



INSTRUMENTE DE SINCRONIZARE



INSTRUMENTE DE SINCRONIZARE

TABEL DE CONȚINUT



FIAT/ALFA ROMEO	3
BMW/MINI	8
PSA	17
FORD	20
JAGUAR/LAND ROVER	26
JEEP/CHRYSLER	28
MERCEDES-BENZ	29
RENAULT/DACIA/NISSAN	32
OPEL/VAUXHALL	37
VAG	42
ALTELE	54
INSTRUMENTE AUXILIARE	56



GASEȘTE UȘOR KITUL TĂU DE DISTRIBUTIE



INTRODUCEȚI ÎN BROWSERUL WEB CODUL DE SCULE OEM SAU CODUL DE MOTOR AL MAȘINII DUMNEAVOASTRĂ ȘI GĂSIȚI KITUL DE DISTRIBUTIE COMPATIBIL



53303

89,00€

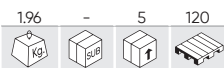

SET DISTRIBUȚIE PE LANȚ FIAT / OPEL

MĂRCI	FIAT: 1.9D/JTD (MOTOR PEUGEOT), 2.4D. ALFA ROMEO: 145, 146, 156 JTD. GM: GM 1.3, 1.6, 1.9, 2.0, 2.4 CDTI (2004 -).
INSTRUMENTE OEM	EN-46789 (1), EN-46789-100 (2), EN-46785 (3), EN-46788 (4), EN-46781 (5), EN-46789 (6)
CODURILE DE MOTOR	GM: K1.3 CDTI Z13DT COMMON RAIL ENGINE. 1.9 CDTI / 04-12 - Z19DT Z19DTH Z19DTJ Z19DTL 2.0 CDTI / 08-12 - A20DT LBS / LBX / LBY / LCDV SAAB: 1.9 TID.



53304

279,00€



SET DISTRIBUȚIE PE LANȚ FIAT

MĂRCI	FIAT
INSTRUMENTE OEM	1 860 874 000 (1), 1 860 895 000 (2), 1 860 898 000 (3), 1 860 905 000 (4), 1 860 845 000 (5)
CODURILE DE MOTOR	PETROL: FIAT BRAVA, BRAVO, BARCHETTA, CARGO, COUPE, MAREA, PALIO, WEEKEND, PUNTO, MULTILA, STILO, IDEA, DOBLO TWIN CAM ENGINES - 1.2, 1.4, 1.6, 1.8, 16V GASOIL: FIAT BRAVA, BRAVO, MAREA, WEEKEND, PALIO, PUNTO, MULTIPLA, DOBLO, ULYSSE, DUCATO, STILO JTD DIESEL ENGINES - 1.9D/TD . 1.9JTD . 2.4TD/JTD.

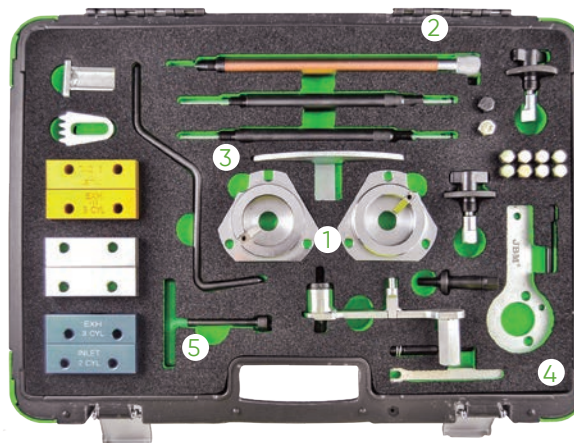

53306

53,00€

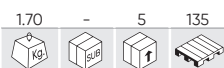

SET DISTRIBUȚIE PE LANȚ FIAT 1.2 16V

MĂRCI	FIAT: FIAT 1.2L 16V, FIAT PUNTO / BRAVA / BRAVO / STILO
INSTRUMENTE OEM	1860992000 (1) (2), 1871000900 (3), 1860987000 (4), 186985000 (5)
CODURILE DE MOTOR	176 B9.000, 182 B2.000, 188 A5.000



53308

55,00€

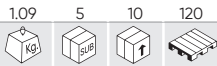

SET DISTRIBUȚIE PE LANȚ ALFA ROMEO

MĂRCI	ALFA ROMEO: 145,146,147,155,156, 1.4 1.6 1.8 2.0 TS, 1.4/1.6 16V; 145/146/147/155/156 (96-10), 1.8 16V; 145/146, (96-01), 155/156 (96-06), SPIDER/GTV (98-05), 2.0 16V; 145/146 (96-01), 147 (01-10), 155/156 (95-02), 166 (98-07), SPIDER/GTV (96-05), PÚRPURA / PURPLE: 1.4, 1.6 // AZUL / BLUE: 1.8, 2.0
INSTRUMENTE OEM	1822149000 (1), 1822154000 (2), 1825041000 (3), 1825042000 (4)
CODURILE DE MOTOR	21.4/1.6-321.02, 321.03, 321.04, 335.03, 676.01 1.8/2.0-323.01, 672.04, 162.01, 323.10, 671.06, 322.01, 671.02, 322.05, 341.03, 363.01.

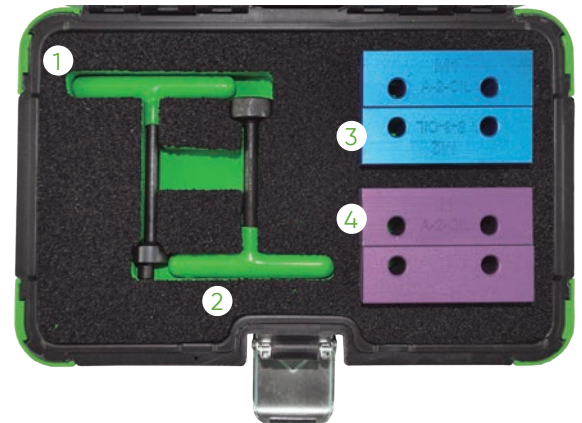

53309

285,00€



SET DISTRIBUȚIE PE LANȚ ALFA/FIAT/LANCIA 1.4, 1.6, 1.8, 2.0 16V

MĂRCI	ALFA ROMEO: 145,146,147,155,156, 1.4 1.6 1.8 2.0 TS, 1.4/1.6 16V; 145/146/147/155/156 (96-10), 1.8 16V; 145/146, (96-01), 155/156 (96-06), SPIDER/GTV (98-05), 2.0 16V; 145/146 (96-01), 147 (01-10), 155/156 (95-02), 166 (98-07), SPIDER/GTV (96-05), PURPUR: 1.4, 1.6 // BLAU: 1.8, 2.0 FIAT: BARCHETTA (96-00), BRAVA (95-00), BRAVO (95-00), COUPE (96-01), MAREA (96-00), MAREA WEEKEND (96-00), PUNTO/PUNTO CLASSIC (99-06), STILO (01-08) LANCIA: DEDRA (95-99), DELTA (96-99), KAPPA (98-02), LYBRA (99-06).
INSTRUMENTE OEM	1.4 16V: 335.03 1.6 16V: 321.02, 321.03, 321.04, 372.03, 676.01 1.8 16V: 322.01, 322.05, 671.06, 182A2.000, 183A1.000, 183A6.000, 188A6.000, 192A4.000 2.0 16V: 162.01, 323.01, 323.1, 341.03, 363.01, 672.04 2.0 20V: 175A3.000, 182A1.000, 182B7.000, 185A8.000.

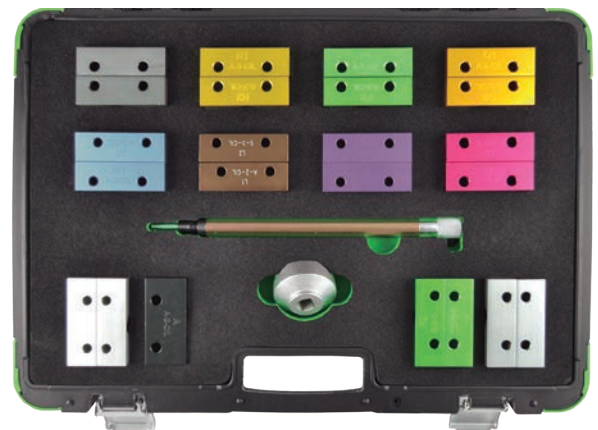

53310

498,00€



SET DISTRIBUȚIE PE LANȚ FIAT/ALFA/LANCIA

MĂRCI	ALFA FIAT LANCIA	ALLA, BARCHETTA, BRAVO, BRAVA, COUPE, DELTA, DEDRA, PUNTO, SPIDER, GT
INSTRUMENTE OEM	1860845000 (1), 1822154000 (2), 1860905000 (3), 1860992000 (4), 1860895000 (5), 1860874000 (6), 1860985000 (7), KM571A (8), 1860896000 (9), 0153A (10)	
CODURILE DE MOTOR	1.2 / 16V, 1.4 / 12V, 1.6 / 16V, 1.6 ECO. 1.8, 2.0 / 16V, 2.0 / 20V, 2.4 / 20V, 3.0 / V6.	



53312

127,00€



SET DISTRIBUȚIE PE LANȚ FIAT/ALFA/FORD

MĂRCI	FIAT: NEW 500 (07-09), IDEA (04-09), LINEA (07-09), GRANDE PUNTO (07-09), DOBLO 1 CARGO (05-09), PANDA EV02 (05) FORD: KA 1.2 DURATEC (09) ALFA ROMEO
INSTRUMENTE OEM	1 860 987 000 (1), 2 000 004 400 (2), 2 000 015 800 (3), 2 000 004 300 (4), 2 000 004 500 (5)
CODURILE DE MOTOR	1.2: 169A4.000 / 199A4.000 . 1.4: 350A 1.000 / 188A4.000-EV02.



53319

18,00€

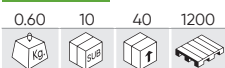

KIT DISTRIBUȚIE PE LANȚ FIAT IVECO 2.3, 3.0 JTD

MĂRCI	FIAT: 2.3 / 3.0 JTD. IVECO: DAILY.
INSTRUMENTE OEM	99360614, 1 860 617 000, 99360615, 2 000 018 200.
CODURILE DE MOTOR	F1AE0481C, F1AE0481D, F1AE0481N, F1CE0481A/D.

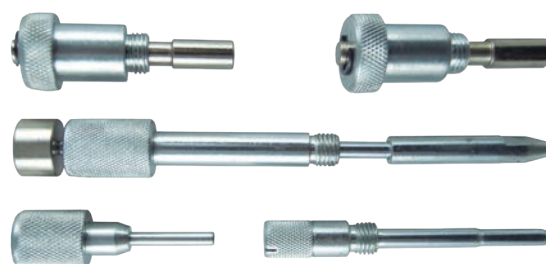

54202

68,00€



SET INSTRUMENTE DE REGLARE A MOTOARELOR PENTRU FIAT/ALFA ROMEO/LANCIA

MĂRCI	ALFA ROMEO: GIULIETTA (10-14), MITO (08-17). FIAT: 500 (07-19), 500L (12-19), 500C (07-19), 500 ABARTH (08-17), BRAVO (07-14), BRAVA/BRAVO (98-02), DOBLO/DOBLO CARGO (10-19), EGEA (15-20), GRANDE PUNTO (07-10), GRANDE PUNTO ABARTH (07-10), IDEA (04-12), LINEA (07-10), MAREA/WEEKEND (98-00), PALIO WEEKEND (01-06), PANDA (07-11), PUNTO (97-08), STILO (01-08), TIPO (15-20). LANCIA: DELTA (08-12), MUSA (04-13), YPSILON (96-11).
INSTRUMENTE OEM	2.000.004.500 (1), 1.860.985.000 (2), 1.860.992.000 (3), 1.860.987.000 (4), 2.000.015.800 (5)
CODURILE DE MOTOR	1.2 16V:176B9.000, 182B2.000, 188A5.000. 1.4 16V / T-JET: 169A3.000, 192B2.000, 198A1.000, 198A4.000, 199A6.000, 198A8.000, , 312A1.000, 312A3.000, 843A1.000, 955A1.000.



54203

91,00€

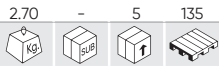

SET INSTRUMENTE DE REGLARE A MOTOARELOR PENTRU ALFA ROMEO/LANCIA 1.8 TBI

MĂRCI	ALFA ROMEO: 159(09-12), BRERA(09-11), GIULIETTA(10-19), SPIDER(09-11), 4C(13-19). LANCIA: DELTA(09-14).
INSTRUMENTE OEM	2 000033500 (1), 2000 003000 (2), 1860898 000 (3).
CODURILE DE MOTOR	ALFA ROMEO 1,75 TBI: 939B1.000, 940A1.000, 940B2.000, 960A1.000 LANCIA 1,75 DI TURBO JET: 939B1.000

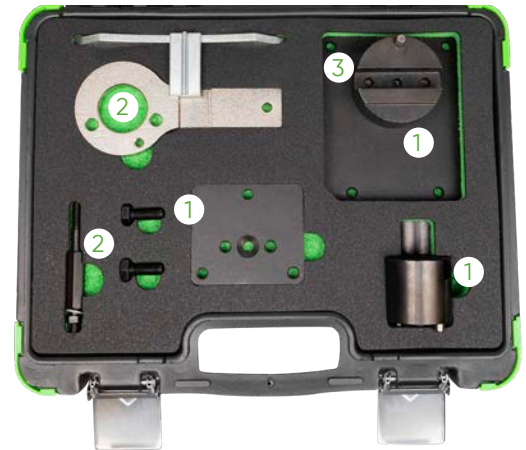

54211

74,00€



SET INSTRUMENTE DE REGLARE A MOTOARELOR PENTRU FIAT/FORD/OPEL/SUZUKI 1.3L

MĂRCI	FIAT: PUNTO (2003-2007) / PANDA (2003-2009) / IDEA (2004-2006) / DOBLO (2004-2006). FORD: KA. VAUXHALL / OPEL: AGILA (2003-2008) / CORSA C (2003-2007) / CORSA D (2006-2009) / COMBO C (2003-2009) / ASTRA H (2004-2009) TIGRA B (2004-2009) / MERIVA (2004-2009). SUZUKI: IGNIS (2003-2009) / WAGON R (2003-2009) / SWIFT (2003-2010).
INSTRUMENTE OEM	1871000200 / 303-1469 / KM-662-C (1), EN 46785 / KM 955 / 09912-38300 (2), 1871000900 / 1860985000 / 303-1472 / EN 46781 / 09917-68610 (3), 1870900400 (4), 1870900300 / 303-1468 (5)
CODURILE DE MOTOR	FIAT: 1.3 JTD 188A9.000 / 169A.000 / 188A8.000 / 199A3.000. FORD: 1.3 TDCI. VAUXHALL / OPEL: 1.3 CDTI Z13DT / Z13DTH / Z13DTJ. SUZUKI: 1.3 CDTI Z13DT.



54212

39,40€

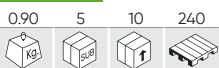

SET INSTRUMENTE DE REGLARE A MOTOARELOR PENTRU FIAT/LANCIA 1,4 12V

MĂRCI	MAREA/MAREA_WEEKEND(96-20), BRAVA(95-98), BRAVO(95-98). LANCIA: YPSILON(96-20)
INSTRUMENTE OEM	1860899000 (1), 1860901000 (2)
CODURILE DE MOTOR	1.4 12V : 182A3.000, 182A5.000.



54215

57,00€

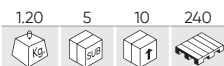

SET INSTRUMENTE DE REGLARE A MOTOARELOR PENTRU ALFA ROMEO/FIAT 1.4 MULTIAIR

MĂRCI	ALFA ROMEO GIULIETTA, MITO / FIAT PUNTO, PUNTO EVO 1.4 (TURBO) MULTIAIR (105/135/163/170PS)
INSTRUMENTE OEM	ALFA ROMEO / FIAT: 1860987000 (1), 2000034400 (2), 2000004500 (3)
CODURILE DE MOTOR	940A2.000 / 940A2.000 / 955A8.000 / 955A8.000 / 940A2.000 / 955A8.000 / 955A2.000 / 955A7.000 / 955A6.000 / 955A8.000



54216

49,00€



SET INSTRUMENTE DE REGLARE A MOTOARELOR PENTRU FIAT/OPEL/ALFA 1.9, 2.4L 16V

MĂRCI	OPEL 1.9, ALFA-ROMEO 1.9-2.4 L DIESEL, FIAT 1.9- 2.4 L DIESEL
INSTRUMENTE OEM	OPEL EN-46788 / FIAT 1.860.905.000 / 1.860.905.010 (1) FIAT 1.860.898.000 (2) OPEL EN-46789 / FIAT 1.870.896.900 (3) OPEL KM 6130 / KM 6349 (4)
CODURILE DE MOTOR	OPEL 1.9 CDTI Z19DT, Z19DTH, Z19DTJ ALFA-ROMEO 1.9 Y 2.4 L : 323.02, 371.01, 342.02, 325.01, 362.02, 182B9.000, 937A2.000, 937A3.000, 192A5.000, 192B1.000, 937A4.000, 937A5.000, 939A2.000, 939A1.000, 939A7.000, 939A8.000, 839A6.000, 841C.000 FIAT 1.9 Y 2.4 L : 182B4.000, 182B9.000, 185A6.000, 186A6.000, 186A8.000, 186A9.000, 188A2.000, 188A7.000, 188B2.000, 192A1.000, 192A3.000, 192A5.000, 192A8.000, 192A9.000, 192B4.000, 192B5.000, 198A2.000, 198A3.000, 198A6.000, 199A5.000, 223A7.000, 937A5.000, 939A1.000, 939A2.000, 939A3.000, 939A7.000



54430

34,00€



INSTRUMENT DE SINCRONIZARE PENTRU ALFA ROMEO/FIAT/LANCIA 0.9 TWIN AIR

MĂRCI	ALFA ROMEO: MITO (2001-2018) CHRYSLER: YPSILON (2011-2015) FIAT: 500/500C (2010-2020), 500L/500L LIVING/500L MPW (2012-2018), PUNTO (2012-2018), PANDA (2012-) LANCIA: YPSILON (2011-2018)
INSTRUMENTE OEM	2 000 035 100 (1) 2 000 035 200 (2) 2 000 035 300 (3)
CODURILE DE MOTOR	Q: 199B6.000, 199B7.000, 312A2.000, 312A4.000, 312A5.000, 312A6.000, 312A7.000



53259

97,00€

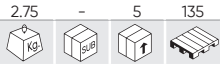

SET DISTRIBUȚIE PE LANȚ BMW N42, N46 1.8, 2.0

MĂRCI	BMW 1 SERIES: 118I E81/82/87/88 (04-14), 120I E81/82/87/88 (04-14). BMW 3 SERIES: 316I/TI COMPACT E46 (01-07), 318I/TI COMPACT E46 (01-07), 318I, E90/91/92/93 (05-12), 320I E90/91/92/93 (05-12). BMW 5 SERIES: 520I E60/61 (07-10), Z4 2.0 E85/86 (04-09). BMW X SERIES: X1 SDRIVE 18I E84 (10-12), X1 XDRIVE 18I E84 (10-12), X3 2.0 E83 (05-10).
INSTRUMENTE OEM	119350 (1), 119340 (2), 119291 (3), 119292 (4), 119270 (5), 115120 (6), 119190 (7), 119293 (8)
CODURILE DE MOTOR	1.8: N42; B18A, N46; B18. / 2.0: N42; B20A, N46; B20, B20B, N46T; B20, B20B, B20BD, B20BZ, B20O2, B2O2.



53260

168,00€

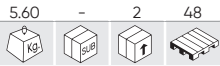

SET DISTRIBUȚIE PE LANȚ BMW N43 1,6/2,0

MĂRCI	BMW 1 SERIES: 116I E81/82/87/88 (07-12), 118I E81/82/87/88 (06-14), 120I E81/82/87/88 (06-14). BMW 3 SERIES: 316I E90/91/92/93 (07-11), 318I E90/91/92/93 (07-13), 320I E90/91/92/93 (07-14). BMW 5 SERIES: 520I E60/61 (07-10).
INSTRUMENTE OEM	118690 (118691/118692/118693) (1), 118710 (118711/118712) (2), 113340 (3) (4), 118700 (5), 119340 (119341/119342) (6), 115120 (7).
CODURILE DE MOTOR	1.6: N43 B16A/AA, B16AA, B16AA/OO. 2.0: N43 B20A, B20A/AA, B20AA, B20AY, B20KO, B20UO.

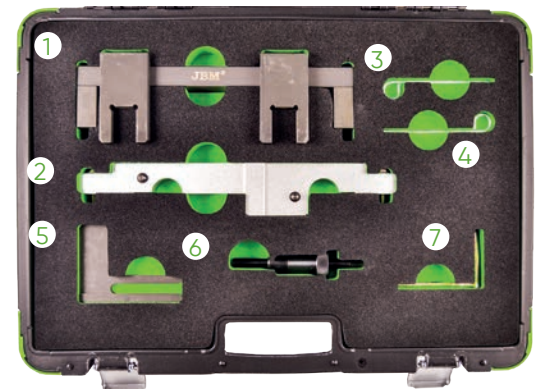

53261

214,00€



SET DISTRIBUȚIE PE LANȚ BMW N42, N46 1.8, 2.0

MĂRCI	BMW 1 SERIES: 118I E81/82/87/88 (04-14), 120I E81/82/87/88 (04-14). BMW 3 SERIES: 316I/TI COMPACT E46 (01-07), 318I/TI COMPACT E46 (01-07), 318I E90/91/92/93 (05-12), 320I (E90/91/92/93 (05-14). BMW 5 SERIES: 520I E60/61 (07-10). BMW X SERIES: X1 E84 SDRIVE 18I (10-12), X1 E84 XDRIVE 18I (10-12), X3 E83 2.0 (05-10). BMW Z SERIES: Z4 2.0 E85/86 (04-09).
INSTRUMENTE OEM	119190 (1), 119310 (2), 119302 (3)
CODURILE DE MOTOR	2.0: N42 B18A, N42 B20A, N46 B18, N46 B20, N46 B20B, N46T B20, N46T B20B, N46T B20BD, N46T B20BZ, N46T B20O2, N46T B2O2



53262

251,00€

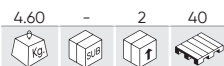

SET DE DISTRIBUȚIE A ARBORELUI CU CAME BMW M52TU, M54, M56

MĂRCI	<p>M52TUB25: 1997-2001 E46 323i/323Ci/323Ti (M52T); 1998-2001 E39 523i (M52TU); 1998-2001 E36/7 Z3 (M52TU).</p> <p>M52TUB28: 1997-2001 E46 328i/328Ci (M52TU); 1997-2001 E36/7 Z3 2.8 (M52B28/Z3); 1998-2001 E39 528i (M52TU); 1998-2001 E38 728i (M52TU).</p> <p>M54B22: 2001-2003 E46 320i/320Ci; 2001-2003 E39 520i; 2001-2002 E36 Z3 2.2i; 2003-2005 E85 Z4 2.2i; 2003-2005 E60/E61 520i.</p> <p>M54B25: 2001-2002 E36/7 Z3 2.5i; 2001-2005 E46 325i/325Xi; 2001-2006 E46 325Ci; 2001-2004 E46 325Ti; 2001-2004 E39 525i; 2003-2004 E60/E61 525i/525Xi; 2004-2006 E83 X3 2.5i; 2004-2006 E85 Z4 2.5i.</p> <p>M54B30: 2001-2005 E46 330i/330Xi; 2001-2006 E46 330Ci; 2001-2003 E39 530i/2001-2002 E36 Z3 3.0i; 2003-2005 BMW E60 530i; 2003-2006 E85 Z4 3.0i; 2001-2006 E53 X5 3.0i.</p>
INSTRUMENTE OEM	116150 (1), 113450 (2), 113292 (3), 116180 (4), 114220(5)



53263

57,00€

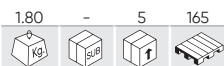

SET BLOCAJ PT ARBOREL CU CAME BMW M47 LAND ROVER TD4,TD6

MĂRCI	<p>BMW 1 SERIES: 118D E87 (04-07), 120D E87 (04-07).</p> <p>BMW 3 SERIES: 318D/TD COMPACT E46 (01-05), 318D/TD E90/91 (05-08), 320D/TD COMPACT E46 (98-05), 320D/CD E90/91 (05-08), 325D E90/91/92/93 (02-10), 330D/CD E46/90/91/92/93 (99-07), 335D E90/91/92 (06-11).</p> <p>BMW 5 SERIES: 520D E39/60/61 (00-09), 525D/XD E39/60/61 (00-10), 530D/XD E46/60/61 (98-10), 535D E60/61 (04-10).</p> <p>BMW 6 SERIES: 635D E63/64 (07-11).</p> <p>BMW 7 SERIES: 730D/LD E38/65/66 (98-08).</p> <p>BMW X SERIES: X3 2.0D E83 (04-07), X3 3.0D/SD E83 (03-10), X5 3.0D E53/E70 (00-10), X6 3.0D E71/72 (08-10), X6 3.5D E71/72 (08-10).</p> <p>LAND ROVER: FREELANDER TD4 (00-06), RANGE ROVER TD6 (02-06).</p> <p>MG/ROVER: MG-ZT/T (01-05), ROVER 75 CDT/CDTI (99-05).</p> <p>VAUXHALL/OPEL: OMEGA-B (01-03).</p>
INSTRUMENTE OEM	112300/12-108, 12-171/KM-813 (1), 113340/12-172/KM-823 (2) (3), 116322/12-174/KM-6267 (4) 116320 (5)
CODURILE DE MOTOR	<p>BM - 2.0D: M47, M47T2, M47TU / 2.5D: M57, M57T2, M57TU / 3.0D: M57, M57T2, M57TU</p> <p>LAND ROVER - 2.0D: 204D3 (TD4) / 3.0D: 306D1 (TD6)</p> <p>MG/ROVER- 2.0D: M47R / 2.0D CDT: M47R</p> <p>VAUXHALL/OPEL- 2.5D: Y25DT</p>



53264

143,00€



SET DISTRIBUȚIE PE LANȚ BMW N62, N73

MĂRCI	<p>BMW 5 SERIES: 540i E60/61 (05-10), 545i E60/61 (03-06), 550i E60/61 (05-10).</p> <p>BMW 6 SERIES: 645i E63/64 (03-06), 650i E63/64 (05-11).</p> <p>BMW 7 SERIES: 735i E65/66 (02-05), 740i E65/66 (05-10), 745i E65/66 (02-05), 750i E65/66 (05-08), 760i E65/66 (02-08).</p> <p>BMW X SERIES: X5 4.4 E53 (03-07), X5 4.8 E53/E70 (04-10).</p>
INSTRUMENTE OEM	119463 (1), 119462 (2), 119340 (3), 119461 (4), 119190 (5)
CODURILE DE MOTOR	<p>3.6 V8: N62 B36A 4.4 V8: N62 B44A</p> <p>4.0 V8: N62 B40A 4.8 V8: N62 B48B 6.0 V12: N73 B60A</p>

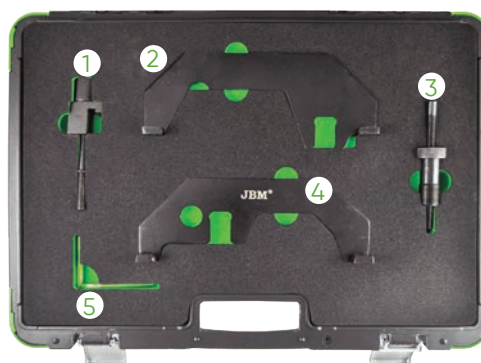

53265

195,00€

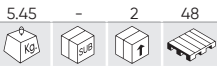

SET DISTRIBUȚIE PE LANȚ BMW DIESEL M47, M57, M41, M51

MĂRCI	BMW
INSTRUMENTE OEM	113360 (1), 116321 (2), 135190 (3), 135191 (4), 135192 (5), 116322 (6), 112300 (7), 113340 (8)
CODURILE DE MOTOR	M41 / M51 / M47TU / M47TU T2. M57TU T2 3.01 1998 - 2008.

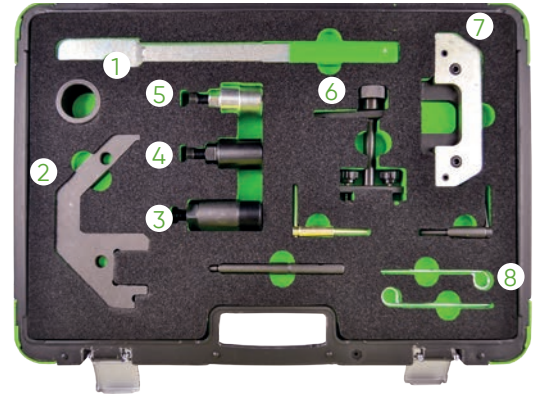

53266

224,00€

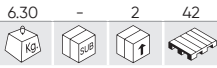

SET DISTRIBUȚIE PE LANȚ BMW M42, M43, M50, M51, M52

MĂRCI	BMW
INSTRUMENTE OEM	113240 (1), 115490 (2), 113190 (3), 112300 (4) (5), 113292 (6), 113320 (7)
CODURILE DE MOTOR	PETROL: M42, M43, M50, M52, M60. DIESEL: M51

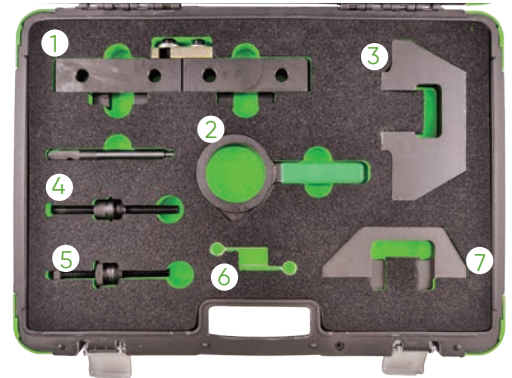

53267

277,00€



SET DISTRIBUȚIE PE LANȚ BMW M40, M43, M42, M44, M52, M54, M56

MĂRCI	BMW SERIES: 3, 5, 7, X, Z
INSTRUMENTE OEM	114220 (1), 112300 (2), 113240 (3), 115490 (4), 113292 (5), 113450 (6)
CODURILE DE MOTOR	M40. M44. M50. M52. M54. M56.

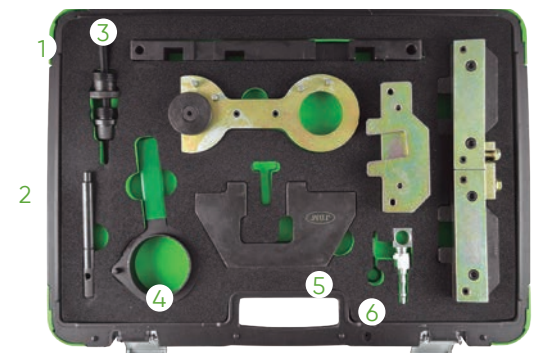

53269

50,00€

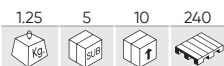

SET DISTRIBUȚIE PE LANȚ BMW N47, N47S, N57

MĂRCI	<p>BMW 1 SERIES: 116D E81/82/87/88 (08-12), 118D E81/82/87/88 (07-14), 120D E81/82/87/88 (07-14), 123D E81/82/87/88 (07-14).</p> <p>BMW 2 SERIES: 218D (11-14), 220D (11-14), 225D (11-14).</p> <p>BMW 3 SERIES: 316D E90/91/92/93 (09-12), 318D E90/91/92/93 (07-12), 320D E90/91/92/93 (07-12), 325D E90/91/92/93 (10-14), 330D/XD E90/91/92/93 (08-14).</p> <p>BMW 5 SERIES: 520D E60/61 (07-10), 525D F10/11 (10-12), 530D F10/11 (10-13), 530DGT F07 (09-12), 535D F10/11 (10-17), 535DGT F07 (10-12).</p> <p>BMW 7 SERIES: 730D/LD F01/02/04 (08-12), 740D F01/02/04 (09-12), 740D XDRIVE F01/02/04 (09-12), 750D XDRIVE F01/02/04 (12-15).</p> <p>BMW X SERIES: X1 SDRIVE 18D E84 (09-15), X1 SDRIVE 20D E84 (09-12), X1 XDRIVE 18D E84 (09-15), X1 XDRIVE 20D E84 (09-15), X1 XDRIVE 23D E84 (09-12), X3 2.0D E83 (07-10), X3 XDRIVE 18D E83 (08-10), X3 XDRIVE 30D E83 (11-12), X3 XDRIVE35D F25 (11-17), X5 3.0D E70 (10-13), X5 XDRIVE 40D X5 F15 M50D (13-17), E70 (10-13), X6 XDRIVE 30D E71/72 (10-14), X6 XDRIVE 40D E71/72 (10-14), X6 F16 M50D (14-17).</p> <p>BMW MINI: PACEMAN (13-17), COUNTRYMAN (10-17), MINI (10-15), ROADSTER (12-14), CLUBMAN (10-14), CLUBVAN (12-14).</p>
INSTRUMENTE OEM	118760 (1), 118740 (2), 116480 (3), 115320 (4)
CODURILE DE MOTOR	<p>1.6 D: N47; C16K1, C16U1.</p> <p>2.0 D: N47; C20K1, C20U1N47; D20, D20A, D20B, D20D, D20K1, D20O0, D20O1, D20T1, D20U0, D20U1, N47S D20T0, N47T; D20, D20O1, D20U1.</p> <p>3.0 D: N57; B30B, B30B/T0, B30C, D30BT0, D30O0, D30O1, D30T0, D30T1, D30U0.</p>



54206

113,00€



SET INSTRUMENTE DE REGLARE A MOTOARELOR PENTRU BMW/MINI 1.5, 2.0L

MĂRCI	<p>BMW</p> <ul style="list-style-type: none"> - 1 SERIES - 114D, 116D, 214D - (F20/ 21) - (2015- 2017) - 2 SERIES - 216D, 118D, 125D - (F22/ 23/ 45/ 46) - (2014-2017) - 3 SERIES - 218D, 220D, 225D - (F30/31/34) - (2015-2017) - 4 SERIES - 316D/320D/325D - (F32, 33, 36) - (2015-2017) - 5 SERIES - 420D, 425D, 418D - (F10, 11) - (2014-2017) - X1 SERIES - 518D - (F48) - (2015-2017) - X3 SERIES - (F25) - (2014-2017) - EFFICIENT DYNAMICS - X4 SERIES - (F26) - (2014-2017) - XDRIVE - X5 SERIES - (F15) - (2015-2017) - SDRIVE <p>MINI</p> <ul style="list-style-type: none"> - CLUBMAN - (F54) - (2015-2017) - ONE D CONVERTIBLE - (F57) - (2016-2017) - COOPER D/ SD MINI HATCH (F55, 56) - (2014-2017)
INSTRUMENTE OEM	114120 (1), 2347904 (2), 2365488 (3), 2288380 (4), 118760 (5), 118740, 118030 (6)
CODURILE DE MOTOR	<p>1.5: B37 D15A, B37 C15A</p> <p>2.0: B47 D20A, B47 D20B, B47 C20A, B47, B47 C20B</p>



GASEȘTE UȘOR KITUL TĂU DE DISTRIBUȚIE

- ✓ INTRODUCEȚI ÎN BROWSERUL WEB CODUL DE SCULE OEM SAU CODUL DE MOTOR AL MAȘINII DUMNEAVOASTRĂ ȘI GĂSIȚI KITUL DE DISTRIBUȚIE COMPATIBIL



54219

60,00€

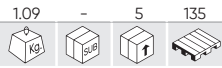

SET INSTRUMENTE DE REGLARE A MOTOARELOR PENTRU BMW/MINI/CITROËN/PEUGEOT

MĂRCI	BMW MINI PSA
INSTRUMENTE OEM	115140 (1), 119280 (2), 119330 (3), 113340 (4), 114360 (5)
CODURILE DE MOTOR	BMW 1.6 (N40 / N45 / N45T, B16, B16A, B16AC) 1.8 / 2.0 (N42 / N46 / N46T) 2.0 / 3.0 (N51 / N52 / N52-COMPONENTE / N53 / N54) PSA 1.4 / 1.6 16V (EP3 / EP6 / EP6DT / EP6DTS) MINI 1.4 / 1.6 (N12 / N14)



54222

59,00€

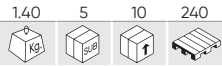

INSTRUMENT DE REGLARE MOTOR PENTRU MINI 1.6

MĂRCI	BMW: MINI COOPER S(07-10) PEUGEOT: 207(06-10), 307(06-10), GT(06-10), THP(06-10), GTI(06-10) CITROËN: DS3(06-10), C4(06-10), GRANDE PICASSO TPH(06-10)
INSTRUMENTE OEM	119550(1), 119551(2), 119552(3), 119590(4)
CODURILE DE MOTOR	N14 B16A , N14 B16CD , N14 B16TO



54227

122,00€

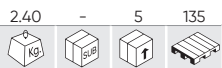

INSTRUMENT DE REGLARE MOTOR PENTRU BMW/MINI N13, N18, PSA

INSTRUMENTE OEM	EN-52127-2, EN-52588, E1 100, G 1376A, T10550/2, T10550/3, 0 496 709, 0109 2B, 0197 A11, 0197 A3, 0197 A31, 0197-A1, 0197-A1Z, 0197-A11, 0197A2, 0197-A31, 0197-A32, 0197-A33, 0197-BZ, 0197-M, 0197-N, 11 7 440 (1), 11 9 340 (2), 11 9 540, 11 9 551, 11 9 590, 1376-A, 2 299 362 (3)
CODURILE DE MOTOR	N12 B14A, N13 B16A, N14 B16A, N14 B16C, N16 B16A, N18 B16A, N18 B16C, 5FA (EP6CDT), 5FD (EP6DTS), 5FE (EP6CDT), 5FE (EP6CDTM), 5FF (EP6DTS), 5FG (EP6CDTR), 5FH (EP6C), 5FK (EP6C), 5FK (EP6CB), 5FL (EP6C), 5FM (EP6CDTM), 5FN (EP6CDT), 5FP (EP6), 5FR (EP6DTE), 5FS (EP6C), 5FT (EP6DT), 5FU (EP6CDTX), 5FV (EP6CDT), 5FW (EP6), 5FX (EP6DT), 5FY (EP6DTS), 5GF (EP6FADTX), 5GF (EP6FADTXD), 5GG (EP6FADTX), 5GM (EP6FDTX), 5GN (EP6FDTR), 5GP (EP6FDTR), 5GR (EP6FDTX), 5GT (EP6FDTX), 5GW (EP6FDT), 5GY (EP6FADTXD), 5GY (EP6FDT), 5GY (EP6FDTM), 5GZ (EP6FDT), 8FN (EP3C), 8FP (EP3C), 8FR (EP3C), 8FS (EP3)



54228

187,00€

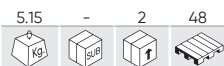

SET INSTRUMENTE DE REGLARE A MOTOARELOR PENTRU BMW/MINI 1.2, 1.5, 2.0, 3.0

MĂRCI	BMW: 1 SERIES (2015 - 2019), 2 SERIES (DESDE 2014), 3 SERIES (DESDE 2015), 4 SERIES (DESDE 2015), 5 SERIES (DESDE 2017), 6 SERIES (DESDE 2017), 7 SERIES (DESDE 2015), i8 (DESDE 2014), X1 (DESDE 2015), X2 (DESDE 2018), X3 (DESDE 2017), X4 (DESDE 2018) AND Z4 (DESDE 2019); MINI: CLUBMAN (DESDE 2015), HATCH (DESDE 2014), CONVERTIBLE (DESDE 2016) AND COUNTRYMAN (DESDE 2017)
INSTRUMENTE OEM	2 358 122 (1), 2 357 904 (2), 2 365 488 (3), 2 288 380 (4), 11 4 120 (5).
CODURILE DE MOTOR	BMW: 1,5 B38 A15A, B38 B15A, B38 K15A ,1,6 B48 B16A, 2,0 B48 A20A, B48 A20B, B48 A20E, B48 B20A, B48 B20B , 3,0 B58 B30A, B58 B30B, B58 B30C MINI: 1,2 B38 A12A , 1,5 B36 A15A, B38 A15A , 2,0 B46 B20A, B48 A20A, B48 A20B



54293

17,50€

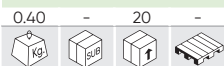

SUPPORT PENTRU ARBORELE COTIT PENTRU BMW

MĂRCI	BMW 1 SERIES E81/82/87/88: 116D (2008-2012),118D (2007-2012),120D (2007-2014), 123D (2007-2014) BMW 1 SERIES E22: 218D (2011-2014), 220D (2011-2014), 225D (2011-2014) BMW 3 SERIES E90/91/92/93: 316D (2007-2012), 318D (2007-2014),320D (2007-2012), 325D (2010-2012), 330D (2008-2014) BMW 5 SERIES E60/61: 520D (2007-2010) BMW 5 SERIES F10/11: 525D (2010-2013), 530D (2010-2013),530D XDRIVE (2011-2015), 535D (2010-2013), 535D XDRIVE (2011-2015),M550D XDRIVE (2012-2015) BMW 5 SERIES E07: 535D GT (2009-2015) BMW 7 SERIES F01/02/04: 730D (2008-2012), 740D (2009-2012),750D XDRIVE (2012-2015) BMW X1 E84: 18D SDRIVE (2009-2015), 20D SDRIVE (2009-2015), 18D XDRIVE (2009-2015), 20D XDRIVE (2009-2015), 23D XDRIVE (2009-2012) BMW X3 E83: 2.0D (2007-2008), 18D XDRIVE (2008-2010) BMW X5 E70: 3.0D XDRIVE (2010-2013), 40D (2010-2013) BMW X6 E71/71: 30D XDRIVE (2010-2014), 40D XDRIVE (2010-2014)
INSTRUMENTE OEM	T10016
CODURILE DE MOTOR	2,0: N47D20C, N47D20D 2,0D: N47, D20A, D20A/KO, D20B, D20B/TO, D20C,D20O0, D20O1, D20U0, D20U1 D20K1 3,0D: N57, D30U0, D30O0, D30O1, D30TO, D20TO,D30A, D30A/O0, D30B , D30B/T1, D30C, D30C/S1,D30A0/O0, D30A0/O1



54398

41,00€

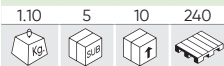

SET DE BLOCARE A VOLANTULUI / SCRIPETELUI ARBORELUI COTIT PENTRU BMW/MINI

MĂRCI	MINI HATCH (14-21), CABRIOLET (16-19), CLUBMAN (15-19), COUNTRYMAN (17-19)
INSTRUMENTE OEM	11 6 480 (1) 11 9265 (2) 11 4 180 (3) 11 9 810 (4) 11 9 811 (4)
CODURILE DE MOTOR	BMW: 116i (15-19), 116d (15-19), 118d (15-19), 120d (15-19), 125d (15-19), M140i (16-19), 214d (15-19), 216i (18-19), 216d (14-20), 218d (17-19), 218i (15-21), 220d, (14-20), 225d (15-20), M240i (16-19), 316d (15-19), 318i (15-19), 320d (15-19), X1 (15-20), X2 (18-19), X3 (14-18), X4 (17-20), X5 (15-18), i8 (14-18) 325d (16-20), 330i (15-20), 340i (15-19), 418i (15-20), 420d (15-20), 425d (16-18), 430i (16-20), 440i (16-19), 518d (14-17), 525d (17-20), 530i (17-18), 540i (17-19), 620d (18-20), 630i (17-19), 640i (17-19), 725d (16-19), 730i, (15-19), 740i (15-19)



54399

56,50€

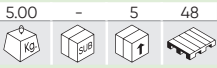

N

INSTRUMENT DE SINCRONIZARE PENTRU BMW/ROVER/OPEL 2.5D

MĂRCI	BMW: 318TDS (94-00) , 325TD (91-99) , 325TDS (91-99) , 525TD (90-03) , 525TDS (90-03) , 725TDS (95-02) RANGE ROVER: P38 (94-02) VAUXHALL/OPEL: OMEGA-B (94-01)
INSTRUMENTE OEM	KM811 (1), 113320 (1), 12112 (1) KM822 (2), 113360 (2), 12115 (2) KM813 (3), 115120 (3), 112300 (3), 12108 (3) KM823 (4), 113340 (4), 12172 (4)
CODURILE DE MOTOR	256T, 25DT, M41/174T1, M51/256T1, M51/256T1L, X25DT

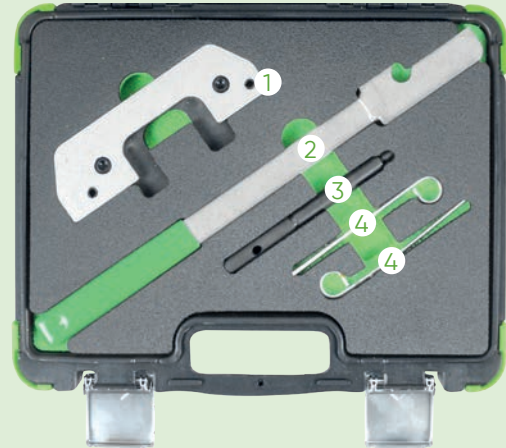

54400

141,00€

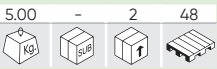

N

INSTRUMENT DE SINCRONIZARE PENTRU BMW N20, N26

MĂRCI	BMW: 1 SERIES 125I - F20/21 (2012-2016) 2 SERIES COUPE 220I, 228I - F22 (2014-2016) 2 SERIES CABRIOLET 220I 228I - F23 (2015-2016) 3 SERIES 320I 328I XDRIVE - F30/31 (2012-2015) 3 SERIES GRAN TURISMO 320I, 328I/XDRIVE - F34 (2013-2016) X4 XDRIVE 20I, 28I (F26) 2014 - 2018, X5 XDRIVE40E (F15) 2015 - 2018, Z4 SDRIVE18I, 20I, 28I (E89) 2011 - 2017 4 SERIES COUPE 420I, 428I/XDRIVE - F32(2013-2016), 4 SERIES CABRIOLET 420I, 428I/XDRIVE-F33 (2014-2016) 4 SERIES GRAN COUPE 420I, 428I/XDRIVE F36 (2014-2016) 5 SERIES 520I, 528I/XDRIVE(F10/11) 2010 - 2017, 5 SERIES GRAN TURISMO 528I-(F07) 2013 - 2016, X1 SDRIVE16I, 18I, 20I, XDRIVE20I, 28I-(E84) 2011 - 2015, X3 SDRIVE18I, 20I, XDRIVE20I, 28I (F25) 2011 - 2017
INSTRUMENTE OEM	11 9 340/341 (1), 11 9 340A (1), 11 9 341 (1), 119340 (1) 2 212 830 (2) 2 212 831 (3) 2 219 548 (4)
CODURILE DE MOTOR	1,6 N20 B16A 2,0 N20 B20 N20 B20A N20 B20A N20 B20B N20 N20B/UO N20 B2000 N20 B2000 N26 B20 B26 B20A

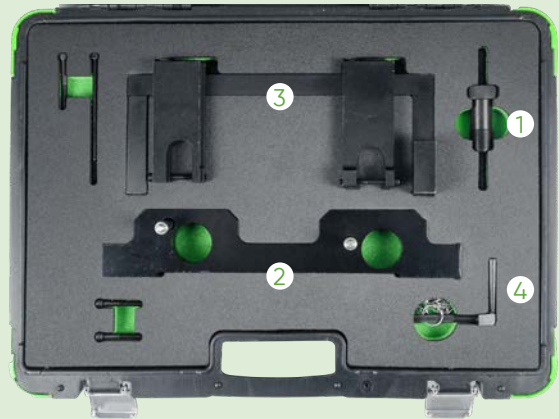

54401

57,00€



N

INSTRUMENT DE SINCRONIZARE PENTRU BMW/MINI N13, N18

MĂRCI	BMW 114i (2012-2015) BMW 116i (2012-2015) BMW 118i (2011-2015) BMW 316i (2012-2015) MINI CLUBMAN (R55) (2011-2014) MINI COOPER S (R56/57) (2010-2015) MINI COUNTRYMAN (R60) (2012-2016) MINI COUPE COOPER S (R58) (2012-2015) MINI PACEMAN (R61) (2013-2017) MINI ROADSTER (R59) (2012-2015)
INSTRUMENTE OEM	11 7 440 (1), 117440 (2), 11 9 340 (3), 11 9 590 (4), 49 6 709 (5)
CODURILE DE MOTOR	N13 B16A N18 B16A N18 B16/MO N18B16A/MO N18B16C N18B16C/TO N18B16MO

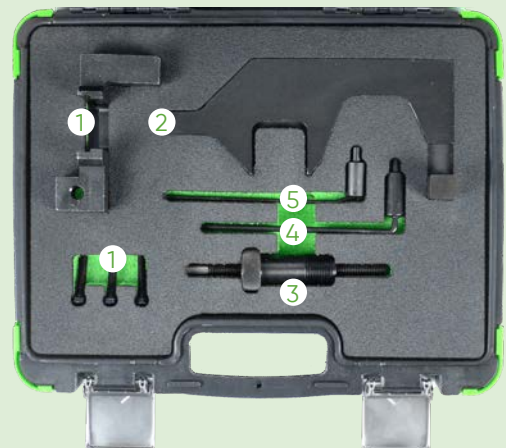

54402

201,00€

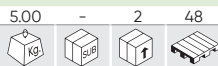

N

INSTRUMENT DE SINCRONIZARE PENTRU BMW N51, N52, N53, N54, N55

MĂRCI	E60: 523i, 523Li, 525i, 525Li, 525Xi, 528i, 528Xi, 530i, 530Li, 530Xi, 535i, 535Xi E61/E63: 523i, 525i, 525Xi, 530i, 530Xi, 535Xi, 630i E64/E65: 630i, 730i E66/E70: 730Li, X5 3.0Si E81/E82: 130i, 135iS E83: X3 2.5i, 2.5Si, 3.0i, 3.0Si E85/E86: Z4 2.5i, 2.5Si, 3.0i, 3.0Si, Z4 3.0Si E87/E90: 130i, 323i, 325i, 325Xi, 328i, 328Xi, 330i, 330Xi, 335i, 335Xi E91: 323i, 325i, 325Xi, 328i, 328Xi, 330i, 330Xi, 335i, 335Xi E92: 323i, 325i, 325Xi, 328i, 328Xi, 330i, 330Xi, 335i E93: 325i, 328i, 330i, 335i
INSTRUMENTE OEM	110300 (1) 114280 (2) 114285 (3) 114290 (4) 114390 (5) 118520 (6) 119190 (7) 119340 (8)
CODURILE DE MOTOR	N51/N52/N53/N54/N55

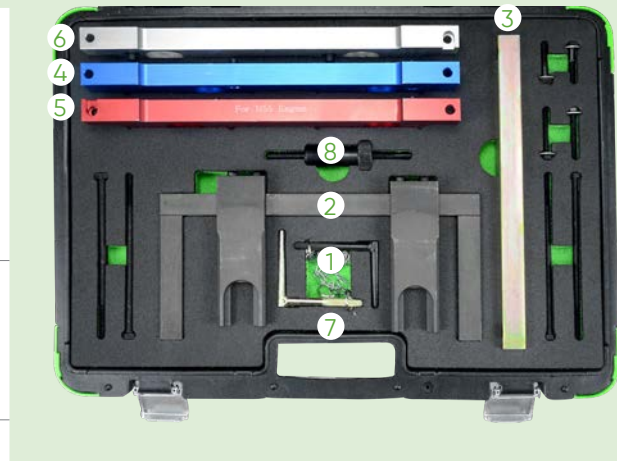

54403

225,00€



N

INSTRUMENT DE SINCRONIZARE PENTRU BMW M60

MĂRCI	BMW 5 SERIES: 530i, 540i (E34) (1992 – 1996), 535i, 540i (E39) (1996 – 2003) BMW 7 SERIES: 730i, 735i, 740i (E38) (1994 – 2002), 730i, 740i (E32) (1992 – 1994) BMW 8 SERIES: 840i (E31) (1993 – 1999) LAND ROVER/RANGE ROVER: (L322) (2002 – 2005) XS: 4.4, 4.6 (E53) (1999 – 2004)
INSTRUMENTE OEM	11 2 445 (1), 11 2 441/445 (1), LRT -12 223/2 (1) 11 2 441 (2), 12 223/1 (2), LRT 12-223/1 (2) 11 2 442 (3), 11 2 442/446 (3), 12 223/3 (3), LRT 12 223/3 (3) 11 2 446 (4), 12 223/4 (4), LRT 12 223/4 (4), LRT 12 224 (4) 11 3 390 (5), 113390/117380 (5), 12 222 (5), LRT 12 222 (5) 11 5 180 (6), 12 227 (6), LRT 12 227 (6) 11 2 300 (7), 11 5 120 (7), 12 108 (7), 12 171 (7), KM 813 (7), LRT 12 108 (7), LRT 12 171 (7) 11 6 420 (8), 12 226 (8), LRT 12 226 (8) 11 6 452 (9), 12 228/1 (9), LRT 12 228/1 (9) 11 6 451 (10), 12 228/2 (10), LRT 12 228/2 (10) 11 3 310 (11), 12 220 (11), LRT 12 220 (11) 11 6 440 (12), 12 224 (12), LRT 12 2214 (12) 11 7 380 (13), 12 221 (13), LRT 12 221 (13)
CODURILE DE MOTOR	BMW 3.0: 30 8S 1 BMW 3.5: 35 8S 1, 35 8S 2 BMW 4.0: 40 8S 1 BMW 4.4: 44 8S 1, 44 8S 2 BMW 4.6: 46 8S 1 RANGE ROVER: V8/44 8S 2



54404

131,00€



N

INSTRUMENT DE SINCRONIZARE PENTRU BMW N62, N73

MĂRCI	SERIES 5, SERIES 6, SERIES 7, X5
INSTRUMENTE OEM	119461 (1), 119462 (2), 119463 (3), 119190 (4), 119340 (5), 119451 (6), 119452 (7), 119453 (8), 119454 (9), 113460 (10), B117207 (11)
CODURILE DE MOTOR	N62 B36A, N62 B40A, N62 B44A, N62 B48A, N62 B48B, N73 B60A

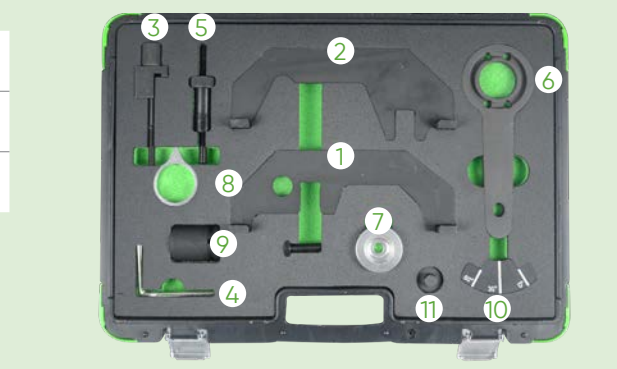

54405

111,00€



N

INSTRUMENT DE SINCRONIZARE PENTRU BMW N63, N74

MĂRCI	SERIES 5, SERIES 6, SERIES 7, X5, X6
INSTRUMENTE OEM	11 9 891 (1) 11 9 892 (1) 11 9 893 (2) 11 9 190 (3) 11 8 090 (4)
CODURILE DE MOTOR	N63, N74



54406

73,00€



N

BLOCATOR VOLAN MOTOR BMW/MINI

MĂRCI	<p>BMW 1 SERIES: F20/21 (12-15), 116i (04-12), 118i (04-14), 120i (04-14), 130i (05-07), 135i (07-11), 116D (08-12), 118D (04-14), 120D (04-14), 123D (07-14), M COUPE (11-12)</p> <p>BMW 3 SERIES: F30/31 (12-15), 316Ti (04-14), 316i (04-11), 316D (09-12), 318i (04-07), 318Ti/COMPACT (04-04)</p> <p>BMW 3 SERIES: 318D (03-12), 318TD (03-07), 320D (01-07), 320D COMPACT (01-05), 318i (05-13), 320D (07-14), 320i (05-14), (05-14), 320Si (05-06)</p> <p>BMW 3 SERIES: 323i (05-11), 325i (05-14), 325D (06-10), 330D (05-08), 330i (06-13), 335D (05-13), 335i (05-11)</p> <p>BMW 4 SERIES: 420i F32 (13-15), 428i F32 (13-15), 420i F33 CABRIOLET (14-15), 428i F33 CABRIOLET (14-15), 420i F36 (14-15), 428i F36 GRAN COUPE (14-15)</p> <p>BMW 5 SERIES: F10/11 (10-15), 520D (05-10), 520i (07-10) 523i (03-10), 525D (05-10), 525i (05-10), 525i (07-10), 530D (03-10), 530i (05-10), 535D (04-10)</p> <p>BMW 6 SERIES: 630i (04-11), 635D (07-11)</p> <p>BMW 7 SERIES: 730D (05-08), 730i (02-08) BMW X SERIES: X1 E84 (09-15), X3 E83 (03-14), X5 E53 (03-14), X3 F25 (11-15), X6 E71/72 (08-10)</p> <p>BMW Z SERIES: Z4 E85/86 (04-09), Z4 (E89) (11-15)</p> <p>MINI: MINI (03-06)</p>
INSTRUMENTE OEM	11 8 180 (1), 11 8 181 (2), 11 8 182 (3), 11 8 183 (4), 11 8 184 (5), 11 8 185 (6)
CODURILE DE MOTOR	BMW: M47T2, M57T2, M67, N43, N45, N45T, N46, N46T, N47, N51, N52, N53, N54 MINI: W17 DIESEL



54324

11,00€



N

INDICATOR DE UZARE A LANȚULUI DE DISTRIBUȚIE MINI

MĂRCI	MINI: CLUBMAN (2007-2014), CLUBVAN (2012-2014), COUNTRYMAN (2010-2017), COUPÉ (2011-2015), MINI (2006-2015), PACEMAN (2013-2017), ROADSTAR (2012-2015)
INSTRUMENTE OEM	2353281 (1)
CODURILE DE MOTOR	1.4: N12 B14AB, N12 B14 1.6: N12 B16A, N16 B16A, N16 B16MO, N16 B16UO, N16 B16A/MO, N16 B16KO, N16 B16A/MO, N18 B16A, N18 B16A/MO, N18 B16C, N18 B16A/MO, N18, N18 B16MO, N18 B16C/T0



53268

92,00€

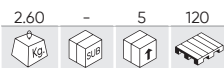

KIT DISTRIBUȚIE PE LANȚ BMW/MINI/PSA 1.4, 1.6

MĂRCI	BMW/MINI: MINI CLUBVAN R55 (12-14), MINI CLUBMAN R55 (08-14), MINI COUNTRYMAN R55 (07-10), MINI CLUBMAN R56/R57 (07-15), MINI R56/R57 (08-15), MINI COUPE R58 (11-15), MINI ROADSTER R59 (08-15), MINI CLUBMAN R60 (10-14), MINI CLUBVAN R60 (12-14), MINI ROADSTER R61 (13-15), MINI PACEMAN R61 (14-15), MINI COUNTRYMAN R60 (10-17). CITROËN: C4 (08-11), C4 PICASSO (08-13) C4 GRAND PICASSO (13-15). PEUGEOT: 207 (06-14), 207CC (07-15), 308 (07-15), 3008 (09-15), 5008 (09-15).
INSTRUMENTE OEM	BMW/MINI: 115590 (1), 119340 (2), 119551 (3) CITROËN: 0197-A1, 0197-A3, 0197-B. PEUGEOT: 0197-A1, 0197-A3, 0197-BZ.
CODURILE DE MOTOR	1.4: N12B14, N14B14AB. 1.6: EP3(8FS), EP3C(8FR), EP6(5FW), EP6C(5FS), EP6CDT(5FV), EP6DT(5FT), EP6DT(5FX), EP6DTS(5FY), N14B16A, N14B16CD, N14B16TO, N14B16CD/TO, N16B16A, N16B16KO, N16B16A/MO, N16B16A/MO, N16B16MO, N16B16UO.



53313

139,00€



KIT DISTRIBUȚIE PE LANȚ CITROEN/PEUGEOT

MĂRCI	CITROËN: AX, BX, BOXER, BERLINGO, C25, DISPATCH, EVASION, J5, JUMPY, JUMPER, RELAY, SAXO, SYNERGIE, VISA, XM, XSARA, XANTIA, XZ, ZX. PEUGEOT: 106, 205, 206, 305, 306, 307, 309, 405, 406, 605, 607, 806, EXPERT, PARTNER, SOLARA, TALBOT.
INSTRUMENTE OEM	7099TM (1), 0188X (2), 0188P (3), 0189AZ (4), 0188H (5), 0132AJ1 (6), 0189A (7), 0188PM (8), 21-260 (9), 4527-TS1 (10), M8X70 (11), 0188K (12), 0188J (13), 0132Q (14), 4507-TL (15), 4507-TJ (16), 9044-T (17), 4507-TJ (18), 5711-TA (19), 7014-TJ (20), 7017-TR (21), 0188X (22), 7017-TW (23), 7014-TM (24), 0189L (25)

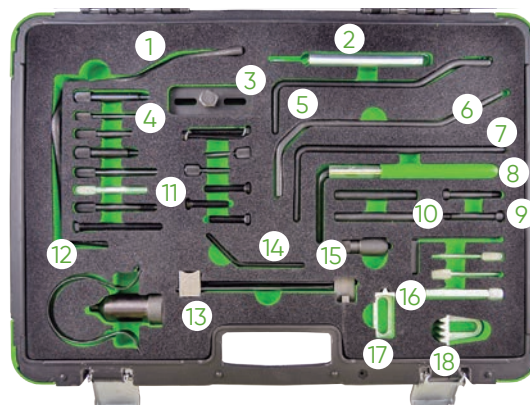

53314

98,00€



KIT DISTRIBUȚIE PE LANȚ CITROEN/PEUGEOT 1.8, 2.0

MĂRCI	CITROËN: C4 PICASSO/GRAND PICASSO (06-10), C5 II (04-08), C8 (05-10), DISPATCH/JUMPY (07-11), XSARA 2.0 16V, C5 1.8/2.0/HPI, XSARA PICASSO 1.8/2.0 16V (02-05). PEUGEOT: 406 1.8 16V (00-04), 407 (06-10), 807 2.0 16V (02-05).
INSTRUMENTE OEM	0189S2 (1), 0188J (2), 0188J2 (2), 0189S1 (3), 21-260 (4), 0189B (5), 0188M (6), 0188AH (7), 0189R (8)
CODURILE DE MOTOR	1.8 16V: EW7A(6FY). 2.0 16V: EW10A(RFJ), EW10ABE4(RFH), EW10J4S (RFK).

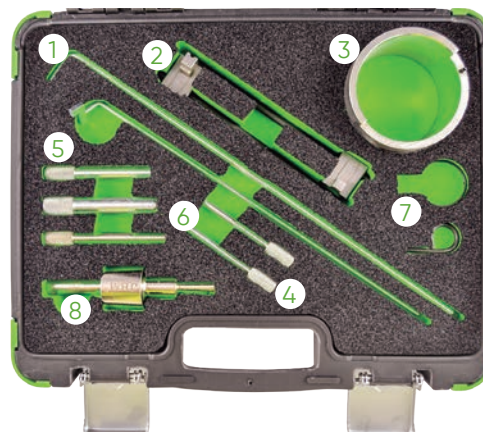

53876

64,00€



KIT DISTRIBUȚIE PE LANȚ CITROËN/PEUGEOT 1.0, 1.2 VTI

MĂRCI	CITROËN: C3 (III) PEUGEOT: 208, 308, 2008 SUV (2012-2014)
INSTRUMENTE OEM	0109-2A (1) 0109-2B (2)
CODURILE DE MOTOR	1.0/1.2 VTI. EBO, (ZMZ), EB2, (HMZ)



54288

72,50€



INSTRUMENT DE SINCRONIZARE PENTRU PSA 1.2 GDI PURETECH

MĂRCI	CITROËN: BERLINGO IV (18-20), C1 II (14-18), C3 III (12-17), C3 IV (16-18), C4 CACTUS (14-20), C4 AIRCROSS (18-20), C-ELYSEE (12-18), DS3 (12-18) PEUGEOT: 108 (14-18), 208 (12-21), 2008 (13-21), 301 (12-20), 308 (13-21), 3008 (16-21), 508 (19-21), 5008 (14-21), PARTNER III (15-18) PARTNER IV (18-21) RIFTER (19-21) TOYOTA: AYGO (14-18) GM: CROSSLAND X (17-20), COMBO E (18-20), GRANDLAND X (17-20)
INSTRUMENTE OEM	CITROËN: G-0109-6 (2), 0109-2B (1), 0109-2C (3), 0109-2D (4), 0197-N (1) PEUGEOT: G-0109-6 (2), 0109-2B (1), 0109-2C (1), 0109-2D (4), 0197-N (1) VAUXHALL: EN-52127-2 (1), EN-52809 (2)
CODURILE DE MOTOR	1.2 VTI: 1PP(HM01), EB2 (HMZ), EB2DTS(HNY), EB2 (HMW), EB2M (HMY), EB2 (HMZ), EB-2DTS(HNY), HMP (EB2FB), HMT(EB2D), HMU(EB2D),HMV (EB2M), HMY (EB2M), HMZ (EB2), HMZ (EB2D), HMZ (EB2F),HMZ (EB2FB) 1.2 E-VTI: HMZ (EB2F), EB2F (HMZ) 1.2 PURETECH THP: HN2 (EB2DT) 1.2 PURETECH VTI: EB2ADS (HNS), EB2D(HMT), EB2ADJ (HNP),EB2ADT (HNK), EB2ADTX (HNN), EB2DTS (HNW), EB2DTM (HNV),EB2DTSM (HNW), EB2FA (HMR), EB2FAD (HMH), EB-2FAD (HMM),EB2DT (HNZ), EB2F (HMX), EB2F (HMT), EB2F(HMZ), EB2DTS(HNY),EB2M(HMY)

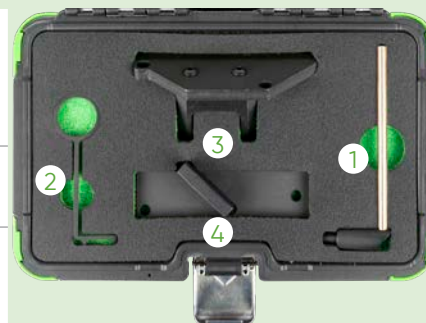

REF. DESCRIERE

16400 PSA CALIBRU DE VERIFICARE CUREA DE TRANSMISIE (REF. 54288)

54323

119,00€



KIT DISTRIBUȚIE PE LANȚ PSA 1.0, 1.2 VTI, 1.2 GDI PURETECH

MĂRCI	CITROËN: C1 II (2014-2018), C3 III (2012-2017), C3 IV (2016-2018), C4 CACTUS (2014-2020), C4 AIRCROSS (2018-2020), C-ELYSEE (2012-2018), DS3 (2012-2018), BERLINGO IV (2018-2020), GM: CROSSLAND X (2017-2020), COMBO E (2018-2020), GRANDLAND X (2017-2020) PEUGEOT: 108 (2014-2018), 208 (2012-2021), 2008 (2013-2021), 301 (2012-2020), 308 (2013-2021), 3008 (2016-2021), 508 (2019-2021), 5008 (2014-2021), PARTNER III (2015-2018), PARTNER IV (2018-2021), RIFTER (2019-2021) TOYOTA: AYGO (2014-2018).
INSTRUMENTE OEM	EN-52127-2 (1), 0109-2B (1) J-0109-2C (2) J-0109-2D (3) EN-52127-1 (4), 0109-2A21 (4) G-0109-6 (5)
CODURILE DE MOTOR	B12XHL (EB2DT), B12XHT (EB2DTS), D12XHL (EB2ADT), D12XHL (HNP/EB2ADT), D12XHT (EB2ADTS), EBO (ZMZ), EBOF (ZMZ), EB2ADT (HNK), EB2ADT (HNP), EB2ADTD (HNK), EB2ADTS (HNS), EB2ADTX (HNN), EB2DT (HNZ), EB2DTM (HNV), EB2DTS (HNW), EB2DTS (HNY), EB2DTSM (HNW), EB2FA, EB2FAD, F12XHT (EB2ADTS), F12XHT (HNS/EB2ADTS), HMM (EB2FAD), HMM (EB2FAD), HMP (EB2FB), HMR (EB2FA), HMT (EB2), HMT (EB2F), HMU (EB2D), HMU (EB2FD), HMV (EB2M), HMW (EB2), HMX (EB2F), HMY (EB2M), HMZ (EB2), HMZ (EB2F), HNJ (EB2ADTXM), HNK (EB2ADT), HNK (EB2ADTD), HNK/EB2ADTD, HNL (EB2ADTSM), HNN (EB2ADTX), HNP (EB2ADT), HNS (EB2ADTS), HNS/EB2ADTS, HNT (EB2ADTS), HNV (EB2DT), HNV (EB2DTM), HNW (EB2DTS), HNW (EB2DTSM), HNX (EB2DT), HNX (EB2DTS), HNY (EB2DTS), HNZ (EB2DT), HNO2, ZMZ (EBO), ZMZ (EBOF), 1PP (HM01)



54213

19,80€

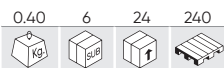

SET INSTRUMENTE DE REGLARE A MOTOARELOR PENTRU ROVER/PEUGEOT/FORD/VOLVO 2.0, 2.2L D

MĂRCI	PEUGEOT: 807 (05-11), 407 (05-11), 607 (05-09).CITROËN: C4 (04-10), C5 II (04-10). LAND ROVER: FREELANDER (06-10). VOLVO: S40 (03-10), V50 (06-10), C70 (06-10), S80 (07-10), C30 906-10, V70 (07-10).FORD: S MAX 2.2 (08-10), GALAXY 2.2 (08-10), MONDEO 2.2, 2.0 (07-10).
INSTRUMENTE OEM	PSA 0188.M, FORD 303-735, 303-1277, VOLVO 999-7122 (1) PSA 0188.X, FORD 303-1059, 303-1270, VOLVO 999-7121 (2) PSA 0188.F, FORD 303-393A, 303-393-01, 303-1272, VOLVO 999-7119/7120 (3)
CODURILE DE MOTOR	PEUGEOT: DW10UTED4 (RHK), DW10BTED4 (RHR)DW12B-TED4 (4HS), (4HP), (4HT), (4HR). CITROËN: DW10BTED4 (RHR). LAND ROVER:DW12BTED4, 224DT. VOLVO:D420T 2.0D. FORD: QXBA(2.2), QXWA(2.0), QXBB(2.0),Q4BA(2.2), QXWA(2.0), QXWB(2.0), AZBA(2.0), AZBC(2.0), AZWA(2.0)

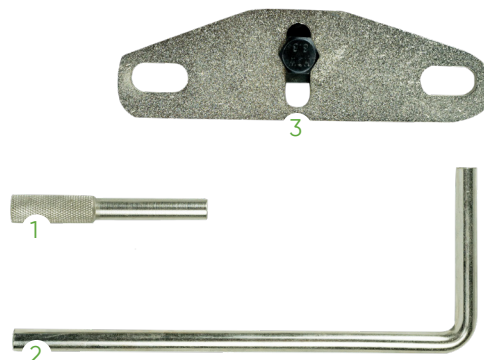

54432

43,00€



INSTRUMENT DE SINCRONIZARE PENTRU PSA 2.7, 3.0 HDI

MĂRCI	CITROËN C6 JAGUAR S-TYPE (X200) 2004 - 2008, XF S (X250) 2008 - 2015, XF S (X260) 2015 - 2020, XJ6 TDVI (X350/358) 2005 - 2010, XJ (X351) 2010 - 2020, F-PACE S 30D (X761) 2016 - 2020 LAND ROVER: DISCOVERY 3 TDV6 (L319) 2004 - 2009, DISCOVERY 4/DISCOVERY SDV6, TDV6 (L319) 2009 - 2017, DISCOVERY SD6, TD6 (L462) 2017 - 2021, RANGE ROVER SDV6, SDV6 HYBRID, TDV6 (L405) 2012 - 2021, RANGE ROVER SPORT SDV6, TDV6 (L320) 2005 - 2013 PEUGEOT 407, 607 COUPE RANGE ROVER VELAR D275, D300 (L560) 2017 - 2021, RANGE ROVER SPORT SDV6, SDV6 HYBRID, TDV6 (L494) 2013 - 2021
INSTRUMENTE OEM	303 11117 (1), 303 11116 (2), 303 1132 (3), 303 1126 (4), 0195H (4), 0195C (5), 0195K (6), 0188-K (7)
CODURILE DE MOTOR	2.7: DT17 TED4 (UHZ), DT17BTED4 (UHZ) 3.0: DT20C (X8C/X8Z), DT20CTED4 (X8Z)

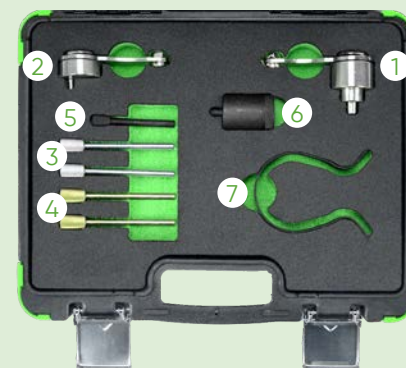

54433

18,00€



INSTRUMENT DE SINCRONIZARE PENTRU PSA 1.0, 1.1, 1.2, 1.4, 1.6, 2.0

MĂRCI	CITROËN BERLINGO 2008 - 2011, C2 2003 - 2010, C-ELYSEE 2012 - 2016, C3 PLURIEL 2003 - 2010, C4 2004 - 2011, NEMO 2008 - 2015, XSARA 2000 - 2005 PEUGEOT 106 1998 - 2003, 206 1998 - 2009, 207 2006 - 2013, 306 1998 - 2003, 307 2000 - 2008, 1007 2005 - 2010, PARTNER 1998 - 2011, BIPPER 2008 - 2015
INSTRUMENTE OEM	0132QY (1), 4507 TA (1), 0132AK (2), 0153AK (2), 0188K (2), 0189K (2), 1 870 900 100 (2), 4533 TAD (2), MOT 1436 (2) 3MM PIN (3), 0132AB (4), 0178D (4), 0194A (4), 77440010400 (4), 1.860.617.000 (4), 11 9 790 (4), 21-260 (4), 303-732 (4), 4527 TS2 (4), 49 JE02 018 (4), 5711 TD (4), 99360608 (4), 999 7169 (4), KM-6349 (4), 0132AJ (5), 0187B (5), 0189B (5), 0194B (5), 09919 58120 (5), 21 263 (5), 303 735 (5), 3031277 (5), 49 JE02 021 (5), 607589011500 (5), 8MM DRILL BIT (5), 8MM PIN (5), 999 7122 (5), EN-52137 (5), MOT. 1430 (5), MOT 1430 (5), 0123-RZ (6), 0132R (6), 0153AA (6), 0153AB (6), 0153G (6), 0153ZY (6), 10MM PIN (6), 4507 TB (6), 7014 TN, 9767 27 (6), M10 X 70MM (6), 0132Q (7), 0132QZ (7), 132Z (7), 4507 TA (7)
CODURILE DE MOTOR	1.0: TU9 (C1A), TU9/K (C1A), TU9M (CDY/CDZ), TU9MZ (CDY/CDZ), TU9M/L (CDZ), TU9M/L3 (CDY) 1.1: TU1A (HFV/HFX), TU1JP (HFX/HFY/HFZ), TU1JP/L4 (HFX), TU1/K (H1A), TU1M (HDZ), TU1M/L (HDZ), TU1M/L3 (HDY/HDZ), TU1M/Z (HDZ), TU1M+ (HDY/HDZ) 1.4: ET3J4 (KFU), ET3JP4 (KFU), TU3A (KFT/KFV/KFW), TU3FJ2 (K6B/KFZ), TU3FM (KDY), TU3JP (KFV/KFW/KFX), TU3JP/IFL4 (KFX), TU3JP/L3 (KFX), TU3JP/L4 (KFX), TU3JP/IFL4 (KFX), ET3J4 (KFU), TU3M (KDX), TU3M/Z (KDY) 1.6: EC5 (NFP), EC5F (NFP), TU5J2 (NFY/NFW), TU5J4 (NFU), TU5JP (NFT/NFZ), TU5JP/L3 (NFZ), TU5JP/L4 (NFT/NFV), TU5JP4 (NFU), TU5JP4B (NFR), TU5JP4 (NFS), TU5JP4/L3 (NFX), TU5JP4/L4 (NFU/NFX), XU5JP (BFZ) 1.8: XU7JB (LFX), XU7JP (LFW), XU7JP/L3 (LFZ), XU7JP4 (LFY), XU7JP4/L3 (LFY) 2.0: XU10JC/Z (RFU), (RGX), XU10J2TE/V (RGX), XU10J2U (RFL), XU10J4R (RFR/RFV), XU10J4R/L3 (RFV), XU10J4RS/L3 (RFS)

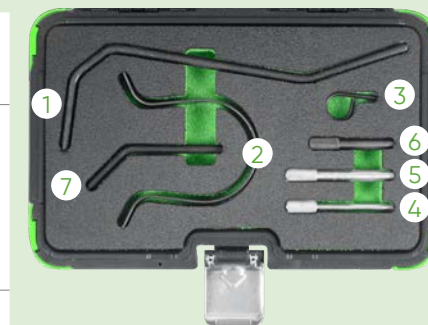

53293

134,00€

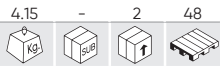

SET DISTRIBUȚIE PE LANȚ FORD

MĂRCI	B-MAX (12-17), C-MAX (07-17), COUGAR (98-01), COURIER (00-02), ESCORT (94-98), FIESTA (95-17), FOCUS (98-17), FOCUS C-MAX (03-07), FUSION (02-12), GALAXY (06-15), GRAND C-MAX (10-17), KUGA (08-15), MAVERICK (01-07), MONDEO (93-15), ORION (94-94), PUMA (97-02), S-MAX (06-15), TOURNEO CONNECT (02-15), TRANSIT (06-11), TRANSIT CONNECT (02-16), ECOSPORT (13-15), TOURNEO COURIER (14-15), GRAND TOURNEO COURIER (13-15).
INSTRUMENTE OEM	303-376 (21-162B) (1), 303-1059 (2), 303-193 (21-104) (3), 303-393-01 (4), 303-1054 (5), 303-1097 (6), 303-748 (7), 303-734 (21-262) (8), 303-651 (21-229) (9), 303-393A (21-168) / 303-393-02 / 303-507 (21-210) / 303-620 (21-163) / 303-732 (21-260) / 303-735 (21-263).
CODURILE DE MOTOR	PETROL: AODA/B, ASDA, ASDB, CFBA, CGBA/B, CHBA/B, CJBA/B, CSDA/B, DHA, DHB, DHC, DHD, DHE, DHF, DHG, EDBB, EDBD, EDDB, EDDC, EDDD, EDDF, EYDB, EYDC, EYDD, EYDE, EYDF, EYDG, EYDI, EYDJ, EYPA, EYPC, F8JA, F8JB, FHA, FHD, FHE, FHF, FUJA, FUJB, FXDA/C, FXDB/D, FXJA, FXJB, FYDA/C, FYDB/D, FYJA, FYJB, HWDA, HWDB, L1F, L1J, L1L, L1N, L1Q, L1T, L1V, L1W, M7JA, M7JB, MHA, MHB, NGA, NGB, NGC, NGD, QQDA/B/C, QQDB, RKA, RKB, RKF, RKH, RKJ, RKK, HXDA. GASOIL: F6JA, F6JB, F6JC, HHJA, HHJB, G8DA, HHDA, HHDB, RTN, RTQ, RTP, C9DC, BHDA/B, BHPA, C9DA/B, F9DA/B, FFBA, FFDA, HCPA, HCPB, KKDA, P7PA, P9PA, QYWA, R2PA, R3PA, RWPA, G6DA, G6DB, G6DC, AZWA, QXWA.



53294

119,00€

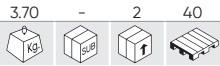

SET DISTRIBUȚIE PE LANȚ FORD MAZDA

MĂRCI	FORD: COURIER (00-02), C-MAX (03-10), FIESTA (02-11), FOCUS (98-11), FUSION (02-11), GALAXY (06-10), KUGA (06-10), MONDEO (07-10), S-MAX (06-10), TOURNEO CONNECT (02-13), TRANSIT CONNECT (02-13) PEUGEOT: BIPPER (08-10) DISPATCH / JUMPY III (07-12) EXPERT III (07-12) NEMO (08-10) PARTNER I / II (05-11) PARTNER III (08-16) 107 (05-10) 1007 (05-10) 206 (01-12) 206+ (09-13) 206 CC (05-07) 207 (06-13) 207 CC (07-15) 208 (11-15) 307 (01-08) 308 (07-15) 308 CC (09-15) 407 (05-11) 508 (04-15) 2008 (13-15) 3008 (09-15) 4008 (12-15) 5008 (09-15). MAZDA: 2 (02-15), 3 (09-14) CITROËN: C1 (05-10), C2 (03-10), C3 I / II (02-10), C3 III (10-15), C3 PLURIEL (04-10), C3 PICASSO (09-12), C4 (04-11), C4 II (11-15), C4 PICASSO (06-12), C4 GRAND PICASSO (10-12), DS3 (09-12), DS4 (11-12), DS5 (12-15), C5 II (04-08), C5 III (04-12), XSARA II (02-04), XSARA PICASSO (04-10)
INSTRUMENTE OEM	FORD: 303-376B (1), 303-193 (2), 303-393 (3), 303-732 (4), 303-651 (5), 303-393/01, 303-1059, 303-734, 303-735, MAZDA: 303-732, 303-734, 303-735. PSA: 0194-A, 0194-C, 0194B.
CODURILE DE MOTOR	1.4D TDCi/Hdi: DV4TD(8HT), DV4TD(8HX), DV4TD(8HZ), DV4TD(8HW), DV4TED4(8HX), DVTED4(8HV), DV4TED4(8HY), DV4C(8HP), DV4C(8HR), DV4TED(8HS), F6JA, F6JB, F6JC. 1.6D TDCi/HDi: DV6TED4(9HZ), DV6ATED4(9HX), DV6TED4(9HY), DV6DTED(9HP), DV6C(9HR), DV6CATED(9HX), DV6C(9HL), DV6TED(9HP), DV6ATED(9HY), DVTED4(9HV), DV6TED4(9HX), DV6C(9HD), DV6C(BHX), DV6C(BHZ), DV6(9HR), DV6BTED4(9HW), DV6DTED(9HJ), DV6ETED(9HN), DV6ATED4BU(9HS), DV6BTED4(9HT), DV6BUTED4(9HT), DV6TED4B(9HV), DV6UTED4(9HX), DV6TED(9HD), DV6UTED4(9HU), DV6D(9HP), DV6TED4(9HV), DV6C(9HD), DV6TED4(9HW), DV6AT(9HX), DV6ATED(9HX), DV6CTED(9HC), DV6AUTED4(9HX), DV6TED4B, DV6DTED(9HF), HHJA, HHJB, G8DA, G8DB, HHDA, HHDB, MZ-CD, Y6. 1.8D TDCi/HDi: BHPA, C9DA/B, FFBA, G6DA, G6DB, G6DC, HCPA, HCBP, KKDA, P7PA, P9PA, R2PA, R3PA, RWPA. 1.8c: C9DC, RTN, RTQ. 1.8d Tdi: C9DA/B, C9DC. 2.0D TDCi/HDi: AZWA, G6DA, G6DB, G6DC, RHE(DW10CTED4), QXWA, QXWB.

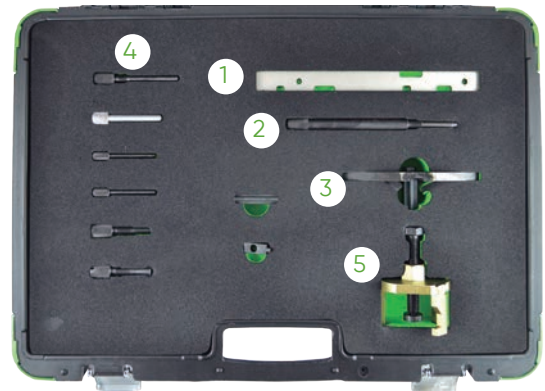

53318

24,00€

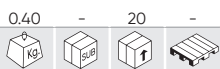

EXTRACTOR PINION PT AROBRELE CU CAME FORD

MĂRCI	FORD
INSTRUMENTE OEM	F8M, F8Q, S8U, S9U.



53295

77,00€

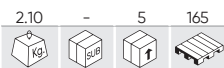

SET DISTRIBUȚIE PE LANȚ FORD 1,8TDDI, TDCI

MĂRCI	C-MAX (07-10), COURIER (00-02), FIESTA (00-02), FOCUS (98-11), FOCUS C-MAX (03-07), GALAXY (06-10), MONDEO (07-10), S-MAX (06-14), TOURNEO CONNECT (02-13), TRANSIT CONNECT (02-13).
INSTRUMENTE OEM	303-193 (21-104) (1), 303-393 (21-168) (2), 303-376 (21-162B) (3), 303-652 (21-230) (4), 310-095 (23-067) (5)
CODURILE DE MOTOR	1.8D TDCI: BHPA, F9DA, F9DB, FFBA, FFDA, FFWA, HCPA, HCPB, KHBA, KKDA, KKDB, P7PA, P9PA, P9PB, QYBA, QYWA, R2PA, R3PA, RWPA, RWPC. 1.8D TDCI/ECONETIC: KHBA. 1.8D TDI: BHDA, BHDB, BHPA, C9DA, C9DB, C9DC. 1.8D TURBO: C9DC, RTN, RTP, RTQ.



53296

60,00€

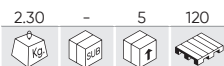

SET DE DISTRIBUȚIE PT POMPA DE INECȚIE FORD/JAGUAR DURATORQ

MĂRCI	FORD: MONDEO (00-07), TRANSIT (00-14). CITROËN: RELAY, JUMPER III (06-13). FIAT: DUCATO (06-11).	JAGUAR: X-TYPE (03-10). PEUGEOT: BOXER III (06-12). LAND ROVER: DEFENDER TD4 (06-11). LDV: CONVOY (02-06).
INSTRUMENTE OEM	303-1151 (1), 303-679A/21-238 (2), 303-732 (3), 303-675/21-234 (4), 303-698/21-251 (5)	
CODURILE DE MOTOR	12.0D DI/TDDI/TDCI: ABFA, D3FA, F3FA, D5BA, D6BA, F1FA, FMBA, FMBB, HJBA, HJBB, HJBC, HJBE, N7BA, N7BB. 2.2D TDCI/ECONETIC: BG, CYFA, CYFB, CYFC, DRFA, DRFB, DRFC, P8FA, P8FB, PGFA, PGFB, QJBA, QJBA (BG), QJBB, QJBC, QJBD, QVFA, QWFA, SRFA, SRFB, SRFC, SRFD, SRFE, UHFA. 2.2D HDI/JTD: P22DTE (4HM), P22DTE (4HU), P22DTE (4HV). 2.4D DI/TDCI: DOFA, D2FA, D2FB, D4FA, F4FA, FXFA, H9FA, H9FB, H9FD, JXFA, JXFC, PHFA, PHFC. 2.4D TD/TDI: ZSD 424. 2.4D TD4: 244DT.	

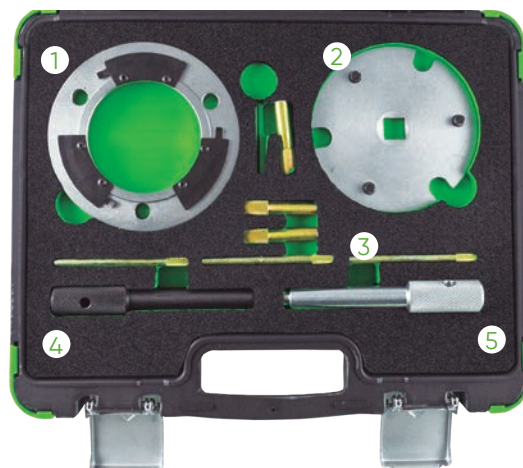

54419

57,00€

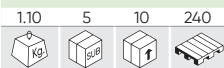

EXTRACTOR/INSTALATOR GARNITURI DE ETANȘARE A ARBORELUI COTIT FRONTAL FORD DURATORQ 2,0, 2,2, 2,4,3,2

MĂRCI	FORD MONDEO 2000 - 2007 RANGER 2011 - ON TRANSIT 2000 - 2006 TRANSIT 2006 - 2014 TRANSIT 2014 - 2019 TRANSIT/TOURNEO CUSTOM 2012 - 2016
INSTRUMENTE OEM	21 238 (1), 303-679A (1), 303-682 (2)
CODURILE DE MOTOR	2.0 Di ABFA D3FA F3FA 2.0 TDCI FMBA FMBB HJBA HJBB HJBC N7BA N7BB SDBA F1FA 2.0 TDDi D5BA D6BA 2.2 TDCI QJBA QJBB QJBC QJBD GBVAJQF GBVAJQJ GBVAJQW CVRA CVRB CYFA CYFB CYFC CYRA CYRB DRFA DRFB DRFC DRFE DRRA DRRB P8FA P8FB PGFA PGFB QVFA QWFA SRFA SRFB SRFC SRFD SRFE UHFA UHFB 2.4 Di D2FA D2FB D4FA DOFA F4FA FXFA 2.4 TDCI H9FA H9FB H9FD JXFA JXFC 3.2 TDCI SAFA SA2R SA2S SA2W SAFA SAFB



54420

102,00€

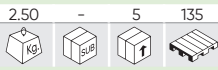

N

SET DE REGLARE A COMBUSTIBILULUI - FORD/VOLVO 2.5 (EURO 4)

MĂRCI	FORD: FOCUS 2.5 RS / ST, MONDEO 2.5, S-MAX 2.5, GALAXY 2.5 ST (2005-) VOLVO: C30 (06-10), C70 (98-10), S40 (96-10), S60 (00-09), S70 (97-07), S80 (98-06), V40 (96-10), V50 (04-10), V70 (97-07), XC70 (02-07), XC90 (02-10)
INSTRUMENTE OEM	303-1178 (1), 999 5452 (1), MOT 1337 (1) 303-1182 (2), 999 5451 (2), MOT 1340 (2) 303-1179 (3), 999 5433 (3) 303-1183 (4)
CODURILE DE MOTOR	FORD: 2.5 Turbo (Euro 4), HUBA / HUWA / HYDA / JZDA VOLVO: 1.6 (B4164S), 1.8 (B4184S), 1.9T (B4194T), 2.0 (B4204S / B4204T), 2.0T (B5204T3 / B5204T4 / B5204T5), 2.3 (B5234FS), 2.3T (B5234T3 / B5234T7 / B5234T9) VOLVO: 2.4 (B5244S / B5244S2 / B5244S4 / B5244S5 / B5244S7), 2.4T (B5244T / B5244T3 / B5244T4 / B5244T5 / B5244T7), 2.5R (B5254FS), 2.4D (D5244T9 / D5244T8 / D5244T13)

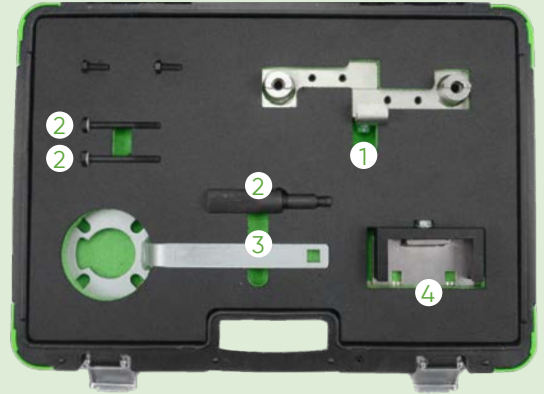

54421

52,00€

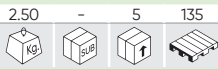

N

DISPOZITIVUL DE INSTALARE A CURELII AUXILIARE FORD/VOLVO 1.4 1.6

MĂRCI	FORD 1.4, 1.6 (FOCUS, C-MAX, MONDEO) VOLVO 1.6 (S40, C30, V50)
INSTRUMENTE OEM	303-1179
CODURILE DE MOTOR	B4164S3, FUJA, FXJA, FYJA C12HM7AD, C12LM7AA, ZH12FUJA, ZH12FUJB, ZH12M7JB C14HDEZ, C14HHDCB, ZH14ASDA, ZH14FXDA, ZH14FXDB, ZH14FXDC, ZH14FXDD, ZH14FXJA, ZH14FXJB 16HDEZ, CH16HDEZ, C16HHDEY, ZH16FYDA, ZH16FYDB, ZH16FYDC, ZH16FYDD, ZH16FYDH, ZH16FYJA, ZH16FYJB, ZH16HWDA, ZH16HXDA



54424

64,50€

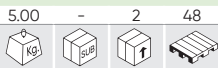

N

INSTRUMENT DE SINCRONIZARE PENTRU FORD 2.0 ECOBOOST

MĂRCI	FOCUS, GALAXY, MONDEO, S-MAX
INSTRUMENTE OEM	303-1504 (1) 303-1600 (2), 300-1565 (2) 303-1521 (3) 303-748 (4) 303-1595 (5) 2MM TENSIONER (6)
CODURILE DE MOTOR	MGDA, R9CB, R9CD, R9CF, R9CH, R9DA, R9DB, R9DC, R9DD, TNBA, TNBB, TNCC, TNCD, TNCF, TNWA, TNWB, TPBA, TPWA, TVDA, XQDA

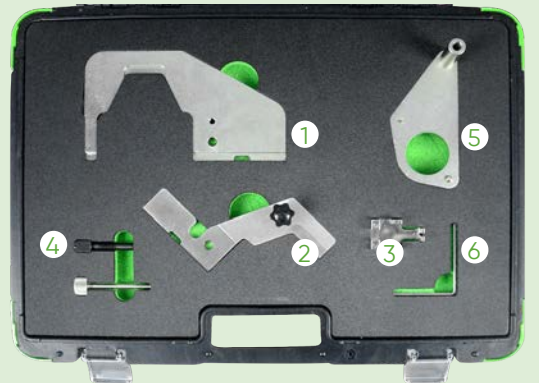

53324

12,50€

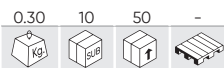

SET DISTRIBUȚIE PE LANȚ FORD

MĂRCI	FORD: B-MAX (15-17), C-MAX (07-10), COUGAR (98-01), FIESTA (95-17), FOCUS (98-11), FOCUS C-MAX (03-07), FUSION (02-12), GALAXY (06-15), MAVERICK (01-07), MONDEO (93-15), PUMA (97-02), S-MAX (06-15), TOURNEO CONNECT (02-06), TRANSIT (06-12), TRANSIT CONNECT (02-06). MAZDA: 121 ZG (95-00), 2 DY (02-07), 3 BK (03-09), 3 BL (09-15), 5 CR (05-10), 5 CW (10-12), 6 GG/GY (02-07), 6 GH (07-15), MPV LW (02-05), MX-5 NC (05-16), TRIBUTE EP (04-06). VOLVO: C30 (06-13), S40 (06-12), S80 (07-11), V50 (04-12).
INSTRUMENTE OEM	FORD: 303-1054, 303-507 (21-210), 303-620 (21-163), 303-574, 303-748, 303-376 (21-162B), 303-376B MAZDA: 49 JE01 061, 303-574, 49 JE02 061, 303-465, 49 JE01 054 VOLVO: 999 7152, 999 7151.
CODURILE DE MOTOR	1.4 / 1.6

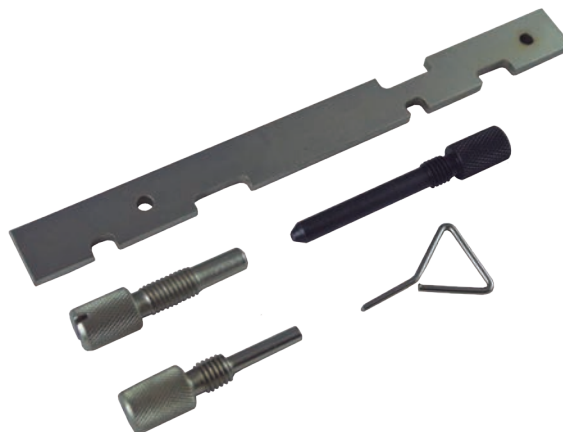

53653

207,00€



SET DISTRIBUȚIE PE LANȚ FORD

MĂRCI	FORD: FIESTA, FOCUS, B-MAX, ECOSPORT.
INSTRUMENTE OEM	303-1605 (1), 303-1606 (2), 303-1604 (3), 303-1602 / 503-393A / (21-168) (4), 303-1054 (5), 303-732 (6)
CODURILE DE MOTOR	M1DD, M1JA, M1JC, M1JE, M1JHM1JJ, M1DA, M2DA, M2DB, M2DC, SFDBSFJA, SFJB, SFJC, SFJD



54201

37,60€



SET DE INSTRUMENTE DE SINCRONIZARE A MOTORULUI FORD

MĂRCI	FORD: C-MAX(07 - 10), C-MAX/GRAND C-MAX(10-18), FIESTA(08-18), FOCUS/FOCUS C-MAX(04-11), FOCUS(11-18), MONDEO(07-15)
INSTRUMENTE OEM	303-1097 (1), OEM 303-1054 (2), OEM 303-1059, 303-1270, 0188X, 999-7121 (3), OEM 303-748, 999-7152, 21-259 (4), OEM 303-735, 999 7122, 0187B, 0189B, 0132AJ1, 21-263, 0188M, MOT 1430, 303-1277, 0194B (5)
CODURILE DE MOTOR	11.6.TI-VCT HXDA (2003-2007), 2.0 TDCI, G6DA, G6DB, G6DC 2003-2007



54204

124,00€

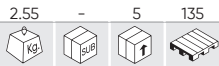

SET INSTRUMENTE DE REGLARE A MOTOARELOR PENTRU FORD 2.0 ECOBLUE

MĂRCI	FORD EDGE, FOCUS, GALAXY, S-MAX (FROM 2018); KUGA, MONDEO, RANGER (DESDE 2019); TRANSIT, TRANSIT CUSTOM AND TOURNEO CUSTOM (DESDE 2016); TODOS CON MOTOR ECOBLUE TDCI ; AWD, FWD Y RWD.
INSTRUMENTE OEM	303-1637 (1), 303-1650 (2), 303-1643 (3).
CODURILE DE MOTOR	BCCC,YLCB,YLDA,YLF6,YLFA,YLFB,YLFS,YLR6,YLRA,YMCB,YM-F6,YMFA,YMFB,YMFS,YMHA,YMRA,YNCA,YNF6,YNFA,YNFB,YNFS,Y-NR6,YNRA

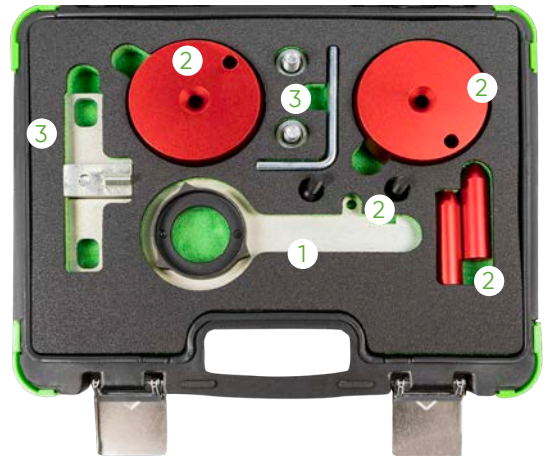

54208

76,00€



SET INSTRUMENTE DE REGLARE A MOTOARELOR PENTRU FORD 2.0 ECO BOOST SCTI, TI-VCT

MĂRCI	<u>FORD</u> : GALAXY(2010)MONDEO (2010) S MAX (2010) FOCUS(2011)
INSTRUMENTE OEM	303-748 (1), 303-1504 (2), 303-1565 (3), 303-1521 (4)
CODURILE DE MOTOR	TNWA, TNWB, TPWA, TNBA, TPBA, MGDA, XQDA



54209

29,70€

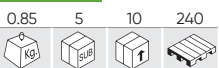

SET INSTRUMENTE DE REGLARE A MOTOARELOR PENTRU FOR/MAZDAD 2.2, 3.2 TDCI

MĂRCI	FORD_RANGER 3.2L (2011-2016) FORD_RANGER 2.2L (2011-2015) FORD_TRANSIT 2.2L (2006-2016) FORD_EVEREST 3.2L (2015) FORD_RANGER 3.2L (2011) MAZDA BT-50 (2011) MAZDA BT-50 3.2L (2011-2016)
INSTRUMENTE OEM	303-675/21-234,303-698/21-251 (1), 303-1587 (2)
CODURILE DE MOTOR	CYFA,CYFB,DRFA,DRFB,P8FA,P8FB,PGFA,PGFB,QVFA,QWFA,SR-FA,SRFB,SRFC,SRFD,SEFE,UHFA,CYFC,DRFC,USRA



54223

149,00€

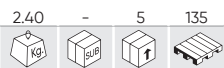

INSTRUMENT DE BLOCARE A PINIONULUI ARBORELUI CU CAME AL MOTORULUI PENTRU FORD 1.5T

MĂRCI	FORD_1,5L DURATEC, ECOSPORT, FIESTA, FOCUS
INSTRUMENTE OEM	303-1639 (1), 303-1643 (2), 303-1647 (3), 303-1648 (4)
CODURILE DE MOTOR	2.2 / 2.5

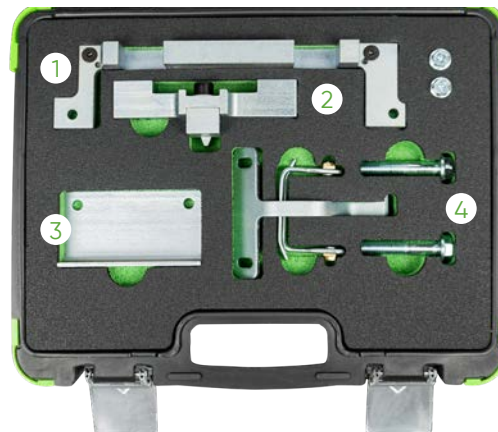

54224

64,50€

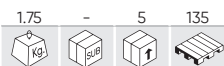

SET INSTALARE/ÎNDEPĂRTARE POMPĂ DE INJECȚIE PENTRU FORD 2.0

MĂRCI	FORD_TRANSIT (17-18), TOURNEO CUSTOM (16-18), TRANSIT CUSTOM (16-18)
INSTRUMENTE OEM	303-1635 (1)/3, 3.3--1635 (2)/1, 303-1635 (3)/2, 303-1635/6 (4)
CODURILE DE MOTOR	YLFS, YMFS, YNFS, YLF6, YMF6, YNF6, YLR6, YMR6 AND YNRS.

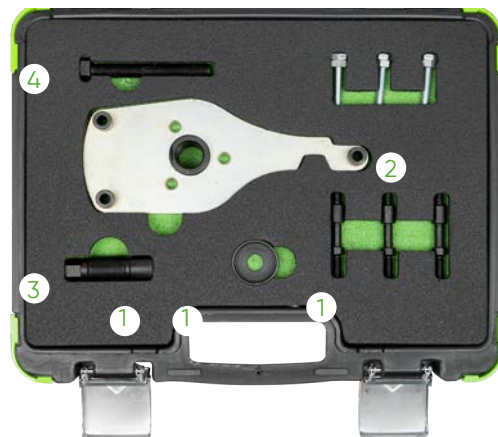

54260

277,00€

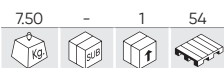

SET MULTIPLICATORI DE CUPLU 5:1 PENTRU MOTOARELE FORD ECOBOOST



1.0 Ecoboost
1.0 Duratec
2.0 Duratec

2.0 Durator-TDCi
2.0 EcoBlue Diesel



53297

45,00€

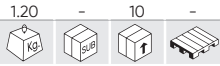

SET DISTRIBUȚIE PE LANȚ JAGUAR/LAND ROVER

MĂRCI	JAGUAR: MS TYPETDVI. LAND ROVER: DISCOVERY 2.7 TDV6. RANGE ROVER: SPORT 2.7 TDV6.
INSTRUMENTE OEM	303-1117 (1), 303-1116 (2), 303-1132 (3), 303-1126 (4) (5)
CODURILE DE MOTOR	276DT, 306DT.

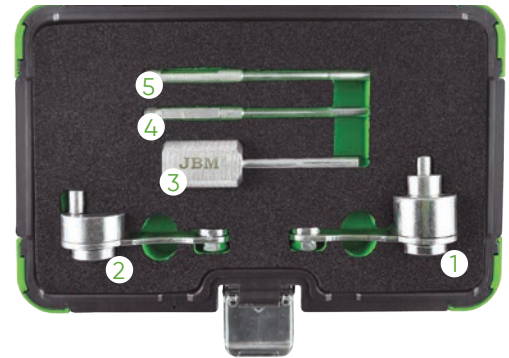

53298

91,00€



SET DISTRIBUȚIE PE LANȚ LAND ROVER

MĂRCI	MOTOARE DIESEL: 200 TDI. 300 TDI. 2.5
	<ul style="list-style-type: none"> - Cutie de transmisie manuală EDC. - 200 TDI. 300 TDI. 2.5 Motoare diesel. - Arborele de deformare a arborelui cotit. - Instrument de blocare pentru pompa de injectie. - Șurub de sincronizare a pompei de injectie 200/300 TDI. - Instrument de sincronizare a motorului 200/300 TWI. - Instrument de sincronizare a pompei DPS 2.5. - Instrument de sincronizare a volantului motorului 2.5.



54422

140,00€



KIT DE REGLARE A AXEI DE ECHILIBRARE JAGUAR/LAND ROVER 2.0D

MĂRCI	JAGUAR: E-PACE D150, D180, D240 (X540) (2017-), F-PACE 20D, 25D, E-PERFORMANCE (X761) (2016-), XE 20D, 25D, E-PERFORMANCE (X760) (2015-), XF 20D, 25D, E-PERFORMANCE (X260) (2015-) LAND ROVER: DEFENDER SD4 D200, SD4 D240 (L663) (2019-2021), DISCOVERY SPORT ED4, SD4, TD4, D150, D180, D240 MHEV (L550) (2015-), DISCOVERY SD4, TD4 (L462) (2017-2021) RANGE ROVER: EVOQUE ED4, SD4, TD4 (L538) (2015-2019), EVOQUE D150, D180, D240 MHEV (L551) (2019-), SPORT SD4 (L494) (2016-2018), VELAR D180, D240 (L560) (2017-)
INSTRUMENTE OEM	JLR-303-1662 (1) JLR303-1663-1 (2) JLR303-1663-2 (3) JLR303-1663-3 (4) JLR-303-1664 (5) JLR-303-1665 (6)
CODURILE DE MOTOR	2.0: AJ200D,AJ200/204DTA,AJ200/2004DTD 2.0: AJ-200D/204DT, AJ-200D/204DTA



54423

108,00€



N

INSTRUMENT DE SINCRONIZARE PENTRU LAND ROVER 3.6D

MĂRCI	RANGE ROVER SPORT: 3.6 (TDV8) DIESEL (2006-2011) RANGE ROVER: 3.6 (TDV8) DIESEL (2006-2011)
INSTRUMENTE OEM	303-1236 (1) 303-1243 (2) 303-1239 (3) 303-1238 (4)
CODURILE DE MOTOR	368DT

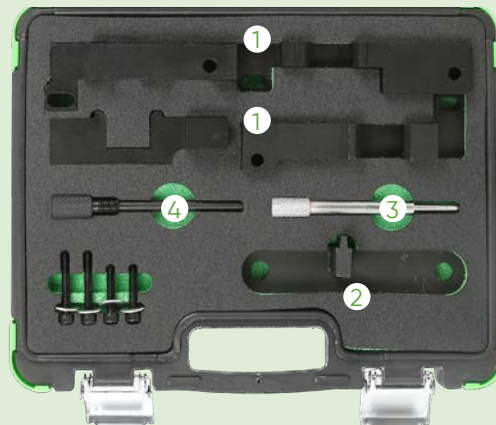

54425

124,00€



N

INSTRUMENT DE SINCRONIZARE PENTRU LAND ROVER FREELANDER V6/ROVER KV6 2.0L, 2.5L

MĂRCI	LAND ROVER: FREELANDER (2000-2006) MG: ZR (2004-2005), ZS (2001-2005), ZT (2001-2005) ROVER: 45 (1999-2005), 75 (1999-2005), 825 (1996-1999)
INSTRUMENTE OEM	LRT 12-175 (1) LRT 12-187 (2) LRT 12-195 (3) LRT 12-196 (4) LRT 12-198 (5) LRT 12-232 (6)
CODURILE DE MOTOR	LAND ROVER: 2,5 KV6 MG: 2,0 KV6, 2,5 KV6 ROVER: 2,0 KV6 2,5 KV6

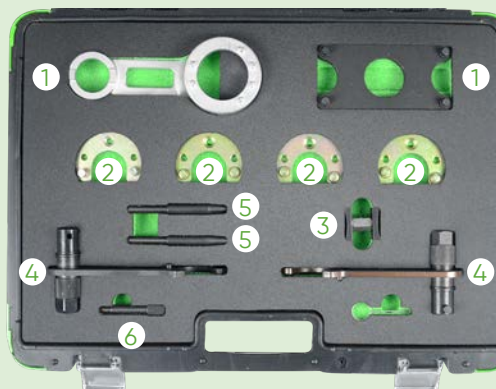

54426

69,00€



N

INSTRUMENT DE SINCRONIZARE PENTRU JAGUAR/LAND ROVER 3.2, 3.5, 4.0, 4.2, 4.4

MĂRCI	DAIMLER: V8 (97-03), SUPER V8 (97-03), SUPER EIGHT (05-10). JAGUAR: S-TYPE (99-08), XF (08-09), XJR (97-10), XJ8 (97-10), XKR (98-09), XK8 (96-09) LAND ROVER: DISCOVERY III (04-09) RANGE ROVER (05-09), RANGE ROVER SPORT (05-09)
INSTRUMENTE OEM	303530 (1) 303531 (2) 303532 (3) 303533 (4) 303645 (5) 303654 (6) T40011 (7)
CODURILE DE MOTOR	3.2: AC,KB,KC 3.5: RB 4.0: BC, CC,CE,DC,EC,GB,GC,LC,MA,MB,NB,NC,PA,PB 4.2: 1B,2B,3B,1G,5G,9G,HB,HG,SB,TB,PC,428PS 4.4: 448PN



54427

113,00€

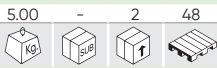

N

INSTRUMENT DE BLOCARE A SCRIPETELUI ARBORELUI COTIT JAGUAR/LAND ROVER 4.0, 4.2, 4.4

MĂRCI	DAIMLER: V8; 4.0 (97-98) JAGUAR: S-TYPE; 3.2, 3.5, 4.2 V8 (99-08), XF; 3.2, 3.5, 4.2 V8 (08-09), XJ; 3.2, 3.5, 4.2 V8 (97-08), XJ8; 4.0 (97-98), XK; 3.2, 3.5, 4.2 V8 (97-08), XK8; 4.0 (97-98) LAND ROVER: DISCOVERY3; 4.2, 4.4 LA V8 (05-09) RANGE ROVER; 4.2, 4.4 SPORT LS V8 (05-09), RANGE ROVER; 4.2, 4.4 LM V8 (06-08)
INSTRUMENTE OEM	LRT 12 080 18G 1437 18G 1437 2 303 191 303 191 03 303 191 04 303 588 303 893
CODURILE DE MOTOR	AJ26, AJ27, AJ28, AJ34 30G,36D,42D,56D,58D,94D,428PS,448PN



54428

31,00€

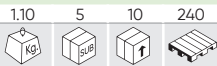

N

INSTRUMENT DE SINCRONIZARE PENTRU CHRYSLER/JEEP 2.8 CRD

MĂRCI	CHRYSLER GRAND VOYAGER 2008 - 2015 DODGE NITRO 2007 - 2011 JEEP CHEROKEE 2008 - 2013, WRANGLER 2007 - 2018
INSTRUMENTE OEM	VM 9991 (1) VM 9992 (2)
CODURILE DE MOTOR	VM64C, ENS, ENS (51C), 49C, 50C, ENS VM10D, ENS VM11D



54429

55,00€



N

INSTRUMENT DE SINCRONIZARE PENTRU CHRYSLER/JEEP 3.0D

MĂRCI	CHRYSLER 300 C 2012 - 2015 JEEP GRAND CHEROKEE 2011 - ON
INSTRUMENTE OEM	VM 10338 1 (1) VM 10338 2 (2) VM 10359A (3), VM 10359 (3) VM 10339 (4), VM 10359 (4)
CODURILE DE MOTOR	3.0 CRD: EXF 3.0 CRD/MULTIJET: EXF VM23D, EXF VM44D, EXF VM44D, EXF VM63D

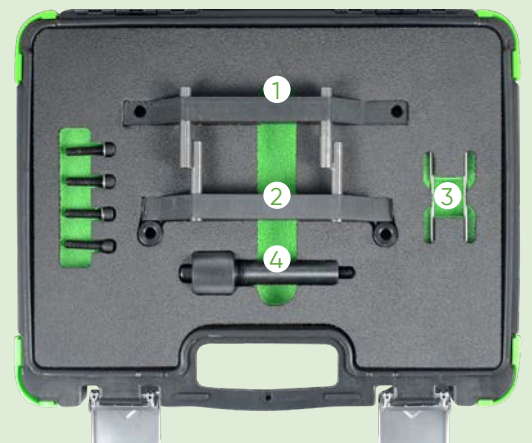

54207

38,90€

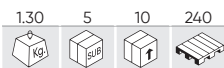

SET INSTRUMENTE DE REGLARE A MOTOARELOR PENTRU CHRYSLER/JEEP LDV 2.5 CRD

MĂRCI	CHRYSLER: VOYAGER (01-08), GRAND VOYAGER (01-08) JEEP: CHEROKEE (01-08) LDV: MAXUS (05-09)	
INSTRUMENTE OEM	VM 9660 (1), VM1052 (2), VM1053 (3), VM1068 / VM1089 (4), VM1080 (5), VM8873 (6)	
CODURILE DE MOTOR	2.5D CRD: R2516C, R2516K, R2516LVM39/40B.	2.8D CRD: R2816C5.05A, R2816K4.



53270

70,00€

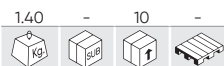

KIT DISTRIBUȚIE PE LANȚ MERCEDES/CHRYSLER/JEEP

MĂRCI	MERCEDES CHRYSLER JEEP
INSTRUMENTE OEM	112589034000 (1), 601589024000 (2), 111589031500 (3)
CODURILE DE MOTOR	HERR.: 112 589 03 40 00: 112, 113, 137, 155, 156, 272/979, 273, 629, 642/992. HERR.: 601 589 02 40 00: 102, 103, 104, 111, 601, 602.91/93/94/96/983, 603.91/93/96/97, 604, 605, 606, 611, 612/965/966, 613. HERR.: 111 589 03 15 00: 111, 119, 604, 605, 606, 611/980, 612, 613, 628, 629, 640, 642/922, 612.965/966, 646, 647, 648 .

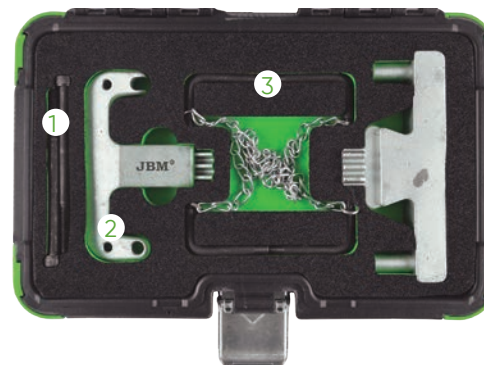

53271

227,00€



KIT DISTRIBUȚIE PE LANȚ MERCEDES BENZ M271

MĂRCI	MERCEDES
INSTRUMENTE OEM	271 589 003100 (1), 271589014000 (2), 271589001500 (3), 156589006100 (4)
CODURILE DE MOTOR	M271. E18ML 2002. DE18ML 2003 - 2005. E16ML 2008. DE18LA 2009.

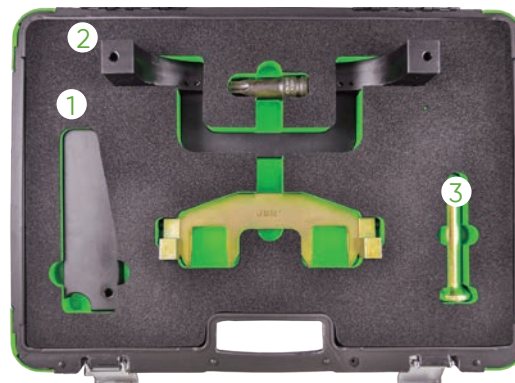

53272

195,00€

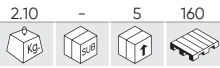

KIT DISTRIBUȚIE PE LANȚ MERCEDES AMG 156

MĂRCI	MERCEDES
INSTRUMENTE OEM	156589006100 (1), 156589003200 (2), 156589016300 (3), 156589006900 (4)
CODURILE DE MOTOR	BENZ AMG 156.ML 63 AMG.S 63L AMG.S 63. AMG. R 63 AMG L 4MATIC. R63 AMG 4MATIC. E 63 AMG. CLS 63 AMG. CLK 63 AMG BLACK SERIES. CLK 63 AMG CABRIO. CL 63 AMG.

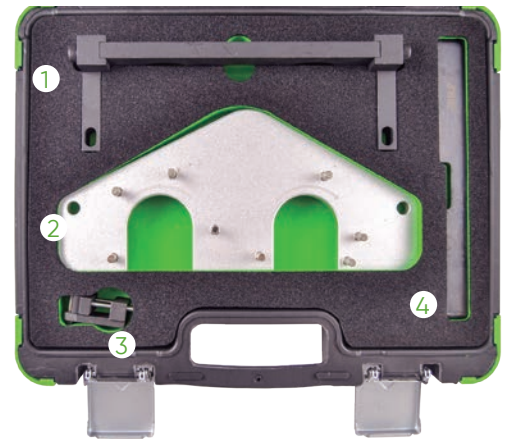

53273

75,00€

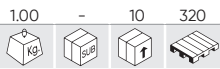

KIT DISTRIBUȚIE PE LANȚ MERCEDES M276, M157, M278

MĂRCI	MERCEDES		
INSTRUMENTE OEM	27658901400		
CODURILE DE MOTOR	<table border="0"> <tr> <td>CL 500 / 63 AMG (C 216) 2010–2013. S 500 / 63 AMG (C 217) 2014. CLS 300 (C 218) 2012. E 300 / 350 / 400 (C/A 207) 2011. CLS 350 / 400 / 500 / 63 AMG (C/X 218) 2011–2014. SLK 350 (R 172) 2011. SL 350 / 400 / 500 / 63 AMG (R 231) 2012. S 500 PLUG-IN HYBRID (V 222) 2014. ML 300 / 350 / 500 / 63 AMG (W 166) 2011.</td> <td>C 400 (W 205) 2014. E 400 HYBRID (W 212) 2012. G 63 AMG (W 463) 2012. E 300 / 350 / 400 / 500 / 63 AMG (W/S 212) 2011. C 350 (W/S/C 204) 2011. S 350 / 500 / 63 AMG (W/V 221) 2010. S 400 / 63 AMG (W/V 222) 2013. R 350 BlueEFFICIENCY (W/V 251) 2012. GL 450 / 500 (X 166) 2012. GLK 350 (X 204) 2011.</td> </tr> </table>	CL 500 / 63 AMG (C 216) 2010–2013. S 500 / 63 AMG (C 217) 2014. CLS 300 (C 218) 2012. E 300 / 350 / 400 (C/A 207) 2011. CLS 350 / 400 / 500 / 63 AMG (C/X 218) 2011–2014. SLK 350 (R 172) 2011. SL 350 / 400 / 500 / 63 AMG (R 231) 2012. S 500 PLUG-IN HYBRID (V 222) 2014. ML 300 / 350 / 500 / 63 AMG (W 166) 2011.	C 400 (W 205) 2014. E 400 HYBRID (W 212) 2012. G 63 AMG (W 463) 2012. E 300 / 350 / 400 / 500 / 63 AMG (W/S 212) 2011. C 350 (W/S/C 204) 2011. S 350 / 500 / 63 AMG (W/V 221) 2010. S 400 / 63 AMG (W/V 222) 2013. R 350 BlueEFFICIENCY (W/V 251) 2012. GL 450 / 500 (X 166) 2012. GLK 350 (X 204) 2011.
CL 500 / 63 AMG (C 216) 2010–2013. S 500 / 63 AMG (C 217) 2014. CLS 300 (C 218) 2012. E 300 / 350 / 400 (C/A 207) 2011. CLS 350 / 400 / 500 / 63 AMG (C/X 218) 2011–2014. SLK 350 (R 172) 2011. SL 350 / 400 / 500 / 63 AMG (R 231) 2012. S 500 PLUG-IN HYBRID (V 222) 2014. ML 300 / 350 / 500 / 63 AMG (W 166) 2011.	C 400 (W 205) 2014. E 400 HYBRID (W 212) 2012. G 63 AMG (W 463) 2012. E 300 / 350 / 400 / 500 / 63 AMG (W/S 212) 2011. C 350 (W/S/C 204) 2011. S 350 / 500 / 63 AMG (W/V 221) 2010. S 400 / 63 AMG (W/V 222) 2013. R 350 BlueEFFICIENCY (W/V 251) 2012. GL 450 / 500 (X 166) 2012. GLK 350 (X 204) 2011.		



54318

105,00€



MAȘINĂ DE NITUIRE A LANȚULUI DE DISTRIBUȚIE

MĂRCI	CHRYSLER JEEP MERCEDES
INSTRUMENTE OEM	112 589 026 300 (1) 103 589 016 300 (2) 602 589 026 300 (3) 602589023300 (4) 602589003900 (5) 602589046301 (6)
CODURILE DE MOTOR	CHRYSLER/JEEP: 2.2D, 2.7D, 3.0D CRD (DIESEL). MERCEDES: 1.7D, 2.1D, 2.2D, 2.7D, 3.0D, 3.2D, 3.9D, 4.0D CDI (DIESEL)

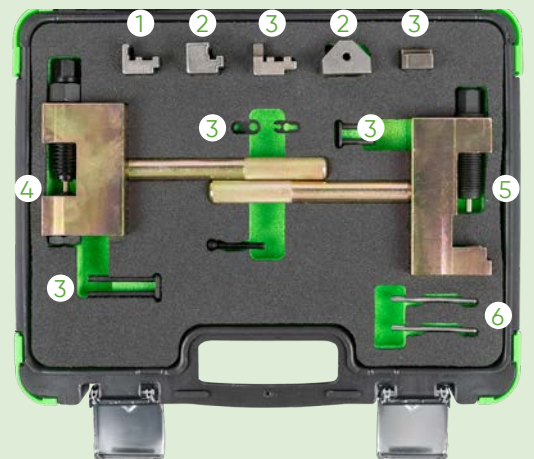

54414

97,50€



N

INSTRUMENT DE SINCRONIZARE PENTRU MERCEDES M651

MĂRCI	A CLASS (2012-2018), B CLASS (2012-2019), C CLASS (2009-2015), C CLASS (2014-2018), CLA COUPE (2013-2019), CLS (2011-2018), E CLASS (2009-2016), GLA (2014-2020), GLC (2015-2019), GLE (2015-2019), GLK (2008-2015), M CLASS (2011-2015), S CLASS (2010-2013), S CLASS (2013-2017), SLC (2016-2017), SLK (2012-2016), SPRINTER (2009-2018), SPRINTER (2018-), V CLASS (2014-), VIANO (2010-2015), VITO (2010-2015), VITO (2014-) MERCEDES-BENZ
INSTRUMENTE OEM	608 31 800 (1) 608 31 830 (2) 608 31 810 (3) 608 31 820 (4) 651 589 00 40 00 (5)
CODURILE DE MOTOR	1.8: 651.901 2.1: 651.900, 651.910, 651.911, 651.912, 651.913, 651.916, 651.921, 651.922, 651.924, 651.930, 651.940, 651.950, 651.955, 651.956, 651.957, 651.958, 651.960, 651.961, 651.980 2.2: 651.925

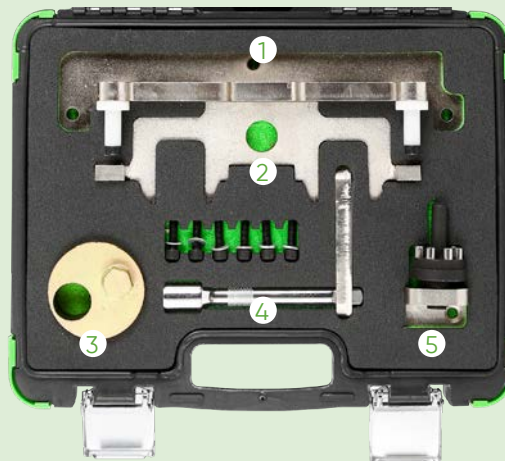

54415

60,00€



N

INSTRUMENT DE SINCRONIZARE PENTRU MERCEDES M651

MĂRCI	GLA X156 200/220 CDI, GLK X 204 200/220/250 CDI, ML W166 250, SLK R172 250 CDI, SPRINTER W906 210/310/510/213/313 CDI, SPRINTER W906 513/216/316/416/516 CDI, V-CLASS W/V 639 2.0/2.2 CDI, VITO W/V 639 110/113/116 CDI MERCEDES-BENZ: A-CLASS W176 180/200/220 CDI, B-CLASS W246 200/220 CDI, C-CLASS W/S/C 204 180/200/220/250 CDI, CLA C117 200/220 CDI, CLD C/X 218 220/250, E-CLASS W/S 212 200/220/250 CDI E-CLASS C/A 207 220/250 CDI, E-CLASS W212 250/300 BLUETEC
INSTRUMENTE OEM	651589004000 (1) 651589014000 (2)
CODURILE DE MOTOR	1,8 651.901 2,1 651.900 651.910 651.911 651.912 651.913 651.916 651.921 651.922 651.924 651.925 651.930 651.940 651.950 651.955 651.956 651.957 651.958 651.960 651.961 651.980

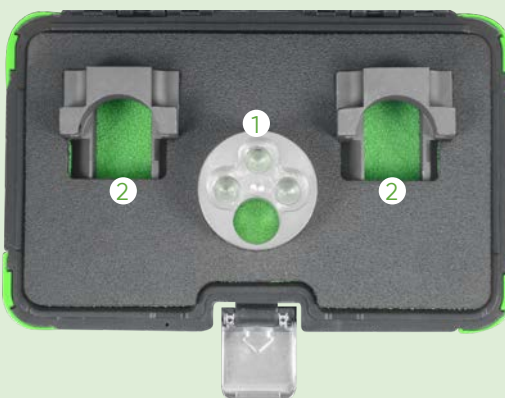

54416

31,00€



N

INSTRUMENT DE SINCRONIZARE PENTRU MERCEDES M642

MĂRCI	G-CLASS (461/463) 2007-2015, GL-CLASS (164/166) 2006-2016, GLE/GLE COUPE (166/292) 2020 GLK (204) 2008-2015, GLS (166) 2016-2019, M-CLASS (164/166) 2005-2015, R-CLASS (251) 2005-2013, S-CLASS (221/222) 2005-2017, SPRINTER (906) 2006-2018, VIANO (639) 2005-2015, VITO (639) 2006-2015 MERCEDES-BENZ: C-CLASS (203/204) 2004-2014, CLK (209) 2005-2009, CLS (219/218) 2005-2018, E-CLASS (211/212/213) 2005-2018, E-CLASS COUPE/CABRIOLET (207) 2009-2017
INSTRUMENTE OEM	642589003100 (1)
CODURILE DE MOTOR	642.820 642.822 642.826 642.830 642.832 642.834 642.835 642.836 642.838 642.850 642.852 642.853 642.854 642.855 642.856 642.858 642.861 642.862 642.867 642.868 642.870 642.872 642.884 642.886 642.890 642.896 642.910 642.920 642.921 642.922 642.930 642.932 642.940 642.950 642.960 642.961 642.970 642.975 642.990 642.992 642.993

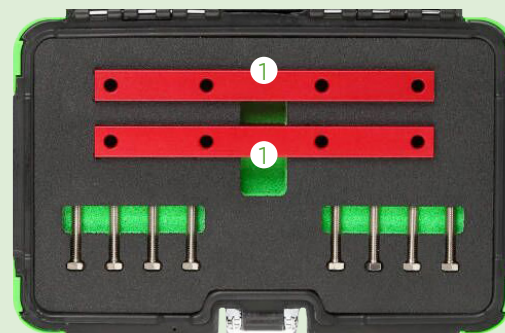

54417

153,00€



N

INSTRUMENT DE SINCRONIZARE PENTRU MERCEDES M133, M270, M274

MĂRCI	MERCEDES BENZ A -CLASS (W176) (2012), MODEL A180/A200 MERCEDES BENZ B CLASS (W246) AS OF 2011, MODEL B180/B200
INSTRUMENTE OEM	270589006100 (1)
CODURILE DE MOTOR	M133 M270 M274

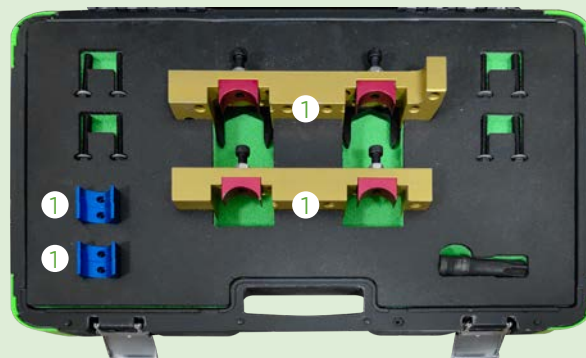

54418

37,00€



N

INSTRUMENT DE SINCRONIZARE PENTRU MERCEDES M112, M113

MĂRCI	C-CLASS (202) 2.4/2.6/2.8/3.2/4.3 - 1998-00, CLK (208) 3.2/4.3/5.4 - 1997-03, E-CLASS (210) 2.4/3
INSTRUMENTE OEM	112589003200 (1) 112589013200 (2) 112589000100 (3)
CODURILE DE MOTOR	MERCEDES.BENZ: M112, M113



51488

16,00€

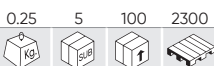

BOLȚURI BLOCAJ MOTOARE RENAULT/NISSAN/DACIA/SUZUKI

MĂRCI	RENAULT: CAPTUR, CLIO II,III,IV, ESPACE/GRAND ESPACE III,IV, FLUENCE, KADJAR, KANGOO, LAGUNA I,II,III, LOGAN/ LOGAN MCV, MEGANE I,II,III,IV, MODUS/GRAND MODUS, SCENIC/GRAND SCENIC I,II,III,IV, TWING II, TRAFIC II, MASTER II 1.5DCI & 1.9 DCI. DACIA: DOKKER, DUSTER, LODGY, LOGAN, SANDERO 1.5DCI NISSAN: ALMERA, CUBE, JUKE, KUBISTAR, MICRA, NOTE, NV200/EVALIA, PRIMERA, TIIDA, INTERSTAR, PRIMASTAR 1.5DCI & 1.9 DCI SUZUKI: GRAND VITARA, JIMNY 1.5DDIS & 1.9DDIS
INSTRUMENTE OEM	MOT1489, MOT1430, MOT1054.
CODURILE DE MOTOR	K9K, F8Q, F9Q - benzină, Clio, R19, Laguna 1.8/2.0 F3R F3P



53289

45,00€

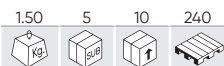

SET DISTRIBUȚIE PE LANȚ RENAULT 1.4, 1.6, 1.8, 2.0 16V

MĂRCI	<p>RENAULT: ESPACE/GRAND ESPACE (98-02), ESPACE/GRAND ESPACE IV (02-10), KANGOO/TREKKA (01-09), LAGUNA (98-01), LAGUNA II (01-07), LAGUNA III (07-13), MEGANE (99-03), MEGANE II (02-10), MEGANE III/SPORT (08-13), MEGANE/SCENIC (99-00), SCENIC/RX4 (99-03), SCENIC/GRAND SCENIC II (03-09), TRAFIC II (01-11), TWINGO II (08-14), VEL SATIS (00-10), WIND (10-14)</p> <p>DACIA: LOGAN/MCV (05-11).</p> <p>NISSAN: KUBISTAR X76 (03-09), PRIMASTAR (02-11).</p> <p>VAUXHALL/OPEL: JETTA, TOURAN, GOLF, GOLF PLUS, POLO, PASSAT, TIguan, SCIROCCO.</p>
INSTRUMENTE OEM	MOT1489 (1), MOT1054 (2), MOT1496 (3)
CODURILE DE MOTOR	<p>1.4 16V K4J: 730, 732, 740.</p> <p>1.6 16V K4M: 752, 753, 760, 761, 764, 788, 812, 813, 854, 856.</p> <p>1.8 16V F4P: 720, 722, 760, 770, 771, 772, 773, 774, 775.</p> <p>2.0 16V F4R: 700, 701, 712, 713, 714, 715, 720, 722, 730, 732, 736, 738, 740, 741, 744, 746, 747, 762, 763, 764, 765, 766, 767, 770, 771, 780, 790, 791, 792, 820, 830, 832, 867.</p> <p>2.0 16V F4RTI: 720, 722, 764, 765, 774, 776, 784, 786, 787, 794, 795, 796, 797, 800, 802, 810, 811, 870, 872, 874, 886, 887, 896, 897.</p>



53290

51,00€



SET DISTRIBUȚIE PE LANȚ RENAULT/VOLVO 16V, 20V

MĂRCI	<p>RENAULT: LAGUNA 2.0 16V / 2.5 20V (1996-1999), SAFRANE 2.0 16V / 2.5 20V (1996-2001)</p> <p>VOLVO: 850 (1992-1997), C70 (1998-2002), S40 (1996-2004), V40 (1996-2004), S60 (2001-2005), S70 (1997-2000), S80 (1999-2005).</p>
INSTRUMENTE OEM	MOT1348 (1), MOT1337 (2), MOT1340 (3)
CODURILE DE MOTOR	<p>RENAULT: N7Q 704/710/711(2.0 16V), N7U 700/701(2.5 20V).</p> <p>VOLVO: B4164S, B4164S2, B4184S, B4184S2, B4184S3, B4184S9, B4184S10, B4194T, BS194T2, B420S4, B4204S2, B4204T, B4204T2, B4204T3, B4204T5, B5202FS, B5204FT, B5204T2, B5204T3, B5204T4, B5204T5, B5234FS, B5204FT, B5234T3, B5234T4, B5234T5, B5234T6, B5234T7, B5234T8, B5234T9, B5244S, B5244S2, B5244SG, B5244SG2, B5244T, B5244T3, B5244T4, B5244T5, B5244T7.</p>

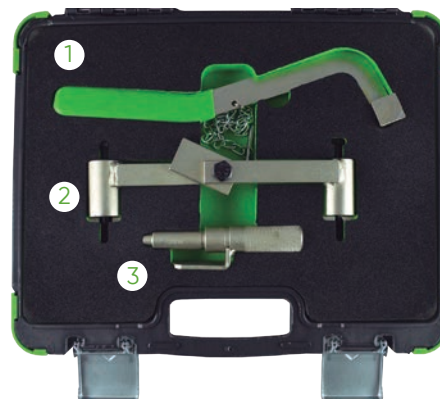

53291

68,00€

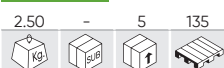

SET DISTRIBUȚIE PE LANȚ RENAULT

MĂRCI	RENAULT: CLIO, LAGUNA, MEGANE
INSTRUMENTE OEM	MOT1496 (1), MOT1489 (2), MOT861/1863 (3), MOT1490(4)
CODURILE DE MOTOR	K4J, K4M, F4P, F4R.

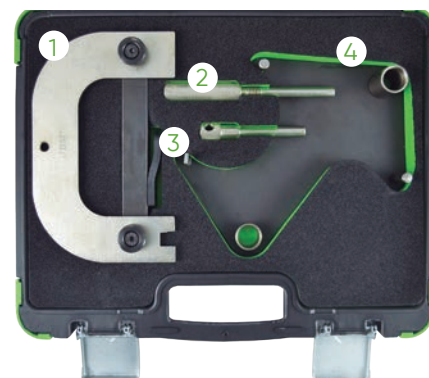

53292

116,00€

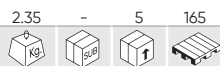

SET DISTRIBUȚIE PE LANȚ RENAULT/OPEL 2.2, 2.5 TDI DCI

MĂRCI	RENAULT: LAGUNA II, ESPACE, MASTER, TRAFIC, 2.2 / 2.5 DCI OPEL: VIVARO, MOVANO, DIESEL: 2.2 / 2.5 DTI, ASTRA B, VECTRA B, SIGNUM, ZAFIRA, 2.2 16V
INSTRUMENTE OEM	KM6205 (1), KM6204 (2), KM6077 (3)
CODURILE DE MOTOR	2.2 / 2.5

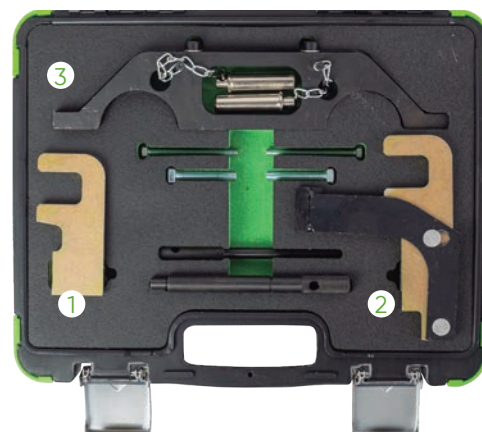

53311

97,00€



SET DISTRIBUȚIE PE LANȚ RENAULT/NISSAN/OPEL/VAUXHALL 2.0, 2.3 DCI, CDTI, M9R, M9T

MĂRCI	NISSAN: PRIMASTAR X83 (06-15), QASHQAI/QASHQAI+2 J10 (07-14), X-TRAIL T31 (07-14). VAUXHALL/OPEL: MOVANO-B (10-17), VIVARO (06-15). RENAULT: ESPACE/GRAND ESPACE IV (06-10), KOLEOS (08-15), LAGUNA LL (05-07), LAGUNA LLL (07-14), MASTER LLL (10-15), MEGANE LL (06-10), SCENIC/GRAND SCENIC LL (06-09), SCENIC/GRAND SCENIC LLL (09-15), TRAFIC LL (06-14), VEL SAVIS (05-10)
INSTRUMENTE OEM	MOT1769 (1), EN-48334 (2), MOT1766 (3), EN-48330 (3), KM-6130 (4), EN-48332 (5), MOT1773 (6), EN-48831 (6)
CODURILE DE MOTOR	2.0D DCI M9R: 630, 780, 782, 784, 786, 788, 830, 832, 833, 834, 835, 836, 838, 855, 856. 2.0D CDTI M9R: 630, 780, 782, 784, 786. 2.3 BI-CDTI: LP6/M9T706, LW7/M9T706. 2.3D DCI M9T: 670, 672, 676, 678, 680, 686, 690, 692, 694, 698.



53523

91,00€



SET PENTRU BLOCAREA MOTOARELOR DIESEL RENAULT / NISSAN/OPEL 1.6 DCI

MĂRCI	RENAULT: ESPACE/GRAND ESPACE IV (06-10), KALEOS (08-11), LAGUNA LL (05-07), LAGUNA LLL (07-12), MASTER LLL (10-12), MAGANE LL (06-10), SCENIC/GRAND SCENIC LL (06-09), SCENIC/GRAND SCENIC LLL (09-12), TRAFIC LL (06-12), VEL SAVIS (05-10) NISSAN: PRIMASTAR X83 (06-10), QASHQAI/QASHQAI+2 J10 (07-10), X-TRAIL T31 (07-12). VAUXHALL / OPEL: MOVANO-B (10-12), VIVARO (06-12).
INSTRUMENTE OEM	MOT1969 (1), MOT1970 (2), MOT1770, MOTT773, EN-48330, EN-48332, EN-48334, EN-48831, KM-6130
CODURILE DE MOTOR	M9R 2.0DCI: 610, 615, 630, 700, 721, 740, 742, 760, 761, 762, 763, 780, 782, 784, 786, 788, 800, 802, 803, 805, 808, 816, 830, 832, 833. M9T 2.3DCI: 670, 672, 676, 678, 680, 686, 690, 692, 694, 698.



54210

84,00€

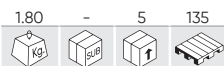

INSTRUMENT DE BLOCARE A PINIONULUI ARBORELUI CU CAME AL MOTORULUI PENTRU RENAULT 1.8, 2.0 16V

MĂRCI	RENAULT LAGUNA II (2001 - 2009), MEGANE II (2002 - 2009), Scenic (2002 - 2009)
INSTRUMENTE OEM	MOT 1509-01 (1), 1509 (2)
CODURILE DE MOTOR	700, 701, 712, 713, 714, 715, 720, 721, 722, 722, 730, 732, 736, 738, 740, 741, 744, 746, 747, 760, 761, 762, 763, 764, 765, 766, 767, 770, 771, 773, 774, 774, 775, 776, 784, 786, 787, 790, 792, 794, 797, 830, F4P, F4R



54225

133,00€

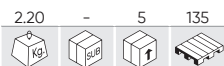

SET DE BLOCARE A VOLANTULUI / SCRIPTELUI ARBORELUI COTIT PENTRU RENAULT/NISSAN

MĂRCI	NISSAN: PRIMASTAR (06-15), QASHQAI/QASHQAI+2 (07-14), X-TRAIL (07-14), NAVARA (15-16), NV400 (11-16) RENAULT: ESPACE V (15-16), CLIO (06-16), FLUENCE (09-15), LAGUNA (05-15), LATITUDE (10-15), MEGANE (06-15), SCENIC/ GRAND SCENIC (06-15), ESPACE/GRAND ESPACE IV (02-15), KOLEOS (08-16), TRAFIC II (07-15), VEL SATIS (00-10), MASTER III (10-16)
INSTRUMENTE OEM	MOT 1431(1), MOT 1716(2), MOT 2019(2), MOT 1789(3), MOT 919-02(4)
CODURILE DE MOTOR	1.4: H4JT700 1.6: M5M400, M5M450 2.0: M4R700, M4R701, M4R704, M4R711, M4R713, M4R714, 2.0D: M9R726, M9R730, M9R735, M4R737, M9R740, M4R746, M9R742, M9R744, M9R746, M9R748, M4R750, M4R751, M4R752, M4R753, M4R754, M9R610, M9R613, M95615, M9R630, M9R750, M9R760, M9R761, M9R762, M9R762, M9R763, M9R700, M9R721, M9R722, M9R724, M9R756, M9R780, M9R782, M9R800, M9R802, M9R803, M9R804, M9R805, M9R806, M9R808, M9R809, M9R811, M9R812, M9R814, M9R815, M9R816, M9R817, M9R820, M9R824, M9R828, M9R830, M9R832, M9R833, M9R834, M9R835, M9R836, M9R838, M9R839, M9R844, M9R845, M9R846, M9R849, M9R854, M9R855, M9R856, M9R857, M9R858, M9R859, M9R865, M9R866, M9R784, M9R786, M9R788 2.3D: M9T670, M9T672, M9T676, M9T678, M9T680, M9T686, M9T690, M9T692, M9T694, M9T696, M9T698, M9T700, M9T702, M9T706, M9T708, M9T870, M9T880, M9T890, M9T896, M9T898, M9TC6, YS23DDT, YS23DDTT 2.5: 2TR700, 2TR702, 2TR703, 2TR704, 2TR705, 2ZV604, V4U604, VQ25 3.5: V4Y701, V4Y711, V4Y713, V4Y715



GASEȘTE UȘOR KITUL TĂU DE DISTRIBUȚIE

- ✓ INTRODUCETI ÎN BROWSERUL WEB CODUL DE SCULE OEM SAU CODUL DE MOTOR AL MAȘINII DUMNEAVOASTRĂ ȘI GĂSIȚI KITUL DE DISTRIBUȚIE COMPATIBIL



54289

38,00€

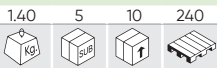

N

SET DE BLOCARE A VOLANULUI DE INERȚIE PENTRU MERCEDES/RENAULT/DACIA/NISSAN

MĂRCI	DACIA DOKER 2015 + DACIA DUSTER 2015+ DACIA LODGY 2015+ DACIA LOGAN 2013/ -2020 DACIA SANDERO 2013+ MERCEDES-BENZ A-CLASS 2018+ MERCEDES-BENZ B-CLASS 2019+ MERCEDES-BENZ CLA 2019+ MERCEDES-BENZ GLA 2019+ MERCEDES-BENZ GLB 2019+ RENAULT ARKANA 2019+ RENAULT CAPTUR 2018+ RENAULT CLIO V 2019 + RENAULT KADJAR 2018+ RENAULT MEGANE IV 2017+ RENAULT SCENIC/GRAND SCENIC IV 2018+ RENAULT TALISMAN 2018+
INSTRUMENTE OEM	MOT.2188 (1)
CODURILE DE MOTOR	HRT3DDT, H4Bt 400, H4Bt 408, H4Bt 410, H4Bt 411, H4M 730, H4M 738, H4M 740, H5H 450, H5H 470, H5H 480, 282.914



54438

40,00€



N

INSTRUMENT DE SINCRONIZARE PENTRU RENAULT/NISSAN 3.0DCI

MĂRCI	NISSAN: NAVARA PICK UP, PATHFINDER, INFITI RENAULT: LAGUNA, LATITUDE
INSTRUMENTE OEM	MOT 1880 (1) MOT 1970 (2) MOT 1874 (3)
CODURILE DE MOTOR	V9X, V9X 791, 891



54439

32,50€

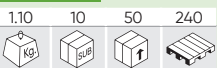

N

DISPOZITIVĂ DE BLOCARE A ROȘII DE TRANSMISIE A ARBORELUI COTIT RENAULT/DACIA 0.9, 1.0, 1.2, 1.6 TCE

MĂRCI	DACIA DOKKER 2012 - 2019, PLUMERO 2013 - 2018, LOGIA 2012 - 2018 RENAULT CAPTURAR 2013 - 2019, CLIO IV 2012 - 2019, KADJAR 2015 - 2018, KANGOO II 2013 - EN, MEGANE III 2012 - 2017, MEGANE IV 2016 - 2020, ESCÉNICO/GRAN ESCÉNICO III 2012 - 2017, ESCÉNICO/GRAN ESCÉNICO IV 2016 - 2018, TWIN-GO III 2014 - EN
INSTRUMENTE OEM	MOT. 2006 (1) MOT. 2054 (1) 281589004000 (1)
CODURILE DE MOTOR	0.9TCE: H4B 453, H4Bt 400, 401, 408, 410, 411, 451. 1.0TCE: H4D, H4D 400, 450, 460, 470 1.2TCE: H5Ft 400, 403, 404, 405, 408, 410, 412. 1.6TCE: H4M 429, 438, 440, 729, 730, 738, 740, 748, 749

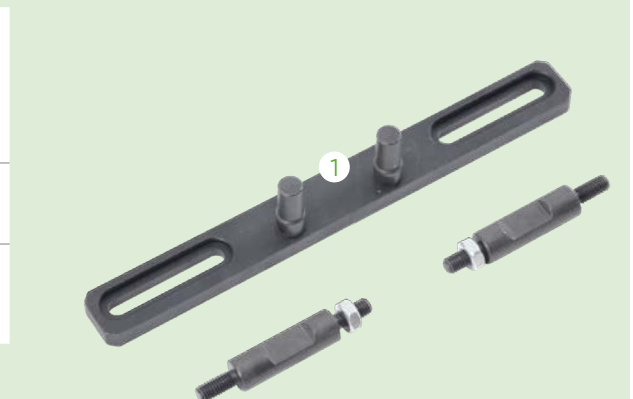

53299

291,00€

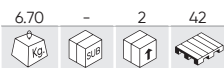

SET DISTRIBUȚIE PE LANȚ OPEL/VAUXHALL

MĂRCI	OPEL / VAUXHALL
INSTRUMENTE OEM	EN-46788 (1), KM927 (2), EN-46789 (3), KM929 (4), EN-46785 (5), EN-46788 (6), 1 860 985 000 (7), KM932 (8), KM933 (9), EN-49978 (10), KM933 (11)
CODURILE DE MOTOR	1.3 CDTI 16V, 1.9 CDTI, 2.0 DTI, 2.2 DTI.



53300

41,00€

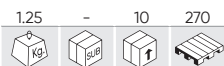

SET DISTRIBUȚIE PE LANȚ OPEL/VAUXHALL/CHEVROLET 2,0CDI

MĂRCI	OPEL VAUXHALL CHEVROLET
INSTRUMENTE OEM	EN-48245 (1), EN-48246 (2), 205083060 (3) (4) (5) (6)
CODURILE DE MOTOR	OPEL / VAUXHALL: Z20DM, Z20DMH CHEVROLET: LLWZ20DMH, RA 420, Z20SI, Z 20S3, Z 20S4, Z 20S5



53301

44,00€



SET DISTRIBUȚIE PE LANȚ SUZUKI/OPEL 1.0, 1.2, 1.4

MĂRCI	SUZUKI: WAGON R (05-08). VAUXHALL / OPEL: AGILA (00-08), ASTRA-G (98-06), ASTRA G CLASSIC II (03-10), ASTRA-H (04-11), COMBO (04-12), CORSA-B (97-00), CORSA-C (00-07), CORSA-D (06-12), MERIVA-A (04-10), TIGRA-B (04-10).
INSTRUMENTE OEM	KM-953/09919-58310 (1), KM-952/09912-38310 (2), KM-954/09919-08310 (3), KM-6130 (4), KM-955/09919-58320 (5)
CODURILE DE MOTOR	1.0 12V: X10XE, Z10XE, Z10XEP. 1.2 16V: X12XE, Z12XE, Z12XEP. 1.4 16V/ECOFLEX: Z14XEL, Z14XEP.

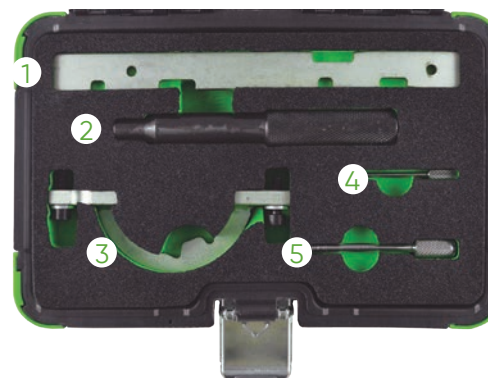

53302

44,00€

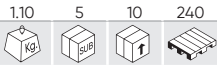

SET DISTRIBUȚIE PE LANȚ FIAT/ALFA ROMEO/VAUXHALL/OPEL/SAAB JTD

MĂRCI	SAAB: 9-3 (04-08), 9-5 (05-08). VAUXHALL / OPEL: ASTRA-H, VECTRA-C, SIGNUM (04-07), ZAFIRA-B (05-07).
INSTRUMENTE OEM	EN46789/32 025 008 (1) (3), EN46788/32 025 009 (2), KM6349 (4)
CODURILE DE MOTOR	Z19DT, Z19DTH, Z19DTL.



53305

136,00€

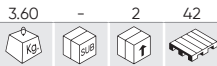

SET DISTRIBUȚIE PE LANȚ SAAB/OPEL/VAUXHALL

MĂRCI	VAUXHALL / OPEL: ANTARA (06-10), CALIBRA (93-98), CAVALIER/VECTRA-A (93-95), OMEGA-B (94-03), SIGNUM (03-05), SINTRA (96-99), VECTRA-B (95-02), VECTRA-C (02-05). SAAB: 900 (93-98), 9000 (95-97), 9-5 (98-03)
INSTRUMENTE OEM	KM-800-1 (1), KM-800-2 (2), KM-800-20 (3), KM-800-10 (4), 83 95 006 (5), KM-800-30 (6), MKM-6038, 83 95 006 (7)
CODURILE DE MOTOR	2.5 V6: SAAB: B2581, VAUXHALL/OPEL: C25XE, X25XE. 2.6 V6: VAUXHALL/OPEL: Y26SE. 3.0 V6: SAAB: B308E, B308I, VAUXHALL / OPEL: X30XE. 3.2 V6: VAUXHALL/OPEL: Y32SE, .



53307

38,50€

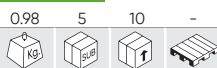

SET DISTRIBUȚIE PE LANȚ ALFA/OPEL/VAUXHALL 1.6, 1.8 16V

MĂRCI	OPEL / VAUXHALL: CORSA-D, AGILA, ASTRA-G-H, MERIVA, ZAFIRA-B, VECTRA-C, SIGNUM, INSIGNA	1.6, 1.8
	CHEVROLET: AVEO, CRUZE, ORLANDO	1.4, 1.6, 1.8
	ALFA ROMEO: 159 FIAT: CROMA	1.8
INSTRUMENTE OEM	E10290 (1), 23056-06 (2) (3), E10230 (4), 23164-04 (5), 23174-01 (6), 23056-05 (7)	
CODURILE DE MOTOR	OPEL / VAUXHALL: Z16LEL, Z16LER, Z16LET, Z16XE1, Z16XEP, Z16XER, A16XER, 18XER, A18XER, 2HO/A18XEL. CHEVROLET: G14D, LDD, LXV (F16D4), 2HO(Z18XER). ALFA / FIAT: 939A4.000.	



53316

34,00€

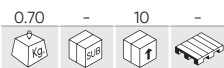

SET DISTRIBUȚIE PE LANȚ FIAT/OPEL/VAUXHALL 2.2 16V LANȚ

MĂRCI	OPEL: ASTRA-G (2000-2006), ASTRA-H (2006-2011), SIGNUM (2003-2008), VECTRA-B (2000-2002, VECTRA-C (2002-2008), ZAFIRA-A (2000-2005), ZAFIRA-B (2005-2012), SPEEDSTER (2000-2006). VAUXHALL: VX220 (2000-2006). FIAT: CROMA (2005-2009).
INSTRUMENTE OEM	VAUXHALL / OPEL: Z22SE, Z22YH FIAT: T94A1.000.



53317

34,00€

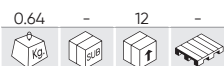

OPEL/VAUXHALL 2.2 ANTIFREEZE PUMP BLOCKER

MĂRCI	OPEL 2.2 Lanț VAUXHALL 2.2 Lanț
-------	------------------------------------



53452

26,50€

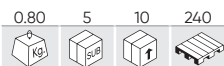

SET DISTRIBUȚIE PE LANȚ OPEL/FORD/FIAT/ ALFA ROMEO/LANCIA/SUZUKI

MĂRCI	VAUXHALL/OPEL 1.3 CDTI: AGILA, CORSA, COMBO (03-08), ASTRA-H(05-08), MERIVA, TIGRA-B(04-08) SUZUKI 1.3 DDIS: IGNIS, WAGON R(03-08), SWIFT(04-08) FORD: 1.3 TDCI FIAT/ALFA ROMEO/LANCIA: 1.3 JTD MULTIJET
INSTRUMENTE OEM	104-A EN 46781 (1) , EN 46785 (2)

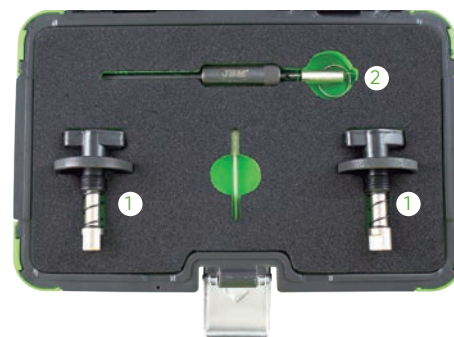

53651

91,00€



SET DISTRIBUȚIE PE LANȚ OPEL/VAUXHALL 1.0, 1.2, 1.4 TURBO

MĂRCI	OPEL: ADAM, AMPERA, ASTRA-J, AVEO, CORSA-D, INSIGNIA, MERIVA-B, MOKKA, ZAFIRA-C TOURER
INSTRUMENTE OEM	EN 49977-100 (1), EN 49977-200 (2), EN 49978 (3), KM 952 (4), KM 953-A (5), KM 955-1 (6), KM 955-2 (7).
CODURILE DE MOTOR	1.0: A10XEP (LDB) 1.2: A12XEL (LWD), A12XER (LDC) 1.4: A14XEL (L2Z), A14XER (LDD), LDU A14NEL (LUH), A14NET (LUJ), TWINPORT / ECOFLEX ENGINES A14XFL (LUU), A14NEL (LDD), A14NEL (LUJ), A12XEL (L2Q)

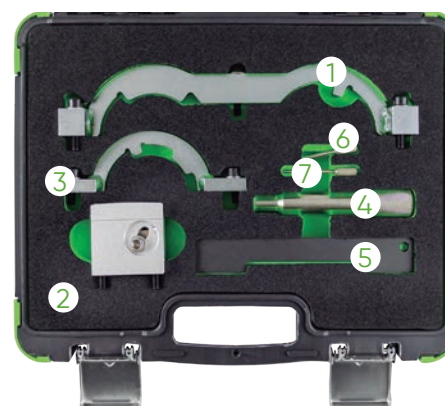

54205

49,00€

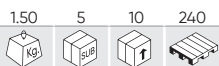

SET INSTRUMENTE DE REGLARE A MOTOARELOR PENTRU VAUXHALL/OPEL 1.6 CDTI

MĂRCI	VAUXHALL/OPEL: Astra J (13-18), Astra K, (15-19), GTC (15-18), Insignia A (15-17), Insignia- B (17-20), Meriva B (13-17), Mokka (14-16), Mokka X (16-20), Zafira C Tourer (13-19).
INSTRUMENTE OEM	EN-6349, EN-6130 (1), EN-51143 (2), EN-51140 (3), EN-50513 (4), EN-51188 (5)
CODURILE DE MOTOR	B16DTC, B16DTE, B16DTH, B16DTJ, B16DTL, B16DTN, B16DTR and B16DTU. D16DTH, D16DTI, D16DTJ, D16DTN, D16DTR, D16DTU



54214

96,00€



KIT DE ȘAIBE PENTRU OPEL/ISUZU 1.6D, 1.7D

MĂRCI	ASTRA, CAVALIES, VECTRA-A(87-00), ISUZU, NOVA, CORSA / COMBO, STRA, CAVALIER, VECTRA, FRONTERA, MONTEREY, MIDI, BRAVA (88-04)
INSTRUMENTE OEM	VAS 6079 (1), KM 951 (2), KM 851 (3), 23-029 (4), KM 661-2 (5), KM 661 (6)
CODURILE DE MOTOR	OPEL : 16DA, 17D, 17DR, X17DTL ISUZU : 4EC1, 4EE1, 4JB1, 4XJ1, 4JA1, 4JG1, 4FC1, 4FD1, 4FG1, Z17DT, Y17DT/DTL

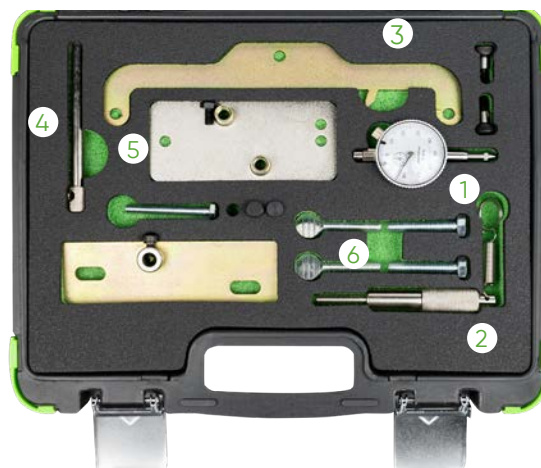

54217

104,00€



SET INSTRUMENTE DE REGLARE A MOTOARELOR PENTRU VAUXHALL/OPEL/SAAB 2.0, 2.2 DTI

MĂRCI	VAUXHALL/OPEL: ASTRA-G (98-06), FRONTERA-B (98-04), OMEGA-B, (98-03), SIGNUM (03-05), SINTRA (98-99), VECTRA-B (97-02), VECTRA-C (02-05), ZAFIRA-A (99-05), SAAB: 9-3 (98-04), 9-5 (02-06)
INSTRUMENTE OEM	SAAB: 83 95 394 (1), 83 95 337 (2), 83 95 352 (3), 83 95 386 (4) VAUXHALL/OPEL/SAAB: KM-927 (2), KM-929 (3), KM-932 (4), KM-933 (1)
CODURILE DE MOTOR	OPEL: X20DTH, X20DTL, Y20DTH, Y20DTL, X22DYH, Y22DTH, Y22DTR SAAB: D223L



54221

111,00€

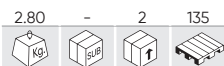

SET INSTRUMENTE DE REGLARE A MOTOARELOR PENTRU VAUXHALL/OPEL 1.3 CDTI

MĂRCI	VAUXHALL/ OPEL 1.3 CDTI Corsa E Diesel Engine From 2015
INSTRUMENTE OEM	KM-662-C (1), EN-50515 (2), EN-51500 (3), EN-46775 (4), KM-955-1 (5), EN-46785 (6)
CODURILE DE MOTOR	LKU B13DTE, LKU B13DTR



54434

48,50€



INSTRUMENT DE SINCRONIZARE PENTRU OPEL 1.0, 1.4

MĂRCI	VAUXHALL/OPEL ADAM 2014 - 2019, ASTRA-K 2015 - 2019, CORSA-E 2015 - 2019, INSIGNIA-B 2017 - 2020, MOKKA X 2016 - 2019, VIVA (KARL) 2015 - 2020
INSTRUMENTE OEM	EN-51367 (1) EN-51298 (2) EN-51632 (3)
CODURILE DE MOTOR	1.0 L5Q/B10XE, L5Q/D10XE, LE1/B10XFL, LE1/B10XFT, LE1/B10XFL, LE1/D10XFL, LE1/D10XFT, LE1/F10XFL, LE1/F10XFT, LWT/B10XL 1.4 LE2/B14XFL, LE2/B14XFT, LE2/D14XFL, LE2/D14XFT, LFE/B14XNT, LFE/D14XNT, LV7/B14XE 1.5 LFV/B15XHT, LFV/D15XHL, LFV/D15XHT



54435

14,50€

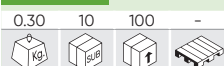

INSTRUMENT DE SINCRONIZARE PENTRU OPEL/CHEVROLET/SAAB 1.4, 1.6, 1.8 ECOTEC

MĂRCI	CHEVROLET: LACETTI (2005-2010), NUBIRA (2005-2010) OPEL/VAUXHALL: ASTRA-G (1998-2004), ASTRA-H (2004-2007), COMBO-C (2005-2012), CORSA-C (2000-2007), MERIVA-A (2003-2010), SIGNUM (2003-2007), TIGRA-B (2004-2010) VECTRA-B (1995-2002), VECTRA-C (2002-2008), ZAFIRA-A (1999-2005), ZAFIRA-B (2006-2013) SAAB: 9-3 (2003-2010)
INSTRUMENTE OEM	KM-911 (1) KM-6130 (2) KM-852 (3), EN-852 (3)
CODURILE DE MOTOR	1.4: X14XE, Z14XE 1.6: X16SEJ, X16XEL, Y16XE, Z16XE, Z16YNG 1.8: F18D3 1.8: X18XE1, Z18XE, Z18XEL, X18E1 1.8: Z18XE

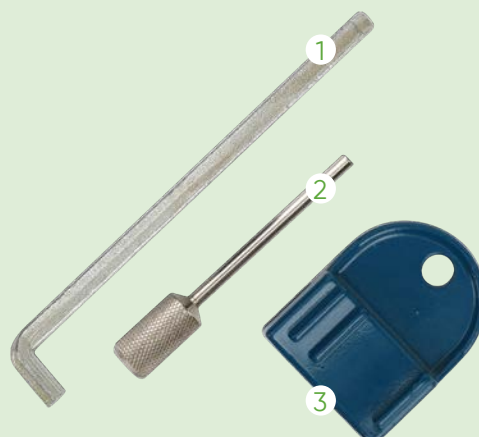

54436

124,00€



N

INSTRUMENT DE SINCRONIZARE PENTRU OPEL 1.6 SIDI

MĂRCI	VAUXHALL ASTRA-J 2013 - 2017,ASTRA-K 2015 - 2019,CASCADE 2013 - 2019,GTC 2015 - 2019,INSIGNIA 2013 - 2017,INSIGNIA-B 2018 - 2020,ZAFIRA-C TOURER 2014 - 2019
INSTRUMENTE OEM	EN 51153 (1) EN 50513 (2) EN 51148 (3) EN 51147 (4)
CODURILE DE MOTOR	1,6 LWC/A16SHT LVP/A16XHT LWC/B16SHL LWC/B16SHT LVP/B16XHT LWC/D16SHJ LWC/D16SHL LWC/D16SHT

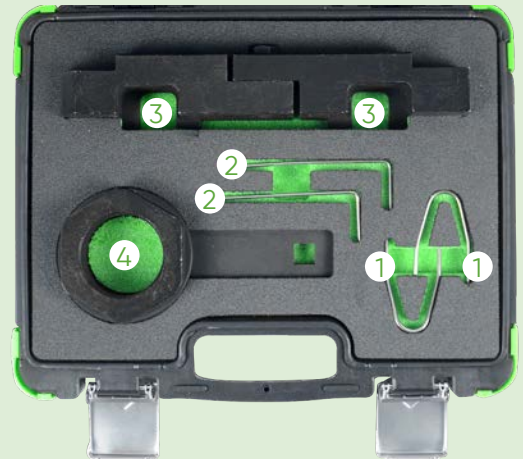

54437

110,00€

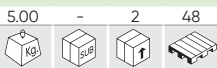

N

INSTRUMENT DE SINCRONIZARE PENTRU OPEL/CHEVROLET/SAAB 2.0, 2.4

MĂRCI	CHEVROLET CAPTIVA 2011 - 2015,HHR 2008 - 2009, MALIBU 2012 - 2015 SAAB 9-3 (02-12) 2010 - 2012,9-5 (10-12) 2010 - 2012 VAUXHALL/OPEL ANTARA 2011 - 2016,ASTRA-J 2012 - 2017,GTC (15-19) 2015 - 2019,INSIGNIA-A (08-17) 2008 - 2013
INSTRUMENTE OEM	EN-48585 (1) EN 43653 (2), J 43653 (2) EN 955 10 (3), KM 955 (3) EN-955-20 (4), KM 955-20 (4) EN 45027 1 (5), J 45027 1 (5) EN 45027 (6), EN45027 2 (6), J 45027 2 (6) EN 49212 (7), EN 49212 1 (7) EN 49212 (8), EN 49212 2 (8) EN 48953 (9)
CODURILE DE MOTOR	LHU/A20NFT 2.0: LDK/A20NHT 2.0: LDK/A20NHT, LHU/A20NET, LHU/A20NFT, LHU/B20NFT 2.4: A24XE (LE5), A24XF (LE9) 2.4: LE5,LE9

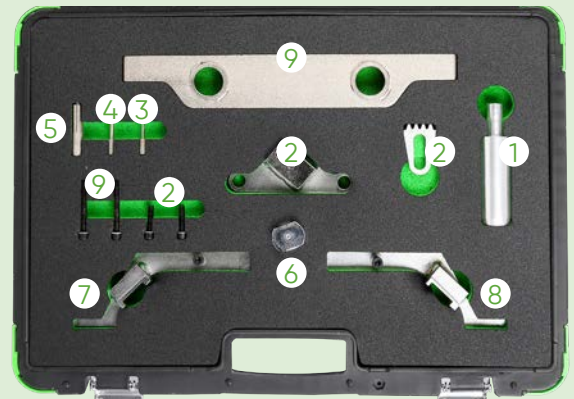

52271

18,00€

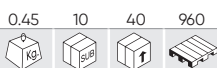

SET BLOCAJ DISTRIBUȚIE VAG

MĂRCI	AUDI: A2 1.4TDI (02-06), A3 1.9 2.0TDI (02-08), A4 1.6TDI (02-05), A4 1.9 2.0TDI (04-08), A6 1.9TDI (02-05). SEAT: ALTEA 1.9SDI/TDI (05-08), LEON 1.9.0TDI (05-08), TOLEDO 1.9SDI/TDI (05-08). SKODA: FABIA 1.4TDI (03-06), OCTAVIA II 2.0TDI (03-06) VW: BEETLE 1.9TDI (02-08), BORA 1.9TDI (02-08), FOX 1.4TDI (02-08), GOLF 1.9 2.0TDI (02-08), LUPO 1.4TDI (02-08), POLO 1.4, 1.9TDI (02-08), SHARAN 1.9TDI (02-08).
INSTRUMENTE OEM	AUDI: AMF, ASZ, ATD, AVB, AVF, AWW, AXR, AZV, BHC, BKC, BKD, BKE, BLB, BMN, BNA, BPW, BRB, BR, BRD, BRE, BRF, BUY, BVA, BVF, BVG. SEAT: BJB, BKC, BLS, BMM, BXE SKODA: AMF, AZV, BKD VW: AJM, AMF, ANU, ARL, ASZ, ATD, AUJ, AVB, AVF, AWW, AXR, BAY, BMS, BNM, BNV, BWB



51489

12,00€

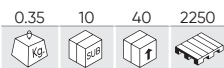

DISPOZITIV BLOCARE DISTRIBUȚIE VAG 1.4, 1.6

MĂRCI	<u>VW</u> : LUPO 99 , POLO 95, CADDY 96, POLO CLASSIC, VARIANT 96, BEETLE 1.4L 99, GOLF 1.4L, 1.6L 98 Y 1.4L, BORA, 1.6L 99. <u>AUDI</u> : A2.
INSTRUMENTE OEM	T10016
CODURILE DE MOTOR	1.4 / 1.6 16V



53274

30,50€

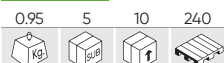

SET DISTRIBUȚIE PE LANȚ VOLKSWAGEN/SEAT/SKODA 1,2L

MĂRCI	<u>VOLKSWAGEN</u> 1.2: LUPO / POLO / EOS / FOX. <u>SEAT</u> 1.2: IBIZA / CORDOBA <u>SKODA</u> 1.2: FABIA
INSTRUMENTE OEM	T10123 (1) (2), T10120 (3), T10121 (4)
CODURILE DE MOTOR	AWY / BMD / AZQ / BME.



53275

35,50€

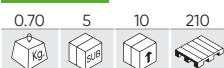

SET DISTRIBUȚIE PE LANȚ VW-AUDI

MĂRCI	<u>DODGE</u> : CALIBER (06-11) <u>FORD</u> : GALAXY (02-06) <u>MITSUBISHI</u> : GRANDIS (05-10), LANCER (05-10), OUTLANDER (07-10). <u>SEAT</u> : ALHAMBRA (00-15), ALTEA/ALTEA XL (04-15), CORDOBA (02-09), IBIZA (02-15), LEON (00-13), TOLEDO (04-11). <u>SKODA</u> : FABIA (00-14), FABIA II (07-15), OCTAVIA (00-10), OCTAVIA II (04-15), PRACTIK (10-15), RAPID (11-15), ROOMSTER (07-15), SUPERB (02-08), SUPERB II (08-15), YETI (09-14). <u>AUDI</u> : A1 (10-15), A2 (00-06), A3 (01-13), A4/ALLROAD (01-16), A5 (08-15), A6 (11-14), TT (08-14), Q3 (11-15), Q5 (08-15), A6 (10-14). <u>VOLKSWAGEN</u> : AMAROK (10-16), BEETLE (02-15), BORA (02-08), CADDY/MAXI (03-15), EOS (06-15), FOX (05-11), GOLF (02-15), GOLF PLUS (05-14), JETTA (05-15), LUPO (02-05), PASSAT/CC (02-15), POLO (99-14), SCIROCCO (08-14), SHARAN (02-15), TIGUAN (07-15), TOURAN (03-15), TRANSPORTER (03-17).
INSTRUMENTE OEM	<u>DODGE</u> : 9882, 9883. <u>FORD</u> : 310-085/23-059, 303-1054. <u>MITSUBISHI</u> : MB995206, MB995208, MB995209. <u>VAG</u> : T10100 (4), T10050 (1), 3359 (3/6)/T20102, T10115 (3), T10060A (2)/T40098, T20167.
CODURILE DE MOTOR	1.2D TDi CR: CFWA. 1.4D TDi PD: AMF, BAY, BMS, BNM, BNV, BWB. 1.6D TDi CR: CAYA, CAYB, CAYC, CAYD, CAYE, CLNA. 1.9D TDi PD: AJM, ANU, ARL, ASZ, ATD, AUY, AVB, AVF, AVQ, AWX, AXB, AXC, AXR, BJB, BKC, BLS, BLT, BMT, BPZ, BRM, BRR, BRS, BRU, BSU, BSV, BSW, BTB, BVK, BXE, BXF, BXJ. 2.0D TDi CR/TDi PD: AZV, BDJ, BDK, BEW, BGW, BHW, BKD, BKP, BKQ, BLB, BMA, BMM, BMN, BMP, BMR, BNA, BPW, BRA, BRC, BRD, BRE, BRF, BRT, BSS, BST, BSY, BUY, BUZ, BVA, BVE, BVF, BVG, BVH, BWC, BWV, CAAA, CAAB, CAAC, CAAD, CAAE, CAGA, CAGB, CAGC, CAHA, CAHB, CBAA, CBAB, CBAC, CBBA, CBBC, CBDA, CBDB, CBDC, CBEA, CCHA, CCHB, CDBA, CDCA, CEGB, CFCA, CFFA, CFFB, CFFD, CFFE, CFGB, CFGC, CFHA, CFHB, CFHC, CFHD, CFHE, CFHF, CFJA, CGLA, CGLB, CGLC, CGLD, CJAA, CJCA, CJC, CJCC, CLCA, CLCB, CLJA, CLLA, CNEA, ECD, ECD/BSY, ECD/BYL, ECE/BWD.

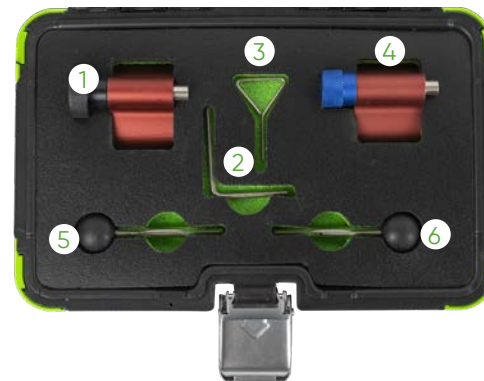

53276

160,00€

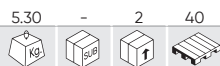

SET DISTRIBUȚIE PE LANȚ AUDI SKODA

MĂRCI	MOTOR AUDI VW: V6 2.0, 2.8, 3.0T FSI. AUDI Q5: 2.0, A6L 2.8, 3.0T.
INSTRUMENTE OEM	3418 (1), 3458 (2), T10100 (3), T10123 (4), T10121 (5), 3242 (6), 3551 (8), T10020 (9), T10098 (10), 3078 (12), 2064 (13), 3369 (14), T10092 (15), T40011 (17), 2065A (18), T10016 (19), 3359 (20), T10008 (21), T10050 (22) T10265 (23), T10264 (24), T10060A (25), T10120 (27), 3366 (28)
CODURILE DE MOTOR	2.0, 2.8, 3.0

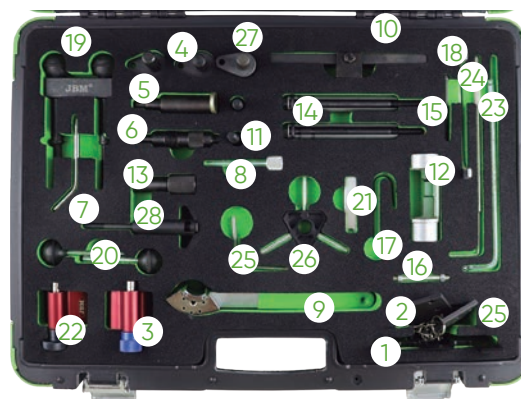

53277

45,00€

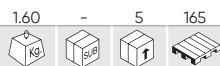

SET DE UNELTE PENTRU CUREA DE DISTRIBUȚIE VW-AUDI

MĂRCI	BENZINĂ	AUDI: 80, 100, A3, A4, A6 1.6, 1.8/TURBO, 2.0, 2.0 16V, A3, A4 1.6 (96-). SEAT: IBIZA/CORDOBA, TOLEDO, ALHAMBRA, INCA 1.6, 1.8, 1.8 16V, 2.0, 2.0 16V, IBIZA/ CORDOBA, LEON, TOLEDO 1.6 (99-), ALHAMBRA 2.0 (00-). VOLKSWAGEN: POLO CLASSIC, SCIROCCO, CORRADO, GOLF, JETTA, VENTO, PASSAT, SHARAN, TRANSPORTER 1.6, 1.8/TURBO, 1.8 16V, 2.0, 2.0 16V, POLO CLASSIC, GOLF, BORA, BEETLE 1.6 (97-), 2.0 (99-). SKODA: OCTAVIA 1.6 (97-), 2.0 (99-).
	DIESEL	AUDI: 80, 100, A3, A4, A6 1.9 TURBO D, 1.9TDI, 2.5TDI, A3, A4, A6 2.0TDI, A2, A3, A4, A6 1.2TDI, 1.4TDI, 1.9TDI (99-). SEAT: IBIZA/CORDOBA, LEON, TOLEDO, ALHAMBRA, INCA 1.7SDI, 1.9D/TD /SDI/TDI. FORD: GALAXY (02-06). SKODA: FELICIA, OCTAVIA 1.9D/TDI. VW: POLO, POLO CLASSIC, GOLF, JETTA, VENTO, BORA, BEETLE, PASSAT, SHARAN, CADDY, TRANSPORTER 1.5D, 1.6D/ TURBO, 1.7D/SDI, 1.9SDI/TDI, GOLF, PASSAT 2.0TDI.
INSTRUMENTE OEM	T10020 (1), 3387 (2), V159 (3), T10060/T100604 (4), T10115 (5), T40011 (6)	
CODURILE DE MOTOR	2.0, 2.8, 3.0	



53278

143,00€



SET DISTRIBUȚIE PE LANȚ AUDI 2.8, 3.2 FSI, 3.0 TFSI

MĂRCI	A2, A4, A4 QUATTRO, A6 (2004-2007) A2, A3, A4, A3 FSI (2004-2007) A4, A6, A8 3.2 FSI A6 L QUATTRO 2.4 A6 2.4, A6 2.4 QUATTRO (2004-2007) A4 3.2 FSI (2004-2007) A6 3.2 FSI (2004-2007) A8 3.2 FSI (2005-2007)
INSTRUMENTE OEM	T10172 (1), 3212 (2), T40070 (3), T40069 (4), T40071 (5), T10172/2 (6)
CODURILE DE MOTOR	AUK / BDW / BDX / BKH / CAJA / CALA



53279

97,00€

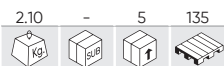

SET DISTRIBUȚIE PE LANȚ VW/AUDI 1.8, 2.0, TSI, TFSI

MĂRCI	AUDI: A3 (96-09), A4 (94-09), A6 (95-11), S3 (99-13), TT (98-14). SEAT: ALHAMBRA (97-10), ALTEA/ALTEA XL (06-09), CORDOBA (99-02), EXEO (09-10), IBIZA (99-02), LEON (99-13), TOLEDO (99-09). SKODA: OCTAVIA/OCTAVIA TOUR (98-10), OCTAVIA II (04-09). VOLKSWAGEN: BEETLE (99-11), BORA (97-04), EOS (06-10), GOLF (97-12), GOLF PLUS (05-09), JETTA (05-09), PASSAT (96-10), SCIROCCO (09-14), SHARAN (97-10), TOURAN (03-09).
INSTRUMENTE OEM	T10020 (1), T10252 (2), T10092 (3), T10115 (4), T40011 (4), 3366 (5), T10060 (6)
CODURILE DE MOTOR	1.8: ADR, AFY, AGN, AJP, APG, APT, AQE, ARG, ARH, AVV. 1.8T: AEB, AGU, AJH, AJL, AJQ, AMK, AMU, ANB, APP, APU, APX, APY, AQA, AQX, ARX, ARY, ARZ, AUM, AUQ, AVC, AWC, AWT, AWU, AYP, BAM, BFV, BVP, BVR. 2.0 FSI: AXW, BHD, BLR, BLX, BLY, BMB, BVX, BVI, BVZ. 2.0 TFSI/S/R/TSI: AXX, BPI, BWA, BGB, BPG, BPJ, BUL, BWE, BWT, BYK, BHZ, BZC, BWJ, BYD, CDLA, CDLB, CDLC, CDLD, CDLF, CDMA.



53280

112,00€

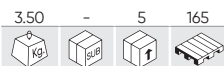

SET ALINIERE PT ARBORELE CU CAME VW/AUDI 3.0 V6

MĂRCI	AUDI: A4 (01-08), A6 (01-08), A8 (03-10).
INSTRUMENTE OEM	3387 (1), T40030 (2) (4), T40026 (3), T40028 (5)
CODURILE DE MOTOR	3.0 V6 30V: ASN, AVK, BBJ, BGN.



53281

55,00€



SET ALINIERE PT ARBORELE CU CAME VW/AUDI

MĂRCI	VOLKSWAGEN: 2.5 TDi V6 AUDI: A4, A6, A8
INSTRUMENTE OEM	3369 (1), 3242 (2), 3458 (3)
CODURILE DE MOTOR	AFB/AKN



53282

48,00€

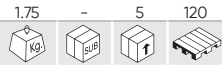

SET DE TURNARE VAG GRUP 1.2, 1.4, 1.6

MĂRCI	SEAT: ALHAMBRA (10-15), ALTEA/ALTEA XL (08-15), IBIZA/CORDOBA (08-12), LEON (07-13), TOLEDO (07-15). VOLKSWAGEN: BEETLE (11-15), CADDY/CADDY MAXI (10-15), EOS (06-12), GOLF (03-12), GOLF PLUS (03-14), GOLF V ESTATE (07-13), GOLF VI CABRIOLET (10-15), JETTA (06-14), PASSAT (05-11), POLO (02-14), SCIROCCO (08-12), TIGUAN (07-12), TOURAN (03-15). SKODA: FABIA II (07-15), OCTAVIA II (04-15), PRAKTIK (10-15), RAPID (12-15), ROOMSTER (06-15), SUPERB II (09-14), YETI (09-14). AUDI: A1 (10-15), A3 (03-13).
INSTRUMENTE OEM	T10171 (1), T10170 (2), T40011 (3)
CODURILE DE MOTOR	1.2 TFSI: CBZA, CBZB, CBZC. 1.4 FSI: AXU, BKG, BLN. 1.4 TFSI: BLG, BMY, BWK, CAVA, CAVB, CAVC, CAVD, CAVE, CAVF, CAXA, CAXC, CDGA, CSMA. 1.6 FSI: BAG, BLF, BLP, BTS.



53283

92,00€

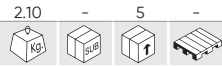

KIT DE ȘTANȚARE GRUP VAG 2.7, 3.0 TDI

MĂRCI	VOLKSWAGEN: TOUAREG, PHATEON VAG: DIESEL 2.7 / 3.0 V6 AUDI: A4, A5, A6
INSTRUMENTE OEM	3242 (1), T40060 (2) (3), 3359 (4), T40058 (5), T40061 (6), T40062 (7), T40049 (8)
CODURILE DE MOTOR	ASB, BKN, BKS, BWZ, BNG, BPP, BSG, BUG, BUN, CAWA, CAMB, CANA, CANB, CANC, CAND, CAPA, CARA, CARS, CASA, CASE, CASC, CAM, CC/HA, CCWA, CCWB, CDYA, CDVB, CDVC, CEXA, CGKA, CGKB.

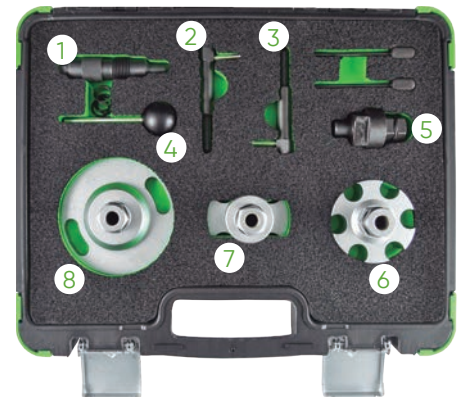

53284

306,00€

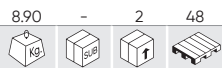

KIT DE FRETARE GRUP VAG 2.5 TDI

MĂRCI	VOLKSWAGEN: TOUAREG (03-10), TRANSPORTER (03-09).
INSTRUMENTE OEM	T10225 (1), T10199 (2), T10234 (3), T10226 (4), T10193 (5), T10194 (6), T10199/01 (7), T10226 (8)
CODURILE DE MOTOR	2.5D TDI PD: AXD, AXE, BAC, BLJ, BLK, BNZ, BPC, BPD, BPE.

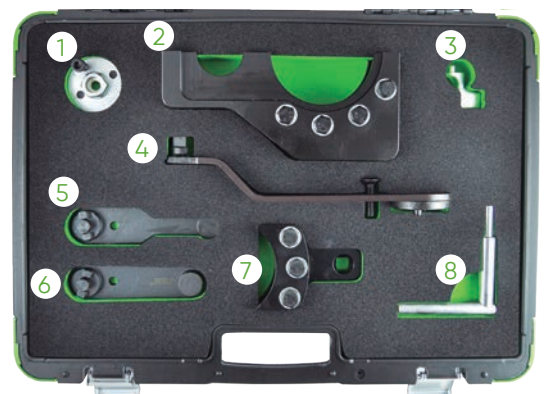

53285

56,00€

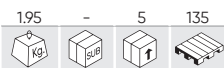

SET DISTRIBUȚIE PE LANȚ VAG 2.4, 2.5, SDI, TDI

MĂRCI	VOLKSWAGEN: CRAFTER (06-13), LT (96-06), TRANSPORTER (90-03).
INSTRUMENTE OEM	2065A (1), T50009 (2), T10025 (3), 3248/3419 (4), 2064 (5), 3355 (6)
CODURILE DE MOTOR	2.4D: AAB, AJA. 2.5D SDI: AGX. 2.5D TDI: ACV, AHD, AHY, AJT, ANJ, APA, AUF, AVR, AXG, AXL, AYC, AYY, BBE, BBF. 2.5D TDI CR: BJJ, BJK, BJL, BJM.



53286

87,00€



SET DISTRIBUȚIE PE LANȚ VAG 1.8, 2.0 TSI, TFSI

MĂRCI	VOLKSWAGEN: 1.8 / 2.0 TSI / TFSI.
INSTRUMENTE OEM	T10368 (2), T10354 (3), T40271 (1)(4), T10352/2 (5), T10352/1 (6), T10352 (7), T40196 (8) (9) (10) (11), T40267(12) (13), T40098 (14), T10060A (15), T40011 (15)
CODURILE DE MOTOR	BYT, BZB, CABA, CABB, CABD, CADA, CAEA, CAEB, CAWA, CAWB, CBFA, CCTA, CCZA, CCZB, CCZC, CDA, CDAB, CDHA, CDHB, CDNB, CDNC, CDND, CESA, CETA, CFKA, CGYA, CJEB, CJBA, CJSB.

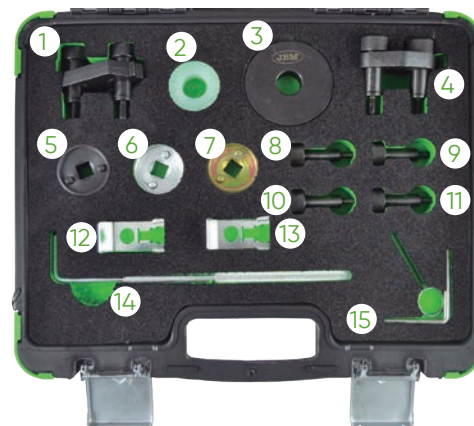

53287

245,00€



SET DISTRIBUȚIE PE LANȚ VW/AUDI 1.8, 2.0L TURBO

MĂRCI	VOLKSWAGEN AUDI	1.8 / 2.0 TURBO
INSTRUMENTE OEM	T10355 (1), T40196 (2), T40271 (3) (4), T10352 (5), T10352/1 (6), T10352/2 (7), T10368 (7), T40267 (8), T10354 (9), T40265 (10), T40011 (11) (14), T40098 (12), T10060A (13)	
CODURILE DE MOTOR	BYT, BZB, CABB, CABD, CADA, CAEA, CAEB, CAWA, CAWB, CBFA, CCTA, CCZA, CCZB, CCZC, CDA, CDAB, CDHB, CDNB, CDNC, CDND, CESA, CETA, CFKA, CGYA, CJEB, CJSB.	

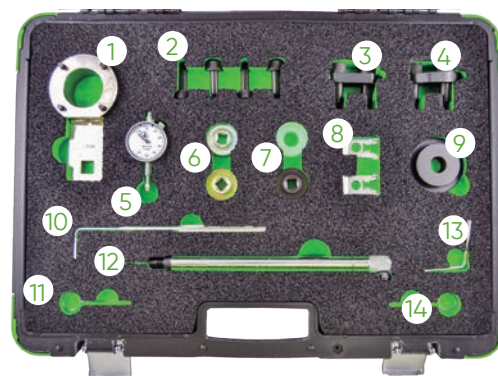

53288

72,00€

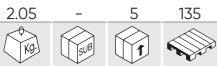

SET DISTRIBUȚIE PE LANȚ VAG VAG 1.6, 2.0 TDI COMMON RAIL

MĂRCI	SEAT: EXEO, LEON, ALTEA, TOLEDO, IBIZA. VOLKSWAGEN: JETTA, TOURAN, GOLF, GOLF PLUS, POLO, PASSAT, TIGUAN, SCIROCCO. SKODA: ROOMSTER, FABIA, PRAKTIK, OCTAVIA, YETI, SUPERB. AUDI: A1, A3, A4, A5, Q5, A6, TT.
INSTRUMENTE OEM	T10264 (1), T10265 (2), T20102 (3), T10052 (4), T10051 (5), T10255 (6), T10050 (7), T10100 (8), T40098 (9)
CODURILE DE MOTOR	1.2 TDI CR, 1.6 D TDI CR, 2.0 D TDI CR CAGA, CAGB, CAGC, CAHA, CAHB, CFHC, CBAA, CBAB, CFFB, CGLA, CGLB, CJCA, CJCB, CAAA, CBAA, CBAB, CBAC, CBBA, CBBB, CBDA, CBDB, CBDC, CCHA, CEGA, CJAA, CAAB, CAAC, CFJA, CFWA, CAYB, CAYC, CAYA.



53320

12,00€

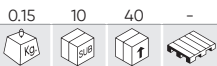

UNEALTĂ DE BLOCAJ PT ARBORELE CU CAME GRUP VAG

MĂRCI	SEAT: ALHAMBRA, ALTEA, AROSA, CORDOBA, IBIZA, LEON, TOLEDO 1.4/1.9/2.0 TDI. VW: PASSAT 1.9. AUDI: A4/A6 1.9.
INSTRUMENTE OEM	T10008, T20102, T10100.



53321

10,50€

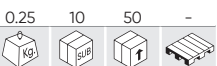

UNEALTĂ PT REGLAREA TENSIUNII CURELEI VAG

MĂRCI	AUDI: A4/1.8T, 2.0 1999-2004 A6/1.8T 2002-2004 A4/3.0 (2002 -), A6/3.0 (2002 -), A8/7.0 (2003 -). VW: GOLF PASSAT 2.0 TDI DIESEL, GOLF 88-97, PASSAT 92-97, VW T4/2.0 1992-2004.
INSTRUMENTE OEM	T10020



53325

7,50€



UNEALTĂ DE SINCRONIZARE A FULIILOR VW AUDI 35MM

MĂRCI	AUDI: 100 ('91-), A6 (2.5 TDI) 2.3, 2.4, 2.5, 2.8, 2.9D TDI (1991-2003) VW: LT, TRANSPORTER
INSTRUMENTE OEM	3355
CODURILE DE MOTOR	AAB, AAT, ACU, ACV, AEL, AET, AGX, AHG, AHY, AJA, AJT, ANJ, APA, APL, AUF, AVT, AXG, AXL, AYC.



53326

16,00€

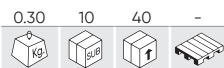

SET DISTRIBUȚIE PE LANȚ VW/AUDI

MĂRCI	VW: V6 2.5TDi. AUDI: V6 2.5TDi, V8 3.3TDi.
INSTRUMENTE OEM	3458 (1), 3242 (2)



53327

11,00€

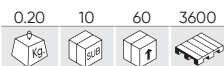

SET DISTRIBUȚIE PE LANȚ VAG 1.2

MĂRCI	SEAT: IBIZA 1.2 6V/3CYL (2002-09), CORDOBA 1.2 12V/3CYL (2002-13). VW: POLO 1.2 6V-12V/3CYL (2002-14). SKODA: FABIA 1.2 6V-12V/3CYL (2002, 2003-), FABIA II 1.2 6V/3CYL (2007-13), ROOMSTER 1.2 12V/3CYL (2006-13), PRAKTIK 1.2 6V/3CYL (2007-13).
INSTRUMENTE OEM	T10123
CODURILE DE MOTOR	1.2 6V: AWY, BMD, BBM, CHFA, CHFB 1.2 12V: AZQ, BME, BXV, BZG, CEVA, CGPA, CGPB, CGPC.



53648

107,00€



SET FIXARE DISTRIBUȚIE PENTRU VAG 1.0, 1.2, 1.4 TSI

MĂRCI	AUDI: A1 (12-15), A1 SPORTBACK (12-15), A3 (13-15), A3 SPORTBACK (12-15). SEAT: IBIZA (12-15), LEON (12-15), TOLEDO (12-15). SKODA: FABIA (10-13), OCTAVIA II (10-13), OCTAVIA III (10-15).
INSTRUMENTE OEM	T10060A (1), T10340 (2), T10476 (3), T10494 (4), T10499 (5), T10504/1 (6), T10504 (7), T10504/2 (8).
CODURILE DE MOTOR	1.2 TSI: CJZA, CJZB. 1.4 TSI: CGGA, CHPA, CMBA, CPVA, CRJA, CXSA. 1.4 TSI ACT: CPTA.



53649

89,00€



SET DE SCULE PENTRU SINCRONIZAREA MOTORULUI VAG GROUP

MĂRCI	AUDI SEAT	SKODA VW
INSTRUMENTE OEM	T10340 (1), T10476 (2), T10477 (3), T10487 (4), T10494 (5), T10499 (6)	
CODURILE DE MOTOR	1.0 MPI; CHYA. 1.0 TSI: CHZE, CHZC, CHZA, CHZB, CHZC, CHZD, CHZJ. 1.2 TSI: CJZB, CJZC, CYVA, CJZA, CJZD, CYVB. 1.4 TSI: CZCC, CMBA, CZCA, CHPA, CPTA (ACT), CZDA, CVNA, CZEA (ACT).	



53706

98,00€



KIT DE INSTRUMENTE DE ALINIARE A ARBORELUI CU CAME VAG 1.4, 1.6, 2.0 TDI COMMON RAIL

MĂRCI	VOLKSWAGEN: GOLF ALLTRACK, GOLF SPORTSVAN, GOLF VII, GOLF VII KOMBI, PASSAT, POLO. AUDI: A1, A1 SPORTBACK, A3, A3 CABRIOLET, A3 LIMOUSINE, A3 SPORTBACK, TT, TT ROADSTER. SEAT: IBIZA, IBIZA V SPORTCOUPE, IBIZA V ST, LEON, LEON SC, LEON ST, TOLEDO IV. SKODA: FABIA, FABIA KOMBI, OCTAVIA, OCTAVIA COMBI, RAPID, RAPID SPACEBACK.
INSTRUMENTE OEM	OEM 3204 (1), OEM 3359 (2), OEM T10490 (3), OEM T10051 (4), OEM T10060A (5), OEM T10264 (6), OEM T10265 (7), OEM T10492 (8), OEM T40098 (9).
CODURILE DE MOTOR	1.4, 1.6, 2.0 TDI CR CXXB, DBKA, DCXA, GGLE, CKFB, CKFC, CLHA, CLHB, CNHA, CNHC, CRBD, CRFA, CRFC, CRKA, CRKB, CRLB, CRLC, CRMB, CRUA, CRVA, CRVC, CSUA, CSUB, CUNA, CUPA, CUSA, CUSB, CUTA, CUUD, CXEB, DBKA, DCXA, DCZA, DFSD.

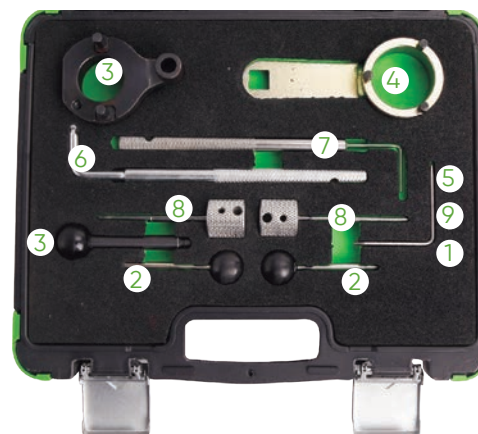

54092

24,00€



SET DE CONTROL ȘI REGLARE FAZA DE DISTRIBUȚIE GAZE PENTRU MOTOR 1.2 TFSI PRODUCĂTOR VAG

MĂRCI	AUDI: A1, A3, A3 SPORTBACK, A3 CABRIO SEAT: ALTEA, ALTEA XL, IBIZA, LEON, TOLEDO SKODA: FABIA II, OKTAVIA II, PRAKTIK, RAPID, RAPID SPACEBACK, ROMMSTER, YETI VW: BEETLE, CADDY, CADDY MAXI, GOLF PLUS, GOLF VI, GOLF VI CABRIO, GOLF VI ESTATA, JETTA, POLO, TOURAN
INSTRUMENTE OEM	T10340(1), T10414(2), T10341(3)
CODURILE DE MOTOR	CBZA, CBZB, CBZC



54199

94,00€

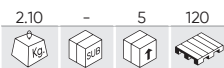

SET INSTRUMENTE DE REGLARE A MOTOARELOR PENTRU VAG TFSI, FSI

MĂRCI	AUDI: A1 (10-15), A1 SPORTBACK (10-15), A3 CABRIOLET (10-13), A3 (10-15), A3 SPORTBACK (03-13) SEAT: ALTEA/ALTEA XL (10-15), IBIZA (10-15), LEON (10-13), TOLEDO (12-15) SKODA: FABIA II (10-15), PRAKTIK (10-15), RAPID (12-15), RAPID SPORTBACK (12-15), OCTAVIA II (04-13), YETI (09-15), YETI OUT-DOOR (13-15) VW: BEETLE (11-15), CADDY/CADDY MAXI (10-15), EOS (07-15), GOLF V (03-13), GOLF V ESTATE (07-09), GOLF VI (10-13), GOLF VI ESTATE (10-13), GOLF VI CABRIOLET (11-15), GOLF PLUS (05-14), JETTA (05-14), PASSAT (05-15), POLO (09-14), SCIROCCO (08-14), TIGUAN (07-15), TOURAN (03-15)
INSTRUMENTE OEM	T10414 (1), VAS 6079 (2), T10170 (3), T10171/ T10171A (4), T40011 (5), T10340 (6), T10341 (7)
CODURILE DE MOTOR	1.2 TFSI: CBZA, CBZB, CBZC 1.4 TFSI/TFSI: BLG, BMY, BWK, CAVA, CAVB, CAVC, CAVD, CAVE, CAVF, CAXA, CAXC, CDGA, CSMA 1.6 FSI: BAG, BLF, BLP



54218

142,00€

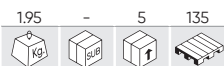

INSTRUMENT DE ASAMBLARE A AMORTIZORULUI DE VIBRAȚIE VAG

MĂRCI	AUDI, SEAT, SKODA, VOLKSWAGEN
INSTRUMENTE OEM	T10531/1 (1), T10531/2 (2), T10531/3 (3), T10531/4 (4)
CODURILE DE MOTOR	1.8L TFSI: BZB, CDA, BPU, BYT, CABA, CABB, CDHA, CDHB, CABD, DAJB, CJS, CJSB, CJEB, CJEE, CJED, CYGA, CDAC, CJS, CGYA, DAJA 2.0L TFSI: CAWB, CCZA, CBFA, CCTA, CDNB, CDNC, CDND, CJXA, CJXE, CJXH, CHIB, CHHA, CULA, CFKA, DEDA, CHJA, CAWA, CCZC, CCZD, CPSA, CJK, CESA, CETA, CFPA, CNCD, CPLA, CYRB, CYRC; CNCE, CYNB, CYP, CULB, CULC, CNCB, CWZA, CJXF, CJXC, CJXB, CJXG, CHHC, CCZB

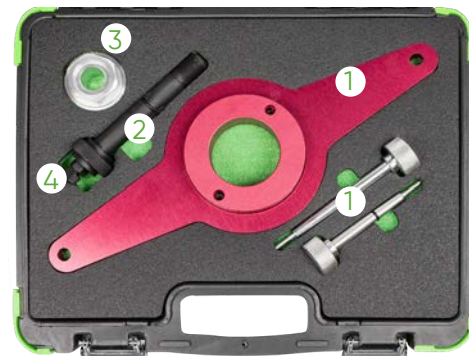

54407

397,00€



SET DE SCULE PENTRU ASAMBLAREA ARBORELUI CU CAME PENTRU VAG/PORSCHE

MĂRCI	AUDI, PORSCHE, SEAT, SKODA, VOLKSWAGEN 1.2 - 1.6 - 2.0 - 2.7 - 3.0 - 4.0 - 4.2 COMMON RAIL
INSTRUMENTE OEM	T40094, T40094/1 (1), T40094/2 (2), T40094/3 (3), T40094/4 (4), T40094/5 (5), T40094/6 (6), T40094/7 (7), T40094/8 (8), T40094/9 (9), T40094/10 (10), T40094/11 (11), T40094/12 (12), T40095 (13), T40096 (14), T40096/1 (15)
CODURILE DE MOTOR	ASB, ASE, BKN, BKS, BMK, BNG, BPP, BSG, BTR, BUG, BUN, BVN, CAAA, CAAB, CAAC, CAAD, CAAE, CAGA, CAGB, CAGC, CAHA, CAHB, CAMA, CAMB, CANA, CANB, CANC, CAND, CAPA, CARA, CASA, CASB, CASC, CASD, CATA, CAYA, CAYB, CAYC, CAYD, CAYE, CBAA, CBAB, CBAC, CBBA, CBBB, CBDA, CBDB, CBDC, CCFA, CCFC, CCHA, CCHB, CCCLA, CCMA, CCWA, CCWB, CDBA, CDCA, CDSB, CDTA, CDTB, CDUC, CDUD, CDYA, CDYB, CDYC, CEGA, CEXA, CFCA, CFFA, CFFB, CFFD, CFFE, CFCB, CFCG, CFCG, CFHA, CFHB, CFHC, CFHD, CFHE, CFHF, CFJA, CFWA, CGKA, CGKB, CGLA, CGLB, CGLC, CGLD, CGLF, CGQB, CJAA, CJCA, CJCB, CJCC, CJCD, CJGA, CJGC, CJGD, CJMA, CKDA, CKTB, CKTC, CKUB, CKUC, CKVB, CKVC, CLAA, CLAB, CLCA, CLCB, CLJA, CLLA, CLNA, CLZB, CMEA, CMFA, CMFB, CMGB, CMHA, CNEA, CNFA, CNRB, CRCA, CSHA, M05/9D(CAS), M05/9E, M05/9E(CRCA), M05/9E(CRCB)



54408

46,00€



N

SET DE UNELTE PENTRU SINCRONIZAREA MOTORULUI VAG DIESEL 1.7, 1.9, SDI, TDI

MĂRCI	AUDI: A3, A4, A6, CABRIOLET, SEAT: ALHAMBRA, AROSA, CORDOBA, IBIZA, INCA, LEON, TOLEDO, SKODA: FELICIA, OCTAVIA VW: BORA, CADDY, FOX, GOLF, LT, LUPO, PASSAT, POLO, SHARAN, TRANSPORTER, VENTO
INSTRUMENTE OEM	T1020 (1), 2587 (2), 2065A (3), T20044 (4), T10098 (5), T40011 (6), 2064 (7), T3359 (8), T10092 (9), M5x60M (10)
CODURILE DE MOTOR	1.7TDI/SDI: AHB, AHG, AKU, AKW 1.9TDI/SDI: 1X, 1Y, 1Z, ABL, AAZ, AEF, AEY, AFF, AFN, AGD, AHF, AHH, AHU, AGP, AGR, ALE, ALH, AQM, ASV, ASY, ASX, AVG, AYQ 2.4D: 1G, 1S, DW, DV, ACL, ACT

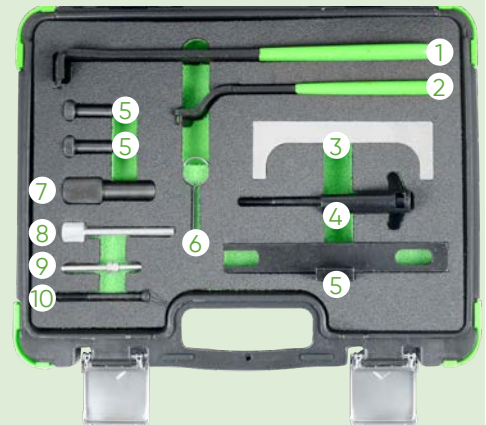

54409

32,00€

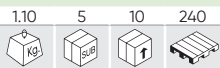

N

INSTRUMENT DE SINCRONIZARE PENTRU VAG 1.4 TSI

MĂRCI	ATECA (2016-) A3 (2012-) SUPERB (2015-) A1 SPORTBACK (2012-2018) LEON/LEON ST (2012-2020) MK5 (2012-2018) Q2 (2016-) Q3 (2015-2018)
INSTRUMENTE OEM	T10340 (1) T10504 (2) T10504/1 (3) T10504/2 (4)
CODURILE DE MOTOR	1.4 TFSI (CoD)-CPTA, CZEA 1.4 TSI (ACT)-CPTA, CZEA



54410

33,50€



N

INSTRUMENT DE SINCRONIZARE PENTRU VAG 2.4, 3.2 FSI

MĂRCI	AUDI: A4, A5, A6, A7, A8, Q5, Q7, R8, RS4, RS5, RS6, S4, S5, S6, S8 VW: TOUAREG
INSTRUMENTE OEM	T40058 (1) T40069 (2) T40071 (3) T40133 (3) T40133/1 (3) T40133/1/2 (3) T40133/2 (3) 40071 (4)
CODURILE DE MOTOR	2.4: BDW 3.2: AUK, BKH, BPK 4.2: BAR, BNS, BVJ, CAUA, CDRA, CFSA, BYH, CNDA 5.0: BUH 5.2: BSM, BUJ, BXA, CMPA, CTPA, CTYA

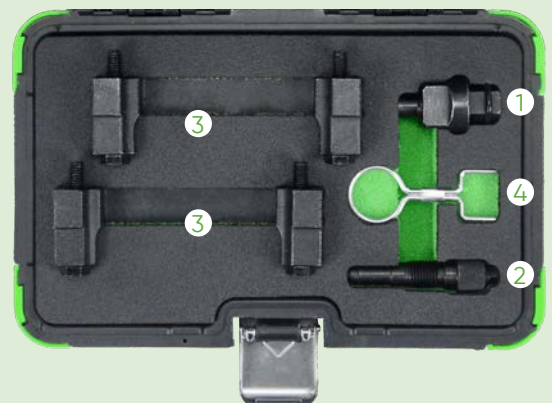

54411 36,00€

1.10 5 10 240

INSTRUMENT DE SINCRONIZARE PENTRU VAG/PORSCHE 2.4, 2.8, 3.0 TFSI

MĂRCI	AUDI: A4 (2011-2015) A5 (2007-2017) A6 (2007-2018) A7 (2010-2018) A8 (2010-2018) A8 (2010-2018) Q7 (2010-2018) S4 (2009-2017) S5 (2010-2017) S5 (2010-2017) Q5 (2008-2017) SQ5 (2013-2018) PORSCHE: CAYENNE (2010-2014) PANAMERA 2011-2013 VAG: TOUAREG (2010-2014)
INSTRUMENTE OEM	T40133/1 (1) T40133/2 (2) T40058 (3) T40069 (4) T40071 (5)
CODURILE DE MOTOR	AUDI: 2,5 CLXB, CPAA 2,8 BDX, CCDA, CCEA, CHVA, CJBA, CNYA 3,0 CAJA, CAKA, CCAA, CGEA, CGWA, CGWB, CGWC, CGWD, CGXB, CGXC, CHMA, CHMB, CJTB, CJTC, CJWC, CMDA, CMUA, CNA, CREA, CREC, CRED, CTTA, CTUA, CTUD, CTVA, CTWA, CTXA 3,2 CALA, CALB PORSCHE: 3,0 M06/EC VAG: 3,0 CJTA, CGFA

54412 57,00€

1.10 5 10 240

INSTRUMENT DE SINCRONIZARE PENTRU AUDI 2.5 TFSI

MĂRCI	AUDI: RSQ3 (2013-2015), RSQ3 (2015-2018), RS3 (2010-2013), RS3 (2015-2017), TT (2009,2014)
INSTRUMENTE OEM	T03003 (1) T40264/1/2 (2), T40264/2A (2) T40069 (3) T40011 (4) T40297 (5)
CODURILE DE MOTOR	2,5 TFSI/RS CEPA, CEPB, CTSA, CZGA, CZGB

54413 115,00€

2.50 - 5 135

INSTRUMENT DE SINCRONIZARE PENTRU AUDI 4.0 FSI, TFSI

MĂRCI	AUDI: A8, RS6, RS7, S6, S7, S8 (2012-2018)
INSTRUMENTE OEM	T40071 (1) T40257 (2) T40264/1 (3) T40264/2 (4) T40264/3 (5) T40269 (6) T40272 (7)
CODURILE DE MOTOR	CEJA CEUC CGTA CRDB CTFA CTGA CTGE CWUB CWUC DDTA

54431

184,00€



N

INSTRUMENT DE SINCRONIZARE PENTRU ALFA ROMEO/MASERATI 2.9

MĂRCI	ALFA ROMEO: GIULIA, STELVIO MASERATI: 3,8T
INSTRUMENTE OEM	1860815000 (1) 2024000090 (2) 2024100000 (3)
CODURILE DE MOTOR	2.9: 670050436,670051007 ,670052721 ,670052722

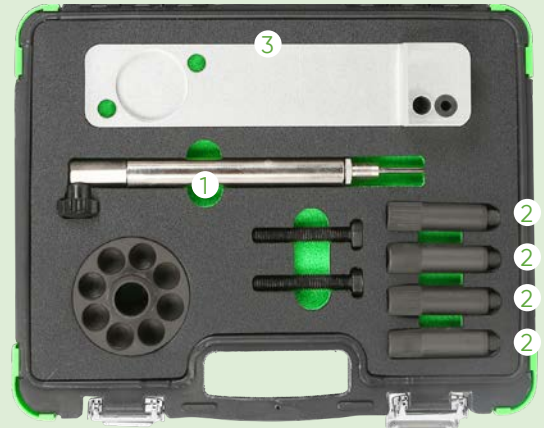

53315

285,00€

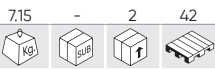

KIT DISTRIBUȚIE PE LANȚ VOLVO 3.0, 3.2T6 / LAND ROVER 3.2

MĂRCI	VOLVO: S60 (10-16), S80 (07-15), XC60 (08-15), XC70 (06-15), XC90 (10-14), V60 (10-15), V70 (10-15). LAND ROVER: FREELANDER II (11-14).
INSTRUMENTE OEM	VOLVO: 999-7263 (3), 999-7264 (1), 999-7272 (5), 999-7257 (2), 999-7261 (4). LAND ROVER: 303-1225 (3), 303-1226 (1), 303-1219 (2), 303-1223 (4).
CODURILE DE MOTOR	3.0 TURBO: B6304T2, B6304T4. 3.2: B6324S, B6324S5. 3.2i6: B6324S.

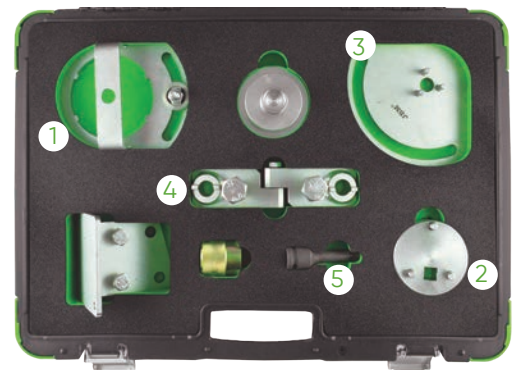

54226

71,00€



SET DE EXTRAȚIE PENTRU SCRIPETE DE POMPĂ DE ÎNALTĂ PRESIUNE PENTRU HYUNDAI/KIA

MĂRCI	HYUNDAI: ACCENT (11-15), ELANTRA (07-10), I20 (09-18), I20 (10-18), I20 COUPE (15-17), I30 (07-19), IX35 (10-16), I40 (11-18) KIA: CARENS (13-18), CEED (07-18), OPTIMA (11-15), PRO-CEED (08-19), RIO (09-17), CERATO (05-07), SOUL (09-14), SPORTAGE (10-18), VENGA (09-18)
INSTRUMENTE OEM	09331-2A000/2A010 (1), 09331-2A010 (1)
CODURILE DE MOTOR	1.1D CRDI: D3FF 1.4D CRDI: D4FC(U1), D4FC(U2) 1.6D CRDI: D4FB(U1), D4FB(U2), D4FB-H(U1), D4FB-H(U2), D4FB-L(U1) 1.7D CRDI: D4FD(U2), D4FD-H(U2), D4FD-L, D4FD-L(U2)



54200

56,00€

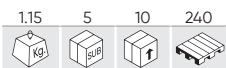

SET INSTRUMENTE DE REGLARE A MOTOARELOR PENTRU PORSCHE

MĂRCI	911 (2001 - 2008), BOXSTER (2002 - 2011), CAYMAN (2006 - 2009)
INSTRUMENTE OEM	9685 (1), 9686 (2), 9595 (3), 9595/1 (4)
CODURILE DE MOTOR	M96/03, M96/05, M96/23, M96/25, M97/20, M96/24, M96/26, M97/01, M97/21, M97/22.



51927

25,00€

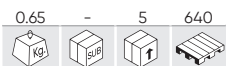

APARAT PT. DEMONTAT ȘI MONTAT CURELE AUX. POLI-V

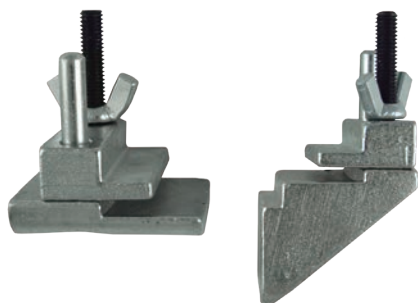

51340

39,30€



CHEIE UNIVERSALĂ PT. FULII, PINIOANE + ADAPTOARE



52616

44,00€

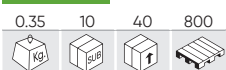

TENSIOMETRU PENTRU CURELE DE DISTRIBUȚIE

- Două scări gradate (daN) cu citire din față și din spate.



53769

178,00€

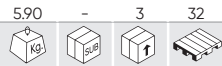

MODUL DE DISTRIBUȚIE PE LANȚ RENAULT/NISSAN/OPEL/VOLVO

MĂRCI	<p>RENAULT: AVANTIME, CLIO, ESPACE, KANGOO, LAGUNA, MASTER, MEGANE, MODUS, SCENIC, TWINGO, TRAFFIC.</p> <p>OPEL/VAUXHALL: MOVANO, VIVARO.</p> <p>DACIA: DOKKER, DUSTER, LOGAN, SANDERO.</p> <p>NISSAN: ALMERA, INTERSTAR, KUBISTAR, MICRA, NOTE, PRIMERA, QASHQAI.</p> <p>VOLVO: S40, V40</p>
INSTRUMENTE OEM	<p>MOT 1312 (1), MOT 1135-01 (2), MOT 1384 (3), MOT 1340 (4), MOT 1543 / KM-6234 / KV113 B0360 (5), MOT 1489 / KV113 B0130 (6), MOT 1536 / KM-6203 (7), MOT 1489 (8), MOT 1054 / KM-6031 / KV113 / B0280 (10), MOT 1318 (11), MOT 910 (12), MOT 910 (14), MOT 1386 (15), MOT 1534 / KM-6205 (16), MOT 1543 / KM-6234 / KV113 B0360 (17), MOT 1543 / KM-6234 / KV113 B0360 (18), MOT 1543 / KM-6234 / KV113 B0360 (19), MOT 1543 / KM-6234 / KV113 B0360 (20), MOT 1386 (22), MOT 1537 / KM-6204 (23), MOT 1348 (24), MOT 1538 (25), MOT 1337 (26), MOT 1496 / MOT 1750 (27), MOT 1490-01 (28), MOT 1200-01 (29)</p>
CODURILE DE MOTOR	<p>PEROL: 2.0 16V, 2.5 20V, 1.4, 1.6 16V, 1.8, 2.0 16V, 1.2, 1.7, 1.8, 2.0 16V, 2.2</p> <p>GASOIL: 1.9, 2.5, 2.8</p> <p>D4F702/706/708/712/714/716/722/728/730/740/764, D7F700/701/710/720/722/726/730/744/746/764/766, E7F700/704/706/750, E7J601/624/626/634/635/680/700/706/710/711/716/718/719/720/724/726/728/740/742/745/754/756/757/764/770/771/773/780, F3P670/682/700/704/706/708/710/712/714/720/724/755/758/760, F7P704/722, F3R611/722/723/728/729/750/751/752/791/796/797/798, F5R700/701/740, J7R732/733/734/735/768, F7R710/714, J7T600/760/761/762/766/772/780/782, N7Q704/710/711, N7U700/701, K4J700/710/711/712/713/714/715/730/732/740/750/770/780, K4M700/701/704/706/707/708/709/710/711/712/714/716/718/720/724/730/732/734/736/740/742/743/744/745/746/748/750/752/753/754/760/761/762/764/765/766/768/776/782/788/790/791/794/800/801/802/804/812/813/830, K9K700/702/704/706/710/712/714/716/718/722/724/728/729/732/734/740/750/752/760/762/764/766/768/802/804/806, F9Q610/650/664/670/674/71/716/717/718/720/722/730/731/732/733/734/736/738/740/744/748/750/752/754/758/759/760/768/762/770/772/774/780/782/784/786/788/790/796/800/803/804/808/812/816/818/820, G9T600/605/700/702/703/706/707/710/712/720/722/742/743/750, G9U720/724/726/730/750/754, F8M736/760, F8Q600/610/606/620/622/624/630/632/640/644/646/648/662/672/678/680/682/684/692/696/706/714/720/722/730/732/740/742/744/764/768/706/776/784/786/788, J8S620/621/622/758/760/776/778, G8T714/716/740/752/760/790/792/794, S8U720/722/730/731/742/748/750/752/770/772/780/782, S9U700/702/704/714/740, S9W700/702/206/208/212, ESF, E6J, K7M, F4P/F4R, FIN, F2N, F3N, F2R, F3P, F4P, F3R, J5T, J6R, J7R</p>

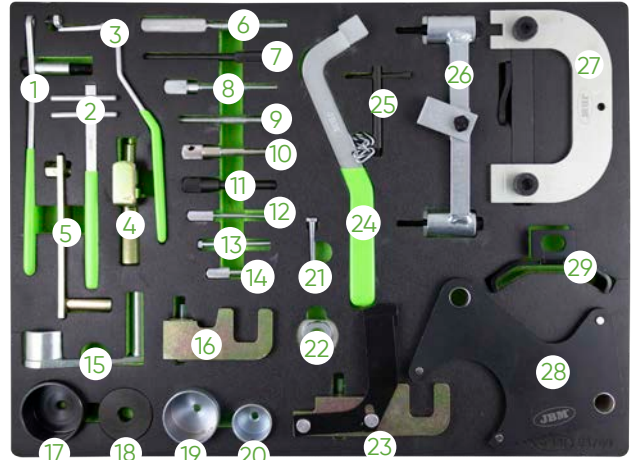

53773

298,00€



MODUL DE BLOCARE FIAT/ALFA/LANCIA/OPEL/SUZUKI/FORD

MĂRCI	<p>ALFA: ROMEO 145, 146, 147, 155, 156, 159, 166, SPIDER, GTV, TS, GT, CROSSWAGON Q4</p> <p>FIAT: PUNTO, GRANDE PUNTO, BRAVA, BRAVO, MAREA, WEEKEND, STILO, DOBLO, CARGO, IDEA, PANDA, MULTIPLA, PALIO, STILO, 500</p> <p>LANCIA: LYBRA, YPSILON, THESIS, MUSA</p> <p>OPEL: CORSA, AGILA, MERIVA, COMBO, VECTRA, ZARA, ASTRA, INSIGNA, SIGNUM 19 CDTI</p> <p>SUZUKI: IGNIS, SWIFT, WAGON R+</p> <p>FORD: KA</p>
INSTRUMENTE OEM	<p>1860874000 (1), 1860874000 (2), 2000004400 / 2190754400 (3), 1860863000 (4), 1860898000 (5), 2190754500 (6), 2000004300 (7), 1870900400 (8), 1860703000 (9), 1860933000 (10), 1860845000 (11), 1870900300 (12), 1860905000 / EN-46788 (13), 1895443000 (14), 1860992000 (15), 1870896900 (16), 1860987000 (17), 1860905000 (18), 1860771000 (19), 1860161000 (20), 1860876000 (21), 1860876000 (22), 1871000900 (23), 1860985000 (24), 2000004200 / 2190754200 (25), 1860965000 (29)</p>
CODURILE DE MOTOR	<p>176B9.000, 182B2.000, 188A5.000, 843A1.000, 323.02, 371.01, 182B4.000, 182B9.000, 186A6.000, 188A2.000, 188A7.000, 188B2.000, 192A1.000, 192A3.000, 937A2.000, 939A1.000, 192A5.000, 192B1.000, 198A5.000, 937A5.000, 939A2.000, 325.01, 342.02, 362.02, 185A6.000, 841C.000, 841G.000, 939A3.000, 940A3.000, 940A4.000, 940A5.000, Z19DT/DTH/DTR/DJ/DTL, 169A1.000, 955A4.000, 350A3.000, 192B4.000, 198A2.000, 350A2.000, 955A3.000, 192A8.000, 198A6.000, 198A3.000, 199B1.000, 199B2.000, 199A2.000, 199A3.000, 199A9.000, 188A3.000, 188A8.000, 188A9.000, 192A9.000, 186A8.000, 186A9.000, 199A5.000, 223A7.000, 223A9.000, 841H.000, 841P.000, 185A2.000, Z13DT, Z13DTJ, Z13DTH, 182A4.000, 182A6.000, 182B6.000, 178B3.000, 186A3.000, 186A4.000, 350A1.000, 169A4.000, 188A4.000, 199A4.000, 199A7.000</p>

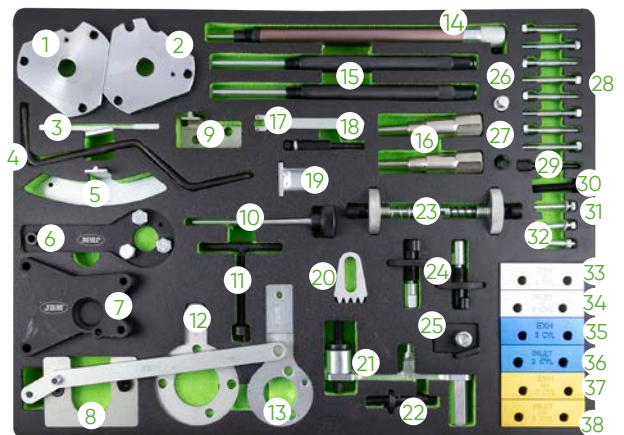

53770

198,00€



MODUL DE DISTRIBUȚIE PE LANȚ FORD/SEAT/VOLKSWAGEN/MAZDA/VOLVO

MĂRCI	FORD: FIESTA, FUSION, COURIER, ESCORT, FOCUS, FOCUS C MAX, PUMA, MONDEO, SIERRA, COUGAR, GALAXY, C-MAX, ORION, TOURNEO CONNECT, TRANSIT, TRANSIT CONNECT. VW: SHARAN. SEAT: ALHAMBRA. MAZDA: 121. VOLVO: S40, V50.
INSTRUMENTE OEM	303-1061 (1), 303-1054 (2), 23-059 / 310-085 (3), 21-105 (4), 323-029 (6), 0194-B / 21-263 / 303-735 / 49 JE 02 021 (7), 0132-AB / 0178-D / 21-151 (9), 0194-C, 21-262, 303-734, 49 JE 02 020 (10), 21-238 / 303-679A / 303-1151 (11), 21-238 / 303-679A / 303-1151 (12), 303-1054 (13), 303-1151 (14), 21-238 / 303-679A (15), 303-393 / 303-393-02 (16), 303-1097 (17), 21-168 / 303-393 (18), 303-0985 (20), 2064 / 23-047 / 310-055 / U20003 (21), 303-652 (22), 21-229, 303-651 (23), 303-748 (24), 21-210 (25), 21-260, 303-732 (26), 21-163, 303-620 (27), 21-234 / 21-251 (28), 303-675 / 303-698 (29), 21-104 / 303-193 (30) / 21-162B / 303-367 / 303-376 (31), 21-162B / 303-376 / 303-376B (32), 23-019 (33), 23-058 / 310-084 (34), 0153-M / 0178-C / 0178-D (35), 0178-B / 5711-TB (36), 21-123 (37), 23-020 (38), 21-234 / 21-251 (39), 303-1059 (40), 23-019 (41), 303-1060 (42), 303-393 / 303-393-01 (43)
CODURILE DE MOTOR	FUJA, FUJB, FXJA, FXJB, FXJB, FYJA, FYJB, F8JA, F8JB, M7JA, M7JB, DHA, DHB, DHC, DHD, DHE, DHF, DHG, FHA, FHE, LIT, LIV, LIE, LIG, LIH, LIK, RDA, RDB, RKC, RQB, RQC, FXDA/C, FXDB/D, FYDA/C, FYDB/D, FYDH, HWDAIZ, AHU, AVG, AFN, D24, D24T, D24TIC, RFN, RTJ, RTK, RVA, RFK, RKD, B4164S3, DV4TD (8HW/8HX/8HZ), DV4TED4(8HV/8HY), DV6ATED4 (9HX/9HY/9HZ) F6JA, F6JB, F6JC, G8DA, G8DB, KKDA, SNJA, SNJB, STJA, STJB, ASDA, ASDB, FXJC, SPJA, SPJC, FYJC, HWDA, HWDB, SHDA, SHDB, SHDC, JQDA, LQDB, JTDA, JTDB, HXDA, HXJA, HXJB, IQDA/B, IQDB, PNBA, PNDA, RHBA, SIDA, F6JD, TZJA, TZJB, HHDA, HHDB, HHJA, HHJC, HHJD, HHJE, HHJF, RTA, RTB, RTC, RTD, RTE, RTF, RTH, RTJ, RTK, RFN, BHPA, HCPA, HCPB, KKDA, P7PA, P9PA, P9PB, R2PA, R3PA, RWPA, RWPC, F9DA/B, FFBA, FFWA, KHBA, QYBA, QYWA, KKDB, C9DC, RVA, 1Z, AFN, AHU, ANU, AUJ, G6DA, G6DB, G6DC, G6DD, G6DE, G6DF, G6DG, UFDB, TXDB, TYDA, UKDB, QXBA, AZBA, KLBA, QXBB, LPBA, AZCB, TYBA, UKBA, UFBA, TXBA, IXDA, QXWA, QXWB, AZWA, KLWA, AZWC, TYWA, UKWA, TXWA, UFWA, UFDA, TXDA, UKDA, Q4BA, KNBA, 4BA, 4BB, 4BC, 4CC, 4FA, 4CA, 4CB, 4DA, 4EA, 4FA, 4FB, 4FC, 4FD, 4GA, 4HB, 4HC, 4EB, 4EC, 4ED 4GA, 4GB, 4GC, 4GD, 4GE, 4GF, 4HA, 4HD, FMBA/B, D5BA, ABFA, D3FA, D6BA, HJBA/B, F3FA, D2FA, D4FA, F4FA, F5FA, DOFA, QJBA, QJBB, QJBC, QJBD, FXFA, H9FA, H9FB, N7BA, N7BB, MZ-CD 1.6, Y6

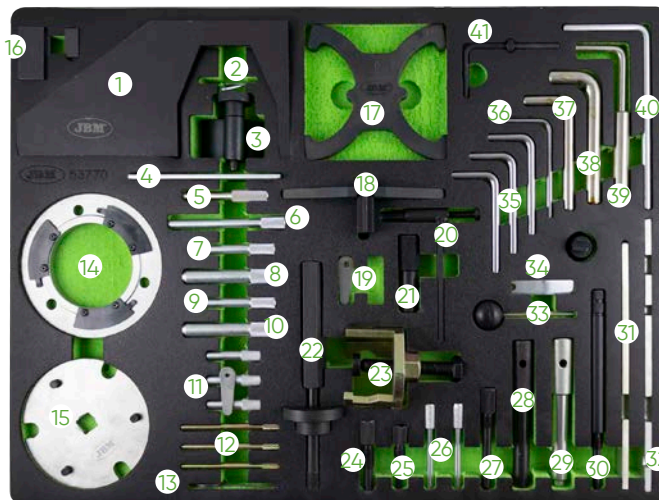

53774

190,00€



MODUL DE DISTRIBUȚIE PE LANȚ OPEL/CHEVROLET/SAAB/FIAT/LANCIA/SUZUKI/FORD

MĂRCI	ALFA: 145, 146, 147, 156, 159, 166, GT, CROSSWAGON Q4 FIAT: PUNTO, GRANDE PUNTO, BRAVO, BRAVA, MAREA WEEKEND, STILO, DOBLÒ, CARGO, MULTIPLA IDEA, PANDA LANCIA: YPSILON, MUSA, LYBRA, THESIS OPEL: CORSA B/C, COMBO, TIGRA, AGILA, TIGRA B, MERIVA, ASTRA F/G/H, ASTRAVAN, SPEEDSTER VX220, ZAFIRA A/B, VECTRA B/C, SIGNUM, OMEGA B, SINTRA, FRONTERA A/B, ASTRAVAN, KADETT, ASCONA, OMEGA, MONTEREY, ANTARA, CROMA, SPEEDSTER VX220 SUZUKI: IGNIS, SWIFT, WAGON R+ FORD: KA CHEVROLET & DAEWOO: EPICA, CAPTIVA, NUBIRA, LACETTI, EVANDA SAAB: 9-3, 9-5 (98-04)
INSTRUMENTE OEM	1860905000 / 1860905010 / EN-46788 (1), KM-6148 (2), KM-6148 (3), 1870900400 / 1871000200 (4), KM-954 (5), KM-J-43651 (6), 1860905000 / 1860905010 / EN-46788 (7), KM-852 (8), KM-853 (9), 1870900300 / 303-1468 (10), EN-46785 / KM-951 (11), KM-932 (12), 1860703000 (13), KM-955 (14), KM-6130 / KM-6349 / KM-6349 (15), KM-927 (16), EN-48245 (17), KM-933 (18), EN-46785 (19), 1860985000 / 1871000900 / EN-46781 (20), 1860985000 / 1871000900 / EN-46781 (21), EN-48246 (22), KM-929 (23), 1870896900 / EN-46789 (24), KM-952 (25), 21-162B / 303-376 / 303-376B (26), KM-933 (27)
CODURILE DE MOTOR	X14XE, Z14XE, X16SEJ, X16XE, X16XEL, Y16XE, Z16XE, Z16YNG, C18XEL, X18XE, X18XE1, Z18XE, Z18XEL, C20SEL, C20XE, X20XE, Z20LEH, Z20LEL, Z20LER, Z20LET, X22SE, Z22XE, Y22SE, Y22XE, Z22XE, D223L, X10XE, Z10XE, Z10XEP, X12XE, Z12XE, Z14XEP, X20DTL, X20DTH, X22DTH, Y20DTL, Y20DTH, Y22DTH, Y22DTR, 169A1.000, 955A4.000, 350A3.000, 192B4.000, 198A2.000, 350A2.000, 955A3.000, 192A8.000, 198A6.000, 198A3.000, 199B1.000, 199B2.000, 199A2.000, 199A3.000, 199A9.000, 940A3.000, 188A3.000, 939A2.000, 188B2.000, 188A8.000, 188A9.000, 323.02, 371.01, 937A2.000, 182B4.000, 182B9.000, 188A2.000, 188A7.000, 192A9.000, 186A6.000, 186A8.000, 192A1.000, 192A3.000, 192B1.000, 192A5.000, 186A9.000, 939A1.000, 199A5.000, 223A7.000, 223A9.000, 342.02, 362.02, 84TG.000, 84TH.000, 84IP.000, 939A3.000, 185A2.000, 185A6.000, Z13DT, Z13DTJ, Z13DTH, Z19DT, Z19DTH, Z19DTJ, Z19DTL, X10XE, Z10XE, Z10XEP, Z12XE, Z14XEP, X16S2R, Z16SE, 4EC1/T, 4EC1, 4EE1/T, 4EE1, X17DT, Y17DT, Y17DTL, 16DA, 17D, 17DR/X, 7DTL, X17DTL, 4JX1/4, JG2T, 4FC1/T, 4FD1, X20DTL, Y20DTL, D223L Z20DMH, Z20DM, RA420, Z20S1, 194A1.000, Z22SE, Z22YH



53771

158,00€

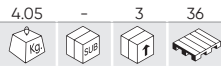

MODUL DE DISTRIBUȚIE PE LANȚ FIAT/FORD/CITROËN/PEUGEOT

MĂRCI	FIAT: ULYSSE, SCUDO, DUCATO LANCIA: ZETA, PHEDRA FORD: FIESTA, FUSION, FOCUS, FOCUS C-MAX CITROËN: C15, C1, C2, C3 PLURIEL, C4, C4 PICASSO, C5, C6, C8, DS3, DS4, DS5, XANTIA, XSARA, XSARA PICASSO, EVASION, BERLINGO, JUMPY, JUMPER, SAXO, ZX, XM, EVASION, AX PEUGEOT: 107, 1007, 206 CC, 207, 208, 306, 307 CC, 308, 406, 407, 508, 607, 806, 807, PARTNER, EXPERT, BOXER, 206, 106, 605, 205, 405
INSTRUMENTE OEM	4200-TH (1), 0117-AR (2), 0188-X (3), 0606-A1.A2 (4), 0188-Q2 (5), 0189-S1 (6), 7017-TR (7), 0132-P / 4507-TL (8), 0189-C (9), 0188-J1 (10), 0188-J2 (11), 0178-E (12), 0189-R (13), 0132-AK / 0188-AK / 0189-K / 0153-AK / 4533-TAD / MOT 1436 (14), 0188-AH (15), 0189-S2 (16), 0153-AB / 9041-TZ (17), 0153-M / 0178-C / 0178-D / 7014-TM / 9767-94 (18), 0189-A (19), 4527-TS1 (20), 0153-AB / 9041-TZ (21), 0189-B / 21-163 (22), 0132-AJ1 / 0153-G / 0188-M / 0189-J / 4533-TAC1 / 5711-TA (24), 0189-L (25), 0188-D / 7017-TM (26), 0132-X / 0188-Q1 / 4507-TJ / 9767-89 (27), 0194-B (28), 0132-AB / 0194-A (29), 0194-C / 21-262 / 303-734 (30), 4527-TS2 (31), 0188-E (32), 0153-A / 6012-T / 9765-54 (33), 0134-AF / 0134-Q / 0188-F / 9004-T (34), 0188-P2 / 0188-P / 174 / 7015-T (35), 0153-U 7019-T (36), 0153-N / 0188-Y / 7014-TJ / 7099-TM / 9797-34 (37)
CODURILE DE MOTOR	F6JA, F6JB, F6JC, G8DA, G8DB, HHDA, HHDB, HHJA, HHJB CITROËN, PEUGEOT: 1.0 / 1.1 / 1.4 / 1.6 / 1.6 16V, 1.4 / 1.6 HDI / 1.8 / 1.8 16V / 2.0 / 2.0 TURBO, 1.9D / 2.0 HDI / 2.2 HDI / 1.8 16V / 2.0 16V TU9 (CDY/CDZ), TU1 (HDY/HDZ/HFX/HFY/HFZ), TU3 (KDX/KDY/KDZ/KFX/KFZ), TU5JP4 (NFU/NFX), TU5 (BDY/BFZ/NFT/NFV/NFW/NFY/NFZ), XU7 (LFW/LFX/LFZ), EW7J4 (RLZ), XU7JP4 (LGY), XU10 (RFL/RFU/RFV/RFW/RFX/RGX/RGY), XU10A (RFJ), EW10J4S (RFK), EW10D (RLZ), EW12J4 (3FZ), ET3JE (KFU), TU3A/JP (KFV/KFW), DV4TD (8HW/8HX/8HZ), DV4TED4 (8HV/8HY), DV6ATED4 (9HX/9HY/9HZ), EW10-CVI (RLZ), EW12 (3FZ), DW8 (WJZ/WJY), DW10 (RHY/RHV/RHZ/RHS/RHM/RHW/RHT/RHR/RHX), DW12 (4HX/4HZ/4HW/4HY), EW7J4 (6FZ), EW10J4 (RFR), EW10J4D (RLZ), DW12TED4 (4HW), DW10ATED (RHT/RHV/RHW/RHX/RHZ) FORD 1.4 / 1.6 DURATORQ TDCI

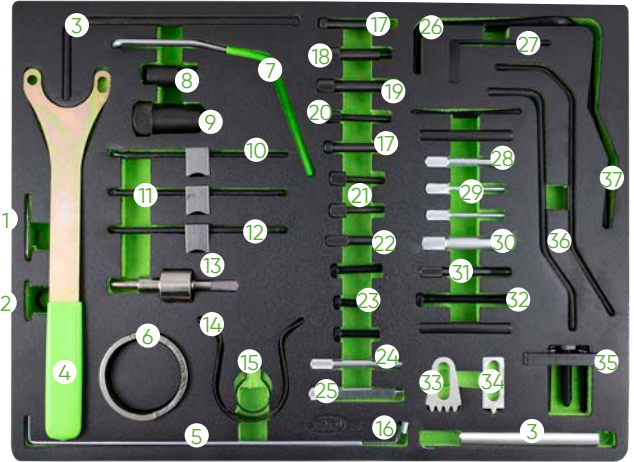

53772

229,00€

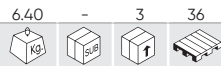

MODUL DE DISTRIBUȚIE PE LANȚ FORD/VAG/MAZDA/VOLVO

MĂRCI	AUDI: 80, A1, A2, A3, S3, A4, A5, A6, TT, Q5 SEAT: AROSA, IBIZA, CORDOBA, LEON, TOLEDO, ALHAMBRA, ALTEA, INCA (99-04) SKODA: FABIA, OCTAVIA, SUPERB VW: LUPO, POLO, FOX, GOLF, BORA, JETTA, GOLF PLUS, PASSAT, BEETLE, TOURAN, SHARAN, CADDY, CADDY MAXI, TRANSPORTER, GOLF VI CABRIO, TIGUAN FORD: GALAXY
INSTRUMENTE OEM	T10252 (1), VAS6079 (2), T10121 (3), MP1-1312 / T10098 / T20038 / T20038 (4), T10123 (5), 23-058 / 310-084 / T10008 (6), 2065A / T10008 / U40021 (7), 3418 (8), T10171 (9), 23-059 / 23-059 / 310-085 / T10050 / T10050 (10), 3458 / T30094 (11), T10016 / T10074 / T10074 (12), T10100 (14), T10414 (15), 3366 / T20018 / T20044 (16), 3411 (17), 3369 / T30092 (18), T10341 (19), 3242 / T40069 / T30052 (20), T 40026 (21), 3359 / MP1-301 / T20102 (22), 2064 / U20003 (23), T10120 (24), MP1-1312 / T10098 / T20038 (25), T10170 (26), T00115 / T10264 / T40098 (27), T10092 (28), T00115 / T10264 / T40098 (29), 303-1054 / T10115 (30), T10060 / T10060A (31), 3359 / MP1-301 / T20102 (32), T10340 (33), 2587 (34), 3387 / U30009A (35), 3387 / T10020 (36)
CODURILE DE MOTOR	ARC, ATN, AUS, AVY, AZD, AFH, BCA, AJV, AKQ, AUA, AUB, AXP, AFH, AFN, AFK, AHW, AHU, APE, AQQ, AUS, AXP, AZD, BBY, BBZ, BCB, ANY, AYZ, AMF, ATL, BAY, BHC, BMS, BNM, BNV, BWB, AJM, AMG, ANU, ARL, ASZ, ATD, ATJ, AUU, AVB, AVF, AVQ, AWW, AXB, AXC, AXR, BEW, BJB, BKC, BKE, BLS, BLT, BMT, BPX, BRB, BRM, BRR, BRS, BRU, BSU, BSW, BTB, BUK, BVK, BXE, BXF, AZV, BDJ, BDK, BGW, BHW, BKD, BKP, BLB, BMA, BMM, BMN, BMP, BMR, BNA, BPW, BRC, BRE, BRF, BRT, BUZ, BE, BVF, BVG, BVH, BWK, BTS, BMY, BLF, BWV, AZV, BKD, AWY, AZQ (55 - 64 PF), AXU, BAG, BKG, BLF, BLN, BLP, BVF, BKF, BNU, BVP, BVR, 1Z, CBZA, CBZC, CBZB, CAXA, CAGA, CAGB, CAGC, CAHA, CAYA, CAYB, CAYC, CBAA, CBAB, CBAC, CBBA, CBBB, CBDA, CBDB, CBDC, CBEA, CEGA, CKUB, AZV, BDJ, BHP, BKD, BLB, BMA, BMM, BMN, BMP, BMR, BNA, BPW, BRC, BRE, BRF, BRT, BSS, BUY, BUZ, BVA, BVE, BVF, BVG, BVH, BWV, ACV, AFB, AGX, AHD, AHY, AHY, AJT, AKE, ANJ, APA, AUF, AXG, AXG, AXL, AYC, AYM, AYY, BAU, BBE, BBF, BCZ, BDG, BDH, BFC, BJJ, BJK, BJL, BJM



DULAP CU 7 SERTARE CU SET DE INSTRUMENTE PENTRU REGLAREA SINCRONIZĂRII

53951 1.794,00€

94.70 - 1 4

PLIN

53952 1.794,00€

94.70 - 1 4

PLIN

54501 1.794,00€

94.70 - 1 4

PLIN

54502 1.794,00€

94.70 - 1 4

PLIN

DIMENSIUNI INTERIOR

SERTAR MIC (X5)

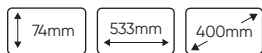

SERTAR MARI (X2)



CAPACITATEA DE ÎNCĂRCARE A SERTARULUI: 30KG.
CAPACITATE TOTALĂ DE ÎNCĂRCARE: 70KG.

DIMENSIUNILE TOTALE

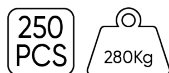

CU EVA MODULE:

SET DE 6 INSTRUMENTE PENTRU SINCRONIZAREA MOTORULUI

53775 1.109,00€

15.50 - 1 6

GASOLINA/PETROL DIESEL/GASOIL

INCLUDE

REF.					€
53769	5.90	-	3	32	178,00€
53770	6.15	-	3	36	198,00€
53771	4.05	-	3	36	158,00€
53772	6.40	-	3	36	229,00€
53773	6.60	-	3	36	298,00€
53774	6.95	-	3	36	190,00€

53769

RENAULT / NISSAN / OPEL / VOLVO

53770

FORD / SEAT / VOLKSWAGEN / MAZDA / VOLVO

53771

FIAT / FORD / CITROËN / PEUGEOT

53772

FORD / VAG / MAZDA / VOLVO

53773

FIAT / ALFA / LANCIA / OPEL / SUZUKI / FORD

53774

OPEL / CHEVROLET / SAAB / FIAT / LANCIA / SUZUKI / FORD

