



KIT DI MESSA IN FASE



KIT DI MESSA IN FASE

TAVOLA DEI CONTENUTI



FIAT/ALFA ROMEO	3
BMW/MINI	8
PSA	17
FORD	20
JAGUAR/LAND ROVER	26
JEEP/CHRYSLER	28
MERCEDES-BENZ	29
RENAULT/DACIA/NISSAN	32
OPEL/VAUXHALL	37
VAG	42
ALTRI	54
STRUMENTI AUSILIARI	56



IL TUO KIT DI MESSA IN FASE
ANCORA PIÙ VICINO



INSERISCI NELLA PAGINA WEB IL CODICE DEGLI
ATTREZZI OEM O IL CODICE DEL MOTORE DELLA
TUA AUTO E TROVA IL KIT COMPATIBILE



53303

89,00€

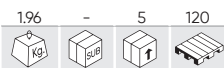

KIT DI ATTREZZI DI REGOLAZIONE CINGHIA DENTATA PER FIAT / OPEL

MODELLO	FIAT: 1.9D/JTD (MOTOR PEUGEOT), 2.4D. ALFA ROMEO: 145, 146, 156 JTD. GM: GM 1.3, 1.6, 1.9, 2.0, 2.4 CDTI (2004 -).
UTENSILI OEM	EN-46789 (1), EN-46789-100 (2), EN-46785 (3), EN-46788 (4), EN-46781 (5), EN-46789 (6)
CODICE MOTORE	GM: K1.3 CDTI Z13DT COMMON RAIL ENGINE. 1.9 CDTI / 04-12 - Z19DT Z19DTH Z19DTJ Z19DTL 2.0 CDTI / 08-12 - A20DT LBS / LBX / LBY / LCDV SAAB: 1.9 TID.



53304

279,00€



KIT DI ATTREZZI DI REGOLAZIONE CINGHIA DENTATA PER FIAT

MODELLO	FIAT
UTENSILI OEM	1 860 874 000 (1), 1 860 895 000 (2), 1 860 898 000 (3), 1 860 905 000 (4), 1 860 845 000 (5)
CODICE MOTORE	PETROL: FIAT BRAVA, BRAVO, BARCHETTA, CARGO, COUPE, MAREA, PALIO, WEEKEND, PUNTO, MULTILA, STILO, IDEA, DO- BLO TWIN CAM ENGINES - 1.2, 1.4, 1.6, 1.8, 16V GASOIL: FIAT BRAVA, BRAVO, MAREA, WEEKEND, PALIO, PUNTO, MULTIPLA, DOBLO, ULYSSE, DUCATO, STILO JTD DIESEL ENGI- NES - 1.9D/TD . 1.9JTD . 2.4TD/JTD.

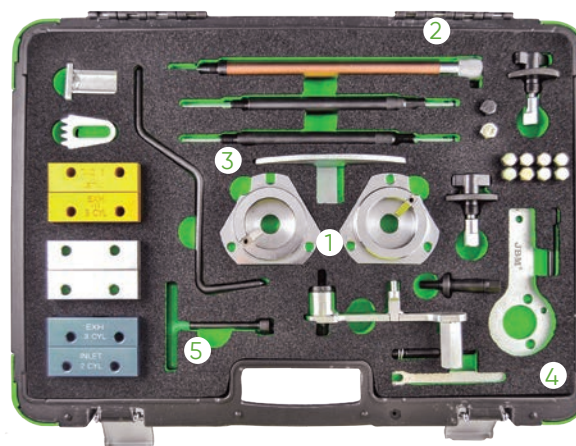

53306

53,00€



KIT DI ATTREZZI DI REGOLAZIONE CINGHIA DENTATA PER FIAT 1.2 16V

MODELLO	FIAT: FIAT 1.2L 16V, FIAT PUNTO / BRAVA / BRAVO / STILO
UTENSILI OEM	1860992000 (1) (2), 1871000900 (3), 1860987000 (4), 186985000 (5)
CODICE MOTORE	176 B9.000, 182 B2.000, 188 A5.000



53308

55,00€

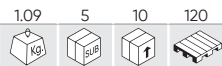

KIT DI ATTREZZI DI REGOLAZIONE CINGHIA DENTATA PER ALFA ROMEO

MODELLO	ALFA ROMEO: 145,146,147,155,156, 1.4 1.6 1.8 2.0 TS, 1.4/1.6 16V; 145/146/147/155/156 (96-10), 1.8 16V; 145/146, (96-01), 155/156 (96-06), SPIDER/GTV (98-05), 2.0 16V; 145/146 (96-01), 147 (01-10), 155/156 (95-02), 166 (98-07), SPIDER/GTV (96-05), PÚRPURA / PURPLE: 1.4, 1.6 // AZUL / BLUE: 1.8, 2.0
UTENSILI OEM	1822149000 (1), 1822154000 (2), 1825041000 (3), 1825042000 (4)
CODICE MOTORE	Z1.4/1.6-321.02, 321.03, 321.04, 335.03, 676.01 1.8/2.0-323.01, 672.04, 162.01, 323.10, 671.06, 322.01, 671.02, 322.05, 341.03, 363.01.

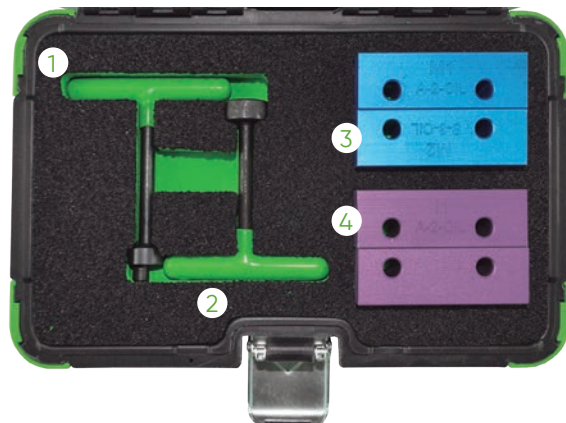

53309

285,00€



KIT DI ATTREZZI DI REGOLAZIONE CINGHIA DENTATA PER ALFA/FIAT/LANCIA 1.4, 1.6, 1.8, 2.0 16V

MODELLO	ALFA ROMEO: 145,146,147,155,156, 1.4 1.6 1.8 2.0 TS, 1.4/1.6 16V; 145/146/147/155/156 (96-10), 1.8 16V; 145/146, (96-01), 155/156 (96-06), SPIDER/GTV (98-05), 2.0 16V; 145/146 (96-01), 147 (01-10), 155/156 (95-02), 166 (98-07), SPIDER/GTV (96-05), PURPUR: 1.4, 1.6 // BLAU: 1.8, 2.0 FIAT: BARCHETTA (96-00), BRAVA (95-00), BRAVO (95-0 0), COUPE (96-01), MAREA (96-00), MAREA WEEKEND (96-00), PUNTO/PUNTO CLASSIC (99-06), STILO (01-08) LANCIA: DEDRA (95-99), DELTA (96-99), KAPPA (98-02), LYBRA (99-06).
UTENSILI OEM	1.4 16V: 335.03 1.6 16V: 321.02, 321.03, 321.04, 372.03, 676.01 1.8 16V: 322.01, 322.05, 671.06, 182A2.000, 183A1.000, 183A6.000, 188A6.000, 192A4.000 2.0 16V: 162.01, 323.01, 323.1, 341.03, 363.01, 672.04 2.0 20V: 175A3.000, 182A1.000, 182B7.000, 185A8.000.

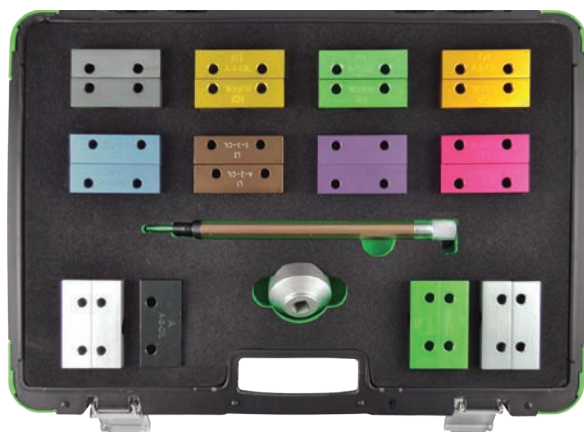

53310

498,00€



KIT DI ATTREZZI DI REGOLAZIONE CINGHIA DENTATA PER FIAT/ALFA/LANCIA

MODELLO	ALFA FIAT LANCIA	ALLA, BARCHETTA, BRAVO, BRAVA, COUPE, DELTA, DEDRA, PUNTO, SPIDER, GT
UTENSILI OEM	1860845000 (1), 1822154000 (2), 1860905000 (3), 1860992000 (4), 1860895000 (5), 1860874000 (6), 1860985000 (7), KM571A (8), 1 860 896 000 (9), 0153A (10)	
CODICE MOTORE	1.2 / 16V, 1.4 / 12V, 1.6 / 16V, 1.6 ECO. 1.8, 2.0 / 16V, 2.0 / 20V, 2.4 / 20V, 3.0 / V6.	



53312

127,00€



KIT DI ATTREZZI DI REGOLAZIONE CINGHIA DENTATA PER FIAT/ALFA/FORD

MODELLO	FIAT: NEW 500 (07-09), IDEA (04-09), LINEA (07-09), GRANDE PUNTO (07-09), DOBLO 1 CARGO (05-09), PANDA EV02 (05) FORD: KA 1.2 DURATEC (09) ALFA ROMEO
UTENSILI OEM	1 860 987 000 (1), 2 000 004 400 (2), 2 000 015 800 (3), 2 000 004 300 (4), 2 000 004 500 (5)
CODICE MOTORE	1.2: 169A4.000 / 199A4.000 . 1.4: 350A 1.000 / 188A4.000-EV02.

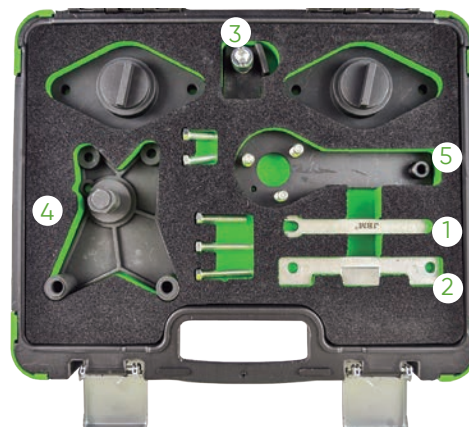

53319

18,00€

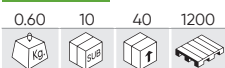

ATTREZZO DI REGOLAZIONE CINGHIA DENTATA PER FIAT IVECO 2.3, 3.0 JTD

MODELLO	FIAT: 2.3 / 3.0 JTD. IVECO: DAILY.
UTENSILI OEM	99360614, 1 860 617 000, 99360615, 2 000 018 200.
CODICE MOTORE	F1AE0481C, F1AE0481D, F1AE0481N, F1CE0481A/D.

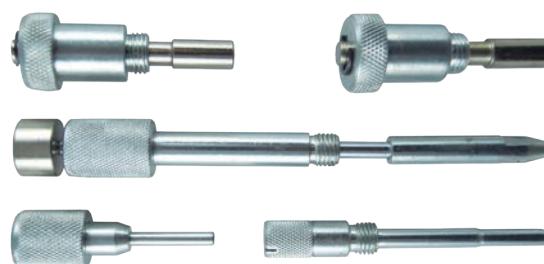

54202

68,00€



KIT DI ATTREZZI I DI CRONOMETRAGGIO DEL MOTORE PER FIAT/ALFA ROMEO/LANCIA

MODELLO	ALFA ROMEO: GIULIETTA (10-14), MITO (08-17). FIAT: 500 (07-19), 500L (12-19), 500C (07-19), 500 ABARTH (08-17), BRAVO (07-14), BRAVA/BRAVO (98-02), DOBLO/DOBLO CARGO (10-19), EGEA (15-20), GRANDE PUNTO (07-10), GRANDE PUNTO ABARTH (07-10), IDEA (04-12), LINEA (07-10), MAREA/WEEKEND (98-00), PALIO WEEKEND (01-06), PANDA (07-11), PUNTO (97-08), STILO (01-08), TIPO (15-20). LANCIA: DELTA (08-12), MUSA (04-13), YPSILON (96-11).
UTENSILI OEM	2.000.004.500 (1), 1.860.985.000 (2), 1.860.992.000 (3), 1.860.987.000 (4), 2.000.015.800 (5)
CODICE MOTORE	1.2 16V:176B9.000, 182B2.000, 188A5.000. 1.4 16V / T-JET: 169A3.000, 192B2.000, 198A1.000, 198A4.000, 199A6.000, 198A8.000, , 312A1.000, 312A3.000, 843A1.000, 955A1.000.



54203

91,00€



KIT DI ATTREZZI DI CRONOMETRAGGIO DEL MOTORE PER ALFA ROMEO/LANCIA 1.8 TBI

MODELLO	ALFA ROMEO: 159(09-12), BRERA(09-11), GIULIETTA(10-19), SPIDER(09-11), 4C(13-19). LANCIA: DELTA(09-14).
UTENSILI OEM	2 000033500 (1), 2000 003000 (2), 1860898 000 (3).
CODICE MOTORE	ALFA ROMEO 1,75 TBI: 939B1.000, 940A1.000, 940B2.000, 960A1.000 LANCIA 1,75 DI TURBO JET: 939B1.000

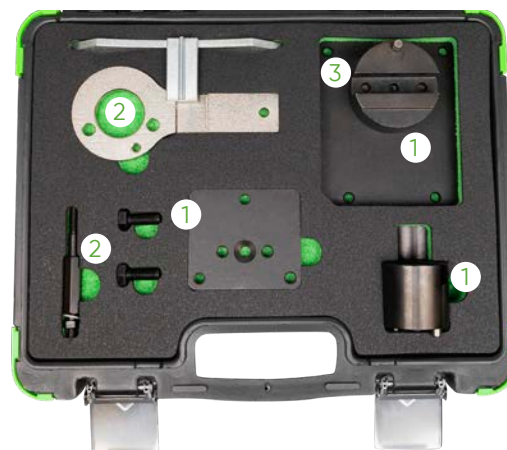

54211

74,00€



KIT DI ATTREZZI DI CRONOMETRAGGIO DEL MOTORE PER FIAT/FORD/OPEL/SUZUKI 1.3L

MODELLO	FIAT: PUNTO (2003-2007) / PANDA (2003-2009) / IDEA (2004-2006) / DOBLO (2004-2006). FORD: KA. VAUXHALL / OPEL: AGILA (2003-2008) / CORSA C (2003-2007) / CORSA D (2006-2009) / COMBO C (2003-2009) / ASTRA H (2004-2009) TIGRA B (2004-2009) / MERIVA (2004-2009). SUZUKI: IGNIS (2003-2009) / WAGON R (2003-2009) / SWIFT (2003-2010).
UTENSILI OEM	1871000200 / 303-1469 / KM-662-C (1), EN 46785 / KM 955 / 09912-38300 (2), 1871000900 / 1860985000 / 303-1472 / EN 46781 / 09917-68610 (3), 1870900400 (4), 1870900300 / 303-1468 (5)
CODICE MOTORE	FIAT: 1.3 JTD 188A9.000 / 169A.000 / 188A8.000 / 199A3.000. FORD: 1.3 TDCI. VAUXHALL / OPEL: 1.3 CDTI Z13DT / Z13DTH / Z13DTJ. SUZUKI: 1.3 CDTI Z13DT.

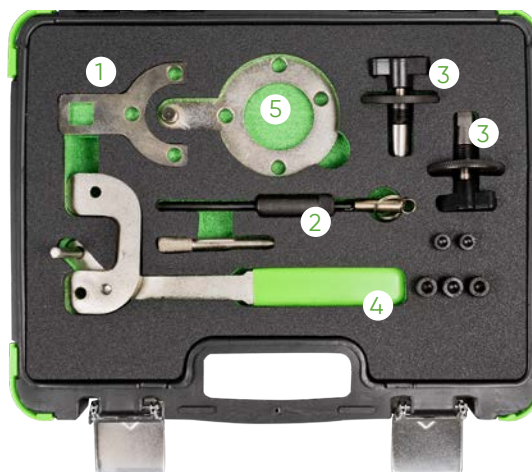

54212

39,40€



KIT DI ATTREZZI DI CRONOMETRAGGIO DEL MOTORE PER FIAT/LANCIA 1,4 12V

MODELLO	MAREA/MAREA_WEEKEND(96-20), BRAVA(95-98), BRAVO(95-98). LANCIA: YPSILON(96-20)
UTENSILI OEM	1860899000 (1), 1860901000 (2)
CODICE MOTORE	1.4 12V : 182A3.000, 182A5.000.



54215

57,00€

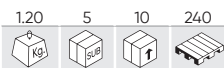

KIT DI ATTREZZI DI CRONOMETRAGGIO DEL MOTORE PER ALFA ROMEO/FIAT 1.4 MULTIAIR

MODELLO	ALFA ROMEO GIULIETTA, MITO / FIAT PUNTO, PUNTO EVO 1.4 (TURBO) MULTIAIR (105/135/163/170PS)
UTENSILI OEM	ALFA ROMEO / FIAT: 1860987000 (1), 2000034400 (2), 2000004500 (3)
CODICE MOTORE	940A2.000 / 940A2.000 / 955A8.000 / 955A8.000 / 940A2.000 / 955A8.000 / 955A2.000 / 955A7.000 / 955A6.000 / 955A8.000



54216

49,00€

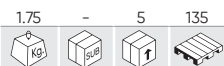

KIT DI ATTREZZI DI CRONOMETRAGGIO DEL MOTORE PER FIAT/OPEL/ALFA 1.9, 2.4L 16V

MODELLO	OPEL 1.9, ALFA-ROMEO 1.9-2.4 L DIESEL, FIAT 1.9- 2.4 L DIESEL
UTENSILI OEM	OPEL EN-46788 / FIAT 1.860.905.000 / 1.860.905.010 (1) FIAT 1.860.898.000 (2) OPEL EN-46789 / FIAT 1.870.896.900 (3) OPEL KM 6130 / KM 6349 (4)
CODICE MOTORE	OPEL 1.9 CDTI Z19DT, Z19DTH, Z19DTJ ALFA-ROMEO 1.9 Y 2.4 L : 323.02, 371.01, 342.02, 325.01, 362.02, 182B9.000, 937A2.000, 937A3.000, 192A5.000, 192B1.000, 937A4.000, 937A5.000, 939A2.000, 939A1.000, 939A7.000, 939A8.000, 839A6.000, 841C.000 FIAT 1.9 Y 2.4 L : 182B4.000, 182B9.000, 185A6.000, 186A6.000, 186A8.000, 186A9.000, 188A2.000, 188A7.000, 188B2.000, 192A1.000, 192A3.000, 192A5.000, 192A8.000, 192A9.000, 192B4.000, 192B5.000, 198A2.000, 198A3.000, 198A6.000, 199A5.000, 223A7.000, 937A5.000, 939A1.000, 939A2.000, 939A3.000, 939A7.000



54430

34,00€

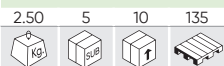

KIT DI MESSA IN FASE PER ALFA ROMEO/FIAT/LANCIA 0.9 TWIN AIR

MODELLO	ALFA ROMEO: MITO (2001-2018) CHRYSLER: YPSILON (2011-2015) FIAT: 500/500C (2010-2020), 500L/500L LIVING/500L MPW (2012-2018), PUNTO (2012-2018), PANDA (2012-) LANCIA: YPSILON (2011-2018)
UTENSILI OEM	2 000 035 100 (1) 2 000 035 200 (2) 2 000 035 300 (3)
CODICE MOTORE	Q.9: 199B6.000, 199B7.000, 312A2.000, 312A4.000, 312A5.000, 312A6.000, 312A7.000



53259

97,00€

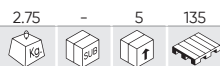

KIT DI ATTREZZI PER MONTAGGIO/FISSAGGIO MOTORI BMW N42, N46 1.8, 2.0 CON TRASMISSIONE A CATENA

MODELLO	BMW 1 SERIES: 118I E81/82/87/88 (04-14), 120I E81/82/87/88 (04-14). BMW 3 SERIES: 316I/TI COMPACT E46 (01-07), 318I/TI COMPACT E46 (01-07), 318I, E90/91/92/93 (05-12), 320I E90/91/92/93 (05-12). BMW 5 SERIES: 520I E60/61 (07-10), Z4 2.0 E85/86 (04-09). BMW X SERIES: X1 SDRIVE 18I E84 (10-12), X1 XDRIVE 18I E84 (10-12), X3 2.0 E83 (05-10).
UTENSILI OEM	119350 (1), 119340 (2), 119291 (3), 119292 (4), 119270 (5), 115120 (6), 119190 (7), 119293 (8)
CODICE MOTORE	1.8: N42; B18A, N46; B18. / 2.0: N42; B20A, N46; B20, B20B, N46T; B20, B20B, B20BD, B20BZ, B20O2, B2O2.



53260

168,00€



KIT DI ATTREZZI PER MONTAGGIO/FISSAGGIO MOTORI A BENZINA BMW N43 1,6/2,0 CON TRASMISSIONE A CAT

MODELLO	BMW 1 SERIES: 116I E81/82/87/88 (07-12), 118I E81/82/87/88 (06-14), 120I E81/82/87/88 (06-14). BMW 3 SERIES: 316I E90/91/92/93 (07-11), 318I E90/91/92/93 (07-13), 320I E90/91/92/93 (07-14). BMW 5 SERIES: 520I E60/61 (07-10).
UTENSILI OEM	118690 (118691/118692/118693) (1), 118710 (118711/118712) (2), 113340 (3) (4), 118700 (5), 119340 (119341/119342) (6), 115120 (7).
CODICE MOTORE	1.6: N43 B16A/AA, B16AA, B16AA/OO. 2.0: N43 B20A, B20A/AA, B20AA, B20AY, B20KO, B20UO.

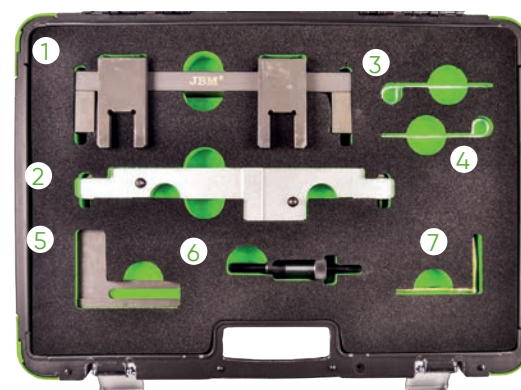

53261

214,00€

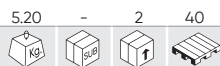

KIT DI ATTREZZI PER FISSAGGIO BMW N42, N46 1.8, 2.0

MODELLO	BMW 1 SERIES: 118I E81/82/87/88 (04-14), 120I E81/82/87/88 (04-14). BMW 3 SERIES: 316I/TI COMPACT E46 (01-07), 318I/TI COMPACT E46 (01-07), 318I E90/91/92/93 (05-12), 320I (E90/91/92/93 (05-14). BMW 5 SERIES: 520I E60/61 (07-10). BMW X SERIES: X1 E84 SDRIVE 18I (10-12), X1 E84 XDRIVE 18I (10-12), X3 E83 2.0 (05-10). BMW Z SERIES: Z4 2.0 E85/86 (04-09).
UTENSILI OEM	119190 (1), 119310 (2), 119302 (3)
CODICE MOTORE	2.0: N42 B18A, N42 B20A, N46 B18, N46 B20, N46 B20B, N46T B20, N46T B20B, N46T B20BD, N46T B20BZ, N46T B20O2, N46T B2O2

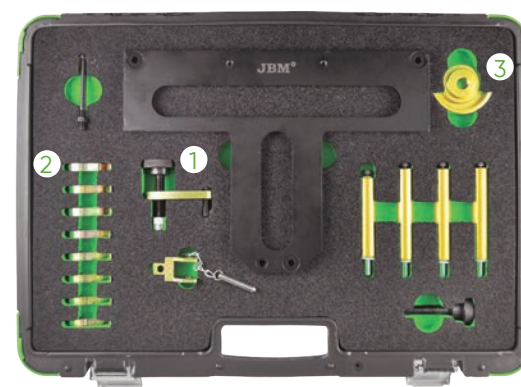

53262

251,00€

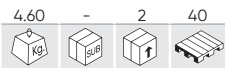

KIT DI ATTREZZI DI REGOLAZIONE ALBERO A CAMME PER BMW M52TU, M54, M56 CON SISTEMA DOUBLE VANOS

MODELLO	<p>M52TUB25: 1997-2001 E46 323i/323Ci/323Ti (M52T); 1998-2001 E39 523i (M52TU); 1998-2001 E36/7 Z3 (M52TU).</p> <p>M52TUB28: 1997-2001 E46 328i/328Ci (M52TU); 1997-2001 E36/7 Z3 2.8 (M52B28/Z3); 1998-2001 E39 528i (M52TU); 1998-2001 E38 728i (M52TU).</p> <p>M54B22: 2001-2003 E46 320i/320Ci; 2001-2003 E39 520i; 2001-2002 E36 Z3 2.2i; 2003-2005 E85 Z4 2.2i; 2003-2005 E60/E61 520i.</p> <p>M54B25: 2001-2002 E36/7 Z3 2.5i; 2001-2005 E46 325i/325Xi; 2001-2006 E46 325Ci; 2001-2004 E46 325Ti; 2001-2004 E39 525i; 2003-2004 E60/E61 525i/525Xi; 2004-2006 E83 X3 2.5i; 2004-2006 E85 Z4 2.5i.</p> <p>M54B30: 2001-2005 E46 330i/330Xi; 2001-2006 E46 330Ci; 2001-2003 E39 530i/2001-2002 E36 Z3 3.0i; 2003-2005 BMW E60 530i; 2003-2006 E85 Z4 3.0i; 2001-2006 E53 X5 3.0i.</p>
UTENSILI OEM	116150 (1), 113450 (2), 113292 (3), 116180 (4), 114220(5)



53263

57,00€

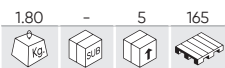

KIT DI ATTREZZI DI REGOLAZIONE ALBERO A CAMME PER BMW M47 LAND ROVER TD4,TD6

MODELLO	<p>BMW 1 SERIES: 118D E87 (04-07), 120D E87 (04-07).</p> <p>BMW 3 SERIES: 318D/TD COMPACT E46 (01-05), 318D/TD E90/91 (05-08), 320D/TD COMPACT E46 (98-05), 320D/CD E90/91 (05-08), 325D E90/91/92/93 (02-10), 330D/CD E46/90/91/92/93 (99-07), 335D E90/91/92 (06-11).</p> <p>BMW 5 SERIES: 520D E39/60/61 (00-09), 525D/XD E39/60/61 (00-10), 530D/XD E46/60/61 (98-10), 535D E60/61 (04-10).</p> <p>BMW 6 SERIES: 635D E63/64 (07-11).</p> <p>BMW 7 SERIES: 730D/LD E38/65/66 (98-08).</p> <p>BMW X SERIES: X3 2.0D E83 (04-07), X3 3.0D/SD E83 (03-10), X5 3.0D E53/E70 (00-10), X6 3.0D E71/72 (08-10), X6 3.5D E71/72 (08-10).</p> <p>LAND ROVER: FREELANDER TD4 (00-06), RANGE ROVER TD6 (02-06).</p> <p>MG/ROVER: MG-ZT/T (01-05), ROVER 75 CDT/CDTI (99-05).</p> <p>VAUXHALL/OPEL: OMEGA-B (01-03).</p>
UTENSILI OEM	112300/12-108, 12-171/KM-813 (1), 113340/12-172/KM-823 (2) (3), 116322/12-174/KM-6267 (4) 116320 (5)
CODICE MOTORE	<p>BM - 2.0D: M47, M47T2, M47TU / 2.5D: M57, M57T2, M57TU / 3.0D: M57, M57T2, M57TU</p> <p>LAND ROVER - 2.0D: 204D3 (TD4) / 3.0D: 306D1 (TD6)</p> <p>MG/ROVER- 2.0D: M47R / 2.0D CDT: M47R</p> <p>VAUXHALL/OPEL- 2.5D: Y25DT</p>



53264

143,00€



KIT DI ATTREZZI PER FISSAGGIO E REGOLAZIONE ALBERO A CAMME PER BMW N62, N73

MODELLO	<p>BMW 5 SERIES: 540i E60/61 (05-10), 545i E60/61 (03-06), 550i E60/61 (05-10).</p> <p>BMW 6 SERIES: 645i E63/64 (03-06), 650i E63/64 (05-11).</p> <p>BMW 7 SERIES: 735i E65/66 (02-05), 740i E65/66 (05-10), 745i E65/66 (02-05), 750i E65/66 (05-08), 760i E65/66 (02-08).</p> <p>BMW X SERIES: X5 4.4 E53 (03-07), X5 4.8 E53/E70 (04-10).</p>
UTENSILI OEM	119463 (1), 119462 (2), 119340 (3), 119461 (4), 119190 (5)
CODICE MOTORE	<p>3.6 V8: N62 B36A 4.4 V8: N62 B44A</p> <p>4.0 V8: N62 B40A 4.8 V8: N62 B48B 6.0 V12: N73 B60A</p>

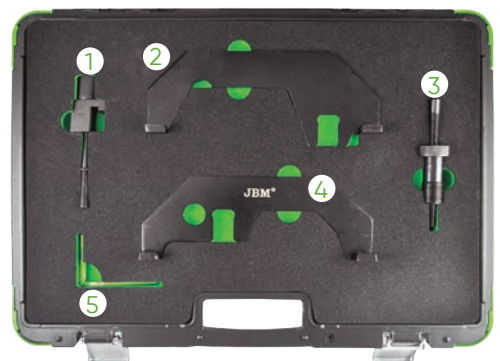

53265

195,00€



KIT DI ATTREZZI PER FISSAGGIO E REGOLAZIONE ALBERO A CAMME PER BMW DIESEL M47, M57, M41, M51

MODELLO	BMW
UTENSILI OEM	113360 (1), 116321 (2), 135190 (3), 135191 (4), 135192 (5), 116322 (6), 112300 (7), 113340 (8)
CODICE MOTORE	M41 / M51 / M47TU / M47TU T2. M57TU T2 3.01 1998 - 2008.

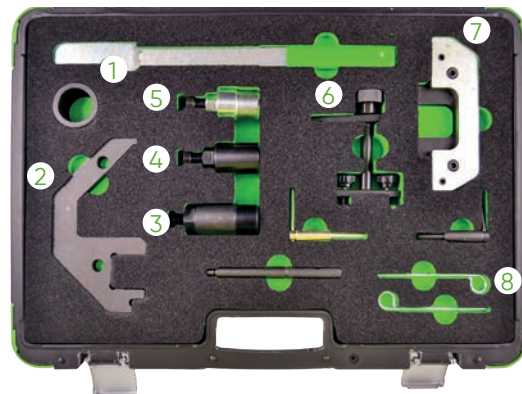

53266

224,00€

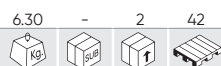

KIT DI ATTREZZI DI REGOLAZIONE CINGHIA DENTATA PER BMW M42, M43, M50, M51, M52

MODELLO	BMW
UTENSILI OEM	113240 (1), 115490 (2), 113190 (3), 112300 (4) (5), 113292 (6), 113320 (7)
CODICE MOTORE	PETROL: M42, M43, M50, M52, M60. DIESEL: M51

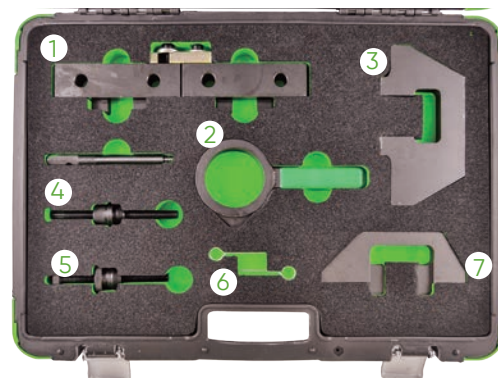

53267

277,00€



KIT DI ATTREZZI DI REGOLAZIONE CINGHIA DENTATA PER BMW M40, M43, M42, M44, M52, M54, M56

MODELLO	BMW SERIES: 3, 5, 7, X, Z
UTENSILI OEM	114220 (1), 112300 (2), 113240 (3), 115490 (4), 113292 (5), 113450 (6)
CODICE MOTORE	M40. M44. M50. M52. M54. M56.

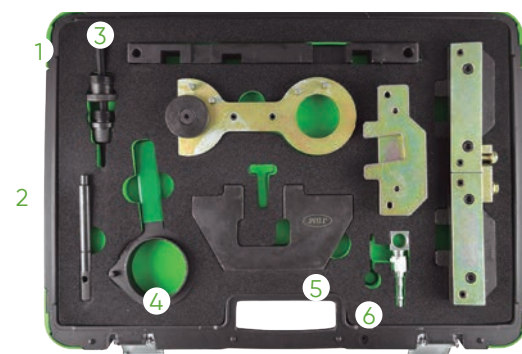

53269

50,00€

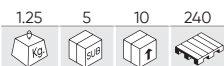

KIT DI ATTREZZI DI REGOLAZIONE CINGHIA DENTATA PER BMW N47, N47S, N57

MODELLO	<p>BMW 1 SERIES: 116D E81/82/87/88 (08-12), 118D E81/82/87/88 (07-14), 120D E81/82/87/88 (07-14), 123D E81/82/87/88 (07-14).</p> <p>BMW 2 SERIES: 218D (11-14), 220D (11-14), 225D (11-14).</p> <p>BMW 3 SERIES: 316D E90/91/92/93 (09-12), 318D E90/91/92/93 (07-12), 320D E90/91/92/93 (07-12), 325D E90/91/92/93 (10-14), 330D/XD E90/91/92/93 (08-14).</p> <p>BMW 5 SERIES: 520D E60/61 (07-10), 525D F10/11 (10-12), 530D F10/11 (10-13), 530DGT F07 (09-12), 535D F10/11 (10-17), 535DGT F07 (10-12).</p> <p>BMW 7 SERIES: 730D/LD F01/02/04 (08-12), 740D F01/02/04 (09-12), 740D XDRIVE F01/02/04 (09-12), 750D XDRIVE F01/02/04 (12-15).</p> <p>BMW X SERIES: X1 SDRIVE 18D E84 (09-15), X1 SDRIVE 20D E84 (09-12), X1 XDRIVE 18D E84 (09-15), X1 XDRIVE 20D E84 (09-15), X1 XDRIVE 23D E84 (09-12), X3 2.0D E83 (07-10), X3 XDRIVE 18D E83 (08-10), X3 XDRIVE 30D E83 (11-12), X3 XDRIVE35D F25 (11-17), X5 3.0D E70 (10-13), X5 XDRIVE 40D X5 F15 M50D (13-17), E70 (10-13), X6 XDRIVE 30D E71/72 (10-14), X6 XDRIVE 40D E71/72 (10-14), X6 F16 M50D (14-17).</p> <p>BMW MINI: PACEMAN (13-17), COUNTRYMAN (10-17), MINI (10-15), ROADSTER (12-14), CLUBMAN (10-14), CLUBVAN (12-14).</p>
UTENSILI OEM	118760 (1), 118740 (2), 116480 (3), 115320 (4)
CODICE MOTORE	<p>1.6 D: N47; C16K1, C16U1.</p> <p>2.0 D: N47; C20K1, C20U1N47; D20, D20A, D20B, D20D, D20K1, D20O0, D20O1, D20T1, D20U0, D20U1, N47S D20T0, N47T; D20, D20O1, D20U1.</p> <p>3.0 D: N57; B30B, B30B/T0, B30C, D30BT0, D30O0, D30O1, D30T0, D30T1, D30U0.</p>



54206

113,00€



KIT DI ATTREZZI DI CRONOMETRAGGIO DEL MOTORE PER BMW/MINI 1.5 , 2.0L

MODELLO	<p>BMW</p> <ul style="list-style-type: none"> - 1 SERIES - 114D, 116D, 214D - (F20/ 21) - (2015- 2017) - 2 SERIES - 216D, 118D, 125D - (F22/ 23/ 45/ 46) - (2014-2017) - 3 SERIES - 218D, 220D, 225D - (F30/31/34) - (2015-2017) - 4 SERIES - 316D/320D/325D - (F32, 33, 36) - (2015-2017) - 5 SERIES - 420D, 425D, 418D - (F10, 11) - (2014-2017) - X1 SERIES - 518D - (F48) - (2015-2017) - X3 SERIES - (F25) - (2014-2017) - EFFICIENT DYNAMICS - X4 SERIES - (F26) - (2014-2017) - XDRIVE - X5 SERIES - (F15) - (2015-2017) - SDRIVE <p>MINI</p> <ul style="list-style-type: none"> - CLUBMAN - (F54) - (2015-2017) - ONE D CONVERTIBLE - (F57) - (2016-2017) - COOPER D/ SD MINI HATCH (F55, 56) - (2014-2017)
UTENSILI OEM	114120 (1), 2347904 (2), 2365488 (3), 2288380 (4), 118760 (5), 118740, 118030 (6)
CODICE MOTORE	<p>1.5: B37 D15A, B37 C15A</p> <p>2.0: B47 D20A, B47 D20B, B47 C20A, B47, B47 C20B</p>



IL TUO KIT DI MESSA IN FASE
ANCORA PIÙ VICINO

- ✓ INSERISCI NELLA PAGINA WEB IL CODICE DEGLI ATTREZZI OEM O IL CODICE DEL MOTORE DELLA TUA AUTO E TROVA IL KIT COMPATIBILE



54219

60,00€

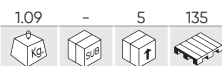

KIT DI STRUMENTI DI CRONOMETRAGGIO DEL MOTORE PER BMW/MINI/CITROËN/PEUGEOT

MODELLO	BMW MINI PSA
UTENSILI OEM	115140 (1), 119280 (2), 119330 (3), 113340 (4), 114360 (5)
CODICE MOTORE	BMW 1.6 (N40 / N45 / N45T, B16, B16A, B16AC) 1.8 / 2.0 (N42 / N46 / N46T) 2.0 / 3.0 (N51 / N52 / N52-COMPONENTE / N53 / N54) PSA 1.4 / 1.6 16V (EP3 / EP6 / EP6DT / EP6DTS) MINI 1.4 / 1.6 (N12 / N14)



54222

59,00€

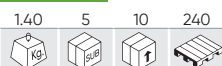

KIT DI ATTREZZI DI CRONOMETRAGGIO DEL MOTORE MINI 1.6

MODELLO	BMW: MINI COOPER S(07-10) PEUGEOT: 207(06-10), 307(06-10), GT(06-10), THP(06-10), GTI(06-10) CITROËN: DS3(06-10), C4(06-10), GRANDE PICASSO TPH(06-10)
UTENSILI OEM	119550(1), 119551(2), 119552(3), 119590(4)
CODICE MOTORE	N14 B16A , N14 B16CD , N14 B16TO



54227

122,00€



KIT DI ATTREZZI DI CRONOMETRAGGIO DEL MOTORE BMW/MINI N13, N18, PSA

UTENSILI OEM	EN-52127-2, EN-52588, E1 100, G 1376A, T10550/2, T10550/3, 0 496 709, 0109 2B, 0197 A11, 0197 A3, 0197 A31, 0197-A1, 0197-A1Z, 0197-A11, 0197A2, 0197-A31, 0197-A32, 0197-A33, 0197-BZ, 0197-M, 0197-N, 11 7 440 (1), 11 9 340 (2), 11 9 540, 11 9 551, 11 9 590, 1376-A, 2 299 362 (3)
CODICE MOTORE	N12 B14A, N13 B16A, N14 B16A, N14 B16C, N16 B16A, N18 B16A, N18 B16C, 5FA (EP6CDT), 5FD (EP6DTS), 5FE (EP6CDT), 5FE (EP6CDTM), 5FF (EP6DTS), 5FG (EP6CDTR), 5FH (EP6C), 5FK (EP6C), 5FK (EP6CB), 5FL (EP6C), 5FM (EP6CDTM), 5FN (EP6CDT), 5FP (EP6), 5FR (EP6DTE), 5FS (EP6C), 5FT (EP6DT), 5FU (EP6CDTX), 5FV (EP6CDT), 5FW (EP6), 5FX (EP6DT), 5FY (EP6DTS), 5GF (EP6FADTX), 5GF (EP6FADTXD), 5GG (EP6FADTX), 5GM (EP6FDTX), 5GN (EP6FDTR), 5GP (EP6FDTR), 5GR (EP6FDTX), 5GT (EP6FDTX), 5GW (EP6FDT), 5GY (EP6FADTXD), 5GY (EP6FDT), 5GY (EP6FDTM), 5GZ (EP6FDT), 8FN (EP3C), 8FP (EP3C), 8FR (EP3C), 8FS (EP3)



54228

187,00€

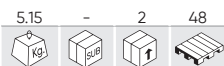

KIT DI ATTREZZI DI CRONOMETRAGGIO DEL MOTORE PER BMW/MINI 1.2, 1.5, 2.0, 3.0

MODELLO	BMW: 1 SERIES (2015 - 2019), 2 SERIES (DESDE 2014), 3 SERIES (DESDE 2015), 4 SERIES (DESDE 2015), 5 SERIES (DESDE 2017), 6 SERIES (DESDE 2017), 7 SERIES (DESDE 2015), i8 (DESDE 2014), X1 (DESDE 2015), X2 (DESDE 2018), X3 (DESDE 2017), X4 (DESDE 2018) AND Z4 (DESDE 2019); MINI: CLUBMAN (DESDE 2015), HATCH (DESDE 2014), CONVERTIBLE (DESDE 2016) AND COUNTRYMAN (DESDE 2017)
UTENSILI OEM	2 358 122 (1), 2 357 904 (2), 2 365 488 (3), 2 288 380 (4), 11 4 120 (5).
CODICE MOTORE	BMW: 1,5 B38 A15A, B38 B15A, B38 K15A ,1,6 B48 B16A, 2,0 B48 A20A, B48 A20B, B48 A20E, B48 B20A, B48 B20B , 3,0 B58 B30A, B58 B30B, B58 B30C MINI: 1,2 B38 A12A , 1,5 B36 A15A, B38 A15A , 2,0 B46 B20A, B48 A20A, B48 A20B



54293

17,50€

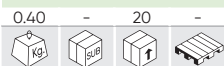

SUPPORTO CONTROLBERO MOTORE PER BMW

N

MODELLO	BMW 1 SERIES E81/82/87/88: 116D (2008-2012),118D (2007-2012),120D (2007-2014), 123D (2007-2014) BMW 1 SERIES E22: 218D (2011-2014), 220D (2011-2014), 225D (2011-2014) BMW 3 SERIES E90/91/92/93: 316D (2007-2012), 318D (2007-2014),320D (2007-2012), 325D (2010-2012), 330D (2008-2014) BMW 5 SERIES E60/61: 520D (2007-2010) BMW 5 SERIES F10/11: 525D (2010-2013), 530D (2010-2013),530D XDRIVE (2011-2015), 535D (2010-2013), 535D XDRIVE (2011-2015),M550D XDRIVE (2012-2015) BMW 5 SERIES E07: 535D GT (2009-2015) BMW 7 SERIES F01/02/04: 730D (2008-2012), 740D (2009-2012),750D XDRIVE (2012-2015) BMW X1 E84: 18D SDRIVE (2009-2015), 20D SDRIVE (2009-2015), 18D XDRIVE (2009-2015), 20D XDRIVE (2009-2015), 23D XDRIVE (2009-2012) BMW X3 E83: 2.0D (2007-2008), 18D XDRIVE (2008-2010) BMW X5 E70: 3.0D XDRIVE (2010-2013), 40D (2010-2013) BMW X6 E71/71: 30D XDRIVE (2010-2014), 40D XDRIVE (2010-2014)
UTENSILI OEM	T10016
CODICE MOTORE	2,0: N47D20C, N47D20D 2,0D: N47; D20A, D20A/KO, D20B, D20B/TO, D20C,D20O0, D20O1, D20U0, D20U1 D20K1 3,0D: N57; D30U0, D30O0, D30O1, D30T0, D20T0,D30A, D30A/O0, D30B , D30B/T1, D30C, D30C/ S1,D30A0/O0, D30A0/O1



54398

41,00€



SET DI BLOCCAGGIO DELLA PULEGGIA DELL'ALBERO MOTORE/DEL VOLANO PER BMW/MINI

N

MODELLO	MINI HATCH (14-21), CABRIOLET (16-19), CLUBMAN (15-19), COUNTRYMAN (17-19)
UTENSILI OEM	11 6 480 (1) 11 9265 (2) 11 4 180 (3) 11 9 810 (4) 11 9 811 (4)
CODICE MOTORE	BMW: 116i (15-19), 116d (15-19), 118d (15-19), 120d (15-19), 125d (15-19), M140i (16-19), 214d (15-19), 216i (18-19), 216d (14-20), 218d (17-19), 218i (15-21), 220d, (14-20), 225d (15-20), M240i (16-19), 316d (15-19), 318i (15-19), 320d (15-19), X1 (15-20),X2 (18-19), X3 (14-18), X4 (17-20), X5 (15-18), i8 (14-18) 325d (16-20),330i (15-20), 340i (15-19), 418i (15-20), 420d (15-20), 425d (16-18), 430i (16-20),440i (16-19), 518d (14-17), 525d (17-20), 530i (17-18), 540i (17-19), 620d (18-20), 630i (17-19), 640i (17-19), 725d (16-19), 730i, (15-19), 740i (15-19)



54399

56,50€



N

KIT DI MESSA IN FASE PER BMW/ROVER/OPEL 2.5D

MODELLO	BMW: 318TDS (94-00) , 325TD (91-99) , 325TDS (91-99) , 525TD (90-03) , 525TDS (90-03) , 725TDS (95-02) RANGE ROVER: P38 (94-02) VAUXHALL/OPEL: OMEGA-B (94-01)
UTENSILI OEM	KM811 (1), 113320 (1), 12112 (1) KM822 (2), 113360 (2), 12115 (2) KM813 (3), 115120 (3), 112300 (3), 12108 (3) KM823 (4), 113340 (4), 12172 (4)
CODICE MOTORE	256T, 25DT, M41/174T1, M51/256T1, M51/256T1L, X25DT

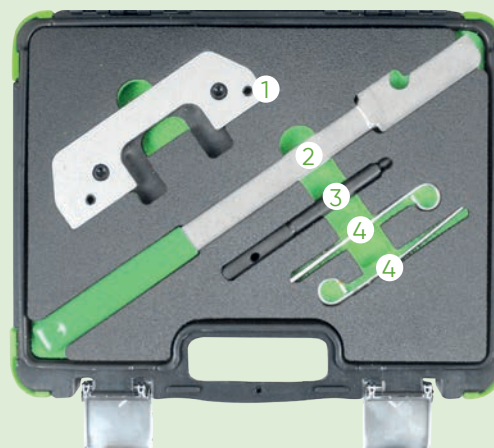

54400

141,00€



N

KIT DI MESSA IN FASE PER BMW N20, N26

MODELLO	BMW: 1 SERIES 125I - F20/21 (2012-2016) 2 SERIES COUPE 220I, 228I - F22 (2014-2016) 2 SERIES CABRIOLET 220I 228I - F23 (2015-2016) 3 SERIES 320I 328I XDRIVE - F30/31 (2012-2015) 3 SERIES GRAN TURISMO 320I, 328I/XDRIVE - F34 (2013-2016) X4 XDRIVE 20I, 28I (F26) 2014 - 2018, X5 XDRIVE40E (F15) 2015 - 2018, Z4 SDRIVE18I, 20I, 28I (E89) 2011 - 2017 4 SERIES COUPE 420I, 428I/XDRIVE - F32(2013-2016), 4 SERIES CABRIOLET 420I, 428I/XDRIVE-F33 (2014-2016) 4 SERIES GRAN COUPE 420I, 428I/XDRIVE F36 (2014-2016) 5 SERIES 520I, 528I/XDRIVE(F10/11) 2010 - 2017, 5 SERIES GRAN TURISMO 528I-(F07) 2013 - 2016, X1 SDRIVE16I, 18I, 20I, XDRIVE20I, 28I-(E84) 2011 - 2015, X3 SDRIVE18I, 20I, XDRIVE20I, 28I (F25) 2011 - 2017
UTENSILI OEM	11 9 340/341 (1), 11 9 340A (1), 11 9 341 (1), 119340 (1) 2 212 830 (2) 2 212 831 (3) 2 219 548 (4)
CODICE MOTORE	1,6 N20 B16A 2,0 N20 B20 N20 B20A N20 B20A N20 B20B N20 N20B/UO N20 B2000 N20 B2000 N26 B20 B26 B20A

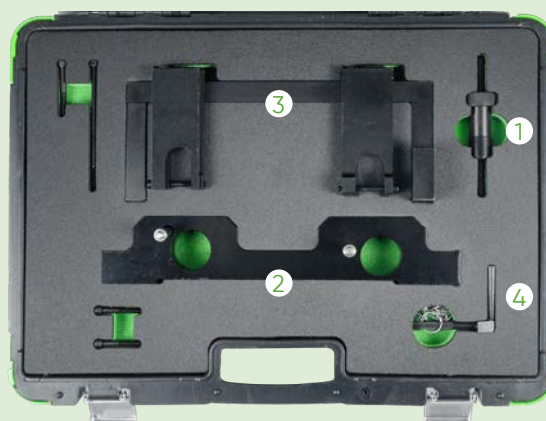

54401

57,00€



N

KIT DI MESSA IN FASE PER BMW/MINI N13, N18

MODELLO	BMW 114i (2012-2015) BMW 116i (2012-2015) BMW 118i (2011-2015) BMW 316i (2012-2015) MINI CLUBMAN (R55) (2011-2014) MINI COOPER S (R56/57) (2010-2015) MINI COUNTRYMAN (R60) (2012-2016) MINI COUPE COOPER S (R58) (2012-2015) MINI PACEMAN (R61) (2013-2017) MINI ROADSTER (R59) (2012-2015)
UTENSILI OEM	11 7 440 (1), 117440 (2), 11 9 340 (3), 11 9 590 (4), 49 6 709 (5)
CODICE MOTORE	N13 B16A N18 B16A N18 B16/MO N18B16A/MO N18B16C N18B16C/TO N18B16MO

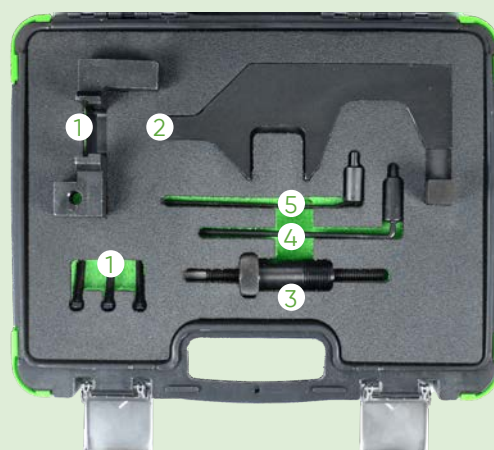

54402

201,00€

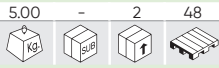

N

KIT DI MESSA IN FASE PER BMW N51, N52, N53, N54, N55

MODELLO	E60: 523i, 523Li, 525i, 525Li, 525Xi, 528i, 528Xi, 530i, 530Li, 530Xi, 535i, 535Xi E61/E63: 523i, 525i, 525Xi, 530i, 530Xi, 535Xi, 630i E64/E65: 630i, 730i E66/E70: 730Li, X5 3.0Si E81/E82: 130i, 135is E83: X3 2.5i, 2.5Si, 3.0i, 3.0Si E85/E86: Z4 2.5i, 2.5Si, 3.0i, 3.0Si, Z4 3.0Si E87/E90: 130i, 323i, 325i, 325Xi, 328i, 328Xi, 330i, 330Xi, 335i, 335Xi E91: 323i, 325i, 325Xi, 328i, 328Xi, 330i, 330Xi, 335i, 335Xi E92: 323i, 325i, 325Xi, 328i, 328Xi, 330i, 330Xi, 335i E93: 325i, 328i, 330i, 335i
UTENSILI OEM	110300 (1) 114280 (2) 114285 (3) 114290 (4) 114390 (5) 118520 (6) 119190 (7) 119340 (8)
CODICE MOTORE	N51/N52/N53/N54/N55

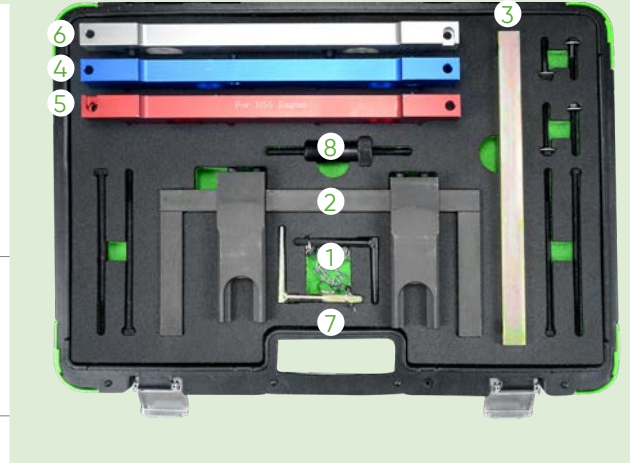

54403

225,00€

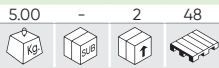

N

KIT DI MESSA IN FASE PER BMW M60

MODELLO	BMW 5 SERIES: 530i, 540i (E34) (1992 – 1996), 535i, 540i (E39) (1996 – 2003) BMW 7 SERIES: 730i, 735i, 740i (E38) (1994 – 2002), 730i, 740i (E32) (1992 – 1994) BMW 8 SERIES: 840i (E31) (1993 – 1999) LAND ROVER/RANGE ROVER: (L322) (2002 – 2005) XS: 4.4, 4.6 (E53) (1999 – 2004)
UTENSILI OEM	11 2 445 (1), 11 2 441/445 (1), LRT -12 223/2 (1) 11 2 441 (2), 12 223/1 (2), LRT 12-223/1 (2) 11 2 442 (3), 11 2 442/446 (3), 12 223/3 (3), LRT 12 223/3 (3) 11 2 446 (4), 12 223/4 (4), LRT 12 223/4 (4), LRT 12 224 (4) 11 3 390 (5), 113390/117380 (5), 12 222 (5), LRT 12 222 (5) 11 5 180 (6), 12 227 (6), LRT 12 227 (6) 11 2 300 (7), 11 5 120 (7), 12 108 (7), 12 171 (7), KM 813 (7), LRT 12 108 (7), LRT 12 171 (7) 11 6 420 (8), 12 226 (8), LRT 12 226 (8) 11 6 452 (9), 12 228/1 (9), LRT 12 228/1 (9) 11 6 451 (10), 12 228/2 (10), LRT 12 228/2 (10) 11 3 310 (11), 12 220 (11), LRT 12 220 (11) 11 6 440 (12), 12 224 (12), LRT 12 224 (12) 11 7 380 (13), 12 221 (13), LRT 12 221 (13)
CODICE MOTORE	BMW 3.0: 30 8S 1 BMW 3.5: 35 8S 1, 35 8S 2 BMW 4.0: 40 8S 1 BMW 4.4: 44 8S 1, 44 8S 2 BMW 4.6: 46 8S 1 RANGE ROVER: V8/44 8S 2



54404

131,00€



N

KIT DI MESSA IN FASE PER BMW N62, N73

MODELLO	SERIES 5, SERIES 6, SERIES 7, X5
UTENSILI OEM	119461 (1), 119462 (2), 119463 (3), 119190 (4), 119340 (5), 119451 (6), 119452 (7), 119453 (8), 119454 (9), 113460 (10), B117207 (11)
CODICE MOTORE	N62 B36A, N62 B40A, N62 B44A, N62 B48A, N62 B48B, N73 B60A

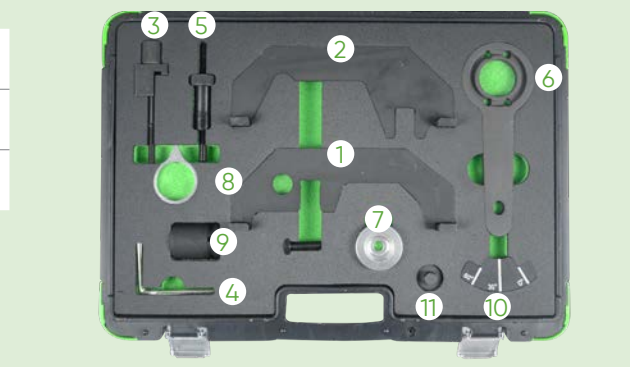

54405

111,00€



N

KIT DI MESSA IN FASE PER BMW N63, N74

MODELLO	SERIES 5, SERIES 6, SERIES 7, X5, X6
UTENSILI OEM	11 9 891 (1) 11 9 892 (1) 11 9 893 (2) 11 9 190 (3) 11 8 090 (4)
CODICE MOTORE	N63, N74

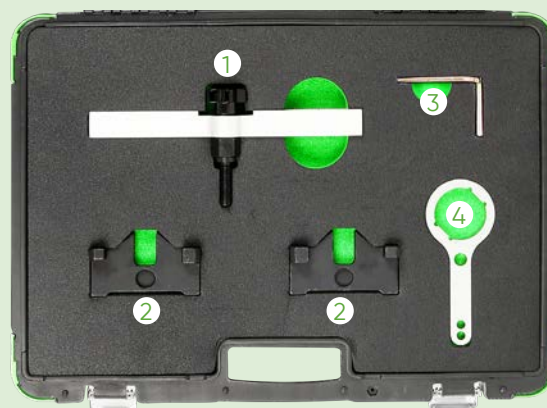

54406

73,00€



N

BLOCCO VOLANTE MOTORE BMW/MINI

MODELLO	<p>BMW 1 SERIES: F20/21 (12-15), 116i (04-12), 118i (04-14), 120i (04-14), 130i (05-07), 135i (07-11), 116D (08-12), 118D (04-14), 120D (04-14), 123D (07-14), M COUPE (11-12)</p> <p>BMW 3 SERIES: F30/31 (12-15), 316Ti (04-14), 316i (04-11), 316D (09-12), 318i (04-07), 318Ti/COMPACT (04-04)</p> <p>BMW 3 SERIES: 318D (03-12), 318TD (03-07), 320D (01-07), 320D COMPACT (01-05), 318i (05-13), 320D (07-14), 320i (05-14), (05-14), 320Si (05-06)</p> <p>BMW 3 SERIES: 323i (05-11), 325i (05-14), 325D (06-10), 330D (05-08), 330i (06-13), 335D (05-13), 335i (05-11)</p> <p>BMW 4 SERIES: 420i F32 (13-15), 428i F32 (13-15), 420i F33 CABRIOLET (14-15), 428i F33 CABRIOLET (14-15), 420i F36 (14-15), 428i F36 GRAN COUPE (14-15)</p> <p>BMW 5 SERIES: F10/11 (10-15), 520D (05-10), 520i (07-10) 523i (03-10), 525D (05-10), 525i (05-10), 525i (07-10), 530D (03-10), 530i (05-10), 535D (04-10)</p> <p>BMW 6 SERIES: 630i (04-11), 635D (07-11)</p> <p>BMW 7 SERIES: 730D (05-08), 730i (02-08) BMW X SERIES: X1 E84 (09-15), X3 E83 (03-14), X5 E53 (03-14), X3 F25 (11-15), X6 E71/72 (08-10)</p> <p>BMW Z SERIES: Z4 E85/86 (04-09), Z4 (E89) (11-15)</p> <p>MINI: MINI (03-06)</p>
UTENSILI OEM	11 8 180 (1), 11 8 181 (2), 11 8 182 (3), 11 8 183 (4), 11 8 184 (5), 11 8 185 (6)
CODICE MOTORE	BMW: M47T2, M57T2, M67, N43, N45, N45T, N46, N46T, N47, N51, N52, N53, N54 MINI: W17 DIESEL



54324

11,00€



N

INDICATORE DI USURA DELLA CATENA DI DISTRIBUZIONE MINI

MODELLO	MINI: CLUBMAN (2007-2014), CLUBVAN (2012-2014), COUNTRYMAN (2010-2017), COUPÉ (2011-2015), MINI (2006-2015), PACEMAN (2013-2017), ROADSTAR (2012-2015)
UTENSILI OEM	2353281 (1)
CODICE MOTORE	1.4: N12 B14AB, N12 B14 1.6: N12 B16A, N16 B16A, N16 B16MO, N16 B16UO, N16 B16A/MO, N16 B16KO, N16 B16A/MO, N18 B16A, N18 B16A/MO, N18 B16C, N18 B16A/MO, N18, N18 B16MO, N18 B16C/T0



53268

92,00€

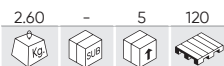

KIT DI ATTREZZI DI REGOLAZIONE CINGHIA DENTATA PER BMW/MINI/PSA 1.4, 1.6

MODELLO	BMW/MINI: MINI CLUBVAN R55 (12-14), MINI CLUBMAN R55 (08-14), MINI COUNTRYMAN R55 (07-10), MINI CLUBMAN R56/R57 (07-15), MINI R56/R57 (08-15), MINI COUPE R58 (11-15), MINI ROADSTER R59 (08-15), MINI CLUBMAN R60 (10-14), MINI CLUBVAN R60 (12-14), MINI ROADSTER R61 (13-15), MINI PACEMAN R61 (14-15), MINI COUNTRYMAN R60 (10-17). CITROËN: C4 (08-11), C4 PICASSO (08-13) C4 GRAND PICASSO (13-15). PEUGEOT: 207 (06-14), 207CC (07-15), 308 (07-15), 3008 (09-15), 5008 (09-15).
UTENSILI OEM	BMW/MINI: 115590 (1), 119340 (2), 119551 (3) CITROËN: 0197-A1, 0197-A3, 0197-B. PEUGEOT: 0197-A1, 0197-A3, 0197-BZ.
CODICE MOTORE	1.4: N12B14, N14B14AB. 1.6: EP3(8FS), EP3C(8FR), EP6(5FW), EP6C(5FS), EP6CDT(5FV), EP6DT(5FT), EP6DT(5FX), EP6DTS(5FY), N14B16A, N14B16CD, N14B16TO, N14B16CD/TO, N16B16A, N16B16KO, N16B16A/MO, N16B16A/MO, N16B16MO, N16B16UO.



53313

139,00€



KIT DI ATTREZZI DI REGOLAZIONE CINGHIA DENTATA PER CITROEN/PEUGEOT

MODELLO	CITROËN: AX, BX, BOXER, BERLINGO, C25, DISPATCH, EVASION, J5, JUMPY, JUMPER, RELAY, SAXO, SYNERGIE, VISA, XM, XSARA, XANTIA, XZ, ZX. PEUGEOT: 106, 205, 206, 305, 306, 307, 309, 405, 406, 605, 607, 806, EXPERT, PARTNER, SOLARA, TALBOT.
UTENSILI OEM	7099TM (1), 0188X (2), 0188P (3), 0189AZ (4), 0188H (5), 0132AJ1 (6), 0189A (7), 0188PM (8), 21-260 (9), 4527-TS1 (10), M8X70 (11), 0188K (12), 0188J (13), 0132Q (14), 4507-TL (15), 4507-TJ (16), 9044-T (17), 4507-TJ (18), 5711-TA (19), 7014-TJ (20), 7017-TR (21), 0188X (22), 7017-TW (23), 7014-TM (24), 0189L (25)

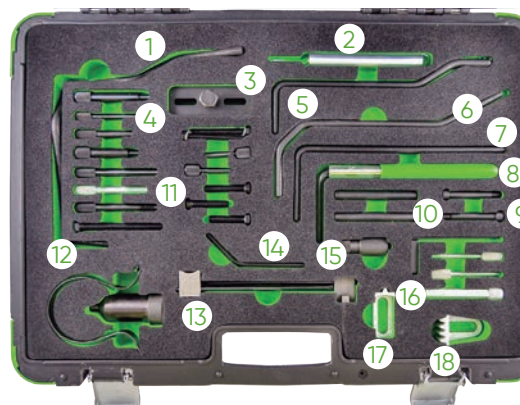

53314

98,00€



KIT DI ATTREZZI DI REGOLAZIONE CINGHIA DENTATA PER CITROEN/PEUGEOT 1.8, 2.0

MODELLO	CITROËN: C4 PICASSO/GRAND PICASSO (06-10), C5 II (04-08), C8 (05-10), DISPATCH/JUMPY (07-11), XSARA 2.0 16V, C5 1.8/2.0/HPI, XSARA PICASSO 1.8/2.0 16V (02-05). PEUGEOT: 406 1.8 16V (00-04), 407 (06-10), 807 2.0 16V (02-05).
UTENSILI OEM	0189S2 (1), 0188J (2), 0188J2 (2), 0189S1 (3), 21-260 (4), 0189B (5), 0188M (6), 0188AH (7), 0189R (8)
CODICE MOTORE	1.8 16V: EW7A(6FY). 2.0 16V: EW10A(RFJ), EW10ABE4(RFH), EW10J4S (RFK).

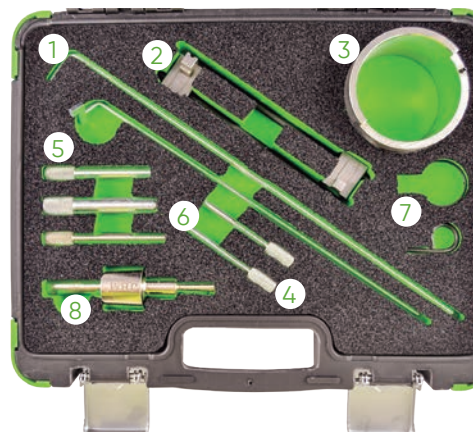

53876

64,00€



KIT DI ATTREZZI DI REGOLAZIONE CINGHIA DENTATA PER CITROËN/PEUGEOT 1.0, 1.2 VTI

MODELLO	CITROËN: C3 (III) PEUGEOT: 208, 308, 2008 SUV (2012-2014)
UTENSILI OEM	0109-2A (1) 0109-2B (2)
CODICE MOTORE	1.0/1.2 VTI. EBO, (ZMZ), EB2, (HMZ)



54288

72,50€

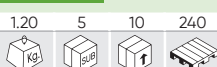

KIT DI MESSA IN FASE PSA 1.2 GDI PURETECH

MODELLO	CITROËN: BERLINGO IV (18-20), C1 II (14-18), C3 III (12-17), C3 IV (16-18), C4 CACTUS (14-20), C4 AIRCROSS (18-20), C-ELYSEE (12-18), DS3 (12-18) PEUGEOT: 108 (14-18), 208 (12-21), 2008 (13-21), 301 (12-20), 308 (13-21), 3008 (16-21), 508 (19-21), 5008 (14-21), PARTNER III (15-18) PARTNER IV (18-21) RIFTER (19-21) TOYOTA: AYGO (14-18) GM: CROSSLAND X (17-20), COMBO E (18-20), GRANDLAND X (17-20)
UTENSILI OEM	CITROËN: G-0109-6 (2), 0109-2B (1), 0109-2C (3), 0109-2D (4), 0197-N (1) PEUGEOT: G-0109-6 (2), 0109-2B (1), 0109-2C (1), 0109-2D (4), 0197-N (1) VAUXHALL: EN-52127-2 (1), EN-52809 (2)
CODICE MOTORE	1.2 VTI: 1PP(HM01), EB2 (HMZ), EB2DTS(HNY), EB2 (HMW), EB2M (HMY), EB2 (HMZ), EB-2DTS(HNY), HMP (EB2FB), HMT(EB2D), HMU(EB2D),HMV (EB2M), HMY (EB2M), HMZ (EB2), HMZ (EB2D), HMZ (EB2F),HMZ (EB2FB) 1.2 E-VTI: HMZ (EB2F), EB2F (HMZ) 1.2 PURETECH THP: HNZ (EB2DT) 1.2 PURETECH VTI: EB2ADS (HNS), EB2D(HMT), EB2ADJ (HNP),EB2ADT (HNK), EB2ADTX (HNN), EB2DTS (HNW), EB2DTM (HNV),EB2DTS (HNW), EB2FA (HMR), EB2FAD (HMH), EB-2FAD (HMM),EB2DT (HNZ), EB2F (HMX), EB2F (HMT), EB2F(HMZ), EB2DTS(HNY),EB2M(HMY)

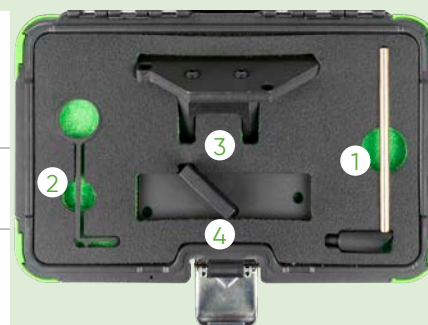

REF. DESCRIZIONE

16400 CALIBRO CONTROLLO CINGHIA DENTATA PSA (RIF.54288)

€ 6,50€

54323

119,00€



KIT DI ATTREZZI DI REGOLAZIONE CINGHIA DENTATA PER PSA 1.0, 1.2 VTI, 1.2 GDI PURETECH

MODELLO	CITROËN: C1 II (2014-2018), C3 III (2012-2017), C3 IV (2016-2018), C4 CACTUS (2014-2020), C4 AIRCROSS (2018-2020), C-ELYSEE (2012-2018), DS3 (2012-2018), BERLINGO IV (2018-2020), GM: CROSSLAND X (2017-2020), COMBO E (2018-2020), GRANDLAND X (2017-2020) PEUGEOT: 108 (2014-2018), 208 (2012-2021), 2008 (2013-2021), 301 (2012-2020), 308 (2013-2021), 3008 (2016-2021), 508 (2012-2021), 5008 (2014-2021), PARTNER III (2015-2018), PARTNER IV (2018-2021), RIFTER (2019-2021) TOYOTA: AYGO (2014-2018).
UTENSILI OEM	EN-52127-2 (1), 0109-2B (1) J-0109-2C (2) J-0109-2D (3) EN-52127-1 (4), 0109-2A21 (4) G-0109-6 (5)
CODICE MOTORE	B12XHL (EB2DT), B12XHT (EB2DTS), D12XHL (EB2ADT), D12XHL (HNP/EB2ADT), D12X-HT (EB2ADTS), EBO (ZMZ), EBOF (ZMZ), EB2ADT (HNK), EB2ADT (HNP), EB2ADTD (HNK), EB2ADTS (HNS), EB2ADTX (HNN), EB2DT (HNZ), EB2DTM (HNV), EB2DTS (HNW), EB2DTS (HNY), EB2DTS (HNV), EB2FA, EB2FAD, F12XHT (EB2ADTS), F12XHT (HNS/EB2ADTS), HMH (EB2FAD), HMM (EB2FAD), HMP (EB2FB), HMR (EB2FA), HMT (EB2), HMT (EB2F), HMU (EB2D), HMU (EB2FD), HMV (EB2M), HMW (EB2), HMX (EB2F), HMY (EB2M), HMZ (EB2), HMZ (EB2F), HNJ (EB2ADTXM), HNK (EB2ADT), HNK (EB2ADTD), HNK/EB2ADTD, HNL (EB2ADTS), HNN (EB2ADTX), HNP (EB2ADT), HNS (EB2ADTS), HNS/EB2ADTS, HNT (EB2ADTS), HNV (EB2DT), HNV (EB2DTM), HNW (EB2DTS), HNW (EB2DTS), HNX (EB2DT), HNX (EB2DTS), HNY (EB2DTS), HNZ (EB2DT), HNO2, ZMZ (EBO), ZMZ (EBOF), 1PP (HM01)



54213

19,80€

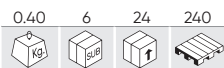

KIT DI ATTREZZI DI CRONOMETRAGGIO DEL MOTORE PER ROVER/PEUGEOT/FORD/VOLVO 2.0, 2.2L D

MODELLO	PEUGEOT: 807 (05-11), 407 (05-11), 607 (05-09).CITROËN: C4 (04-10), C5 II (04-10). LAND ROVER: FREELANDER (06-10). VOLVO: S40 (03-10), V50 (06-10), C70 (06-10), S80 (07-10), C30 906-10, V70 (07-10).FORD: S MAX 2.2 (08-10), GALAXY 2.2 (08-10), MONDEO 2.2, 2.0 (07-10).
UTENSILI OEM	PSA 0188.M, FORD 303-735, 303-1277, VOLVO 999-7122 (1) PSA 0188.X, FORD 303-1059, 303-1270, VOLVO 999-7121 (2) PSA 0188.F, FORD 303-393A, 303-393-01, 303-1272, VOLVO 999-7119/7120 (3)
CODICE MOTORE	PEUGEOT: DW10UTED4 (RHK), DW10BTED4 (RHR)DW12B-TED4 (4HS), (4HP), (4HT), (4HR). CITROËN: DW10BTED4 (RHR). LAND ROVER:DW12BTED4, 224DT. VOLVO:D420T 2.0D. FORD: QXBA(2.2), QXWA(2.0), QXBB(2.0),Q4BA(2.2), QXWA(2.0), QXWB(2.0), AZBA(2.0), AZBC(2.0), AZWA(2.0)

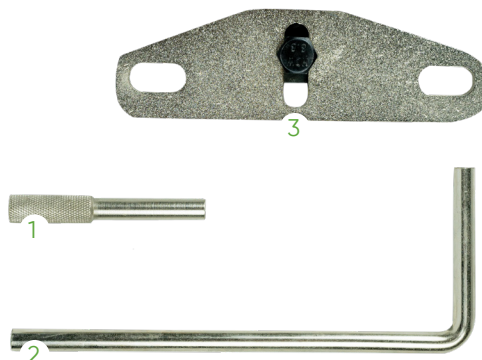

54432

43,00€



KIT DI MESSA IN FASE PER PSA 2.7, 3.0 HDI

MODELLO	CITROËN C6 JAGUAR S-TYPE (X200) 2004 - 2008, XF S (X250) 2008 - 2015, XF S (X260) 2015 - 2020, XJ6 TDVI (X350/358) 2005 - 2010, XJ (X351) 2010 - 2020, F-PACE S 30D (X761) 2016 - 2020 LAND ROVER: DISCOVERY 3 TDV6 (L319) 2004 - 2009, DISCOVERY 4/DISCOVERY SDV6, TDV6 (L319) 2009 - 2017, DISCOVERY SD6, TD6 (L462) 2017 - 2021, RANGE ROVER SDV6, SDV6 HYBRID, TDV6 (L405) 2012 - 2021, RANGE ROVER SPORT SDV6, TDV6 (L320) 2005 - 2013 PEUGEOT 407, 607 COUPE RANGE ROVER VELAR D275, D300 (L560) 2017 - 2021, RANGE ROVER SPORT SDV6, SDV6 HYBRID, TDV6 (L494) 2013 - 2021
UTENSILI OEM	303 11117 (1), 303 11116 (2), 303 1132 (3), 303 1126 (4), 0195H (4), 0195C (5), 0195K (6), 0188-K (7)
CODICE MOTORE	2.7: DT17 TED4 (UHZ), DT17BTED4 (UHZ) 3.0: DT20C (X8C/X8Z), DT20CTED4 (X8Z)

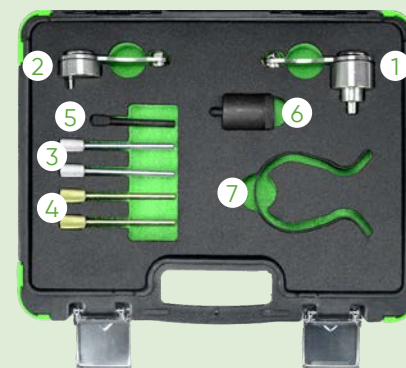

54433

18,00€



KIT DI MESSA IN FASE PER PSA 1.0, 1.1, 1.2, 1.4, 1.6, 2.0

MODELLO	CITROËN BERLINGO 2008 - 2011, C2 2003 - 2010, C-ELYSEE 2012 - 2016, C3 PLURIEL 2003 - 2010, C4 2004 - 2011, NEMO 2008 - 2015, XSARA 2000 - 2005 PEUGEOT 106 1998 - 2003, 206 1998 - 2009, 207 2006 - 2013, 306 1998 - 2003, 307 2000 - 2008, 1007 2005 - 2010, PARTNER 1998 - 2011, BIPPER 2008 - 2015
UTENSILI OEM	0132QY (1), 4507 TA (1), 0132AK (2), 0153AK (2), 0188K (2), 0189K (2), 1 870 900 100 (2), 4533 TAD (2), MOT 1436 (2) 3MM PIN (3), 0132AB (4), 0178D (4), 0194A (4), 77440010400 (4), 1.860.617.000 (4), 11 9 790 (4), 21-260 (4), 303-732 (4), 4527 TS2 (4), 49 JE02 018 (4), 5711 TD (4), 99360608 (4), 999 7169 (4), KM-6349 (4), 0132AJ (5), 0187B (5), 0189B (5), 0194B (5), 09919 58120 (5), 21 263 (5), 303 735 (5), 3031277 (5), 49 JE02 021 (5), 607589011500 (5), 8MM DRILL BIT (5), 8MM PIN (5), 999 7122 (5), EN-52137 (5), MOT. 1430 (5), MOT 1430 (5), 0123-RZ (6), 0132R (6), 0153AA (6), 0153AB (6), 0153G (6), 0153ZY (6), 10MM PIN (6), 4507 TB (6), 7014 TN, 9767 27 (6), M10 X 70MM (6), 0132Q (7), 0132QZ (7), 132Z (7), 4507 TA (7)
CODICE MOTORE	1.0: TU9 (C1A), TU9/K (C1A), TU9M (CDY/CDZ), TU9MZ (CDY/CDZ), TU9M/L (CDZ), TU9M/L3 (CDY) 1.1: TU1A (HFV/HFX), TU1JP (HFV/HFY/HFZ), TU1JP/L4 (HFX), TU1/K (H1A), TU1M (HDZ), TU1M/L (HDZ), TU1M/L3 (HDY/HDZ), TU1M/Z (HDZ), TU1M+ (HDY/HDZ) 1.4: ET3J4 (KFU), ET3JP4 (KFU), TU3A (KFT/KFV/KFW), TU3FJ2 (K6B/KFZ), TU3FM (KDY), TU3JP (KFW/KFX), TU3JP/IFL4 (KFX), TU3JP/L3 (KFX), TU3JP/L4 (KFX), TU3JP/IFL4 (KFX), ET3J4 (KFU), TU3M (KDX), TU3M/Z (KDY) 1.6: EC5 (NFP), EC5F (NFP), TU5J2 (NFY/NFW), TU5J4 (NFU), TU5JP (NFT/NFZ), TU5JP/L3 (NFZ), TU5JP/L4 (NFT/NFV), TU5JP4 (NFU), TU5JP4B (NFR), TU5JP4 (NFS), TU5JP4/L3 (NFX), TU5JP4/L4 (NFU/NFX), XU5JP (BFZ) 1.8: XU7JB (LFX), XU7JP (LFW), XU7JP/L3 (LFZ), XU7JP4 (LFY), XU7JP4/L3 (LFY) 2.0: XU10JC/Z (RFU), (RGX), XU10J2TE/V (RGX), XU10J2U (RFL), XU10J4R (RFR/RFV), XU10J4R/L3 (RFV), XU10J4RS/L3 (RFS)

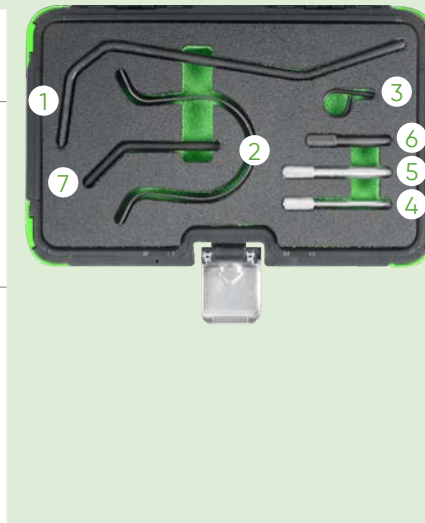

53293

134,00€

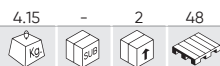

KIT DI ATTREZZI DI REGOLAZIONE CINGHIA DENTATA PER- FORD

MODELLO	B-MAX (12-17), C-MAX (07-17), COUGAR (98-01), COURIER (00-02), ESCORT (94-98), FIESTA (95-17), FOCUS (98-17), FOCUS C-MAX (03-07), FUSION (02-12), GALAXY (06-15), GRAND C-MAX (10-17), KUGA (08-15), MAVERICK (01-07), MONDEO (93-15), ORION (94-94), PUMA (97-02), S-MAX (06-15), TOURNEO CONNECT (02-15), TRANSIT (06-11), TRANSIT CONNECT (02-16), ECOSPORT (13-15), TOURNEO COURIER (14-15), GRAND TOURNEO COURIER (13-15).
UTENSILI OEM	303-376 (21-162B) (1), 303-1059 (2), 303-193 (21-104) (3), 303-393-01 (4), 303-1054 (5), 303-1097 (6), 303-748 (7), 303-734 (21-262) (8), 303-651 (21-229) (9), 303-393A (21-168) / 303-393-02 / 303-507 (21-210) / 303-620 (21-163) / 303-732 (21-260) / 303-735 (21-263).
CODICE MOTORE	PETROL: AODA/B, ASDA, ASDB, CFBA, CGBA/B, CHBA/B, CJBA/B, CSDA/B, DHA, DHB, DHC, DHD, DHE, DHF, DHG, EDBB, EDBD, EDDB, EDDC, EDDD, EDDF, EYDB, EYDC, EYDD, EYDE, EYDF, EYDG, EYDI, EYDJ, EYPA, EYPC, F8JA, F8JB, FHA, FHD, FHE, FHF, FUJA, FUJB, FXDA/C, FXDB/D, FXJA, FXJB, FYDA/C, FYDB/D, FYJA, FYJB, HWDA, HWDB, L1F, L1J, L1L, L1N, L1Q, L1T, L1V, L1W, M7JA, M7JB, MHA, MHB, NGA, NGB, NGC, NGD, QQDA/B/C, QQDB, RKA, RKB, RKF, RKH, RKJ, RKK, HXDA. GASOIL: F6JA, F6JB, F6JC, HHJA, HHJB, G8DA, HHDA, HHDB, RTN, RTQ, RTP, C9DC, BHDA/B, BHPA, C9DA/B, F9DA/B, FFBA, FFDA, HCPA, HCPB, KKDA, P7PA, P9PA, QYWA, R2PA, R3PA, RWPA, G6DA, G6DB, G6DC, AZWA, QXWA.



53294

119,00€



KIT DI ATTREZZI DI REGOLAZIONE CINGHIA DENTATA PER FORD MAZDA

MODELLO	FORD: COURIER (00-02), C-MAX (03-10), FIESTA (02-11), FOCUS (98-11), FUSION (02-11), GALAXY (06-10), KUGA (06-10), MONDEO (07-10), S-MAX (06-10), TOURNEO CONNECT (02-13), TRANSIT CONNECT (02-13) PEUGEOT: BIPPER (08-10) DISPATCH/ JUMPY III (07-12) EXPERT III (07-12) NEMO (08-10) PARTNER I/ II (05-11) PARTNER III (08-16) 107 (05-10) 1007 (05-10) 206 (01-12) 206+ (09-13) 206 CC (05-07) 207 (06-13) 207 CC (07-15) 208 (11-15) 307 (01-08) 308 (07-15) 308 CC (09-15) 407 (05-11) 508 (04-15) 2008 (13-15) 3008 (09-15) 4008 (12-15) 5008 (09-15). MAZDA: 2 (02-15), 3 (09-14) CITROËN: C1 (05-10), C2 (03-10), C3 I/II (02-10), C3 III (10-15), C3 PLURIEL (04-10), C3 PICASSO (09-12), C4 (04-11), C4 II (11-15), C4 PICASSO (06-12), C4 GRAND PICASSO (10-12), DS3 (09-12), DS4 (11-12), DS5 (12-15), C5 II (04-08), C5 III (04-12), XSARA II (02-04), XSARA PICASSO (04-10)
UTENSILI OEM	FORD: 303-376B (1), 303-193 (2), 303-393 (3), 303-732 (4), 303-651 (5), 303-393/01, 303-1059, 303-734, 303-735, MAZDA: 303-732, 303-734, 303-735. PSA: 0194-A, 0194-C, 0194B.
CODICE MOTORE	1.4D TDCi/Hdi: DV4TD(8HT), DV4TD(8HX), DV4TD(8HZ), DV4TD(8HW), DV4TED4(8HX), DVTED4(8HV), DV4TED4(8HY), DV4C(8HP), DV4C(8HR), DV4TED(8HS), F6JA, F6JB, F6JC. 1.6D TDCi/HDi: DV6TED4(9HZ), DV6ATED4(9HX), DV6TED4(9HY), DV6DTED(9HP), DV6C(9HR), DV6CATED(9HX), DV6C(9HL), DV6TED(9HP), DV6ATED(9HY), DVTED4(9HV), DV6TED4(9HX), DV6C(9HD), DV6C(BHX), DV6C(BHZ), DV6(9HR), DV6BTED4(9HW), DV6DTED(9HJ), DV6ETED(9HN), DV6ATED4BU(9HS), DV6BTED4(9HT), DV6BUTED4(9HT), DV6TED4B(9HV), DV6UTED4(9HX), DV6TED(9HD), DV6UTED4(9HU), DV6D(9HP), DV6TED4(9HV), DV6C(9HD), DV6TED4(9HW), DV6AT(9HX), DV6ATED(9HX), DV6CTED(9HC), DV6AUTED4(9HX), DV6TED4B, DV6DTED(9HF), HHJA, HHJB, G8DA, G8DB, HHDA, HHDB, MZ-CD, Y6. 1.8D TDCi/HDi: BHPA, C9DA/B, FFBA, G6DA, G6DB, G6DC, HCPA, HCBP, KKDA, P7PA, P9PA, R2PA, R3PA, RWPA. 1.8c: C9DC, RTN, RTQ. 1.8d Tdi: C9DA/B, C9DC. 2.0D TDCi/HDi: AZWA, G6DA, G6DB, G6DC, RHE(DW10CTED4), QXWA, QXWB.

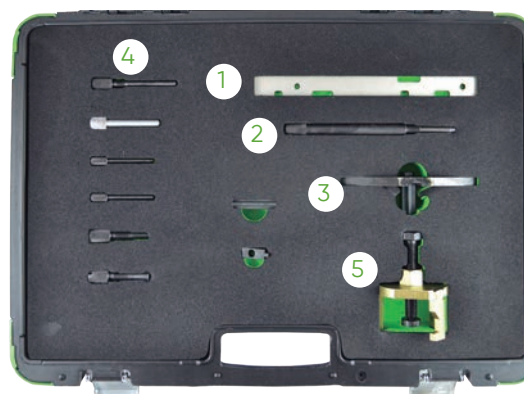

53318

24,00€



ESTRATTORE RUOTA DENTATA DI ALBERO A CAMME PER FORD

MODELLO	FORD
UTENSILI OEM	F8M, F8Q, S8U, S9U.



53295

77,00€

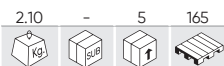

KIT DI ATTREZZI DI REGOLAZIONE CINGHIA DENTATA PER FORD 1,8TDDI, TDCI

MODELLO	C-MAX (07-10), COURIER (00-02), FIESTA (00-02), FOCUS (98-11), FOCUS C-MAX (03-07), GALAXY (06-10), MONDEO (07-10), S-MAX (06-14), TOURNEO CONNECT (02-13), TRANSIT CONNECT (02-13).
UTENSILI OEM	303-193 (21-104) (1), 303-393 (21-168) (2), 303-376 (21-162B) (3), 303-652 (21-230) (4), 310-095 (23-067) (5)
CODICE MOTORE	1.8D TDCI: BHPA, F9DA, F9DB, FFBA, FFDA, FFWA, HCPA, HCPB, KHBA, KKDA, KKDB, P7PA, P9PA, P9PB, QYBA, QYWA, R2PA, R3PA, RWPA, RWPC. 1.8D TDCI ECONETIC: KHBA. 1.8D TDI: BHDA, BHDB, BHPA, C9DA, C9DB, C9DC. 1.8D TURBO: C9DC, RTN, RTP, RTQ.



53296

60,00€

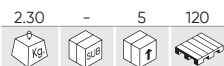

KIT DI ATTREZZI PER MONTAGGIO E REGOLAZIONE POMPA CARBURANTE PER FORD/JAGUAR DURATORQ

MODELLO	FORD: MONDEO (00-07), TRANSIT (00-14). CITROËN: RELAY, JUMPER III (06-13). FIAT: DUCATO (06-11).	JAGUAR: X-TYPE (03-10). PEUGEOT: BOXER III (06-12). LAND ROVER: DEFENDER TD4 (06-11). LDV: CONVOY (02-06).
UTENSILI OEM	303-1151 (1), 303-679A/21-238 (2), 303-732 (3), 303-675/21-234 (4), 303-698/21-251 (5)	
CODICE MOTORE	12.0D DI/TDDI/TDCI: ABFA, D3FA, F3FA, D5BA, D6BA, F1FA, FMBA, FMBB, HJBA, HJBB, HJBC, HJBE, N7BA, N7BB. 2.2D TDCI/ECONETIC: BG, CYFA, CYFB, CYFC, DRFA, DRFB, DRFC, P8FA, P8FB, PGFA, PGFB, QJBA, QJBA (BG), QJBB, QJBC, QJBD, QVFA, QWFA, SRFA, SRFB, SRFC, SRFD, SRFE, UHFA. 2.2D HDI/JTD: P22DTE (4HM), P22DTE (4HU), P22DTE (4HV). 2.4D DI/TDCI: DOFA, D2FA, D2FB, D4FA, F4FA, FXFA, H9FA, H9FB, H9FD, JXFA, JXFC, PHFA, PHFC. 2.4D TD/TDI: ZSD 424. 2.4D TD4: 244DT.	

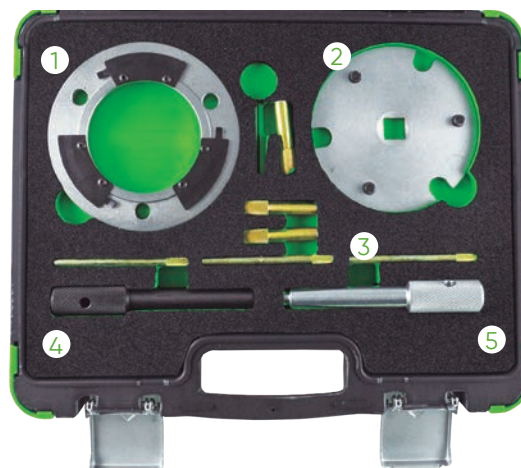

54419

57,00€

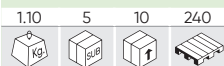

N

ESTRATTORE/INSTALLATORE PER GUARNIZIONI ALBERO MOTORE ANTERIORE FORD DURATORQ 2.0, 2.2, 2.4, 3.2

MODELLO	FORD MONDEO 2000 - 2007 RANGER 2011 - ON TRANSIT 2000 - 2006 TRANSIT 2006 - 2014 TRANSIT 2014 - 2019 TRANSIT/TOURNEO CUSTOM 2012 - 2016
UTENSILI OEM	21 238 (1), 303-679A (1), 303-682 (2)
CODICE MOTORE	2.0 Di ABFA D3FA F3FA 2.0 TDCI FMBA FMBB HJBA HJBB HJBC N7BA N7BB SDBA F1FA 2.0 TDDi D5BA D6BA 2.2 TDCI QJBA QJBB QJBC QJBD GBVAJQF GBVAJQJ GBVAJQW CVRA CVRB CYFA CYFB CYFC CYRA CYRB DRFA DRFB DRFC DRFE DRRA DRRB P8FA P8FB PGFA PGFB QVFA QWFA SRFA SRFB SRFC SRFD SRFE UHFA UHFB 2.4 Di D2FA D2FB D4FA DOFA F4FA FXFA 2.4 TDCI H9FA H9FB H9FD JXFA JXFC 3.2 TDCI SAFA SA2R SA2S SA2W SAFA SAFB



FIAT/ALFA ROMEO
BMW/MINI
PSA
FORD
JAGUAR/LAND ROVER
JEEP/CHRYSLER
MERCEDES-BENZ
RENAULT/DACIA/NISSAN
OPEL/VAUXHALL
VAG
STRUMENTI AUSILIARI
ALTRI

54420

102,00€



N

SET REGOLAZIONE CARBURANTE - FORD / VOLVO 2.5 (EURO 4)

MODELLO	FORD: FOCUS 2.5 RS / ST, MONDEO 2.5, S-MAX 2.5, GALAXY 2.5 ST (2005-) VOLVO: C30 (06-10), C70 (98-10), S40 (96-10), S60 (00-09), S70 (97-07), S80 (98-06), V40 (96-10), V50 (04-10), V70 (97-07), XC70 (02-07), XC90 (02-10)
UTENSILI OEM	303-1178 (1), 999 5452 (1), MOT 1337 (1) 303-1182 (2), 999 5451 (2), MOT 1340 (2) 303-1179 (3), 999 5433 (3) 303-1183 (4)
CODICE MOTORE	FORD: 2.5 Turbo (Euro 4), HUBA / HUWA / HYDA / JZDA VOLVO: 1.6 (B4164S), 1.8 (B4184S), 1.9T (B4194T), 2.0 (B4204S / B4204T), 2.0T (B5204T3 / B5204T4 / B5204T5), 2.3 (B5234FS), 2.3T (B5234T3 / B5234T7 / B5234T9) VOLVO: 2.4 (B5244S / B5244S2 / B5244S4 / B5244S5 / B5244S7), 2.4T (B5244T / B5244T3 / B5244T4 / B5244T5 / B5244T7), 2.5R (B5254FS), 2.4D (D5244T9 / D5244T8 / D5244T13)

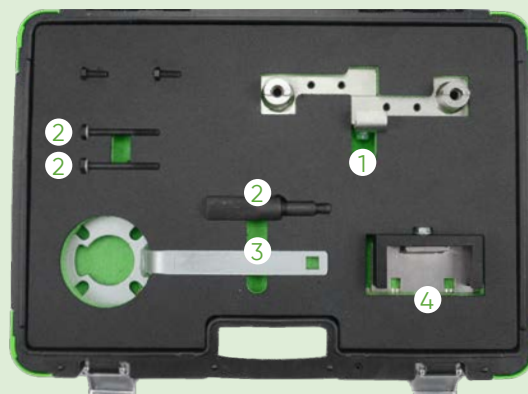

54421

52,00€



N

INSTALLATORE CINGHIA AUSILIARIA FORD/VOLVO 1.4 1.6

MODELLO	FORD 1.4, 1.6 (FOCUS, C-MAX, MONDEO) VOLVO 1.6 (S40, C30, V50)
UTENSILI OEM	303-1179
CODICE MOTORE	B4164S3, FUJA, FXJA, FYJA C12HM7AD, C12LM7AA, ZH12FUJA, ZH12FUJB, ZH12M7JB C14HDEZ, C14HHADB, ZH14ASDA, ZH14FXDA, ZH14FXDB, ZH-14FXDC, ZH14FXDD, ZH14FXJA, ZH14FXJB 16HDEZ, CH16HDEZ, C16HHDEY, ZH16FYDA, ZH16FYDB, ZH16FYDC, ZH16FYDD, ZH16FYDH, ZH16FYJA, ZH16FYJB, ZH16HWDA, ZH16HXDA



54424

64,50€



N

KIT DI MESSA IN FASE PER FORD 2.0 ECOBOOST

MODELLO	FOCUS, GALAXY, MONDEO, S-MAX
UTENSILI OEM	303-1504 (1) 303-1600 (2), 300-1565 (2) 303-1521 (3) 303-748 (4) 303-1595 (5) 2MM TENSIONER (6)
CODICE MOTORE	MGDA, R9CB, R9CD, R9CF, R9CH, R9DA, R9DB, R9DC, R9DD, TNBA, TNBB, TNCC, TNCD, TNCF, TNWA, TNWB, TPBA, TPWA, TVDA, XQDA

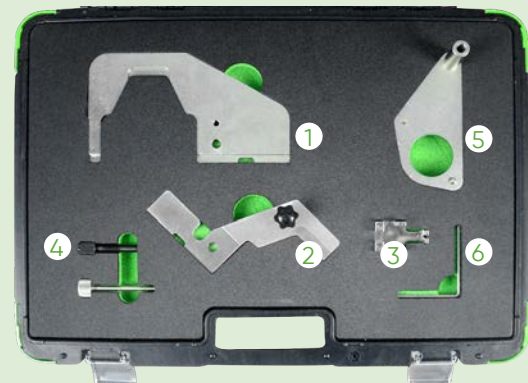

53324

12,50€

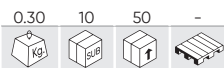

ATTREZZO DI REGOLAZIONE CINGHIA DENTATA PER FORD

MODELLO	FORD: B-MAX (15-17), C-MAX (07-10), COUGAR (98-01), FIESTA (95-17), FOCUS (98-11), FOCUS C-MAX (03-07), FUSION (02-12), GALAXY (06-15), MAVERICK (01-07), MONDEO (93-15), PUMA (97-02), S-MAX (06-15), TOURNEO CONNECT (02-06), TRANSIT (06-12), TRANSIT CONNECT (02-06). MAZDA: 121 ZG (95-00), 2 DY (02-07), 3 BK (03-09), 3 BL (09-15), 5 CR (05-10), 5 CW (10-12), 6 GG/GY (02-07), 6 GH (07-15), MPV LW (02-05), MX-5 NC (05-16), TRIBUTE EP (04-06). VOLVO: C30 (06-13), S40 (06-12), S80 (07-11), V50 (04-12).
UTENSILI OEM	FORD: 303-1054, 303-507 (21-210), 303-620 (21-163), 303-574, 303-748, 303-376 (21-162B), 303-376B MAZDA: 49 JE01 061, 303-574, 49 JE02 061, 303-465, 49 JE01 054 VOLVO: 999 7152, 999 7151.
CODICE MOTORE	1.4 / 1.6

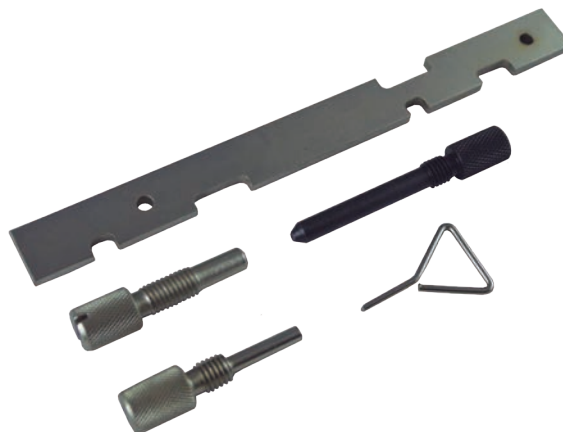

53653

207,00€

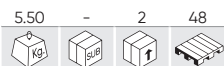

ATTREZZO DI REGOLAZIONE CINGHIA DENTATA PER FORD

MODELLO	FORD: FIESTA, FOCUS, B-MAX, ECOSPORT.
UTENSILI OEM	303-1605 (1), 303-1606 (2), 303-1604 (3), 303-1602 / 503-393A / (21-168) (4), 303-1054 (5), 303-732 (6)
CODICE MOTORE	M1DD, M1JA, M1JC, M1JE, M1JHM1JJ, M1DA, M2DA, M2DB, M2DC, SFDBSFJA, SFJB, SFJC, SFJD



54201

37,60€



SET DI STRUMENTI PER LA FASATURA DEL MOTORE FORD

MODELLO	FORD: C-MAX(07 - 10), C-MAX/GRAND C-MAX(10-18), FIESTA(08-18), FOCUS/FOCUS C-MAX(04-11), FOCUS(11-18), MONDEO(07-15)
UTENSILI OEM	303-1097 (1), OEM 303-1054 (2), OEM 303-1059, 303-1270, 0188X, 999-7121 (3), OEM 303-748, 999-7152, 21-259 (4), OEM 303-735, 999 7122, 0187B, 0189B, 0132AJ1, 21-263, 0188M, MOT 1430, 303-1277, 0194B (5)
CODICE MOTORE	11.6 T1-VCT HXDA (2003-2007), 2.0 TDCI, G6DA, G6DB, G6DC 2003-2007



54204

124,00€



KIT DI ATTREZZI DI CRONOMETRAGGIO DEL MOTORE PER FORD 2.0 ECOBLUE

MODELLO	FORD EDGE, FOCUS, GALAXY, S-MAX (FROM 2018); KUGA, MONDEO, RANGER (DESDE 2019); TRANSIT, TRANSIT CUSTOM AND TOURNEO CUSTOM (DESDE 2016); TODOS CON MOTOR ECOBLUE TDCI ; AWD, FWD Y RWD.
UTENSILI OEM	303-1637 (1), 303-1650 (2), 303-1643 (3).
CODICE MOTORE	BCCC,YLCB,YLDA,YLF6,YLFA,YLFB,YLFS,YLR6,YLRA,YMCB,YM-F6,YMFA,YMFB,YMFS,YMHA,YMRA,YNCA,YNF6,YNFA,YNFB,YNFS,Y-NR6,YNRA

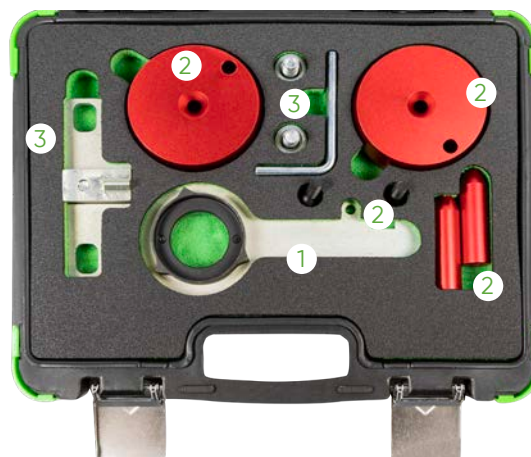

54208

76,00€



KIT DI ATTREZZI DI CRONOMETRAGGIO DEL MOTORE PER FORD 2.0 ECO BOOST SCTI, TI-VCT

MODELLO	<u>FORD</u> : GALAXY(2010)MONDEO (2010) S MAX (2010) FOCUS(2011)
UTENSILI OEM	303-748 (1), 303-1504 (2), 303-1565 (3), 303-1521 (4)
CODICE MOTORE	TNWA, TNWB, TPWA, TNBA, TPBA, MGDA, XQDA

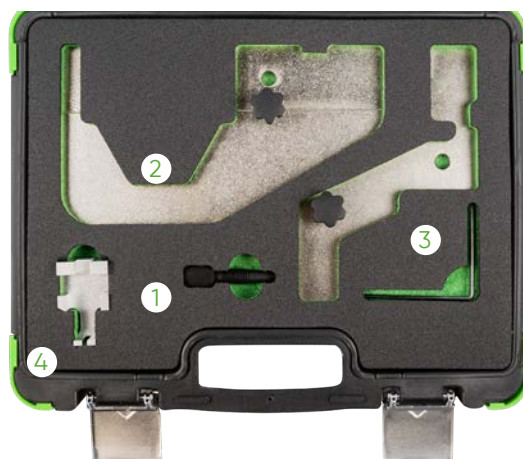

54209

29,70€



KIT DI ATTREZZI DI CRONOMETRAGGIO DEL MOTORE PER FORD/MAZDA 2.2, 3.2 TDCI

MODELLO	FORD_RANGER 3.2L (2011-2016) FORD_RANGER 2.2L (2011-2015) FORD_TRANSIT 2.2L (2006-2016) FORD_EVEREST 3.2L (2015) FORD_RANGER 3.2L (2011) MAZDA BT-50 (2011) MAZDA BT-50 3.2L (2011-2016)
UTENSILI OEM	303-675/21-234,303-698/21-251 (1), 303-1587 (2)
CODICE MOTORE	CYFA,CYFB,DRFA,DRFB,P8FA,P8FB,PGFA,PGFB,QVFA,QWFA,SR-FA,SRFB,SRFC,SRFD,SEFE,UHFA,CYFC,DRFC,USRA



54223

149,00€

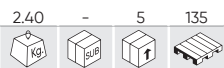

KIT DI ATTREZZI DI BLOCCAGGIO DELLA RUOTA DENTATA DELL'ALBERO A CAMME PER FORD 1.5T

MODELLO	FORD_1,5L DURATEC, ECOSPORT, FIESTA, FOCUS
UTENSILI OEM	303-1639 (1), 303-1643 (2), 303-1647 (3), 303-1648 (4)
CODICE MOTORE	2.2 / 2.5

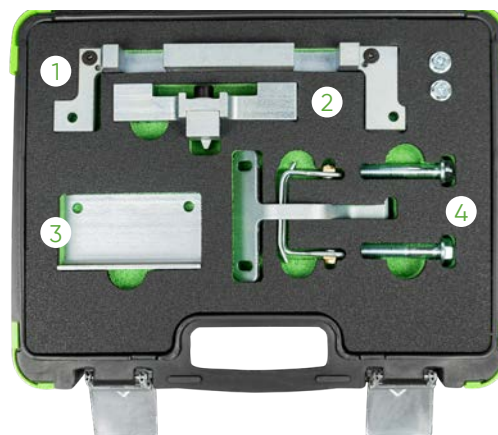

54224

64,50€

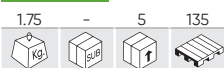

KIT DI ATTREZZI PER INSTALLAZIONE E RIMOZIONE DELLA POMPA DI INIEZIONE PER FORD 2.0

MODELLO	FORD_TRANSIT (17-18), TOURNEO CUSTOM (16-18), TRANSIT CUSTOM (16-18)
UTENSILI OEM	303-1635 (1)/3, 3.3--1635 (2)/1, 303-1635 (3)/2, 303-1635/6 (4)
CODICE MOTORE	YLFS, YMFS, YNFS, YLF6, YMF6, YNF6, YLR6, YMR6 AND YNRS.

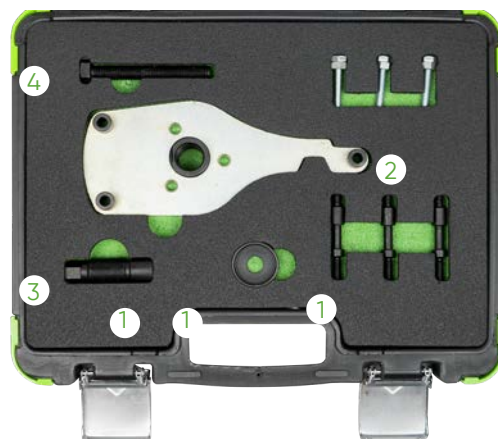

54260

277,00€

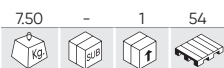

KIT DI MOLTIPLICATORE DI FORZA 5:1 PER MOTORI FORD ECOBOOST



1.0 EcoBoost
1.0 Duratec
2.0 Duratec

2.0 Durator-TDCi
2.0 EcoBlue Diesel



53297

45,00€

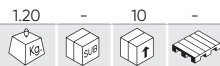

KIT DI ATTREZZI DI REGOLAZIONE CINGHIA DENTATA PER JAGUAR/LAND ROVER

MODELLO	JAGUAR: MS TYPETDVI. LAND ROVER: DISCOVERY 2.7 TDV6. RANGE ROVER: SPORT 2.7 TDV6.
UTENSILI OEM	303-1117 (1), 303-1116 (2), 303-1132 (3), 303-1126 (4) (5)
CODICE MOTORE	276DT, 306DT.



53298

91,00€



KIT DI ATTREZZI DI REGOLAZIONE CINGHIA DENTATA PER LAND ROVER

MODELLO	MOTORI DIESEL: 200 TDI. 300 TDI. 2.5
	<ul style="list-style-type: none"> - Perno di sincronizzazione trasmissione manuale EDC 200 TDI. - 2.5 Motori diesel. - Estrattore dell'ammortizzatore dell'albero motore. - Instrumenti di bloccaggio della pompa di iniezione. - Bullone di sincronizzazione dalla pompa d'iniezione 200/300 TDI. - Strumento di sincronizzazione del volante motore 200/300 TDI. - Strumento di sincronizzazione della pompa DPS 2.5. - Strumento di sincronizzazione del volante del motore 2.5.



54422

140,00€



KIT REGOLAZIONE EQUILIBRIO ASSE JAGUAR/LAND ROVER 2.0D

MODELLO	JAGUAR: E-PACE D150, D180, D240 (X540) (2017-), F-PACE 20D, 25D, E-PERFORMANCE (X761) (2016-), XE 20D, 25D, E-PERFORMANCE (X760) (2015-), XF 20D, 25D, E-PERFORMANCE (X260) (2015-) LAND ROVER: DEFENDER SD4 D200, SD4 D240 (L663) (2019-2021), DISCOVERY SPORT ED4, SD4, TD4, D150, D180, D240 MHEV (L550) (2015-), DISCOVERY SD4, TD4 (L462) (2017-2021) RANGE ROVER: EVOQUE ED4, SD4, TD4 (L538) (2015-2019), EVOQUE D150, D180, D240 MHEV (L551) (2019-), SPORT SD4 (L494) (2016-2018), VELAR D180, D240 (L560) (2017-)
UTENSILI OEM	JLR-303-1662 (1) JLR303-1663-1 (2) JLR303-1663-2 (3) JLR303-1663-3 (4) JLR-303-1664 (5) JLR-303-1665 (6)
CODICE MOTORE	2.0: AJ200D,AJ200/204DTA,AJ200/2004DTD 2.0: AJ-200D/204DT, AJ-200D/204DTA



54423

108,00€



N

KIT DI MESSA IN FASE PER LAND ROVER 3.6D

MODELLO	RANGE ROVER SPORT; 3.6 (TDV8) DIESEL (2006-2011) RANGE ROVER; 3.6 (TDV8) DIESEL (2006-2011)
UTENSILI OEM	303-1236 (1) 303-1243 (2) 303-1239 (3) 303-1238 (4)
CODICE MOTORE	368DT

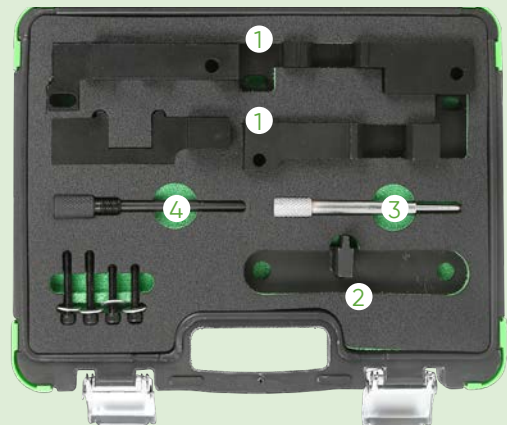

54425

124,00€



N

KIT DI MESSA IN FASE PER LAND ROVER FREELANDER V6/ROVER KV6 2.0L, 2.5L

MODELLO	LAND ROVER; FREELANDER (2000-2006) MG; ZR (2004-2005), ZS (2001-2005), ZT (2001-2005) ROVER; 45 (1999-2005), 75 (1999-2005), 825 (1996-1999)
UTENSILI OEM	LRT 12-175 (1) LRT 12-187 (2) LRT 12-195 (3) LRT 12-196 (4) LRT 12-198 (5) LRT 12-232 (6)
CODICE MOTORE	LAND ROVER; 2,5 KV6 MG; 2,0 KV6, 2,5 KV6 ROVER; 2,0 KV6 2,5 KV6

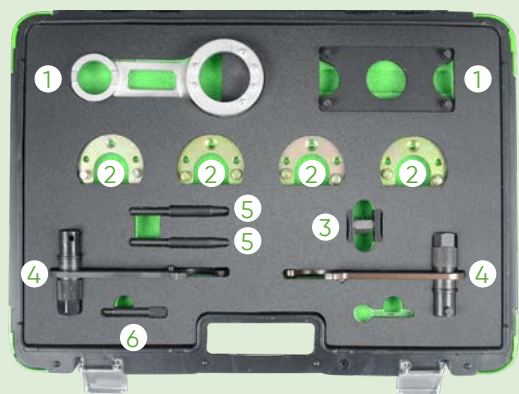

54426

69,00€



N

KIT DI MESSA IN FASE PER JAGUAR/LAND ROVER 3.2, 3.5, 4.0, 4.2, 4.4

MODELLO	DAIMLER; V8 (97-03), SUPER V8 (97-03), SUPER EIGHT (05-10). JAGUAR; S-TYPE (99-08), XF (08-09), XJR (97-10), XJ8 (97-10), XKR (98-09), XK8 (96-09) LAND ROVER; DISCOVERY III (04-09) RANGE ROVER (05-09), RANGE ROVER SPORT (05-09)
UTENSILI OEM	303530 (1) 303531 (2) 303532 (3) 303533 (4) 303645 (5) 303654 (6) T40011 (7)
CODICE MOTORE	3.2: AC,KB,KC 3.5: RB 4.0: BC, CC,CE,DC,EC,GB,GC,LC,MA,MB,NB,NC,PA,PB 4.2: 1B,2B,3B,1G,5G,9G,HB,HG,SB,TB,PC,428PS 4.4: 448PN



54427

113,00€



N

ATTREZZO PER IL BLOCCAGGIO DELLA PULEGGIA DELL'ALBERO MOTORE JAGUAR/LAND ROVER 4.0, 4.2, 4.4

MODELLO	DAIMLER: V8; 4.0 (97-98) JAGUAR: S-TYPE; 3.2, 3.5, 4.2 V8 (99-08), XF; 3.2, 3.5, 4.2 V8 (08-09), XJ; 3.2, 3.5, 4.2 V8 (97-08), XJ8; 4.0 (97-98), XK; 3.2, 3.5, 4.2 V8 (97-08), XK8; 4.0 (97-98) LAND ROVER: DISCOVERY3; 4.2, 4.4 LA V8 (05-09) RANGE ROVER; 4.2, 4.4 SPORT LS V8 (05-09), RANGE ROVER; 4.2, 4.4 LM V8 (06-08)
UTENSILI OEM	LRT 12 080 18G 1437 18G 1437 2 303 191 303 191 03 303 191 04 303 588 303 893
CODICE MOTORE	AJ26, AJ27, AJ28, AJ34 30G,36D,42D,56D,58D,94D,428PS,448PN



54428

31,00€



N

KIT DI MESSA IN FASE PER CHRYSLER/JEEP 2.8 CRD

MODELLO	CHRYSLER GRAND VOYAGER 2008 - 2015 DODGE NITRO 2007 - 2011 JEEP CHEROKEE 2008 - 2013, WRANGLER 2007 - 2018
UTENSILI OEM	VM 9991 (1) VM 9992 (2)
CODICE MOTORE	VM64C, ENS, ENS (51C), 49C, 50C, ENS VM10D, ENS VM11D



54429

55,00€



N

KIT DI MESSA IN FASE PER CHRYSLER/JEEP 3.0D

MODELLO	CHRYSLER 300 C 2012 - 2015 JEEP GRAND CHEROKEE 2011 - ON
UTENSILI OEM	VM 10338 1 (1) VM 10338 2 (2) VM 10359A (3), VM 10359 (3) VM 10339 (4), VM 10359 (4)
CODICE MOTORE	3.0 CRD: EXF 3.0 CRD/MULTIJET: EXF VM23D, EXF VM44D, EXF VM44D, EXF VM63D



54207

38,90€

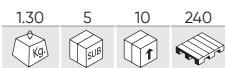

KIT DI ATTREZZI DI CRONOMETRAGGIO DEL MOTORE PER CHRYSLER/JEEP LDV 2.5 CRD

MODELLO	CHRYSLER: VOYAGER (01-08), GRAND VOYAGER (01-08) JEEP: CHEROKEE (01-08) LDV: MAXUS (05-09)	
UTENSILI OEM	VM 9660 (1), VM1052 (2), VM1053 (3), VM1068 / VM1089 (4), VM1080 (5), VM8873 (6)	
CODICE MOTORE	2.5D CRD: R2516C, R2516K, R2516LVM39/40B.	2.8D CRD: R2816C5.05A, R2816K4.



53270

70,00€



KIT DI ATTREZZI DI REGOLAZIONE CINGHIA DENTATA PER MERCEDES/CHRYSLER/JEEP

MODELLO	MERCEDES CHRYSLER JEEP
UTENSILI OEM	112589034000 (1), 601589024000 (2), 111589031500 (3)
CODICE MOTORE	HERR.: 112 589 03 40 00: 112, 113, 137, 155, 156, 272/979, 273, 629, 642/992. HERR.: 601 589 02 40 00: 102, 103, 104, 111, 601, 602.91/93/94/96/983, 603.91/93/96/97, 604, 605, 606, 611, 612/965/966, 613. HERR.: 111 589 03 15 00: 111, 119, 604, 605, 606, 611/980, 612, 613, 628, 629, 640, 642/922, 612.965/966, 646, 647, 648 .



53271

227,00€



KIT DI ATTREZZI DI REGOLAZIONE CINGHIA DENTATA PER MERCEDES BENZ M271

MODELLO	MERCEDES
UTENSILI OEM	271 589 003100 (1), 271589014000 (2), 271589001500 (3), 156589006100 (4)
CODICE MOTORE	M271. E18ML 2002. DE18ML 2003 - 2005. E16ML 2008. DE18LA 2009.

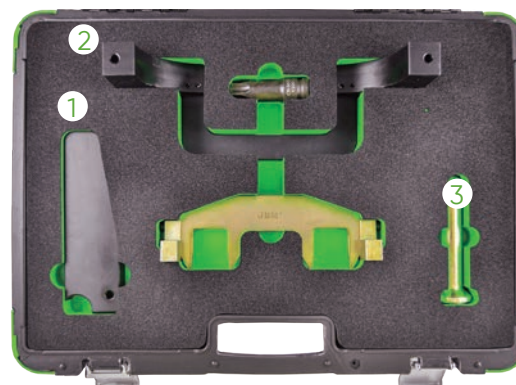

53272

195,00€

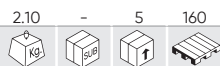

KIT DI ATTREZZI DI ALLINEAMENTO PER MERCEDES BENZ AMG 156

MODELLO	MERCEDES
UTENSILI OEM	156589006100 (1), 156589003200 (2), 156589016300 (3), 156589006900 (4)
CODICE MOTORE	BENZ AMG 156.ML 63 AMG.S 63L AMG.S 63. AMG. R 63 AMG L 4MATIC. R63 AMG 4MATIC. E 63 AMG. CLS 63 AMG. CLK 63 AMG BLACK SERIES. CLK 63 AMG CABRIO. CL 63 AMG.

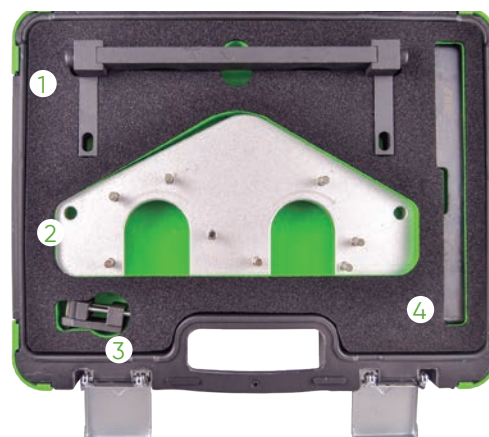

53273

75,00€



KIT DI ATTREZZI DI REGOLAZIONE CINGHIA DENTATA PER MERCEDES M276, M157, M278

MODELLO	MERCEDES		
UTENSILI OEM	27658901400		
CODICE MOTORE	<table border="0"> <tr> <td>CL 500 / 63 AMG (C 216) 2010-2013. S 500 / 63 AMG (C 217) 2014. CLS 300 (C 218) 2012. E 300 / 350 / 400 (C/A 207) 2011. CLS 350 / 400 / 500 / 63 AMG (C/X 218) 2011-2014. SLK 350 (R 172) 2011. SL 350 / 400 / 500 / 63 AMG (R 231) 2012. S 500 PLUG-IN HYBRID (V 222) 2014. ML 300 / 350 / 500 / 63 AMG (W 166) 2011.</td> <td>C 400 (W 205) 2014. E 400 HYBRID (W 212) 2012. G 63 AMG (W 463) 2012. E 300 / 350 / 400 / 500 / 63 AMG (W/S 212) 2011. C 350 (W/S/C 204) 2011. S 350 / 500 / 63 AMG (W/V 221) 2010. S 400 / 63 AMG (W/V 222) 2013. R 350 BlueEFFICIENCY (W/V 251) 2012. GL 450 / 500 (X 166) 2012. GLK 350 (X 204) 2011.</td> </tr> </table>	CL 500 / 63 AMG (C 216) 2010-2013. S 500 / 63 AMG (C 217) 2014. CLS 300 (C 218) 2012. E 300 / 350 / 400 (C/A 207) 2011. CLS 350 / 400 / 500 / 63 AMG (C/X 218) 2011-2014. SLK 350 (R 172) 2011. SL 350 / 400 / 500 / 63 AMG (R 231) 2012. S 500 PLUG-IN HYBRID (V 222) 2014. ML 300 / 350 / 500 / 63 AMG (W 166) 2011.	C 400 (W 205) 2014. E 400 HYBRID (W 212) 2012. G 63 AMG (W 463) 2012. E 300 / 350 / 400 / 500 / 63 AMG (W/S 212) 2011. C 350 (W/S/C 204) 2011. S 350 / 500 / 63 AMG (W/V 221) 2010. S 400 / 63 AMG (W/V 222) 2013. R 350 BlueEFFICIENCY (W/V 251) 2012. GL 450 / 500 (X 166) 2012. GLK 350 (X 204) 2011.
CL 500 / 63 AMG (C 216) 2010-2013. S 500 / 63 AMG (C 217) 2014. CLS 300 (C 218) 2012. E 300 / 350 / 400 (C/A 207) 2011. CLS 350 / 400 / 500 / 63 AMG (C/X 218) 2011-2014. SLK 350 (R 172) 2011. SL 350 / 400 / 500 / 63 AMG (R 231) 2012. S 500 PLUG-IN HYBRID (V 222) 2014. ML 300 / 350 / 500 / 63 AMG (W 166) 2011.	C 400 (W 205) 2014. E 400 HYBRID (W 212) 2012. G 63 AMG (W 463) 2012. E 300 / 350 / 400 / 500 / 63 AMG (W/S 212) 2011. C 350 (W/S/C 204) 2011. S 350 / 500 / 63 AMG (W/V 221) 2010. S 400 / 63 AMG (W/V 222) 2013. R 350 BlueEFFICIENCY (W/V 251) 2012. GL 450 / 500 (X 166) 2012. GLK 350 (X 204) 2011.		



54318

105,00€



RIVETTATRICE PER CATENE DI DISTRIBUZIONE

MODELLO	CHRYSLER JEEP MERCEDES
UTENSILI OEM	112 589 026 300 (1) 103 589 016 300 (2) 602 589 026 300 (3) 602589023300 (4) 602589003900 (5) 602589046301 (6)
CODICE MOTORE	CHRYSLER/JEEP: 2.2D, 2.7D, 3.0D CRD (DIESEL). MERCEDES: 1.7D, 2.1D, 2.2D, 2.7D, 3.0D, 3.2D, 3.9D, 4.0D CDI (DIESEL)

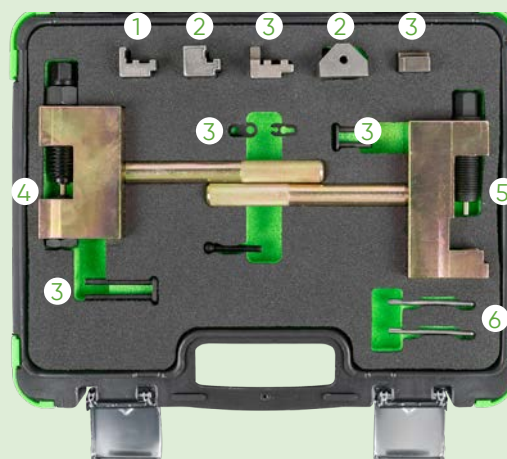

54414

97,50€



N

KIT DI MESSA IN FASE PER MERCEDES M651

MODELLO	A CLASS (2012-2018), B CLASS (2012-2019), C CLASS (2009-2015), C CLASS (2014-2018), CLA COUPE (2013-2019), CLS (2011-2018), E CLASS (2009-2016), GLA (2014-2020), GLC (2015-2019), GLE (2015-2019), GLK (2008-2015), M CLASS (2011-2015), S CLASS (2010-2013), S CLASS (2013-2017), SLC (2016-2017), SLK (2012-2016), SPRINTER (2009-2018), SPRINTER (2018-), V CLASS (2014-), VIANO (2010-2015), VITO (2010-2015), VITO (2014-) MERCEDES-BENZ
UTENSILI OEM	608 31 800 (1) 608 31 830 (2) 608 31 810 (3) 608 31 820 (4) 651 589 00 40 00 (5)
CODICE MOTORE	1.8: 651.901 2.1: 651.900, 651.910, 651.911, 651.912, 651.913, 651.916, 651.921, 651.922, 651.924, 651.930, 651.940, 651.950, 651.955, 651.956, 651.957, 651.958, 651.960, 651.961, 651.980 2.2: 651.925

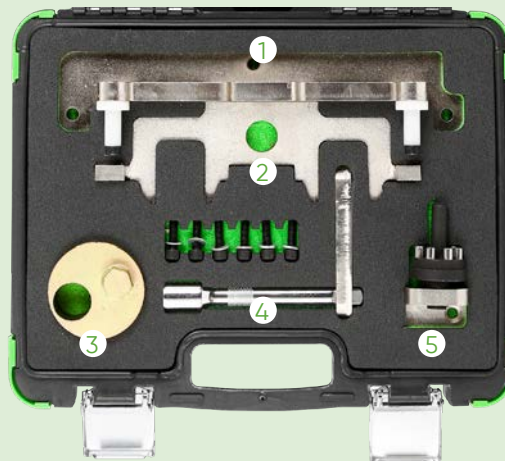

54415

60,00€



N

KIT DI MESSA IN FASE PER MERCEDES M651

MODELLO	GLA X156 200/220 CDI, GLK X 204 200/220/250 CDI, ML W166 250, SLK R172 250 CDI, SPRINTER W906 210/310/510/213/313 CDI, SPRINTER W906 513/216/316/416/516 CDI, V-CLASS W/V 639 2.0/2.2 CDI, VITO W/V 639 110/113/116 CDI MERCEDES-BENZ: A-CLASS W176 180/200/220 CDI, B-CLASS W246 200/220 CDI, C-CLASS W/S/C 204 180/200/220/250 CDI, CLA C117 200/220 CDI, CLD C/X 218 220/250, E-CLASS W/S 212 200/220/250 CDI E-CLASS C/A 207 220/250 CDI, E-CLASS W212 250/300 BLUETEC
UTENSILI OEM	651589004000 (1) 651589014000 (2)
CODICE MOTORE	1,8 651.901 2,1 651.900 651.910 651.911 651.912 651.913 651.916 651.921 651.922 651.924 651.925 651.930 651.940 651.950 651.955 651.956 651.957 651.958 651.960 651.961 651.980

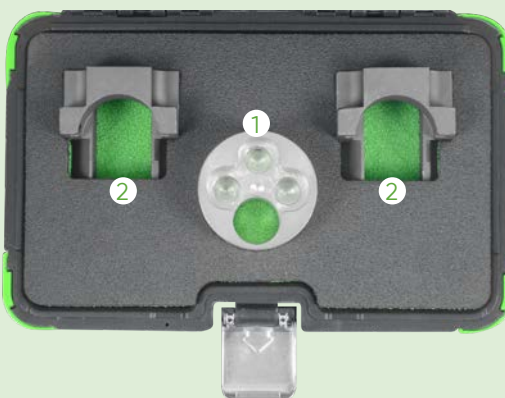

54416

31,00€



N

KIT DI MESSA IN FASE PER MERCEDES M642

MODELLO	G-CLASS (461/463) 2007-2015, GL-CLASS (164/166) 2006-2016, GLE/GLE COUPE (166/292) 2020 GLK (204) 2008-2015, GLS (166) 2016-2019, M-CLASS (164/166) 2005-2015, R-CLASS (251) 2005-2013, S-CLASS (221/222) 2005-2017, SPRINTER (906) 2006-2018, VIANO (639) 2005-2015, VITO (639) 2006-2015 MERCEDES-BENZ: C-CLASS (203/204) 2004-2014, CLK (209) 2005-2009, CLS (219/218) 2005-2018, E-CLASS (211/212/213) 2005-2018, E-CLASS COUPE/CABRIOLET (207) 2009-2017
UTENSILI OEM	642589003100 (1)
CODICE MOTORE	642.820 642.822 642.826 642.830 642.832 642.834 642.835 642.836 642.838 642.850 642.852 642.853 642.854 642.855 642.856 642.858 642.861 642.862 642.867 642.868 642.870 642.872 642.884 642.886 642.890 642.896 642.910 642.920 642.921 642.922 642.930 642.932 642.940 642.950 642.960 642.961 642.970 642.975 642.990 642.992 642.993

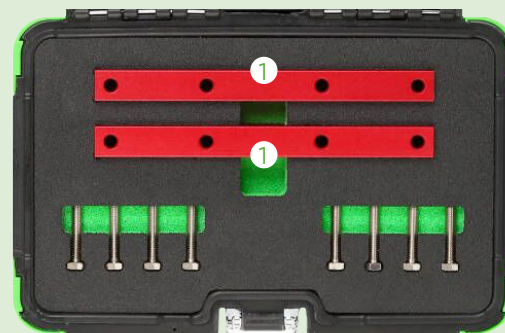

54417

153,00€

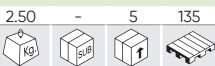

N

KIT DI MESSA IN FASE PER MERCEDES M133, M270, M274

MODELLO	MERCEDES BENZ A -CLASS (W176) (2012), MODEL A180/A200 MERCEDES BENZ B CLASS (W246) AS OF 2011, MODEL B180/B200
UTENSILI OEM	270589006100 (1)
CODICE MOTORE	M133 M270 M274

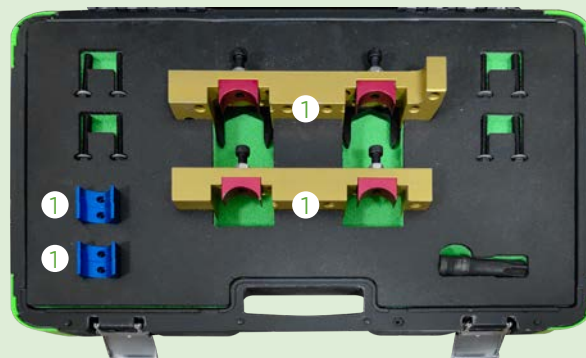

54418

37,00€



N

KIT DI MESSA IN FASE PER MERCEDES M112, M113

MODELLO	C-CLASS (202) 2.4/2.6/2.8/3.2/4.3 - 1998-00, CLK (208) 3.2/4.3/5.4 - 1997-03, E-CLASS (210) 2.4/3
UTENSILI OEM	112589003200 (1) 112589013200 (2) 112589000100 (3)
CODICE MOTORE	MERCEDES.BENZ: M112, M113



51488

16,00€

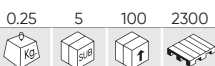

DISPOSITIVO BLOCCAGGIO ALBERO MOTORE / ALBERO PER RENAULT/NISSAN/DACIA/SUZUKI

MODELLO	RENAULT: CAPTUR, CLIO II,III,IV, ESPACE/GRAND ESPACE III,IV, FLUENCE, KADJAR, KANGOO, LAGUNA I,II,III, LOGAN/ LOGAN MCV, MEGANE I,II,III,IV, MODUS/GRAND MODUS, SCENIC/ GRAND SCENIC I,II,III,IV, TWING II, TRAFIC II, MASTER II 1.5DCI & 1.9 DCI. DACIA: DOKKER, DUSTER, LODGY, LOGAN, SANDERO 1.5DCI NISSAN: ALMERA, CUBE, JUKE, KUBISTAR, MICRA, NOTE, NV200/EVALIA, PRIMERA, TIIDA, INTERSTAR, PRIMASTAR 1.5DCI & 1.9 DCI SUZUKI: GRAND VITARA, JIMNY 1.5DDIS & 1.9DDIS
UTENSILI OEM	MOT1489, MOT1430, MOT1054.
CODICE MOTORE	K9K, F8Q, F9Q - benzina, Clío, R19, Laguna 1.8/2.0 F3R F3P



53289

45,00€

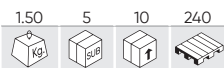

KIT DI ATTREZZI DI REGOLAZIONE CINGHIA DENTATA PER RENAULT 1.4, 1.6, 1.8, 2.0 16V

MODELLO	<p>RENAULT: ESPACE/GRAND ESPACE (98-02), ESPACE/GRAND ESPACE IV (02-10), KANGOO/TREKKA (01-09), LAGUNA (98-01), LAGUNA II (01-07), LAGUNA III (07-13), MEGANE (99-03), MEGANE II (02-10), MEGANE III/SPORT (08-13), MEGANE/SCENIC (99-00), SCENIC/RX4 (99-03), SCENIC/GRAND SCENIC II (03-09), TRAFIC II (01-11), TWINGO II (08-14), VEL SATIS (00-10), WIND (10-14)</p> <p>DACIA: LOGAN/MCV (05-11).</p> <p>NISSAN: KUBISTAR X76 (03-09), PRIMASTAR (02-11).</p> <p>VAUXHALL/OPEL: JETTA, TOURAN, GOLF, GOLF PLUS, POLO, PASSAT, TIguan, SCIROCCO.</p>
UTENSILI OEM	MOT1489 (1), MOT1054 (2), MOT1496 (3)
CODICE MOTORE	<p>1.4 16V K4J: 730, 732, 740.</p> <p>1.6 16V K4M: 752, 753, 760, 761, 764, 788, 812, 813, 854, 856.</p> <p>1.8 16V F4P: 720, 722, 760, 770, 771, 772, 773, 774, 775.</p> <p>2.0 16V F4R: 700, 701, 712, 713, 714, 715, 720, 722, 730, 732, 736, 738, 740, 741, 744, 746, 747, 762, 763, 764, 765, 766, 767, 770, 771, 780, 790, 791, 792, 820, 830, 832, 867.</p> <p>2.0 16V F4RTI: 720, 722, 764, 765, 774, 776, 784, 786, 787, 794, 795, 796, 797, 800, 802, 810, 811, 870, 872, 874, 886, 887, 896, 897.</p>

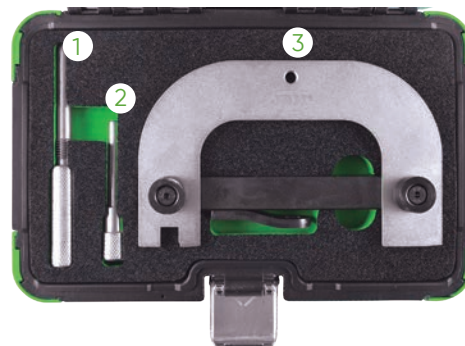

53290

51,00€



KIT DI ATTREZZI DI REGOLAZIONE CINGHIA DENTATA PER RENAULT/VOLVO 16V, 20V

MODELLO	<p>RENAULT: LAGUNA 2.0 16V / 2.5 20V (1996-1999), SAFRANE 2.0 16V / 2.5 20V (1996-2001)</p> <p>VOLVO: 850 (1992-1997), C70 (1998-2002), S40 (1996-2004), V40 (1996-2004), S60 (2001-2005), S70 (1997-2000), S80 (1999-2005).</p>
UTENSILI OEM	MOT1348 (1), MOT1337 (2), MOT1340 (3)
CODICE MOTORE	<p>RENAULT: N7Q 704/710/711(2.0 16V), N7U 700/701(2.5 20V).</p> <p>VOLVO: B4164S, B4164S2, B4184S, B4184S2, B4184S3, B4184S9, B4184S10, B4194T, BS194T2, B420S4, B4204S2, B4204T, B4204T2, B4204T3, B4204T5, B5202FS, B5204FT, B5204T2, B5204T3, B5204T4, B5204T5, B5234FS, B5204FT, B5234T3, B5234T4, B5234T5, B5234T6, B5234T7, B5234T8, B5234T9, B5244S, B5244S2, B5244SG, B5244SG2, B5244T, B5244T3, B5244T4, B5244T5, B5244T7.</p>

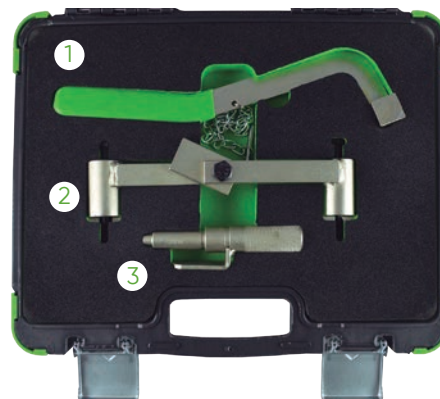

53291

68,00€

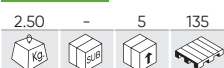

KIT DI ATTREZZI DI REGOLAZIONE CINGHIA DENTATA PER RENAULT

MODELLO	RENAULT: CLIO, LAGUNA, MEGANE
UTENSILI OEM	MOT1496 (1), MOT1489 (2), MOT861/1863 (3), MOT1490(4)
CODICE MOTORE	K4J, K4M, F4P, F4R.

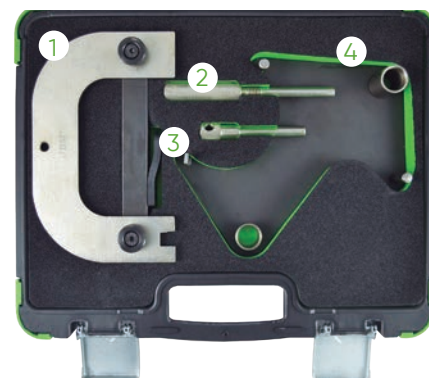

53292

116,00€

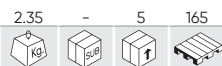

KIT DI ATTREZZI DI REGOLAZIONE CINGHIA DENTATA PER RENAULT/OPEL 2.2, 2.5 TDI DCI

MODELLO	RENAULT: LAGUNA II, ESPACE, MASTER, TRAFIC, 2.2 / 2.5 DCI OPEL: VIVARO, MOVANO, DIESEL: 2.2 / 2.5 DTI, ASTRA B, VECTRA B, SIGNUM, ZAFIRA, 2.2 16V
UTENSILI OEM	KM6205 (1), KM6204 (2), KM6077 (3)
CODICE MOTORE	2.2 / 2.5

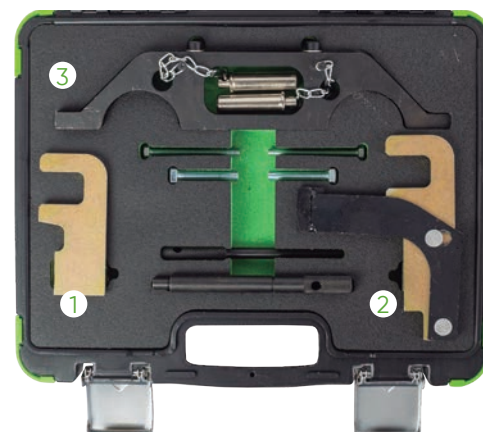

53311

97,00€



KIT DI MESSA IN FASE RENAULT/NISSAN/OPEL/VAUXHALL 2.0, 2.3 DCI, CDTI, M9R, M9T

MODELLO	NISSAN: PRIMASTAR X83 (06-15), QASHQAI/QASHQAI+2 J10 (07-14), X-TRAIL T31 (07-14). VAUXHALL/OPEL: MOVANO-B (10-17), VIVARO (06-15). RENAULT: ESPACE/GRAND ESPACE IV (06-10), KOLEOS (08-15), LAGUNA LL (05-07), LAGUNA LLL (07-14), MASTER LLL (10-15), MEGANE LL (06-10), SCENIC/GRAND SCENIC LL (06-09), SCENIC/GRAND SCENIC LLL (09-15), TRAFIC LL (06-14), VEL SATIS (05-10)
UTENSILI OEM	MOT1769 (1), EN-48334 (2), MOT1766 (3), EN-48330 (3), KM-6130 (4), EN-48332 (5), MOT1773 (6), EN-48831 (6)
CODICE MOTORE	2.0D DCI M9R: 630, 780, 782, 784, 786, 788, 830, 832, 833, 834, 835, 836, 838, 855, 856. 2.0D CDTI M9B: 630, 780, 782, 784, 786. 2.3 BI-CDTI: LP6/M9T706, LW7/M9T706. 2.3D DCI M9T: 670, 672, 676, 678, 680, 686, 690, 692, 694, 698.



53523

91,00€



KIT DI BLOCCAGGIO PER MOTORI DIESEL RENAULT/NISSAN/OPEL 1.6 DCI

MODELLO	RENAULT: ESPACE/GRAND ESPACE IV (06-10), KALEOS (08-11), LAGUNA LL (05-07), LAGUNA LLL (07-12), MASTER LLL (10-12), MAGANE LL (06-10), SCENIC/GRAND SCENIC LL (06-09), SCENIC/GRAND SCENIC LLL (09-12), TRAFIC LL (06-12), VEL SATIS (05-10) NISSAN: PRIMASTAR X83 (06-10), QASHQAI/QASHQAI+2 J10 (07-10), X-TRAIL T31 (07-12). VAUXHALL / OPEL: MOVANO-B (10-12), VIVARO (06-12).
UTENSILI OEM	MOT1969 (1), MOT1970 (2), MOT1770, MOT1773, EN-48330, EN-48332, EN-48334, EN-48831, KM-6130
CODICE MOTORE	M9R 2.0DCI: 610, 615, 630, 700, 721, 740, 742, 760, 761, 762, 763, 780, 782, 784, 786, 788, 800, 802, 803, 805, 808, 816, 830, 832, 833. M9T 2.3DCI: 670, 672, 676, 678, 680, 686, 690, 692, 694, 698.



54210

84,00€

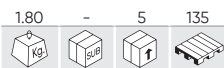

KIT DI ATTREZZI DI BLOCCAGGIO DELLA RUOTA DENTATA DELL'ALBERO A CAMME PER FORD RENAULT 1.8, 2.0 16V

MODELLO	RENAULT LAGUNA II (2001 - 2009), MEGANE II (2002 - 2009), Scenic (2002 - 2009)
UTENSILI OEM	MOT 1509-01 (1), 1509 (2)
CODICE MOTORE	700, 701, 712, 713, 714, 715, 720, 721, 722, 722, 730, 732, 736, 738, 740, 741, 744, 746, 747, 760, 761, 762, 763, 764, 765, 766, 767, 770, 771, 773, 774, 774, 775, 776, 784, 786, 787, 790, 792, 794, 797, 830, F4P, F4R



54225

133,00€



KIT DI BLOCCAGGIO DELLA PULEGGIA DELL'ALBERO MOTORE/DEL VOLANO PER RENAULT/NISSAN

MODELLO	NISSAN: PRIMASTAR (06-15), QASHQAI/QASHQAI+2 (07-14), X-TRAIL (07-14), NAVARA (15-16), NV400 (11-16) RENAULT: ESPACE V (15-16), CLIO (06-16), FLUENCE (09-15), LAGUNA (05-15), LATITUDE (10-15), MEGANE (06-15), SCENIC/ GRAND SCENIC (06-15), ESPACE/GRAND ESPACE IV (02-15), KOLEOS (08-16), TRAFIC II (07-15), VEL SATIS (00-10), MASTER III (10-16)
UTENSILI OEM	MOT 1431(1), MOT 1716(2), MOT 2019(2), MOT 1789(3), MOT 919-02(4)
CODICE MOTORE	1.4: H4JT700 1.6: M5M400, M5M450 2.0: M4R700, M4R701, M4R704, M4R711, M4R713, M4R714, 2.0D: M9R726, M9R730, M9R735, M4R737, M9R740, M4R746, M9R742, M9R744, M9R746, M9R748, M4R750, M4R751, M4R752, M4R753, M4R754, M9R610, M9R613, M95615, M9R630, M9R750, M9R760, M9R761, M9R762, M9R762, M9R763, M9R700, M9R721, M9R722, M9R724, M9R756, M9R780, M9R782, M9R800, M9R802, M9R803, M9R804, M9R805, M9R806, M9R808, M9R809, M9R811, M9R812, M9R814, M9R815, M9R816, M9R817, M9R820, M9R824, M9R828, M9R830, M9R832, M9R833, M9R834, M9R835, M9R836, M9R838, M9R839, M9R844, M9R845, M9R846, M9R849, M9R854, M9R855, M9R856, M9R857, M9R858, M9R859, M9R865, M9R866, M9R784, M9R786, M9R788 2.3D: M9T670, M9T672, M9T676, M9T678, M9T680, M9T686, M9T690, M9T692, M9T694, M9T696, M9T698, M9T700, M9T702, M9T706, M9T708, M9T709, M9T880, M9T890, M9T896, M9T898, M9TC6, YS23DDT, YS23DDTT 2.5: 2TR700, 2TR702, 2TR703, 2TR704, 2TR705, 2ZV604, V4U604, VQ25 3.5: V4Y701, V4Y711, V4Y713, V4Y715



IL TUO KIT DI MESSA IN FASE ANCORA PIÙ VICINO



INSERISCI NELLA PAGINA WEB IL CODICE DEGLI ATTREZZI OEM O IL CODICE DEL MOTORE DELLA TUA AUTO E TROVA IL KIT COMPATIBILE



54289

38,00€

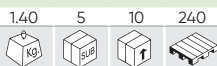

N

KIT BLOCCAGGIO VOLANO MOTORE PER MERCEDES/RENAULT/DACIA/NISSAN

MODELLO	DACIA DOKER 2015 + DACIA DUSTER 2015+ DACIA LODGY 2015+ DACIA LOGAN 2013/-2020 DACIA SANDERO 2013+ MERCEDES-BENZ A-CLASS 2018+ MERCEDES-BENZ B-CLASS 2019+ MERCEDES-BENZ CLA 2019+ MERCEDES-BENZ GLA 2019+ MERCEDES-BENZ GLB 2019+ RENAULT ARKANA 2019+ RENAULT CAPTUR 2018+ RENAULT CLIO V 2019 + RENAULT KADJAR 2018+ RENAULT MEGANE IV 2017+ RENAULT SCENIC/GRAND SCENIC IV 2018+ RENAULT TALISMAN 2018+
UTENSILI OEM	MOT.2188 (1)
CODICE MOTORE	HRT3DDT, H4Bt 400, H4Bt 408, H4Bt 410, H4Bt 411, H4M 730, H4M 738, H4M 740, H5H 450, H5H 470, H5H 480, 282.914



54438

40,00€



N

KIT DI MESSA IN FASE PER RENAULT/NISSAN 3.0DCI

MODELLO	NISSAN: NAVARA PICK UP, PATHFINDER, INFITI RENAULT: LAGUNA, LATITUDE
UTENSILI OEM	MOT 1880 (1) MOT 1970 (2) MOT 1874 (3)
CODICE MOTORE	V9X, V9X 791, 891

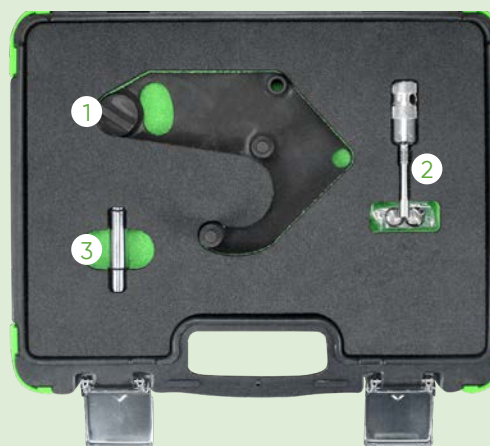

54439

32,50€

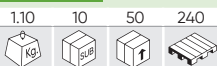

N

BLOCCAGGIO PULEGGIA ALBERO MOTORE RENAULT/DACIA 0.9, 1.0, 1.2, 1.6 TCE

MODELLO	DACIA DOKKER 2012 - 2019, PLUMERO 2013 - 2018, LOGIA 2012 - 2018 RENAULT CAPTURAR 2013 - 2019, CLIO IV 2012 - 2019, KADJAR 2015 - 2018, KANGOO II 2013 - EN, MEGANE III 2012 - 2017, MEGANE IV 2016 - 2020, ESCÉNICO/GRAN ESCÉNICO III 2012 - 2017, ESCÉNICO/GRAN ESCÉNICO IV 2016 - 2018, TWIN-GO III 2014 - EN
UTENSILI OEM	MOT. 2006 (1) MOT. 2054 (1) 281589004000 (1)
CODICE MOTORE	0.9TCe: H4B 453, H4Bt 400, 401, 408, 410, 411, 451. 1.0TCe: H4D, H4D 400, 450, 460, 470 1.2TCe: H5Ft 400, 403, 404, 405, 408, 410, 412. 1.6TCe: H4M 429, 438, 440, 729, 730, 738, 740, 748, 749

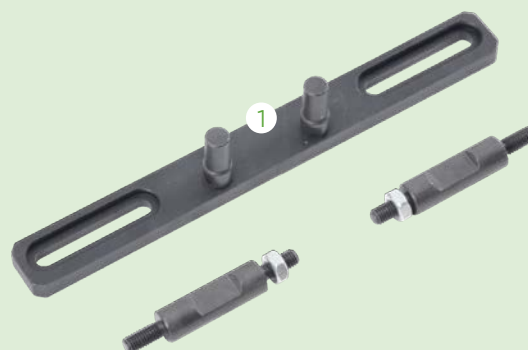

53299

291,00€

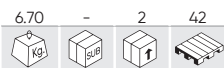

KIT DI ATTREZZI DI REGOLAZIONE CINGHIA DENTATA PER OPEL/VAUXHALL

MODELLO	OPEL / VAUXHALL
UTENSILI OEM	EN-46788 (1), KM927 (2), EN-46789 (3), KM929 (4), EN-46785 (5), EN-46788 (6), 1 860 985 000 (7), KM932 (8), KM933 (9), EN-49978 (10), KM933 (11)
CODICE MOTORE	1.3 CDTI 16V, 1.9 CDTI, 2.0 DTI, 2.2 DTI.



53300

41,00€

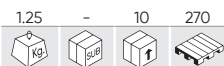

KIT DI ATTREZZI DI REGOLAZIONE CINGHIA DENTATA PER OPEL/VAUXHALL/CHEVROLET 2,0CDI

MODELLO	OPEL VAUXHALL CHEVROLET
UTENSILI OEM	EN-48245 (1), EN-48246 (2), 205083060 (3) (4) (5) (6)
CODICE MOTORE	OPEL / VAUXHALL: Z20DM, Z20DMH CHEVROLET: LLWZ20DMH, RA 420, Z20Si, Z 20S3, Z 20S4, Z 20S5

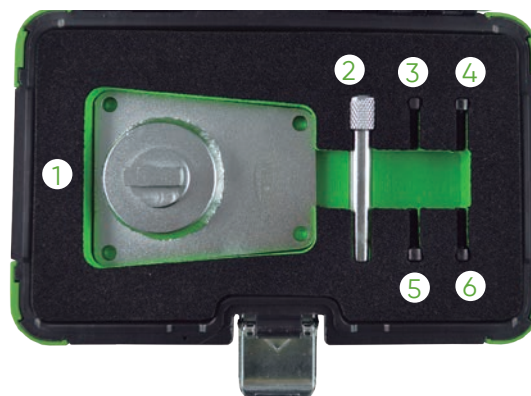

53301

44,00€



KIT DI ATTREZZI DI REGOLAZIONE CINGHIA DENTATA PER SUZUKI/OPEL 1.0, 1.2, 1.4

MODELLO	SUZUKI: WAGON R (05-08). VAUXHALL / OPEL: AGILA (00-08), ASTRA-G (98-06), ASTRA G CLASSIC II (03-10), ASTRA-H (04-11), COMBO (04-12), CORSA-B (97-00), CORSA-C (00-07), CORSA-D (06-12), MERIVA-A (04-10), TIGRA-B (04-10).
UTENSILI OEM	KM-953/09919-58310 (1), KM-952/09912-38310 (2), KM-954/09919-08310 (3), KM-6130 (4), KM-955/09919-58320 (5)
CODICE MOTORE	1.0 12V: X10XE, Z10XE, Z10XEP. 1.2 16V: X12XE, Z12XE, Z12XEP. 1.4 16V/ECOFLEX: Z14XEL, Z14XEP.



53302

44,00€

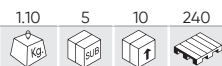

KIT DI ATTREZZI DI REGOLAZIONE CINGHIA DENTATA PER FIAT/ALFA ROMEO/VAUXHALL/OPEL/SAAB JTD

MODELLO	SAAB: 9-3 (04-08), 9-5 (05-08). VAUXHALL / OPEL: ASTRA-H, VECTRA-C, SIGNUM (04-07), ZAFIRA-B (05-07).
UTENSILI OEM	EN46789/32 025 008 (1) (3), EN46788/32 025 009 (2), KM6349 (4)
CODICE MOTORE	Z19DT, Z19DTH, Z19DTL.



53305

136,00€



KIT DI ATTREZZI DI REGOLAZIONE CINGHIA DENTATA PER SAAB/OPEL/VAUXHALL

MODELLO	VAUXHALL / OPEL: ANTARA (06-10), CALIBRA (93-98), CAVALIER/VECTRA-A (93-95), OMEGA-B (94-03), SIGNUM (03-05), SINTRA (96-99), VECTRA-B (95-02), VECTRA-C (02-05). SAAB: 900 (93-98), 9000 (95-97), 9-5 (98-03)
UTENSILI OEM	KM-800-1 (1), KM-800-2 (2), KM-800-20 (3), KM-800-10 (4), 83 95 006 (5), KM-800-30 (6), MKM-6038, 83 95 006 (7)
CODICE MOTORE	2,5 V6: SAAB: B2581, VAUXHALL/OPEL: C25XE, X25XE. 2,6 V6: VAUXHALL/OPEL: Y26SE. 3,0 V6: SAAB: B308E, B308I, VAUXHALL / OPEL: X30XE. 3,2 V6: VAUXHALL/OPEL: Y32SE, .



53307

38,50€



KIT DI ATTREZZI DI REGOLAZIONE CINGHIA DENTATA PER ALFA/OPEL/VAUXHALL 1.6, 1.8 16V

MODELLO	OPEL / VAUXHALL: CORSA-D, AGILA, ASTRA-G-H, MERIVA, ZAFIRA-B, VECTRA-C, SIGNUM, INSIGNA	1.6, 1.8
	CHEVROLET: AVEO, CRUZE, ORLANDO	1.4, 1.6, 1.8
	ALFA ROMEO: 159 FIAT: CROMA	1.8
UTENSILI OEM	E10290 (1), 23056-06 (2) (3), E10230 (4), 23164-04 (5), 23174-01 (6), 23056-05 (7)	
CODICE MOTORE	OPEL / VAUXHALL: Z16LEL, Z16LER, Z16LET, Z16XE1, Z16XEP, Z16XER, A16XER, 18XER, A18XER, 2HO/A18XEL. CHEVROLET: G14D, LDD, LXV (F16D4), 2HO(Z18XER). ALFA / FIAT: 939A4.000.	



53316

34,00€

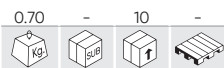

ATTREZZO DI REGOLAZIONE CINGHIA DENTATA PER FIAT/OPEL/VAUXHALL 2.2 16V CADENA

MODELLO	OPEL: ASTRA-G (2000-2006), ASTRA-H (2006-2011), SIGNUM (2003-2008), VECTRA-B (2000-2002, VECTRA-C (2002-2008), ZAFIRA-A (2000-2005), ZAFIRA-B (2005-2012), SPEEDSTER (2000-2006). VAUXHALL: VX220 (2000-2006). FIAT: CROMA (2005-2009).
UTENSILI OEM	VAUXHALL / OPEL: Z22SE, Z22YH FIAT: T94A1.000.



53317

34,00€

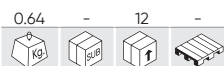

OPEL/VAUXHALL 2.2 BLOCCO POMPA ANTIGELO

MODELLO	OPEL 2.2 Catena VAUXHALL 2.2 Catena
---------	--



53452

26,50€



KIT DI ATTREZZI DI REGOLAZIONE CINGHIA DENTATA PER OPEL/FORD/FIAT/ ALFA ROMEO/LANCIA/ SUZUKI

MODELLO	VAUXHALL/OPEL 1.3 CDTI: AGILA, CORSA, COMBO (03-08), ASTRA-H(05-08), MERIVA, TIGRA-B(04-08) SUZUKI 1.3 DDIS: IGNIS, WAGON R(03-08), SWIFT(04-08) FORD: 1.3 TDCI FIAT/ALFA ROMEO/LANCIA: 1.3 JTD MULTIJET
UTENSILI OEM	104-A EN 46781 (1) , EN 46785 (2)

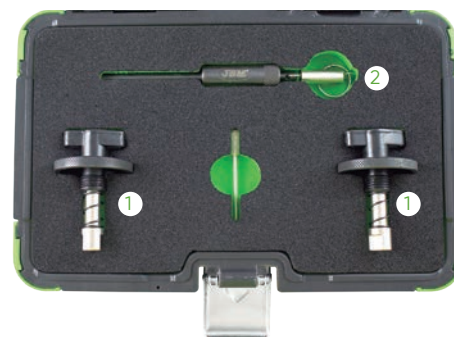

53651

91,00€



KIT DI ATTREZZI DI REGOLAZIONE CINGHIA DENTATA PER OPEL/VAUXHALL 1.0, 1.2, 1.4 TURBO

MODELLO	OPEL: ADAM, AMPERA, ASTRA-J, AVEO, CORSA-D, INSIGNIA, MERIVA-B, MOKKA, ZAFIRA-C TOURER
UTENSILI OEM	EN 49977-100 (1), EN 49977-200 (2), EN 49978 (3), KM 952 (4), KM 953-A (5), KM 955-1 (6), KM 955-2 (7).
CODICE MOTORE	1.0: A10XEP (LDB) 1.2: A12XEL (LWD), A12XER (LDC) 1.4: A14XEL (L2Z), A14XER (LDD), LDU A14NEL (LUH), A14NET (LUJ), TWINPORT / ECOFLEX ENGINES A14XFL (LUU), A14NEL (LDD), A14NEL (LUJ), A12XEL (L2Q)

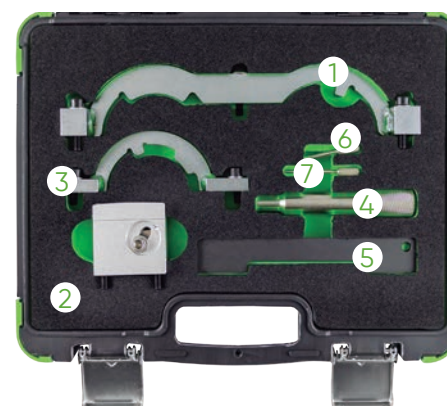

54205

49,00€

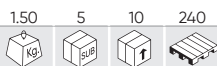

KIT DI ATTREZZI DI CRONOMETRAGGIO DEL MOTORE PER VAUXHALL/OPEL 1.6 CDTI

MODELLO	VAUXHALL/OPEL: Astra J (13-18), Astra K, (15-19), GTC (15-18), Insignia A (15-17), Insignia- B (17-20), Meriva B (13-17), Mokka (14-16), Mokka X (16-20), Zafira C Tourer (13-19).
UTENSILI OEM	EN-6349, EN-6130 (1), EN-51143 (2), EN-51140 (3), EN-50513 (4), EN-51188 (5)
CODICE MOTORE	B16DTC, B16DTE, B16DTH, B16DTJ, B16DTL, B16DTN, B16DTR and B16DTU. D16DTH, D16DTI, D16DTJ, D16DTN, D16DTR, D16DTU



54214

96,00€



KIT DI ATTREZZI DI CRONOMETRAGGIO DEL MOTORE PER OPEL/ISUZU 1.6D, 1.7D

MODELLO	ASTRA, CAVALIES, VECTRA-A(87-00), ISUZU, NOVA, CORSA / COMBO, STRA, CAVALIER, VECTRA, FRONTERA, MONTEREY, MIDI, BRAVA (88-04)
UTENSILI OEM	VAS 6079 (1), KM 951 (2), KM 851 (3), 23-029 (4), KM 661-2 (5), KM 661 (6)
CODICE MOTORE	OPEL : 16DA, 17D, 17DR, X17DTL ISUZU : 4EC1, 4EE1, 4JB1, 4XJ1, 4JA1, 4JG1, 4FC1, 4FD1, 4FG1, Z17DT, Y17DT/DTL

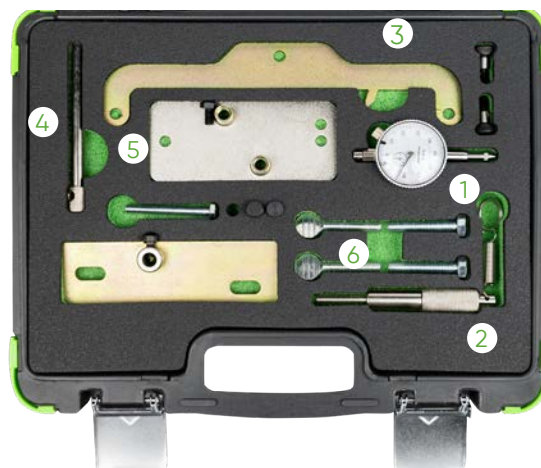

54217

104,00€



KIT DI ATTREZZI DI CRONOMETRAGGIO DEL MOTORE PER VAUXHALL/OPEL/SAAB 2.0, 2.2 DTI

MODELLO	VAUXHALL/OPEL: ASTRA-G (98-06), FRONTERA-B (98-04), OMEGA-B, (98-03), SIGNUM (03-05), SINTRA (98-99), VECTRA-B (97-02), VECTRA-C (02-05), ZAFIRA-A (99-05), SAAB: 9-3 (98-04), 9-5 (02-06)
UTENSILI OEM	SAAB: 83 95 394 (1), 83 95 337 (2), 83 95 352 (3), 83 95 386 (4) VAUXHALL/OPEL/SAAB: KM-927 (2), KM-929 (3), KM-932 (4), KM-933 (1)
CODICE MOTORE	OPEL: X20DTH, X20DTL, Y20DTH, Y20DTL, X22DYH, Y22DTH, Y22DTR SAAB: D223L



54221

111,00€

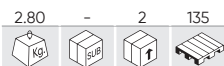

KIT DI ATTREZZI CRONOMETRAGGIO DEL MOTORE PER VAUXHALL/OPEL 1.3 CDTI

MODELLO	VAUXHALL/ OPEL 1.3 CDTI Corsa E Diesel Engine From 2015
UTENSILI OEM	KM-662-C (1), EN-50515 (2), EN-51500 (3), EN-46775 (4), KM-955-1 (5), EN-46785 (6)
CODICE MOTORE	LKU B13DTE, LKU B13DTR



54434

48,50€



KIT DI MESSA IN FASE PER OPEL 1.0, 1.4

MODELLO	VAUXHALL/OPEL ADAM 2014 - 2019, ASTRA-K 2015 - 2019, CORSA-E 2015 - 2019, INSIGNIA-B 2017 - 2020, MOKKA X 2016 - 2019, VIVA (KARL) 2015 - 2020
UTENSILI OEM	EN-51367 (1) EN-51298 (2) EN-51632 (3)
CODICE MOTORE	1.0 L5Q/B10XE, L5Q/D10XE, LE1/B10XFL, LE1/B10XFT, LE1/B10XFL, LE1/D10XFL, LE1/D10XFT, LE1/F10XFL, LE1/F10XFT, LWT/B10XL 1.4 LE2/B14XFL, LE2/B14XFT, LE2/D14XFL, LE2/D14XFT, LFE/B14XNT, LFE/D14XNT, LV7/B14XE 1.5 LFV/B15XHT, LFV/D15XHL, LFV/D15XHT



54435

14,50€

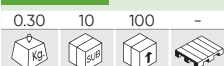

KIT DI MESSA IN FASE PER OPEL/CHEVROLET/SAAB 1.4, 1.6, 1.8 ECOTEC

MODELLO	<u>CHEVROLET</u> : LACETTI (2005-2010), NUBIRA (2005-2010) <u>OPEL/VAUXHALL</u> : ASTRA-G (1998-2004), ASTRA-H (2004-2007), COMBO-C (2005-2012), CORSA-C (2000-2007), MERIVA-A (2003-2010), SIGNUM (2003-2007), TIGRA-B (2004-2010) VECTRA-B (1995-2002), VECTRA-C (2002-2008), ZAFIRA-A (1999-2005), ZAFIRA-B (2006-2013) <u>SAAB</u> : 9-3 (2003-2010)
UTENSILI OEM	KM-911 (1) KM-6130 (2) KM-852 (3), EN-852 (3)
CODICE MOTORE	1.4: X14XE, Z14XE 1.6: X16SEJ, X16XEL, Y16XE, Z16XE, Z16YNG 1.8: F18D3 1.8: X18XE1, Z18XE, Z18XEL, X18E1 1.8: Z18XE

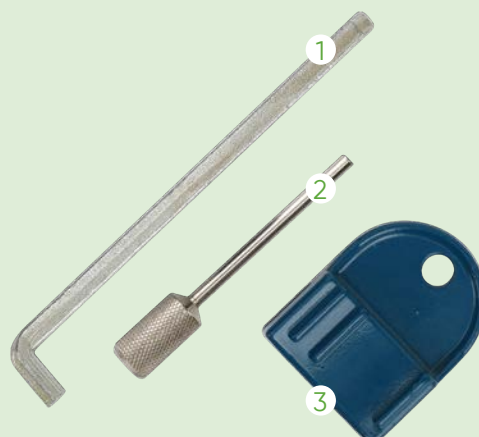

54436

124,00€



N

KIT DI MESSA IN FASE PER OPEL 1.6 SIDI

MODELLO	VAUXHALL ASTRA-J 2013 - 2017,ASTRA-K 2015 - 2019,CASCADA 2013 - 2019,GTC 2015 - 2019,INSIGNIA 2013 - 2017,INSIGNIA-B 2018 - 2020,ZAFIRA-C TOURER 2014 - 2019
UTENSILI OEM	EN 51153 (1) EN 50513 (2) EN 51148 (3) EN 51147 (4)
CODICE MOTORE	1,6 LWC/A16SHT LVP/A16XHT LWC/B16SHL LWC/B16SHT LVP/B16XHT LWC/D16SHJ LWC/D16SHL LWC/D16SHT

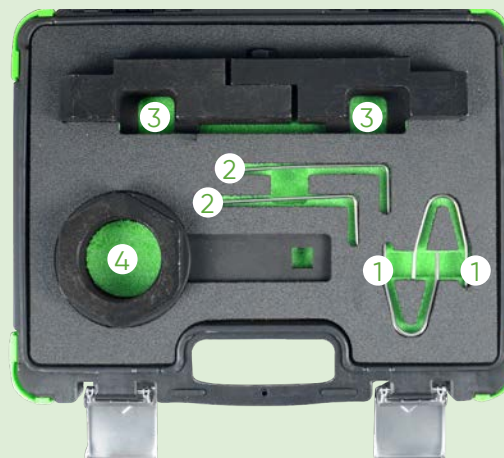

54437

110,00€



N

KIT DI MESSA IN FASE PER OPEL/CHEVROLET/SAAB 2.0, 2.4

MODELLO	CHEVROLET CAPTIVA 2011 - 2015,HHR 2008 - 2009, MALIBU 2012 - 2015 SAAB 9-3 (02-12) 2010 - 2012,9-5 (10-12) 2010 - 2012 VAUXHALL/OPEL ANTARA 2011 - 2016,ASTRA-J 2012 - 2017,GTC (15-19) 2015 - 2019,INSIGNIA-A (08-17) 2008 - 2013
UTENSILI OEM	EN-48585 (1) EN 43653 (2), J 43653 (2) EN 955 10 (3), KM 955 (3) EN-955-20 (4), KM 955-20 (4) EN 45027 1 (5), J 45027 1 (5) EN 45027 (6), EN45027 2 (6), J 45027 2 (6) EN 49212 (7), EN 49212 1 (7) EN 49212 (8), EN 49212 2 (8) EN 48953 (9)
CODICE MOTORE	LHU/A20NFT 2.0: LDK/A20NHT 2.0: LDK/A20NHT, LHU/A20NET, LHU/A20NFT, LHU/B20NFT 2.4: A24XE (LE5), A24XF (LE9) 2.4: LE5,LE9

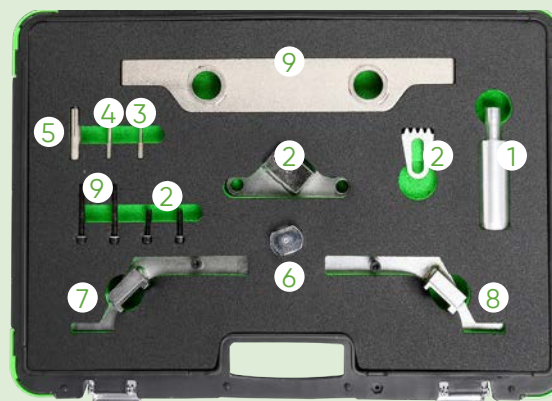

52271

18,00€

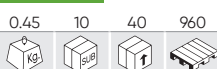

UTENSILI PER LA MESSA IN FASE DELLA DISTRIBUZIONE VAG

MODELLO	AUDI: A2 1.4TDI (02-06), A3 1.9 2.0TDI (02-08), A4 1.6TDI (02-05), A4 1.9 2.0TDI (04-08), A6 1.9TDI (02-05). SEAT: ALTEA 1.9SDI/TDI (05-08), LEON 1.9.0TDI (05-08), TOLEDO 1.9SDI/TDI (05-08). SKODA: FABIA 1.4TDI (03-06), OCTAVIA II 2.0TDI (03-06) VW: BEETLE 1.9TDI (02-08), BORA 1.9TDI (02-08), FOX 1.4TDI (02-08), GOLF 1.9 2.0TDI (02-08), LUPO 1.4TDI (02-08), POLO 1.4, 1.9TDI (02-08), SHARAN 1.9TDI (02-08).
UTENSILI OEM	AUDI: AMF, ASZ, ATD, AVB, AVF, AWW, AXR, AZV, BHC, BKC, BKD, BKE, BLB, BMN, BNA, BPW, BRB, BR, BRD, BRE, BRF, BUY, BVA, BVF, BVG. SEAT: BJB, BKC, BLS, BMM, BXE SKODA: AMF, AZV, BKD VW: AJM, AMF, ANU, ARL, ASZ, ATD, AUJ, AVB, AVF, AWW, AXR, BAY, BMS, BNM, BNV, BWB



51489

12,00€

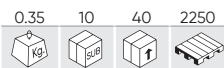

KIT DI BLOCCAGGIO DELL'ALBERO A CAMME VAG 1.4, 1.6

MODELLO	VW: LUPO 99 , POLO 95, CADDY 96, POLO CLASSIC, VARIANT 96, BEETLE 1.4L 99, GOLF 1.4L, 1.6L 98 Y 1.4L, BORA, 1.6L 99. AUDI: A2.
UTENSILI OEM	T10016
CODICE MOTORE	1.4 / 1.6 16V



53274

30,50€



KIT DI ATTREZZI DI REGOLAZIONE CINGHIA DENTATA PER VOLKSWAGEN/SEAT/SKODA 1,2L

MODELLO	VOLKSWAGEN 1.2: LUPO / POLO / EOS / FOX. SEAT 1.2: IBIZA / CORDOBA SKODA 1.2: FABIA
UTENSILI OEM	T10123 (1) (2), T10120 (3), T10121 (4)
CODICE MOTORE	AWY / BMD / AZQ / BME.



53275

35,50€



KIT DI ATTREZZI DI REGOLAZIONE CINGHIA DENTATA PER VW-AUDI

MODELLO	DODGE: CALIBER (06-11) FORD: GALAXY (02-06) MITSUBISHI: GRANDIS (05-10), LANCER (05-10), OUTLANDER (07-10). SEAT: ALHAMBRA (00-15), ALTEA/ALTEA XL (04-15), CORDOBA (02-09), IBIZA (02-15), LEON (00-13), TOLEDO (04-11). SKODA: FABIA (00-14), FABIA II (07-15), OCTAVIA (00-10), OCTAVIA II (04-15), PRACTIK (10-15), RAPID (11-15), ROOMSTER (07-15), SUPERB (02-08), SUPERB II (08-15), YETI (09-14). AUDI: A1 (10-15), A2 (00-06), A3 (01-13), A4/ALLROAD (01-16), A5 (08-15), A6 (11-14), TT (08-14), Q3 (11-15), Q5 (08-15), A6 (10-14). VOLKSWAGEN: AMAROK (10-16), BEETLE (02-15), BORA (02-08), CADDY/MAXI (03-15), EOS (06-15), FOX (05-11), GOLF (02-15), GOLF PLUS (05-14), JETTA (05-15), LUPO (02-05), PASSAT/CC (02-15), POLO (99-14), SCIROCCO (08-14), SHARAN (02-15), TIGUAN (07-15), TOURAN (03-15), TRANSPORTER (03-17).
UTENSILI OEM	DODGE: 9882, 9883. FORD: 310-085/23-059, 303-1054. MITSUBISHI: MB995206, MB995208, MB995209. VAG: T10100 (4), T10050 (1), 3359 (3/6)/T20102, T10115 (3), T10060A (2)/T40098, T20167.
CODICE MOTORE	1.2D TDi CR: CFWA. 1.4D TDi PD: AMF, BAY, BMS, BNM, BNV, BWB. 1.6D TDi CR: CAYA, CAYB, CAYC, CAYD, CAYE, CLNA. 1.9D TDi PD: AJM, ANU, ARL, ASZ, ATD, AUY, AVB, AVF, AVQ, AWX, AXB, AXC, AXR, BJB, BKC, BLS, BLT, BMT, BPZ, BRM, BRR, BRS, BRU, BSU, BSV, BSW, BTB, BVK, BXE, BXF, BXJ. 2.0D TDi CR/TDi PD: AZV, BDJ, BDK, BEW, BGW, BHW, BKD, BKP, BKQ, BLB, BMA, BMM, BMN, BMP, BMR, BNA, BPW, BRA, BRC, BRD, BRE, BRF, BRT, BSS, BST, BSY, BUY, BUZ, BVA, BVE, BVF, BVG, BVH, BWC, BWV, CAAA, CAAB, CAAC, CAAD, CAAE, CAGA, CAGB, CAGC, CAHA, CAHB, CBAA, CBAB, CBAC, CBBA, CBBB, CBDA, CBDB, CBDC, CBEA, CCHA, CCHB, CDBA, CDCA, CEGB, CFCA, CFFA, CFFB, CFFD, CFFE, CFGB, CFGC, CFHA, CFHB, CFHC, CFHD, CFHE, CFHF, CFJA, CGLA, CGLB, CGLC, CGLD, CJAA, CJCA, CJC, CJC, CLCA, CLCB, CLJA, CLLA, CNEA, ECD, ECD/BSY, ECD/BYL, ECE/BWD.

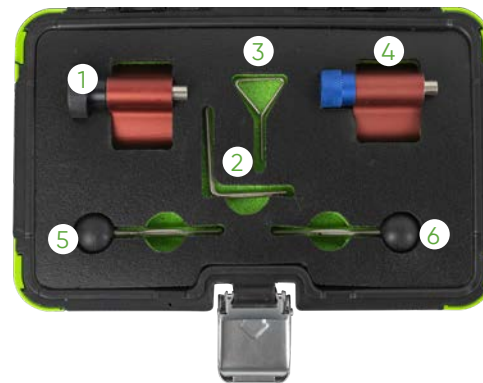

53276

160,00€

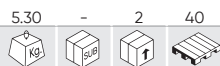

KIT DI ATTREZZI DI REGOLAZIONE CINGHIA DENTATA PER AUDI & SKODA

MODELLO	MOTOR AUDI VW: V6 2.0, 2.8, 3.0T FSI. AUDI Q5: 2.0, A6L 2.8, 3.0T.
UTENSILI OEM	3418 (1), 3458 (2), T10100 (3), T10123 (4), T10121 (5), 3242 (6), 3551 (8), T10020 (9), T10098 (10), 3078 (12), 2064 (13), 3369 (14), T10092 (15), T40011 (17), 2065A (18), T10016 (19), 3359 (20), T10008 (21), T10050 (22) T10265 (23), T10264 (24), T10060A (25), T10120 (27), 3366 (28)
CODICE MOTORE	2.0, 2.8, 3.0

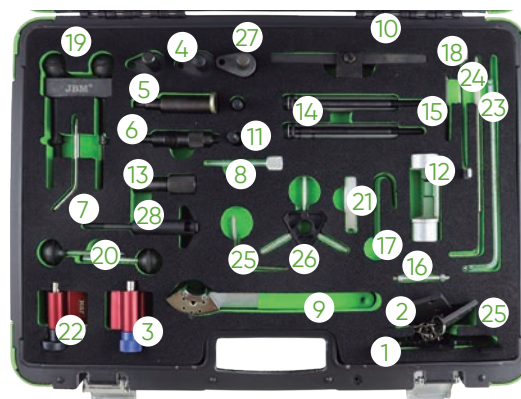

53277

45,00€

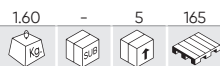

KIT DI ATTREZZI PER LA CINGHIA DI DISTRIBUZIONE VW/AUDI

MODELLO	BENZINA	AUDI: 80, 100, A3, A4, A6 1.6, 1.8/TURBO, 2.0, 2.0 16V, A3, A4 1.6 (96-). SEAT: IBIZA/CORDOBA, TOLEDO, ALHAMBRA, INCA 1.6, 1.8, 1.8 16V, 2.0, 2.0 16V, IBIZA/ CORDOBA, LEON, TOLEDO 1.6 (99-), ALHAMBRA 2.0 (00-). VOLKSWAGEN: POLO CLASSIC, SCIROCCO, CORRADO, GOLF, JETTA, VENTO, PASSAT, SHARAN, TRANSPORTER 1.6, 1.8/TURBO, 1.8 16V, 2.0, 2.0 16V, POLO CLASSIC, GOLF, BORA, BEETLE 1.6 (97-), 2.0 (99-). SKODA: OCTAVIA 1.6 (97-), 2.0 (99-).
	DIESEL	AUDI: 80, 100, A3, A4, A6 1.9 TURBO D, 1.9TDI, 2.5TDI, A3, A4, A6 2.0TDI, A2, A3, A4, A6 1.2TDI, 1.4TDI, 1.9TDI (99-). SEAT: IBIZA/CORDOBA, LEON, TOLEDO, ALHAMBRA, INCA 1.7SDI, 1.9D/TD /SDI/TDI. EORD: GALAXY (02-06). SKODA: FELICIA, OCTAVIA 1.9D/TDI. VW: POLO, POLO CLASSIC, GOLF, JETTA, VENTO, BORA, BEETLE, PASSAT, SHARAN, CADDY, TRANSPORTER 1.5D, 1.6D/ TURBO, 1.7D/SDI, 1.9SDI/TDI, GOLF, PASSAT 2.0TDI.
UTENSILI OEM	T10020 (1), 3387 (2), V159 (3), T10060/T100604 (4), T10115 (5), T40011 (6)	
CODICE MOTORE	2.0, 2.8, 3.0	



53278

143,00€



KIT DI ATTREZZI DI REGOLAZIONE CINGHIA DENTATA PER AUDI 2.8, 3.2 FSI, 3.0 TFSI

MODELLO	A2, A4, A4 QUATTRO, A6 (2004-2007) A2, A3, A4, A3 FSI (2004-2007) A4, A6, A8 3.2 FSI A6 L QUATTRO 2.4 A6 2.4, A6 2.4 QUATTRO (2004-2007) A4 3.2 FSI (2004-2007) A6 3.2 FSI (2004-2007) A8 3.2 FSI (2005-2007)
UTENSILI OEM	T10172 (1), 3212 (2), T40070 (3), T40069 (4), T40071 (5), T10172/2 (6)
CODICE MOTORE	AUK / BDW / BDX / BKH / CAJA / CALA

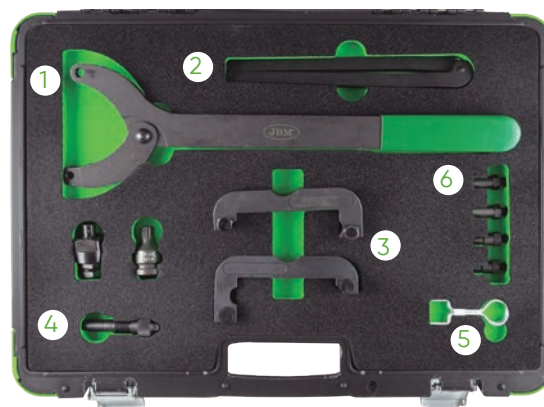

53279

97,00€

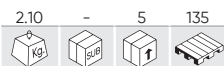

KIT DI ATTREZZI DI REGOLAZIONE CINGHIA DENTATA PER VW/AUDI 1.8, 2.0, TSI, TFSI

MODELLO	AUDI: A3 (96-09), A4 (94-09), A6 (95-11), S3 (99-13), TT (98-14). SEAT: ALHAMBRA (97-10), ALTEA/ALTEA XL (06-09), CORDOBA (99-02), EXEO (09-10), IBIZA (99-02), LEON (99-13), TOLEDO (99-09). SKODA: OCTAVIA/OCTAVIA TOUR (98-10), OCTAVIA II (04-09). VOLKSWAGEN: BEETLE (99-11), BORA (97-04), EOS (06-10), GOLF (97-12), GOLF PLUS (05-09), JETTA (05-09), PASSAT (96-10), SCIROCCO (09-14), SHARAN (97-10), TOURAN (03-09).
UTENSILI OEM	T10020 (1), T10252 (2), T10092 (3), T10115 (4), T40011 (4), 3366 (5), T10060 (6)
CODICE MOTORE	1.8: ADR, AFY, AGN, AJP, APG, APT, AQE, ARG, ARH, AVV. 1.8T: AEB, AGU, AJH, AJL, AJQ, AMK, AMU, ANB, APP, APU, APX, APY, AQA, AQX, ARX, ARY, ARZ, AUM, AUQ, AVC, AWC, AWT, AWU, AYP, BAM, BFV, BVP, BVR. 2.0 FSI: AXV, BHD, BLR, BLX, BLY, BMB, BVX, BVI, BVZ. 2.0 TFSI/S/R/TSI: AXX, BPI, BWA, BGB, BPG, BPJ, BUL, BWE, BWT, BYK, BHZ, BZC, BWJ, BYD, CDLA, CDLB, CDLC, CDLD, CDLF, CDMA.



53280

112,00€

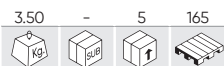

KIT DI ATTREZZI DI ALLINEAMENTO ALBERO A CAMME VW/AUDI 3.0 V6

MODELLO	AUDI: A4 (01-08), A6 (01-08), A8 (03-10).
UTENSILI OEM	3387 (1), T40030 (2) (4), T40026 (3), T40028 (5)
CODICE MOTORE	3.0 V6 30V: ASN, AVK, BBJ, BGN.



53281

55,00€



KIT DI ATTREZZI DI ALLINEAMENTO ALBERO A CAMME VW/AUDI

MODELLO	VOLKSWAGEN: 2.5 TDi V6 AUDI: A4, A6, A8
UTENSILI OEM	3369 (1), 3242 (2), 3458 (3)
CODICE MOTORE	AFB/AKN



53282

48,00€

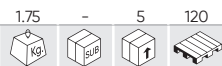

KIT TRAFORO GRUPPO VAG 1.2, 1.4, 1.6

MODELLO	SEAT: ALHAMBRA (10-15), ALTEA/ALTEA XL (08-15), IBIZA/CORDOBA (08-12), LEON (07-13), TOLEDO (07-15). VOLKSWAGEN: BEETLE (11-15), CADDY/CADDY MAXI (10-15), EOS (06-12), GOLF (03-12), GOLF PLUS (03-14), GOLF V ESTATE (07-13), GOLF VI CABRIOLET (10-15), JETTA (06-14), PASSAT (05-11), POLO (02-14), SCIROCCO (08-12), TIGUAN (07-12), TOURAN (03-15). SKODA: FABIA II (07-15), OCTAVIA II (04-15), PRAKTIK (10-15), RAPID (12-15), ROOMSTER (06-15), SUPERB II (09-14), YETI (09-14). AUDI: A1 (10-15), A3 (03-13).
UTENSILI OEM	T10171 (1), T10170 (2), T40011 (3)
CODICE MOTORE	1.2 TFSI: CBZA, CBZB, CBZC. 1.4 FSI: AXU, BKG, BLN. 1.4 TFSI: BLG, BMY, BWK, CAVA, CAVB, CAVC, CAVD, CAVE, CAVF, CAXA, CAXC, CDGA, CSMA. 1.6 FSI: BAG, BLF, BLP, BTS.



53283

92,00€

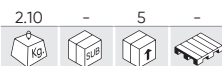

KIT DI SPESSORI GRUPPO VAG 2.7, 3.0 TDI

MODELLO	VOLKSWAGEN: TOUAREG, PHATEON VAG: DIESEL 2.7 / 3.0 V6 AUDI: A4, A5, A6
UTENSILI OEM	3242 (1), T40060 (2) (3), 3359 (4), T40058 (5), T40061 (6), T40062 (7), T40049 (8)
CODICE MOTORE	ASB, BKN, BKS, BWZ, BNG, BPP, BSG, BUG, BUN, CAWA, CAMB, CANA, CANB, CANC, CAND, CAPA, CARA, CARS, CASA, CASE, CASC, CAM, CC/HA, CCWA, CCWB, CDYA, CDVB, CDVC, CEXA, CGKA, CGKB.

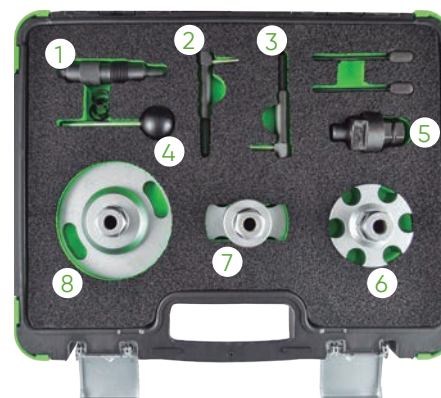

53284

306,00€



KIT TRAFORO GRUPPO VAG 2.5 TDI

MODELLO	VOLKSWAGEN: TOUAREG (03-10), TRANSPORTER (03-09).
UTENSILI OEM	T10225 (1), T10199 (2), T10234 (3), T10226 (4), T10193 (5), T10194 (6), T10199/01 (7), T10226 (8)
CODICE MOTORE	2.5D TDI PD: AXD, AXE, BAC, BLJ, BLK, BNZ, BPC, BPD, BPE.

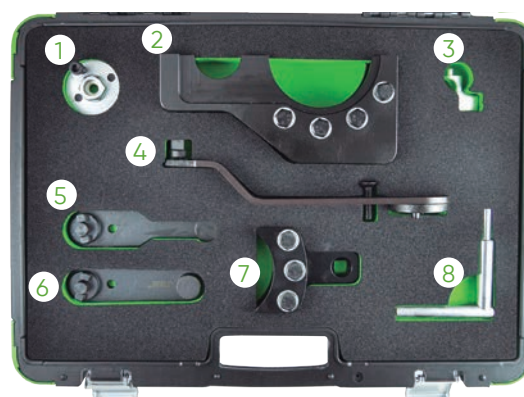

53285

56,00€

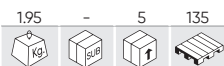

KIT DI ATTREZZI DI REGOLAZIONE CINGHIA DENTATA PER VAG 2.4, 2.5, SDI, TDI

MODELLO	VOLKSWAGEN: CRAFTER (06-13), LT (96-06), TRANSPORTER (90-03).
UTENSILI OEM	2065A (1), T50009 (2), T10025 (3), 3248/3419 (4), 2064 (5), 3355 (6)
CODICE MOTORE	2.4D: AAB, AJA. 2.5D SDI: AGX. 2.5D TDI: ACV, AHD, AHY, AJT, ANJ, APA, AUF, AVR, AXG, AXL, AYC, AYY, BBE, BBF. 2.5D TDI CR: BJJ, BJK, BJL, BJM.



53286

87,00€



KIT DI ATTREZZI DI REGOLAZIONE CINGHIA DENTATA PER VAG VAG 1.8, 2.0 TSI, TFSI

MODELLO	VOLKSWAGEN: 1.8 / 2.0 TSI / TFSI.
UTENSILI OEM	T10368 (2), T10354 (3), T40271 (1)(4), T10352/2 (5), T10352/1 (6), T10352 (7), T40196 (8) (9) (10) (11), T40267(12) (13), T40098 (14), T10060A (15), T40011 (15)
CODICE MOTORE	BYT, BZB, CABA, CABB, CABD, CADA, CAEA, CAEB, CAWA, CAWB, CBFA, CCTA, CCZA, CCZB, CCZC, CDA, CDAB, CDHA, CDHB, CDNB, CDNC, CDND, CESA, CETA, CFKA, CGYA, CJEB, CJBA, CJSB.

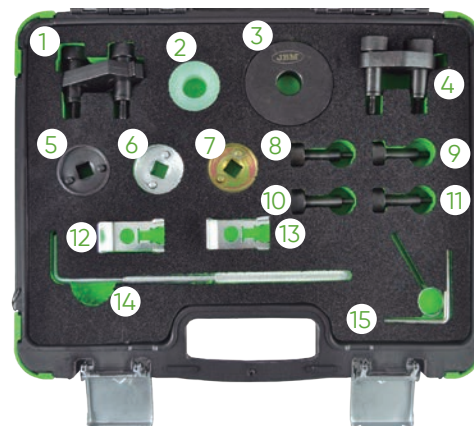

53287

245,00€



KIT DI ATTREZZI DI REGOLAZIONE CINGHIA DENTATA PER VW/AUDI 1.8, 2.0L TURBO

MODELLO	VOLKSWAGEN AUDI	1.8 / 2.0 TURBO
UTENSILI OEM	T10355 (1), T40196 (2), T40271 (3) (4), T10352 (5), T10352/1 (6), T10352/2 (7), T10368 (7), T40267 (8), T10354 (9), T40265 (10), T40011 (11) (14), T40098 (12), T10060A (13)	
CODICE MOTORE	BYT, BZB, CABB, CABD, CADA, CAEA, CAEB, CAWA, CAWB, CBFA, CCTA, CCZA, CCZB, CCZC, CDA, CDAB, CDHB, CDNB, CDNC, CDND, CESA, CETA, CFKA, CGYA, CJEB, CJSA, CJSB.	



53288

72,00€

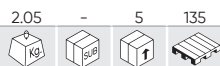

KIT DI ATTREZZI DI REGOLAZIONE CINGHIA DENTATA PER VAG 1.6, 2.0 TDI COMMON RAIL

MODELLO	SEAT: EXEO, LEON, ALTEA, TOLEDO, IBIZA. VOLKSWAGEN: JETTA, TOURAN, GOLF, GOLF PLUS, POLO, PASSAT, TIGUAN, SCIROCCO. SKODA: ROOMSTER, FABIA, PRAKTIK, OCTAVIA, YETI, SUPERB. AUDI: A1, A3, A4, A5, Q5, A6, TT.
UTENSILI OEM	T10264 (1), T10265 (2), T20102 (3), T10052 (4), T10051 (5), T10255 (6), T10050 (7), T10100 (8), T40098 (9)
CODICE MOTORE	1.2 TDI CR, 1.6 D TDI CR, 2.0 D TDI CR CAGA, CAGB, CAGC, CAHA, CAHB, CFHC, CBAA, CBAB, CFFB, CGLA, CGLB, CJCA, CJCB, CAAA, CBAA, CBAB, CBAC, CBBA, CBBB, CBDA, CBDB, CBDC, CCHA, CEGA, CJAA, CAAB, CAAC, CFJA, CFWA, CAYB, CAYC, CAYA.



53320

12,00€

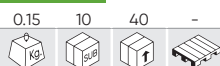

ATTREZZO PER FISSAGGIO ALBERO A GOMITI CON PIASTRA IN ACCIAIO

MODELLO	SEAT: ALHAMBRA, ALTEA, AROSA, CORDOBA, IBIZA, LEON, TOLEDO 1.4/1.9/2.0 TDI. VW: PASSAT 1.9. AUDI: A4/A6 1.9.
UTENSILI OEM	T10008, T20102, T10100.



53321

10,50€



CHIAVE REGOLAZIONE TENSIONAMENTO CINGHIA PER VW AUDI

MODELLO	AUDI: A4/1.8T, 2.0 1999-2004 A6/1.8T 2002-2004 A4/3.0 (2002 -), A6/3.0 (2002 -), A8/7.0 (2003 -). VW: GOLF PASSAT 2.0 TDI DIESEL, GOLF 88-97, PASSAT 92-97, VW T4/2.0 1992-2004.
UTENSILI OEM	T10020

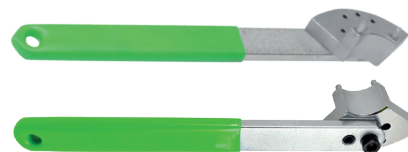

53325

7,50€

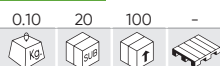

CHIAVE PER PULEGGIA DENTATA 35 MM PER VW AUDI

MODELLO	AUDI: 100 ('91-), A6 (2.5 TDI) 2.3, 2.4, 2.5, 2.8, 2.9D TDI (1991-2003) VW: LT, TRANSPORTER
UTENSILI OEM	3355
CODICE MOTORE	AAB, AAT, ACU, ACV, AEL, AET, AGX, AHG, AHY, AJA, AJT, ANJ, APA, APL, AUF, AVT, AXG, AXL, AYC.



53326

16,00€

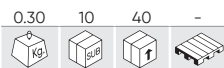

ATTREZZO DI REGOLAZIONE CINGHIA DENTATA PER VW/AUDI

MODELLO	VW: V6 2.5TDi. AUDI: V6 2.5TDi, V8 3.3TDi.
UTENSILI OEM	3458 (1), 3242 (2)



53327

11,00€



ATTREZZO DI REGOLAZIONE CINGHIA DENTATA PER VAG 1.2

MODELLO	SEAT: IBIZA 1.2 6V/3CYL (2002-09), CORDOBA 1.2 12V/3CYL (2002-13). VW: POLO 1.2 6V-12V/3CYL (2002-14). SKODA: FABIA 1.2 6V-12V/3CYL (2002, 2003-), FABIA II 1.2 6V/3CYL (2007-13), ROOMSTER 1.2 12V/3CYL (2006-13), PRAKTIK 1.2 6V/3CYL (2007-13).
UTENSILI OEM	T10123
CODICE MOTORE	1.2 6V: AWY, BMD, BBM, CHFA, CHFB 1.2 12V: AZQ, BME, BXV, BZG, CEVA, CGPA, CGPB, CGPC.



53648

107,00€



KIT DI ATTREZZI PER LA MESSA IN FASE DELLA DISTRIBUZIONE PER VAG 1.0, 1.2, 1.4 TSI

MODELLO	AUDI: A1 (12-15), A1 SPORTBACK (12-15), A3 (13-15), A3 SPORTBACK (12-15). SEAT: IBIZA (12-15), LEON (12-15), TOLEDO (12-15). SKODA: FABIA (10-13), OCTAVIA II (10-13), OCTAVIA III (10-15).
UTENSILI OEM	T10060A (1), T10340 (2), T10476 (3), T10494 (4), T10499 (5), T10504/1 (6), T10504 (7), T10504/2 (8).
CODICE MOTORE	1.2 TSI: CJZA, CJZB. 1.4 TSI: CGGA, CHPA, CMBA, CPVA, CRJA, CXSA. 1.4 TSI ACT: CPTA.

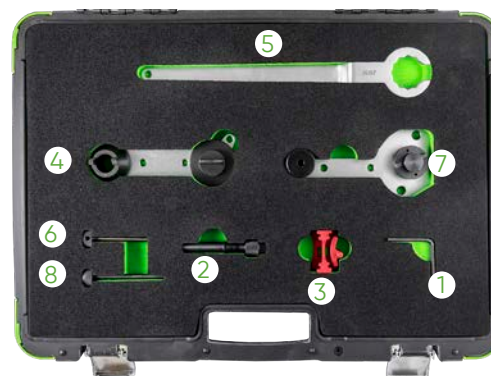

53649

89,00€



SET DI STRUMENTI PER LA FASATURA DEL MOTORE VAG GROUP

MODELLO	AUDI SEAT	SKODA VW
UTENSILI OEM	T10340 (1), T10476 (2), T10477 (3), T10487 (4), T10494 (5), T10499 (6)	
CODICE MOTORE	1.0 MPI; CHYA. 1.0 TSI: CHZE, CHZC, CHZA, CHZB, CHZC, CHZD, CHZJ. 1.2 TSI: CJZB, CJZC, CYVA, CJZA, CJZD, CYVB. 1.4 TSI: CZCC, CMBA, CZCA, CHPA, CPTA (ACT), CZDA, CVNA, CZEA (ACT).	



53706

98,00€



KIT PER CENTRAGGIO DEL L'ALBERO A CAMME VAG 1.4, 1.6, 2.0 TDI COMMON RAIL

MODELLO	VOLKSWAGEN: GOLF ALLTRACK, GOLF SPORTSVAN, GOLF VII, GOLF VII KOMBI, PASSAT, POLO. AUDI: A1, A1 SPORTBACK, A3, A3 CABRIOLET, A3 LIMOUSINE, A3 SPORTBACK, TT, TT ROADSTER. SEAT: IBIZA, IBIZA V SPORTCOUPE, IBIZA V ST, LEON, LEON SC, LEON ST, TOLEDO IV. SKODA: FABIA, FABIA KOMBI, OCTAVIA, OCTAVIA COMBI, RAPID, RAPID SPACEBACK.	
UTENSILI OEM	OEM 3204 (1), OEM 3359 (2), OEM T10490 (3), OEM T10051 (4), OEM T10060A (5), OEM T10264 (6), OEM T10265 (7), OEM T10492 (8), OEM T40098 (9).	
CODICE MOTORE	1.4, 1.6, 2.0 TDI CR CXXB, DBKA, DCXA, GGLE, CKFB, CKFC, CLHA, CLHB, CNHA, CNHC, CRBD, CRFA, CRFC, CRKA, CRKB, CRLB, CRLC, CRMB, CRUA, CRVA, CRVC, CSUA, CSUB, CUNA, CUPA, CUSA, CUSB, CUTA, CUUD, CXEB, DBKA, DCXA, DCZA, DFSD.	

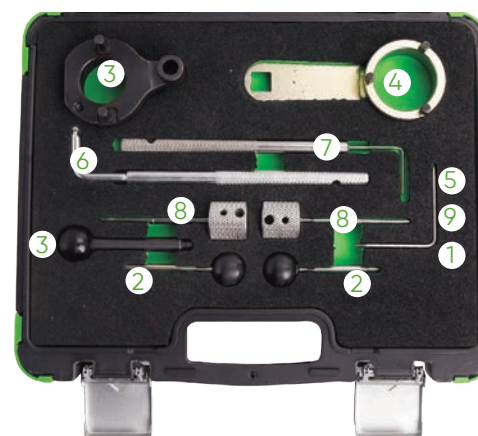

54092

24,00€



KIT DI CONTROLLO E REGOLAZIONE DI FASI DISTRIBUZIONE DEL GAS PER IL MOTORE VAG 1.2 TFSI

MODELLO	AUDI: A1, A3, A3 SPORTBACK, A3 CABRIO SEAT: ALTEA, ALTEA XL, IBIZA, LEON, TOLEDO SKODA: FABIA II, OKTAVIA II, PRAKTIK, RAPID, RAPID SPACEBACK, ROMMSTER, YETI VW: BEETLE, CADDY, CADDY MAXI, GOLF PLUS, GOLF VI, GOLF VI CABRIO, GOLF VI ESTATA, JETTA, POLO, TOURAN	
UTENSILI OEM	T10340(1), T10414(2), T10341(3)	
CODICE MOTORE	CBZA, CBZB, CBZC	



54199

94,00€

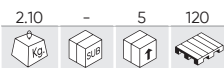

KIT DI ATTREZZI DI CRONOMETRAGGIO DEL MOTORE PER VAG TFSI, FSI

MODELLO	AUDI: A1 (10-15), A1 SPORTBACK (10-15), A3 CABRIOLET (10-13), A3 (10-15), A3 SPORTBACK (03-13) SEAT: ALTEA/ALTEA XL (10-15), IBIZA (10-15), LEON (10-13), TOLEDO (12-15) SKODA: FABIA II (10-15), PRAKTIK (10-15), RAPID (12-15), RAPID SPORTBACK (12-15), OCTAVIA II (04-13), YETI (09-15), YETI OUT-DOOR (13-15) VW: BEETLE (11-15), CADDY/CADDY MAXI (10-15), EOS (07-15), GOLF V (03-13), GOLF V ESTATE (07-09), GOLF VI (10-13), GOLF VI ESTATE (10-13), GOLF VI CABRIOLET (11-15), GOLF PLUS (05-14), JETTA (05-14), PASSAT (05-15), POLO (09-14), SCIROCCO (08-14), TIGUAN (07-15), TOURAN (03-15)
UTENSILI OEM	T10414 (1), VAS 6079 (2), T10170 (3), T10171/ T10171A (4), T40011 (5), T10340 (6), T10341 (7)
CODICE MOTORE	1.2 TFSI: CBZA, CBZB, CBZC 1.4 TFSI/TFSI: BLG, BMY, BWK, CAVA, CAVB, CAVC, CAVD, CAVE, CAVF, CAXA, CAXC, CDGA, CSMA 1.6 FSI: BAG, BLF, BLP



54218

142,00€



KIT DI ATTREZZI DI MONTAGGIO PER AMMORTIZZATORE DI VIBRAZIONI VAG

MODELLO	AUDI, SEAT, SKODA, VOLKSWAGEN
UTENSILI OEM	T10531/1 (1), T10531/2 (2), T10531/3 (3), T10531/4 (4)
CODICE MOTORE	1.8L TFSI: BZB, CDA, BPU, BYT, CABA, CABB, CDHA, CDHB, CABD, DAJB, CJA, CJSB, CJEB, CJEE, CJED, CYGA, CDAC, CJSC, CGYA, DAJA 2.0L TFSI: CAWB, CCZA, CBFA, CCTA, CDNB, CDNC, CDND, CJXA, CJXE, CJXH, CHHB, CHHA, CULA, CFKA, DEDA, CHJA, CAWA, CCZC, CCZD, CPSA, CJK, CESA, CETA, CFPA, CNCD, CPLA, CYRB, CYRC; CNCE, CYNB, CYP, CULB, CULC, CNCB, CWZA, CJXF, CJXC, CJXB, CJXG, CHHC, CCZB



54407

397,00€



N

KIT ATTREZZI PER MONTAGGIO ALBERO A CAMME PER VAG/PORSCHE

MODELLO	AUDI, PORSCHE, SEAT, SKODA, VOLKSWAGEN 1.2 - 1.6 - 2.0 - 2.7 - 3.0 - 4.0 - 4.2 COMMON RAIL
UTENSILI OEM	T40094, T40094/1 (1), T40094/2 (2), T40094/3 (3), T40094/4 (4), T40094/5 (5), T40094/6 (6), T40094/7 (7), T40094/8 (8), T40094/9 (9), T40094/10 (10), T40094/11 (11), T40094/12 (12), T40095 (13), T40096 (14), T40096/1 (15)
CODICE MOTORE	ASB, ASE, BKN, BKS, BMK, BNG, BPP, BSG, BTR, BUG, BUN, BVN, CAAA, CAAB, CAAC, CAAD, CAAE, CAGA, CAGB, CAGC, CAHA, CAHB, CAMA, CAMB, CANA, CANB, CANC, CAND, CAPA, CARA, CASA, CASB,CASC, CASD, CATA, CAYA, CAYB, CAYC, CAYD, CAYE, CBAA, CBAB, CBAC, CBBA, CBBB, CBDA, CBDB, CBDC, CCFA, CCFC, CCHA, CCHB, CCLA, CCMA, CCWA, CCWB, CDBA, CDCA, CDSB, CDTA, CDTB, CDUC, CDUD, CDYA, CDYB, CDYC, CEGA, CEXA, CFCA, CFFA, CFFB, CFFD, CFFE, CFGB, CFGC, CFGD, CFHA, CFHB, CFHC, CFHD, CFHE, CFHF, CFJA, CFWA, CGKA, CGKB, CGLA, CGLB, CGLC, CGLD, CGLE, CGQB, CJAA, CJCA, CJCB, CJCC, CJCD, CJGA, CJGC, CJGD, CJMA, CKDA, CKTB, CKTC, CKUB, CKUC, CKVB, CKVC, CLAA, CLAB, CLCA, CLCB, CLJA, CLLA, CLNA, CLZB, CMEA, CMFA, CMFB, CMGB, CMHA, CNEA, CNFA, CNRB, CRCA,CSHA, M05/9D(CAS), M05/9E, M05/9E(CRCA), M05/9E(CRCB)



54408

46,00€



N

SET DI STRUMENTI PER LA FASATURA DEL MOTORE VAG DIESEL 1.7, 1.9, SDI, TDI

MODELLO	AUDI: A3, A4, A6, CABRIOLET, SEAT: ALHAMBRA, AROSA, CORDOBA, IBIZA, INCA, LEON, TOLEDO, SKODA: FELICIA, OCTAVIA VW: BORA, CADDY, FOX, GOLF, LT, LUPO, PASSAT, POLO, SHARAN, TRANSPORTER, VENTO
UTENSILI OEM	T1020 (1), 2587 (2), 2065A (3), T20044 (4), T10098 (5), T40011 (6), 2064 (7), T3359 (8), T10092 (9), M5x60M (10)
CODICE MOTORE	1.7TDI/SDI: AHB, AHG, AKU, AKW 1.9TDI/SDI: 1X, 1Y, 1Z, ABL, AAZ, AEF, AEY, AFF, AFN, AGD, AHF, AHH, AHU, AGP, AGR, ALE, ALH, AQM, ASV, ASY, ASX, AVG, AYQ 2.4D: 1G, 1S, DW, DV, ACL, ACT

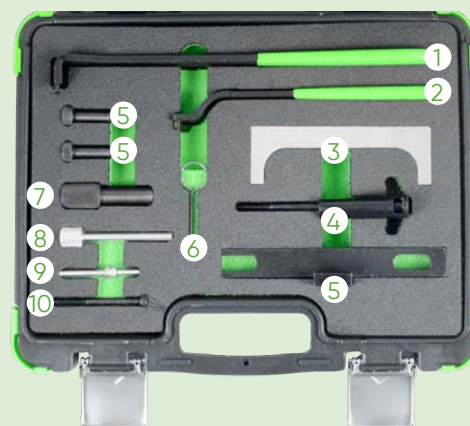

54409

32,00€

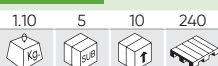

N

KIT DI MESSA IN FASE PER VAG 1.4 TSI

MODELLO	ATECA (2016-) A3 (2012-) SUPERB (2015-) A1 SPORTBACK (2012-2018) LEON/LEON ST (2012-2020) MK5 (2012-2018) Q2 (2016-) Q3 (2015-2018)
UTENSILI OEM	T10340 (1) T10504 (2) T10504/1 (3) T10504/2 (4)
CODICE MOTORE	1.4 TFSI (CoD)-CPTA, CZEA 1.4 TSI (ACT)-CPTA, CZEA



54410

33,50€



N

KIT DI MESSA IN FASE PER VAG 2.4, 3.2 FSI

MODELLO	AUDI: A4, A5, A6, A7, A8, Q5, Q7, R8, RS4, RS5, RS6, S4, S5, S6, S8 VW: TOUAREG
UTENSILI OEM	T40058 (1) T40069 (2) T40071 (3) T40133 (3) T40133/1 (3) T40133/1/2 (3) T40133/2 (3) 40071 (4)
CODICE MOTORE	2.4: BDW 3.2: AUK, BKH, BPK 4.2: BAR, BNS, BVJ, CAUA, CDRA, CFSA, BYH, CNDA 5.0: BUH 5.2: BSM, BUJ, BXA, CMPA, CTPA, CTYA



54411

36,00€



N

KIT DI MESSA IN FASE PER VAG/PORSCHE 2.4, 2.8, 3.0 TFSI

MODELLO	AUDI: A4 (2011-2015) A5 (2007-2017) A6 (2007-2018) A7 (2010-2018) A8 (2010-2018) A8 (2010-2018) Q7 (2010-2018) S4 (2009-2017) S5 (2010-2017) S5 (2010-2017) Q5 (2008-2017) SQ5 (2013-2018) PORSCHE: CAYENNE (2010-2014) PANAMERA 2011-2013 VAG: TOUAREG (2010-2014)
UTENSILI OEM	T40133/1 (1) T40133/2 (2) T40058 (3) T40069 (4) T40071 (5)
CODICE MOTORE	AUDI: 2,5 CLXB, CPAA 2,8 BDX, CCDA, CCEA, CHVA, CJBA, CNYA 3,0 CAJA, CAKA, CCAA, CGEA, CGWA, CGWB, CGWC, CGWD, CGXB, CGXC, CHMA, CHMB, CJTB, CJTC, CJWC, CMDA, CMUA, CNA, CREA, CREC, CRED, CTTA, CTUA, CTUD, CTVA, CTWA, CTXA 3,2 CALA, CALB PORSCHE: 3,0 M06/EC VAG: 3,0 CJTA, CGFA



54412

57,00€



N

KIT DI MESSA IN FASE PER AUDI 2.5 TFSI

MODELLO	AUDI: RSQ3 (2013-2015), RSQ3 (2015-2018), RS3 (2010-2013), RS3 (2015-2017), TT (2009,2014)
UTENSILI OEM	T03003 (1) T40264/1/2 (2), T40264/2A (2) T40069 (3) T40011 (4) T40297 (5)
CODICE MOTORE	2,5 TFSI/RS CEPA, CEPB, CTSA, CZGA, CZGB



54413

115,00€



N

KIT DI MESSA IN FASE PER AUDI 4.0 FSI, TFSI

MODELLO	AUDI: A8, RS6, RS7, S6, S7, S8 (2012-2018)
UTENSILI OEM	T40071 (1) T40257 (2) T40264/1 (3) T40264/2 (4) T40264/3 (5) T40269 (6) T40272 (7)
CODICE MOTORE	CEJA CEUC CGTA CRDB CTFA CTGA CTGE CWUB CWUC DDTA

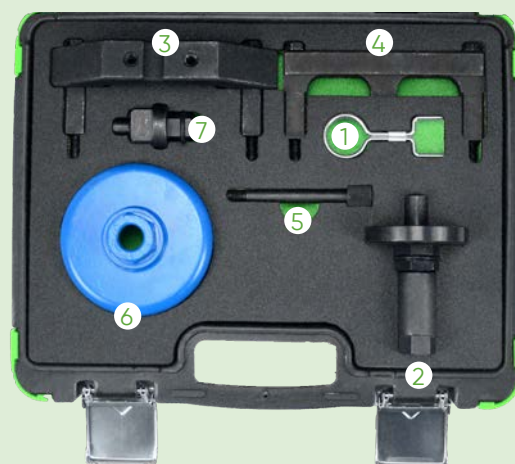

54431

184,00€



N

KIT DI MESSA IN FASE PER ALFA ROMEO/MASERATI 2.9

MODELLO	ALFA ROMEO: GIULIA, STELVIO MASERATI: 3,8T
UTENSILI OEM	1860815000 (1) 2024000090 (2) 2024100000 (3)
CODICE MOTORE	2.9: 670050436,670051007 ,670052721 ,670052722



53315

285,00€



KIT DI ATTREZZI DI REGOLAZIONE CINGHIA DENTATA PER VOLVO 3.0, 3.2T6 / LAND ROVER 3.2

MODELLO	VOLVO: S60 (10-16), S80 (07-15), XC60 (08-15), XC70 (06-15), XC90 (10-14), V60 (10-15), V70 (10-15). LAND ROVER: FREELANDER II (11-14).
UTENSILI OEM	VOLVO: 999-7263 (3), 999-7264 (1), 999-7272 (5), 999-7257 (2), 999-7261 (4). LAND ROVER: 303-1225 (3), 303-1226 (1), 303-1219 (2), 303-1223 (4).
CODICE MOTORE	3.0 TURBO: B6304T2, B6304T4. 3.2: B6324S, B6324S5. 3.2i6: B6324S.

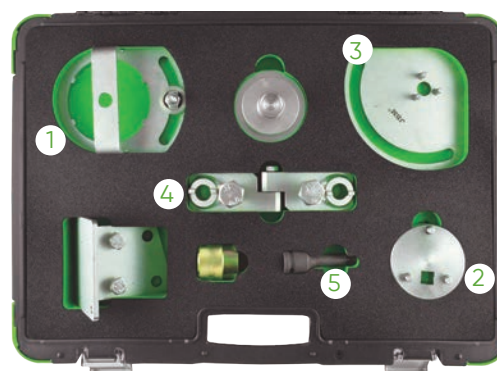

54226

71,00€



SET DI ESTRATTORI PER PULEGGIA POMPA AD ALTA PRESSIONE PER HYUNDAI/KIA

MODELLO	HYUNDAI: ACCENT (11-15), ELANTRA (07-10), I20 (09-18), IX20 (10-18), I20 COUPE (15-17), I30 (07-19), IX35 (10-16), I40 (11-18) KIA: CARENS (13-18), CEED (07-18), OPTIMA (11-15), PRO-CEED (08-19), RIO (09-17), CERATO (05-07), SOUL (09-14), SPORTAGE (10-18), VENGA (09-18)
UTENSILI OEM	09331-2A000/2A010 (1), 09331-2A010 (1)
CODICE MOTORE	1.1D CRDI: D3FF 1.4D CRDI: D4FC(U1), D4FC(U2) 1.6D CRDI: D4FB(U1), D4FB(U2), D4FB-H(U1), D4FB-H(U2), D4FB-L(U1) 1.7D CRDI: D4FD(U2), D4FD-H(U2), D4FD-L, D4FD-L(U2)



54200

56,00€

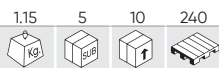

KIT DI ATTREZZI DI CRONOMETRAGGIO DEL MOTORE PER PORSCHE

MODELLO	911 (2001 - 2008), BOXSTER (2002 - 2011), CAYMAN (2006 - 2009)
UTENSILI OEM	9685 (1), 9686 (2), 9595 (3), 9595/1 (4)
CODICE MOTORE	M96/03, M96/05, M96/23, M96/25, M97/20, M96/24, M96/26, M97/01, M97/21, M97/22.

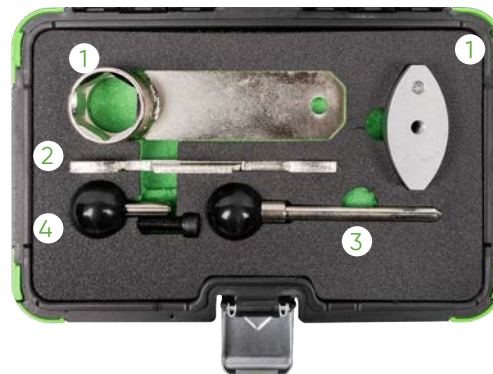

51927

25,00€



KIT DI SMONTAGGIO E MESSA IN TENSIONE DI CINGHIE POLY-V

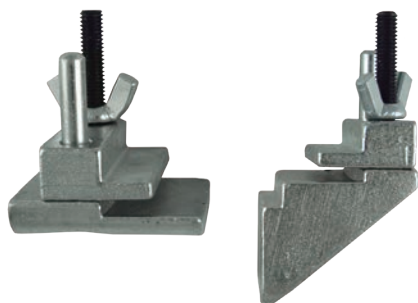

51340

39,30€



CHIAVE UNIVERSALE PER ALBERO A CAMME + ADATTATORI



52616

44,00€



TENSIOMETRO PER CINGHIA DI DISTRIBUZIONE

- Due misure di regolazioni con lettura anteriore e posteriore.

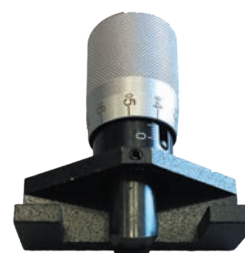

53769

178,00€



MODULO DI REGOLAZIONE CINGHIA DENTATA PER RENAULT/NISSAN/OPEL/VOLVO

MODELLO	<p>RENAULT: AVANTIME, CLIO, ESPACE, KANGOO, LAGUNA, MASTER, MEGANE, MODUS, SCENIC, TWINGO, TRAFFIC.</p> <p>OPEL/VAUXHALL: MOVANO, VIVARO.</p> <p>DACIA: DOKKER, DUSTER, LOGAN, SANDERO.</p> <p>NISSAN: ALMERA, INTERSTAR, KUBISTAR, MICRA, NOTE, PRIMERA, QASHQAI.</p> <p>VOLVO: S40, V40</p>
UTENSILI OEM	<p>MOT 1312 (1), MOT 1135-01 (2), MOT 1384 (3), MOT 1340 (4), MOT 1543 / KM-6234 / KV113 B0360 (5), MOT 1489 / KV113 B0130 (6), MOT 1536 / KM-6203 (7), MOT 1489 (8), MOT 1054 / KM-6031 / KV113 / B0280 (10), MOT 1318 (11), MOT 910 (12), MOT 910 (14), MOT 1386 (15), MOT 1534 / KM-6205 (16), MOT 1543 / KM-6234 / KV113 B0360 (17), MOT 1543 / KM-6234 / KV113 B0360 (18), MOT 1543 / KM-6234 / KV113 B0360 (19), MOT 1543 / KM-6234 / KV113 B0360 (20), MOT 1386 (22), MOT 1537 / KM-6204 (23), MOT 1348 (24), MOT 1538 (25), MOT 1337 (26), MOT 1496 / MOT 1750 (27), MOT 1490-01 (28), MOT 1200-01 (29)</p>
CODICE MOTORE	<p>PEROL: 2.0 16V, 2.5 20V, 1.4, 1.6 16V, 1.8, 2.0 16V, 1.2, 1.7, 1.8, 2.0 16V, 2.2</p> <p>GASOIL: 1.9, 2.5, 2.8</p> <p>D4F702/706/708/712/714/716/722/728/730/740/764, D7F700/701/710/720/722/726/730/744/746/764/766, E7F700/704/706/750, E7J601/624/626/634/635/680/700/706/710/711/716/718/719/720/724/726/728/740/742/745/754/756/757/764/770/771/773/780, F3P670/682/700/704/706/708/710/712/714/720/724/755/758/760, F7P704/722, F3R611/722/723/728/729/750/751/752/791/796/797/798, F5R700/701/740, J7R732/733/734/735/768, F7R710/714, J7T600/760/761/762/766/772/780/782, NTQ704/710/711, N7U700/701, K4J700/710/711/712/713/714/715/730/732/740/750/770/780, K4M700/701/704/706/707/708/709/710/711/712/714/716/718/720/724/730/732/734/736/740/742/743/744/745/746/748/750/752/753/754/760/761/762/764/765/766/768/776/782/788/790/791/794/800/801/802/804/812/813/830, K9K700/702/704/706/710/712/714/716/718/722/724/728/729/732/734/740/750/752/760/762/764/766/768/802/804/806, F9Q610/650/664/670/674/71/716/717/718/720/722/730/731/732/733/734/736/738/740/744/748/750/752/754/758/759/760/768/762/770/772/774/780/782/784/786/788/790/796/800/803/804/808/812/816/818/820, G9T600/605/700/702/703/706/707/710/712/720/722/742/743/750, G9U720/724/726/730/750/754, F8M736/760, F8Q600/610/606/620/622/624/630/632/640/644/646/648/662/672/678/680/682/684/692/696/706/714/720/722/730/732/740/742/744/764/768/706/776/784/786/788, J8S620/621/622/758/760/776/778, G8T714/716/740/752/760/790/792/794, S8U720/722/730/731/742/748/750/752/770/772/780/782, S9U700/702/704/714/740, S9W700/702/206/208/212, ESF, E6J, K7M, F4P/F4R, FIN, F2N, F3N, F2R, F3P, F4P, F3R, J5T, J6R, J7R</p>



53773

298,00€

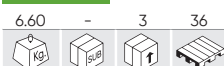

MODULO DI REGOLAZIONE CINGHIA DENTATA PER FIAT/ALFA/LANCIA/OPEL/SUZUKI/FORD

MODELLO	<p>ALFA: ROMEO 145, 146, 147, 155, 156, 159, 166, SPIDER, GTV, TS, GT, CROSSWAGON Q4</p> <p>FIAT: PUNTO, GRANDE PUNTO, BRAVA, BRAVO, MAREA, WEEKEND, STILO, DOBLO, CARGO, IDEA, PANDA, MULTIPLA, PALIO, STILO, 500</p> <p>LANCIA: LYBRA, YPSILON, THESIS, MUSA</p> <p>OPEL: CORSA, AGILA, MERIVA, COMBO, VECTRA, ZARA, ASTRA, INSIGNA, SIGNUM 19 CDTI</p> <p>SUZUKI: IGNIS, SWIFT, WAGON R+</p> <p>FORD: KA</p>
UTENSILI OEM	<p>1860874000 (1), 1860874000 (2), 2000004400 / 2190754400 (3), 1860863000 (4), 1860898000 (5), 2190754500 (6), 2000004300 (7), 1870900400 (8), 1860703000 (9), 1860933000 (10), 1860845000 (11), 1870900300 (12), 1860905000 / EN-46788 (13), 1895443000 (14), 1860992000 (15), 1870896900 (16), 1860987000 (17), 1860905000 (18), 1860771000 (19), 1860161000 (20), 1860876000 (21), 1860876000 (22), 1871000900 (23), 1860985000 (24), 2000004200 / 2190754200 (25), 1860965000 (29)</p>
CODICE MOTORE	<p>176B9.000, 182B2.000, 188A5.000, 843A1.000, 323.02, 371.01, 182B4.000, 182B9.000, 186A6.000, 188A2.000, 188A7.000, 188B2.000, 192A1.000, 192A3.000, 937A2.000, 939A1.000, 192A5.000, 192B1.000, 198A5.000, 937A5.000, 939A2.000, 325.01, 342.02, 362.02, 185A6.000, 841C.000, 841G.000, 939A3.000, 940A3.000, 940A4.000, 940A5.000, Z19DT/DTH/DTR/DJ/DTL, 169A1.000, 955A4.000, 350A3.000, 192B4.000, 198A2.000, 350A2.000, 955A3.000, 192A8.000, 198A6.000, 198A3.000, 199B1.000, 199B2.000, 199A2.000, 199A3.000, 199A9.000, 188A3.000, 188A8.000, 188A9.000, 192A9.000, 186A8.000, 186A9.000, 199A5.000, 223A7.000, 223A9.000, 841H.000, 841P.000, 185A2.000, Z13DT, Z13DTJ, Z13DTH, 182A4.000, 182A6.000, 182B6.000, 178B3.000, 186A3.000, 186A4.000, 350A1.000, 169A4.000, 188A4.000, 199A4.000, 199A7.000</p>



53770

198,00€

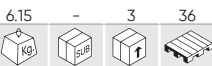

ATTREZZO DI REGOLAZIONE CINGHIA DENTATA PER FORD/SEAT/VOLKSWAGEN/MAZDA/VOLVO

MODELLO	FORD: FIESTA, FUSION, COURIER, ESCORT, FOCUS, FOCUS C MAX, PUMA, MONDEO, SIERRA, COUGAR, GALAXY, C-MAX, ORION, TOURNEO CONNECT, TRANSIT, TRANSIT CONNECT. VW: SHARAN. SEAT: ALHAMBRA. MAZDA: I21. VOLVO: S40, V50.
UTENSILI OEM	303-1061 (1), 303-1054 (2), 23-059 / 310-085 (3), 21-105 (4), 323-029 (6), 0194-B / 21-263 / 303-735 / 49 JE 02 021 (7), 0132-AB / 0178-D / 21-151 (9), 0194-C, 21-262, 303-734, 49 JE 02 020 (10), 21-238 / 303-679A / 303-1151 (11), 21-238 / 303-679A / 303-1151 (12), 303-1054 (13), 303-1151 (14), 21-238 / 303-679A (15), 303-393 / 303-393-02 (16), 303-1097 (17), 21-168 / 303-393 (18), 303-0985 (20), 2064 / 23-047 / 310-055 / U20003 (21), 303-652 (22), 21-229, 303-651 (23), 303-748 (24), 21-210 (25), 21-260, 303-732 (26), 21-163, 303-620 (27), 21-234 / 21-251 (28), 303-675 / 303-698 (29), 21-104 / 303-193 (30) / 21-162B / 303-367 / 303-376 (31), 21-162B / 303-376 / 303-376B (32), 23-019 (33), 23-058 / 310-084 (34), 0153-M / 0178-C / 0178-D (35), 0178-B / 5711-TB (36), 21-123 (37), 23-020 (38), 21-234 / 21-251 (39), 303-1059 (40), 23-019 (41), 303-1060 (42), 303-393 / 303-393-01 (43)
CODICE MOTORE	FUJA, FUJB, FXJA, FXJB, FXJB, FYJA, FYJB, F8JA, F8JB, M7JA, M7JB, DHA, DHB, DHC, DHD, DHE, DHF, DHG, FHA, FHE, LIT, LIV, LIE, LIG, LIH, LIK, RDA, RDB, RKC, RQB, RQC, FXDA/C, FXDB/D, FYDA/C, FYDB/D, FYDH, HWDAIZ, AHU, AVG, AFN, D24, D24T, D24TIC, RFN, RTJ, RTK, RVA, RFK, RKD, B4164S3, DV4TD (8HW/8HX/8HZ), DV4TED4(8HV/8HY), DV6ATED4 (9HX/9HY/9HZ) F6JA, F6JB, F6JC, G8DA, G8DB, KKDA, SNJA, SNJB, STJA, STJB, ASDA, ASDB, FXJC, SPJA, SPJC, FYJC, HWDA, HWDB, SHDA, SHDB, SHDC, JQDA, LQDB, JTDA, JTDB, HXDA, HXJA, HXJB, IQDA/B, IQDB, PNBA, PNDA, RHBA, SIDA, F6JD, TZJA, TZJB, HHDA, HHDB, HHJA, HHJC, HHJD, HHJE, HHJF, RTA, RTB, RTC, RTD, RTE, RTF, RTH, RTJ, RTK, RFN, BHPA, HCPA, HCPB, KKDA, P7PA, P9PA, P9PB, R2PA, R3PA, RWPA, RWPC, F9DA/B, FFBA, FFWA, KHBA, QYBA, QYWA, KKDB, C9DC, RVA, 1Z, AFN, AHU, ANU, AUY, G6DA, G6DB, G6DC, G6DD, G6DE, G6DF, G6DG, UFDB, TXDB, TYDA, UKDB, QXBA, AZBA, KLBA, QXBB, LPBA, AZCB, TYBA, UKBA, UFBA, TXBA, IXDA, QXWA, QXWB, AZWA, KLWA, AZWC, TYWA, UKWA, TXWA, UFWA, UFDA, TXDA, UKDA, Q4BA, KNBA, 4BA, 4BB, 4BC, 4CC, 4FA, 4CA, 4CB, 4DA, 4EA, 4FA, 4FB, 4FC, 4FD, 4GA, 4HB, 4HC, 4EB, 4EC, 4ED 4GA, 4GB, 4GC, 4GD, 4GE, 4GF, 4HA, 4HD, FMBA/B, D5BA, ABFA, D3FA, D6BA, HJBA/B, F3FA, D2FA, D4FA, F4FA, F5FA, DOFA, QJBA, QJBB, QJBC, QJBD, FXFA, H9FA, H9FB, N7BA, N7BB, MZ-CD 1.6, Y6

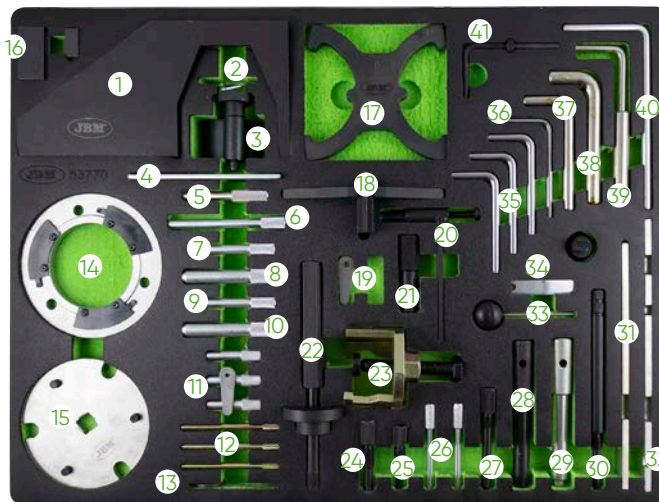

53774

190,00€

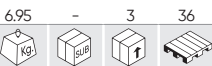

ATTREZZO DI REGOLAZIONE CINGHIA DENTATA PER OPEL/CHEVROLET/SAAB/FIAT/LANCIA/SUZUKI/FORD

MODELLO	ALFA: 145, 146, 147, 156, 159, 166, GT, CROSSWAGON Q4 FIAT: PUNTO, GRANDE PUNTO, BRAVO, BRAVA, MAREA WEEKEND, STILO, DOBLÒ, CARGO, MULTIPLA IDEA, PANDA LANCIA: YPSILON, MUSA, LYBRA, THESIS OPEL: CORSA B/C, COMBO, TIGRA, AGILA, TIGRA B, MERIVA, ASTRA F/G/H, ASTRAVAN, SPEEDSTER VX220, ZAFIRA A/B, VECTRA B/C, SIGNUM, OMEGA B, SINTRA, FRONTERA A/B, ASTRAVAN, KADETT, ASCONA, OMEGA, MONTEREY, ANTARA, CROMA, SPEEDSTER VX220 SUZUKI: IGNIS, SWIFT, WAGON R+ FORD: KA CHEVROLET & DAEWOO: EPICA, CAPTIVA, NUBIRA, LACETTI, EVANDA SAAB: 9-3, 9-5 (98-04)
UTENSILI OEM	1860905000 / 1860905010 / EN-46788 (1), KM-6148 (2), KM-6148 (3), 1870900400 / 1871000200 (4), KM-954 (5), KM-J-43651 (6), 1860905000 / 1860905010 / EN-46788 (7), KM-852 (8), KM-853 (9), 1870900300 / 303-1468 (10), EN-46785 / KM-951 (11), KM-932 (12), 1860703000 (13), KM-955 (14), KM-6130 / KM-6349 / KM-6349 (15), KM-927 (16), EN-48245 (17), KM-933 (18), EN-46785 (19), 1860985000 / 1871000900 / EN-46781 (20), 1860985000 / 1871000900 / EN-46781 (21), EN-48246 (22), KM-929 (23), 1870896900 / EN-46789 (24), KM-952 (25), 21-162B / 303-376 / 303-376B (26), KM-933 (27)
CODICE MOTORE	X14XE, Z14XE, X16SEJ, X16XE, X16XEL, Y16XE, Z16XE, Z16YNG, C18XEL, X18XE, X18XE1, Z18XE, Z18XEL, C20SEL, C20XE, X20XE, Z20LEH, Z20LEL, Z20LER, Z20LET, X22SE, Z22XE, Y22SE, Y22XE, Z22XE, D223L, X10XE, Z10XE, Z10XEP, X12XE, Z12XE, Z14XEP, X20DTL, X20DTH, X22DTH, Y20DTL, Y20DTH, Y22DTH, Y22DTR, 169A1.000, 955A4.000, 350A3.000, 192B4.000, 198A2.000, 350A2.000, 955A3.000, 192A8.000, 198A6.000, 198A3.000, 199B1.000, 199B2.000, 199A2.000, 199A3.000, 199A9.000, 940A3.000, 188A3.000, 939A2.000, 188B2.000, 188A8.000, 188A9.000, 323.02, 371.01, 937A2.000, 182B4.000, 182B9.000, 188A2.000, 188A7.000, 192A9.000, 186A6.000, 186A8.000, 192A1.000, 192A3.000, 192B1.000, 192A5.000, 186A9.000, 939A1.000, 199A5.000, 223A7.000, 223A9.000, 342.02, 362.02, 84TG.000, 84TH.000, 84P.000, 939A3.000, 185A2.000, 185A6.000, Z13DT, Z13DTJ, Z13DTH, Z19DT, Z19DTH, Z19DTJ, Z19DTL, X10XE, Z10XE, Z10XEP, Z12XE, Z14XEP, X16SZR, Z16SE, 4EC1/T, 4EC1, 4EE1/T, 4EE1, X17DT, Y17DT, Y17DTL, 16DA, 17D, 17DR/X, 7DTL, X17DTL, 4JX1/4, JG2T, 4FC1/T, 4FD1, X20DTL, Y20DTL, D223L Z20DMH, Z20DM, RA420, Z20S1, 194A1.000, Z22SE, Z22YH



FIAT/ALFA ROMERO
BMW/MINI
PSA
FORD
JAGUAR/LAND ROVER
JEEP/CHRYSLER
MERCEDES-BENZ
RENAULT/DACIA/NISSAN
OPEL/VAUXHALL
VAG
STRUMENTI AUSILIARI
ALTRI

53771

158,00€

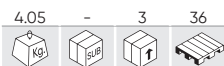

MODULO DI REGOLAZIONE CINGHIA DENTATA PER FIAT/FORD/CITROËN/PEUGEOT

MODELLO	FIAT: ULYSSE, SCUDO, DUCATO LANCIA: ZETA, PHEDRA FORD: FIESTA, FUSION, FOCUS, FOCUS C-MAX CITROËN: C15, C1, C2, C3 PLURIEL, C4, C4 PICASSO, C5, C6, C8, DS3, DS4, DS5, XANTIA, XSARA, XSARA PICASSO, EVASION, BERLINGO, JUMPY, JUMPER, SAXO, ZX, XM, EVASION, AX PEUGEOT: 107, 1007, 206 CC, 207, 208, 306, 307 CC, 308, 406, 407, 508, 607, 806, 807, PARTNER, EXPERT, BOXER, 206, 106, 605, 205, 405
UTENSILI OEM	4200-TH (1), 0117-AR (2), 0188-X (3), 0606-A1.A2 (4), 0188-Q2 (5), 0189-S1 (6), 7017-TR (7), 0132-P / 4507-TL (8), 0189-C (9), 0188-J1 (10), 0188-J2 (11), 0178-E (12), 0189-R (13), 0132-AK / 0188-AK / 0189-K / 0153-AK / 4533-TAD / MOT 1436 (14), 0188-AH (15), 0189-S2 (16), 0153-AB / 9041-TZ (17), 0153-M / 0178-C / 0178-D / 7014-TM / 9767-94 (18), 0189-A (19), 4527-TS1 (20), 0153-AB / 9041-TZ (21), 0189-B / 21-163 (22), 0132-AJ1 / 0153-G / 0188-M / 0189-J / 4533-TAC1 / 5711-TA (24), 0189-L (25), 0188-D / 7017-TM (26), 0132-X / 0188-Q1 / 4507-TJ / 9767-89 (27), 0194-B (28), 0132-AB / 0194-A (29), 0194-C / 21-262 / 303-734 (30), 4527-TS2 (31), 0188-E (32), 0153-A / 6012-T / 9765-54 (33), 0134-AF / 0134-Q / 0188-F / 9004-T (34), 0188-P2 / 0188-P / 174 / 7015-T (35), 0153-U 7019-T (36), 0153-N / 0188-Y / 7014-TJ / 7099-TM / 9797-34 (37)
CODICE MOTORE	F6JA, F6JB, F6JC, G8DA, G8DB, HHDA, HHDB, HHJA, HHJB CITROËN, PEUGEOT: 1.0 / 1.1 / 1.4 / 1.6 / 1.6 16V, 1.4 / 1.6 HDI / 1.8 / 1.8 16V / 2.0 / 2.0 TURBO, 1.9D / 2.0 HDI / 2.2 HDI / 1.8 16V / 2.0 16V TU9 (CDY/CDZ), TU1 (HDY/HDZ/HFX/HFY/HFZ), TU3 (KDX/KDY/KDZ/KFX/KFZ), TU5JP4 (NFU/NFX), TU5 (BDY/BFZ/NFT/NFU/NFW/NFY/NFZ), XU7 (LFW/LFX/LFZ), EW7J4 (RLZ), XU7JP4 (LGY), XU10 (RFL/RFU/RFW/RFX/RGX/RGY), XU10JP4 (RGX/RGY), EW10A (RFJ), EW10J4S (RFK), EW10D (RLZ), EW12J4 (3FZ), ET3JE (KFU), TU3A/JP (KFV/KFW), DV4TD (8HW/8HX/8HZ), DV4TED4 (8HW/8HY), DV6ATED4 (9HX/9HY/9HZ), EW10-CVI (RLZ), EW12 (3FZ), DW8 (WJZ/WJY), DW10 (RHY/RHV/RHZ/RHS/RHM/RHW/RHT/RHR/RHX), DW12 (4HX/4HZ/4HW/4HY), EW7J4 (6FZ), EW10J4 (RFR), EW10J4D (RLZ), DW12TED4 (4HW), DW10ATED (RHT/RHV/RHW/RHX/RHZ) FORD 1.4 / 1.6 DURATORQ TDCI

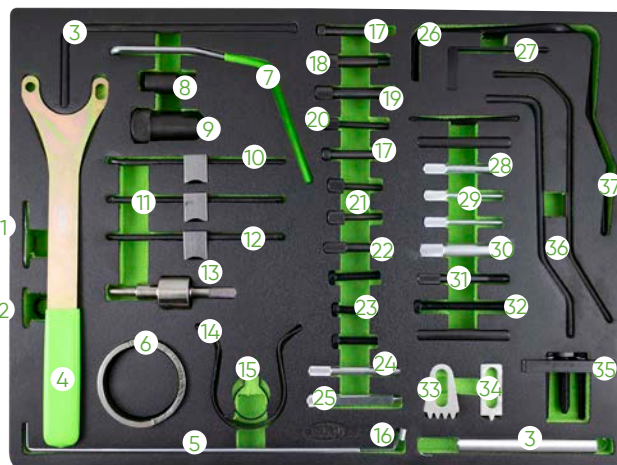

53772

229,00€



ATTREZZO DI REGOLAZIONE CINGHIA DENTATA PER FORD/VAG/MAZDA/VOLVO

MODELLO	AUDI: 80, A1, A2, A3, S3, A4, A5, A6, TT, Q5 SEAT: AROSA, IBIZA, CORDOBA, LEON, TOLEDO, ALHAMBRA, ALTEA, INCA (99-04) SKODA: FABIA, OCTAVIA, SUPERB VW: LUPO, POLO, FOX, GOLF, BORA, JETTA, GOLF PLUS, PASSAT, BEETLE, TOURAN, SHARAN, CADDY, CADDY MAXI, TRANSPORTER, GOLF VI CABRIO, TIGUAN FORD: GALAXY
UTENSILI OEM	T10252 (1), VAS6079 (2), T10121 (3), MP1-1312 / T10098 / T20038 / T20038 (4), T10123 (5), 23-058 / 310-084 / T10008 (6), 2065A / T10008 / U40021 (7), 3418 (8), T10171 (9), 23-059 / 23-059 / 310-085 / T10050 / T10050 (10), 3458 / T30094 (11), T10016 / T10074 / T10074 (12), T10100 (14), T10414 (15), 3366 / T20018 / T20044 (16), 3411 (17), 3369 / T30092 (18), T10341 (19), 3242 / T40069 / T30052 (20), T 40026 (21), 3359 / MP1-301 / T20102 (22), 2064 / U20003 (23), T10120 (24), MP1-1312 / T10098 / T20038 (25), T10170 (26), T00115 / T10264 / T40098 (27), T10092 (28), T00115 / T10264 / T40098 (29), 303-1054 / T10115 (30), T10060 / T10060A (31), 3359 / MP1-301 / T20102 (32), T10340 (33), 2587 (34), 3387 / U30009A (35), 3387 / T10020 (36)
CODICE MOTORE	ARC, ATN, AUS, AVY, AZD, AFH, BCA, AJV, AKQ, AUA, AUB, AXP, AFH, AFN, AFK, AHW, AHU, APE, AQQ, AUS, AXP, AZD, BBY, BBZ, BCB, ANY, AYZ, AMF, ATL, BAY, BHC, BMS, BNM, BNV, BWB, AJM, AMG, ANU, ARL, ASZ, ATD, ATJ, AUU, AVB, AVF, AVQ, AWWX, AXB, AXC, AXR, BEW, BJB, BKC, BKE, BLS, BLT, BMT, BPX, BRB, BRM, BRR, BRU, BSU, BSW, BTB, BUK, BVK, BXE, BXF, AZV, BDJ, BDK, BGW, BHW, BKD, BKP, BLB, BMA, BMM, BMN, BMP, BMR, BNA, BPW, BRC, BRE, BRF, BRT, BUZ, BE, BVF, BVG, BVH, BWK, BTS, BMY, BLF, BWV, AZV, BKD, AWY, AZQ (55 - 64 PF), AXU, BAG, BKG, BLF, BLN, BLP, BVF, BKF, BNU, BVP, BVR, 1Z, CBZA, CBZC, CBZB, CAXA, CAGA, CAGB, CAGC, CAHA, CAYA, CAYB, CAYC, CBAA, CBAB, CBAC, CBBA, CBBB, CBDA, CBDB, CBDC, CBEA, CEGA, CKUB, AZV, BDJ, BHP, BKD, BLB, BMA, BMM, BMN, BMP, BMR, BNA, BPW, BRC, BRE, BRF, BRT, BSS, BUU, BUZ, BVA, BVE, BVF, BVG, BVH, BWW, ACV, AFB, AGX, AHD, AHY, AHY, AJT, AKE, ANJ, APA, AUF, AXG, AXG, AXL, AYC, AYM, AYY, BAU, BBE, BBF, BCZ, BDG, BDH, BFC, BJJ, BJK, BJL, BJM



CARRELLO 7 CASSETTI CON MODULI DI UTENSILI SPECIALI PER KIT DI MESSA IN FASE

53951 1.794,00€

94.70 - 1 4

CON UTENSILI

53952 1.794,00€

94.70 - 1 4

CON UTENSILI

54501 1.794,00€

94.70 - 1 4

CON UTENSILI

54502 1.794,00€

94.70 - 1 4

CON UTENSILI

MISURE INTERNE

CASSETTI PICCOLI (X5)

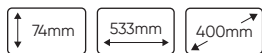

CASSETTI GRANDI (X2)



CAPACITÀ DI CARICO DEL CASSETTO: 30KG.
CAPACITÀ DI CARICO TOTALE: 70KG.

DIMENSIONI TOTALI

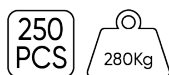

CON ATTREZZATURE EVA:

SET DI 6 MODULI KIT DI MESSA IN FASE

53775 1.109,00€

15.50 - 1 6

GASOLINA/PETROL DIESEL/GASOIL

CONTIENE

REF.					€
53769	5.90	-	3	32	178,00€
53770	6.15	-	3	36	198,00€
53771	4.05	-	3	36	158,00€
53772	6.40	-	3	36	229,00€
53773	6.60	-	3	36	298,00€
53774	6.95	-	3	36	190,00€

53769

RENAULT / NISSAN / OPEL / VOLVO

53770

FORD / SEAT / VOLKSWAGEN / MAZDA / VOLVO

53771

FIAT / FORD / CITROËN / PEUGEOT

53772

FORD / VAG / MAZDA / VOLVO

53773

FIAT / ALFA / LANCIA / OPEL / SUZUKI / FORD

53774

OPEL / CHEVROLET / SAAB / FIAT / LANCIA / SUZUKI / FORD

