

## SERIE565

4.950,00€

## SET DE MOBILIER MODULAR (24 PIESE) - COMPLET

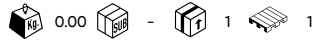

Găsiți toate piesele de schimb și accesoriile disponibile pe site-ul nostru.

## SERIE527

1.254,00€

## SET DE MOBILIER MODULAR (11PCS) - EXTENSIE CU REF.16500 ȘI REF.16493

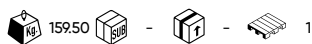

REF.	DESCRIERE	Boxe	Cabine	Bancuri	€	
16493	DULAP CU 3 SERTARE CU SUPORT PENTRU ROLE DE HĂRTIE (REF. 54327)	41.20	-	1	4	463,00€
16494	DULAP DE PERETE (REF. 54327)	10.40	-	1	9	139,00€
16496	PLACĂ MDF 1360X500X38MM (REF. 16627/16628/16500)	18.45	-	1	19	127,00€
16498	PANOU PENTRU SCULE 680X340X25MM (REF. 54327)	2.00	-	3	180	26,00€
16500	DULAP CU 2 UȘI (REF.54327)	33.60	-	1	4	463,00€
16561	BARĂ SUPORT (REF.54327)	7.80	-	10	200	36,50€



## 54735

41,20€

## BALIZĂ DE URGENȚĂ GEOLOCALIZABILĂ V16



Lumină de urgență pentru semnalizarea, localizarea sau urmărirea oricărui vehicul în orice situație de urgență. Foarte practică, mică, ușoară și ușor de utilizat.

Luminozitate	40-80cd
Protecție IP	IP54
Frecvență	0,82Hz
Temperatura de lucru	-20~50°C
Rezistență	180Pa
Temperatura de culoare a LED-ului	1700±200 Kelvin
Certificare	V16
Material	ABS/PC
Metoda de încărcare	Pila/Battery AA (x4)
Magnetizat	Si/ Yes
Include	GPS ~ x4 Batteries
Greutate	0,23Kg
Dimensiuni (LxIxH)	85x85x60mm

- Obligatoriu în Spania începând cu 1 ianuarie 2026.
- Conectat la DGT 3.0. Fără conexiune în afacerea Spaniei.



CONECTADA CON TELEFONICA



CONECTADA CON LA DGT  
CONNECTED WITH DGT

## IDIADA PC25020303



\*DIN CAUZA DATEI DE EXPIRARE, NU SE ACCEPTĂ RETURNAREA ACESTUI ARTICOL.

54718

2.060,00€

CARUCIOR DE UNELTE CU 8 SERTARE ASAMBLAT CU 289 PIESE

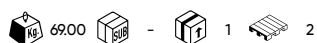

54717 549,00€

CĂRUȚI PENTRU SCULE CU 8 SERTARE GOALE

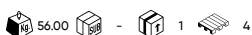

Piese	289
Material	Acero/Plástico
Sertare	8
Dimensiuni sertar mic	575x428x150mm
Dimensiuni sertar mare	575x428x750mm
Capacitatea sertarului mic	35Kg
Capacitatea sertarului mare	35Kg
Capacitate	280Kg
Greutate	52,00Kg
Dimensiuni (LxIxH)	771x466x960mm

54688

3.150,00€

CARUCIOR DE UNELTE XL CU 8 SERTARE ASAMBLAT CU 468 PIESE

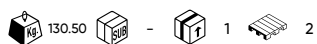

Piese	468
Material	Acero + ABS
Sertare	8
Dimensiunile sertarelor	771x430x73mm
Dimensiuni sertar mare	771x430x152mm
Capacitatea sertarului mic	35,00Kg
Capacitatea sertarului mare	35,00Kg
Capacitate de încărcare a tăvii superioare	55,00Kg
Capacitate	335,00Kg
Greutate	130,50Kg
Dimensiuni (LxIxH)	1002x473x984 mm



16875



16874



16878



16876



16873



16879



16877

54690 988,00€

CĂRUȚI DE SCULE XL CU 8 SERTARE - GOL



54758

17,50€

DOZATOR MAGNETIC DE MĂNUȘI

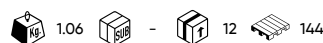

Piese	1
Material	Acero A3/A3 Steel
Finisaj	Pintura en polvo/Powder coating
Greutate	0,884Kg
Dimensiuni (LxIxH)	253x143x95mm



54759

24,00€

SISTEM DE ORGANIZARE A PRIZELOR MAGNETICE, 38BUC

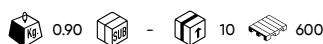

Piese	1
Material	Acero A3/A3 Steel
Finisaj	Pintura en polvo/Powder coating
Măsur	12x1/4", 12x3/8", 12x1/2"
Greutate	0,809Kg
Dimensiuni (LxIxH)	300x152x18,5mm



54784

170,00€

RAFT DE DEPOZITARE PENTRU UNELTE ELECTRICE PE 3 NIVELE

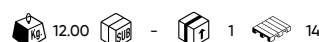

Material	Acero/Steel	Fante pentru unelte	5
Sertare	1	Compartimente	3
Dimensiunile sertarelor	449x231x78mm	Greutate	13 Kg
Capacitatea sertarelor	3Kg	Dimensiuni (LxIxH)	540x250x340mm



**16875** 433,00€

MODUL EVA CU SUPOȚI DE 1/2"

**16876** 369,00€

SET DE CHEI PENTRU ȘURUBURI

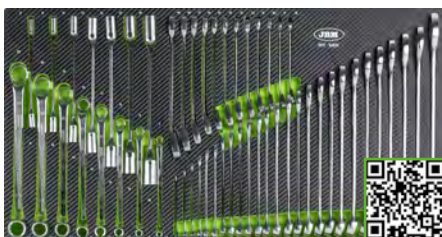
**16877** 290,00€

SET DE CLEȘTI EVA ȘI INSTRUMENTE DE MĂSURĂ ASORTATE

**16878** 174,00€

SET DE ȘURUBELNIȚE ȘI PILE

**16873** 145,00€

TAVĂ SET ȘURUBELNIȚĂ EVA

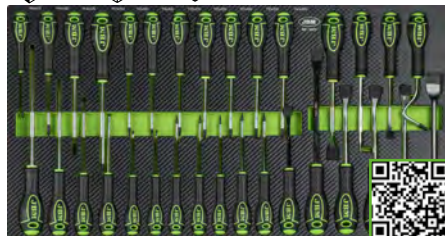
**16879** 315,00€

SET CIOCAN, DALȚĂ ȘI SUPOȚI DE IMPACT

**16874** 454,00€

MODUL EVA CU SUPOȚI DE 1/4" ȘI 3/8"

**54760**

SET DE REPARAȚIE GĂURI DE PANĂ - LICHID ȘI COMPRESOR DE AER

38,00€

Piese	2
Include	17684, 17676
Greutate	1,60Kg
Dimensiuni (LxIxH)	240x165x95mm



54545

18,60€

SET DE CHEI TUBULARE SCURTE 3/8" 9 BUC.

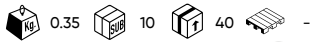

Piese	9
Măsurarea pătratului	3/8"
Profil	Hexagonal
Material	Cr-V

3/8" x9 4, 5, 6, 7, 8, 9, 10, 12, 14mm

54546

20,00€

SET ADAPTOR SCURT BIȚI TORX 10 BUC. 3/8"



Piese	10
Măsurarea pătratului	3/8"
Profil	Torx
Material	Cr-V

3/8" x10 T10, T15, T20, T25, T27, T30, T40, T45, T50, T55

54684

23,50€

SET DE 4 ȘURUBELNIȚE TORX EXTRA LUNGI

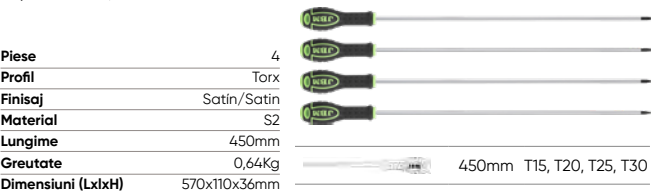
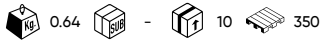

Piese	4
Profil	Torx
Finisaj	Satin/Satin
Material	S2
Lungime	450mm
Greutate	0,64Kg
Dimensiuni (LxIxH)	570x110x36mm

450mm T15, T20, T25, T30

54749

54,00€

KIT DE CURĂȚARE PENTRU ȘTIȚURI ȘI BUTUCI



Piese	7
Adaptoare	50x12, 50x13, 50x14, 60x16, 60x22, 60x28mm
Greutate	0,54Kg

54529

84,00€

CHEIE DINAMOMETRICĂ CU VIZOR 1/4" (3-25NM)

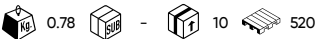

Piese	1
Măsurarea pătratului	1/4"
Material	42CrMo, 40Cr
Numărul de dinți	72
Gama de cuplu	3-25Nm
Precizie (în sensul acelor de ceasornic)	3%
Unități de măsură	Nm
Lungime	280mm
Greutate	0,41Kg



54530

105,00€

CHEIE DINAMOMETRICĂ CU VIZOR 1/2" (20-200NM)

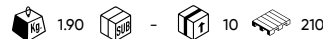

Piese	1
Măsurarea pătratului	1/2"
Material	CrMo, Cr
Numărul de dinți	72
Gama de cuplu	20-200Nm
Precizie (în sensul acelor de ceasornic)	3%
Unități de măsură	Nm
Lungime	515mm
Greutate	1,30Kg



53483

35,03€

SET DE 3 PLIERE ADJUSTABILE

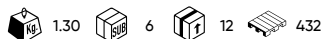

Piese	3
Material	Cr-V
Lungime	180, 240, 300mm
Deschidere	27, 38, 44mm
Greutate	1,30Kg



54539

129,00€

TRUSĂ DE SCULE CU 77 PIESE CU TUBULARE ȘI BIȚI TORX / TORX PLUS

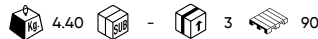

1/4" x5	E4, E5, E6, E7, E8	1/4" x7	T8A, T8B, T8C, T8D, T8E, T8F, T8G, T8H
3/8" x4	E9, E10, E11, E14	3/8" x4	T8A0, T8A1, T50, T55
1/2" x4	E18, E20, E22, E24	1/2" x1	T8A0
1/4" x5	EP1A, EP1B, EP1C, EP1D, EP1E	1/4" x7	IP1, IP10, IP15, IP20, IP25, IP30, IP35
3/8" x4	EP1D, EP1E, EP1F, EP1G, EP1H	3/8" x3	IP40, IP45, IP50
1/2" x4	EP1E, EP1F, EP1G, EP1H, EP1I	1/2" x2	IP55, IP60
1/4" x4	T6, T6, T7, T7, T7, T7, T7, T7, T7	1/4" x7	IP65, IP65, IP65, IP65, IP65, IP65, IP65
3/8" x3	T8, T8, T8, T8, T8, T8, T8, T8	3/8" x3	IP65, IP65, IP65
1/2" x2	T8, T8	1/2" x2	IP65, IP65



54751

617,00€

CRIC PNEUMATIC CU ULEI STIVUITOR DE 22T

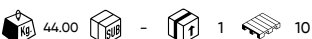

Capacitate	22T
Înălțimea minimă	228mm
Înălțime maximă	548mm
Adaptoare	20-60-90mm
Intrarea aerului	1/4"
Presiunea de lucru	7-10BAR
Consumul real de aer	9,5CFM
Extensibil	110mm
Greutate	43,00Kg
Dimensiuni (LxIxH)	1390x575x322mm



54516

861,00€

CRIC PNEUMATIC CU ULEI TELESCOPIC CU CĂRUȚIOR DE 20/40T

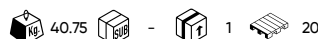

Capacitate	20/40T
Înălțimea minimă	150mm
Înălțime maximă	227-295mm
Conformitate cu directiva europeană	ENISO12100, EN1494
Adaptoare	35-65mm
Intrarea aerului	1/4"
Presiunea de lucru	7-10BAR
Consumul real de aer	9,5CFM
Greutate	41,50Kg
Dimensiuni (LxIxH)	900x290x1195mm





54517

1.184,00€

CRIC PNEUMATIC CU ULEI  
TELESCOPIC CU CĂRUȚIOR DE  
15/20/40T

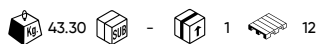

Capacitate	15/25/40T
Înălțimea minimă	125mm
Înălțime maximă	185-240-301mm
Conformitate cu directiva europeană	ENISO12100, EN1494
Adaptoare	35-65mm
Intrarea aerului	1/4"
Presiunea de lucru	7-10BAR
Consumul real de aer	9,5CFM
Greutate	38,70Kg
Dimensiuni (LxlxH)	918x285x1195mm



54757

135,00€

SUPORT TRANSVERSAL PENTRU CRIC HIDRAULIC 2T

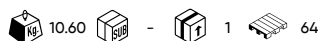

Compatibil cu	50818, 53112
Capacitate	1350-2000Kg
Lungime	700-925mm
Înălțimea de lucru	50-130mm
Greutate	10,00Kg
Dimensiuni (LxlxH)	700x120x140mm



54744

57,21€

KIT DE DISTRIBUȚIE  
PENTRU FIAT/JEEP  
1,0&1,3L

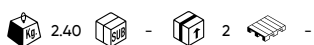

54739

62,00€

SET DE BLOCARE A  
DISTRIBUȚIEI ARBORELUI CU  
CAME PSA PEUGEOT CITROËN

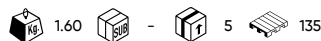

54743

77,57€

KIT DE DISTRIBUȚIE PENTRU  
FIAT 1,0L HYBRID FIRE-FLY

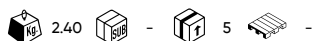

54738

167,00€

SET DE SCULE PENTRU  
DISTRIBUȚIA ARBORELUI CU  
CAME PENTRU MOTOARE  
DIESEL

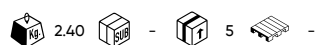

54741

358,00€

INSTRUMENT DE EXTRAGERE A  
CAPULUI SFERIC HIDRAULIC

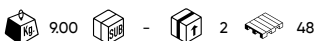

Piese	7
Capacitate	4,5T
Domeniu de lucru	81-113mm
Diametrul exterior	19, 25, 28, 30mm
Compatibil cu	54742
Greutate	7,50Kg
Dimensiuni (LxlxH)	300x100x280mm



54742

485,00€

POMPĂ HIDRO-PNEUMATICĂ

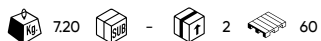

Capacitate	2,3L
Presiunea de lucru	<70MPa
Flux de lucru	0,75-0,95L/min
Greutate	8Kg
Dimensiuni (LxlxH)	315x175x210mm



54737

254,00€

SET DE SCULE EXTRACTOR  
INJECTOR PNEUMATIC

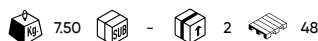

Piese	27
Mărci	BOSCH, DELPHI, DENSO, SIEMENS
Viteze	2
Cuplu de strângere	20-30Nm
Presiunea de lucru	5-8BAR
Greutate	7,50Kg
Dimensiuni (LxlxH)	500x370x110mm



54587

205,00€

SET DE EXTRACTOARE  
PNEUMATICE PENTRU  
INJECTOARE DE COMBUSTIBIL,  
CU ADAPTOARE ȘI GHEARE DE  
EXTRACȚIE

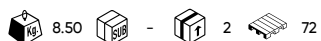

Piese	24
Mărci	Multimarca/Multi-brand
Material	S
Presiunea de lucru	5-8BAR
Greutate	8,50Kg
Dimensiuni (LxlxH)	390x310x100mm



54740

64,00€

EXTRACTOR DE INJECTOARE PENTRU FORD/VOLVO GTDI

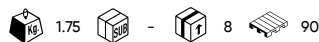

Piese	6
Mărci	FORD, VOLVO
Material	Acero/Steel
Greutate	1,75Kg
Dimensiuni (LxlxH)	650x55x103mm



54736

22,50€

SCULĂ DE DEMONTARE FULIE VIBROCHEN PENTRU FORD



Piese	2
Mărci	FORD
Dimensiuni (LxlxH)	0,49Kg
Greutate	130x370x330mm



54768

80,00€

DISPOZITIV ÎNDEPĂRTARE INJECTOARE PENTRU GRUPUL VAG

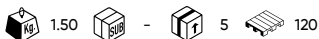

Piese	6
Greutate	1,50Kg
Dimensiuni (LxlxH)	350x310x54mm



54591

58,00€

TRUSĂ TESTATE PENTRU POMPA DE APĂ

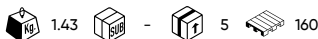

Piese	8
Greutate	1,43Kg
Dimensiuni (LxlxH)	350x25x65mm



54590

108,00€

TRUSĂ DE PURJARE COMBUSTIBIL DIESEL

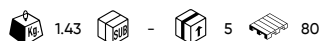

Piese	12
Mărci	Multimarca/Multi-brand
Compatibil cu	Injectores Diesel/Diesel injectors
Greutate	1,43Kg
Dimensiuni (LxlxH)	326x70x414mm



54561

93,00€

APARAT DE SUDURĂ PLASTIC PENTRU REPARAȚII CAROSERII AUTO

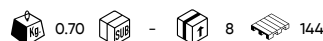

Tensiune nominală	3,7V
Putere	18W
Baterie	2600mAh Li-ion
Include	200 Grapas/Staples
Timp de încărcare	3H
Timp de lucru	200-500 Grapasdas/Staples
Încărcător	Tipo C/ Type C
Temperatura de lucru	500°C
Greutate	0,70Kg
Dimensiuni (LxlxH)	200x27x50mm



54708

17,00€

CHEIE PENTRU FILTRU DE ULEI DE 12 FEȚE 46MM PENTRU VW

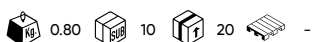

Mărci	VW
Material	S
Măsură	46mm
Greutate	0,80Kg
Dimensiuni (LxlxH)	460x3,5x5,5mm



54764

298,00€

VERIFICATOR DE JOCURI PENTRU SUSPENSIE ȘI DIRECȚIE



Piese	1
Lățimea jantei	13-22"
Material	Acero/Steel
Greutate	12,5Kg
Dimensiuni (LxlxH)	690x400x580mm



52994

84,00€

DISPOZITIV PNEUMATIC FIXARE BURDUF PLANETARĂ (8 BAR)

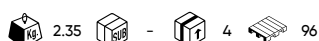

Presiunea de lucru	4,9-8,9BAR
Diametru	120mm
Intrarea aerului	1/4"
Greutate	2,35Kg
Dimensiuni (LxlxH)	460x140x140mm



54595

18,50€

INSTRUMENT DE ÎMPRĂȘTIERE A STRUTURILOR DE SUSPENSIE

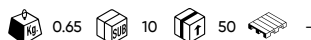

Deschidere	5-30mm
Greutate	0,65Kg
Dimensiuni (LxlxH)	85x32x40mm



54597

125,00€

BAZĂ DE SPRIJIN PENTRU INTRODUCEREA ȘI EXTRAGEREA RULMENȚILOR

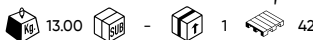

Capacitate	20T
Domeniu de lucru	130-300mm
Greutate	13,00Kg
Dimensiuni (LxlxH)	300x300mm

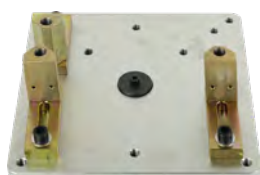

54540

85,50€

PÂRGHIE CU AX UNIVERSALĂ CU LANȚ

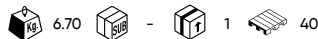

Forță maximă de tracțiune	180Kg
Material	S Q235
Înălțime maximă	65mm - 265mm
Greutate	6,70Kg
Dimensiuni (LxlxH)	960x190x15mm





54721

67,00€

## SET DE CHEI PENTRU PURJAREA FRÂNELOR

1.43 5 10 160

Piese	7
Măsură	7, 8, 9, 10, 11, 12mm
Greutate	1,43Kg
Dimensiuni (LxIxH)	350x25x65mm



54734

19,00€

## SET DE 2 PIESE DE IMPACT PENTRU JENȚI ALUMINIU FORD

0.40 5 20 -

Piese	2
Măsurarea pătratului	1/2"
Profil	Hexagonal
Material	CR-MO
Greutate	0,36Kg
Dimensiuni (LxIxH)	1207x77mm



54685

105,00€

## DETECTOR DE SCURGERI CU ULTRASUNETE

0.63 - 10 120

Tensiune	9V
Frecvența undelor ultrasonice	40kHz
Temperatura de lucru	0 ~ -40°C
Greutate	0,21Kg
Dimensiuni (LxIxH)	192x50x30mm



54589

31,50€

## ADAPTOR UNIVERSAL PENTRU AERISIRE FRÂNĂ

0.55 5 30 -

Presiune maximă	3,5BAR
Lungime	114-180mm
Conexiune rapidă	3/8"
Diametru	28-70mm
Greutate	0,48Kg



54588

499,00€

## DISPOZITIV ELECTRIC PENTRU AERISIRE FRÂNĂ

7.00 - 1 18

Presiunea de lucru	0,6-3,0BAR
Adaptoare	16
Putere	48W
Măsurarea tensiunii în curent alternativ (AC)	90-240V
Măsurarea tensiunii în curent continuu (DC)	12-24V
Debit	2,2LPM
Greutate	7,00Kg
Dimensiuni (LxIxH)	240x200x280mm



54770

95,00€

## PISTOL MINI DE IMPACT 1/2" 1200NM

1.45 5 10 360

Măsurarea pătratului	1/2"
Intrarea aerului	1/4"
Cuplu maxim de strângere	610Nm
Cuplu maxim de rupere (deșurubare)	1200Nm
Viteza nominală	8500RPM
Consumul real de aer	5CFM
Presiunea de lucru	6,3BAR
Intensitatea sunetului	93,14dB
Sistem de cocan	Jumbo
Greutate	1,2Kg
Dimensiuni (LxIxH)	135x64x179mm



54719

16,50€

## PÂLNIE CU SUPORT PENTRU ULEI DE MOTOR

0.44 8 16 96

Diametru	125mm
Material	PVC
Greutate	0,37Kg
Dimensiuni (LxIxH)	300x130x220mm



REF.	DESCRIERE	0.05	16	1024	€
54656	CUTIE DE 100 CONTRAGREUTĂȚI CU CLEME DIN ZINC DE 05GR. SPECIAL PENTRU JANTA UNIVERSALĂ	0.05	16	1024	10,50€
54657	CUTIE DE 100 CONTRAGREUTĂȚI CU CLEME DIN ZINC DE 10GR. SPECIAL PENTRU JANTA UNIVERSALĂ	0.01	16	1024	21,00€
54660	CUTIE DE 100 CONTRAGREUTĂȚI CU CLEME DIN ZINC DE 25GR. SPECIAL PENTRU JANTA UNIVERSALĂ	0.03	8	480	52,50€
54662	CUTIE CU 100 CONTRAGREUTĂȚI DIN ZINC CU CLIP 35GR. SPECIAL PENTRU JANTE UNIVERSALĂ	0.04	4	320	73,50€
54663	CUTIE DE 100 CONTRAGREUTĂȚI CU CLEME DIN ZINC DE 40GR. SPECIAL PENTRU JANTA UNIVERSALĂ	0.04	4	256	84,00€
54665	CUTIE DE 100 CONTRAGREUTĂȚI CU CLEME DIN ZINC DE 50GR. SPECIAL PENTRU JANTA UNIVERSALĂ	0.05	4	256	97,00€

REF.	DESCRIERE	0.01	8	768	€
54667	CUTIE DE 100 CONTRAGREUTĂȚI CU CLEME DIN ZINC DE 10GR. SPECIAL PENTRU JANTE DIN ALIAJ	0.01	8	768	21,00€
54671	CUTIE DE 100 CONTRAGREUTĂȚI CU CLEME DIN ZINC DE 30GR. SPECIAL PENTRU JANTE DIN ALIAJ	0.03	6	300	63,00€
54673	CUTIE DE CONTRAGREUTĂȚI CU CLEME DIN ZINC DE 35GR. SPECIAL PENTRU JANTE DIN ALIAJ	0.04	4	320	73,50€
54669	CUTIE DE 100 CONTRAGREUTĂȚI DIN ZINC CU CLIP 20GR. SPECIAL PENTRU JANTE DIN ALIAJ	0.02	8	550	42,00€
54674	CUTIE CU 100 CONTRAGREUTĂȚI DIN ZINC CU CLIP 40GR. SPECIAL PENTRU JANTE DIN ALIAJ	0.04	4	320	84,00€
54675	CUTIE CU 100 CONTRAGREUTĂȚI DIN ZINC CU CLIP 45GR. SPECIAL PENTRU JANTE DIN ALIAJ	0.04	4	320	94,50€

REF.	DESCRIERE	0.06	4	200	€
54787	CUTIE CU 100 CONTRAGREUTĂȚI ADEZIVE DIN FIER - 60 G (12X5 G) - NEGRU	0.06	4	200	37,00€
54788	CUTIE CU 100 CONTRAGREUTĂȚI ADEZIVE DIN FIER - 60 G (4X10 G + 4X5 G) - NEGRU	0.06	2	200	37,00€

54769

200,00€

## CLICHET FĂRĂ FIR 1/4" - 3.6V CU ÎNCĂRCĂTOR

0.49 5 20 720

Măsurarea pătratului	1/4"
Tensiune	3,6V
Putere	7,2W
Cuplu motor maxim	3Nm
Cuplu manual maxim	62,3Nm
Viteza nominală	320RPM
LED	Si/Yes
Încărcător	USB Tipo C/ USB Type C
Tipul de baterie	Lithium-ION/Litio-ION 3.6V, 2.0Ah
Dimensiuni (LxIxH)	35x215x35mm



54683

58,00€

## ȘURUBELNIȚE FĂRĂ FIR ȘI BIȚI CU VALIZĂ

1.00 - 5 180

Măsurarea pătratului	1/4"
Tensiune	3,6V
Cuplu maxim de strângere	6Nm
Viteza nominală	210RPM
Baterie	LI-ION 1300mAh
LED	Si/Yes
Greutate	1,00Kg
Dimensiuni (LxIxH)	180x45x145mm





**60010C**

299,00€

**FIERĂSTRĂU PENDULAR FĂRĂ FIR CU VALIZĂ**

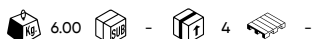

Tensiune	20V
Viteză fără sarcină	2600SPM
Capacitatea maximă de tăiere	8-135mm
Include	60010, 60013, 60016
Compatibil cu	60012, 60013, 60015, 60016, 60017
Greutate	6,00Kg
Dimensiuni (LxIxH)	230x80x210mm
Lungimea ferăstrăului	26mm



**60037C**

348,00€

**PISTOL BATERIE DE ÎMPUȘCAT CUIE/STAPLER FĂRĂ FIR CU VALIZĂ**

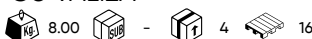

Tensiune	20V
Capacitate	100 Clavos/Nails
Include	60037, 60013, 60016
Compatibil cu	60012, 60013, 60015, 60016, 60017
Greutate	8,00Kg
Dimensiuni (LxIxH)	292x94x259mm



**60032C**

266,00€

**PISTOL DE SILICON FĂRĂ FIR CU VALIZĂ**

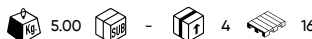

Tensiune	20V
Forța maximă de împingere	2500N
Viteză de avans	0,5-8mm/s (30-480mm/min)
Capacitatea cartușului	300ml
Viteză	Ajustabilă/Adjustable
Include	60032, 60013, 60016
Compatibil cu	60012, 60013, 60015, 60016, 60017
Greutate	4,96Kg
Dimensiuni (LxIxH)	500x130x400mm



**60003C**

250,00€

**POMPĂ ELECTRICĂ COMPRESOR AER FĂRĂ FIR CU VALIZĂ**

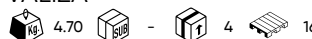

Tensiune	12-20V
Flux de aer	12-380L/min
Presiunea maximă a aerului	160PSI/11BAR/1100KPA
Lungimea furtunului de înaltă presiune	760mm
Lungimea furtunului de mare capacitate	460mm
Include	60003, 60013, 60016
Compatibil cu	60012, 60013, 60015, 60016, 60017
Greutate	4,70Kg
Dimensiuni (LxIxH)	240x210x130mm



**60043C**

252,00€

**SET DE PISTOL DE VOPSIT CU ACUMULATOR ȘI ÎNCĂRCĂTOR**



Tensiune	20V
Putere	280W
Capacitatea rezervorului	900ml
Diametrul duzei	2,5mm
Distanța de pulverizare	200mm
Capacitate de pulverizare	700ml/min
Include	60043, 60013, 60017
Compatibil cu	60012, 60013, 60015, 60016, 60017
Greutate	6,00Kg
Dimensiuni (LxIxH)	350x120x300mm



**60054C**

329,00€

**POLIZOR UNGHIULAR FĂRĂ PERII, FĂRĂ FIR DE 115MM CU VALIZĂ**



Tensiune	20V
Putere	1115W
Viteză nominală	8000RPM
Diametrul discului	115mm
Diametrul arborelui	M14
Vibrații pe min.	0,8m/s2
Include	60054, 60013, 60016
Compatibil cu	60012, 60013, 60015, 60016, 60017
Greutate	5,50Kg
Dimensiuni (LxIxH)	318x137x105mm



**60061C**

149,00€

**UNEALTĂ DE TĂIERE FĂRĂ FIR DE 12V CU GEANTĂ**

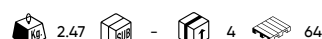

Tensiune	12V
Putere	165W
Viteza nominală	18500RPM
Diametrul discului	76mm
Diametrul arborelui	M5
Vibrații pe min.	18.500/min
Include	60061, 60025, 60026
Greutate	2,47Kg
Dimensiuni (LxIxH)	163x113x89mm



**60056**

142,00€

**MINI FERĂSTRĂU CU LANȚ DE 12V FĂRĂ FIR**



Tensiune	12V
Putere	230W
Viteza nominală	9m/s
Capacitatea maximă de tăiere	100mm
Diametrul discului	1/4"
Lungimea ferăstrăului	160mm
Compatibil cu	60025, 60026
Greutate	1,10Kg
Dimensiuni (LxIxH)	135x100x390mm



**60055**

78,00€

**RADIO FĂRĂ FIR CU BATERII - 12V**

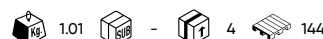

Tensiune	12V
Putere	10W
Compatibil cu	60025, 60026
Conectivitate Bluetooth	15m
Greutate	1,10Kg
Dimensiuni (LxIxH)	197x138x106mm
Inclusiv baterie	No



**60062**

169,00€

**CLICHET DE 1/2 - 12V**



Măsurarea pătratului	1/2"
Tensiune	12V
Putere	360W
Cuplu maxim de strângere	80Nm
Cuplu maxim de rupere (deșurubare)	80Nm
Viteza nominală	175RPM
Compatibil cu	60025, 60026
Greutate	1,17Kg
Dimensiuni (LxIxH)	69x50x310,3mm



**60026**

40,50€

**BATERIE LI-ION 2.0 A\*H**

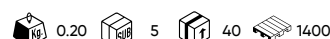

Tipul de baterie	LI-ION
Tensiune	12V
Capacitate	2.0Ah
Greutate	0,20Kg
Compatibil cu	60025



**60025**

34,00€

**ÎNCĂRCĂTOR 12V - PENTRU REF. 60026**

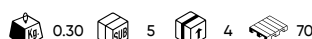

Tensiune	12V
Întare în sarcină	100-240V AC 50/60Hz
Sarcina de ieșire	2A
TimP de încărcare	60 +/-10min (60026)
Greutate	0,30Kg

