



CAROSERIE AUTO

2026

53224

142,00€

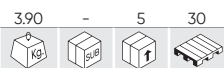

SET REPARATOR DE LOVITURI



PIESE DISPONIBILE



x5	SET DE 5 SUPORTURI ALBASTRE (REF. 53224)
x5	SET DE 4 SUPORTURI GALBENE (REF. 53224)
x10	SET DE 10 SUPORTURI ROȘII (REF. 53224)
x5	SET DE 5 TIJE DE ÎNCLEIERE (REF. 53224)

52876

182,00€



SET DE 7 PIESE DE TINICHIGERIE



PIESE DISPONIBILE



x1	NICOVALĂ CURBATA PENTRU TINICHIGERIE
x1	NICOVALĂ PROFILATA PENTRU TINICHIGERIE
x1	NICOVALĂ BOMBATA PENTRU TINICHIGERIE
x1	NICOVALĂ PANĂ PENTRU TINICHIGERIE
x1	NICOVALĂ VIRGULA PENTRU TINICHIGERIE
x1	NICOVALĂ CALCAI PENTRU TINICHIGERIE
x1	NICOVALĂ VIRGULA CU MÂNER PENTRU TINICHIGERIE

51131

61,00€

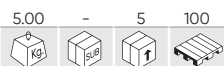

SET 7 PIESE DE TINICHIGERIE PENTRU CAROSERII AUTO



PIESE DISPONIBILE



x1	CIOCAN CU CAP LAT
x1	CIOCAN VÂRF CREION
x1	CIOCAN CU CAP LAT CONIC
x1	TAS VERTICAL
x1	ARIPA TAS
x1	TAS DOUĂ MARGINI
x1	PANĂ TAS ÎN 8

53545

38,50€

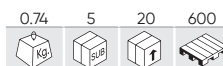

SET DE 5 PIESE DE CHEI CU CAP HEXAGONAL PRELUNGIT 3/8"



x1		8mm
x1		10mm
x1	3/8"	120mmL 12mm
x1		13mm
x1		14mm



55116

125,50€

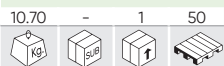

NEW

SET DE REPARAȚII ÎNDOITURI CAROSERIE 11 PIESE

Piese	11
Greutate	10,50Kg
Dimensiuni (LxIxH)	770x100x215mm



**51832** 18,00€

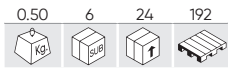

SET DE 4 LEVIERE FINE DIN PLASTIC



x4	19x273mm
	22x273mm
	25x273mm
	36x273mm

**50903** 30,80€

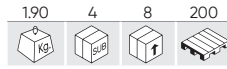

SET DE 5 LEVIERE CU MÂNÈRE DIN PLASTIC



x5	180mm
	280mm
	380mm
	430mm
	600mm

**52026** 34,50€

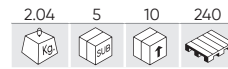

SET DE 2 LEVIERE EXTRALUNGI



x2	900mm
	900mm

**52851** 9,65€

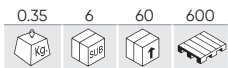

SET DE 2 LEVIERE



x2	7x220mm
	8.5x245mm

**53110** 29,50€

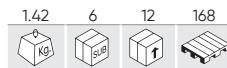

SET DE 6 PÂRGHII



x1	4.5x240mm	x1	4.5x490mm
	8.5x240mm		8.5x490mm
	10.3x24mm		10.3x490mm

**51360** 8,20€

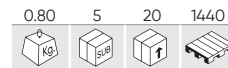

**51361** 12,00€

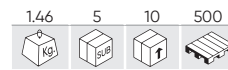

LEVIER DE COFRAJ



x1	51360	x1	18" x 5/8
	51361		24" x 3/4

**50901** 16,00€

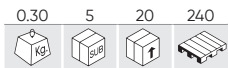

SET DE 5 LEVIERE DIN PLASTIC PENTRU DEMONTARE TAPIȚERIE



x5	60x160, 63x175, 30x200, 20x180, 20x215mm
----	--

**52788** 39,00€

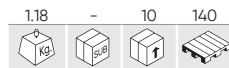

SET DE 27 PIESE DE CHEI DIN NAILON



52977

141,00€

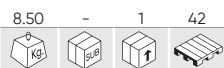

SET DE 4 LEVIERE FOARTE LUNG



Piese	4
Măsur	0° 900x16mm, 30°900x16mm, 75°600x16mm, 90°600x16mm
Greutate	8,50Kg
Dimensiuni (LxIxH)	1005x260x80mm

52540

221,00€



VENTUZĂ PNEUMATICĂ PT. ÎNDREPTAT LOVITURI LA CAROSERII AUTO



Piese	5
Rezistență	7,6BAR
Diametru	75, 100, 125mm
Lungime	620mm
Greutate	4,36Kg
Dimensiuni (LxIxH)	620x250x100mm

54017

12,00€

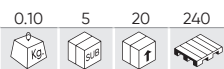

INSTRUMENT DE ETANȘARE A ÎMBINĂRIILOR DE SILICONIC

Conține	Almohadillas de silicona/Silicone pads
Greutate	0,10Kg
Dimensiuni (LxIxH)	270x44x95mm

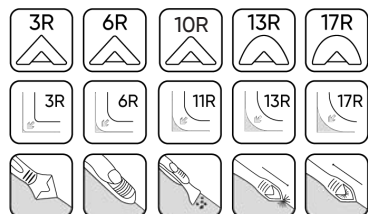

52533

10,00€

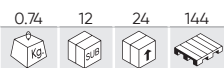

PISTOL PENTRU SILICON PNEUMATIC 300ML - PROFESIONAL



Capacitate	300ml
Greutate	0,74Kg
Dimensiuni (LxIxH)	360x215x60mm

53567

43,00€



PISTOL PENTRU SILICON PNEUMATIC 310ML



Intrarea aerului	1/4"
Presiunea de lucru	2,5-5BAR
Capacitate	310ml
Greutate	1,05Kg
Dimensiuni (LxIxH)	305x185x65mm

60032

123,00€

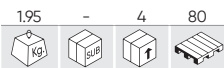

## PISTOL DE SILICON CU BATERII

Tensiune	20V
Forța maximă de împingere	2500N
Viteză de avans	0,5-8 mm/s (30-480mm/min)
Capacitatea cartușului	300ml
Viteză	Ajustable/Adjustable
LED	Si/Yes
Compatibil cu	60012, 60013, 60015, 60016, 60017
Greutate	1,60Kg
Dimensiuni (LxlxH)	420x70x270mm

PIESE  
DISPONIBILE

60032C

266,00€

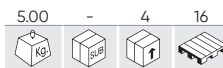

## PISTOL DE SILICON FĂRĂ FIR CU VALIZĂ

Tensiune	20V
Forța maximă de împingere	2500N
Viteză de avans	0,5-8mm/s (30-480mm/min)
Capacitatea cartușului	300ml
Viteză	Ajustable/Adjustable
Include	60032, 60013, 60016
LED	Si/Yes
Compatibil cu	60012, 60013, 60015, 60016, 60017
Greutate	4,96Kg
Dimensiuni (LxlxH)	500x130x400mm

PIESE  
DISPONIBILE

53525

12,00€

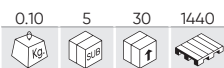

## INSTRUMENT DE BLOCARE A ARCULUI DE GAZ



Diametru	10mm
Greutate	0,10Kg
Dimensiuni (LxlxH)	140x90x30mm

53655

12,00€

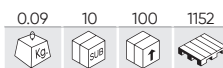

## EXTRACTOR PENTRU MÂNERILE UȘILOR VAG



Mărci	VAG
Greutate	0,09Kg
Dimensiuni (LxlxH)	340x70x40mm

54246

104,00€

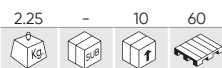

CÂNTAR DE PRECIZIE 5 KG



Capacitate	5Kg
Precizie	0,1g
Măsurarea tensiunii în curent alternativ (AC)	220V
Măsurarea tensiunii în curent continuu (DC)	6V
Temperatura de lucru	0-40°C
Umiditate relativă	10%<RH<85%
Greutate	2,25Kg
Dimensiuni (LxIxH)	280x115x285mm

54247

99,00€



CÂNTAR DE PRECIZIE 2 KG



Capacitate	2Kg
Precizie	0,1g
Măsurarea tensiunii în curent alternativ (AC)	220V
Măsurarea tensiunii în curent continuu (DC)	6V
Temperatura de lucru	0-40°C
Umiditate relativă	10%<RH<85%
Greutate	2,25Kg
Dimensiuni (LxIxH)	352x136x240mm

53230

20,50€

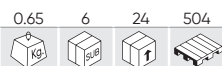

SET DE 10 PIESE DE USTENSILE PENTRU DESCHIDEREA MAȘINILOR

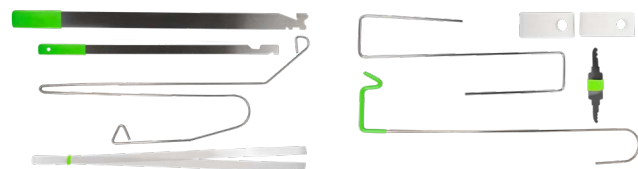

x2	Bandă de deschidere pentru mânăre
x2	Nylon pană cu gaură centrală
x1	Cârlig rigid "s"
x1	Cârlig glisant pentru deblocarea încuietorilor
x1	Pârghie de eliberare largă 610mm
x1	558mm îngust maneta de blocare
x1	Tip cheie pentru încuietori
x1	Cârlig special

52077

29,50€



SET DE 4 PERNUȚE PNEUMATICE PT. DESCHIS MAȘINI



x1	Pernuță de 16x16cm
x1	Pernuță de 32x12cm
x1	Pernuță de 19x6cm
x1	Pernuță de 18x4,5cm
x1	Pompă manuală

53486

30,50€

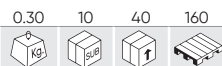

ECRAN PENTRU INSPECȚIA URME DE LOVITURI

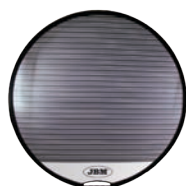

Diametru	800mm
Greutate	0,30Kg
Dimensiuni (LxIxH)	320x300x40mm

15375

28,00€

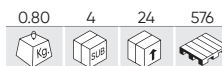

VAS CU LICHID PENTRU REF. 53673



Capacitate	600ml
Greutate	0,80Kg
Dimensiuni (LxIxH)	75x75x190mm



53626

18,00€

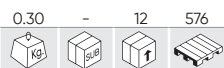

SET PENTRU RESTAURAREA FAPTURILOR

- x2 roți de șlefuit P800
- x2 roți de șlefuit P1200
- x2 roți de șlefuit P2000
- x2 3,0 ml lichid de protecție UV
- x2 adaptor (3/8 "și 1/4")
- x1 85 g pastă de lustruire
- x1 bandă adezivă
- x1 roată de lustruire din lână
- x1 disc de burete alb



ÎN INTERPRET 12 UNITĂȚI

53729

20,50€

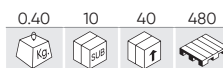

SET DE INSTRUMENTE PENTRU REGLAREA FARURILOR

- x1 H6
- x1 300mm H7
- x1 T25



VENTUZĂ

52262

7,50€

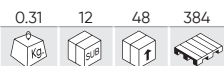

Piese	1
Diametru	115mm
Capacitate	40,00Kg

52263

13,50€



Piese	1
Diametru	115mm
Capacitate	70,00Kg

52264

21,50€

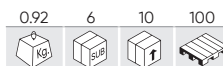

Piese	1
Diametru	115mm
Capacitate	100,00Kg

52265

30,50€

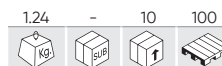

Piese	1
Diametru	115mm
Capacitate	120,00Kg

52295

7,00€

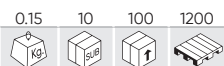

Piese	2
Diametru	60mm
Capacitate	5,00Kg

52589

13,00€



Piese	1
Diametru	70mm
Capacitate	8,00Kg

52765

21,70€

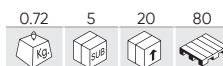

Piese	1
Diametru	120mm
Capacitate	80,00Kg

52998

48,00€



Piese	3
Diametru	120mm
Capacitate	80,00Kg

53232

39,50€

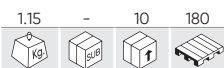

## USTENSILĂ PENTRU ÎNLOCUIREA PARBRIZELOR

- x1 PIESE DE TRIM EXTRACTOR UTILE
- x1 MANETA PENTRU A ELIMINA CAUCIUC
- x1 CÂRLIG EXTRACTOR
- x1 1.8M SĂRMĂ DE TĂIERE
- x2 MĂNERE PENTRU TĂIEREA SĂRMEI
- x1 TRECERE CABLU



REF.	DESCRIERE					€
13813	CABLU PENTRU EXTRAGEREA LICHIDULUI DE PARBRIZE	0.10	10	60	1200	7,00€
13814	UNELTE DE EXTRAGERE PARBRIZE	0.20	10	60	1080	11,00€

55012

680,00€



NEW

## SET DE SCULE PENTRU ÎNLOCUIREA PARBRIZULUI CU VALIZĂ

- x1 ANCORĂ PENTRU LINIA DE TĂIERE
- x1 SCRIPETE PENTRU LINIA DE TĂIERE
- x1 TAMBUR PENTRU LINIA DE TĂIERE
- x1 CABLU DIN FIBRĂ SINTETICĂ L:100M
- x1 UNEALTĂ DE PERFORAT
- x1 BARĂ PENTRU INSTALAREA DĂLȚII
- x1 UNEALTĂ TIP CÂRLIG 90°
- x1 CHEIE CU CLICHET CU CAP DE 1/4"
- x1 PLACĂ DE PROTECȚIE

PIESE  
DISPONIBILE

52321

8,80€

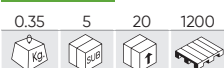

## CENTURĂ CU TENSOR ȘI CLICHET 5M X 25MM



Piese	2
Lungime	5m
Capacitate	800Kg
Greutate	0,35Kg
Dimensiuni (LxIxH)	125x115x30mm

52327

12,00€



## CENTURĂ CU TENSOR ȘI CLICHET 8M X 25MM



Piese	2
Lungime	8m
Capacitate	800Kg
Greutate	0,46Kg
Dimensiuni (LxIxH)	150x140x40mm

50577

12,60€



## CLEȘTE REGLABIL AUTOBLOCANT



Lungime	280mm
Greutate	0,53Kg

52385

268,00€



SET DE 6 CLEȘTI CU PRINDERE SPECIALĂ



W (195mm)

JJ (195mm)

LL (195mm)

J (210mm)

T (215mm)

L (225mm)



52982

55,00€

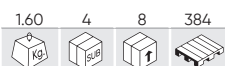

SET DE 3 CLEȘTI REGLABIL AUTOBLOCANT



Unghi 90°  
Lungime 340mm



Unghi 45°  
Lungime 360mm



Unghi 0°  
Lungime 370mm

53675

53,00€

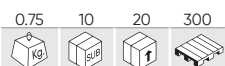

CLEȘTE FIXATOR CU VÂRF DREPT



ÎN INTERPRET 10 UNITĂȚI

53676

47,00€

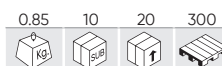

CLEȘTE FIXATOR CU VÂRF ÎNDOIT



ÎN INTERPRET 10 UNITĂȚI

53677

59,00€

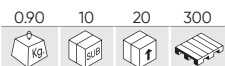

CLEȘTE FIXATOR CU VÂRF ÎNDOIT ȘI SUPORT ROTATIV



ÎN INTERPRET 10 UNITĂȚI

53678

55,00€

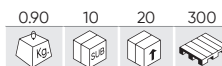





CLEȘTE FIXATOR CU VÂRF ALUNGIT ÎNDOIT



ÎN INTERPRET 10 UNITĂȚI

## CLEȘTE FIXATOR

REF.	DESCRIERE	mm	MATERIAL		T					€
52390	CLEȘTE SPECIAL SUDURĂ	250mm	CrMo	-	-	0.50	5	40	640	37,50€
52474	CLEMĂ DE TRAGERE CAROSERII 5T	190mm	Oțel	0-20mm	5T	3.49	-	5	1500	69,00€
52475	CLEMĂ DE TRAGERE CAROSERII ÎNGUSTĂ 3T	170mm	Oțel	0-25mm	3T	3.60	-	10	1500	62,00€
52476	CLEMĂ DE TRAGERE CAROSERII CAPSULATĂ 5T	220mm	Oțel	0-25mm	5T	3.10	-	10	1500	50,00€
52477	CLEMĂ DE TRAGERE CAROSERII CU AUTOSTRÂNGERE 2T	200mm	Oțel	0-60mm	2T	2.65	-	10	1500	76,50€
52478	CLEMĂ DE TRACȚIUNE CU DUBLĂ TRAGERE 5T	170mm	Oțel	0-20mm	5T	2.90	-	10	1500	49,00€
52479	CLEMĂ TRACȚIUNE MINI 3T 90°	155mm	Oțel	0-20mm	3T	1.18	-	30	1500	24,70€
52480	CLEMĂ DE TRAGERE PĂTRATĂ 90° 3T	210mm	Oțel	0-25mm	3T	2.00	-	10	1500	44,00€
52481	CLEMĂ DE TRAGERE PĂTRATĂ 3T	220mm	Oțel	0-20mm	3T	2.05	-	10	1500	52,00€
52482	CLEMĂ DE TRAGERE CU UNGHI DE 45° 5T	210mm	Oțel	0-10mm	5T	2.13	-	12	1500	44,00€
52483	CLEMĂ DE TRAGERE LATĂ MINI 5T	210mm	Oțel	0-10mm	5T	2.02	-	12	1500	41,00€
52484	CÂRLIG DUBLU PENTRU CAROSERII 3T	280mm	Oțel	0-110mm	3T	1.19	-	11	1500	70,00€
52485	CÂRLIG CU LANȚ TRAS CAROSERII 4T	270mm	Oțel	0-90mm	4T	1.17	-	30	1000	54,00€
52486	CÂRLIG DUBLU CU LANȚ TRAS CAROSERII 3T	280mm	Oțel	0-110mm	3T	1.21	-	11	1500	66,00€
52487	CLEMĂ DE TRACȚIUNE 5T	220mm	Oțel	0-20mm	5T	2.27	-	7	1000	63,00€
52502	CLEȘTE SUDURĂ AUTOBLOCANT	280mm	CrMo	0-110mm	-	0.84	10	30	540	33,50€
52503	CLEȘTE SUDURĂ AUTOBLOCANT TIP C	280mm	CrMo	0-105mm	-	0.85	-	30	540	35,00€
52504	CLEȘTE DE TRAS CU DOUĂ GHEARE	225mm	CrMo	0-50mm	-	1.14	-	30	480	27,60€
52505	CLEȘTE TINICHIGERIE AUTOBLOCANT	170mm	CrMo	0-40mm	-	0.27	36	72	2160	22,50€
52506	CLEȘTE TINICHIGERIE AUTOBLOCANT TIP C	170mm	CrMo	0-50mm	-	0.28	36	72	2160	16,00€
52507	CLEȘTE TINICHIGERIE CU FĂLCI PLATE	250mm	CrMo	0-80mm	-	0.77	5	30	420	32,50€
52511	CLEȘTE SUDURĂ AUTOBLOCANT 18"	440mm	CrMo	0-225mm	-	1.31	-	20	280	44,50€
52512	CLEȘTE SUDURĂ AUTOBLOCANT TIP C	450mm	CrMo	0-155mm	-	1.31	-	20	280	53,00€



52390



52474



52475



52476



52477



52478



52479



52480



52481



52482



52483



52484



52485



52486



52487



52502



52503



52504



52505



52506



52507



52511



52512

53983

215,00€

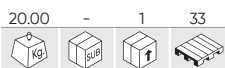

SUPORT DE PIESE PENTRU PARBRIZ ȘI CARCASĂ



Capacitate	150Kg
Dimensiuni pliate	1200x120x210mm
Greutate	19,40Kg
Dimensiuni (LxIxH)	1200x700x635mm

53124

287,00€



SUPORT DE SUSȚINERE PENTRU CAROSERII



Capacitate	100Kg
Dimensiuni pliate	25x860x840mm
Greutate	21,10Kg
Dimensiuni (LxIxH)	1380x860x1300mm

53125

477,00€

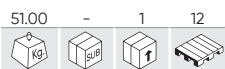

CĂRUCIOR PENTRU A DEPOZITA PIESE

Capacitate	150Kg
Greutate	51,00Kg
Dimensiuni (LxIxH)	900x610x1980mm

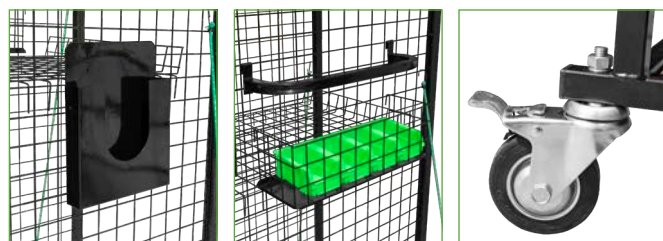

50923

454,00€

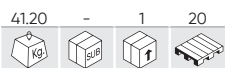

CĂRUCIOR PENTRU ROȚI CAROSERII 340KG



PIESE DISPONIBILE

Capacitate	340Kg
Deschidere	0-1100mm
Greutate	41,20Kg
Dimensiuni (LxIxH)	1340x250x240mm

50839

198,00€



CRIC HIDRAULIC POZIȚIONARE MAȘINĂ 680KG



PIESE DISPONIBILE

Capacitate	680Kg
Deschidere	345-660mm
Greutate	19,20Kg
Dimensiuni (LxIxH)	680x625x230mm

53079

89,00€

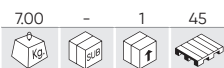

SUPORT DE SUȚINERE PENTRU CAROSERII ÎN "X"



Capacitate	100Kg
Dimensiuni pliate	660x1140x300mm
Greutate	6,77Kg
Dimensiuni (LxlxH)	600x680x870mm

53080

99,00€

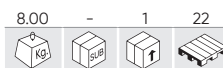

SUPORT DE SUȚINERE PENTRU PARBRIZ MAȘINĂ



Capacitate	70Kg
Dimensiuni pliate	1130x285x990mm
Greutate	7,87Kg
Dimensiuni (LxlxH)	1130x610x990mm

52749

79,00€

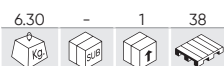

SUPORT PLIABILI PENTRU ELEMENTE DE CAROSERIE



PIESE  
DISPONIBILE

Capacitate	220Kg
Dimensiuni pliate	1030x905x500mm
Greutate	6,25Kg
Dimensiuni (LxlxH)	1030x390x1000mm

53736

99,00€



SUPORT SUȚINERE PENTRU BARA DE PROTECȚIE



Capacitate	25Kg
Dimensiuni pliate	600x310x1230mm
Greutate	8,10Kg
Dimensiuni (LxlxH)	600x750x1060mm

53685

310,00€

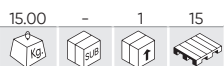

SUPORT PENTRU BARA DE PARASTA

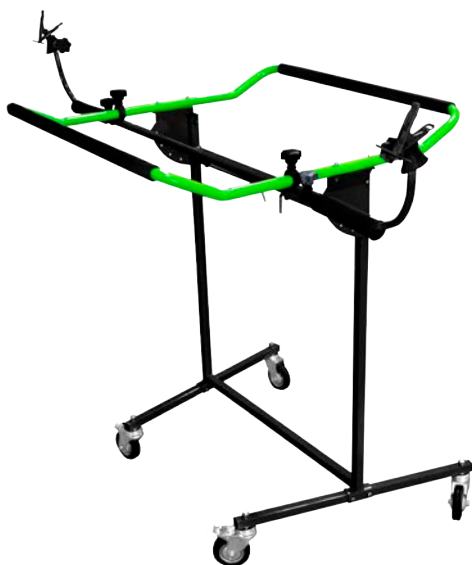

Capacitate	25Kg
Dimensiuni pliate	960x865x95mm
Greutate	14,50Kg
Dimensiuni (LxIxH)	762x1118x1346mm

54579

229,00€

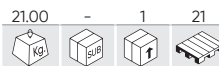

RAFT MOBIL PENTRU DEPOZITARE AMORTIZOARE



Capacitate	60Kg
Capacitate bare	15Kg
Greutate	21,00Kg
Dimensiuni (LxIxH)	1200x1200x2150mm

53134

145,00€

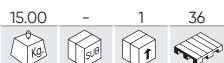

SUPORT PENTRU VOPSITORIT

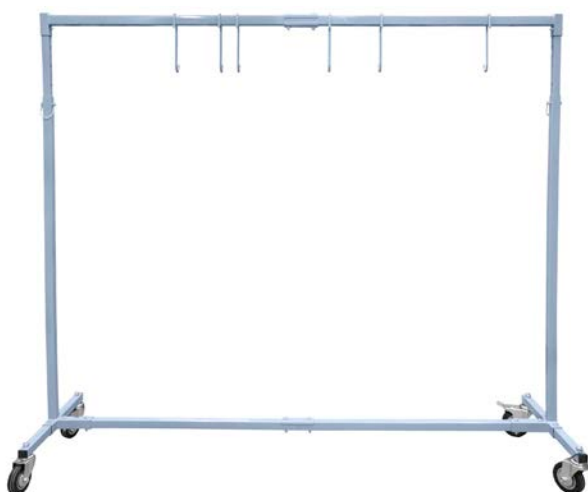

Capacitate	150Kg
Înălțimea minimă de ridicare	1270mm
Înălțime maximă	2030mm
Conține	6 Ganchos/Hooks
Greutate	14,70Kg
Dimensiuni (LxIxH)	1770x500x2030mm

53126

243,00€



SUPORT BASCULANT VOPSITORIT



PIESE DISPONIBILE

Capacitate	50Kg
Conține	6 Brazos de sujeción/Support arms
Greutate	19,70Kg
Dimensiuni (LxIxH)	1220x250x165mm

54959

268,00€

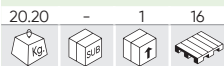

NEW

### SUPORT MOBIL PENTRU VOPSIREA JANTELOR

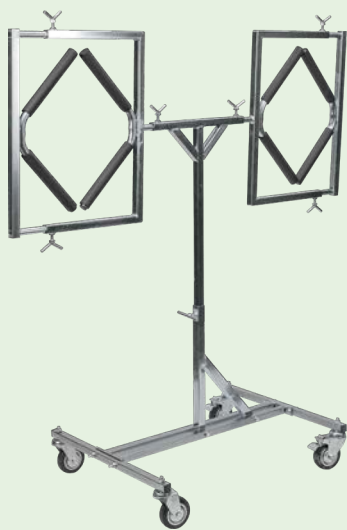

Material	GS
Înălțime	1100 - 1420mm
Rotativ	360°
Tăvi	2
Diametrul roții	15" - 22"
Dimensiuni (LxlxH)	900x670x1100mm

54960

159,50€

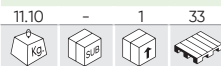

NEW

### SUPORT UNIVERSAL PENTRU PANOURI ȘI BARE DE PROTECȚIE



Material	GS
Rotativ	90°
Sarcina maximă	100Kg
Dimensiuni (LxlxH)	1220x1330x1870mm
Greutate	10,50Kg

54961

20,00€

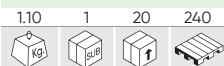

NEW

### SUPORT PENTRU JANTE



Greutate	1,15Kg
Dimensiuni (LxlxH)	130x100x380mm

54962

430,50€



NEW

### CĂRUȚIOR PENTRU PIESE CU SUPORT PENTRU PANOURI



Sarcina maximă	120Kg
Capacitate bare	40Kg
Greutate	40,00Kg
Dimensiuni (LxlxH)	1220x1330x1900mm

52230

398,00€

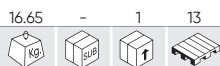

PLATFORMĂ DIN ALUMINIU TELESCOPICĂ



PIESE  
DISPONIBILE

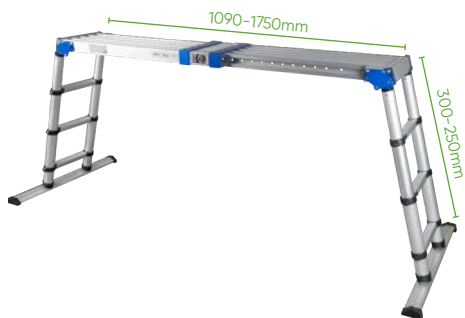

Capacitate	150Kg
Dimensiuni pliate	300x1090x900mm
Lungime minimă	1090mm
Lungime maximă	1750mm
Înălțimea minimă	550mm
Înălțime maximă	930mm
Material	Al
Conformitate cu directiva europeană	EN131
Greutate	16,65Kg
Dimensiuni (LxlxH)	300x1750x900mm

50656

290,00€



SET DE 2 PLATFORME DIN ALUMINIU



PIESE  
DISPONIBILE



Capacitate	100Kg
Dimensiuni platformă mare (LxlxH)	1300x300x550mm
Dimensiuni platformă mare pliată (LxlxH)	1300x300x140mm
Dimensiuni platformă mică (LxlxH)	1000x300x300mm
Dimensiuni platformă mică pliată (LxlxH)	1000x300x140mm
Material	Al
Conține	11897, 15552
Conformitate cu directiva europeană	EN131
Greutate	10,45Kg

50913

229,00€



PLATFORMĂ MARE DIN ALUMINIU

Capacitate	100Kg
Material	Al
Conformitate cu directiva europeană	EN131
Dimensiuni (LxlxH)	1400x300x800mm
Greutate	6,50Kg
Dimensiuni pliate	1400x300x14mm



54789

34,00€

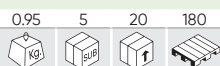

NEW

PROTECȚIE FRONTALĂ PENTRU MAȘINĂ



Material	Poliéster/Polyester
Greutate	0,95Kg
Dimensiuni pliate	330x50x210mm
Dimensiuni asamblate	4050x725mm

51622

27,00€



HUSĂ MAGNETICĂ PROTECȚIE



Tip	Imantado/Magnetized
Material	PVC
Greutate	0,45Kg
Dimensiuni (LxH)	1300x640mm

53922

35,00€

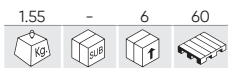

## SUPPORT PENTRU HÂRTIE PENTRU PERETE

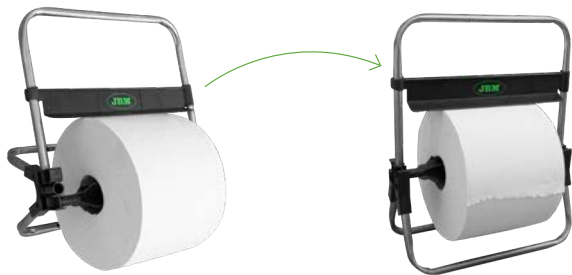

Material	Acero inoxidable/Stainless steel
Înălțimea minimă	480mm
Înălțimea maximă	690mm
Rola de hârtie	380mm
Dimensiuni pliate	450x270x480mm
Greutate	1,55Kg
Dimensiuni (LxIxH)	4550x210x690mm

HÂRTIA NU ESTE INCLUSĂ

53921

39,00€



## SUPPORT PENTRU HÂRTIE



Material	Acero inoxidable/Stainless steel
Înălțime	975mm
Rola de hârtie	380mm
Greutate	1,85Kg
Dimensiuni (LxIxH)	450x345x975mm

HÂRTIA NU ESTE INCLUSĂ

## BARĂ EXTENSIBILĂ MULTIFUNCȚIONALĂ

REF.	MIN.	MAX.	KG	BOX	BOX	BOX	PALET	€
52497	1200mm	530mm	0.29	6	48	480		27,00€
53196	1600mm	710mm	0.37	6	48	384		33,00€



53221

5,00€

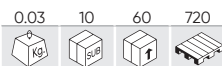

## SET DE 3 PIESE DE LAVETE DIN MICROFIBRĂ



Piese	3
Culoare	Verde/Green
Material	PL
Măsură	360x360mm

55066

319,50€



NEW

## ȘLEFUIȚOR ELECTRIC 150 MM 400W



Tensiune	220V
Putere	400W
Frecvență	50Hz
Viteza nominală	4000-10000RPM
Diametrul discului	150mm
Orbită de șlefuire	5mm
Lungimea cablului	3m
Greutate	1,10Kg
Dimensiuni (LxIxH)	310x150x110mm

54556

74,00€

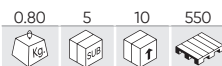

## ȘLEFUIȚOR CU BANDĂ 3/8"

PIESE  
DISPONIBILE

Intrarea aerului	1/4"
Viteza nominală	18000RPM
Consumul real de aer	113L/min
Presiunea de lucru	6,2BAR
Intensitatea sunetului	89dB
Orbită de șlefuire	10x330mm
Orbită de șlefuire	60x80x120mm
Unghi	90°
Greutate	0,75Kg
Dimensiuni (LxIxH)	290x100x50mm

55025

120,00€



NEW

## PISTOL DE USCARE ELECTRIC



Tensiune	220V ~ 50Hz
Putere	1350W
Lungimea cablului	5M
Debitul de aer	93 CFM
Accelerația maximă a aerului	22000ft/min
Greutate	1,80Kg
Dimensiuni (LxIxH)	270x140x280mm

60071

140,00€



NEW

## SUFLANTĂ DE AER CU ACUMULATOR PENTRU USCĂREA VEHICULELOR



Tensiune	20V
Flux de aer	55m/s
RPM ( rotații pe minut)	22500-35000
Debitul de aer	10,4CFM (294L/min)
Diametru	2,5"
Compatibil cu	60013, 60015
Greutate	0,76Kg
Dimensiuni (LxIxH)	168x116x255mm

54771

279,00€

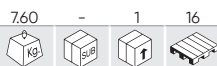

## ASPIRATOR PENTRU TAPIȚERII (USCAT+UMED) 20L

PIESE  
DISPONIBILE

Tensiune	230V
Putere	1200W
Frecvență	50Hz
Capacitate	20L
Litri de aspirație pe secundă	26L/s
Intensitatea sunetului	82dB
Putere de aspirație	17-18KPa
Protecție IP	4
Dimensiuni (LxIxH)	390x340x460mm
Greutate	7,60Kg



53947

149,00€

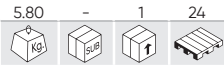

## SPĂLĂTOR DE ÎNALTĂ PRESIUNE 1400W

PIESE  
DISPONIBILE

Tensiune	230V
Putere	1400W
Frecvență	50Hz
Presiunea de lucru	70-105BAR
Debit maxim de funcționare	5,5-6,8L/min
Temperatura de lucru	50°C
Protecție IP	IPX5
Greutate	5,80Kg
Dimensiuni (LxlxH)	280x255x440mm

53948

324,00€



## SPĂLĂTOR DE ÎNALTĂ PRESIUNE 2400W

PIESE  
DISPONIBILE

Tensiune	230V
Putere	2400W
Frecvență	50Hz
Presiunea de lucru	120-180BAR
Debit maxim de funcționare	5,5-8L/min
Temperatura de lucru	50°C
Protecție IP	IPX5
Greutate	12,10Kg
Dimensiuni (LxlxH)	440x345x505mm



54805

478,00€

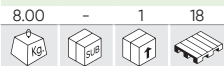

NEW

## SET DE PLAFONIERE HEXAGONALE CU LEDURI

Luminozitate	83640Lm
Putere	615W
Eficiență	110-120Lm/W
Tensiune	185-240V
Tip LED	2835
Numărul de LED-uri	12
Temperatura de culoare a LED-ului	6500k
Material	Al + PC
Lungimea cablului	1,5m Enchufe europeo/ EU Plug
Protecție IP	IP45
Greutate	7,50Kg
Dimensiuni (LxlxH)	2435x42x4845mm

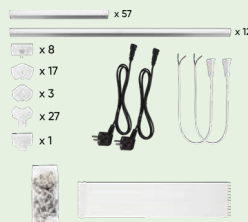
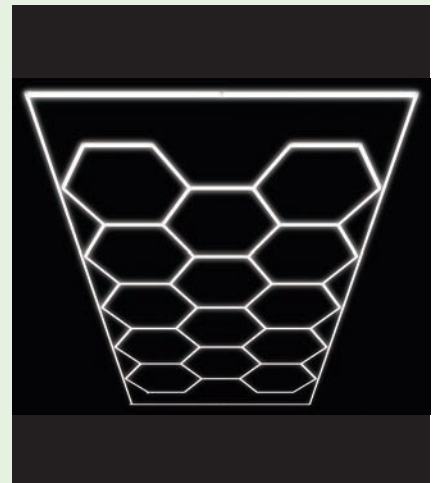
PIESE  
DISPONIBILE



54346

12,80€

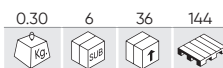

SET DE 3 PERII DE CURĂȚARE PENTRU BURGHIIE



Piese	3
Dimensiunea axei	1/4"
Diametru	50, 88, 100mm

54912

7,90€

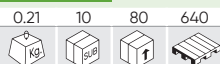

NEW

SET PROFESIONAL DE SPĂLARE AUTO 4 ÎN 1 PENTRU INTERIOR ȘI EXTERIOR



Piese	4
Material	PP
Lungimea pensulei	220, 225, 230, 240mm
Greutate	0,21Kg

54895

16,80€



NEW

SET DE DETAILING AUTO CU 7 ACCESORII ESENȚIALE



Piese	7
Material	PP
Lungimea pensulei	220, 225, 230, 240mm
Diametrul capului	50, 88, 100mm
Dimensiunea axei	1/4"
Greutate	0,35Kg

50844

65,00€

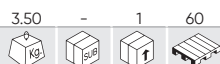

BANCHETĂ CU ROTILE



Material	Acero/Steel, PVC
Capacitate	115Kg
Înălțime	380mm
Greutate	3,50Kg
Dimensiuni (LxIxH)	360x375x380mm

54682

54,00€

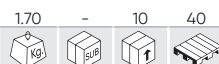

PLATFORMĂ MOBILĂ DE ÎNGENUNCHIERE



Material	Polipropileno/Polypropylene
Sarcina maximă	100Kg
Greutate	1,7Kg
Dimensiuni (LxIxH)	500x255x85mm

53191

14,80€



COVORAȘ INDIVIDUAL



Material	Espuma EVA/EVA foam
Greutate	0,15Kg
Dimensiuni (LxIxH)	480x180x320mm