

53224

142,00€



KIT REPARADOR DE AMOLGADELAS



REPOSIÇÕES DISPONÍVEIS



x5	SACO DE 5 DISCOS AZUIS PARA REF. 53224
x5	SACO DE 4 DISCOS AMARELOS PARA REF. 53224
x10	SACO DE 10 DISCOS VERMELHOS PARA REF. 53224
x5	SACO DE 5 BARRAS DE COLA PARA REF. 53224

52876

182,00€



KIT ENCONTRADORES PARA CHAPEIROS 7 PCS



REPOSIÇÕES DISPONÍVEIS



x1	ENCONTRADOR TIPO BIGORNA
x1	ENCONTRADOR TIPO TRILHO
x1	ENCONTRADOR TIPO DUPLA FACE
x1	ENCONTRADOR TIPO PUNHO COM CABEÇA CONVEXA
x1	ENCONTRADOR TIPO VIRGULA
x1	ENCONTRADOR TIPO CALCANHAR
x1	ENCONTRADOR TIPO VIRGULA CON MANGO

51131

61,00€



KIT ENCONTRADORES E MARTELOS PARA CHAPEIROS



REPOSIÇÕES DISPONÍVEIS



x1	MARTELO BOCA PLANA
x1	MARTELO BOCA PLANA/PEÑA
x1	MARTELO BOCA PLANA CÔNICA
x1	ENCONTRADOR TIPO CALCANHAR
x1	ENCONTRADOR TIPO CARRIL
x1	ENCONTRADOR DUPLA EXTREMIDADE
x1	ENCONTRADOR TIPO VIRGULA

53545

38,50€



CAIXA DE 5 CHAVES DE CABEÇAS HEXAGONAIS ALONGADAS 3/8"



x1	8mm
x1	10mm
x1	3/8" 120mmL 12mm
x1	13mm
x1	14mm



55116

125,50€



NEW

CONJUNTO DE REPARAÇÃO DE AMOLGADELAS DE CARROÇARIA 11 PEÇAS

Peças	11
Peso	10,50Kg
Dimensões (CxLxA)	770x100x215mm



51832 18,00€

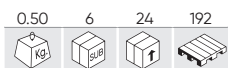

JOGO DE 4 ALAVANCAS DE NYLON TIPO FACAS



x4	19x273mm
	22x273mm
	25x273mm
	36x273mm

50903 30,80€

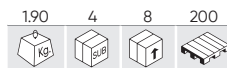

JOGO DE 5 ALAVANCAS DE FERRO



x5	180mm
	280mm
	380mm
	430mm
	600mm

52026 34,50€

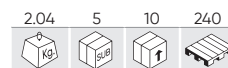

JOGO DE 2 ALAVANCAS DE FERRO



x2	900mm
	900mm

52851 9,65€



JOGO DE 2 ALAVANCAS PARA EXTRAÇÃO DE GRAMPOS



x2	7x220mm
	8.5x245mm

53110 29,50€



KIT DE 6 ALAVANCAS



x1	4.5x240mm	x1	4.5x490mm
	8.5x240mm		8.5x490mm
	10.3x24mm		10.3x490mm

51360 8,20€

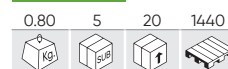

51361 12,00€



PÉ DE CABRA



x1	51360	18" x 5/8
	51361	24" x 3/4

50901 16,00€

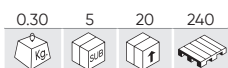

JOGO DE 5 ALAVANCAS DE NYLON



x5	60x160, 63x175, 30x200, 20x180, 20x215mm
----	--

52788 39,00€

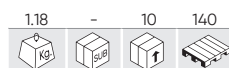

KIT DE 27 ALAVANCAS DE NYLON

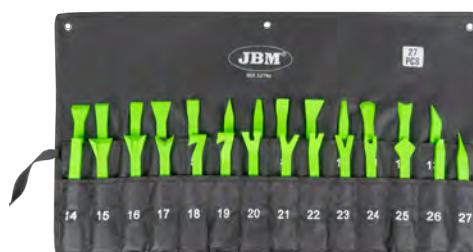

52977

141,00€

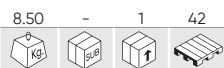

KIT DE 4 ALAVANCAS EXTRALARGAS



Peças	4
Medidas	0° 900x16mm, 30°900x16mm, 75°600x16mm, 90°600x16mm
Peso	8,50Kg
Dimensões (CxLxA)	1005x260x80mm

52540

221,00€



VENTOSA PNEUMÁTICA COM MARTELO DESLIZANTE

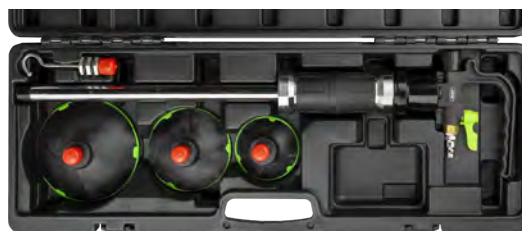

Peças	5
Resistência	7,6BAR
Diâmetro	75, 100, 125mm
Comprimento	620mm
Peso	4,36Kg
Dimensões (CxLxA)	620x250x100mm

54017

12,00€

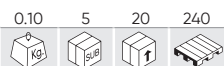

FERRAMENTA DE VEDAÇÃO DE SILICONE

Contém	Almohadillas de silicona/Silicone pads
Peso	0,10Kg
Dimensões (CxLxA)	270x44x95mm

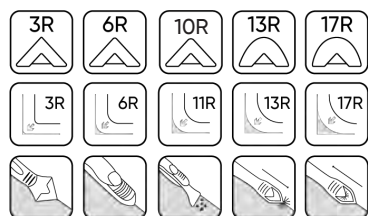

52533

10,00€

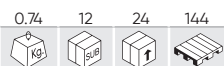

PISTOLA SILICONE 300ML



Capacidade	300ml
Peso	0,74Kg
Dimensões (CxLxA)	360x215x60mm

53567

43,00€



PISTOLA DE SILICONE PNEUMÁTICA 310ML



Entrada de ar	1/4"
Pressão do trabalho	2,5-5BAR
Capacidade	310ml
Peso	1,05Kg
Dimensões (CxLxA)	305x185x65mm

60032

123,00€

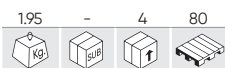

PISTOLA PARA SILICONE A BATERIA

Tensão	20V
Força máxima de empurrão	2500N
Velocidade de avanço	0,5-8 mm/s (30-480mm/min)
Capacidade do cartucho	300ml
Velocidade	Ajustable/Adjustable
LED	Si/Yes
Compatível com	60012, 60013, 60015, 60016, 60017
Peso	1,60Kg
Dimensões (CxLxA)	420x70x270mm

REPOSIÇÕES
DISPONÍVEIS

60032C

266,00€

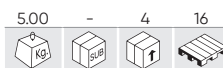

PISTOLA PARA SILICONE A BATERIA COM CAIXA

Tensão	20V
Força máxima de empurrão	2500N
Velocidade de avanço	0,5-8mm/s (30-480mm/min)
Capacidade do cartucho	300ml
Velocidade	Ajustable/Adjustable
Inclui	60032, 60013, 60016
LED	Si/Yes
Compatível com	60012, 60013, 60015, 60016, 60017
Peso	4,96Kg
Dimensões (CxLxA)	500x130x400mm

REPOSIÇÕES
DISPONÍVEIS

53525

12,00€

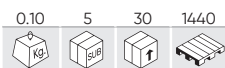

GRAMPO PARA ABRIDORES DO CAPÔ E PORTA-MALAS



Diâmetro	10mm
Peso	0,10Kg
Dimensões (CxLxA)	140x90x30mm

53655

12,00€

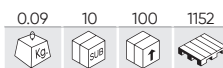

CHAVE PARA MAÇANETAS VAG



Marcas	VAG
Peso	0,09Kg
Dimensões (CxLxA)	340x70x40mm

54246

104,00€

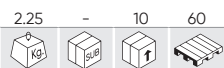

BALANÇA DE PRECISÃO DE 5KG



Capacidade	5Kg
Precisão	0,1g
Medição de voltagem em corrente alternada (AC)	220V
Medição de voltagem em corrente continua (DC)	6V
Temperatura de trabalho	0-40°C
Umidade relativa	10%<RH<85%
Peso	2,25Kg
Dimensões (CxLxA)	280x115x285mm

54247

99,00€



BALANÇA DE PRECISÃO DE 2KG



Capacidade	2Kg
Precisão	0,1g
Medição de voltagem em corrente alternada (AC)	220V
Medição de voltagem em corrente continua (DC)	6V
Temperatura de trabalho	0-40°C
Umidade relativa	10%<RH<85%
Peso	2,25Kg
Dimensões (CxLxA)	352x136x240mm

53230

20,50€

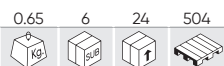

JOGO DE UTENSÍLIOS PARA ABRIR CARROS

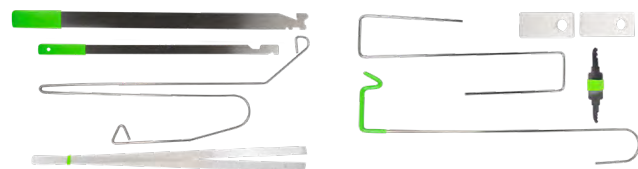

x2	Fita de abertura de puxadores
x2	Cunha de nylon com furo central
x1	Gancho rígido em forma de "s"
x1	Gancho deslizante para desbloqueio de seguros
x1	Alavanca de desbloqueio larga 610mm
x1	Alavanca de bloqueio estreito 558mm
x1	Chave de encaixe para fechaduras
x1	Gancho especial

52077

29,50€

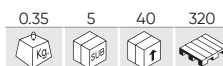

JOGO DE 4 ALMOFADAS INFLÁVEIS



x1	Almofada de 16x16cm
x1	Almofada de 32x12cm
x1	Almofada de 19x6cm
x1	Almofada de 18x4,5cm
x1	Bomba manual

53486

30,50€

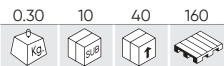

ECRÃ PARA INSPEÇÃO DE AMOLGADELAS

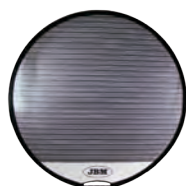

Diâmetro	800mm
Peso	0,30Kg
Dimensões (CxLxA)	320x300x40mm

15375

28,00€

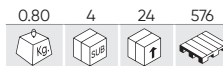

GARRAFA COM LÍQUIDO PARA REF. 53673



Capacidade	600ml
Peso	0,80Kg
Dimensões (CxLxA)	75x75x190mm

53673

80,00€

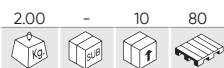

KIT DE RESTAURAÇÃO DE FARÓIS

x6	KIT DE 6 PAPÉIS ABRASIVOS PARA REF. 53673
x1	ADAPTADOR AC-DC PARA REF. 53673
x1	ADAPTADOR 12V PARA REF. 53673
x1	COPO DE EVAPORAÇÃO PARA REF. 53673
x1	TAMPA CURVADA COM ANEL DE VEDAÇÃO DE BORRACHA PARA REF. 53673
x1	TAMPA PLANA COM ANEL DE VEDAÇÃO DE BORRACHA PARA REF. 53673
x1	FUNIL PARA REF. 53673
x1	PLACA DE MOAGEM PARA REF. 53673
x1	PAPEL TEXTURIZADO PARA REF. 53673
x1	GARRAFA COM LÍQUIDO PARA REF. 53673



CONJUNTO DE 10 ELEMENTOS DO PAPEL ABRASIVO

REF.	GRÃO				€	REF.	GRÃO				€
14710	180	0.25	10	100	3,90€	14713	600	0.15	10	100	4,25€
14711	280	0.20	10	100	4,00€	14714	800	0.15	10	100	4,50€
14712	360	0.20	10	100	4,00€	14715	1200	0.10	10	100	4,75€



VIDEO TUTORIAL



REPOSIÇÕES DISPONÍVEIS

52740

690,00€

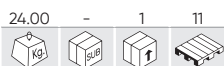

ALINHADOR DE FARÓIS COM LUXÓMETRO 152CM



Altura mínima de elevação	230mm
Altura máxima de elevação	1350mm
Medição	LUX Digital
Compatível com	Hálogeno/Xenón
Peso	24,00Kg
Dimensões (CxLxA)	520x280x1520mm

52836

1.100,00€



ALINHADOR DE FARÓIS COM DUPLO LASER E LUXÓMETRO



VIDEO TUTORIAL

Altura mínima de elevação	230mm
Altura máxima de elevação	1350mm
Medição	Láser/Laser, LUX Digital
Compatível com	Cualquier tipo de faro/Any type of car lighthouse
Peso	24,85Kg
Dimensões (CxLxA)	520x270x1560mm

53626

18,00€

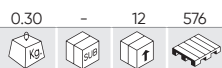

KIT DE RESTAURAÇÃO DE FARÓIS

- x2 EP800 Discos de lixar
- x2 P1200 Discos de lixar
- x2 P2000 Discos de lixar
- x2 3.0ml Líquido protetor UV
- x2 Adaptador (3/8" & 1/4")
- x1 85gm Pasta de polimento
- x1 Fita adesiva
- x1 Disco de polimento de lã
- x1 Disco de Esponja Branco



EM EXPOSITOR DE 12 UDS

53729

20,50€

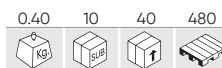

KIT DE FERRAMENTAS PARA AJUSTAR FARÓIS

- x1 H6
- x1 300mm H7
- x1 T25



VENTOSA

52262

7,50€

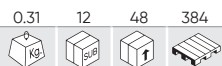

Peças	1
Diâmetro	115mm
Capacidade	40,00Kg

52263

13,50€



Peças	1
Diâmetro	115mm
Capacidade	70,00Kg

52264

21,50€

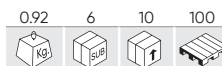

Peças	1
Diâmetro	115mm
Capacidade	100,00Kg

52265

30,50€

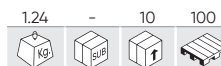

Peças	1
Diâmetro	115mm
Capacidade	120,00Kg

52295

7,00€

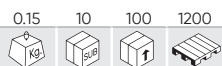

Peças	2
Diâmetro	60mm
Capacidade	5,00Kg

52589

13,00€

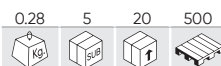

Peças	1
Diâmetro	70mm
Capacidade	8,00Kg

52765

21,70€

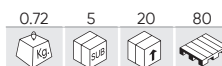

Peças	1
Diâmetro	120mm
Capacidade	80,00Kg

52998

48,00€



Peças	3
Diâmetro	120mm
Capacidade	80,00Kg

53232

39,50€

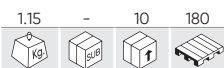

FERRAMENTAS PARA SUBSTITUIÇÃO DE PARA-BRISAS

- x1 ÚTIL EXTRATOR DE MOLDURAS
- x1 ALAVANCA PARA EXTRAIR A BORRACHA
- x1 GANCHO EXTRATOR
- x1 1.8M DE FIO DE CORTE
- x2 CABOS PARA O FIO DE CORTE
- x1 PASSA-CABOS



REF.	DESCRIÇÃO					€
13813	CABO PARA EXTRAÇÃO DE PÁRA-BRISAS	0.10	10	60	1200	7,00€
13814	FERRAMENTA PARA EXTRAÇÃO DE PÁRA-BRISAS	0.20	10	60	1080	11,00€

55012

680,00€



NEW

CONJUNTO DE FERRAMENTAS PARA SUBSTITUIÇÃO DE PARA-BRISAS COM MALETA

- x1 ÂNCORA DA LINHA DE CORTE
- x1 POLIA DA LINHA DE CORTE
- x1 ENROLADOR DA LINHA DE CORTE
- x1 CABO DE FIBRA SINTÉTICA L:100M
- x1 FERRAMENTA PERFURADORA
- x1 BARRA PARA INSTALAÇÃO DO CINZEL
- x1 FERRAMENTA DE GANCHO TIPO PICO 90°
- x1 CHAVE DE CATRACA COM SOQUETE 1/4"
- x1 TÁBUA PROTETORA



REPOSIÇÕES DISPONÍVEIS

52321

8,80€

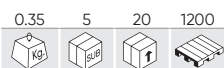

CINTA DE APERTO POLIÉSTER COM TENSOR 5M X 25MM



Peças	2
Comprimento	5m
Capacidade	800Kg
Peso	0,35Kg
Dimensões (CxLxA)	125x115x30mm

52327

12,00€



CINTA DE APERTO POLIÉSTER COM TENSOR 8M X 25MM



Peças	2
Comprimento	8m
Capacidade	800Kg
Peso	0,46Kg
Dimensões (CxLxA)	150x140x40mm

50577

12,60€

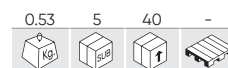

ALICATE DE PRESSÃO



Comprimento	280mm
Peso	0,53Kg

52385

268,00€



JOGO DE 6 ALICATES DE MORDAÇA



52982

55,00€

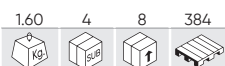

JOGO 3 MORDAÇAS DE PRESSÃO EXTRA-LARGAS



Ângulo	90°
Comprimento	340mm



Ângulo	45°
Comprimento	360mm



Ângulo	0°
Comprimento	370mm

53675

53,00€

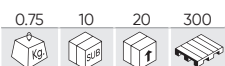

ALICATE DE PONTAS DIRETAS



EM EXPOSITOR DE 10 UDS



53676

47,00€

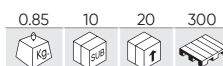

ALICATE DE PONTAS CURVAS



EM EXPOSITOR DE 10 UDS



53677

59,00€

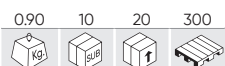

ALICATE DE PONTAS CURVAS E ALMOFADA GIRATÓRIA



EM EXPOSITOR DE 10 UDS



53678

55,00€

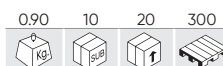





ALICATE DE PONTAS CURVAS LONGAS



EM EXPOSITOR DE 10 UDS



MORDAÇAS

REF.	DESCRIÇÃO	mm	MATERIAL		T					€
52390	MORDAÇA ESPECIAL SOLDADURA	250mm	CrMo	-	-	0.50	5	40	640	37,50€
52474	MORDAÇA DE ARGOLA 5T	190mm	Aço	0-20mm	5T	3.49	-	5	1500	69,00€
52475	MORDAÇA PLANO 3T	170mm	Aço	0-25mm	3T	3.60	-	10	1500	62,00€
52476	MORDAÇA QUADRADO 5T	220mm	Aço	0-25mm	5T	3.10	-	10	1500	50,00€
52477	MORDAÇA DE MOLA 2T	200mm	Aço	0-60mm	2T	2.65	-	10	1500	76,50€
52478	MORDAÇA 90° 5T	170mm	Aço	0-20mm	5T	2.90	-	10	1500	49,00€
52479	MINI MORDAÇA PLANO 90° 3T	155mm	Aço	0-20mm	3T	1.18	-	30	1500	24,70€
52480	MINI MORDAÇA QUADRADA 90° 3T	210mm	Aço	0-25mm	3T	2.00	-	10	1500	44,00€
52481	MORDAÇA QUADRADA 3T	220mm	Aço	0-20mm	3T	2.05	-	10	1500	52,00€
52482	MORDAÇA PLANO ÂNGULO 45° 5T	210mm	Aço	0-10mm	5T	2.13	-	12	1500	44,00€
52483	MORDAÇA PLANO MINI 5T	210mm	Aço	0-10mm	5T	2.02	-	12	1500	41,00€
52484	UNIÃO DE CORRENTES 3T	280mm	Aço	0-110mm	3T	1.19	-	11	1500	70,00€
52485	UNIÃO DE GANCHOS DE 4T	270mm	Aço	0-90mm	4T	1.17	-	30	1000	54,00€
52486	UNIÃO DE CORRENTES GANCHOS 3T	280mm	Aço	0-110mm	3T	1.21	-	11	1500	66,00€
52487	MORDAÇA DE MOLA 5T	220mm	Aço	0-20mm	5T	2.27	-	7	1000	63,00€
52502	MORDAÇA DE PRESSÃO PARA SOLDADURA	280mm	CrMo	0-110mm	-	0.84	10	30	540	33,50€
52503	MORDAÇA DE PRESSÃO PESCOÇO DE CISNE MAXILAR OSCILANTES	280mm	CrMo	0-105mm	-	0.85	-	30	540	35,00€
52504	MORDAÇA DE DUPLA GARRA PARA BATE-CHAPA	225mm	CrMo	0-50mm	-	1.14	-	30	480	27,60€
52505	MORDAÇA PESCOÇO DE CISNE	170mm	CrMo	0-40mm	-	0.27	36	72	2160	22,50€
52506	MORDAÇA PESCOÇO DE CISNE, MAXILAS OSCILANTES	170mm	CrMo	0-50mm	-	0.28	36	72	2160	16,00€
52507	MORDAÇA DE PRESSÃO PARÁGRAFO LATOEIROS	250mm	CrMo	0-80mm	-	0.77	5	30	420	32,50€
52511	MORDAÇA PARA SOLDADURA 18"	440mm	CrMo	0-225mm	-	1.31	-	20	280	44,50€
52512	MORDAÇA DE PRESSÃO SOLDADURA, MAXILAS OSCILANTES	450mm	CrMo	0-155mm	-	1.31	-	20	280	53,00€



52390



52474



52475



52476



52477



52478



52479



52480



52481



52482



52483



52484



52485



52486



52487



52502



52503



52504



52505



52506



52507



52511



52512

53983

215,00€

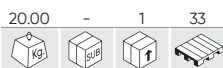

SUPORE DE PEÇAS - PÁRA-BRISAS E COBERTURA



Capacidade	150Kg
Dimensões dobradas	1200x120x210mm
Peso	19,40Kg
Dimensões (CxLxA)	1200x700x635mm

53124

287,00€



CAVALETE UNIVERSAL TELESCÓPICO



Capacidade	100Kg
Dimensões dobradas	25x860x840mm
Peso	21,10Kg
Dimensões (CxLxA)	1380x860x1300mm

53125

477,00€

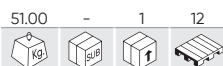

CARRO PARA ARMAZENAGEM DE PEÇAS

Capacidade	150Kg
Peso	51,00Kg
Dimensões (CxLxA)	900x610x1980mm



50923

454,00€

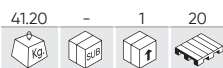

CARRO TRANSPORTADOR ESP. CHAPEIROS 340KG



REPOSIÇÕES DISPONÍVEIS

Capacidade	340Kg
Abertura	0-1100mm
Peso	41,20Kg
Dimensões (CxLxA)	1340x250x240mm

50839

198,00€



PORTA CARROS HIDRÁULICO 680KG



Capacidade	680Kg
Abertura	345-660mm
Peso	19,20Kg
Dimensões (CxLxA)	680x625x230mm

53079

89,00€

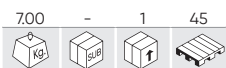

CAVALETE EN "X"



Capacidade	100Kg
Dimensões dobradas	660x1140x300mm
Peso	6,77Kg
Dimensões (CxLxA)	600x680x870mm

53080

99,00€

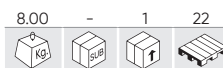

CAVALETE PARA PARA-BRISA



Capacidade	70Kg
Dimensões dobradas	1130x285x990mm
Peso	7,87Kg
Dimensões (CxLxA)	1130x610x990mm

52749

79,00€

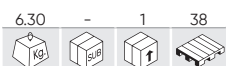

CAVALETE PROFESSIONAL

REPOSIÇÕES
DISPONÍVEIS

Capacidade	220Kg
Dimensões dobradas	1030x905x500mm
Peso	6,25Kg
Dimensões (CxLxA)	1030x390x1000mm

53736

99,00€



CAVALETE SUPORTE PARA-CHOQUES



Capacidade	25Kg
Dimensões dobradas	600x310x1230mm
Peso	8,10Kg
Dimensões (CxLxA)	600x750x1060mm

53685

310,00€

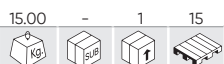

SUPORE PARA PARACHOQUE

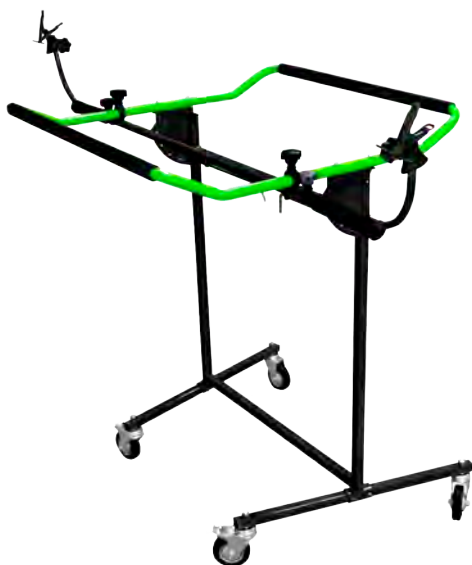

Capacidade	25Kg
Dimensões dobradas	960x865x95mm
Peso	14,50Kg
Dimensões (CxLxA)	762x1118x1346mm

54579

229,00€



SUPORE MÓVEL PARA ARMAZENAMENTO DE PARA-CHOQUES



Capacidade	60Kg
Capacidade da barra	15Kg
Peso	21,00Kg
Dimensões (CxLxA)	1200x1200x2150mm

53134

145,00€

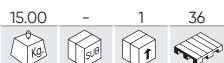

SUPORE PARA PINTURA AJUSTÁVEL

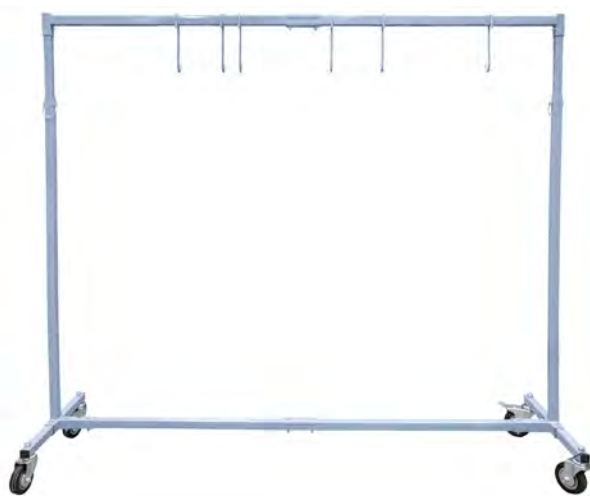

Capacidade	150Kg
Altura mínima de elevação	1270mm
Altura máxima	2030mm
Contém	6 Ganchos/Hooks
Peso	14,70Kg
Dimensões (CxLxA)	1770x500x2030mm

53126

243,00€



SUPORE BASCULANTE PARA PINTURA



Capacidade	50Kg
Contém	6 Braços de sujeição/Support arms
Peso	19,70Kg
Dimensões (CxLxA)	1220x250x165mm

54959 **268,00€**

20.20 - 1 16 **NEW**

SUPORE MÓVEL PARA PINTURA DE RODAS

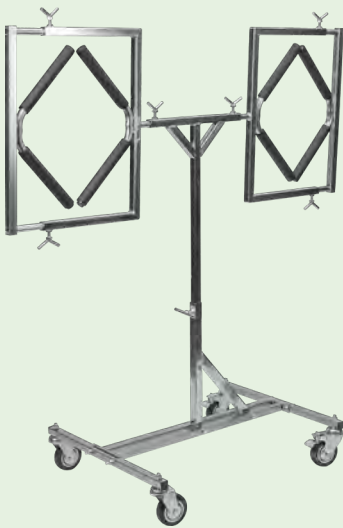

Material	GS
Altura	1100 - 1420mm
Rotativo	360°
Bandejas	2
Diâmetro da roda	15" - 22"
Dimensões (CxLxA)	900x670x1100mm

54960 **159,50€**

11.10 - 1 33 **NEW**

SUPORE UNIVERSAL PARA PAINÉIS E PARA-CHOQUES



Material	GS
Rotativo	90°
Carga máxima	100Kg
Dimensões (CxLxA)	1220x1330x1870mm
Peso	10,50Kg

54961 **20,00€**

1.10 1 20 240 **NEW**

SUPORE PARA RODAS

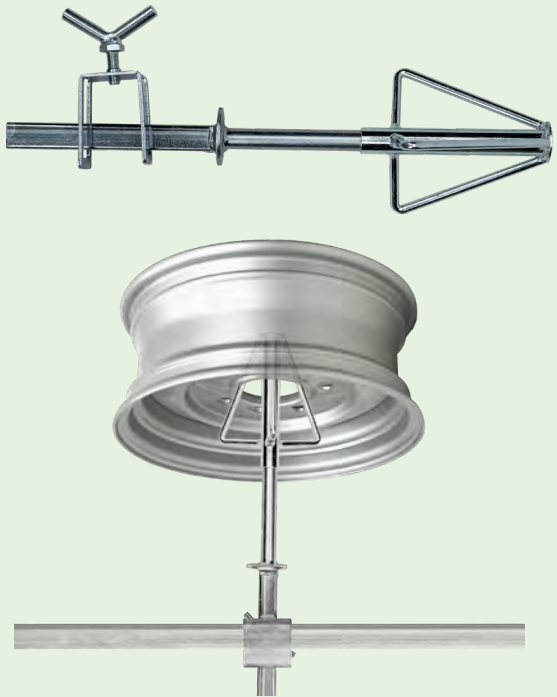

Peso	1,15Kg
Dimensões (CxLxA)	130x100x380mm

54962 **430,50€**

40.25 - 1 14 **NEW**

CARRINHO PARA PEÇAS COM SUPORTE PARA PAINÉIS



Carga máxima	120Kg
Capacidade da barra	40Kg
Peso	40,00Kg
Dimensões (CxLxA)	1220x1330x1900mm

52230

398,00€

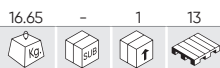

PLATAFORMA DE ALUMÍNIO TELESCÓPICA



REPOSIÇÕES DISPONÍVEIS

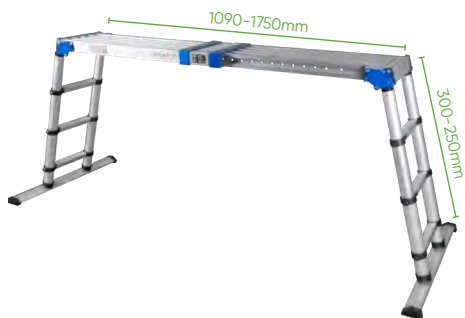

Capacidade	150Kg
Dimensões dobradas	300x1090x900mm
Comprimento mínimo	1090mm
Comprimento máximo	1750mm
Altura mínima	550mm
Altura máxima	930mm
Material	Al
Conformidade com a diretiva europeia	EN131
Peso	16,65Kg
Dimensões (CxLxA)	300x1750x900mm

50656

290,00€



JOGO 2 PLATAFORMAS DE ALUMÍNIO



REPOSIÇÕES DISPONÍVEIS



Capacidade	100Kg
Dimensões da plataforma grande (CxLxA)	1300x300x550mm
Dimensões da plataforma grande dobrada (CxLxA)	1300x300x140mm
Dimensões da plataforma pequena (CxLxA)	1000x300x300mm
Dimensões da plataforma pequena dobrada (CxLxA)	1000x300x140mm
Material	Al
Contém	11897, 15552
Conformidade com a diretiva europeia	EN131
Peso	10,45Kg

50913

229,00€



PLATAFORMA DE ALUMÍNIO GRANDE

Capacidade	100Kg
Material	Al
Conformidade com a diretiva europeia	EN131
Dimensões (CxLxA)	1400x300x800mm
Peso	6,50Kg
Dimensões dobradas	1400x300x14mm



54789

34,00€

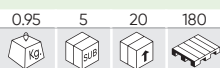

NEW

PROTECTOR FRONTAL PARA CARRO



Material	Poliéster/Polyester
Peso	0,95Kg
Dimensões dobradas	330x50x210mm
Dimensões montadas	4050x725mm

51622

27,00€



PROTECTOR MAGNÉTICO DE COBERTURA DE ALETAS E FACHADAS



Tipo	Imantado/Magnetized
Material	PVC
Peso	0,45Kg
Dimensões (CxA)	1300x640mm

53922

35,00€



SUPORE DE PAPEL PARA PAREDE



Material	Acero inoxidable/Stainless steel
Altura mínima	480mm
Altura máxima	690mm
Rolo de papel	380mm
Dimensões dobradas	450x270x480mm
Peso	1,55Kg
Dimensões (CxLxA)	4550x210x690mm

PAPEL NÃO INCLUSO

53921

39,00€



PORTA ROLO DE PAPEL



Material	Acero inoxidable/Stainless steel
Altura	975mm
Rolo de papel	380mm
Peso	1,85Kg
Dimensões (CxLxA)	450x345x975mm

PAPEL NÃO INCLUSO

CABO EXTENSÍVEL MULTIFUNÇÃO

REF.	MIN.	MAX.	KG	BOX	BOX	BOX	BOX	€
52497	1200mm	530mm	0.29	6	48	480	27,00€	
53196	1600mm	710mm	0.37	6	48	384	33,00€	



53221

5,00€

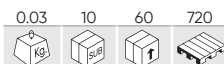

JOGO DE 3 CAMURÇAS DE MICROFIBRAS



Peças	3
Cor	Verde/Green
Material	PL
Medida	360x360mm

55066

319,50€

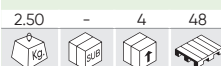

NEW

LIXADEIRA ELÉTRICA 150 MM 400W



Tensão	220V
Potência	400W
Frequência	50Hz
Velocidade nominal	4000-10000RPM
Diâmetro do disco	150mm
Órbita de lixamento	5mm
Comprimento do cabo	3m
Peso	1,10Kg
Dimensões (CxLxA)	310x150x110mm

54556

74,00€

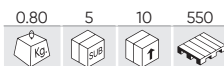

LIXADEIRA DE CINTA 3/8"



REPOSIÇÕES DISPONÍVEIS



Entrada de ar	1/4"
Velocidade nominal	18000RPM
Consumo real de ar	113L/min
Pressão do trabalho	6,2BAR
Intensidade do som	89dB
Órbita de lixamento	10x330mm
Órbita de lixamento	60x80x120mm
Ângulo	90°
Peso	0,75Kg
Dimensões (CxLxA)	290x100x50mm

55025

120,00€



NEW

PISTOLA DE SECAGEM ELÉTRICA



Tensão	220V ~ 50Hz
Potência	1350W
Comprimento do cabo	5M
Taxa de fluxo de ar	93 CFM
Aceleração máxima de ar	22000ft/min
Peso	1,80Kg
Dimensões (CxLxA)	270x140x280mm

60071

140,00€



NEW

SOPRADOR DE AR A BATERIA PARA SECAGEM DE VEÍCULOS



Tensão	20V
Fluxo de ar	55m/s
RPM (rotações por minuto)	22500-35000
Taxa de fluxo de ar	10,4CFM (294L/min)
Diâmetro	2,5"
Compatível com	60013, 60015
Peso	0,76Kg
Dimensões (CxLxA)	168x116x255mm

54771

279,00€



ASPIRADOR PARA ESTOFOS 20L (SECO+HÚMIDO)



REPOSIÇÕES DISPONÍVEIS

Tensão	230V
Potência	1200W
Frequência	50Hz
Capacidade	20L
Litros de sucção por segundo	26L/s
Intensidade do som	82dB
Potência de sucção	17-18KPa
Proteção IP	4
Dimensões (CxLxA)	390x340x460mm
Peso	7,60Kg

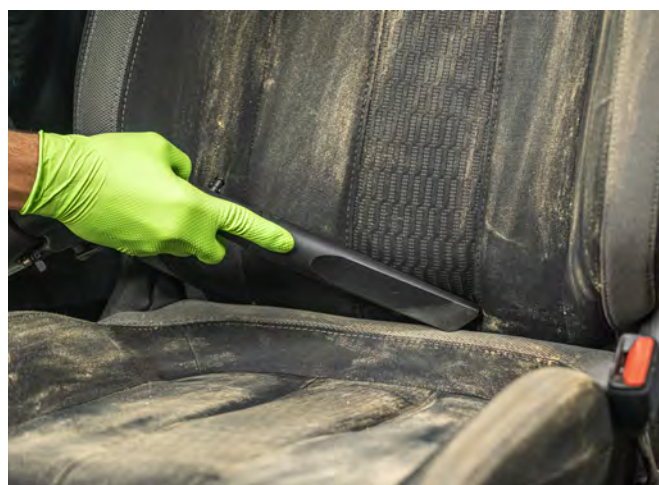

53947 149,00€

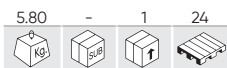

LAVADORA DE ALTA PRESSÃO 1400W



REPOSIÇÕES DISPONÍVEIS



Tensão	230V
Potência	1400W
Frequência	50Hz
Pressão do trabalho	70-105BAR
Fluxo máximo de operação	5,5-6,8L/min
Temperatura de trabalho	50°C
Proteção IP	IPX5
Peso	5,80Kg
Dimensões (CxLxA)	280x255x440mm

53948 324,00€



LAVADORA DE ALTA PRESSÃO 2400W



REPOSIÇÕES DISPONÍVEIS



Tensão	230V
Potência	2400W
Frequência	50Hz
Pressão do trabalho	120-180BAR
Fluxo máximo de operação	5,5-8L/min
Temperatura de trabalho	50°C
Proteção IP	IPX5
Peso	12,10Kg
Dimensões (CxLxA)	440x345x505mm

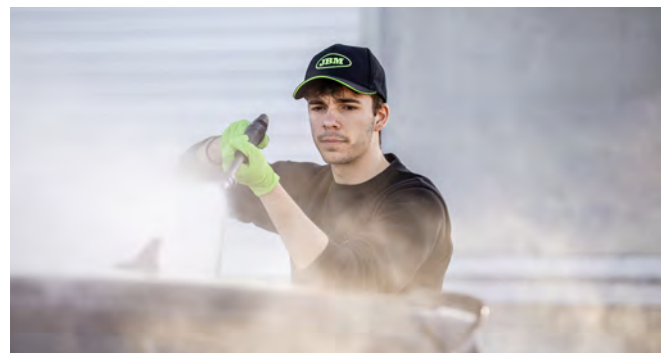

54805 478,00€



NEW

CONJUNTO DE CANDEEIROS DE TECTO HEXAGONAIS

Brilho	83640Lm
Potência	615W
Eficiência	110-120Lm/W
Tensão	185-240V
Tipo de LED	2835
Número de LEDs	12
Temperatura de cor do LED	6500k
Material	Al + PC
Comprimento do cabo	1,5m Enchufe europeu/ EU Plug
Proteção IP	IP45
Peso	7,50Kg
Dimensões (CxLxA)	2435x42x4845mm

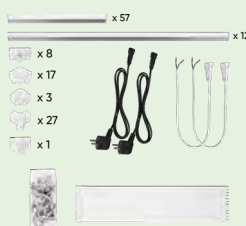

REPOSIÇÕES DISPONÍVEIS

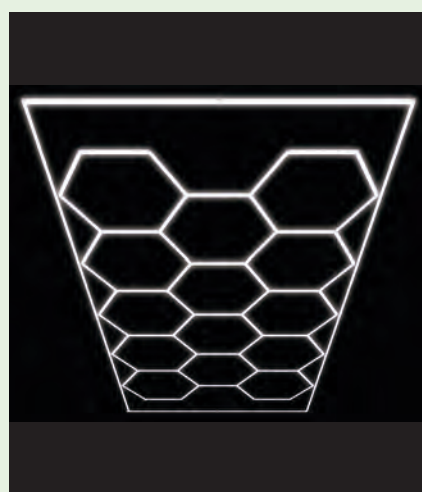



54346 12,80€

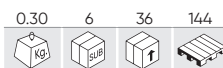

CONJUNTO DE 3 ESCOVAS DE LIMPEZA PARA BERBEQUIM



Peças	3
Tamanho do eixo	1/4"
Diâmetro	50, 88, 100mm

54912 7,90€

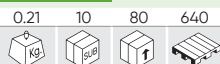

NEW

CONJUNTO PROFÍSSIONAL DE LAVAGEM DE CARRO 4 EM 1 PARA INTERIOR E EXTERIOR



Peças	4
Material	PP
Comprimento da trincha	220, 225, 230, 240mm
Peso	0,21Kg

54895 16,80€



NEW

KIT DE DETALHAMENTO AUTOMOTIVO COM 7 ACESSÓRIOS ESSENCIAIS



Peças	7
Material	PP
Comprimento da trincha	220, 225, 230, 240mm
Diâmetro da cabeça	50, 88, 100mm
Tamanho do eixo	1/4"
Peso	0,35Kg

50844 65,00€

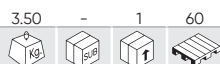

BANCO DE AÇO



Material	Acero/Steel, PVC
Capacidade	115Kg
Altura	380mm
Peso	3,50Kg
Dimensões (CxLxA)	360x375x380mm

54682 54,00€



PLATAFORMA MÓVEL DE AJOELHAMENTO



Material	Polipropileno/Polypropylene
Carga máxima	100Kg
Peso	1,7Kg
Dimensões (CxLxA)	500x255x85mm

53191 14,80€



ESTRADO EM ESPUMA



Material	Espuma EVA/EVA foam
Peso	0,15Kg
Dimensões (CxLxA)	480x180x320mm