



JBM[®]

CARROZZERIA

2026

53224

142,00€

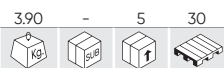

SET DI ATTREZZI RIPARA AMMACCATURE



RICAMBI DISPONIBILI



x5	SET DI 5 DISCHI BLU (RIF. 53224)
x5	SET DI 5 DISCHI GIALLI (RIF. 53224)
x10	SET DI 10 DISCHI ROSSI (RIF. 53224)
x5	SET DI 5 STICK DI COLLA (RIF. 53224)

52876

182,00€



SET DI TASSI RIVESTITI IN PLASTICA 7 PEZZI



RICAMBI DISPONIBILI



x1	TASSO A INCUDINE
x1	TASSO A ROTAIA
x1	TASSO CURVO
x1	TASSO CUNEO
x1	TASSO A VIRGOLA
x1	TASSO A TACCO BOMBATO
x1	TASSO A VIRGOLA CON MANICO

51131

61,00€

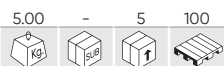

SET DI MARTELLI SPECIALI DA CARROZZIERE



RICAMBI DISPONIBILI



x1	MARTELLO A TESTA PIATTA
x1	MARTELLO PIATTO PICCOLO
x1	MARTELLO PIATTO CONICO
x1	TASSELLO
x1	TASSELLO AD ALETTA
x1	TASSELLO A DUE LATI SMUSSI
x1	TASSELLO CUNEO A 8 O A SLITTA

53545

38,50€

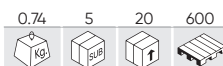

5 BUSSOLE ESAGONALI DA 3/8" - EXTRA LUNGHE



x1		8mm
x1		10mm
x1	3/8"	120mmL 12mm
x1		13mm
x1		14mm



55116

125,50€

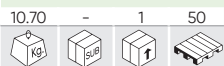

NEW

SET RIPARAZIONE AMMACCATURE CARROZZERIA 11 PZ

Pezzi	11
Peso	10,50Kg
Dimensioni (LxIxH)	770x100x215mm



51832 18,00€

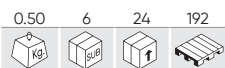

SET DI 4 LEVE DI NYLON A LAMA



x4	19x273mm
	22x273mm
	25x273mm
	36x273mm

50903 30,80€

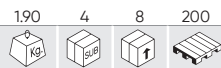

SET DI 5 LEVE DI METALLO



x5	180mm
	280mm
	380mm
	430mm
	600mm

52026 34,50€

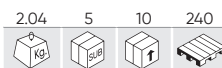

SET DI DUE LEVE DI METALLO



x2	900mm
	900mm

52851 9,65€

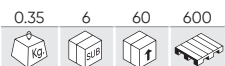

SET DI 2 LEVE



x2	7x220mm
	8.5x245mm

53110 29,50€

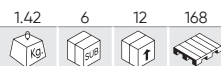

SET DI 6 LEVE



x1	4.5x240mm	x1	4.5x490mm
	8.5x240mm		8.5x490mm
	10.3x24mm		10.3x490mm

51360 8,20€

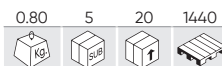

51361 12,00€
LEVA EUROPEA CON GANCIO



x1	18" x 5/8
	24" x 3/4

50901 16,00€

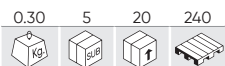

SET DI 5 LEVE DI NYLON



x5	60x160, 63x175, 30x200, 20x180, 20x215mm
----	--

52788 39,00€



SET DI 27 LEVE DI NYLON

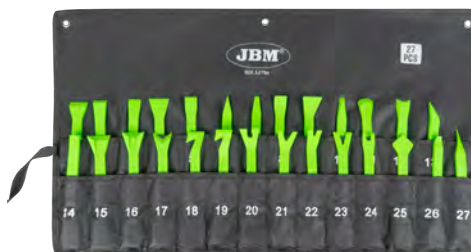

52977

141,00€

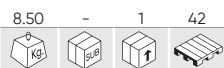

SET DI 4 LEVE EXTRALUNGHE



Pezzi	4
Misure	0° 900x16mm, 30°900x16mm, 75°600x16mm, 90°600x16mm
Peso	8,50Kg
Dimensioni (LxIxH)	1005x260x80mm

52540

221,00€



TIRABOLLI A VUOTO D'ASPIRAZIONE

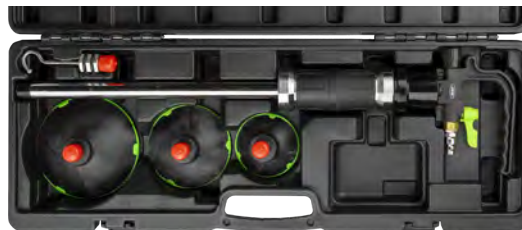

Pezzi	5
Resistenza	7,6BAR
Diametro	75, 100, 125mm
Lunghezza	620mm
Peso	4,36Kg
Dimensioni (LxIxH)	620x250x100mm

54017

12,00€

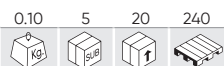

STRUMENTO PER CALAFATAGGIO IN SILICONE

Contiene	Almohadillas de silicona/Silicone pads
Peso	0,10Kg
Dimensioni (LxIxH)	270x44x95mm

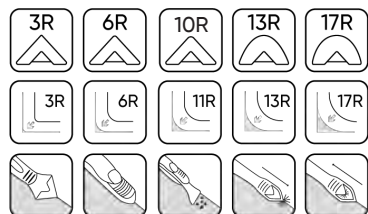

52533

10,00€

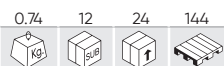

PISTOLA PER SILICONE 300ML



Capacità	300ml
Peso	0,74Kg
Dimensioni (LxIxH)	360x215x60mm

53567

43,00€



PISTOLA PER SIGILLANTE PNEUMATICA 310ML



Presa d'aria	1/4"
Pressione di lavoro	2,5-5BAR
Capacità	310ml
Peso	1,05Kg
Dimensioni (LxIxH)	305x185x65mm

60032

123,00€



SIRINGA A BATTERIA PER SIGILLARE

Tensione	20V
Forza di spinta massima	2500N
Velocità di avanzamento	0,5-8 mm/s (30-480mm/min)
Capacità del cartuccio	300ml
Velocità	Ajustable/Adjustable
LED	Si/Yes
Compatibile con	60012, 60013, 60015, 60016, 60017
Peso	1,60Kg
Dimensioni (LxIxH)	420x70x270mm



RICAMBI DISPONIBILI

60032C

266,00€

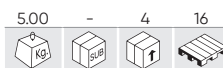

SIRINGA A BATTERIA PER SIGILLARE CON CUSTODIA

Tensione	20V
Forza di spinta massima	2500N
Velocità di avanzamento	0,5-8mm/s (30-480mm/min)
Capacità del cartuccio	300ml
Velocità	Ajustable/Adjustable
Include	60032, 60013, 60016
LED	Si/Yes
Compatibile con	60012, 60013, 60015, 60016, 60017
Peso	4,96Kg
Dimensioni (LxIxH)	500x130x400mm



RICAMBI DISPONIBILI

53525

12,00€

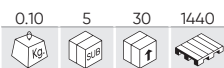

MORSETTO DI BLOCCAGGIO PER PISTONCINI COFANO E BAGAGLIAIO



Diametro	10mm
Peso	0,10Kg
Dimensioni (LxIxH)	140x90x30mm

53655

12,00€

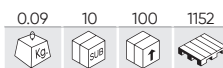

CHIAVE VAG PER RIMOZIONE MANIGLIE PER PORTE



Marche	VAG
Peso	0,09Kg
Dimensioni (LxIxH)	340x70x40mm

54246

104,00€

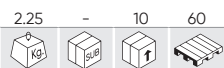

BILANCIA DI PRECISIONE 5KG



Capacità	5Kg
Precisione	0,1g
Misurazione della tensione in corrente alternata	220V
Misurazione della tensione in corrente continua	6V
Temperatura di lavoro	0-40°C
Umidità relativa	10%<RH<85%
Peso	2,25Kg
Dimensioni (LxIxH)	280x115x285mm

54247

99,00€



BILANCIA DI PRECISIONE 2KG



Capacità	2Kg
Precisione	0,1g
Misurazione della tensione in corrente alternata	220V
Misurazione della tensione in corrente continua	6V
Temperatura di lavoro	0-40°C
Umidità relativa	10%<RH<85%
Peso	2,25Kg
Dimensioni (LxIxH)	352x136x240mm

53230

20,50€

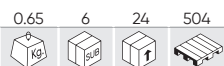

SET DI UTENSILI PER APRIRE L'AUTO

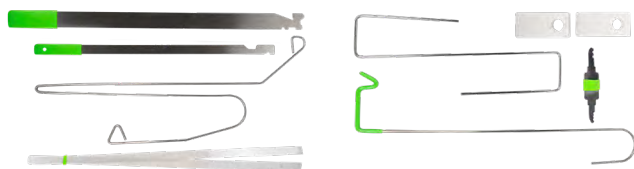

- x2 Nastro di apertura della maniglia
- x2 Cuneo in nylon con foro centrale
- x1 Gancio rigido a forma di "s"
- x1 Gancio scorrevole per lo sblocco
- x1 Leva di sblocco larga 610mm
- x1 Leva di bloccaggio stretta da 558mm
- x1 Chiave tipo granulare per serrature
- x1 Gancio speciale

52077

29,50€

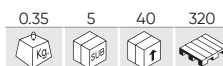

SET DI 4 CUSCINETTI GONFIABILI



- x1 Cuscinetto da 16x16cm
- x1 Cuscinetto da 32x12cm
- x1 Cuscinetto da 19x6cm
- x1 Cuscinetto da 18x4,5cm
- x1 Pompa manuale

53486

30,50€

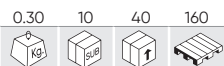

SPECCHIO PER L'ISPEZIONE DELLE AMMACCATURE

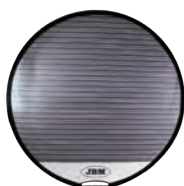

Diametro	800mm
Peso	0,30Kg
Dimensioni (LxIxH)	320x300x40mm

15375

28,00€

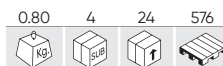

RECIPIENTE CON LIQUIDO PER REF. 53673



Capacità	600ml
Peso	0,80Kg
Dimensioni (LxIxH)	75x75x190mm

53673

80,00€

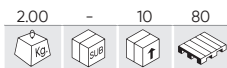

KIT DI RIPRISTINO FANALI

x6	SET DI 6 TELE SMERIGLIATE PER RIF. 53673
x1	ADATTATORE PER CONVERSIONE DELLA CORRENTE ALTERNATA IN CORRENTE CONTINUA (RIF. 53673)
x1	ADATTATORE 12V PER RIF. 53673
x1	TAZZA PER EVAPORAZIONE PER RIF. 53673
x1	COPERCHIO CURVO CON ANELLO DI TENUTA IN GOMMA PER RIF. 53673
x1	COPERCHIO PIATTO CON ANELLO DI TENUTA IN GOMMA PER RIF. 53673
x1	IMBUTO PER RIF. 53673
x1	PIASTRA DI LAPPATURA PER RIF. 53673
x1	CARTA STRUTTURATA PER RIF. 53673
x1	RECIPIENTE CON LIQUIDO PER RIF. 53673



SET DI 10 CARTE VETRATE

REF.	GRANA	kg	L	€
14710	180	0.25	10	3,90€
14711	280	0.20	10	4,00€
14712	360	0.20	10	4,00€

REF.	GRANA	kg	L	€
14713	600	0.15	10	4,25€
14714	800	0.15	10	4,50€
14715	1200	0.10	10	4,75€



VIDEO TUTORIAL



RICAMBI DISPONIBILI

52740

690,00€

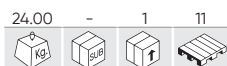

ALLINEATORE PER FARI CON MISURATORE DI LUCE DA 152CM



Altezza minima di sollevamento	230mm
Altezza massima di sollevamento	1350mm
Misurazione	LUX Digital
Compatibile con	Hálogeno/Xenón
Peso	24,00Kg
Dimensioni (LxIxH)	520x280x1520mm

52836

1.100,00€



ALLINEATORE DI FARI DOPPIO LASER



VIDEO TUTORIAL

Altezza minima di sollevamento	230mm
Altezza massima di sollevamento	1350mm
Misurazione	Láser/Laser, LUX Digital
Compatibile con	Cualquier tipo de faro/Any type of car lighthouse
Peso	24,85Kg
Dimensioni (LxIxH)	520x270x1560mm

53626

18,00€

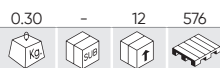

KIT DI RIPRISTINO FANALI

- x2 P800 Dischi abrasivi
- x2 P1200 Dischi abrasivi
- x2 P2000 Dischi abrasivi
- x2 3.0ml Liquido protezione UV
- x2 Adattatore (3/8" & 1/4")
- x1 85gm Pasta lucidante
- x1 Nastro adesivo
- x1 Disco per lucidare la lana
- x1 Disco di spugna bianco



IN ESPOSITORE DA 12 UNITÀ

53729

20,50€

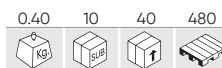

KIT STRUMENTI PER REGOLARE I FARI

- x1 H6
- x1 300mm H7
- x1 T25



VENTOSA

52262

7,50€

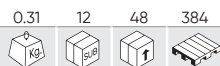

Pezzi	1
Diametro	115mm
Capacità	40,00Kg

52263

13,50€



Pezzi	1
Diametro	115mm
Capacità	70,00Kg

52264

21,50€

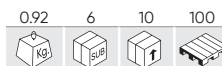

Pezzi	1
Diametro	115mm
Capacità	100,00Kg

52265

30,50€

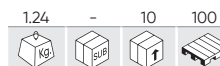

Pezzi	1
Diametro	115mm
Capacità	120,00Kg

52295

7,00€

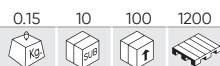

Pezzi	2
Diametro	60mm
Capacità	5,00Kg

52589

13,00€

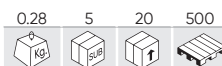

Pezzi	1
Diametro	70mm
Capacità	8,00Kg

52765

21,70€

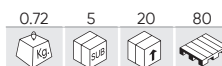

Pezzi	1
Diametro	120mm
Capacità	80,00Kg

52998

48,00€



Pezzi	3
Diametro	120mm
Capacità	80,00Kg

53232

39,50€

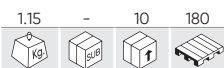

STRUMENTI PER SOSTITUZIONE DI CRISTALLI

- x1 UTILE ESTRATTORE DI STAMPI
- x1 LEVA PER RIMUOVERE LA GOMMA
- x1 GANCIO DI ESTRAZIONE
- x1 FILO DA TAGLIO 1.8M
- x2 MANICI PER TAGLIARE IL FILO
- x1 PERCORSO DEL CAVO



REF.	DESCRIZIONE					€
13813	CAVO PER LA RIMOZIONE DEI TERGICRISTALLI	0.10	10	60	1200	7,00€
13814	MANIGLIE PER LA RIMOZIONE DEI TERGICRISTALLI	0.20	10	60	1080	11,00€

55012

680,00€



NEW

SET DI ATTREZZI PER LA SOSTITUZIONE DEL PARABREZZA CON VALIGETTA

- x1 ANCORA DELLA LINEA DI TAGLIO
- x1 PULEGGIA DELLA LINEA DI TAGLIO
- x1 AVVOLGITORE DELLA LINEA DI TAGLIO
- x1 CAVO IN FIBRA SINTETICA L:100M
- x1 UTENSILE PERFORANTE
- x1 BARRA PER INSTALLAZIONE SCALPELLO
- x1 UTENSILE A GANCIO TIPO PUNTA 90°
- x1 CHIAVE A CRICCHETTO CON BUSSOLA 1/4"
- x1 TAVOLA PROTETTIVA

RICAMBI
DISPONIBILI

52321

8,80€

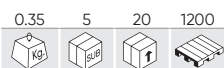
CINGHIA CON TENDITORE
5M X 25MM

Pezzi	2
Lunghezza	5m
Capacità	800Kg
Peso	0,35Kg
Dimensioni (LxIxH)	125x115x30mm

52327

12,00€

CINGHIA DI SOSTEGNO
CON TENDITORE 8M X
25MM

Pezzi	2
Lunghezza	8m
Capacità	800Kg
Peso	0,46Kg
Dimensioni (LxIxH)	150x140x40mm

50577

12,60€

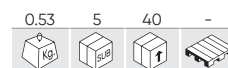

PINZA A SCATTO



Lunghezza	280mm
Peso	0,53Kg

52385

268,00€



SET DI 6 PINZE AUTOBLOCCANTI



W (195mm) JJ (195mm) LL (195mm) J (210mm) T (215mm) L (225mm)



52982

55,00€

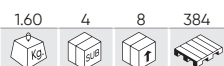

SET DI 3 PINZE AUTOBLOCCANTI SUPERLUNGHE



Angolo 90°
Lunghezza 340mm



Angolo 45°
Lunghezza 360mm



Angolo 0°
Lunghezza 370mm

53675

53,00€

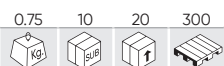

PINZA AUTOBLOCCANTE CON GANASCE DRITTE



IN ESPOSITORE DA 10 UNITÀ

53676

47,00€



PINZA AUTOBLOCCANTE CON GANASCE CURVE



IN ESPOSITORE DA 10 UNITÀ

53677

59,00€

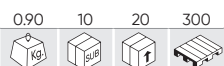

PINZA AUTOBLOCCANTE CON GANASCE A COLLO DI CIGNO OSCILLANTI



IN ESPOSITORE DA 10 UNITÀ

53678

55,00€







PINZA AUTOBLOCCANTE CON GANASCE CURVE LUNGHE



IN ESPOSITORE DA 10 UNITÀ

PINZE AUTOBLOCCANTI CON GANASCE

REF.	DESCRIZIONE	mm	MATERIALE		T					€
52390	PINZA AUTOBLOCCANTE	250mm	CrMo	-	-	0.50	5	40	640	37,50€
52474	MORSETTO AD ANELLO 5T	190mm	Acciaio	0-20mm	5T	3.49	-	5	1500	69,00€
52475	MORSETTO AD ANELLO ALLUNGATO 3T	170mm	Acciaio	0-25mm	3T	3.60	-	10	1500	62,00€
52476	MORSETTO AD ANELLO 5T	220mm	Acciaio	0-25mm	5T	3.10	-	10	1500	50,00€
52477	MORSETTO AGGANCIO A PINZA 2T	200mm	Acciaio	0-60mm	2T	2.65	-	10	1500	76,50€
52478	MORSETTO AGGANCIO A 90° 5T	170mm	Acciaio	0-20mm	5T	2.90	-	10	1500	49,00€
52479	MORSETTO AGGANCIO A 90° 3T	155mm	Acciaio	0-20mm	3T	1.18	-	30	1500	24,70€
52480	MINI MORSETTO AGGANCIO A 2 VIE 3T	210mm	Acciaio	0-25mm	3T	2.00	-	10	1500	44,00€
52481	MORSETTO AGGANCIO QUADRATO 3T	220mm	Acciaio	0-20mm	3T	2.05	-	10	1500	52,00€
52482	MORSETTO AGGANCIO PIANO ANGOLO 45° 5T	210mm	Acciaio	0-10mm	5T	2.13	-	12	1500	44,00€
52483	MORSETTO AGGANCIO PIANO MINI 5T	210mm	Acciaio	0-10mm	5T	2.02	-	12	1500	41,00€
52484	GANCI TIPO GAP 3T	280mm	Acciaio	0-110mm	3T	1.19	-	11	1500	70,00€
52485	GANCI AD UNCINO 4T	270mm	Acciaio	0-90mm	4T	1.17	-	30	1000	54,00€
52486	GANCI UNCINO + GAP 3T	280mm	Acciaio	0-110mm	3T	1.21	-	11	1500	66,00€
52487	MORSETTO A PINZA 5T	220mm	Acciaio	0-20mm	5T	2.27	-	7	1000	63,00€
52502	PINZA A SCATTO PER SALDATURA	280mm	CrMo	0-110mm	-	0.84	10	30	540	33,50€
52503	PINZA A SCATTO PER SALDATURA PRESA PIANA	280mm	CrMo	0-105mm	-	0.85	-	30	540	35,00€
52504	MORSETTO A DOPPIA GRIFFIA PER CARROZZERIA	225mm	CrMo	0-50mm	-	1.14	-	30	480	27,60€
52505	PINZA A SCATTO PRESA PIANA	170mm	CrMo	0-40mm	-	0.27	36	72	2160	22,50€
52506	PINZA A SCATTO CON PRESA PIANA	170mm	CrMo	0-50mm	-	0.28	36	72	2160	16,00€
52507	PINZA A SCATTO PRESA PIANA	250mm	CrMo	0-80mm	-	0.77	5	30	420	32,50€
52511	PINZA A SCATTO PER SALDATURA 18"	440mm	CrMo	0-225mm	-	1.31	-	20	280	44,50€
52512	PINZA A SCATTO PER SALDATURA CON PRESA PIANA	450mm	CrMo	0-155mm	-	1.31	-	20	280	53,00€



52390



52474



52475



52476



52477



52478



52479



52480



52481



52482



52483



52484



52485



52486



52487



52502



52503



52504



52505



52506



52507



52511



52512

53983

215,00€

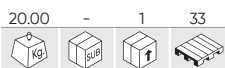

PORTA PARTI - PARABREZZA E GUSCIO



Capacità	150Kg
Dimensioni piegato	1200x120x210mm
Peso	19,40Kg
Dimensioni (LxIxH)	1200x700x635mm

53124

287,00€



CAVALLETTO UNIVERSALE



Capacità	100Kg
Dimensioni piegato	25x860x840mm
Peso	21,10Kg
Dimensioni (LxIxH)	1380x860x1300mm

53125

477,00€

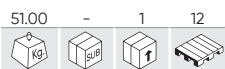

CARRELLO PER CONSERVAZIONE DEI COMPONENTI

Capacità	150Kg
Peso	51,00Kg
Dimensioni (LxIxH)	900x610x1980mm



50923

454,00€

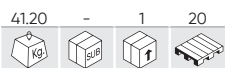

CARRELLO TRASPORTATORE SPECIALE LAMIERA 340KG



RICAMBI DISPONIBILI

Capacità	340Kg
Apertura	0-1100mm
Peso	41,20Kg
Dimensioni (LxIxH)	1340x250x240mm

50839

198,00€



TRASPORTATORE IDRAULICO 680KG



RICAMBI DISPONIBILI

Capacità	680Kg
Apertura	345-660mm
Peso	19,20Kg
Dimensioni (LxIxH)	680x625x230mm

53079

89,00€

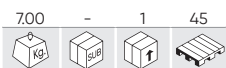

CAVALLETTO "X"



Capacità	100Kg
Dimensioni piegato	660x1140x300mm
Peso	6,77Kg
Dimensioni (LxIxH)	600x680x870mm

53080

99,00€

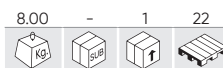

CAVALLETTO PER VETRI AUTO



Capacità	70Kg
Dimensioni piegato	1130x285x990mm
Peso	7,87Kg
Dimensioni (LxIxH)	1130x610x990mm

52749

79,00€

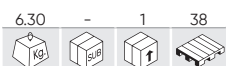

CAVALLETTO PROFESSIONALE

RICAMBI
DISPONIBILI

Capacità	220Kg
Dimensioni piegato	1030x905x500mm
Peso	6,25Kg
Dimensioni (LxIxH)	1030x390x1000mm

53736

99,00€



SUPPORTO PIEGHEVOLE PER PARAURTI



Capacità	25Kg
Dimensioni piegato	600x310x1230mm
Peso	8,10Kg
Dimensioni (LxIxH)	600x750x1060mm

53685

310,00€

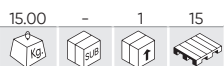

STAFFA PARAURTI



Capacità	25Kg
Dimensioni piegato	960x865x95mm
Peso	14,50Kg
Dimensioni (LxIxH)	762x1118x1346mm

54579

229,00€



PORTAPARAURTI MOBILE



Capacità	60Kg
Capacità della barra	15Kg
Peso	21,00Kg
Dimensioni (LxIxH)	1200x1200x2150mm

53134

145,00€

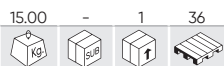

SUPPORTO PER VERNICE REGOLABILE

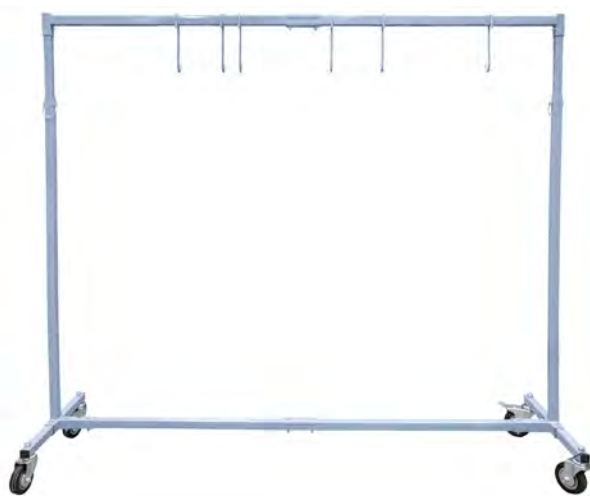

Capacità	150Kg
Altezza minima di sollevamento	1270mm
Altezza massima	2030mm
Contiene	6 Ganchos/Hooks
Peso	14,70Kg
Dimensioni (LxIxH)	1770x500x2030mm

53126

243,00€



SUPPORTO BASCULANTE PER VERNICIATURA



RICAMBI
DISPONIBILI

Capacità	50Kg
Contiene	6 Brazos de sujeción/Support arms
Peso	19,70Kg
Dimensioni (LxIxH)	1220x250x165mm

54959 **268,00€**

20.20 - 1 16 **NEW**

SUPPORTO MOBILE PER VERNICIATURA CERCHI RUOTA



Materiale	GS
Altezza	1100 - 1420mm
Rivoluzionaria	360°
Vassoi	2
Diametro della ruota	15" - 22"
Dimensioni (LxIxH)	900x670x1100mm

54960 **159,50€**

11.10 - 1 33 **NEW**

SUPPORTO UNIVERSALE PER PANNELLI E PARAURTI



Materiale	GS
Rivoluzionaria	90°
Carico massimo	100Kg
Dimensioni (LxIxH)	1220x1330x1870mm
Peso	10,50Kg

54961 **20,00€**

1.10 1 20 240 **NEW**

SUPPORTO PER CERCHI

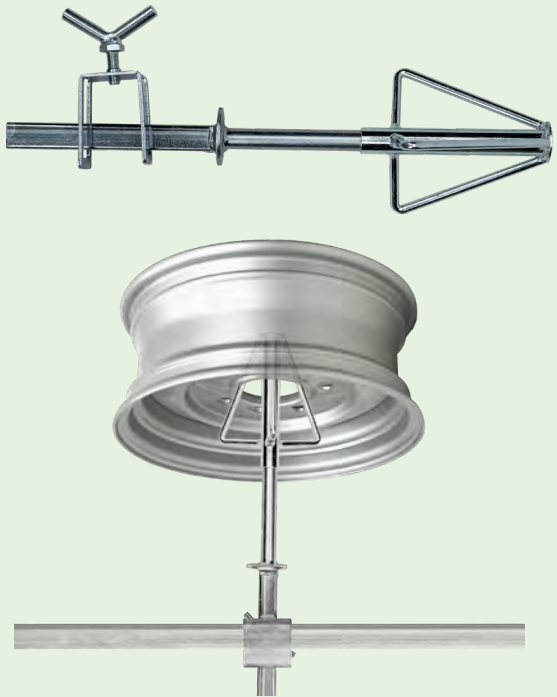

Peso	1,15Kg
Dimensioni (LxIxH)	130x100x380mm

54962 **430,50€**

40.25 - 1 14 **NEW**

CARRELLO PORTAPEZZI CON SUPPORTO PER PANNELLI



Carico massimo	120Kg
Capacità della barra	40Kg
Peso	40,00Kg
Dimensioni (LxIxH)	1220x1330x1900mm

52230

398,00€

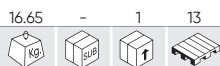

PIATTAFORMA D'ALLUMINIO TELESCOPICA



RICAMBI
DISPONIBILI

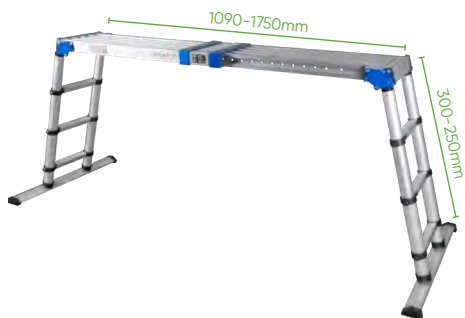

Capacità	150Kg
Dimensioni piegato	300x1090x900mm
Lunghezza minima	1090mm
Lunghezza massima	1750mm
Altezza minima	550mm
Altezza massima	930mm
Materiale	Al
Conformità alla direttiva europea	EN131
Peso	16,65Kg
Dimensioni (LxIxH)	300x1750x900mm

50656

290,00€



KIT DI 2 PIATTAFORME D'ALLUMINIO



RICAMBI
DISPONIBILI



Capacità	100Kg
Dimensioni della grande piattaforma (LxIxH)	1300x300x550mm
Dimensioni della grande piattaforma piegata (LxIxH)	1300x300x140mm
Dimensioni della piccola piattaforma (LxIxH)	1000x300x300mm
Dimensioni della piccola piattaforma piegata (LxIxH)	1000x300x140mm
Materiale	Al
Contiene	11897, 15552
Conformità alla direttiva europea	EN131
Peso	10,45Kg

50913

229,00€



PIATTAFORMA D'ALLUMINIO GRANDE

Capacità	100Kg
Materiale	Al
Conformità alla direttiva europea	EN131
Dimensioni (LxIxH)	1400x300x800mm
Peso	6,50Kg
Dimensioni piegato	1400x300x14mm



54789

34,00€

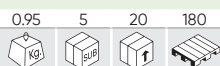

NEW

PROTEZIONE ANTERIORE PER AUTO



Materiale	Poliéster/Polyester
Peso	0,95Kg
Dimensioni piegato	330x50x210mm
Dimensioni assemblate	4050x725mm

51622

27,00€



PROTETTORE MAGNETICO COPRI ALETTE E FRONTALI



Tipo	Imantado/Magnetized
Materiale	PVC
Peso	0,45Kg
Dimensioni (LxAl)	1300x640mm

53922

35,00€



PORTA ROTOLO DI CARTA PER PARETE



Materiale	Acero inoxidable/Stainless steel
Altezza minima	480mm
Altezza massima	690mm
Rotolo di carta	380mm
Dimensioni piegato	450x270x480mm
Peso	1,55Kg
Dimensioni (LxH)	4550x210x690mm

CARTA NON INCLUSA

53921

39,00€



PORTA ROTOLO DI CARTA



Materiale	Acero inoxidable/Stainless steel
Altezza	975mm
Rotolo di carta	380mm
Peso	1,85Kg
Dimensioni (LxH)	450x345x975mm

CARTA NON INCLUSA

BASTONE ESTENSIBILE MULTIFUNZIONE

REF.	MIN.	MAX.	KG	UNITA'	UNITA'	UNITA'	€
52497	1200mm	530mm	0.29	6	48	480	27,00€
53196	1600mm	710mm	0.37	6	48	384	33,00€



53221

5,00€

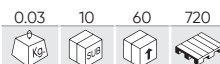

SET 3 PANNI IN MICROFIBRA



Pezzi	3
Colore	Verde/Green
Materiale	PL
Misura	360x360mm

55066

319,50€



NEW

LEVIGATRICE ELETTRICA 150 MM 400W



Tensione	220V
Potenza	400W
Frequenza	50Hz
Velocità nominale	4000-10000RPM
Diametro del disco	150mm
Orbita di levigatura	5mm
Lunghezza del cavo	3m
Peso	1,10Kg
Dimensioni (LxH)	310x150x110mm

54556

74,00€

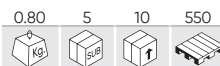

LEVIGATRICE A NASTRO 3/8"

RICAMBI
DISPONIBILI

Presa d'aria	1/4"
Velocità nominale	18000RPM
Consumo di aria reale	113L/min
Pressione di lavoro	6,2BAR
Intensità del suono	89dB
Orbita di levigatura	10x330mm
Orbita di levigatura	60x80x120mm
Angolo	90°
Peso	0,75Kg
Dimensioni (LxH)	290x100x50mm

55025

120,00€



NEW

PISTOLA DI ASCIUGATURA ELETTRICA



Tensione	220V ~ 50Hz
Potenza	1350W
Lunghezza del cavo	5M
Portata d'aria	93 CFM
Accelerazione massima dell'aria	22000ft/min
Peso	1,80Kg
Dimensioni (LxIxH)	270x140x280mm

60071

140,00€



NEW

SOFFIATORE D'ARIA A BATTERIA PER L'ASCIUGATURA DEI VEICOLI



Tensione	20V
Flusso d'aria	55m/s
RPM (giri al minuto)	22500-35000
Portata d'aria	10,4CFM (294L/min)
Diametro	2,5"
Compatibile con	60013, 60015
Peso	0,76Kg
Dimensioni (LxIxH)	168x116x255mm

54771

279,00€



ASPIRATORE PER TAPPEZZERIA DA 20 L (ASCIUTTO+BAGNATO)



RICAMBI DISPONIBILI

Tensione	230V
Potenza	1200W
Frequenza	50Hz
Capacità	20L
Litri di aspirazione al secondo	26L/s
Intensità del suono	82dB
Potenza di aspirazione	17-18KPa
Protezione IP	4
Dimensioni (LxIxH)	390x340x460mm
Peso	7,60Kg

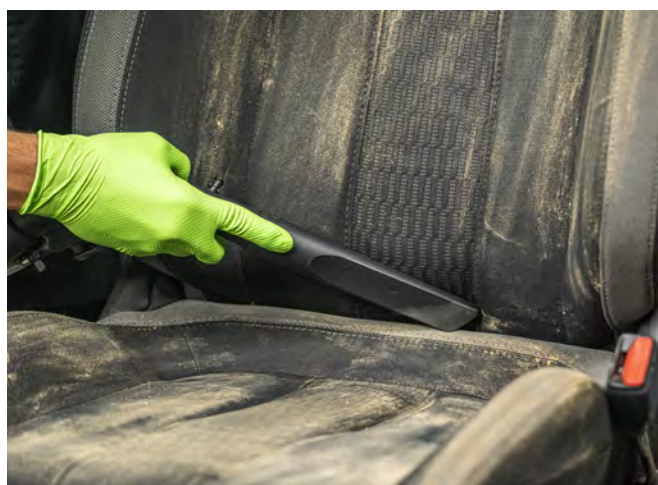

53947

149,00€

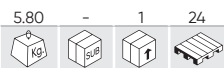

IDROPULITRICE AD ALTA PRESSIONE 1400W



RICAMBI
DISPONIBILI



Tensione	230V
Potenza	1400W
Frequenza	50Hz
Pressione di lavoro	70-105BAR
Portata massima di funzionamento	5,5-6,8L/min
Temperatura di lavoro	50°C
Protezione IP	IPX5
Peso	5,80Kg
Dimensioni (LxIxH)	280x255x440mm

53948

324,00€



IDROPULITRICE AD ALTA PRESSIONE 2400W



RICAMBI
DISPONIBILI



Tensione	230V
Potenza	2400W
Frequenza	50Hz
Pressione di lavoro	120-180BAR
Portata massima di funzionamento	5,5-8L/min
Temperatura di lavoro	50°C
Protezione IP	IPX5
Peso	12,10Kg
Dimensioni (LxIxH)	440x345x505mm



54805

478,00€

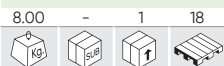

NEW

SET DI PLAFONIERE ESAGONALI A LED

Luminosità	83640Lm
Potenza	615W
Efficienza	110-120Lm/W
Tensione	185-240V
Tipo di LED	2835
Numero di LED	12
Temperatura di colore dei LED	6500k
Materiale	Al + PC
Lunghezza del cavo	1,5m Enchufe europeo/ EU Plug
Protezione IP	IP45
Peso	7,50Kg
Dimensioni (LxIxH)	2435x42x4845mm

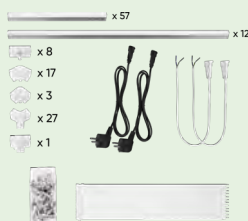

RICAMBI
DISPONIBILI





54346

12,80€



SET DI 3 SPAZZOLE PER LA PULIZIA DEL TRAPANO



Pezzi	3
Dimensioni dell'asse	1/4"
Diametro	50, 88, 100mm

54912

7,90€

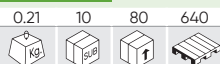

NEW

SET PROFESSIONALE 4 IN 1 PER IL LAVAGGIO AUTO PER INTERNI ED ESTERNI



Pezzi	4
Materiale	PP
Lunghezza del pennello	220, 225, 230, 240mm
Peso	0,21Kg

54895

16,80€



NEW

SET PER LA CURA DELL'AUTO CON 7 ACCESSORI ESSENZIALI



Pezzi	7
Materiale	PP
Lunghezza del pennello	220, 225, 230, 240mm
Diametro della testa	50, 88, 100mm
Dimensioni dell'asse	1/4"
Peso	0,35Kg

50844

65,00€

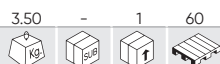

SGABELLO IN ACCIAIO



Materiale	Accero/Steel, PVC
Capacità	115Kg
Altezza	380mm
Peso	3,50Kg
Dimensioni (LxIxH)	360x375x380mm

54682

54,00€

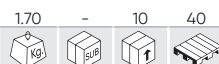

PIATTAFORMA MOBILE PER INGINOCCHIARSI



Materiale	Polipropileno/Polypropylene
Carico massimo	100Kg
Peso	1,7Kg
Dimensioni (LxIxH)	500x255x85mm

53191

14,80€



TAPPETO INDIVIDUALE IN MATERIALE ESPANSO



Materiale	Espuma EVA/EVA foam
Peso	0,15Kg
Dimensioni (LxIxH)	480x180x320mm