



JBM[®]

CARROSSERIE

2026

53224

142,00€

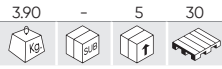

COFFRET DE RÉPARATION POUR BOSSELLEMENT



PIÈCES DE RECHANGE



| | |
|-----|--|
| x5 | SAC DE 5 DISQUES BLEUS POUR REF.53224 |
| x5 | SAC DE 4 DISQUES JAUNES POUR REF.53224 |
| x10 | SAC DE 10 DISQUES ROUGES POUR REF. 53224 |
| x5 | JEUX DE 5 TUBES DE COLLE POUR REF. 53224 |

52876

182,00€



COFFRET TAS POUR CARROSSIER



PIÈCES DE RECHANGE



| | |
|----|--|
| x1 | DOUBLE TAS DE CARROSSIER |
| x1 | TAS DE CARROSSIER RECTANGLE |
| x1 | TAS DE CARROSSIER COURBURE |
| x1 | TAS DE CARROSSIER FAÇON HACHETTE |
| x1 | TAS DE CARROSSIER ÉPINÇOIR |
| x1 | TAS DE CARROSSIER TALON |
| x1 | TAS DE CARROSSIER ÉPINÇOIR AVEC MANCHE |

51131

61,00€

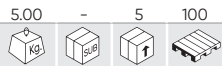

COFFRET CARROSSIER POUR DÉBOSELAGE



PIÈCES DE RECHANGE



| | |
|----|----------------------------------|
| x1 | MARTEAU TÊTE RONDE/CARRÉ |
| x1 | MARTEAU TÊTE RONDE/PANNE POINTUE |
| x1 | MARTEAU TÊTE RONDE /PANNE DROITE |
| x1 | TAS TALON |
| x1 | TAS À RAIL |
| x1 | TAS TÊTE CARRÉE |
| x1 | TAS VIRGULE |

53545

38,50€

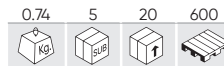

COFFRET DE DOUILLES 5, PIÈCES DE TÊTES HEXAGONALES ALLONGÉES 3/8"



| | | |
|----|------|-------------|
| x1 | | 8mm |
| x1 | | 10mm |
| x1 | 3/8" | 120mmL 12mm |
| x1 | | 13mm |
| x1 | | 14mm |



55116

125,50€



NEW

KIT DE RÉPARATION DES BOSSES DE CARROSSERIE 11 PCS

| | |
|--------------------|---------------|
| Pièces | 11 |
| Poids | 10,50Kg |
| Dimensions (LxlxH) | 770x100x215mm |



51832 18,00€

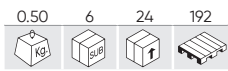

JEU DE 4 BURINS EN NYLON



| | |
|----|----------|
| x4 | 19x273mm |
| | 22x273mm |
| | 25x273mm |
| | 36x273mm |

50903 30,80€

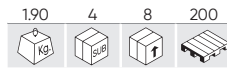

JEU DE 5 LEVIERS COUDES METAL



| | |
|----|-------|
| x5 | 180mm |
| | 280mm |
| | 380mm |
| | 430mm |
| | 600mm |

52026 34,50€

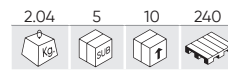

JEU DE 2 LEVIERS METAL



| | |
|----|-------|
| x2 | 900mm |
| | 900mm |

52851 9,65€

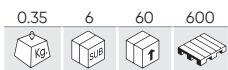

JEU DE 2 LEVIERS



| | |
|----|-----------|
| x2 | 7x220mm |
| | 8.5x245mm |

53110 29,50€

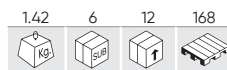

JEU DE 6 LEVIERS



| | | | |
|----|-----------|----|------------|
| x1 | 4.5x240mm | x1 | 4.5x490mm |
| | 8.5x240mm | | 8.5x490mm |
| | 10.3x24mm | | 10.3x490mm |

51360 8,20€

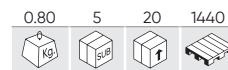

51361 12,00€

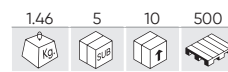

PIED DE BICHE



| | | |
|----|-------|-----------|
| x1 | 51360 | 18" x 5/8 |
| | 51361 | 24" x 3/4 |

50901 16,00€

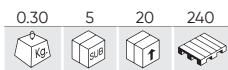

JEU DE 5 LEVIERS NYLON



| | |
|----|--|
| x5 | 60x160, 63x175, 30x200, 20x180, 20x215mm |
|----|--|

52788 39,00€

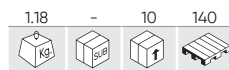

JEU DE 27 LEVIERS NYLON



52977

141,00€

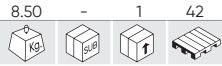

JEU DE 4 LEVIERS EXTRA LONG



| | |
|--------------------|--|
| Pièces | 4 |
| Mesures | 0° 900x16mm, 30°900x16mm, 75°600x16mm, 90°600x16mm |
| Poids | 8,50Kg |
| Dimensions (LxIxH) | 1005x260x80mm |

52540

221,00€



VENTOUSE PNEUMATIQUE POUR CARROSSERIE



| | |
|--------------------|----------------|
| Pièces | 5 |
| Résistance | 7,6BAR |
| Diamètre | 75, 100, 125mm |
| Longueur | 620mm |
| Poids | 4,36Kg |
| Dimensions (LxIxH) | 620x250x100mm |

54017

12,00€

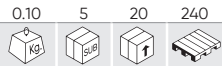

OUTIL D'ÉTANCHÉITÉ EN SILICONE

| | |
|--------------------|--|
| Contient | Almohadillas de silicona/Silicone pads |
| Poids | 0,10Kg |
| Dimensions (LxIxH) | 270x44x95mm |

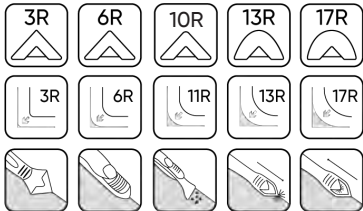

52533

10,00€

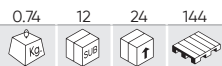

PISTOLET POUR CARTOUCHES 300ML



| | |
|--------------------|--------------|
| Capacité | 300ml |
| Poids | 0,74Kg |
| Dimensions (LxIxH) | 360x215x60mm |

53567

43,00€



SERINGUE PNEUMATIQUE POUR GARNISSAGE DES JOINTS 310ML



| | |
|---------------------|--------------|
| Entrée d'air | 1/4" |
| Pression de travail | 2,5-5BAR |
| Capacité | 310ml |
| Poids | 1,05Kg |
| Dimensions (LxIxH) | 305x185x65mm |

60032

123,00€



PISTOLET JOINT BATTERIE

| | |
|---------------------------|-----------------------------------|
| Tension | 20V |
| Force de poussée maximale | 2500N |
| Vitesse d'avance | 0,5-8 mm/s (30-480mm/min) |
| Capacité de la cartouche | 300ml |
| Vitesse | Ajustable/Adjustable |
| LED | Si/Yes |
| Compatible avec | 60012, 60013, 60015, 60016, 60017 |
| Poids | 1,60Kg |
| Dimensions (LxIxH) | 420x70x270mm |



PIÈCES DE RECHANGE

60032C

266,00€

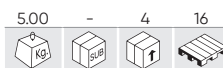

PISTOLET JOINT SANS FILS AVEC MALLETTE

| | |
|---------------------------|-----------------------------------|
| Tension | 20V |
| Force de poussée maximale | 2500N |
| Vitesse d'avance | 0,5-8mm/s (30-480mm/min) |
| Capacité de la cartouche | 300ml |
| Vitesse | Ajustable/Adjustable |
| Inclut | 60032, 60013, 60016 |
| LED | Si/Yes |
| Compatible avec | 60012, 60013, 60015, 60016, 60017 |
| Poids | 4,96Kg |
| Dimensions (LxIxH) | 500x130x400mm |



PIÈCES DE RECHANGE

53525

12,00€

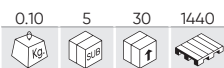

PINCE POUR LES DISPOSITIFS D'OUVERTURE DU CAPOT ET DU COFFRE



| | |
|--------------------|-------------|
| Diamètre | 10mm |
| Poids | 0,10Kg |
| Dimensions (LxIxH) | 140x90x30mm |

53655

12,00€

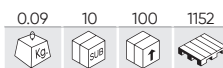

ARRACHEUR POUR POIGNÉES DE PORTE VAG



| | |
|--------------------|-------------|
| Marques | VAG |
| Poids | 0,09Kg |
| Dimensions (LxIxH) | 340x70x40mm |

54246

104,00€

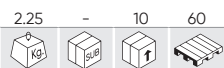

BALANCE DE PRÉCISION DE 5 KG



| | |
|---|---------------|
| Capacité | 5Kg |
| Précision | 0,1g |
| Mesure de la tension en courant alternatif (AC) | 220V |
| Mesure de la tension en courant continu (DC) | 6V |
| Température de travail | 0-40°C |
| Humidité relative | 10%<RH<85% |
| Poids | 2,25Kg |
| Dimensions (LxlxH) | 280x115x285mm |

54247

99,00€



BALANCE DE PRÉCISION DE 2 KG



| | |
|---|---------------|
| Capacité | 2Kg |
| Précision | 0,1g |
| Mesure de la tension en courant alternatif (AC) | 220V |
| Mesure de la tension en courant continu (DC) | 6V |
| Température de travail | 0-40°C |
| Humidité relative | 10%<RH<85% |
| Poids | 2,25Kg |
| Dimensions (LxlxH) | 352x136x240mm |

53230

20,50€

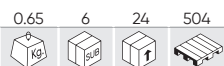

JEU D'OUTILS POUR OUVRIR LES VOITURES

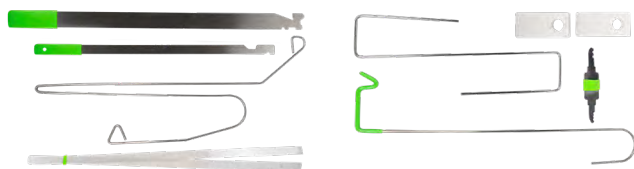

- x2 Ruban d'ouverture des poignées
- x2 Cale en nylon avec trou central
- x1 Crochet rigide en forme de "s"
- x1 Crochet coulissant pour déverrouillage sécurisé
- x1 Levier de déverrouillage large 610mm
- x1 Levier de verrouillage étroit 558mm
- x1 Clé type grenaille pour serrures
- x1 Crochet spécial

52077

29,50€

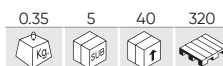

JEU DE 4 COUSSINS GONFLABLES



- x1 Coussins 16x16cm
- x1 Coussins 32x12cm
- x1 Coussins 19x6cm
- x1 Coussins 18x4,5cm
- x1 Pompe manuel

53486

30,50€

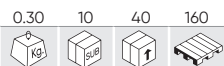

MIROIR D'INSPECTION DES FOSSES

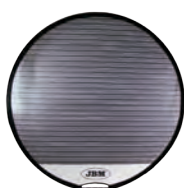

| | |
|--------------------|--------------|
| Diamètre | 800mm |
| Poids | 0,30Kg |
| Dimensions (LxlxH) | 320x300x40mm |

15375

28,00€

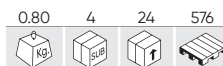

RÉCIPIENT AVEC LIQUIDE POUR RÉF. 53673



| | |
|--------------------|-------------|
| Capacité | 600ml |
| Poids | 0,80Kg |
| Dimensions (LxlxH) | 75x75x190mm |

53673

80,00€

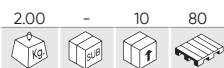

KIT DE RESTAURATION DES PHARES

| | |
|----|--|
| x6 | KIT DE 6 PAPIERS ÉMERIS POUR RÉF. 53673 |
| x1 | ADAPTATEUR CA-CC POUR RÉF. 53673 |
| x1 | ADAPTATEUR 12V POUR RÉF. 53673 |
| x1 | TASSE D'ÉVAPORATION POUR RÉF. 53673 |
| x1 | COUVERCLE COURBÉ AVEC BAGUE D'ÉTANCHÉITÉ EN CAOUTCHOUC POUR RÉF. 53673 |
| x1 | COUVERCLE PLAT AVEC BAGUE D'ÉTANCHÉITÉ EN CAOUTCHOUC POUR RÉF. 53673 |
| x1 | ENTONNOIR POUR RÉF. 53673 |
| x1 | PLAQUE DE RODAGE POUR RÉF. 53673 |
| x1 | PAPIER TEXTURÉ POUR RÉF. 53673 |
| x1 | RÉCIPIENT AVEC LIQUIDE POUR RÉF. 53673 |



KIT DE 10 ÉLÉMENTS DE PAPIER ABRASIF

| REF. | GRAIN | kg | L | € | REF. | GRAIN | kg | L | € |
|-------|-------|------|----|-------|-------|-------|------|----|-------|
| 14710 | 180 | 0.25 | 10 | 3,90€ | 14713 | 600 | 0.15 | 10 | 4,25€ |
| 14711 | 280 | 0.20 | 10 | 4,00€ | 14714 | 800 | 0.15 | 10 | 4,50€ |
| 14712 | 360 | 0.20 | 10 | 4,00€ | 14715 | 1200 | 0.10 | 10 | 4,75€ |



TUTORIEL VIDÉO



PIÈCES DE RECHANGE

52740

690,00€

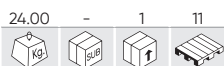

REGLOPHARES AVEC LUXOMÈTRE 152CM



| | |
|----------------------------|----------------|
| Hauteur de levage minimale | 230mm |
| Hauteur de levage maximale | 1350mm |
| Mesure | LUX Digital |
| Compatible avec | Halogeno/Xenón |
| Poids | 24,00Kg |
| Dimensions (LxIxH) | 520x280x1520mm |

52836

1.100,00€



PHARE D'ALIGNEMENT DOUBLE LASER



TUTORIEL VIDÉO



| | |
|----------------------------|---|
| Hauteur de levage minimale | 230mm |
| Hauteur de levage maximale | 1350mm |
| Mesure | Láser/Laser, LUX Digital |
| Compatible avec | Cualquier tipo de faro/Any type of car lighthouse |
| Poids | 24,85Kg |
| Dimensions (LxIxH) | 520x270x1560mm |

53626

18,00€

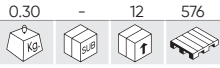

KIT DE RESTAURATION DE PHARES

- x2 Roues d'éméri P800
- x2 Roues d'éméri P1200
- x2 Roues d'éméri P2000
- x2 3,0ml de liquide de protection UV
- x2 Adaptateur (3/8" et 1/4")
- x1 85g de pâte à polir
- x1 Ruban adhésif
- x1 Roue à polir en laine
- x1 Disque éponge blanc



PRÉSENTAIRE DE 12 UNITÉS

53729

20,50€

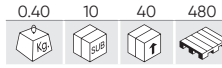

ENSEMBLE D'OUTILS DE RÉGLAGE LES PHARES

- | | | |
|--|----|----------|
| | x1 | H6 |
| | x1 | 300mm H7 |
| | x1 | T25 |



VENTOUSE

52262

7,50€

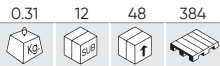

- | | |
|----------|---------|
| Pièces | 1 |
| Diamètre | 115mm |
| Capacité | 40,00Kg |

52263

13,50€

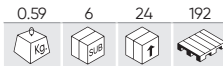

- | | |
|----------|---------|
| Pièces | 1 |
| Diamètre | 115mm |
| Capacité | 70,00Kg |

52264

21,50€

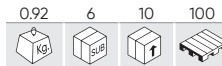

- | | |
|----------|----------|
| Pièces | 1 |
| Diamètre | 115mm |
| Capacité | 100,00Kg |

52265

30,50€

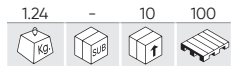

- | | |
|----------|----------|
| Pièces | 1 |
| Diamètre | 115mm |
| Capacité | 120,00Kg |

52295

7,00€

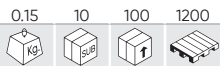

- | | |
|----------|--------|
| Pièces | 2 |
| Diamètre | 60mm |
| Capacité | 5,00Kg |

52589

13,00€

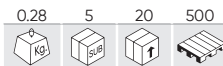

- | | |
|----------|--------|
| Pièces | 1 |
| Diamètre | 70mm |
| Capacité | 8,00Kg |

52765

21,70€

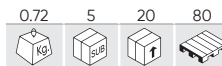

- | | |
|----------|---------|
| Pièces | 1 |
| Diamètre | 120mm |
| Capacité | 80,00Kg |

52998

48,00€

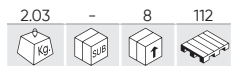

- | | |
|----------|---------|
| Pièces | 3 |
| Diamètre | 120mm |
| Capacité | 80,00Kg |

53232

39,50€

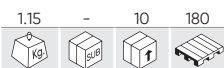

OUTILS POUR REMPLACEMENT DE VITRES

- x1 EXTRACTEUR DE MOULURES
- x1 LEVIER POUR EXTRAIRE LA GOMME
- x1 CROCHET EXTRACTEUR
- x1 1.8M DE CÂBLE DE COUPE
- x2 POIGNÉES POUR LE CÂBLE DE COUPE
- x1 PASSE-CÂBLES



| REF. | DESCRIPTION | | | | | € |
|-------|-----------------------------------|------|----|----|------|--------|
| 13813 | CÂBLE POUR EXTRACTION PARE-BRISÉS | 0.10 | 10 | 60 | 1200 | 7,00€ |
| 13814 | OUTILS POUR EXTRACTION DE VITRES | 0.20 | 10 | 60 | 1080 | 11,00€ |

55012

680,00€



NEW

KIT D'OUTILS DE REMPLACEMENT DE PARE-BRISÉ AVEC MALLETTE

- x1 ANCRE DE LA LIGNE DE COUPE
- x1 POULIE DE LA LIGNE DE COUPE
- x1 ENROULEUR DE LA LIGNE DE COUPE
- x1 CÂBLE EN FIBRE SYNTHÉTIQUE L:100M
- x1 OUTIL DE PERÇAGE
- x1 BARRE D'INSTALLATION DU CISEAU
- x1 OUTIL CROCHET TYPE PIQUE 90°
- x1 CLÉ À CLIQUET AVEC DOUILLE 1/4"
- x1 PLANCHE DE PROTECTION



PIÈCES DE RECHANGE

52321

8,80€

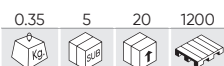

SANGLE DE FIXATION AVEC TENSEUR 5M X 25MM



| | |
|--------------------|--------------|
| Pièces | 2 |
| Longueur | 5m |
| Capacité | 800Kg |
| Poids | 0,35Kg |
| Dimensions (LxlxH) | 125x115x30mm |

52327

12,00€

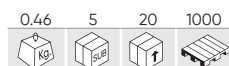

SANGLE DE FIXATION AVEC TENSEUR 8M X 25MM



| | |
|--------------------|--------------|
| Pièces | 2 |
| Longueur | 8m |
| Capacité | 800Kg |
| Poids | 0,46Kg |
| Dimensions (LxlxH) | 150x140x40mm |

50577

12,60€

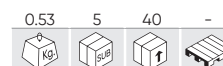

PINCE ÉTAU



| | |
|----------|--------|
| Longueur | 280mm |
| Poids | 0,53Kg |

52385

268,00€

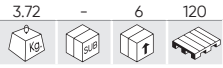

SET DE 6 PINCES À ETAU



52982

55,00€

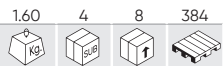

JEU DE 3 PINCES ETAUX EXTRA LONGUES



| | |
|----------|-------|
| Angle | 90° |
| Longueur | 340mm |



| | |
|----------|-------|
| Angle | 45° |
| Longueur | 360mm |



| | |
|----------|-------|
| Angle | 0° |
| Longueur | 370mm |

53675

53,00€

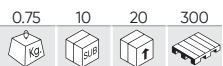

PINCE À VERROUILLAGE ET MÂCHOIRES DROITES



PRÉSENTOIR DE 10 UNITÉS

53676

47,00€

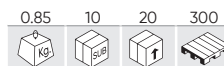

PINCE À VERROUILLAGE ET MÂCHOIRES COURBÉES



PRÉSENTOIR DE 10 UNITÉS

53677

59,00€

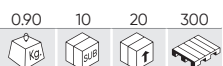

PINCE À VERROUILLAGE, MÂCHOIRES COURBÉES ET SUPPORT ROTATIF



PRÉSENTOIR DE 10 UNITÉS

53678

55,00€

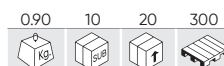





PINCE À VERROUILLAGE ET MÂCHOIRES COURBÉES LONGUES



PRÉSENTOIR DE 10 UNITÉS

PINCE À VERROUILLAGE ET MÂCHOIRES

| REF. | DESCRIPTION | mm | MATÉRIEL |  | T |  |  |  |  | € |
|-------|---|-------|----------|---|----|---|---|---|---|--------|
| 52390 | PINCE SPECIAL SOUDURE | 250mm | CrMo | - | - | 0.50 | 5 | 40 | 640 | 37,50€ |
| 52474 | PINCE DE TIRAGE 5T | 190mm | Acier | 0-20mm | 5T | 3.49 | - | 5 | 1500 | 69,00€ |
| 52475 | PINCE DE TIRAGE PLATE 3T | 170mm | Acier | 0-25mm | 3T | 3.60 | - | 10 | 1500 | 62,00€ |
| 52476 | PINCE DE TIRAGE CARRÉ 5T | 220mm | Acier | 0-25mm | 5T | 3.10 | - | 10 | 1500 | 50,00€ |
| 52477 | PINCE DE TIRAGE 2T | 200mm | Acier | 0-60mm | 2T | 2.65 | - | 10 | 1500 | 76,50€ |
| 52478 | PINCE DE TIRAGE 90° 5T | 170mm | Acier | 0-20mm | 5T | 2.90 | - | 10 | 1500 | 49,00€ |
| 52479 | PINCE DE TIRAGE PLATE 90° 3T | 155mm | Acier | 0-20mm | 3T | 1.18 | - | 30 | 1500 | 24,70€ |
| 52480 | MINI PINCE DE TIRAGE CARRÉ 90° 3T | 210mm | Acier | 0-25mm | 3T | 2.00 | - | 10 | 1500 | 44,00€ |
| 52481 | PINCE DE TIRAGE CARRÉ 3T | 220mm | Acier | 0-20mm | 3T | 2.05 | - | 10 | 1500 | 52,00€ |
| 52482 | PINCE DE TIRAGE PLATE ANGLE 45° 5T | 210mm | Acier | 0-10mm | 5T | 2.13 | - | 12 | 1500 | 44,00€ |
| 52483 | PINCE DE TIRAGE MINI 5T | 210mm | Acier | 0-10mm | 5T | 2.02 | - | 12 | 1500 | 41,00€ |
| 52484 | UNIÓN CHÂÎNES 3T | 280mm | Acier | 0-110mm | 3T | 1.19 | - | 11 | 1500 | 70,00€ |
| 52485 | UNIÓN CROCHETS 4T | 270mm | Acier | 0-90mm | 4T | 1.17 | - | 30 | 1000 | 54,00€ |
| 52486 | UNIÓN CHÂÎNE CROCHET 3T | 280mm | Acier | 0-110mm | 3T | 1.21 | - | 11 | 1500 | 66,00€ |
| 52487 | PINCE DE TIRAGE 5T | 220mm | Acier | 0-20mm | 5T | 2.27 | - | 7 | 1000 | 63,00€ |
| 52502 | PINCE ÉTAU POUR SOUDURE | 280mm | CrMo | 0-110mm | - | 0.84 | 10 | 30 | 540 | 33,50€ |
| 52503 | PINCE ÉTAU POUR SOUDURE MACHOIRES AMOVIBLES | 280mm | CrMo | 0-105mm | - | 0.85 | - | 30 | 540 | 35,00€ |
| 52504 | PINCE DE TIRAGE À DOUBLE GRIFFE | 225mm | CrMo | 0-50mm | - | 1.14 | - | 30 | 480 | 27,60€ |
| 52505 | PINCE ÉTAU BLOCAGE | 170mm | CrMo | 0-40mm | - | 0.27 | 36 | 72 | 2160 | 22,50€ |
| 52506 | PINCE ÉTAU MACHOIRES AMOVIBLES | 170mm | CrMo | 0-50mm | - | 0.28 | 36 | 72 | 2160 | 16,00€ |
| 52507 | PINCE ÉTAU POUR U ET CORNIERES | 250mm | CrMo | 0-80mm | - | 0.77 | 5 | 30 | 420 | 32,50€ |
| 52511 | PINCE ÉTAU POUR SOUDURE 18" | 440mm | CrMo | 0-225mm | - | 1.31 | - | 20 | 280 | 44,50€ |
| 52512 | PINCE ÉTAU POUR SOUDURE MACHOIRES AMOVIBLES | 450mm | CrMo | 0-155mm | - | 1.31 | - | 20 | 280 | 53,00€ |

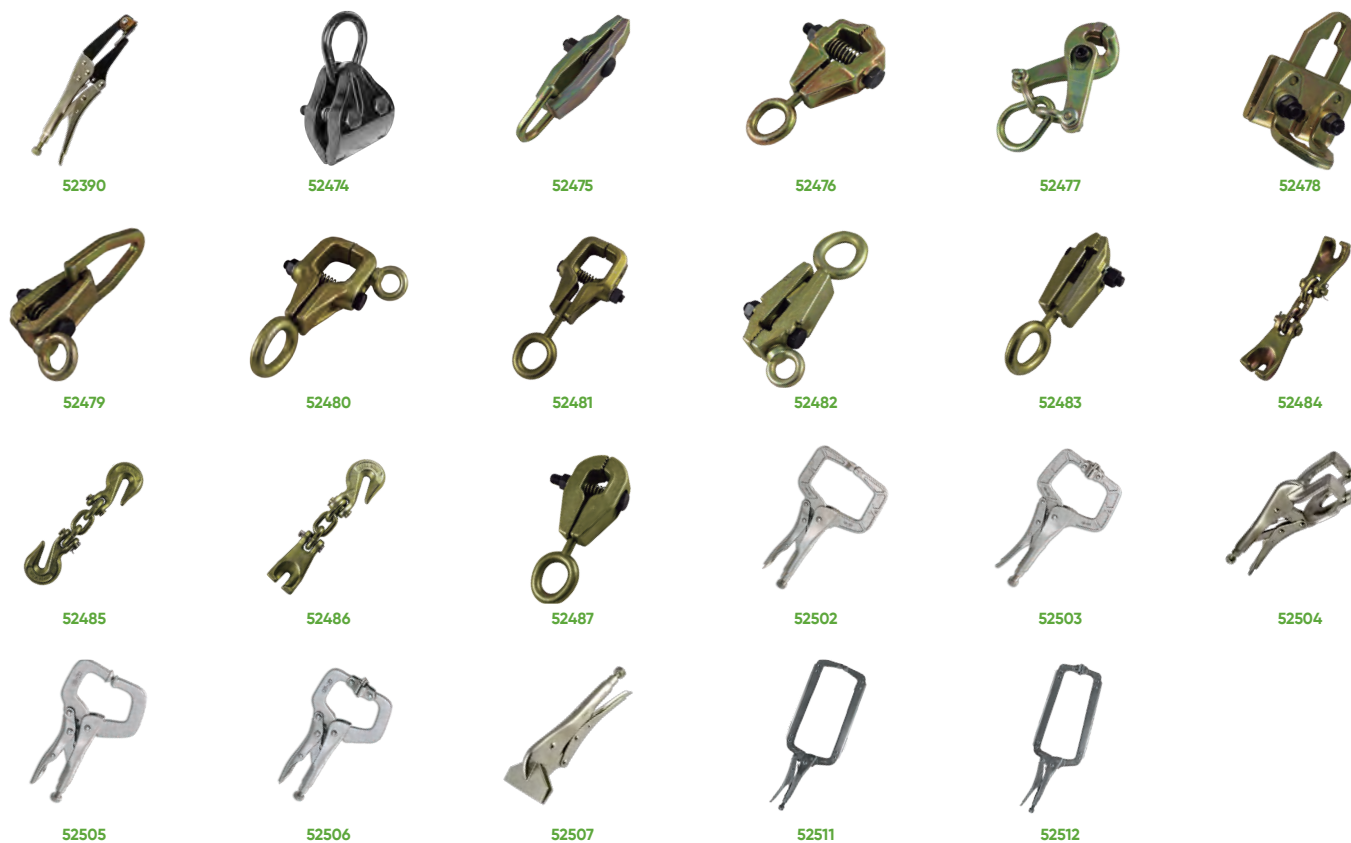

53983

215,00€

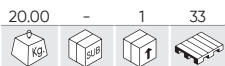

PORTE-PIÈCES - PARE-BRISE ET COQUE



| | |
|--------------------|----------------|
| Capacité | 150Kg |
| Dimensions pliées | 1200x120x210mm |
| Poids | 19,40Kg |
| Dimensions (LxlxH) | 1200x700x635mm |

53124

287,00€



CHEVALET UNIVERSEL TÉLESCOPIQUE



| | |
|--------------------|-----------------|
| Capacité | 100Kg |
| Dimensions pliées | 25x860x840mm |
| Poids | 21,10Kg |
| Dimensions (LxlxH) | 1380x860x1300mm |

53125

477,00€

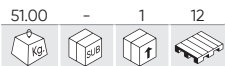

CHARIOT SPÉCIAL CARROSSERIE

| | |
|--------------------|----------------|
| Capacité | 150Kg |
| Poids | 51,00Kg |
| Dimensions (LxlxH) | 900x610x1980mm |



50923

454,00€

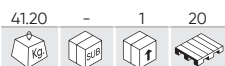

CHARIOT CARROSSERIE 340KG



PIÈCES DE RECHANGE

| | |
|--------------------|----------------|
| Capacité | 340Kg |
| Ouverture | 0-1100mm |
| Poids | 41,20Kg |
| Dimensions (LxlxH) | 1340x250x240mm |

50839

198,00€



CHARIOT HYDRAULIQUE 680KG



PIÈCES DE RECHANGE

| | |
|--------------------|---------------|
| Capacité | 680Kg |
| Ouverture | 345-660mm |
| Poids | 19,20Kg |
| Dimensions (LxlxH) | 680x625x230mm |

53079

89,00€

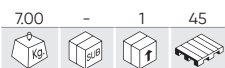

CHEVALET EN "X"



| | |
|--------------------|----------------|
| Capacité | 100Kg |
| Dimensions pliées | 660x1140x300mm |
| Poids | 6,77Kg |
| Dimensions (LxlxH) | 600x680x870mm |

53080

99,00€

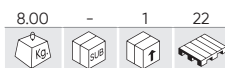

CHEVALET POUR PARE-BRIS



| | |
|--------------------|----------------|
| Capacité | 70Kg |
| Dimensions pliées | 1130x285x990mm |
| Poids | 7,87Kg |
| Dimensions (LxlxH) | 1130x610x990mm |

52749

79,00€

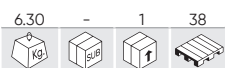

CHEVALET PLIABLE POUR CARROSSIER



PIÈCES DE RECHANGE

| | |
|--------------------|-----------------|
| Capacité | 220Kg |
| Dimensions pliées | 1030x905x500mm |
| Poids | 6,25Kg |
| Dimensions (LxlxH) | 1030x390x1000mm |

53736

99,00€



CHEVALET SUPPORT PARE-CHOCS



| | |
|--------------------|----------------|
| Capacité | 25Kg |
| Dimensions pliées | 600x310x1230mm |
| Poids | 8,10Kg |
| Dimensions (LxlxH) | 600x750x1060mm |

53685

310,00€

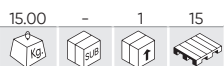

SUPPORT DE PARE-CHOCS

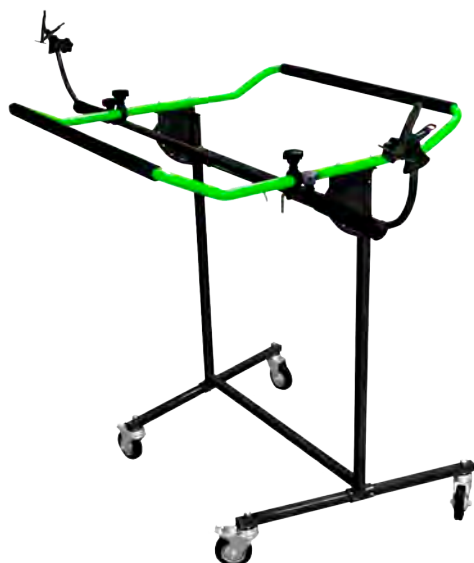

| | |
|--------------------|-----------------|
| Capacité | 25Kg |
| Dimensions pliées | 960x865x95mm |
| Poids | 14,50Kg |
| Dimensions (LxlxH) | 762x1118x1346mm |

54579

229,00€



SUPPORT DE RANGEMENT DE PARE-CHOCS MOBILE



| | |
|--------------------|------------------|
| Capacité | 60Kg |
| Capacité en barres | 15Kg |
| Poids | 21,00Kg |
| Dimensions (LxlxH) | 1200x1200x2150mm |

53134

145,00€

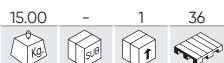

SUPPORT ÉLÉMENTS POUR CARROSSERIE

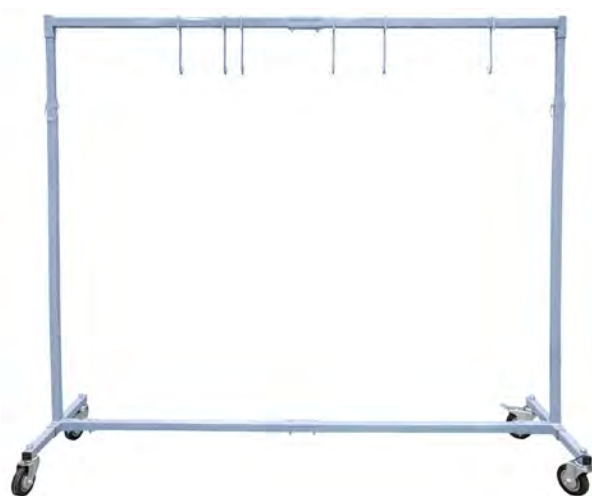

| | |
|----------------------------|-----------------|
| Capacité | 150Kg |
| Hauteur de levage minimale | 1270mm |
| Hauteur maximale | 2030mm |
| Contient | 6 Ganchos/Hooks |
| Poids | 14,70Kg |
| Dimensions (LxlxH) | 1770x500x2030mm |

53126

243,00€



SUPPORT BASCULANT POUR ÉLÉMENT DE CARROSSERIE



PIÈCES DE RECHANGE

| | |
|--------------------|-----------------------------------|
| Capacité | 50Kg |
| Contient | 6 Brazos de sujeción/Support arms |
| Poids | 19,70Kg |
| Dimensions (LxlxH) | 1220x250x165mm |

54959 268,00€

20.20 - 1 16 **NEW**

SUPPORT MOBILE POUR PEINTURE DE JANTES DE ROUE



| | |
|---------------------|----------------|
| Matériau | GS |
| Hauteur | 1100 - 1420mm |
| Renouvelable | 360° |
| Plateaux | 2 |
| Diamètre de la roue | 15" - 22" |
| Dimensions (LxlxH) | 900x670x1100mm |

54960 159,50€

11.10 - 1 33 **NEW**

SUPPORT UNIVERSEL POUR PANNEAUX ET PARE-CHOCS



| | |
|--------------------|------------------|
| Matériau | GS |
| Renouvelable | 90° |
| Charge maximale | 100Kg |
| Dimensions (LxlxH) | 1220x1330x1870mm |
| Poids | 10,50Kg |

54961 20,00€

1.10 1 20 240 **NEW**

SUPPORT DE JANTE

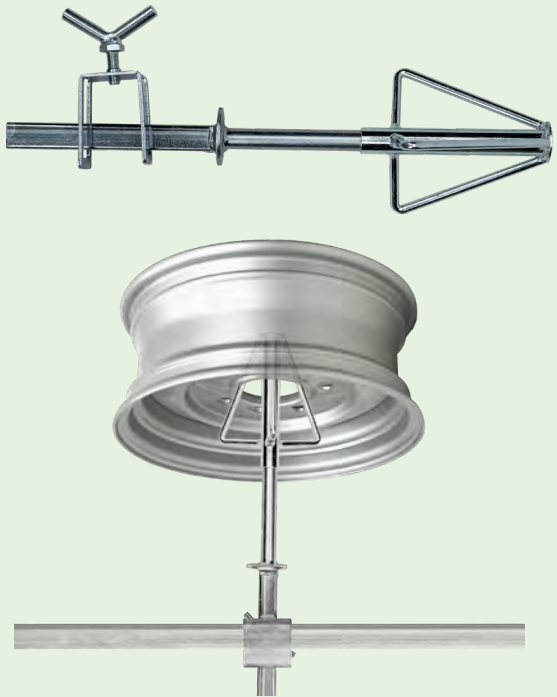

| | |
|--------------------|---------------|
| Poids | 1,15Kg |
| Dimensions (LxlxH) | 130x100x380mm |

54962 430,50€

40.25 - 1 14 **NEW**

CHARIOT POUR PIÈCES AVEC SUPPORT POUR PANNEAUX



| | |
|--------------------|------------------|
| Charge maximale | 120Kg |
| Capacité en barres | 40Kg |
| Poids | 40,00Kg |
| Dimensions (LxlxH) | 1220x1330x1900mm |

52230

398,00€

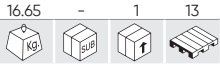
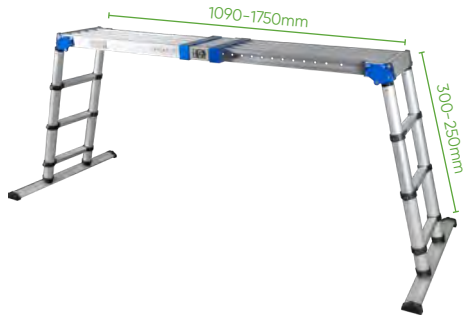

PLATE-FORME DE TRAVAIL TÉLESCOPIQUE



PIÈCES DE RECHANGE



| | |
|--------------------------------------|----------------|
| Capacité | 150Kg |
| Dimensions pliées | 300x1090x900mm |
| Longueur minimale | 1090mm |
| Longueur maximale | 1750mm |
| Hauteur minimale | 550mm |
| Hauteur maximale | 930mm |
| Matériau | Al |
| Conformité à la directive européenne | EN131 |
| Poids | 16,65Kg |
| Dimensions (LxlxH) | 300x1750x900mm |

50656

290,00€



JEU DE 2 PLATE-FORME DE TRAVAIL EN ALUMINIUM



PIÈCES DE RECHANGE



| | |
|--|----------------|
| Capacité | 100Kg |
| Dimensions de la grande plateforme (LxlxH) | 1300x300x550mm |
| Dimensions de la grande plateforme pliée (LxlxH) | 1300x300x140mm |
| Dimensions de la petite plateforme (LxlxH) | 1000x300x300mm |
| Dimensions de la petite plateforme pliée (LxlxH) | 1000x300x140mm |
| Matériau | Al |
| Contient | 11897, 15552 |
| Conformité à la directive européenne | EN131 |
| Poids | 10,45Kg |

50913

229,00€

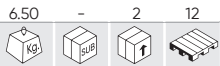
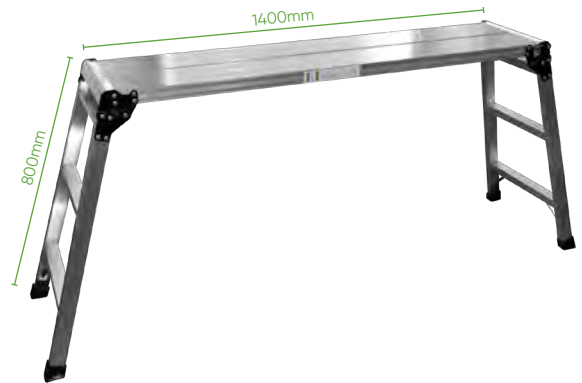

PLATE-FORME DE TRAVAIL EN ALUMINIUM

| | |
|--------------------------------------|----------------|
| Capacité | 100Kg |
| Matériau | Al |
| Conformité à la directive européenne | EN131 |
| Dimensions (LxlxH) | 1400x300x800mm |
| Poids | 6,50Kg |
| Dimensions pliées | 1400x300x14mm |



54789

34,00€

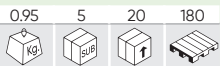

NEW

PROTECTION AVANT POUR VOITURE



| | |
|-----------------------|---------------------|
| Matériau | Poliéster/Polyester |
| Poids | 0,95Kg |
| Dimensions pliées | 330x50x210mm |
| Dimensions assemblées | 4050x725mm |

51622

27,00€



PROTECTEUR MAGNÉTIQUE COUVRANT LES ANTENNES ET LES FRONTS



| | |
|------------------|---------------------|
| Type | Imantado/Magnetized |
| Matériau | PVC |
| Poids | 0,45Kg |
| Dimensions (LxH) | 1300x640mm |

53922

35,00€

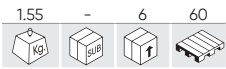

PORTE-ROULEAU PAPIER POUR MUR



| | |
|--------------------|----------------------------------|
| Matériau | Acero inoxidable/Stainless steel |
| Hauteur minimale | 480mm |
| Hauteur maximale | 690mm |
| Rouleau de papier | 380mm |
| Dimensions pliées | 450x270x480mm |
| Poids | 1,55Kg |
| Dimensions (LxIxH) | 4550x210x690mm |

PAPIER NON INCLUS

53921

39,00€



PORTE-ROULEAU PAPIER



| | |
|--------------------|----------------------------------|
| Matériau | Acero inoxidable/Stainless steel |
| Hauteur | 975mm |
| Rouleau de papier | 380mm |
| Poids | 1,85Kg |
| Dimensions (LxIxH) | 450x345x975mm |

PAPIER NON INCLUS

MANCHE TÉLESCOPIQUE

| REF. | MIN. | MAX. | KG | BOX | BOX | BOX | € |
|-------|--------|-------|------|-----|-----|-----|--------|
| 52497 | 1200mm | 530mm | 0.29 | 6 | 48 | 480 | 27,00€ |
| 53196 | 1600mm | 710mm | 0.37 | 6 | 48 | 384 | 33,00€ |



53221

5,00€



JEU DE 3 LAVETTES MICROFIBRE



| | |
|----------|-------------|
| Pièces | 3 |
| Couleur | Verde/Green |
| Matériau | PL |
| Mesure | 360x360mm |

55066

319,50€



NEW

PONCEUSE ÉLECTRIQUE 150 MM 400W



| | |
|--------------------|---------------|
| Tension | 220V |
| Puissance | 400W |
| Fréquence | 50Hz |
| Vitesse nominale | 4000-10000RPM |
| Diamètre du disque | 150mm |
| Orbite de ponçage | 5mm |
| Longueur du câble | 3m |
| Poids | 1,10Kg |
| Dimensions (LxIxH) | 310x150x110mm |

54556

74,00€

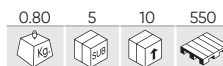

PONCEUSE À BANDE 3/8"



PIÈCES DE RECHANGE



| | |
|---------------------------|--------------|
| Entrée d'air | 1/4" |
| Vitesse nominale | 18000RPM |
| Consommation d'air réelle | 113L/min |
| Pression de travail | 6,2BAR |
| Intensité du son | 89dB |
| Orbite de ponçage | 10x330mm |
| Orbite de ponçage | 60x80x120mm |
| Angle | 90° |
| Poids | 0,75Kg |
| Dimensions (LxIxH) | 290x100x50mm |

55025

120,00€



NEW

PISTOLET DE SÉCHAGE ÉLECTRIQUE



| | |
|-----------------------------|---------------|
| Tension | 220V ~ 50Hz |
| Puissance | 1350W |
| Longueur du câble | 5M |
| Débit d'air | 93 CFM |
| Accélération d'air maximale | 22000ft/min |
| Poids | 1,80Kg |
| Dimensions (LxlxH) | 270x140x280mm |

60071

140,00€



NEW

SOUFFLEUR D'AIR À BATTERIE POUR LE SÉCHAGE DES VÉHICULES



| | |
|------------------------|--------------------|
| Tension | 20V |
| Flux d'air | 55m/s |
| RPM (tours par minute) | 22500-35000 |
| Débit d'air | 10,4CFM (294L/min) |
| Diamètre | 2,5" |
| Compatible avec | 60013, 60015 |
| Poids | 0,76Kg |
| Dimensions (LxlxH) | 168x116x255mm |

54771

279,00€



ASPIRATEUR POUR TISSUS D'AMEUBLEMENT 20 L (SEC+HUMIDE)



PIÈCES DE RECHANGE

| | |
|---------------------------------|---------------|
| Tension | 230V |
| Puissance | 1200W |
| Fréquence | 50Hz |
| Capacité | 20L |
| Litres d'aspiration par seconde | 26L/s |
| Intensité du son | 82dB |
| Puissance d'aspiration | 17-18KPa |
| Protection IP | 4 |
| Dimensions (LxlxH) | 390x340x460mm |
| Poids | 7,60Kg |

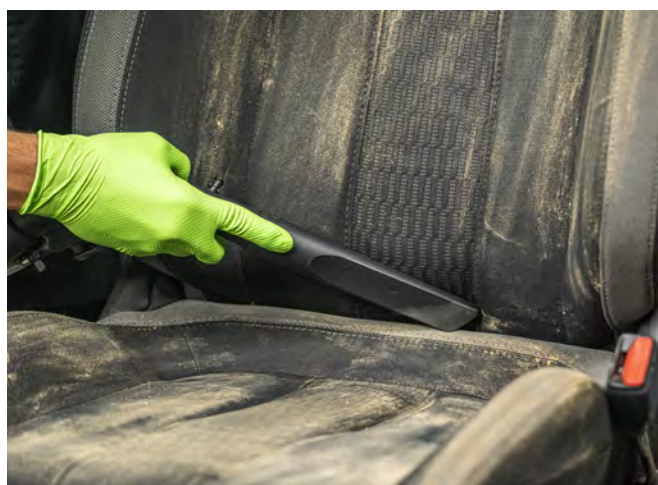

53947

149,00€

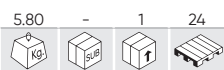

LAVEUSE HAUTE PRESSION 1400W



PIÈCES DE RECHANGE



| | |
|---------------------------------|---------------|
| Tension | 230V |
| Puissance | 1400W |
| Fréquence | 50Hz |
| Pression de travail | 70-105BAR |
| Débit maximal de fonctionnement | 5,5-6,8L/min |
| Température de travail | 50°C |
| Protection IP | IPX5 |
| Poids | 5,80Kg |
| Dimensions (LxlxH) | 280x255x440mm |

53948

324,00€

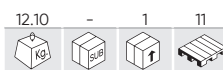

LAVEUSE HAUTE PRESSION 2400W



PIÈCES DE RECHANGE



| | |
|---------------------------------|---------------|
| Tension | 230V |
| Puissance | 2400W |
| Fréquence | 50Hz |
| Pression de travail | 120-180BAR |
| Débit maximal de fonctionnement | 5,5-8L/min |
| Température de travail | 50°C |
| Protection IP | IPX5 |
| Poids | 12,10Kg |
| Dimensions (LxlxH) | 440x345x505mm |



54805

478,00€



NEW

ENSEMBLE DE PLAFONNIERS LED HEXAGONAUX

| | |
|--------------------------------|-------------------------------|
| Luminosité | 83640Lm |
| Puissance | 615W |
| Efficacité | 110-120Lm/W |
| Tension | 185-240V |
| Type de LED | 2835 |
| Nombre de LED | 12 |
| Température de couleur des LED | 6500k |
| Matériau | Al + PC |
| Longueur du câble | 1,5m Enchufe europeo/ EU Plug |
| Protection IP | IP45 |
| Poids | 7,50Kg |
| Dimensions (LxlxH) | 2435x42x4845mm |

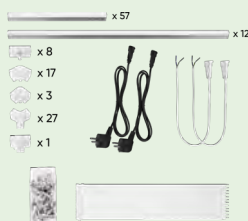

PIÈCES DE RECHANGE





54346

12,80€

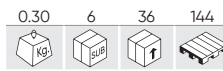

KIT DE 3 BROSSES DE NETOYAGE POUR PERCEUSE



| | |
|--------------------|---------------|
| Pièces | 3 |
| Taille de l'essieu | 1/4" |
| Diamètre | 50, 88, 100mm |

54912

7,90€

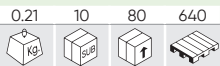

NEW

KIT DE LAVAGE DE VOITURE PROFESSIONNEL 4 EN 1 POUR INTÉRIEUR ET EXTÉRIEUR



| | |
|--------------------|----------------------|
| Pièces | 4 |
| Matériau | PP |
| Longueur de brosse | 220, 225, 230, 240mm |
| Poids | 0,21Kg |

54895

16,80€

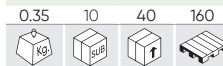

NEW

KIT DE DETAILING AUTO AVEC 7 ACCESSOIRES ESSENTIELS



| | |
|--------------------|----------------------|
| Pièces | 7 |
| Matériau | PP |
| Longueur de brosse | 220, 225, 230, 240mm |
| Diamètre de tête | 50, 88, 100mm |
| Taille de l'essieu | 1/4" |
| Poids | 0,35Kg |

50844

65,00€

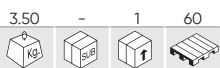

TABOURET FIXE



| | |
|--------------------|------------------|
| Matériau | Acero/Steel, PVC |
| Capacité | 115Kg |
| Hauteur | 380mm |
| Poids | 3,50Kg |
| Dimensions (LxlxH) | 360x375x380mm |

54682

54,00€

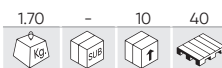

PLATE-FORME MOBILE D'AGENOUILLEMENT



| | |
|--------------------|-----------------------------|
| Matériau | Polipropileno/Polypropylene |
| Charge maximale | 100Kg |
| Poids | 1,7Kg |
| Dimensions (LxlxH) | 500x255x85mm |

53191

14,80€



TAPIS DE SOL INDIVIDUEL



| | |
|--------------------|---------------------|
| Matériau | Espuma EVA/EVA foam |
| Poids | 0,15Kg |
| Dimensions (LxlxH) | 480x180x320mm |