

53224

142,00€

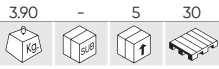

DENT TOOL KIT



SPARE PARTS AVAILABLE



x5	BAG OF 5 PCS BLUE PAD (REF.53224)
x5	BAG OF 4 PCS YELLOW PAD (REF.53224)
x10	BAG OF 10 PCS RED PAD (REF.53224)
x5	BAG OF 5 GLUE BAR (REF.53224)

52876

182,00€



SET OF 7 RUBBERISED DOLLIES



SPARE PARTS AVAILABLE



x1	FLAT FACE & OVAL FACE TAS
x1	RAIL TAS
x1	OVAL FACE TAS
x1	HANDLE WITH WEDGE TAS
x1	TAS IN COMMA
x1	TAS HEELED
x1	TAS IN COMMA WITH WEDGE

51131

61,00€

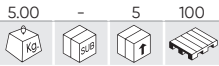

SET OF 7 PANEL BEATING TOOLS



SPARE PARTS AVAILABLE



x1	BUMPING HAMMER
x1	REVERSE CURVE HAMMER
x1	PICK AND FINISH HAMMER
x1	UTILITY DOLLY
x1	SHRINKING DOLLY
x1	DOUBLE END DOLLY
x1	CURVE DOLLY

53545

38,50€

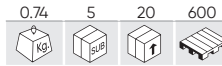

SET OF 5 3/8" EXTRA LONG HEXAGONAL SOCKETS



x1	8mm
x1	10mm
x1	3/8" 120mmL 12mm
x1	13mm
x1	14mm



55116

125,50€

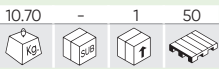

NEW

BODYWORK DENT REPAIR SET 11 PCS

Pieces	11
Weight	10,50Kg
Dimensions (LxWxH)	770x100x215mm



51832 18,00€

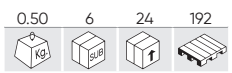

SET OF 4 NYLON LEVERS



x4	19x273mm
	22x273mm
	25x273mm
	36x273mm

50903 30,80€

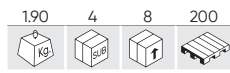

SET OF 5 METAL LEVERS WITH HANDLE



x5	180mm
	280mm
	380mm
	430mm
	600mm

52026 34,50€

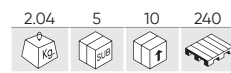

SET OF 2 METAL LARGE LEVERS WITH HANDLE



x2	900mm
	900mm

52851 9,65€



SET OF 2 LEVERS



x2	7x220mm
	8.5x245mm

53110 29,50€



SET OF 6 LEVERS



x1	4.5x240mm	x1	4.5x490mm
	8.5x240mm		8.5x490mm
	10.3x24mm		10.3x490mm

51360 8,20€

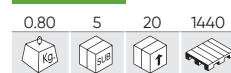

51361 12,00€

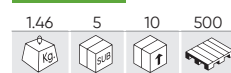

WRECKING BAR



x1	51360	x1	18" x 5/8
	51361		24" x 3/4

50901 16,00€

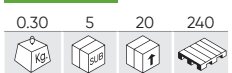

SET OF 5 NYLON LEVERS



x5	60x160, 63x175, 30x200, 20x180, 20x215mm
----	--

52788 39,00€



SET OF 27 NYLON LEVERS



52977

141,00€

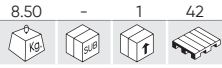

SET OF 4 EXTRA LONG PRY BARS



Pieces	4
Measures	0° 900x16mm, 30°900x16mm, 75°600x16mm, 90°600x16mm
Weight	8,50Kg
Dimensions (LxWxH)	1005x260x80mm

52540

221,00€



PNEUMATIC SUCTION CUP DENT PULLER



Pieces	5
Resistance	7,6BAR
Diameter	75, 100, 125mm
Lenght	620mm
Weight	4,36Kg
Dimensions (LxWxH)	620x250x100mm

54017

12,00€

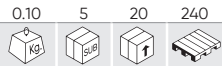

SILICONE CAULKING TOOL

Contains	Almohadillas de silicona/Silicone pads
Weight	0,10Kg
Dimensions (LxWxH)	270x44x95mm

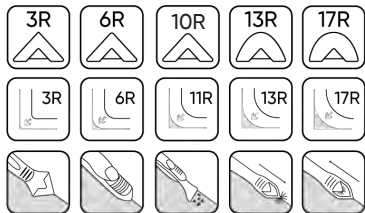

52533

10,00€

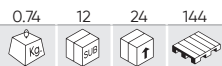

SILICONE CAULKING GUN 300ML



Capacity	300ml
Weight	0,74Kg
Dimensions (LxWxH)	360x215x60mm

53567

43,00€



AIR CAULKING GUN 310ML



Air intake	1/4"
Operating pressure	2,5-5BAR
Capacity	310ml
Weight	1,05Kg
Dimensions (LxWxH)	305x185x65mm

60032

123,00€



BATTERY CAULKING GUN

Voltage	20V
Maximum thrust force	2500N
Feed rate	0,5-8 mm/s (30-480mm/min)
Cartridge capacity	300ml
Speed	Ajustable/Adjustable
LED	Si/Yes
Compatible with	60012, 60013, 60015, 60016, 60017
Weight	1,60Kg
Dimensions (LxWxH)	420x70x270mm



SPARE PARTS AVAILABLE

60032C

266,00€

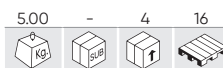

BATTERY CAULKING GUN WITH STORAGE CASE

Voltage	20V
Maximum thrust force	2500N
Feed rate	0,5-8mm/s (30-480mm/min)
Cartridge capacity	300ml
Speed	Ajustable/Adjustable
Includes	60032, 60013, 60016
LED	Si/Yes
Compatible with	60012, 60013, 60015, 60016, 60017
Weight	4,96Kg
Dimensions (LxWxH)	500x130x400mm



SPARE PARTS AVAILABLE

53525

12,00€

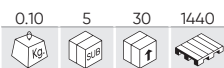

LOCKING CLAMP FOR HOOD AND TRUNK OPENERS



Diameter	10mm
Weight	0,10Kg
Dimensions (LxWxH)	140x90x30mm

53655

12,00€

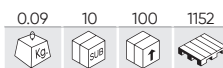

DOOR HANDLE REMOVING TOOL VAG



Brands	VAG
Weight	0,09Kg
Dimensions (LxWxH)	340x70x40mm

54246

104,00€

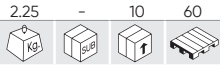

5KG PRECISION SCALE



Capacity	5Kg
Precision	0,1g
AC voltage measurement	220V
DC voltage measurement	6V
Operating temperature	0-40°C
Relative humidity	10%<RH<85%
Weight	2,25Kg
Dimensions (LxWxH)	280x115x285mm

54247

99,00€



2KG PRECISION SCALE



Capacity	2Kg
Precision	0,1g
AC voltage measurement	220V
DC voltage measurement	6V
Operating temperature	0-40°C
Relative humidity	10%<RH<85%
Weight	2,25Kg
Dimensions (LxWxH)	352x136x240mm

53230

20,50€

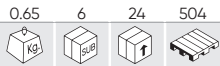

LOCK-OUT TOOL SET

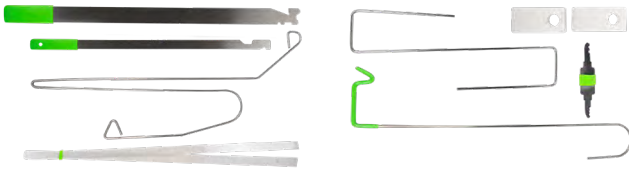

x2	Plastic coat hanger
x2	Nylon wedge with hole
x1	Wire form s-hook
x1	Slide lock tool
x1	Wide lockout bar 610mm
x1	Thin lockout bar 558mm
x1	Gas cap tool
x1	Wonder tool

52077

29,50€



SET OF 4 INFLATABLE PADS



x1	16 x 16cm Pad
x1	32 x 12cm Pad
x1	19 x 6cm Pad
x1	18 x 4.5cm Pad
x1	Manual pump

53486

30,50€



DENT MIRROR

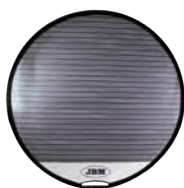

Diameter	800mm
Weight	0,30Kg
Dimensions (LxWxH)	320x300x40mm

15375

28,00€

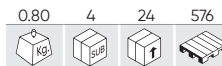

600ML BOTTLE WITH LIQUID FOR REF.53673



Capacity	600ml
Weight	0,80Kg
Dimensions (LxWxH)	75x75x190mm

53673 **80,00€**

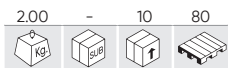

HEADLIGHT RESTORATION SET

x6	6 PCS ABRASIVE PAPER SET FOR 53673
x1	AC-DC ADAPTER FOR 53673
x1	12V ADAPTER FOR 53673
x1	EVAPORATING CUP FOR 53673
x1	CURVED CAP WITH RUBBER SEAL RING FOR 53673
x1	FLAT CAP WITH ONE RUBBER SEAL RING FOR 53673
x1	FUNNEL FOR 53673
x1	GRINDING PLATE FOR 53673
x1	TEXTURED PAPER FOR 53673
x1	600ML BOTTLE WITH LIQUID FOR REF.53673



BAG OF 10 ABRASIVE PAPER

REF.	GRAIN	kg	L	Units	€
14710	180	0.25	10	100	3,90€
14711	280	0.20	10	100	4,00€
14712	360	0.20	10	100	4,00€

REF.	GRAIN	kg	L	Units	€
14713	600	0.15	10	100	4,25€
14714	800	0.15	10	100	4,50€
14715	1200	0.10	10	100	4,75€



VIDEO TUTORIAL



SPARE PARTS AVAILABLE

52740 **690,00€**

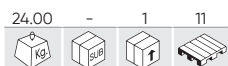

HEAD LIGHT BEAM ALIGNER WITH LUXMETER



Minimum lifting height	230mm
Maximum lifting height	1350mm
Measurement	LUX Digital
Compatible with	Hálogeno/Xenón
Weight	24,00Kg
Dimensions (LxWxH)	520x280x1520mm

52836 **1.100,00€**



DOUBLE LAMP CHECK HEADLIGHT ALIGNER WITH LASER AND LUXMETER



VIDEO TUTORIAL

Minimum lifting height	230mm
Maximum lifting height	1350mm
Measurement	Láser/Laser, LUX Digital
Compatible with	Cualquier tipo de faro/Any type of car lighthouse
Weight	24,85Kg
Dimensions (LxWxH)	520x270x1560mm

53626

18,00€

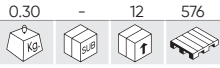

HEADLIGHT RESTORATION SET

- x2 P800 Sanding Discs
- x2 P1200 Sanding Discs
- x2 P2000 Sanding Discs
- x2 3.0ml UV Protect Liquid
- x2 Adapter (3/8" & 1/4")
- x1 85gm Polish Paste
- x1 Masking tape
- x1 Wool Polish Disc
- x1 White Sponge Disc



IN 12 UNITS DISPLAY CASE

53729

20,50€

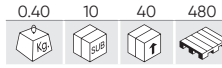

HEADLIGHT ADJUSTMENT TOOL SET

- x1 H6
- x1 300mm H7
- x1 T25



SUCTION PADS

52262

7,50€

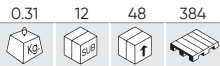

Pieces	1
Diameter	115mm
Capacity	40,00Kg

52263

13,50€

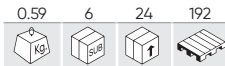

Pieces	1
Diameter	115mm
Capacity	70,00Kg

52264

21,50€

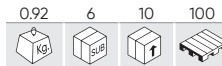

Pieces	1
Diameter	115mm
Capacity	100,00Kg

52265

30,50€

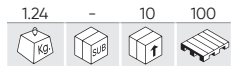

Pieces	1
Diameter	115mm
Capacity	120,00Kg

52295

7,00€

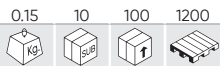

Pieces	2
Diameter	60mm
Capacity	5,00Kg

52589

13,00€

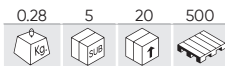

Pieces	1
Diameter	70mm
Capacity	8,00Kg

52765

21,70€

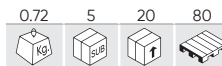

Pieces	1
Diameter	120mm
Capacity	80,00Kg

52998

48,00€

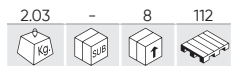

Pieces	3
Diameter	120mm
Capacity	80,00Kg

53232 **39,50€**

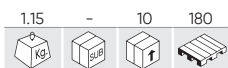

WINDSHIELD REMOVAL TOOL SET

- x1 WINDSHIELD REMOVAL TOOL
- x1 WINDSHIELD MOLDING RELEASE TOOL
- x1 TRIM PAD REMOVER
- x1 1.8M WIRE
- x2 WIRE GRIPPING HANDLE
- x1 WIRE FEEDER TOOL



REF.	DESCRIPTION					€
13813	WIRE FOR WINDSHIELD REMOVAL	0.10	10	60	1200	7,00€
13814	WINDSHIELD REMOVAL HANDLES	0.20	10	60	1080	11,00€

55012 **680,00€**

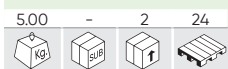

NEW

WINDSHIELD REPLACEMENT TOOL SET WITH CARRY CASE

- x1 CUTTING LINE ANCHOR
- x1 CUTTING LINE PULLEY
- x1 CUTTING LINE WINDER
- x1 SYNTHETIC FIBER WIRE L:100M
- x1 PIERCING TOOL
- x1 CHISEL INSTALLATION STICK
- x1 HOOK TOOL 90° PICK
- x1 RATCHET WRENCH 1/4" SOCKET
- x1 PROTECTION TABLE BOARD



SPARE PARTS AVAILABLE



52321 **8,80€**

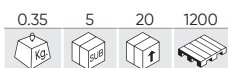

SUBJECTION TAPE WITH TENSIONER 5M X 25MM



Pieces	2
Lenght	5m
Capacity	800Kg
Weight	0,35Kg
Dimensions (LxWxH)	125x115x30mm

52327 **12,00€**



SUBJECTION TAPE WITH TENSIONER 8M X 25MM



Pieces	2
Lenght	8m
Capacity	800Kg
Weight	0,46Kg
Dimensions (LxWxH)	150x140x40mm

50577 **12,60€**

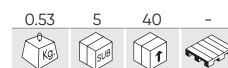

CURVED JAW LOCKING PLIER



Lenght	280mm
Weight	0,53Kg

52385

268,00€

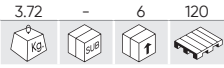

SET OF 6 SELF LOCKING MULTI GRIP PLIERS



52982

55,00€

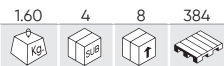

SET OF 3 EXTRA-LONG LOCKING PLIERS



Angle	90°
Length	340mm



Angle	45°
Length	360mm



Angle	0°
Length	370mm

53675

53,00€

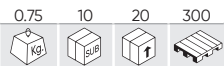

STRAIGHT JAW LOCKING PLIERS



IN 10 UNITS DISPLAY CASE

53676

47,00€

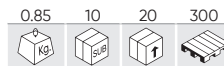

CURVE JAW LOCKING PLIERS



IN 10 UNITS DISPLAY CASE

53677

59,00€

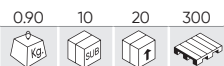

CURVE JAW LOCKING PLIER WITH SWIVEL PAD



IN 10 UNITS DISPLAY CASE

53678

55,00€

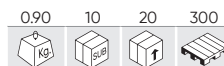





LONG-CURVE JAW LOCKING PLIER



IN 10 UNITS DISPLAY CASE

EXTRA-WIDE OPENING LOCKING PLIERS

REF.	DESCRIPTION	mm	MATERIAL		T					€
52390	PLUGWELD PLIER	250mm	CrMo	-	-	0.50	5	40	640	37,50€
52474	RING CLAMP 5T	190mm	Steel	0-20mm	5T	3.49	-	5	1500	69,00€
52475	LONG NOSE CLAMP 3T	170mm	Steel	0-25mm	3T	3.60	-	10	1500	62,00€
52476	HEAVY DUTY CLAMP 5T	220mm	Steel	0-25mm	5T	3.10	-	10	1500	50,00€
52477	GAP HOOKS CLAMP 2T	200mm	Steel	0-60mm	2T	2.65	-	10	1500	76,50€
52478	ANGLE PULL CLAMP 5T 90°	170mm	Steel	0-20mm	5T	2.90	-	10	1500	49,00€
52479	C CLAMP 3T 90°	155mm	Steel	0-20mm	3T	1.18	-	30	1500	24,70€
52480	BOX CLAMP WITH PULL BRACKET 3T 90°	210mm	Steel	0-25mm	3T	2.00	-	10	1500	44,00€
52481	BOX CLAMP 3T	220mm	Steel	0-20mm	3T	2.05	-	10	1500	52,00€
52482	SMALL MOUTH PULL CLAMP TWO-WAY 5T	210mm	Steel	0-10mm	5T	2.13	-	12	1500	44,00€
52483	SMALL MOUTH PULL CLAMP SINGLE WAY 5T	210mm	Steel	0-10mm	5T	2.02	-	12	1500	41,00€
52484	DOUBLE CLAW HOOK 3T	280mm	Steel	0-110mm	3T	1.19	-	11	1500	70,00€
52485	CHAIN JOINT 4T (DOUBLE GRAB HOOK ASSEMBLY)	270mm	Steel	0-90mm	4T	1.17	-	30	1000	54,00€
52486	CHAIN JOINT 3T (CLAW HOOK & GRAB HOOK ASSEMBLY)	280mm	Steel	0-110mm	3T	1.21	-	11	1500	66,00€
52487	PULL CLAMP 5T	220mm	Steel	0-20mm	5T	2.27	-	7	1000	63,00€
52502	11" LOCKING C-CLAMP	280mm	CrMo	0-110mm	-	0.84	10	30	540	33,50€
52503	LOCKING C-CLAMP W/PAD 11"	280mm	CrMo	0-105mm	-	0.85	-	30	540	35,00€
52504	DOUBLE CLAW CLAMP	225mm	CrMo	0-50mm	-	1.14	-	30	480	27,60€
52505	6" LOCKING C-CLAMP	170mm	CrMo	0-40mm	-	0.27	36	72	2160	22,50€
52506	6" LOCKING C-CLAMP W/PAD	170mm	CrMo	0-50mm	-	0.28	36	72	2160	16,00€
52507	SHEET METAL TOOL 9.5"	250mm	CrMo	0-80mm	-	0.77	5	30	420	32,50€
52511	18" LOCKING C-CLAMP	440mm	CrMo	0-225mm	-	1.31	-	20	280	44,50€
52512	18" LOCKING C-CLAMP W/PAD	450mm	CrMo	0-155mm	-	1.31	-	20	280	53,00€

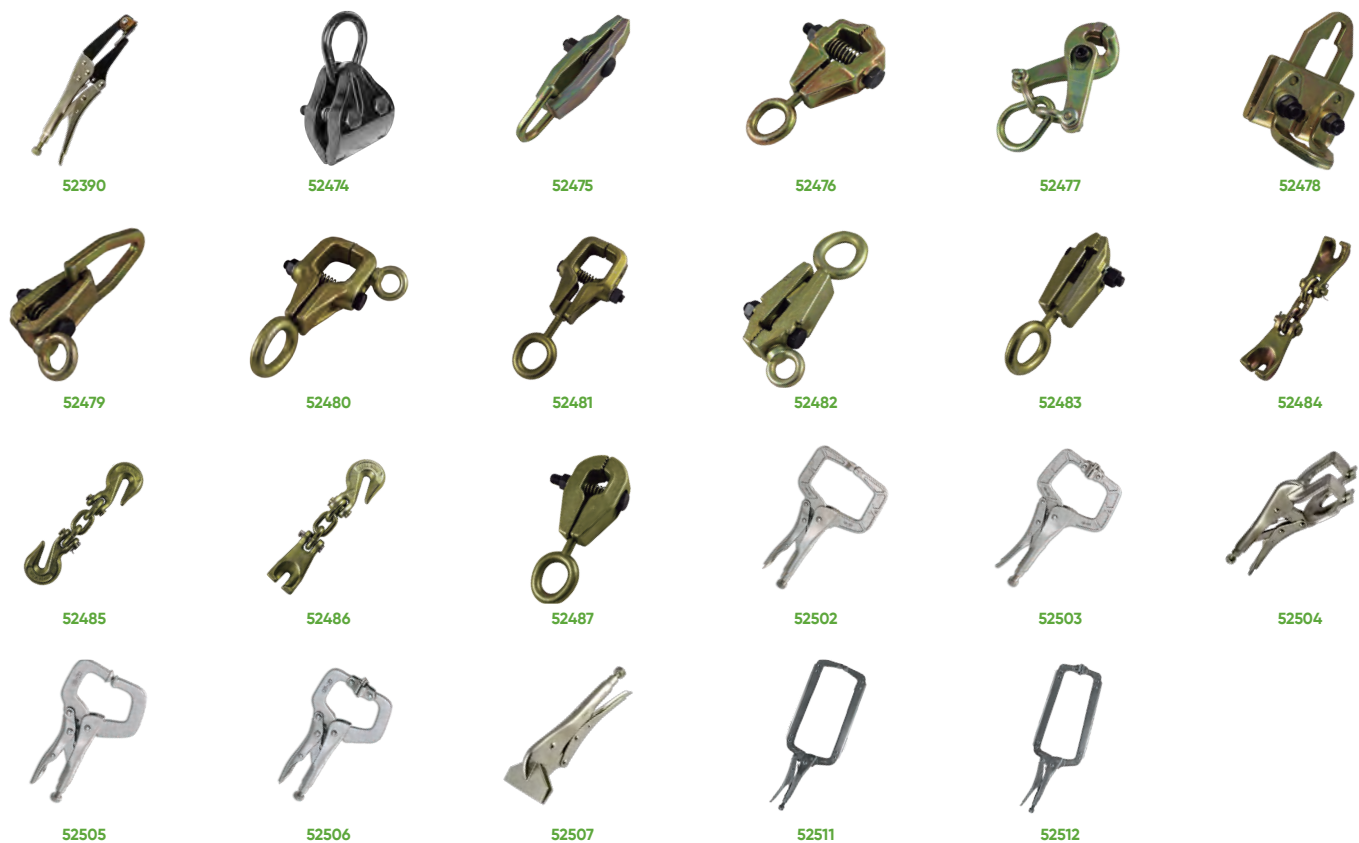

53983

215,00€

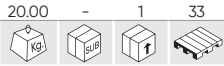

PARTS CARRIER - WINDSHIELD AND HOOD



Capacity	150Kg
Folded dimensions	1200x120x210mm
Weight	19,40Kg
Dimensions (LxWxH)	1200x700x635mm

53124

287,00€



TELESCOPIC UNIVERSAL STAND



Capacity	100Kg
Folded dimensions	25x860x840mm
Weight	21,10Kg
Dimensions (LxWxH)	1380x860x1300mm

53125

477,00€

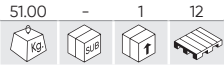

AUTOMOTIVE PARTS CART

Capacity	150Kg
Weight	51,00Kg
Dimensions (LxWxH)	900x610x1980mm



50923

454,00€

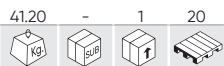

SPECIAL PLATE TRANSPORT CART 340KG



SPARE PARTS AVAILABLE

Capacity	340Kg
Opening	0-1100mm
Weight	41,20Kg
Dimensions (LxWxH)	1340x250x240mm

50839

198,00€



HYDRAULIC CAR WHEEL DOLLY 680KG



SPARE PARTS AVAILABLE

Capacity	680Kg
Opening	345-660mm
Weight	19,20Kg
Dimensions (LxWxH)	680x625x230mm

53079

89,00€

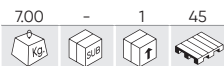

X-TRESTLE



Capacity	100Kg
Folded dimensions	660x1140x300mm
Weight	6,77Kg
Dimensions (LxWxH)	600x680x870mm

53080

99,00€

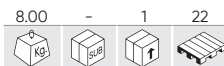

PORTABLE WINDSHIELD STAND



Capacity	70Kg
Folded dimensions	1130x285x990mm
Weight	7,87Kg
Dimensions (LxWxH)	1130x610x990mm

52749

79,00€

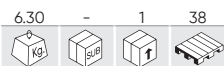

PORTABLE WORKING FOLDING STAND



SPARE PARTS AVAILABLE

Capacity	220Kg
Folded dimensions	1030x905x500mm
Weight	6,25Kg
Dimensions (LxWxH)	1030x390x1000mm

53736

99,00€



FOLDING BUMPER STAND



Capacity	25Kg
Folded dimensions	600x310x1230mm
Weight	8,10Kg
Dimensions (LxWxH)	600x750x1060mm

53685

310,00€

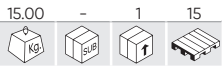

ADJUSTABLE BUMPER STAND



Capacity	25Kg
Folded dimensions	960x865x95mm
Weight	14,50Kg
Dimensions (LxWxH)	762x1118x1346mm

54579

229,00€

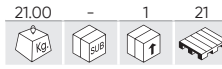

MOBILE BUMPER STORAGE RACK



Capacity	60Kg
Bar Capacity	15Kg
Weight	21,00Kg
Dimensions (LxWxH)	1200x1200x2150mm

53134

145,00€

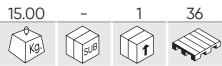

ADJUSTABLE PAINT HANGER

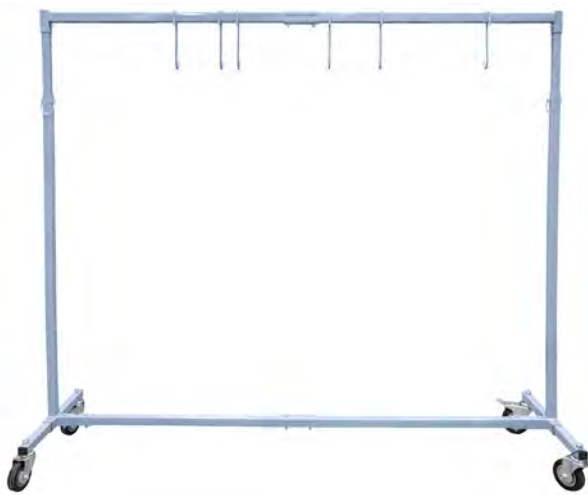

Capacity	150Kg
Minimum lifting height	1270mm
Maximum height	2030mm
Contains	6 Ganchos/Hooks
Weight	14,70Kg
Dimensions (LxWxH)	1770x500x2030mm

53126

243,00€

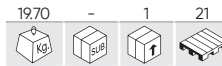

ROTATING PAINT PANEL STAND



SPARE PARTS AVAILABLE

Capacity	50Kg
Contains	6 Brazos de sujeción/Support arms
Weight	19,70Kg
Dimensions (LxWxH)	1220x250x165mm

54959 **268,00€**

20.20 - 1 16 **NEW**

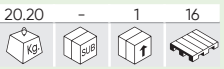

MOBILE WHEEL RIM PAINTING STAND

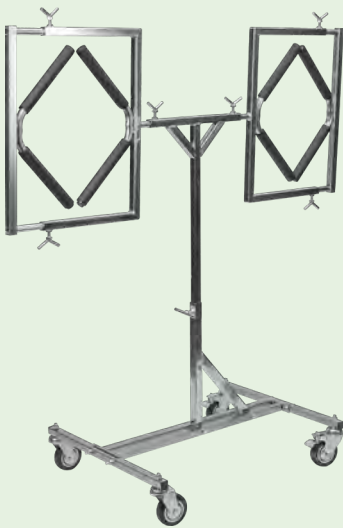

Material	GS
Height	1100 - 1420mm
Rotating	360°
Trays	2
Wheel diameter	15" - 22"
Dimensions (LxWxH)	900x670x1100mm

54960 **159,50€**

11.10 - 1 33 **NEW**



UNIVERSAL PANEL AND BUMPER STAND



Material	GS
Rotating	90°
Maximum load	100Kg
Dimensions (LxWxH)	1220x1330x1870mm
Weight	10,50Kg

54961 **20,00€**

1.10 1 20 240 **NEW**

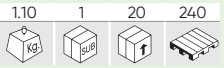

WHEEL RIM HOLDER

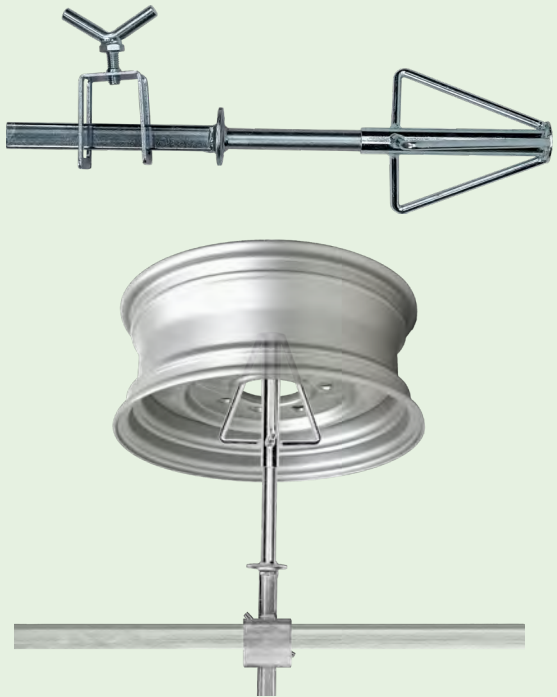

Weight	1,15Kg
Dimensions (LxWxH)	130x100x380mm

54962 **430,50€**

40.25 - 1 14 **NEW**



PARTS CART WITH PANEL SUPPORT



Maximum load	120Kg
Bar Capacity	40Kg
Weight	40,00Kg
Dimensions (LxWxH)	1220x1330x1900mm

52230

398,00€

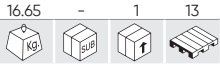

STEP ALUMINIUM WORKING PLATFORM

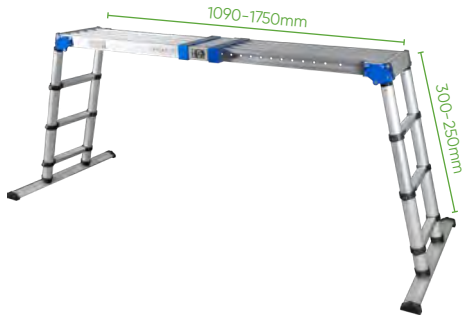

SPARE PARTS AVAILABLE

Capacity	150Kg
Folded dimensions	300x1090x900mm
Minimum length	1090mm
Maximum length	1750mm
Minimum height	550mm
Maximum height	930mm
Material	Al
Compliance with the European directive	EN131
Weight	16,65Kg
Dimensions (LxWxH)	300x1750x900mm

50656

290,00€



SET OF 2 STEP ALUMINIUM WORKING PLATFORM



SPARE PARTS AVAILABLE

Capacity	100Kg
Large platform dimensions (LxWxH)	1300x300x550mm
Folded large platform dimensions (LxWxH)	1300x300x140mm
Small platform dimensions (LxWxH)	1000x300x300mm
Folded small platform dimensions (LxWxH)	1000x300x140mm
Material	Al
Contains	11897, 15552
Compliance with the European directive	EN131
Weight	10,45Kg

50913

229,00€

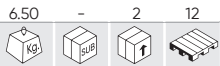

LARGE STEP ALUMINIUM WORKING PLATFORM



Capacity	100Kg
Material	Al
Compliance with the European directive	EN131
Dimensions (LxWxH)	1400x300x800mm
Weight	6,50Kg
Folded dimensions	1400x300x14mm

54789

34,00€

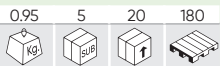

NEW

FRONT CAR PROTECTOR



Material	Poliéster/Polyester
Weight	0,95Kg
Folded dimensions	330x50x210mm
Dimensions assembled	4050x725mm

51622

27,00€



MAGNETIC PROTECTOR FOR FINS AND FRONT PANELS



Type	Imantado/Magnetized
Material	PVC
Weight	0,45Kg
Dimensions (LxH)	1300x640mm

53922

35,00€



WALL PAPER ROLL DISPENSER



Material	Acero inoxidable/Stainless steel
Minimum height	480mm
Maximum height	690mm
Paper roll	380mm
Folded dimensions	450x270x480mm
Weight	1,55Kg
Dimensions (LxWxH)	4550x210x690mm

PAPER NOT INCLUDED

53921

39,00€



FLOOR STAND ROLL DISPENSER



Material	Acero inoxidable/Stainless steel
Height	975mm
Paper roll	380mm
Weight	1,85Kg
Dimensions (LxWxH)	450x345x975mm

PAPER NOT INCLUDED

TELESCOPIC EXTENSION POLES

REF.	MIN.	MAX.	KG	CM	CM	CM	€
52497	1200mm	530mm	0.29	6	48	480	27,00€
53196	1600mm	710mm	0.37	6	48	384	33,00€



53221

5,00€

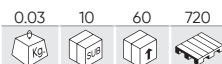

SET OF 3 MICROFIBER CLOTHS



Pieces	3
Color	Verde/Green
Material	PL
Mesure	360x360mm

55066

319,50€



NEW

ELECTRIC SANDER 150 MM 400W



Voltage	220V
Power	400W
Frequency	50Hz
Nominal speed	4000-10000RPM
Disc diameter	150mm
Sanding orbit	5mm
Cable lenght	3m
Weight	1,10Kg
Dimensions (LxWxH)	310x150x110mm

54556

74,00€

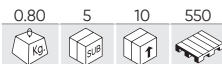

BELT SANDER 3/8"



SPARE PARTS AVAILABLE



Air intake	1/4"
Nominal speed	18000RPM
Real air consumption	113L/min
Operating pressure	6,2BAR
Sound intensity	89dB
Sanding orbit	10x330mm
Sanding orbit	60x80x120mm
Angle	90°
Weight	0,75Kg
Dimensions (LxWxH)	290x100x50mm

55025

120,00€

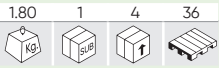

NEW

ELECTRIC DRYING GUN



Voltage	220V ~ 50Hz
Power	1350W
Cable lenght	5M
Air flow rate	93 CFM
Maximum air acceleration	22000ft/min
Weight	1,80Kg
Dimensions (LxWxH)	270x140x280mm

60071

140,00€

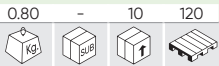

NEW

CORDLESS AIR BLOWER FOR VEHICLE DRYING



Voltage	20V
Air flow	55m/s
RPM (Revolutions per minute)	22500-35000
Air flow rate	10,4CFM (294L/min)
Diameter	2,5"
Compatible with	60013, 60015
Weight	0,76Kg
Dimensions (LxWxH)	168x116x255mm

54771

279,00€



20L UPHOLSTERY VACUUM CLEANER (DRY+WET)



SPARE PARTS AVAILABLE

Voltage	230V
Power	1200W
Frequency	50Hz
Capacity	20L
Liters of suction per second	26L/s
Sound intensity	82dB
Suction power	17-18KPa
IP protection	4
Dimensions (LxWxH)	390x340x460mm
Weight	7,60Kg



53947 **149,00€**

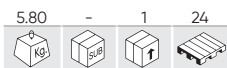

HIGH PRESSURE WASHER 1400W



SPARE PARTS AVAILABLE



Voltage	230V
Power	1400W
Frequency	50Hz
Operating pressure	70-105BAR
Maximum flow rate / Maximum operating flow	5,5-6,8L/min
Operating temperature	50°C
IP protection	IPX5
Weight	5,80Kg
Dimensions (LxWxH)	280x255x440mm

53948 **324,00€**



HIGH PRESSURE WASHER 2400W



SPARE PARTS AVAILABLE



Voltage	230V
Power	2400W
Frequency	50Hz
Operating pressure	120-180BAR
Maximum flow rate / Maximum operating flow	5,5-8L/min
Operating temperature	50°C
IP protection	IPX5
Weight	12,10Kg
Dimensions (LxWxH)	440x345x505mm

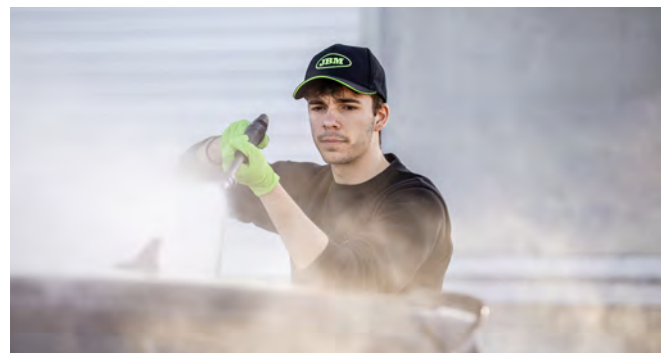

54805 **478,00€**



NEW

SET OF HEXAGONAL LED CEILING LIGHTS

Brightness	83640Lm
Power	615W
Efficiency	110-120Lm/W
Voltage	185-240V
LED type	2835
Number of LED's	12
LED color temperature	6500k
Material	Al + PC
Cable lenght	1,5m Enchufe europeo/ EU Plug
IP protection	IP45
Weight	7,50Kg
Dimensions (LxWxH)	2435x42x4845mm

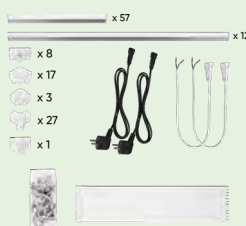

SPARE PARTS AVAILABLE

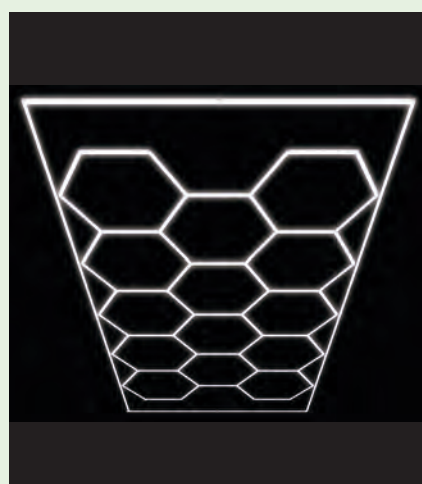



54346

12,80€

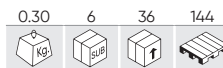

SET OF 3 CLEANING BRUSHES FOR DRILL



Pieces	3
Axle size	1/4"
Diameter	50, 88, 100mm

54912

7,90€

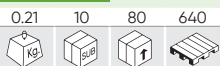

NEW

PROFESSIONAL 4-IN-1 CAR WASHING KIT FOR INTERIOR AND EXTERIOR



Pieces	4
Material	PP
Brush length	220, 225, 230, 240mm
Weight	0,21Kg

54895

16,80€



NEW

CAR DETAILING SET WITH 7 DETAILING ESSENTIALS



Pieces	7
Material	PP
Brush length	220, 225, 230, 240mm
Head diameter	50, 88, 100mm
Axle size	1/4"
Weight	0,35Kg

50844

65,00€

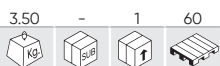

WORK STOOL



Material	Acero/Steel, PVC
Capacity	115Kg
Height	380mm
Weight	3,50Kg
Dimensions (LxWxH)	360x375x380mm

54682

54,00€

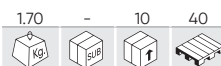

ROLLING KNEE CREEPER



Material	Polipropileno/Polypropylene
Maximum load	100Kg
Weight	1,7Kg
Dimensions (LxWxH)	500x255x85mm

53191

14,80€



INDIVIDUAL FOAM MAT



Material	Espuma EVA/EVA foam
Weight	0,15Kg
Dimensions (LxWxH)	480x180x320mm