



JBM[®]

UNEALTA DVS

PRETURI VALABILE DIN
01/04/2024



2024



TRUSE DE SCULE

7

TRUSE DE SCULE
TRUSE DE TUBULARE
CUTII / VALIZE DE SCULE
TRUSE DE BITI
TRUSE MINI CU CLICHETI
TRUSE DE ADAPTOARE
SET DE TUBULARE
SET DE BITI
SCULE IZOLATE



SCULE DE MÂNĂ

37

CHEI FIXE
CLEME FIXARE
CLICHETI
CHEI DINAMOMETRICE
BARE DE EXTENSIE
ȘURUBELNIȚE
CLEȘTI
SCULE DE INSPECȚIE
CIOCANE
SCULE DE TĂIAT
DĂLȚI
NITUITOARE
SCULE DE MĂSURAT
DIVERSE



MOBILIER DE ATELIER

71

CĂRUȚIOARE CU SCULE
SETURI DE SCULE
ACCESORII / PIESE DE SCHIMB
MASĂ DE LUCRU
DEPOZITARE
TABURETI / TĂRGI
NICOVALE / MENGHINE



SCULE ELECTRICE FĂRĂ FIR

101

ÎNȘURUBARE
PERFORARE
ȘLEFUIRE/LUSTRUIRE
DEBITARE
SCULE SPECIALE
SCULE PENTRU GRĂDINĂRIT
BATERII / ÎNCĂRCĂTOARE
ACCESORII / CONSUMABILE



ILUMINAT

129

LĂMPI DE INSPECȚIE
LANTERNE DE CAP
LAMPĂ DE MĂRIRE CU LED
REFLECTOARE CU LED
LĂMPI DE CAPOTĂ
GIROFARURI
LĂMPI DE LUCRU CU LED
SEMNALIZARE
ACCESORII ȘI PIESE DE SCHIMB



SCULE PNEUMATICE

145

ÎNȘURUBARE
PERFORARE
TĂIERE / DEBITARE
ȘLEFUIRE / LUSTRIRE
PISTOALE DE SUFLAT CU AER
ÎNȚEȚINEREA ANVELOPELOR
ALTELE
ROLE / FURTUNURI DE AER
CUPLE CONECTARE
ACCESORII ȘI CONSUMABILE



SCULE DE IMPACT

167

TUBULARE DE IMPACT
SCULE SPECIALE PENTRU ROTI
ADAPTOARE
PIESE DE SCHIMB DE TUBULARE DE IMPACT
SCULE SPECIALE PENTRU CAMIOANE



CAROSERIE AUTO

179

INSTRUMENTE DE LUCRU PENTRU TINICHIGERIE
RESTAURARE FARURI
ÎNLOCUIRE GEAMURI
REPARAȚII ȘASIU
MOBILIER AUXILIAR
ÎNȚEȚINEREA INTERIOARE



FRÂNE

193

SCULE PENTRU REPOZIȚIONARE FRÂNE
PURGATOARE FRÂNE
ÎNȚEȚINEREA



SCULE SPECIALE

199

SISTEM DE LUBRIFIERE
EXTRACTOARE DE INJECTOARE
BLOC / CHIULASA
AMBREIAJ
SISTEMUL DE RĂCIRE
SISTEMUL DE AER CONDIȚIONAT
TRANSMISIE
SUSPENSIE
EVACUARE
SISTEMUL ELECTRIC
REPARAȚII FILETE
MOTOCICLETĂ
EXTRACTOARE



INSTRUMENTE DE SINCRONIZARE

243

FIAT/ALFA ROMEO
BMW/MINI
PSA
FORD
JAGUAR/LAND ROVER
JEEP/CHRYSLER

MERCEDES-BENZ
RENAULT/DACIA/NISSAN
OPEL/VAUXHALL
VAG
ALTELE
INSTRUMENTE AUXILIARE



ACCESORII PENTRU LUBRIFIANȚI

301

POMPE DE ALIMENTARE MOTORINA
POMPE DE ALIMENTARE CU UREE
POMPE DE EXTRACTIE/UMPLERE
COLECTOARE DE ULEI
PISTOALE DE ASPIRAȚIE
GĂLEȚI DE COLECTARE A ULEIULUI
ALTELE



SCULE HIDRAULICE

313

CRICURI HIDRAULICE
CRICURI HIDRAULICE TIP BUTELIE
CRICURI CU CLICHET
CRIC HIDRAULIC TELESCOPIC
SUPPORTURI PENTRU CRIC AUTO
ALTELE
LIZE
PRESE
MACARALE
MESE DE RIDICARE
RACORD DE CAUCIUC PENTRU RIDICAREA MAȘINII



SCULE ELECTRICE

327

DISPOZITIVE DE PORNIRE
ÎNȚREȚINERE BATERII
MULTIMETRE
INSPECȚIE VIZUALĂ
SUDURĂ
ECHIPAMENTE DE ATELIER
AER CONDIȚIONAT
TERMOMETRE
ALTELE



ENERGIE REGENERABILĂ ȘI MOBILITATE

341

CABLURI DE ÎNCĂRCARE A MAȘINILOR ELECTRICE
ÎNCĂRCĂTOARE PENTRU MAȘINI ELECTRICE
GENERATOR DE ENERGIE
SCULE IZOLATE



ACCESORII PENTRU ATELIER

347

ROLE DE FURTUNURI
SCĂRI
CĂRUȚIOARE ȘI PLATFORME



ACCESORII PENTRU AUTOVEHICULE 353

SEMNALIZARE
TRUSE DE URGENȚĂ
BECURI
TRUSE DE PRIM AJUTOR
SIGURANȚĂ
SETURI DE BURDUFURI ȘI CLEME PENTRU ARTICULAȚII
COVORAȘE
ȘTERGĂTOARE
BICICLETĂ
ALTELE
SENZORI DE PARCARE
TUBURI FLEXIBILE



ACCESORII PENTRU ANVELOPE 367

GREUTĂȚI PENTRU ROȚI
REPARAȚII PERFORĂRI
VALVE PENTRU ANVELOPE
DEMONTARE ȘI INSTALARE

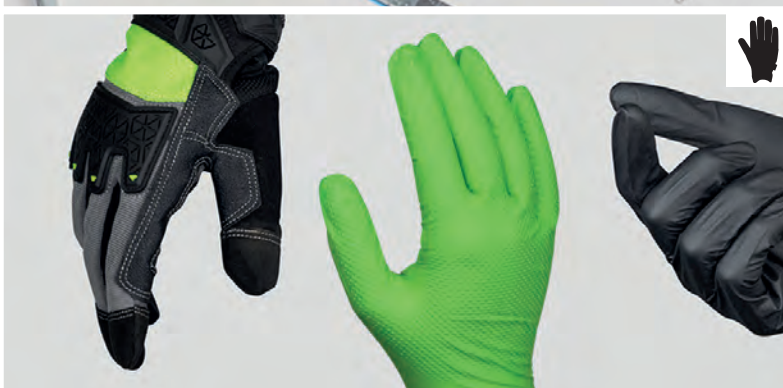

SIGURANȚĂ ȘI EIP 373

MĂNUȘI / IPE
MĂȘTI PT FAȚĂ / DISPENSATORI
DELIMITARE
OZONOMETRU



CONSUMABILE 381

ACE ȘI INELE FIXARE
NITURI
ȘURUBURI PIULIȚE ȘAIBE
ȘAIBE PENTRU CARTER ȘI MOTOR
ALTELE
GARNITURI ȘI GARNITURI INELARE
CONECTORI PENTRU FURTUNURI
ELECTRICE
CLEME ȘI AGRAFE DIN PLASTIC



ÎMBRĂCĂMINTE DE LUCRU 405

VESTE
GEACHETE



PROMOȚIONAL 407

PRODUSE PROMOȚIONALE
STANDURI / ACCESORII
AMBALARE

JBM INSTRUMENTUL DVS

JBM ESTE MARCA DVS. DE UNELTE PROFESIONALE

Companie lider specializata in industrie și auto

+7.000

DE PRODUSE
DISPONIBILE

+23.000

DE EUROPALEȚI
ÎN STOC

+68

EXPORTĂM ÎN
PESTE 68 DE ȚĂRI

+550

DE PRODUSE
NOI PE AN

PESTE 30 DE ANI DE EXPERIENȚĂ

La JBM suntem specialiști în distribuția de unelte și echipamente pentru automobile, oferind servicii de calitate celor peste 11.000 de clienți din mai mult de 68 de țări.

EXPERȚI ÎN DISTRIBUȚIE ȘI LOGISTICĂ

JBM dispune de o rețea logistică în continuă îmbunătățire, care permite o distribuție rapidă și eficientă nu numai în Peninsula Iberică, ci și către toți clienții internaționali.

GAMĂ MARE DE PRODUSE

Oferim o gamă completă de peste 7.000 de articole. Unelte de toate tipurile: manuale, electrice, pentru atelier, dulapuri de unelte, iluminare, truse de consumabile...



**SERVICII DE
CALITATE SUSȚINUTE
DE PESTE 11.000
DE CLIENȚI**

**LIVRĂRI
INTERNAȚIONALE
EXPORTĂM ÎN
PESTE 68 DE ȚĂRI**

**SEDIUL CENTRAL DIN
SPANIA ȘI UN DEPOZIT DE
PESTE 6.000M²**



TRUSE DE SCULE

- 9 TRUSE DE SCULE
- 17 TRUSE DE TUBULARE
- 24 CUTII / VALIZE DE SCULE
- 28 TRUSE DE BITI
- 32 TRUSE MINI CU CLICHETI
- 32 TRUSE DE ADAPTOARE
- 33 SET DE TUBULARE
- 34 SET DE BITI
- 35 SCULE IZOLATE



INSTRUMENTE DE ÎNALTĂ CALITATE PENTRU ACTIVITĂȚILE ZILNICE

01

CONCEPTE PENTRU O
PERFORMANȚĂ OPTIMĂ ÎN TOATE
TIPURILE DE LUCRĂRI

02

MATERIAL REZISTENT CU FINISAJ DIN
OȚEL CROMAT DE CALITATE OPTIMĂ

03

MÂNER ERGONOMIC CU DIAMETRU
MARE PENTRU O MAI BUNĂ
CAPACITATE DE TORSIUNE



54034

178,00€



TRUSĂ DE TUBULARE 216 PIESE HEXAGONALE - ZINCAT



ZINCAT

54045

179,00€



TRUSĂ DE TUBULARE 216 PIESE HEXAGONALE - CROMAT



CROMAT



INCLUDE

	1/2" x14	13, 14, 15, 16, 17, 18, 19, 20, 21, 22, 24, 27, 30, 32mm
	3/8" x10	10, 11, 12, 13, 14, 15, 16, 17, 18, 19mm
	1/4" x13	4, 4.5, 5, 5.5, 6, 7, 8, 9, 10, 11, 12, 13, 14mm
	1/2" x5	16, 17, 18, 19, 22mm
	3/8" x6	10, 11, 12, 13, 14, 15mm
	1/4" x7	4, 5, 6, 7, 8, 9, 10mm
	1/2" x3	E20, E22, E24
	3/8" x6	E10, E11, E12, E14, E16, E18
	1/4" x5	E4, E5, E6, E7, E8
	1/2" x3	1/2" - 3/8" - 1/4"
	1/2" x2	125, 250mm
	3/8" x1	125mm
	1/4" x2	50, 100mm
	x3	1/2" - 3/8" - 1/4"
	1/2" x1	Adaptor 3/8" H x 1/2" M
	1/2" x1	8mm
	3/8" x1	8mm
	1/4" x1	6mm

	1/2" x2	16, 21mm
	3/8" x1	18mm
	1/2" x12	8, 9, 10, 11, 12, 13, 14, 15, 16, 17, 18, 19mm
	1/2" x7	1.27, 1.5, 2, 2.5, 3, 4, 5mm
	1/4" x1	
	1/4" x1	
	1/4" x1	
	1/2" x1	T70
	1/2" x1	14mm
	x3	PH0, PH1, PH2
	x3	P20, P21, P22
	x4	3, 4, 5, 6mm
	1/4" x4	SL4, SL5.5, SL6.5, SL7
	x8	T8, T9, T10, T15, T20, T25, T27, T30
	x8	T8, T9, T10, T15, T20, T25, T27, T30

	8mm x4	7, 8, 10, 12mm
	6mm x6	2, 2.5, 3, 4, 5, 6mm
	8mm x3	SL8, SL10, SL12
	8mm x3	PH2, PH3, PH4
	8mm x3	P22, P23, P24
	8mm x5	T40, T45, T50, T55, T60
	6mm x3	T5, T6, T7
	8mm x5	T40, T45, T50, T55, T60
	6mm x1	T7
	8mm x4	M10, M11, M12, M13
	6mm x5	M5, M6, M7, M8, M9
	8mm x2	M10, M12
	6mm x3	M5, M6, M8
	8mm x1	TS50
	6mm x8	TS10, TS15, TS20, TS25, TS27, TS30, TS40, TS45
	x4	0, 1, 2, 3mm
	x3	6, 8, 10mm
	6mm x4	4, 6, 8, 10mm
	x3	1, 2, 3mm
	x4	1, 2, 3, 4mm
	6mm x1	1/4"

54250

188,00€

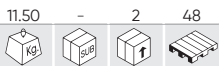

TRUSĂ DE TUBULARE 12 FEȚE CU 216 PIESE - ZINCAT



ZINCAT



PIESE DISPONIBILE



INCLUDE

	1/2" x14	13, 14, 15, 16, 17, 18, 19, 20, 21, 22, 24, 27, 30, 32mm
	3/8" x10	10, 11, 12, 13, 14, 15, 16, 17, 18, 19mm
	1/4" x13	4, 4.5, 5, 5.5, 6, 7, 8, 9, 10, 11, 12, 13, 14mm
	1/2" x5	16, 17, 18, 19, 22mm
	3/8" x6	10, 11, 12, 13, 14, 15mm
	1/4" x7	4, 5, 6, 7, 8, 9, 10mm
	1/2" x3	E20, E22, E24
	3/8" x6	E10, E11, E12, E14, E16, E18
	1/4" x5	E4, E5, E6, E7, E8
	1/2" x3	1/2" - 3/8" - 1/4"
	1/2" x2	125, 250mm
	3/8" x1	125mm
	1/4" x2	50, 100mm
	1/2" x3	1/2" - 3/8" - 1/4"
	1/2" x1	Adaptor 3/8" H x 1/2" M

	1/2" x1	8mm
	3/8" x1	8mm
	1/4" x1	6mm
	1/2" x2	16, 21mm
	3/8" x1	18mm
	1/2" x12	8, 9, 10, 11, 12, 13, 14, 15, 16, 17, 18, 19mm
	1/2" x7	1.27, 1.5, 2, 2.5, 3, 4, 5mm
	1/4" x1	
	1/4" x1	
	1/4" x1	
	1/2" x1	T70
	1/2" x1	14mm
		x3 PH0, PH1, PH2
		x3 PZ0, PZ1, PZ2
		x4 3, 4, 5, 6mm
	1/4" x4	SL4, SL5.5, SL6.5, SL7
		T8, T9, T10, T15, T20, T25, T27, T30
	x8	T8, T9, T10, T15, T20, T25, T27, T30

	8mm x4	7, 8, 10, 12mm
	6mm x6	2, 2.5, 3, 4, 5, 6mm
	8mm x3	SL8, SL10, SL12
	8mm x3	PH2, PH3, PH4
	8mm x3	PZ2, PZ3, PZ4
	8mm x5	T40, T45, T50, T55, T60
	6mm x3	T5, T6, T7
	8mm x5	T40, T45, T50, T55, T60
	6mm x1	T7
	8mm x4	M10, M11, M12, M13
	6mm x5	M5, M6, M7, M8, M9
	8mm x2	M10, M12
	6mm x3	M5, M6, M8
	8mm x1	TS50
	6mm x8	TS10, TS15, TS20, TS25, TS27, TS30, TS40, TS45
	x4	0, 1, 2, 3mm
	x3	6, 8, 10mm
	6mm x4	4, 6, 8, 10mm
	x3	1, 2, 3mm
	x4	1, 2, 3, 4mm
	6mm x1	1/4"

54082

189,00€

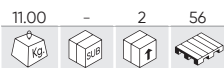

TRUSĂ DE SCULE DIN 132 DE PIESE CU PRIZE HEXAGONALE ZINCATE

132 PCS CrV

ZINCAT



SPECIAL AUTOMOBILE



INCLUDE

	1/2" x7 19, 21, 22, 24, 27, 30, 32mm
	3/8" x12 8, 9, 10, 11, 12, 13, 14, 15, 16, 17, 18, 19mm
	1/4" x11 4, 5, 5.5, 6, 7, 8, 9, 10, 11, 12, 13mm
	3/8" x4 13, 14, 15, 17mm
	1/4" x4 8, 10, 12, 13mm
	3/8" x6 E8, E10, E11, E14, E16, E20
	1/2" x1
	3/8" x1
	1/4" x1
	1/2" x2 127, 254mm
	3/8" x2 76, 152mm
	1/4" x1 50mm
	x1 Ø14mm
	x1

	x1 3/8"(H) - 1/2"(M)
	x1 3/8"(H) - 1/2"(M)
	x1 3/8"(H) - 1/2"(M)
	1/2" x1
	3/8" x1
	1/4" x1
	1/2" x3 17, 19, 21mm
	1/4" x1 6mm
	x1
	x1 PH2x100
	x1 SL6x100
	x12 8, 9, 10, 11, 12, 13, 14, 15, 16, 17, 18, 19mm
	x1
	1/2" x1 H17
	x1

	1/2" x1 21mm
	3/8" x2 16, 18mm
	1/2" x1 T52
	1/2" x1 M16
	x2 5.5, 6.5mm
	x2 PH1, PH3
	3/8" x2 PZ1, PZ3
	x4 4, 5, 6, 8mm
	x6 T20, T30, T40, T45, T50, T55
	x3 4, 5, 6.5mm
	x3 PH1, PH2, PH3
	6mm x3 PZ1, PZ2, PZ3
	x4 3, 4, 5, 6
	x7 T10, T15, T20, T25, T27, T30, T40
	x9 1.5, 2, 2.5, 3, 4, 5, 6, 8, 10mm

54035

149,00€

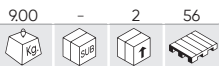

TRUSĂ DE TUBULARE 179 PIESE HEXAGONALE - ZINCAT



ZINCAT

54046

150,00€

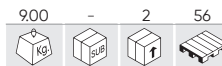

TRUSĂ DE TUBULARE 179 PIESE HEXAGONALE - CROMAT



CROMAT



INCLUDE

	1/2" x17	10, 11, 12, 13, 14, 15, 16, 17, 18, 19, 20, 21, 22, 24, 27, 30, 32mm
	3/8" x10	10, 11, 12, 13, 14, 15, 16, 17, 18, 19mm
	1/4" x13	4, 4.5, 5, 5.5, 6, 7, 8, 9, 10, 11, 12, 13, 14mm
	1/2" x5	16, 17, 18, 19, 22mm
	3/8" x6	10, 11, 12, 13, 14, 15mm
	1/4" x7	4, 5, 6, 7, 8, 9, 10mm
	1/2" x2	E20, E24
	3/8" x6	E10, E11, E12, E14, E16, E18
	1/4" x5	E4, E5, E6, E7, E8
	1/2" x3	1/2" - 3/8" - 1/4"
	3/8" x2	125, 250mm
	1/4" x1	125mm
	1/4" x2	50, 100mm

	x3	1/2" - 3/8" - 1/4"
	1/2" x2	16, 21mm
	3/8" x1	18mm
	1/2" x1	8mm
	3/8" x1	8mm
	1/4" x1	6mm
	x7	1.27, 1.5, 2, 2.5, 3, 4, 5mm
	x1	1/4"
	x1	1/4"
	x3	PH1, PH2, PH3
	x3	PZ1, PZ2, PZ3
	x5	2, 3, 4, 5, 6mm
	x3	SL4, SL5.5, SL7
	x8	T8, T9, T10, T15, T20, T25, T27, T30
	x8	T8, T9, T10, T15, T20, T25, T27, T30

	x11	T5, T6, T7, T8, T9, T10, T15, T20, T25, T27, T30
	x9	T7, T10, T15, T20, T25, T27, T30, T40, T45
	x5	M5, M6, M7, M8, M9
	x3	M5, M6, M8
	x2	PH3, PH4
	x2	PZ3, PZ4
	x5	7, 8, 10, 12, 14mm
	x3	SL8, SL10, SL12
	x6	T40, T45, T50, T55, T60, T70
	x6	T40, T45, T50, T55, T60, T70

54036

99,00€

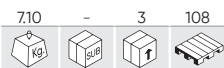

TRUSĂ DE TUBULARE 113 PIESE HEXAGONALE - ZINCAT



ZINCAT

54047

100,00€



TRUSĂ DE TUBULARE 12 FEȚE CU 113 PIESE - CROMAT



CROMAT



INCLUDE

	1/2" x17	10, 11, 12, 13, 14, 15, 16, 17, 18, 19, 20, 21, 22, 24, 27, 30, 32mm
	1/4" x13	4, 4.5, 5, 5.5, 6, 7, 8, 9, 10, 11, 12, 13, 14mm
	1/2" x5	14, 15, 17, 19, 22mm
	1/4" x8	6, 7, 8, 9, 10, 11, 12, 13mm
	1/2" x8	E10, E11, E12, E14, E16, E18, E20, E24
	1/4" x5	E4, E5, E6, E7, E8
	1/2" x2	1/2" - 1/4"
	1/2" x2	125, 250mm
	1/4" x2	50, 100mm

	x2	1/2" - 1/4"
	1/2" x1	Adaptor 3/8" H x 1/2" M
	1/2" x1	8mm
	x5	7, 8, 10, 12, 14mm
	x3	SL8, SL10, SL12
	x2	PH3, PH4
	8mm x2	PZ3, PZ4
	x5	T40, T45, T50, T55, T60
	x5	5, 6, 8, 10, 12mm

	1/2" x2	16, 21mm
	x3	1.5, 2, 2.5mm
	x1	1/4"
	x1	1/4"
	x2	PH1, PH2
	x2	PZ1, PZ2
	1/4" x4	3, 4, 5, 6mm
	x3	SL4, SL5.5, SL6.5
	1/4" x7	T8, T10, T15, T20, T25, T27, T30

54037

88,00€

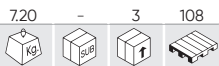

TRUSĂ DE TUBULARE 108 PIESE HEXAGONALE - ZINCAT



ZINCAT

54048

89,00€

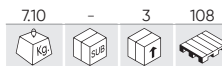

TRUSĂ DE TUBULARE 108 PIESE HEXAGONALE - CROMAT



CROMAT



PIESE DISPONIBILE



PIESE DISPONIBILE

INCLUDE

	1/2" x17	10, 11, 12, 13, 14, 15, 16, 17, 18, 19, 20, 21, 22, 24, 27, 30, 32mm
	1/4" x13	4, 4.5, 5, 5.5, 6, 7, 8, 9, 10, 11, 12, 13, 14mm
	1/2" x5	14, 15, 17, 19, 22mm
	1/4" x8	6, 7, 8, 9, 10, 11, 12, 13mm
	1/2" x8	E10, E11, E12, E14, E16, E18, E20, E24
	1/4" x5	E4, E5, E6, E7, E8
	1/2" x2	1/2" - 1/4"
	1/2" x2	125, 250mm
	1/4" x2	50, 100mm
	1/2" x2	1/2" - 1/4"
	1/2" x1	Adaptor 3/8" H x 1/2" M

	1/2" x2	16, 21mm
	1/2" x1	8mm
	x3	1.5, 2, 2.5mm
	x1	1/4"
	x1	1/4"
	x2	PH3, PH4
	x2	PZ3, PZ4
	8mm x5	7, 8, 10, 12, 14mm
	x3	SL8, SL10, SL12
	x5	T40, T45, T50, T55, T60

	x2	PH1, PH2
	x2	PZ1, PZ2
	1/4" x4	3, 4, 5, 6mm
	x3	SL4, SL5.5, SL6.5
	x7	T8, T10, T15, T20, T25, T27, T30

54038

88,00€

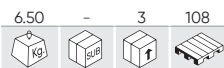

TRUSĂ DE TUBULARE 94 PIESE HEXAGONALE - ZINCAT



ZINCAT



PIESE DISPONIBILE

54049

89,00€



TRUSĂ DE TUBULARE 94 PIESE HEXAGONALE - CROMAT



CROMAT



PIESE DISPONIBILE

INCLUDE

	1/2"	x18	10, 11, 12, 13, 14, 15, 16, 17, 18, 19, 20, 21, 22, 23, 24, 27, 30, 32mm
	1/4"	x13	4, 4.5, 5, 5.5, 6, 7, 8, 9, 10, 11, 12, 13, 14mm
	1/2"	x4	14, 15, 17, 19mm
	1/4"	x8	6, 7, 8, 9, 10, 11, 12, 13mm
		x2	1/2" - 1/4"
	1/2"	x2	125, 250mm
	1/4"	x2	50, 100mm
		x2	1/2" - 1/4"
	1/2"	x1	Adaptor 3/8" H x 1/2" M

	1/2"	x1	8mm
		x3	1.5, 2, 2.5mm
	1/2"	x2	16, 21mm
		x2	PH3, PH4
		x2	PZ3, PZ4
	8mm	x4	8, 10, 12, 14mm
		x3	SL8, SL10, SL12
		x4	T40, T45, T50, T55
	8mm	x1	1/4"

		x1	1/4"
		x1	1/4"
		x1	1/4"
		x2	PH1, PH2
		x2	PZ1, PZ2
	1/4"	x4	3, 4, 5, 6mm
		x3	SL4, SL5.5, SL7
		x6	T8, T10, T15, T20, T25, T30

53212

174,00€

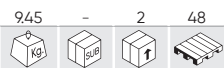

TRUSĂ DE SCULE DIN 303 PIESE CU MUFE HEXAGONALE ZINCATE

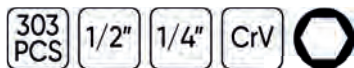

ZINCAT



INCLUDE

	x18	10, 11, 12, 13, 14, 15, 16, 17, 18, 19, 20, 21, 22, 23, 24, 27, 30, 32mm
	x2	125, 250mm
	x2	16, 21mm
	x1	8mm
	x1	Adaptor 3/8" H x 1/2" M
	x1	UNIVERSAL
	x1	T2
	x13	4, 4.5, 5, 5.5, 6, 7, 8, 9, 10, 11, 12, 13, 14mm
	x2	50, 100mm
	x1	6,3mm
	x1	1/4"
	x1	UNIVERSAL
	x1	T2
	x8	T25, T27, T30, T35, T40 (x2), T45, T50
	x2	PH3, PH4
	x2	PZ3, PZ4
	x4	H5.5, H6.5, H7, H8
	x4	5.5, 6.5, 7, 8mm
	x4	5, 6, 8, 10mm

	x9	3, 4, 4.5, 5, 5.5, 6, 6.5, 7, 8mm
	x9	T8, T10, T15, T20, T25, T27, T30, T35, T40
	x9	H1.5, H2, H2.5, H3, H.4, H5, H5.5, H6, H8
	x3	5, 6, 8mm
	x4	1, 2, 3, 4
	x3	6, 8, 10
	x3	C1, C2, C3
	x6	2, 2.5, 3, 4, 5, 6mm
	x4	S0, S1, S2, S3
	x6	5/64, 3/32, 7/64, 1/8, 9/64, 5/32
	x4	4, 6, 8, 10mm
	x10	PH0 (x2), PH1 (x2), PH2 (x4), PH3 (x2)
	x10	PZ0 (x2), PZ1 (x2), PZ2 (x4), Z3 (x2)
	x10	1/16, 5/64, 3/32, 7/64, 1/8, 9/64, 5/32, 3/16, 7/32, 1/4
	x10	T8, T10, T15, T20, T25, T27, T30, T35, T40, T45
	x6	1.5, 2, 2.5, 3, 3.5, 4mm
	x4	PH000, PH00, PH0, PH1
	x2	PZ0, PZ1
	x8	T5, T6, T7, T8, T9, T10, T15, T20

	x1		x1	300g
	x1		x1	
	x10		x1	
	x1		x23	
	x1	3m		x22
	x1			x10
	x1	8"		x10
	x2	0.4x2.5, 0.5x3.0x50mm		
	x3	PH0x50, PH00x50, PH000x50mm		
	x2	0.8x4x100, 1.2x6.5x125mm		
	x2	PH1x80, PH2x100mm		
	x7	1.27, 1.5, 2, 2.5, 3, 4, 5mm		
	x13	1.5, 2, 2.5, 3, 3.2, 3.5, 4, 4.5, 4.8, 5, 5.5, 6, 6.5mm		



54106

89,00€

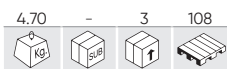

TRUSĂ DE SCULE DE 37 DE PIESE ZINCATĂ ÎN INCH



ZINCAT



PIESE DISPONIBILE

INCLUDE

	1/2" x17	5/16", 3/8", 7/16", 1/2", 9/16", 19/32", 5/8", 11/16", 3/4", 13/16", 7/8", 15/16", 1", 1-1/16", 1-1/8", 1-3/16", 1-1/4"		1/2" x2	5" - 10"
	1/4" x8	3/16", 7/32", 1/4", 9/32", 5/16", 11/32", 3/8", 7/16"		1/4" x1	3"
	x2	1/2" - 1/4"		x1	1/2" - 1/4"
	x2	16, 21mm		x1	1/4"

53074

78,00€

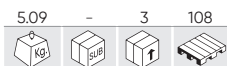

TRUSĂ DE SCULE DIN 74 DE PIESE CU PRIZE CU 12 MUCHII, ZINCATĂ

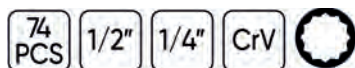

ZINCAT



PIESE DISPONIBILE



INCLUDE

	1/2" x18	10, 11, 12, 13, 14, 15, 16, 17, 18, 19, 20, 21, 22, 23, 24, 27, 30, 32mm
	1/4" x10	4, 5, 5.5, 6, 7, 8, 10, 11, 12, 13mm
	x2	1/2" - 1/4"
	x2	125, 250mm
	1/4" x1	100mm
	x1	1/2"
	x5	PH0, PH1, PH2, PH3, PH4
	x5	PZ0, PZ1, PZ2, PZ3, PZ4
	x6	3, 4, 5, 6, 8, 10mm
	x5	SL3, SL4, SL5.5, SL6, SL7
	x8	T8, T10, T15, T20, T25, T27, T30, T40
	x4	4, 5, 6, 7mm
	1/2" x1	Adaptor 3/8" H x 1/2" M
	1/2" x1	21mm
	x3	1.5, 2, 2.5mm
	x1	1/4"
	1/4" x1	6mm

54140

36,00€



TRUSĂ DE SCULE DIN 56 DE PIESE CU PRIZE CU 12 MUCHII ZINCATĂ



ZINCAT



PIESE DISPONIBILE



INCLUDE

	x13	4, 4.5, 5, 5.5, 6, 7, 8, 9, 10, 11, 12, 13, 14mm
	x1	T2
	x2	50, 100mm
	1/4" x1	
	x1	
	x1	
	x1	
	x1	
	x4	SL4, SL5, SL6, SL7
	x3	M5, M6, M8
	x8	T8, T10, T15, T20, T25, T27, T30, T40
	x8	T8, T10, T15, T20, T25, T27, T30, T40
	x3	PH0, PH1, PH2
	x3	PZ0, PZ1, PZ2
	x6	3, 4, 5, 6, 7, 8mm



TRUSE DE SCULE

54108

66,00€

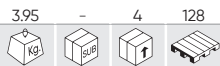

TRUSĂ DE SCULE 22 BUC. 22 BUC. 1/2" PRIZE HEXAGONALE ZINCATE

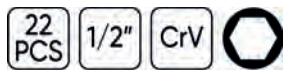

ZINCAT



INCLUDE

	1/2"	x17	10, 11, 12, 13, 14, 15, 16, 17, 18, 19, 20, 21, 22, 24, 27, 30, 32mm
	1/2"	x1	
	1/2"	x2	75, 125mm
		x1	3/8" (H) - 1/2" (M)
		x1	1/2"

54116

66,00€

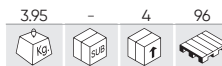

TRUSĂ DE SCULE 22 BUC. 22 BUC. PRIZE CU 12 MUCHII 1/2" ZINCATE

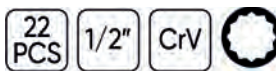

ZINCAT



INCLUDE

	1/2"	x17	10, 11, 12, 13, 14, 15, 16, 17, 18, 19, 21, 22, 24, 27, 30, 32mm
	1/2"	x1	1/2"
	1/2"	x2	125, 250mm
	1/2"	x1	
	1/2"	x1	3/8" (H) - 1/2" (M)

51818

109,00€

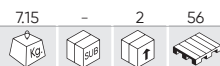

TRUSĂ DE SCULE DIN 72 DE PIESE CU CHEI CU HEXAGONALE ZINCATE



ZINCAT



INCLUDE

	1/2"	x13	10, 11, 12, 13, 14, 15, 17, 19, 22, 24, 27, 30, 32mm
	1/4"	x10	4, 5, 6, 7, 8, 9, 10, 11, 12, 13mm
	1/4"	x5	5, 6, 7, 8, 9mm
	1/2"	x1	1/2"
	1/4"	x1	1/4"
	1/2"	x1	125mm
	1/4"	x1	75mm

	x1	
	x1	300gr
	x1	
	x1	
	x4	SL3, SL4, SL5, SL6
	x3	PH1, PH2, PH3
	x7	T10, T15, T20, T25, T27, T30, T40

	x2	1/2" - 1/4"
	x2	1/2", 16, 21mm
	x1	1/4", 6mm
	x8	10, 11, 12, 13, 14, 15, 17, 19mm
	x3	1.5, 2, 2.5mm
	x1	1/4"
	x2	PH2x100, PH1x40mm
	x3	8x200, 6x100, 6x40mm

54258

58,00€

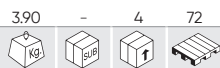

SET DE SCULE ZINCATE DIN 77 DE PIESE



ZINCAT



INCLUDE

	x5	PH0, PH1, PH2, PH2, PH3		x1
	x5	PZ0, PZ1, PZ2, PZ2, PZ3		x10
	x5	SL3, SL4, SL5, SL5.5, SL6mm		x1
	x5	T10, T15, T20, T25, T30		x1
	x4	6x7, 8x9, 10x11, 12x13mm		x1
	x9	1.5, 2, 2.5, 3, 4, 5, 6, 8, 10mm		x1
	x3	PH2x100, PH00x50, PH000x50		x1
	x3	SL6x100, SL2.5x50, SL3.0x50		x10
	x1			x10



54277

53,50€



TRUSĂ DE TUBULARE CU 59 PIESE HEXAGONALE DE 3/8" - ZINCAT

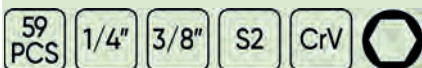

ZINCAT



PIESE DISPONIBILE

INCLUDE

	3/8"	x17	6, 7, 8, 9, 10, 11, 12, 13, 14, 15, 16, 17, 18, 19, 20, 21, 22mm		x2	PH3, PH4		x2	PH1, PH2	
	3/8"	x1	3/8"		x2	PZ3, PZ4		x2	PZ1, PZ2	
	3/8"	x2	75, 150mm		8mm	x5	7, 8, 10, 12, 14mm		x4	3, 4, 5, 6mm
	3/8"	x1	8mm		x3	SL8, SL10, SL12		x3	SL4, SL5.5, SL6.5	
	3/8"	x1	3/8"		x5	T40, T45, T50, T55, T60		x7	T8, T10, T15, T20, T25, T27, T30	
	1/4"	x1	1/4"							

53953

29,00€

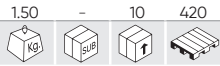

SET DE 130 DE BUC. DE PRIZE ȘI BIȚI ZINCATE

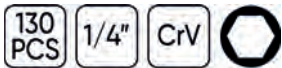

ZINCAT



ÎN INTERPET
10 UNITĂȚI



INCLUDE

	1/4"	x13	4, 4.5, 5, 5.5, 6, 7, 8, 9, 10, 11, 12, 13, 14mm
	1/4"	x1	1/4"
	1/4"	x1	50mm
	1/4"	x1	1/4"
	1/4"	x1	6mm
	1/4"	x1	1/4"
	1/4"	x1	1/4"
	1/4"	x7	1.27, 1.5, 2, 2.5, 3, 4, 5mm

	25mm	x10	T8, T10, T15, T20, T25, T27, T30, T35, T40, T45
	25mm	x9	T8, T10, T15, T20, T25, T27, T30, T35, T40
	25mm	x3	M5, M6, M8
	25mm	x3	6, 8, 10mm
	25mm	x3	C1, C2, C3
	25mm	x4	1, 2, 3, 4mm
	25mm	x4	4, 6, 8, 10mm
	25mm	x4	0, 1, 2, 3mm

	25mm	x10	1/16, 5/64, 3/32, 7/64, 1/8, 9/64, 5/32, 3/16, 7/32, 1/4
	25mm	x9	1.5, 2, 2.5, 3, 4, 5, 5.5, 6, 8mm
	25mm	x6	5/64, 3/32, 7/64, 1/8, 9/64, 5/32
	25mm	x6	2, 2.5, 3, 4, 5, 6mm
	25mm	x9	3, 4, 4.5, 5, 5.5, 6, 6.5, 7, 8mm
	50mm	x2	4, 6mm
	25mm	x10	PH0(x2), PH1(x2), PH2(x4), PH3(x2)
	50mm	x2	PH1, PH2
	25mm	x10	P20(x2), PZ1(x2), PZ2(x4), PZ3(x2)

54109

34,00€

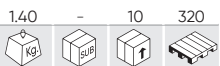

SET DE 46 DE PIESE CU MUFHE HEXAGONALE ZINCATE



ZINCAT



INCLUDE

	1/4"	x13	4, 4.5, 5, 5.5, 6, 7, 8, 9, 10, 11, 12, 13, 14mm
	1/4"	x1	1/4"
	1/4"	x1	72
	1/4"	x1	
	1/4"	x2	50, 100mm
		x4	1.27, 1.5, 2.0, 2.5mm
		x1	
		x1	UNIVERSAL
		x1	1/4"
		x3	SL4, SL5.5, SL7
		x3	PH1, PH2, PH3
		x3	PZ1, PZ2, PZ3
		x6	H3, H4, H5, H6, H7, H8
		x6	T10, T15, T20, T25, T30, T40

54168

49,00€

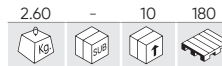

TRUSĂ DE SCULE 3/8" DIN 59 DE PIESE CU PRIZE CU 12 MUCHII, ZINCATĂ



ZINCAT



INCLUDE

		x2	PH3, PH4
		x2	PZ3, PZ4
	8mm	x5	7, 8, 10, 12, 14mm
		x3	8, 10, 12mm
		x5	T40, T45, T50, T55, T60
		x2	PH1, PH2
		x2	PZ1, PZ2
	1/4"	x4	3, 4, 5, 6mm
		x3	4, 5.5, 6.5mm
		x7	T8, T10, T15, T20, T25, T27, T30
	3/8"	x17	6, 7, 8, 9, 10, 11, 12, 13, 14, 15, 16, 17, 18, 19, 20, 21, 22mm
	3/8"	x1	3/8"
	3/8"	x2	75, 150mm
	3/8"	x1	8mm
	3/8"	x1	8mm
	3/8"	x1	
	1/4"	x1	

54105

33,00€



TRUSĂ DE SCULE 3/8" DIN 59 DE PIESE CU PRIZE CU 12 MUCHII, ZINCATĂ



ZINCAT



INCLUDE

	1/4"	x13	4, 4.5, 5, 5.5, 6, 7, 8, 9, 10, 11, 12, 13, 14mm		x4	SL4, SL5, SL6, SL7
	1/4"	x1			x3	M5, M6, M8
	1/4"	x2	50, 100mm		x8	6mm T8, T10, T15, T20, T25, T27, T30, T40
	1/4"	x1			x8	T8, T10, T15, T20, T25, T27, T30, T40
	1/4"	x1			x8	T8, T10, T15, T20, T25, T27, T30, T40
	1/4"	x1			x1	6mm 1/4"
	1/4"	x1	6mm		x3	PH0, PH1, PH2
	6mm	x3	PZ0, PZ1, PZ2		x6	3, 4, 5, 6, 7, 8mm

52418

179,00€



39 DE PIESE GO-THROUGH CAZ INSTRUMENT CROMAT



CROMAT

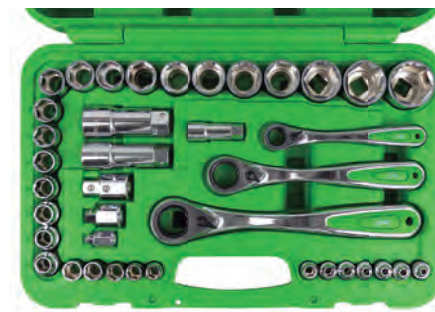

INCLUDE

	13mm	x12	4, 4.5, 5, 5.5, 6, 7, 8, 9, 10, 11, 12, 13mm		1/4"	x1	13mm
	19mm	x10	10, 11, 12, 13, 14, 15, 16, 17, 18, 19mm		3/8"	x1	19mm
	22mm	x5	20, 21, 22, 23, 24mm		1/2"	x1	22mm
	22mm	x3	27, 30, 32mm		1/2"	x3	13, 19, 22mm
	1/2"	x3	13, 19, 22mm		1/2"	x3	13, 19, 22mm

54090

56,00€



14 PIESE GO-THROUGH KIT DE SCULE ZINCAT GALVANIZAT

ZINCAT



INCLUDE

	x11	13, 14, 15, 16, 17, 18, 19, 21, 22, 24, 27mm
	x1 (75mmL)	12,5mm
	x1	1/2"
	x1 (go-through)	

50623

60,00€

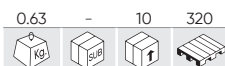

17 PIESE GO-THROUGH CAZ CROMAT

CROMAT



INCLUDE

	x13	4, 4.5, 5, 5.5, 6, 7, 8, 9, 10, 11, 12, 13, 14mm
	x1	75mm
	x1	1/4"
	x1	145mm

TRUSE DE SCULE

52722

87,00€



TRUSĂ DE SCULE DIN 61 DE PIESE ȘURUBURI CU CANELURĂ DE 1/2" ȘI 1/4", ZINCAT



ZINCAT



INCLUDE

	1/2" x11	14, 15, 16, 17, 18, 19, 22, 24, 27, 30, 32mm
	1/4" x12	4, 4.5, 5, 5.5, 6, 7, 8, 9, 10, 11, 12, 13mm
	x2	1/2" - 1/4"
	1/2" x2	5" - 10"
	1/4" x2	2" - 4"
	x2	1/2" - 1/4"

	x1	Adaptor 3/8" H x 1/2" M
	1/2" x2	16, 21mm
	x1	25mm
	x3	1.5, 2, 2.5mm
	x1	1/4"
	x1	1/4"
	x1	AD

	x3	PH1, PH2, PH3
	x3	PZ1, PZ2, PZ3
	x5	25mm 3, 4, 5, 6, 8mm
	x3	SL4, SL5.5, SL7
	x5	T10, T15, T20, T25, T30

53108

92,00€



TRUSĂ DE SCULE 61 DE BUCĂȚI ȘURUBURI CU CANELURĂ DE 1/2" ȘI 1/4", CROMAT

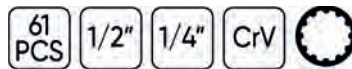

CROMAT



53915

65,00€

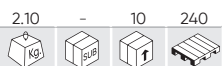

SET DE 6 PRIZE 1/2" TORX TIP E EXTRA LUNG ZINCAT

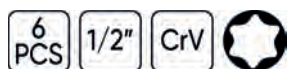

ZINCAT



INCLUDE

	1/2" x6	140mm E10, E12, E14, E16, E18, E20
--	---------	------------------------------------

E12 capul frontal pentru chiulasa BMW:
 - Motor M42, 1,8 L, 4 cilindri, 16 V, model 318 (1989)
 - Motor M50, 2.0L, 2.5L, 6 cilindri, 24V, modele 520i, 525i (1991)

54141

42,00€



SET 28 DE PRIZE TORX SCURTE ȘI LUNGI, ZINCAT

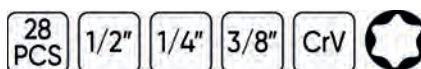

ZINCAT



INCLUDE

	1/4" x5 (25mm)	E4, E5, E6, E7, E8
	3/8" x5 (28mm)	E10, E11, E12, E14, E16
	1/2" x4 (38mm)	E18, E20, E22, E24
	1/4" x5 (50mm)	E4, E5, E6, E7, E8
	3/8" x5 (63mm)	E10, E11, E12, E14, E16
	1/2" x4 (76mm)	E18, E20, E22, E24





51616 378,00€

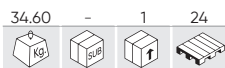

CUTIE METALICĂ CU 22 DE BUCĂȚI DE AUTOCLAVE HEXAGONALE DE 1" ZINCATE



ZINCAT



**CUTIE METALICĂ
INCLUDE**

	1"	x17	36, 38, 41, 46, 50, 54, 55, 58, 60, 63, 65, 67, 70, 71, 75, 77, 80mm
	1"	x1	650mm
	1"	x2	205, 410mm
	1"	x1	
	1"	x1	



51855 378,00€



CARCAȘĂ METALICĂ CU 22 BUCĂȚI DE AUTOCLAVE DE 1" PE 12 MUCHII ZINCATE

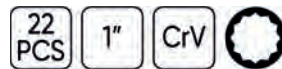

ZINCAT



**CUTIE METALICĂ
INCLUDE**

	1"	x17	36, 38, 41, 46, 50, 54, 55, 58, 60, 63, 65, 67, 70, 71, 75, 77, 80mm
	1"	x1	650mm
	1"	x2	205, 410mm
	1"	x1	
	1"	x1	



53727 198,00€

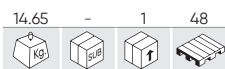

TRUSĂ DE SCULE CU 21 DE PIESE 3/4" HEXAGONALE ZINCATE

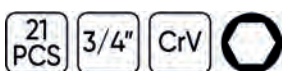

ZINCAT



INCLUDE

	3/4"	x16	19, 21, 22, 23, 24, 26, 27, 29, 30, 32, 35, 36, 38, 41, 46, 50mm
	3/4"	x1	495mm
	3/4"	x3	100, 200, 400mm
	3/4"	x1	445mm



53728 198,00€



TRUSĂ DE SCULE CU 21 BUC. 3/4" 12 TĂIȘURI ZINCATE

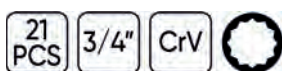

ZINCAT



INCLUDE

	3/4"	x16	19, 21, 22, 23, 24, 26, 27, 29, 30, 32, 35, 36, 38, 41, 46, 50mm
	3/4"	x1	495mm
	3/4"	x3	100, 200, 400mm
	3/4"	x1	445mm



54261



321,00€

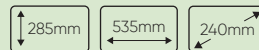

N

CUTIE METALICĂ CU UNELTE 143 BUCĂȚI ZINCATĂ



ZINCAT



PIESE DISPONIBILE

INCLUDE

	x13	4, 4.5, 5, 5.5, 6, 7, 8, 9, 10, 11, 12, 13, 14mm		x20	8, 9, 10, 11, 12, 13, 14, 15, 16, 17, 18, 19, 20, 21, 22, 23, 24, 27, 30, 32mm		x4	SL5x75, SL6x100, SL8x150, SL10x200mmL	
	x6	8, 10, 11, 12, 13, 14mm		x2	5" - 10"		x3	PH1x80, PH2x100, PH3x150mmL	
	x7	E4, E5, E6, E7, E8, E10, E11		x2	1/2" x2	16, 21mm		x4	PH1, PH2x2, PH3
	x2	2", 4"		x1	UNIVERSAL			x4	PZ1, PZ2x2, PZ3
	x1	110mmL		x1	3/8"(F) - 1/2"(M)			x4	SL3, SL4, SL5, SL6
	1/4"	x1		x1	150L			x4	H3, H4, H5, H6
	x3	PH1, PH2, PH3		x3	SL4, SL5.5, SL6.5			x7	T10, T15, T20, T25, T27, T30, T40
	x6	TT10, TT15, TT20, TT25, TT30, TT40		x6	H3, H4, H5, H6, H7, H8			x7	TT10, TT15, TT20, TT25, TT27, TT30, TT40
	x6	H3, H4, H5, H6, H7, H8		x3	SL4, SL5.5, SL6.5			x1	1/4"
	x1	250mm		x3	SL4, SL5.5, SL6.5			x1	6.35mmx60mmL
	x1	250mm		x6	TT10, TT15, TT20, TT25, TT30, TT40			x1	1/4"-6.35mm
	x1	250mm		x6	H3, H4, H5, H6, H7, H8			x1	7"-180mm
	x1	250mm		x6	H3, H4, H5, H6, H7, H8			x1	7"-180mm
	x1	250mm		x6	H3, H4, H5, H6, H7, H8			x1	10"-250mm
	x1	250mm		x6	H3, H4, H5, H6, H7, H8			x1	10"-250mm

53565

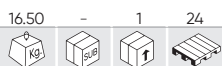

258,00€



CUTIE DE SCULE DIN FIER 64 DE PIESE ZINCAT



ZINCAT

INCLUDE

	1/2"	x18	10, 11, 12, 13, 14, 15, 16, 17, 18, 19, 20, 21, 22, 23, 24, 27, 30, 32mm
		x1	1/2"
		x1	1/2"
	1/2"	x3	76, 127, 254mm
	1/2"	x1	255mm
	1/2"	x1	21mm
		x1	457mm
		x18	6, 7, 8, 9, 10, 11, 12, 13, 14, 15, 16, 17, 18, 19, 20, 21, 22, 24mm
		x9	1.5, 2, 2.5, 3, 4, 5, 6, 8, 10mm
		x3	PH1x100, PH2x150, H3x200mm
		x3	SL5x100, SL6x150, SL8x200mm
		x1	250mm
		x1	180mm
		x1	200mm
		x1	180mm



PIESE DISPONIBILE

53159

289,00€

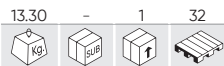

CUTIE DE SCULE DIN ALUMINIU 159 PIESE ZINCATE



ZINCAT



INCLUDE



	1/2" x14	14, 15, 16, 17, 18, 19, 20, 21, 22, 23, 24, 27, 30, 32mm
	1/4" x10	4, 5, 6, 7, 8, 9, 10, 11, 12, 13mm
	x2	1/4" - 1/2"
	1/2" x2	50, 100mm
	1/4" x2	125, 250mm
	1/4" x1	150mm
	x2	1/4" - 1/2"
	1/2" x1	Adaptor 3/8" H x 1/2" M
	x2	1/4" - 1/2"
	1/4" x1	250mm
	1/4" x1	110mm
	1/2" x2	16, 21mm
	x1	1/4"

	x9	8, 10, 11, 12, 13, 15, 17, 19, 22mm
	x9	1.5, 2, 2.5, 3, 4, 5, 6, 8, 10mm
	x1	100-250V
	x1	
	x2	PH1x80, PH2x10mm
	x4	SL3x75, SL4x100, SL6.5x125, SL8x150mm
	x1	PH00x50mm
	x1	SL2.5x50mm
	x1	250mm
	x1	200mm
	x1	160mm
	x1	7" (180mm)
	x1	180mm
	x1	220mm
	x1	160mm
	x1	160mm

	x1	
	x6	1,5mm
	x1	
	x1	300gr
	x1	3m
	x1	200mm
	x5	
	x1	18mm
	x10	
	x40	6.35mm
	x15	8mm



53928

278,00€

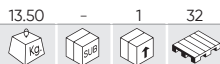

TRUSĂ DE SCULE DIN 135 DE PIESE CU PRIZE HEXAGONALE ZINCATE



ZINCAT



INCLUDE

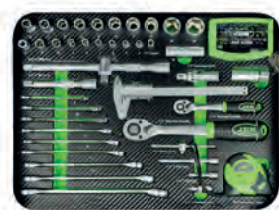

	x10	10, 11, 12, 13, 14, 15, 17, 19, 22, 24mm
	x2	16, 21mm
	x1	UNIVERSAL
	x2	125, 250mm
	x1	3/8" - 1/2"
	x1	
	x9	4, 5, 6, 7, 8, 9, 10, 11, 12mm
	x1	UNIVERSAL
	x1	
	x2	50, 100mm
	x1	6mm
	x9	8, 10, 11, 12, 13, 14, 17, 19, 22mm
	x1	150mm
	x1	

	x4	PH1, PH2, PH2, PH3
	x4	PZ1, PZ2, PZ2, PZ3
	x4	SL3, SL4, SL5, SL6
	x4	H3, H4, H5, H6
	x7	TT10, TT15, TT20, TT25, TT27, T30, T40
	x7	TT10, TT15, TT20, TT25, TT27, TT30, TT40
	x1	6mm
	x1	6mmL
	x5	
	x1	
	x2	PH1x80mm, PH2x100mm
	x4	SL3.0x75mm, SL4.0x100mm, SL6.5x125mm, SL8x150mm

	x1	
	x1	
	x3	SL1.5, SL2, SL3
	x4	PH000, PH00, PH0, PH1
	x4	T4, T5, T6, T7, T8, T10, T15, T20
	x8	T8, T10, T15, T20
	x4	TS0.8, TS1.2, TS1.5, TS2.0
	x1	H2.0
	x1	
	x1	
	x9	1.5, 2, 2.5, 3, 4, 5, 6, 8, 10mm
	x1	
	x1	5m
	x1	300g

	x1	250mm
	x1	180mm
	x1	180mm
	x1	200mm
	x1	160mm
	x1	200mm
	x1	
	x3	
	x1	18mm

53444

195,00€

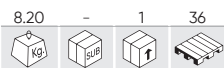

TRUSĂ DE SCULE DIN ALUMINIU 108 BUC. ȘTUȚURI 1/2" ZINCATE

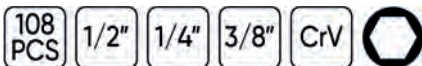

ZINCAT



INCLUDE



	x9	10, 11, 12, 13, 14, 15, 17, 18, 19mm
	x2	75, 150mm
	x1	16mm
	x1	Ⓜ
	x1	Adaptor 3/8" H x 1/2" M
	x8	4, 4.5, 5, 5.5, 6, 7, 8, 9mm
	x1	150mmL
	x1	6mm
	x2	PH1x80, PH2x100mm
	x4	SL3.5x75, SL4x100, SL6.5x125, SL8x150mm
	x1	PH00x50mm
	x1	SL2.5x50mm
	x1	

	x9	6x7, 8x9, 10x11, 12x13, 14x15, 16x17, 18x19, 20x22mm
	x9	1.5, 2, 2.5, 3, 4, 5, 6, 8, 10mm
	x1	
	x6	
	x1	200mm
	x1	18mm
	x10	
	x1	220mm
	x1	180mm
	x1	160mm
	x1	250mm
	x1	160mm

	x30	
	x1	300g
	x1	3m



52603

74,00€

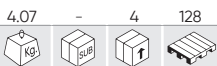

TRUSĂ CAPETE TUBULARE PENTRU ȘURUBURI 12 FEȚE CU 26 PIESE



INCLUDE

	x8 (55mmL)	M5, M6, M8, M9, M10, M12, M14, M16
	x7 (100mmL)	M5, M6, M8, M9, M10, M12, M14
	x7 (140mmL)	M5, M6, M8, M9, M10, M12, M14
	x4 (200mmL)	M8, M10, M12, M14

52606

88,00€



TRUSĂ CAPETE TUBULARE RIBE PENTRU ȘURUBURI CU 32 PIESE

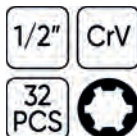

INCLUDE

	x9 (55mmL)	M5, M6, M7, M8, M9, M10, M12, M13, M14
	x9 (100mmL)	M5, M6, M7, M8, M9, M10, M12, M13, M14
	x7 (140mmL)	M7, M8, M9, M10, M12, M13, M14
	x7 (200mmL)	M7, M8, M9, M10, M12, M13, M14

52604

78,00€

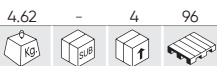

TRUSĂ CAPETE TUBULARE HEXAGONALE PT. ȘURUBURI CU 30 PIESE

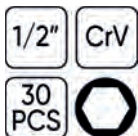

INCLUDE

	x9 (55mmL)	5, 6, 7, 8, 10, 12, 14, 17, 19mm
	x8 (100mmL)	5, 6, 7, 8, 10, 11, 12, 13mm
	x7 (140mmL)	5, 6, 7, 8, 10, 12, 14mm
	x6 (200mmL)	5, 6, 7, 8, 10, 12mm

52605

76,00€



TRUSĂ CAPETE TUBULARE TORX PT. ȘURUBURI CU 32 PIESE

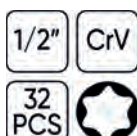

INCLUDE

	x10 (55mmL)	T20, T25, T27, T30, T40, T45, T50, T55, T60, T70
	x10 (100mmL)	T20, T25, T27, T30, T40, T45, T50, T55, T60, T70
	x6 (140mmL)	T40, T45, T50, T55, T60, T70
	x6 (200mmL)	T40, T45, T50, T55, T60, T70



54266

39,50€

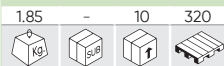

N

TRUSA DE TUBULARE ȘI VÂRFURI TORX DE 1/2" 19 PIESE



INCLUDE

	x9	E10, E11, E12, E14, E16, E18, E20
	x10	T20, T25, T27, T30, T40, T45, T50, T55, T60, T70



PIESE DISPONIBILE

54154

37,50€



TRUSĂ 12 PIESE 1/2" IMBUSURI TORX

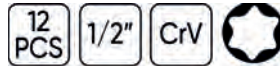

INCLUDE

	x6	T20, T25, T30, T40, T45, T50
	x6	T55, 60, T70, T80, T90, T100



PIESE DISPONIBILE

51260

37,00€



TRUSĂ DE 12 BUC. VÂRFURI HEXAGONALE DE 1/2".

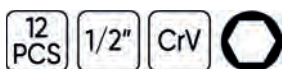

INCLUDE

	x6	H5, H6, H7, H8, H10, H12
	x1	H14
	x5	H16, H17, H18, H19, H20



PIESE DISPONIBILE

54164

34,00€



TRUSĂ DE 12 PIESE 1/2" IMBUSURI INELARE

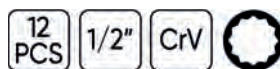

INCLUDE

	x6 (55mmL)	M4, M5, M6, M8, M9
	x6 (70mmL)	M10, M12, M14, M16, M18, M20



PIESE DISPONIBILE



50983

48,00€



TRUSĂ SPECIALĂ CU 42 CAPETE ȘURUBELNIȚĂ PT. ȘURUBURI TORX ȘI ȘURUBURI DE 12 ȘI 6 FEȚE

42 PCS 1/2"
3/8" S-2



INCLUDE

	3/8"	x1	10mm
	1/2"	x1	10mm
	30mm	x7	4, 5, 6, 7, 8, 10, 12mm
	75mm	x7	4, 5, 6, 7, 8, 10, 12mm
	30mm	x8	T20, T25, T30, T40, T45, T50, T55, T60
	75mm	x8	T20, T25, T30, T40, T45, T50, T55, T60
	30mm	x5	M5, M6, M8, M10, M12
	75mm	x5	M5, M6, M8, M10, M12



PIESE DISPONIBILE

50985

59,00€



TRUSĂ SPECIALĂ CU 42 CAPETE DE ȘURUBELNIȚĂ PENTRU ȘURUBURI TORX ȘI ȘURUBURI DE 12 ȘI 6 FEȚE

42 PCS 1/2"
3/8" S-2



INCLUDE

	3/8"	x1	10mm
	1/2"	x1	10mm
	30mm	x7	4, 5, 6, 7, 8, 10, 12mm
	75mm	x7	4, 5, 6, 7, 8, 10, 12mm
	30mm	x8	T20, T25, T30, T40, T45, T50, T55, T60
	75mm	x8	T20, T25, T30, T40, T45, T50, T55, T60
	30mm	x5	M5, M6, M8, M10, M12
	75mm	x5	M5, M6, M8, M10, M12



PIESE DISPONIBILE

52550

92,00€

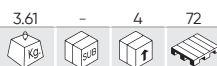

TRUSĂ CAPETE DE ȘURUBELNIȚĂ 75 PIESE PENTRU ȘURUBURI RIBE, XZN, TORX INV., HEXAGONAL

75 PCS 1/2"
3/8" S-2

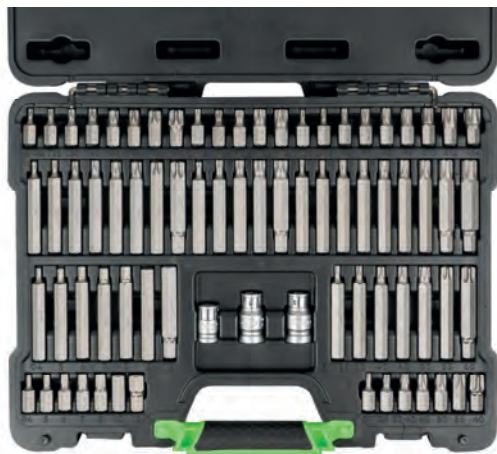

PIESE DISPONIBILE

INCLUDE

	3/8"	x1	10mm
	1/2"	x2	10mm
	30mm	x7	4, 5, 6, 7, 8, 10, 12mm
	75mm	x7	4, 5, 6, 7, 8, 10, 12mm
	30mm	x8	T20, T25, T30, T40, T45, T50, T55, T60
	75mm	x8	T20, T25, T30, T40, T45, T50, T55, T60
	30mm	x5	M5, M6, M8, M10, M12
	75mm	x5	M5, M6, M8, M10, M12
	30mm	x8	R5, R6, R7, R8, R9, R10, R12, R14
	75mm	x8	R5, R6, R7, R8, R9, R10, R12, R14
	30mm	x8	TT20, TT25, TT30, TT40, TT45, TT50, TT55, TT60
	75mm	x8	TT20, TT25, TT30, TT40, TT45, TT50, TT55, TT60

52753

107,00€



TRUSĂ SPECIALĂ CU 55 CAPETE DE ȘURUBELNIȚĂ HEAVY DUTY

55 PCS 1/2"
3/8" S-2



PIESE DISPONIBILE

INCLUDE

	3/8"	x1	10mm
	1/2"	x2	10, 14mm
	30mm	x9	4, 5, 6, 7, 8, 10, 12, 14, 16mm - ISO 2136
	75mm	x9	4, 5, 6, 7, 8, 10, 12, 14, 16mm - ISO 2136
	30mm	x10	T20, T25, T30, T40, T45, T50, T55, T60, T70, T80 - DIN 2325
	75mm	x10	T20, T25, T30, T40, T45, T50, T55, T60, T70, T80 - DIN 2325
	30mm	x7	M5, M6, M8, M10, M12, M14, M16 - DIN 2325
	75mm	x7	M5, M6, M8, M10, M12, M14, M16 - DIN 2325

52539

59,00€

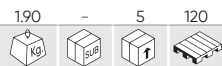

TRUSĂ CAPETE TUBULARĂ ASORTATE



INCLUDE

	x10	PH3, PH4
	x10	PZ3, PZ4
	8mm	x25 7, 8, 10, 12, 14mm
	x15	SL8, SL10, SL12
	x25	T40, T45, T50, T55, T60



52538

62,00€



TRUSĂ CAPETE ȘURBELNIȚĂ ASORTATE



INCLUDE

	x10	PH1, PH2
	x10	PZ1, PZ2
	1/4"	x20 3, 4, 5, 6mm
	x15	SL4, SL5.5, SL6.5
	x35	T8, T10, T15, T20, T25, T27, T30



53574

47,00€

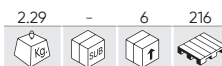

TRUSĂ DE 208 PIESE



INCLUDE

	x12	1.5, 2, 2.5, 3, 3.5, 4, 4.5, 5, 5.5, 6, 7, 8mm
	25mmL x10	1/16, 5/64, 3/32, 7/64, 1/8, 9/64, 5/32, 3/16, 7/32, 1/4
	50mmL x5	2.5, 3, 4, 5, 6mm
	75mmL x5	2.5, 3, 4, 5, 6mm
	25mmL x18	PH00, PH0, PH1(x5), PH2(x5), PH3(x5), PH4
	50mmL x3	PH1, PH2, PH3
	75mmL x3	PH1, PH2, PH3
	25mmL x17	PZ00, PZ0, PZ1(x5), PZ2(x5), PZ3(x4), PZ4
	50mmL x3	PZ1, PZ2, PZ3
	75mmL x3	PZ1, PZ2, PZ3
	25mmL x14	T5, T6, T7, T8, T9, T10, T15, T20, T25, T27, T30, T35, T40, T45
	50mmL x7	T10, T15, T20, T25, T27, T30, T40
	75mmL x7	T10, T15, T20, T25, T27, T30, T40

	25mmL x3	6, 8, 10mm
	50mmL x3	6, 8, 10mm
	25mmL x4	4, 6, 8, 10mm
	50mmL x4	4, 6, 8, 10mm
	25mmL x4	1, 2, 3, 4mm
	50mmL x4	1, 2, 3, 4mm
	25mmL x6	2, 2.5, 3, 4, 5, 6mm
	25mmL x6	5/64, 3/32, 7/64, 1/8, 9/64, 5/32
	25mmL x13	T5, 6, 7, 8, 9, 10, 15, 20, 25, 27, 30, 40, 45
	25mmL x3	1, 2, 3mm
	25mmL x4	0, 1, 2, 3mm
	25mmL x3	M5, M6, M8
	25mmL x9	TS10, TS15, TS20, TS25, TS27, TS30, TS40, TS45, TS50

	25mmL x12	SL2, SL2.5, SL3, SL3.5, SL4, SL4.5, SL5, SL5.5, SL6, SL6.5, SL7, SL8
	mm x10	4, 5, 6, 7, 8, 9, 10, 11, 12, 13
	" x10	5/32, 3/16, 7/32, 1/4, 9/32, 5/16, 11/32, 3/8, 7/16, 1/2
	6mm x1	1/4"
	x1	
	x1	



52620

8,80€

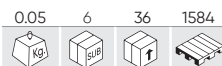

ADAPTOR UNGHIULAR

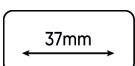

- Pentru zone de acces dificil.
- Funcție de eliberare rapidă.
- Burghiu 6mm.

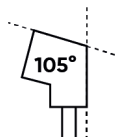

53156

26,20€

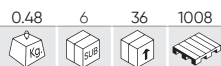

TRUSĂ DE 38 PIESE CU CLICHET TELESCOPIC DE 1/4"



PIESE DISPONIBILE



INCLUDE

	1/4"	x11	4, 4.5, 5, 6, 7, 8, 9, 10, 11, 12, 13mm		6mm	x5	4, 5, 6, 7, 8mm
	1/4"	x1			6mm	x3	SL6, SL8, SL10
		x2	PH3, PH4		6mm	x8	T8, T9, T10, T15, T20, T25, T30, T40
		x2	PZ3, PZ4			x4	M5, M6, M9, M10
		x1	1/4"			x1	1/4"

52198

37,70€

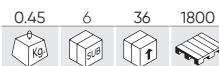

TRUSĂ DE 37 PIESE CU CLICHET TELESCOPIC DE 1/4"

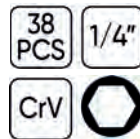

PIESE DISPONIBILE



INCLUDE

	1/4"	x11	4, 4.5, 5, 6, 7, 8, 9, 10, 11, 12, 13mm		6mm	x5	4, 5, 6, 7, 8mm
	1/4"	x1			6mm	x3	SL6, SL8, SL10
		x2	PH3, PH4		6mm	x8	T8, T9, T10, T15, T20, T25, T30, T40
		x2	PZ3, PZ4			x4	M5, M6, M9, M10
		x1	1/4"			x1	1/4"

51333

18,00€



SET DE 6 ADAPTOARE

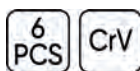

PIESE DISPONIBILE

REF.	mm				€
11360	1/4H - 3/8M	0.03	10	100	2,60€
11361	1/4M - 3/8H	0.03	5	300	3,20€
11362	1/2H - 3/4M	0.14	10	100	5,20€
11363	3/8H - 1/2M	0.50	10	100	3,90€
11364	1/2H - 3/8M	0.05	10	100	4,50€
11365	3/4H - 1/2M	0.14	10	100	9,40€

53743

39,70€



SET DIN 6 DE CAPETE DE PERCUŢIE



PIESE DISPONIBILE

REF.	mm				€
14749	1/4"H - 3/8"M	0.03	20	200	2,00€
14750	3/8"H - 1/4"M	0.05	20	100	2,00€
14751	3/8"H - 1/2"M	0.15	20	100	4,00€
14752	1/2"H - 3/8"M	0.16	10	100	4,00€
11962	1/2"H - 3/4"M	0.17	10	100	7,50€
11964	3/4"H - 1/2"M	0.35	10	100	12,50€

52714

15,70€

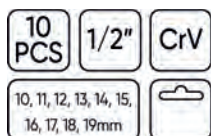

SET TUBULARE 1/2" HEXAGONALE

PIESE
DISPONIBILE

52716

15,90€

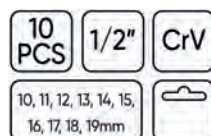

SET TUBULARE 1/2" INELARE

PIESE
DISPONIBILE

52715

10,00€

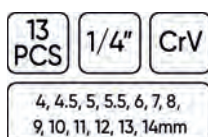

SET TUBULARE 1/4" HEXAGONALE

PIESE
DISPONIBILE

52717

11,00€

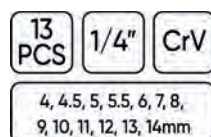

SET TUBULARE 1/4" INELARE

PIESE
DISPONIBILE

51410

36,00€

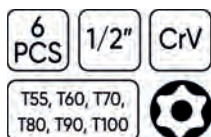
SET DE 6 BUC. VÂRFURI TORX 1/2",
INVIOLABILEPIESE
DISPONIBILE

51409

36,00€

SET DE 6 VÂRFURI 1/2" 12 FEȚE / VÂRF TIP
XZNPIESE
DISPONIBILE

52909

12,50€

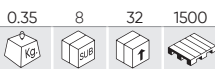

SET DE CAPETE TUBULARE 1/4" (18 PCS)

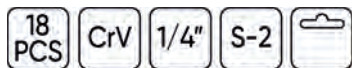

PIESE DISPONIBILE

INCLUDE

	x2	PH1, PH2		x3	SL4, SL5.5, SL6.5
	x2	PZ1, PZ2		x7	T8, T10, T15, T20, T25, T27, T30
	x4	3, 4, 5, 6mm			

52908

17,00€

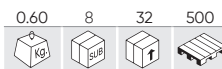

SET DE CAPETE TUBULARE 1/4" 30 UNITĂȚI

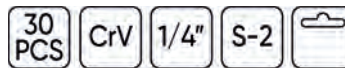

PIESE DISPONIBILE

INCLUDE

	x3	PH0, PH1, PH2		x4	SL4, SL5.5, SL6.5, SL7
	x3	PZ0, PZ1, PZ2		x8	T8, T9, T10, T15, T20, T25, T27, T30
	x4	3, 4, 5, 6mm		x8	T8, T9, T10, T15, T20, T25, T27, T30

53084

24,00€

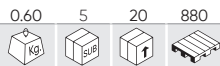

SET DE CAPETE TUBULARE TORX 3/8" - 1/2"

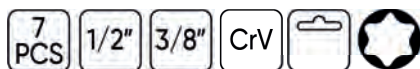

PIESE DISPONIBILE

	x2	T55, T60, T70		x5	T30, T40, T45, T50
--	----	---------------	--	----	--------------------

53127

12,00€

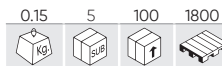

SET DE 7 CAPETE TUBULARE TORX INVIOLABILE 1/4"



PIESE DISPONIBILE

	x7	T10, T15, T20, T25, T30, T40, T45
--	----	-----------------------------------

51746

12,00€

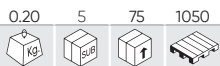

SET DE CAPETE TUBULARE TS 5 FEȚE INVIOLABILE



TS10, TS15, TS20, TS25, TS30, TS40, TS45



50980

22,00€

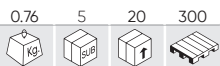

SET DE CAPETE TUBULARE TORX RIBE



	100mm	M12, M13, M14
	90mm	M6, M7, M8, M10

50982

22,00€

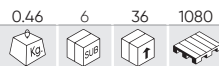

SET DE CAPETE TUBULARE TORX ROTUNDE 3/8"



	100mm	
	4, 5, 6, 7, 8, 10mm	

52320

22,00€

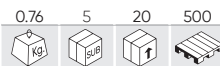

SET DE CAPETE TUBULARE INELARE



	100mm	M12, M13, M14
	90mm	M6, M7, M8, M10

12029

5,50€

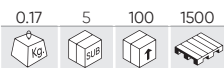

TUBULARĂ CAPĂT XZN 1/2" INVIOLABILĂ M16X58MM ESP. VAG



12030

6,50€



TUBULARĂ CAPĂT 1/2" XZN INVIOLABILĂ M16X100MM ESP. VAG



"T" DE FORȚĂ CU PĂTRAT EXTRALUNG 12 FEȚE - 800MM 1/2"

REF.	DESCRIERE					€
52059	Ø 8mm - 800mm	0.57	-	25	1750	29,00€
52060	Ø 10mm - 800mm	0.57	-	25	1750	32,00€
53667	Ø 12mm - 800mm	0.80	10	20	-	32,00€
53668	Ø 14mm - 800mm	1.05	10	20	-	34,00€



54091

441,00€



KIT DE SCULE CAUCIUCATE CONFORM STANDARDULUI VDE - 26BUC.



54093

441,00€



MODUL EVA CU UNELTE IZOLATE VDE 26 BUC. (ACETAT DE VINIL ETILEN)

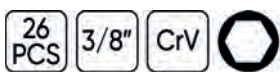

INCLUDE

	3/8" x10	8, 10, 11, 12, 13, 14, 16, 17, 18, 19, 21, 22mm
	3/8" x1	200mm
	1/2" x1	125mm
	3/8" x1	200mm

	x2	4x100mmL, 5,5x125mmL
	x2	PH1x80mm, PH2x100mm
	x1	185mm
	x1	

	x6	7x86, 8x99, 10x109, 12x127, 14x141, 17x156mm
	x1	185mm

15162

30,20€

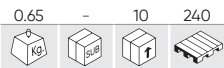

MODUL DE 8 ȘURUBELNIȚE IZOLATE, EVA ÎN FIBRĂ DE CARBON



PIESE DISPONIBILE

REF.	Ø	kg	10	50	€
15227	0.5x3.0x75mm	0,02	10	50	3,50€
15228	0.8x4.0x100mm	0,05	10	50	4,00€
15229	1.0x5.5x125mm	0,08	5	50	5,00€
15230	1.2x6.5x150mm	0,11	5	50	5,00€
15231	PH0x75mm	0,02	10	50	3,50€
15232	PH1x80mm	0,05	10	50	4,00€
15233	PH2x100mm	0,08	5	50	5,00€
15234	Circuit de Tester Auto 140mm	0,02	10	50	3,00€



- ⊖ x4 0.5x3.0x75, 0.8x4.0x100, 1.0x5.5x125, 1.2x6.5x150mm
- ⊕ x3 PH0x75, PH1x80, PH2x100mm
- ⚡ x1 SL3x140mm

53154

462,00€



TRUSĂ DE PIESE IZOLATE CU 20 PIESE DE 3/8"



INCLUDE

⊖	3/8"	x12	8, 10, 11, 12, 13, 14, 16, 17, 18, 19, 21, 22mm
⊕	3/8"	x1	200mm
⊕	3/8"	x2	125, 250mm
⊕	3/8"	x1	200mm
⚡	3/8"	x4	75mm, 4, 5, 6, 8mm

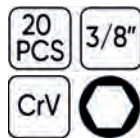

52519

25,50€

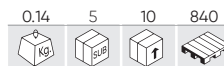

SET DE 7 ȘURUBELNIȚE IZOLATE 1.000V



INCLUDE

- ⊕ x2 PH00x50, PH0x50mm
- ⊖ x5 SL1.5x0.23x50, SL1.8x0.30x50, SL2.0x0.40x50, SL2.5x0.40x50, SL3.0x0.50x50mm

CUȚIT IZOLAT

REF.	DESCRIERE	kg	6	36	1152	€
53164	DREPT	0.10	6	36	1152	16,50€
53165	CURBAT	0.10	6	36	1152	19,60€



SCULE DE MÂNĂ

- 38 CHEI FIXE
- 48 CLEME FIXARE
- 49 CLICHETI
- 51 CHEI DINAMOMETRICE
- 53 BARE DE EXTENSIE
- 53 ȘURUBELNIȚE
- 56 CLEȘTI
- 62 SCULE DE INSPECȚIE
- 63 CIOCANE
- 64 SCULE DE TĂIAT
- 65 DĂLȚI
- 66 NITUITOARE
- 68 SCULE DE MĂSURAT
- 69 DIVERSE

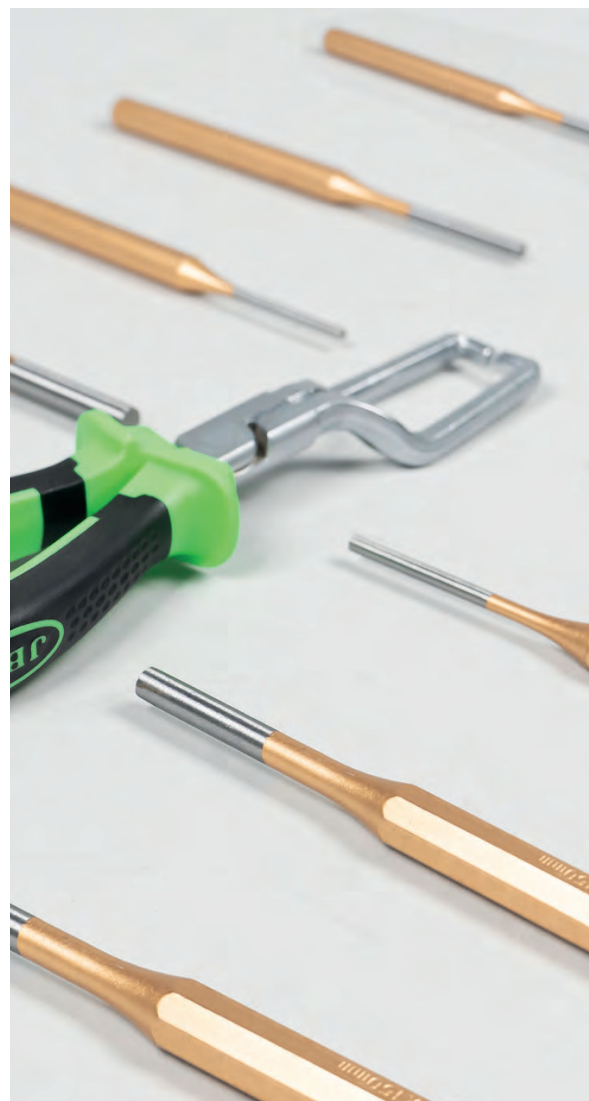

SCULE DE MÂNĂ

54101

61,00€

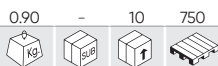

SET DE 6 CHEI CU RATCHET



8x9, 10x11, 12x13,
14x15, 16x18, 17x19mm



PIESE DISPONIBILE

REF.	mm	Kg	Box	Box	€
15632	8x9	0.04	10	100	9,00€
15633	10x11	0.07	10	100	9,50€
15634	12x13	0.11	10	100	11,00€

REF.	mm	Kg	Box	Box	€
15635	14x15	0.13	10	100	12,50€
15636	16x18	0.19	10	100	14,00€
15637	17x19	0.25	10	100	15,00€

53017

57,00€

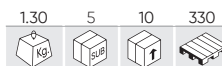

SET DE 7 CHEI COMBinate CU CLICHET ȘI CAP ROTATIV



8, 10, 11, 13,
14, 17, 19 mm



PIESE DISPONIBILE

REF.	mm	Kg	Box	Box	€
10552	8	0.06	10	100	7,10€
10554	10	0.09	10	100	7,50€
10555	11	0.09	10	100	7,80€
10557	13	0.13	10	100	8,10€

REF.	mm	Kg	Box	Box	€
10558	14	0.14	5	100	9,35€
10561	17	0.22	10	100	11,00€
10563	19	0.28	10	100	12,50€

54117

74,00€



SET DE 12 CHEI COMBinate CU RATCHET



8, 9, 10, 11, 12, 13, 14, 15,
16, 17, 18, 19 mm



PIESE DISPONIBILE

REF.	mm	Kg	Box	Box	€
13465	8	0.05	10	100	5,55€
13466	9	0.06	10	100	5,55€
13467	10	0.10	10	100	6,00€
13468	11	0.08	10	100	6,25€
13469	12	0.09	10	100	6,25€
13470	13	0.10	10	100	6,60€

REF.	mm	Kg	Box	Box	€
13471	14	0.11	10	100	6,90€
13472	15	0.13	10	100	7,25€
13473	16	0.15	10	100	8,10€
13474	17	0.19	10	100	8,70€
13475	18	0.22	10	100	9,10€
13476	19	0.22	10	100	9,60€

51318

98,00€



SET DE 12 CHEI COMBinate CU CLICHET ȘI CAP ROTATIV



8, 9, 10, 11, 12, 13, 14,
15, 16, 17, 18, 19 mm



PIESE DISPONIBILE

REF.	mm	Kg	Box	Box	€
10552	8	0.06	10	100	7,10€
10553	9	0.07	10	100	7,35€
10554	10	0.09	10	100	7,50€
10555	11	0.09	10	100	7,80€
10556	12	0.11	10	100	8,10€
10557	13	0.13	10	100	8,10€

REF.	mm	Kg	Box	Box	€
10558	14	0.14	5	100	9,35€
10559	15	0.16	10	100	9,50€
10560	16	0.19	5	50	10,60€
10561	17	0.22	10	100	11,00€
10562	18	0.26	5	100	12,30€
10563	19	0.28	10	100	12,50€

54338

60,00€



CHEIE CU CLICHET CU CAP INTERSCHIMBABIL 12 BUC.

PIESE DISPONIBILE

REF.	mm				€	REF.	mm				€
16391	8	0.01	30	100	4,60€	16397	14	0.05	30	100	5,50€
16392	9	0.05	30	100	4,60€	16398	15	0.05	30	100	5,50€
16393	10	0.05	30	100	4,60€	16399	16	0.05	30	100	5,50€
16394	11	0.05	30	100	5,10€	16401	17	0.05	30	100	6,10€
16395	12	0.05	30	100	5,10€	16402	18	0.05	30	100	6,10€
16396	13	0.05	30	100	5,10€	16403	19	0.10	30	100	6,10€



N

15316

58,00€

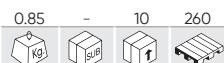

SET DE 3 CHEI CU 72 DE DENTI – TIP «4 ÎN 1»



PIESE DISPONIBILE

REF.	mm				€
15515	12-13mm x 8-10mm	0.15	10	50	15,50€
15516	14-15mm x 9-11mm	0.20	10	50	19,00€
15517	18-19mm x 16-17mm	0.40	5	50	22,50€

54066

83,00€



MODUL CU 7 CHEI CU TRINCHETĂ EXTRA LUNGĂ



PIESE DISPONIBILE

REF.	mm				€	REF.	mm				€
13453	8	0.10	6	36	9,00€	13457	14	0.25	6	36	12,00€
13454	10	0.15	10	100	9,50€	13460	17	0.40	6	24	15,00€
13455	12	0.20	6	36	10,50€	13462	19	0.50	6	24	17,00€
13456	13	0.20	6	36	11,50€						

54032

84,00€



MODUL CU 12 CHEI MINI COMBinate ARTICULATE CU TRINCHETĂ



PIESE DISPONIBILE

REF.	mm				€	REF.	mm				€
15328	8	0.05	12	96	6,00€	15334	14	0.11	12	96	7,00€
15329	9	0.05	12	96	5,50€	15335	15	0.13	12	96	7,50€
15330	10	0.05	12	96	5,50€	15336	16	0.14	12	96	8,00€
15331	11	0.07	12	96	5,50€	15337	17	0.16	12	96	8,50€
15332	12	0.09	12	96	6,00€	15338	18	0.18	12	96	9,00€
15333	13	0.10	12	96	6,50€	15339	19	0.20	12	96	9,50€

15122

74,00€



MODUL EVA CARBON CU 12 CHEI COMBinate CU CLICHET



PIESE DISPONIBILE

REF.	mm				€	REF.	mm				€
13465	8	0.05	10	100	5,55€	13471	14	0.11	10	100	6,90€
13466	9	0.06	10	100	5,55€	13472	15	0.13	10	100	7,25€
13467	10	0.10	10	100	6,00€	13473	16	0.15	10	100	8,10€
13468	11	0.08	10	100	6,25€	13474	17	0.19	10	100	8,70€
13469	12	0.09	10	100	6,25€	13475	18	0.22	10	100	9,10€
13470	13	0.10	10	100	6,60€	13476	19	0.22	10	100	9,60€

53018

119,00€



SET DE 6 CHEI CU CLICHET ȘI CAP ROTATIV

8x9, 10x11, 12x13,
14x15, 16x18, 17x19mm

PIESE DISPONIBILE

REF.	mm	kg	dm³	mm	€
13447	8x9	0.10	6	36	16,50€
13448	10x11	0.15	6	36	17,50€
13449	12x13	0.25	6	36	20,00€

REF.	mm	kg	dm³	mm	€
13450	14x15	0.30	6	36	23,00€
13451	16x18	0.35	6	24	28,00€
13452	17x19	0.40	6	24	29,50€



54110

46,00€

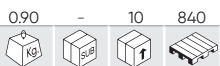

SET DE 8 CHEI COMBinate CU CLICHET SCURTE

10, 11, 12, 13, 14,
15, 17, 19mm

PIESE DISPONIBILE

REF.	mm	kg	dm³	mm	€
13491	10	0.05	10	100	5,30€
13492	11	0.06	10	100	5,35€
13493	12	0.07	10	100	5,50€
13494	13	0.08	5	100	6,00€

REF.	mm	kg	dm³	mm	€
13495	14	0.09	10	100	6,40€
13496	15	0.12	10	100	6,60€
13497	17	0.14	10	100	7,50€
13498	19	0.19	10	100	8,50€



54041

198,00€



SET DE 22 CHEI COMBinate CU RATCHET

6, 7, 8, 9, 10, 11, 12, 13, 14, 15, 16,
17, 18, 19, 20, 21, 22, 23, 24,
27, 30, 32mm

PIESE DISPONIBILE

REF.	mm	kg	dm³	mm	€
13463	6	0.03	10	100	5,30€
13464	7	0.04	10	100	5,30€
13465	8	0.05	10	100	5,55€
13466	9	0.06	10	100	5,55€
13467	10	0.10	10	100	6,00€
13468	11	0.08	10	100	6,25€
13469	12	0.09	10	100	6,25€
13470	13	0.10	10	100	6,60€
13471	14	0.11	10	100	6,90€
13472	15	0.13	10	100	7,25€
13473	16	0.15	10	100	8,10€

REF.	mm	kg	dm³	mm	€
13474	17	0.19	10	100	8,70€
13475	18	0.22	10	100	9,10€
13476	19	0.22	10	100	9,60€
13477	20	0.23	6	60	9,85€
13478	21	0.37	6	60	12,20€
13479	22	0.37	6	60	13,10€
13480	23	0.37	6	48	15,50€
13481	24	0.53	6	48	15,80€
13482	27	0.60	6	24	22,10€
13483	30	0.80	6	24	25,50€
13484	32	1.12	6	24	27,20€



54079

83,00€

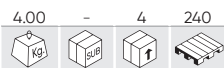

SET 21 CHEI COMBinate

21 PCS 6, 7, 8, 9, 10, 11, 12, 13, 14, 15, 16, 17, 18, 19, 20, 21, 22, 24, 27, 30, 32mm

PIESE DISPONIBILE

REF.	mm	kg	sub	mm	€
10531	10	0.05	10	100	3,00€
10532	11	0.06	10	100	2,70€
10533	12	0.07	10	100	3,00€
10534	13	0.08	10	100	3,25€
10535	14	0.10	10	100	3,50€
10536	15	0.10	10	100	3,65€
10537	16	0.11	10	100	3,90€
10538	17	0.14	10	100	4,30€
10539	18	0.16	10	100	4,75€

REF.	mm	kg	sub	mm	€
10540	19	0.20	10	100	5,25€
10541	20	0.21	6	60	5,55€
10542	21	0.25	-	50	5,85€
10543	22	0.25	-	50	7,00€
10544	24	0.33	10	100	8,10€
10545	27	0.41	10	50	9,75€
10546	30	0.52	-	25	11,60€
10547	32	0.59	-	25	13,50€
10548	6	0.03	10	100	1,75€



REF.	mm	kg	sub	mm	€
10549	7	0.03	10	100	2,00€
10550	8	0.03	10	100	2,15€
10551	9	0.04	10	100	2,15€

54097

38,90€

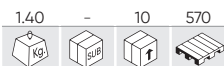

SET DE 14 CHEI COMBinate

14 PCS CrV 6, 7, 8, 9, 10, 11, 12, 13, 14, 15, 16, 17, 18, 19 mm

PIESE DISPONIBILE

REF.	mm	kg	sub	mm	€
10531	10	0.05	10	100	3,00€
10532	11	0.06	10	100	2,70€
10533	12	0.07	10	100	3,00€
10534	13	0.08	10	100	3,25€
10535	14	0.10	10	100	3,50€
10536	15	0.10	10	100	3,65€
10537	16	0.11	10	100	3,90€

REF.	mm	kg	sub	mm	€
10538	17	0.14	10	100	4,30€
10539	18	0.16	10	100	4,75€
10540	19	0.20	10	100	5,25€
10548	6	0.03	10	100	1,75€
10549	7	0.03	10	100	2,00€
10550	8	0.03	10	100	2,15€
10551	9	0.04	10	100	2,15€



54120

59,00€



SET DE 7 CHEI COMBinate

7 PCS CrV

20, 21, 22, 24, 27, 30, 32mm



PIESE DISPONIBILE

REF.	mm	kg	sub	mm	€
10541	20	0.21	6	60	5,55€
10542	21	0.25	-	50	5,85€
10543	22	0.25	-	50	7,00€
10544	24	0.33	10	100	8,10€

REF.	mm	kg	sub	mm	€
10545	27	0.41	10	50	9,75€
10546	30	0.52	-	25	11,60€
10547	32	0.59	-	25	13,50€

54174

139,00€



SET DE 6 CHEI COMBinate

6 PCS CrV XL

34, 36, 38, 41, 46, 50mm



PIESE DISPONIBILE

REF.	mm	kg	sub	mm	€
16020	34	0.36	10	100	17,00€
16021	36	0.00	10	100	19,50€
16022	38	0.43	10	100	23,00€

REF.	mm	kg	sub	mm	€
16023	41	0.47	10	100	26,50€
16024	46	0.51	10	100	34,50€
16025	50	0.58	10	100	37,50€

SCULE DE MÂNĂ

50564

30,00€

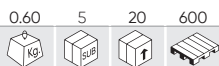

SET DE 8 CHEI COMBINATE SCURTE



PIESE DISPONIBILE

REF.	mm	Kg	SUB	mm	€	REF.	mm	Kg	SUB	mm	€	REF.	mm	Kg	SUB	mm	€
10564	10	0.05	10	100	2,50€	10567	13	0.05	10	100	3,50€	10570	17	0.10	10	100	4,50€
10565	11	0.05	10	100	3,50€	10568	14	0.05	10	100	4,00€	10571	19	0.15	10	100	5,00€
10566	12	0.05	10	100	3,50€	10569	15	0.05	10	100	4,50€						



54150

23,50€

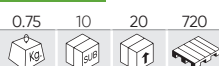

SET DE 7 CHEI FIXE

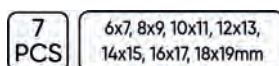

PIESE DISPONIBILE

REF.	mm	Kg	SUB	mm	€	REF.	mm	Kg	SUB	mm	€
10579	10x11	0.06	10	100	3,00€	10583	18x19	0.19	10	100	4,15€
10580	12x13	0.07	10	100	3,10€	10589	6x7	0.03	10	100	2,00€
10581	14x15	0.10	10	100	3,40€	10590	8x9	0.04	10	100	2,40€
10582	16x17	0.14	10	100	4,00€						



54149

60,00€



SET DE 12 CHEI FIXE

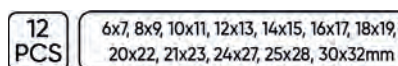

PIESE DISPONIBILE

REF.	mm	Kg	SUB	mm	€	REF.	mm	Kg	SUB	mm	€
10579	10x11	0.06	10	100	3,00€	10585	21x23	0.31	-	50	6,75€
10580	12x13	0.07	10	100	3,10€	10586	24x27	0.35	10	100	7,60€
10581	14x15	0.10	10	100	3,40€	10587	25x28	0.36	-	50	9,80€
10582	16x17	0.14	10	100	4,00€	10588	30x32	0.54	-	25	10,50€
10583	18x19	0.19	10	100	4,15€	10589	6x7	0.03	10	100	2,00€
10584	20x22	0.25	6	60	5,05€	10590	8x9	0.04	10	100	2,40€



52973

59,00€



SET DE 12 CHEI FIXE - FINISAJ LUCIOS

PIESE DISPONIBILE

REF.	mm	Kg	SUB	mm	€	REF.	mm	Kg	SUB	mm	€
10579	10x11	0.06	10	100	3,00€	10585	21x23	0.31	-	50	6,75€
10580	12x13	0.07	10	100	3,10€	10586	24x27	0.35	10	100	7,60€
10581	14x15	0.10	10	100	3,40€	10587	25x28	0.36	-	50	9,80€
10582	16x17	0.14	10	100	4,00€	10588	30x32	0.54	-	25	10,50€
10583	18x19	0.19	10	100	4,15€	10589	6x7	0.03	10	100	2,00€
10584	20x22	0.25	6	60	5,05€	10590	8x9	0.04	10	100	2,40€



6x7, 8x9, 10x11, 12x13, 14x15, 16x17, 18x19, 20x22, 21x23, 24x27, 25x28, 30x32mm



54115 26,80€

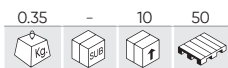

SET DE 4 CHEI TORX LATE

4 PCS E6xE8, E10xE12, E14xE18, E20xE24



PIESE DISPONIBILE

REF.	mm				€
16546	E6xE8	0.05	10	100	5,00€
16547	E10xE12	0.07	10	100	5,50€
16548	E14xE18	0.08	10	100	9,00€
16549	E20xE24	0.09	10	100	14,00€

54081 28,00€

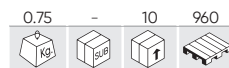

SET DE CHEI HEXAGONALE CU CAPĂȚUL DESCHIS, 6 FEȚE

5 PCS 10x11HEX, 12x13HEX, 14x15HEX, 16x17HEX, 18x19HEX



PIESE DISPONIBILE

REF.	mm				€
11258	10x11	0.10	5	100	7,30€
11259	12x13	0.10	5	100	8,30€
11260	14x15	0.11	5	100	9,75€
11261	16x17	0.18	5	100	11,35€
11262	18x19	0.21	-	100	13,50€

54159 47,00€



SET DE 8 CHEI INELARE SEMILUNĂ

8 PCS

6x7, 8x9, 10x11, 12x13, 14x15, 16x17, 18x19, 20X22mm



PIESE DISPONIBILE

REF.	mm				€
11639	6x7	0.61	5	50	4,00€
11640	8x9	0.04	5	50	4,50€
11641	10x11	0.04	5	50	5,00€
11642	12x13	0.06	5	50	5,00€
11643	14x15	0.09	5	-	6,00€
11644	16x17	0.12	5	50	7,00€
11645	18x19	0.15	5	50	7,00€
11646	20x22	0.22	5	-	9,45€

52451 42,00€



SET DE 8 CHEI DE TIP "C" CU CAP ROTUND SI 12 LATURI

8 PCS

6x7, 8x9, 10x11, 12x13, 14x15, 16x17, 18x19, 20X22mm



PIESE DISPONIBILE

REF.	mm				€
11639	6x7	0.61	5	50	4,00€
11640	8x9	0.04	5	50	4,50€
11641	10x11	0.04	5	50	5,00€
11642	12x13	0.06	5	50	5,00€
11643	14x15	0.09	5	-	6,00€
11644	16x17	0.12	5	50	7,00€
11645	18x19	0.15	5	50	7,00€
11646	20x22	0.22	5	-	9,45€

15156 70,00€



MODUL EVA DIN FIBRĂ DE CARBON CU 4 CHEI UNGHIULARE

PIESE DISPONIBILE

REF.	mm				€
15206	21x23	0.45	5	50	15,00€
15207	24x27	0.50	5	50	16,50€
15208	25x28	0.45	5	50	17,00€
15209	30x32	0.67	10	50	18,00€

4 PCS 21x23, 24x27, 25x28, 30x32mm



SCULE DE MÂNĂ

54119

78,00€

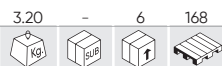

SET DE 12 CHEI INELARE CU COT 12 FEȚE

12 PCS



6x7, 8x9, 10x11, 12x13, 14x15, 16x17, 18x19, 20x22, 21x23, 24x27, 25x28, 30x32mm



PIESE DISPONIBILE

REF.	mm				€	REF.	mm				€
10627	6x7	0.04	10	100	2,80€	10633	18x19	0.22	10	100	6,60€
10628	8x9	0.06	10	100	3,10€	10634	20x22	0.43	-	50	7,80€
10629	10x11	0.08	10	100	3,65€	10635	21x23	0.30	-	50	8,15€
10630	12x13	0.11	10	100	3,90€	10636	24x27	0.35	-	25	8,80€
10631	14x15	0.14	10	100	4,20€	10637	25x28	0.48	6	24	12,10€
10632	16x17	0.18	10	100	5,30€	10638	30x32	0.73	6	24	12,70€

50562

23,50€

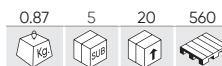

SET DIN 7 CHEI INELARE DUBLU COTITĂ

7 PCS



6x7, 8x9, 10x11, 12x13, 14x15, 16x17, 18x19mm



PIESE DISPONIBILE

REF.	mm				€	REF.	mm				€
10627	6x7	0.04	10	100	2,80€	10631	14x15	0.14	10	100	4,20€
10628	8x9	0.06	10	100	3,10€	10632	16x17	0.18	10	100	5,30€
10629	10x11	0.08	10	100	3,65€	10633	18x19	0.22	10	100	6,60€
10630	12x13	0.11	10	100	3,90€						

51528

49,00€



SET DE 14 CHEI TUBULARE CU COT TIP "L"

14 PCS



8, 9, 10, 11, 12, 13, 14, 15, 16, 17, 18, 19, 20, 21mm



PIESE DISPONIBILE

REF.	mm				€	REF.	mm				€
10591	10	0.09	10	200	2,50€	10598	17	0.32	10	60	4,60€
10592	11	0.12	10	200	2,55€	10599	18	0.43	10	40	6,00€
10593	12	0.16	10	120	3,15€	10600	19	0.41	10	40	6,25€
10594	13	0.17	10	100	3,20€	10601	20	0.45	10	30	6,50€
10595	14	0.20	10	100	3,35€	10602	21	0.47	10	30	7,05€
10596	15	0.25	10	70	4,25€	10603	8	0.07	10	300	2,10€
10597	16	0.30	10	70	4,50€	10604	9	0.08	10	200	2,25€

53420

72,00€



SET DE 8 TUBULARE

8 PCS



6x7, 8x9, 10x11, 12x13, 14x15, 16x17, 18x19, 20x22mm



53979

34,60€

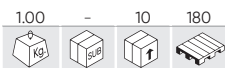

SET DE 8 ȘURUBELNIȚE TORX ÎN "T"



T10x75, T15x75, T20x100, T25x100, T30x150, T40x150, T45x200, T50x200mm



53980

34,60€

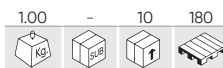

SET DE 8 CHEI IMBUS ÎN "T"



H2x100, H2.5x100, H3x100, H4x150, H5x150, H6x200, H8x200, H10x200

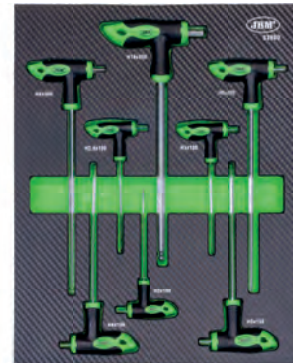

SET DE 6 CHEI INELARE EXTRALUNGI

51864

64,00€

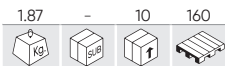

10x11mm (290mmL), 12x14mm (330mmL), 13x15mm (368mmL), 16x18mm (407mmL), 17x19mm (407mmL), 22x24mm (430mmL)



52912

91,00€

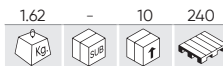

E6xE7 (200mmL), E8xE10 (235mmL), E11xE12 (290mmL), E14xE16 (370mmL), E18xE20 (410mmL), E22xE24 (420mmL)



PIESE DISPONIBILE

REF.	mm	kg	box	set	€	REF.	mm	kg	box	set	€
11244	10x11	0.13	5	100	8,50€	11247	16x18	0.30	6	36	14,00€
11245	12x14	0.18	10	50	9,15€	11248	17x19	0.31	10	36	14,60€
11246	13x15	0.25	6	36	12,40€	11249	22x24	0.43	5	-	26,50€

SET DIN 9 DUZE

TORX

REF.	mm	DESCRIERE	kg	box	set	€	
53737	90-218mm	SET DE 9 CHEI TORX (EXTRA LUNGI)	0.42	10	40	1000	12,50€
53739	86-150mm	SET DE 9 DUZE TORX (ÎNALTE)	0.32	10	40	960	10,50€
53955	72-170mm	SET DE 9 DUZE TORX (SCURTE)	0.25	10	40	1480	10,00€



T10, T15, T20, T25, T27, T30, T40, T45, T50



HEXAGONALE

REF.	mm	DESCRIERE	kg	box	set	€	
53738	90-220mm	SET DE 9 DUZE HEXAGONALE (EXTRA LUNG)	0.45	10	40	1000	10,90€
53740	72-170mm	SET DIN 9 DUZE HEXAGONALE (ÎNALTE)	0.37	10	40	960	9,10€
53954	43-97mm	SET DE 9 DUZE HEXAGONALE (SCURTE)	0.25	10	40	1480	8,50€



1,5, 2, 2,5, 3, 4, 5, 6, 8, 10mm

SCULE DE MÂNĂ

51659

59,00€



SET DE CHEI ARTICULATE CU TUBULARĂ INELARĂ CU 6 PIESE

6 PCS



8x9, 10x11, 12x13,
14x15, 16x17, 18x19mm



PIESE DISPONIBILE

REF.	mm				€
10621	8-9	0.09	10	100	9,50€
10622	10-11	0.13	10	100	10,00€
10623	12-13	0.16	5	100	12,60€

50622

64,00€



SET DE CHEI ARTICULATE CU TUBULARĂ TORX CU 4 PIESE

4 PCS



E6 x E8, E10 x E12,
E14 x E18, E20 x E24



PIESE DISPONIBILE

REF.	mm				€
10617	E6x E8	0.07	10	100	14,10€
10618	E10x E12	0.11	10	100	15,10€
10619	E14x E18	0.20	10	100	15,70€
10620	E20x E24	0.34	10	100	16,20€

54187

39,30€



SET DE 10 CHEI CROWFOOT 3/8"

PIESE DISPONIBILE

REF.	mm				€
16010	10	0.04	10	100	4,00€
16011	11	0.04	10	100	4,00€
16012	13	0.04	10	100	4,00€
16013	14	0.05	10	100	4,50€
16014	15	0.05	10	100	4,50€

REF.	mm				€
16015	16	0.05	10	100	5,00€
16016	17	0.05	10	100	5,00€
16017	18	0.06	10	100	5,00€
16018	19	0.06	10	100	5,50€
16019	22	0.08	10	100	6,00€

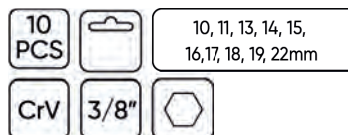

UNELTE ÎN ÎNCH-ȚOLI

51890

92,00€



SET DE 17 CHEI COMBinate ÎN ȚOLI

17 PCS

5/16, 3/8, 7/16, 1/2, 9/16, 19/32,
5/8, 11/16, 3/4, 13/16, 7/8, 15/16,
1", 1 1/16, 1 1/8, 1 3/16, 1 1/4



54005

14,00€

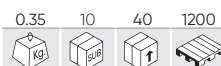

SET DE 9 IMBUSURI HEXAGONALE ÎN ȚOLI

9 PCS

CrV



1/16", 5/64", 3/32", 1/8",
5/32", 3/16", 1/4", 5/16", 3/8"

72-170mm



54106

89,00€

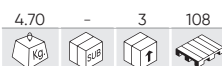

TRUSĂ DE SCULE DE 37 DE PIESE ZINCATĂ ÎN ÎNCH

37 PCS

CrV

1/2"

1/4"



CHEIE ÎN CRUCE LEGĂTURA SUDATĂ

51661 12,00€

1.17 5 20 360

1/2" 355mm

17, 19, 21mm

52880 42,00€

3.75 - 5 120

3/4" 700mm

24, 27, 32mm

52881 17,00€

1.40 - 10 480

1/2" 400mm

17, 19, 21, 22mm

51416 12,00€

1.05 10 20 360

CHEIE EXTENSIBILĂ PENTRU ROȚI CU TUBULARĂ REVERSIBILĂ 330-490MM

1/2"

17/19mm
21/23mm

CHEIE ENGLEZĂ

MODEL 1

REF.	DESCRIERE		mm					€
51798	CHEIE ENGLEZĂ 18"		53mm 450mm	1.90	3	12	480	39,60€
52424	CHEIE ENGLEZĂ 24"		62mm 610mm	3.75	-	5	350	64,00€



MODEL 2

REF.	DESCRIERE		mm					€
51795	CHEIE ENGLEZĂ 8"		22mm 200mm	0.28	6	60	3600	9,00€
51796	CHEIE ENGLEZĂ 10"		28mm 250mm	0.48	6	36	2400	14,00€
51797	CHEIE ENGLEZĂ 12"		37mm 300mm	0.71	6	24	960	18,00€



MODEL 3

REF.	DESCRIERE		mm					€
53639	CHEIE ENGLEZĂ 6"		28mm 150mm	0.15	6	96	576	28,60€
53640	CHEIE ENGLEZĂ 8"		30mm 200mm	0.28	6	72	504	34,40€
53641	CHEIE ENGLEZĂ 10"		33mm 250mm	0.50	6	36	1151	41,00€
53642	CHEIE ENGLEZĂ 12"		40mm 300mm	0.83	6	10	1200	54,00€
53643	CHEIE ENGLEZĂ 16"		52mm 400mm	1.53	-	12	336	92,00€
54098	CHEIE ENGLEZĂ 20"		65mm 640mm	2.70	-	6	-	158,50€



53654 81,00€

1.40 - 5 200

SET DE CHEI FIXE DE TIP CÂRLIG

8 PCS 35-60, 60-90, 90-120mm

160mm 177mm 250mm

CHEIE ȚEVI STILLSON

REF.	DESCRIERE		"					€
52235	CHEIE ȚEVI STILLSON 300MM	50mm	12"	0.90	6	24	1140	11,00€
52236	CHEIE ȚEVI STILLSON 350MM	60mm	14"	1.09	6	24	760	13,30€
52237	CHEIE ȚEVI STILLSON 450MM	70mm	18"	1.75	4	12	720	18,10€
52238	CHEIE ȚEVI STILLSON 600MM	75mm	24"	2.50	2	8	600	24,90€
53210	CHEIE ȚEVI STILLSON 915MM	110mm	36"	4.95	-	4	96	48,00€

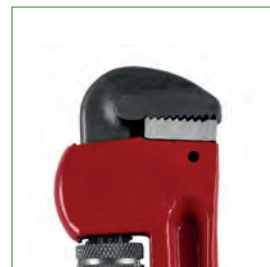

CHEIE STILLSON ALUMINIO

REF.	DESCRIERE		mm					€
53070	CHEIE STILLSON ALUMINIO 12"	45mm	270mm	0.68	6	24	900	16,20€
53071	CHEIE STILLSON ALUMINIO 14"	50mm	320mm	0.92	4	12	900	26,10€
53072	CHEIE STILLSON ALUMINIO 18"	65mm	410mm	1.35	4	12	900	31,60€
53073	CHEIE STILLSON ALUMINIO 24"	75mm	540mm	2.05	2	8	1000	50,00€



MENGHINĂ DE MÂNĂ

REF.	DESCRIERE					€
52349	MENGHINĂ DE MÂNĂ 90X200MM	1.25	-	10	480	22,10€
52350	MENGHINĂ DE MÂNĂ 90X300MM	1.41	-	10	540	22,60€
52351	MENGHINĂ DE MÂNĂ 90X400MM	1.60	-	10	480	25,40€
52352	MENGHINĂ DE MÂNĂ 120X300MM	1.99	-	10	360	32,40€
52353	MENGHINĂ DE MÂNĂ 120X400MM	2.10	-	10	350	33,40€
52354	MENGHINĂ DE MÂNĂ 120X500MM	2.41	-	6	300	34,40€
52355	MENGHINĂ DE MÂNĂ 120X600MM	2.62	-	4	300	36,60€
52357	MENGHINĂ DE MÂNĂ 150X800MM	4.60	-	5	125	54,00€
52358	MENGHINĂ DE MÂNĂ 150X1000MM	5.35	-	5	120	63,00€



CLICHET CU 72 DINȚI 1/2" CU SET TUBULARE





REF.	DESCRIERE					€
54028	CLICHET CU 72 DINȚI - 1/2" CU SET TUBULARE HEX.	1.30	4	24	432	28,00€
54029	CLICHET CU 72 DINȚI - 1/2" CU SET TUBULARE 12 FEȚE	1.25	4	24	432	28,00€
54030	CLICHET CU 72 DINȚI - 1/4" CU SET TUBULARE HEX.	0.35	6	36	1008	18,80€
54031	CLICHET CU 72 DINȚI - 1/4" CU SET TUBULARE 12 FEȚE	0.35	6	36	864	19,30€



54028 - 54029	10, 11, 12, 13, 14, 15, 16, 17, 18, 19mm
54030 - 54031	4, 5, 6, 7, 8, 9, 10, 11, 12, 13mm

CLICHET





CROMAT

REF.	DESCRIERE					€
54022	CLICHET CU 72 DINȚI - 1/4" 145MM CROMAT	0.15	12	36	1440	9,95€
54023	CLICHET CU 72 DINȚI - 3/8" 200MM CROMAT	0.30	12	24	1440	13,50€
54024	CLICHET CU 72 DINȚI - 1/2" 255MM CROMAT	0.60	12	24	960	17,90€



PREZENTAT ÎNTR-UN EXPOZANT DE 12 UNITĂȚI





ZINCAT

REF.	DESCRIERE					€
54018	CLICHET CU 72 DINȚI - 1/4" 145MM ZINCATĂ	0.15	12	36	1440	9,85€
54019	CLICHET CU 72 DINȚI - 1/2" 255MM ZINCATĂ	0.60	12	24	864	17,90€
54021	CLICHET CU 72 DINȚI - 3/8" 200MM ZINCATĂ	0.60	12	24	1440	13,50€



PREZENTAT ÎNTR-UN EXPOZANT DE 12 UNITĂȚI



CLICHET CU 72 DINȚI

REF.	DESCRIERE					€
54083	CLICHET CU MÂNER DREPT CU 72 DINȚI - 1/4"	0.14	12	24	2592	9,75€
54084	CLICHET CU MÂNER DREPT CU 72 DINȚI - 3/8"	0.30	12	24	1440	13,10€
54085	CLICHET CU MÂNER DREPT CU 72 DINȚI - 1/2"	0.60	12	24	960	17,80€



PREZENTAT ÎNTR-UN EXPOZANT DE 12 UNITĂȚI

CLICHET DREPT COMPACT CU 72 DE DINȚI

REF.	DESCRIERE					€
54086	CLICHET DREPT COMPACT CU 72 DINȚI 1/4	0.10	12	24	2592	9,25€
54087	CLICHET DREPT COMPACT CU 72 DINȚI - 1/2"	0.50	12	24	1008	17,30€



PREZENTAT ÎNTR-UN EXPOZANT DE 12 UNITĂȚI

SCULE DE MÂNĂ

52197

36,30€

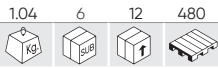

CLICHET ARTICULAT EXTENSIBIL DE 1/2" 72 DINȚI

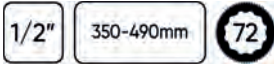

PREZENTAT ÎNTR-UN EXPOZANT DE 6 UNITĂȚI

52207

24,20€

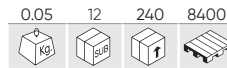

MINI CLICHET CU 72 DINȚI ZINCAT - 1/4" 85MM



PREZENTAT ÎNTR-UN EXPOZANT DE 12 UNITĂȚI

CLICHET ARTICULAT CU 72 DINȚI

REF.						€
52587	1/4" 172mm	0.16	12	144	3456	39,90€
52588	1/2" 172mm	0.17	12	144	3456	45,00€



PREZENTAT ÎNTR-UN EXPOZANT DE 12 UNITĂȚI



CLICHET ARTICULAT CU 72 DINȚI

REF.						€
51305	1/2" 175mm	0.31	12	48	816	28,90€
51306	1/4" 165mm	0.30	12	48	816	28,10€



PREZENTAT ÎNTR-UN EXPOZANT DE 12 UNITĂȚI



CLICHET 72 DINȚI CU CAP ROTATIV

REF.						€
51405	1/4" 145mm	0.58	12	24	-	21,10€
51406	1/2" 280mm	0.66	12	24	864	29,20€



PREZENTAT ÎNTR-UN EXPOZANT DE 12 UNITĂȚI



CLICHET EXTENSIBIL 72 DINȚI

REF.						€
51307	1/2" 305-445mm	0.92	6	12	360	29,70€
53346	1/4" 150-200mm	0.25	6	12	-	18,00€
54304	1/2" 450-610mm	1.15	-	6	480	26,00€



PREZENTAT ÎNTR-UN EXPOZANT DE 6 UNITĂȚI



CLICHET LUNG REVERSIBIL CU 72 DE DINȚI

REF.	DESCRIERE					€
53886	1/4" 305mm	0.27	10	40	1680	20,30€
53887	3/8" 457mm	0.68	10	20	700	30,30€
53888	1/2" 609mm	1.27	4	16	480	37,90€



PIESĂ DE SCHIMB

REF.	"					€
15147	3/8"	0.10	-	100	-	5,00€

REF.	"					€
15148	1/2"	0.20	-	100	-	5,00€

REF.	"					€
15149	1/4"	0.05	-	100	-	5,00€



51801

62,00€



CLICHET FLEXIBIL 72 DINȚI DE 3/8" 500MM



UTIL PENTRU LOCURI DE ACCES DIFICIL

CONTROL CU AJUTORUL MÂNERULUI

CU CAP GIRATORIU



53671

41,00€

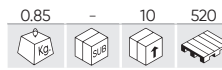

SET DE 3 CLICHEȚI MINI

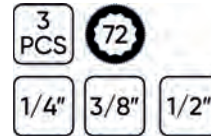

KIT DE REPARAȚII PENTRU CHEIE CU CLICHET

REF.	DESCRIERE				€
15138	1/4"	0.10	-	50	10,50€
15139	3/8"	0.15	-	50	12,00€
15140	1/2"	0.20	-	50	13,50€

54339

273,00€

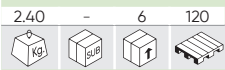

CHEIE DINAMOMETRICĂ DIGITAL 1/2" 10-200NM



N

52913

292,00€



CHEIE DINAMOMETRICĂ CU HEDER INTERSCHIMBABIL 200NM

	x1	1/2"
	x9	13, 14, 15, 17, 19, 22, 24, 27, 30mm
	x1	40-200Nm

- Inclusiv certificatul de calibrare de la producător.



1/2"

54269

56,00€



SET DE 21 BUC. CU CHEIE DINAMOMETRICĂ DE 1/4"

	x1	5-25Nm		x3	PH1, PH2, PH3
	x1	100mm		x8	H2, H2.5, H3, H4, H5, H6, H8, H10 (37mmL)
	x1	UNIVERSAL		x1	H5 (87mmL)
	x1	1/4" (F) - 3/8" (M)		x5	T10, T15, T20, T25, T30



1/4"

N

53972

550,00€

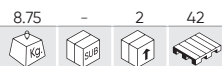

CHEIE DINAMOMETRICĂ 3/4"

200-800Nm
21.4-86.6M.Kg

1000-1210mm



- Inclusiv certificatul de calibrare de la producător.

CHEIE DINAMOMETRICĂ CU VIZOR

REF.	DESCRIERE					€
53081	1/4" 4-20NM (36T) 375mm	1.10	5	25	350	115,00€
53082	1/2" 40-210NM (24T) 560mm	1.90	4	8	168	148,00€

- Inclusiv certificatul de calibrare de la producător.



CHEI DINAMOMETRICE

REF.	DESCRIERE					€
51127	1/2" 28-210NM 470mm	1.70	4	8	256	56,00€
51262	1/4" 5-25NM 270mm	0.80	4	16	384	51,00€
51338	3/8" 19-110NM 365mm	1.05	4	16	384	53,00€



SET DE UNELTE

REF.	"					€	REF.	"					€	REF.	"					€
51127R	1/2"	0.15	-	20	-	14,00€	51262R	1/4"	0.05	-	20	-	14,00€	51338R	3/8"	0.05	-	20	-	14,00€



51830

94,00€



ȘURUBELNIȚĂ DINAMOMETRICĂ MECANICĂ

- Exactitate: CW: +/- 4%
- Rang de operație: 2-10 N-m
- Unități de selecție: N-m, in-lb.
- Lung (mm): 242
- Pătrat: 1/4"
- Viață utilă: 2000 cilcuri

- Inclusiv certificatul de calibrare de la producător.



TIJĂ DE MANIPULARE CU CAP MOBIL

REF.	DESCRIERE					€
53468	1/2" 250mm	0.35	6	48	600	8,50€
53478	1/4" 115mm	0.50	5	100	1200	4,55€
53479	3/8" 200mm	0.15	5	50	300	6,40€
53480	3/4" 460mm	1.35	5	10	440	19,90€
53481	1" 550mm	2.85	-	5	300	27,40€



BARĂ "T" DE FORȚĂ

REF.	DESCRIERE						€
52524	3/4" 1020mm	3.60	3	6	144		51,00€
52526	1/2" 600mm	1.65	5	10	600		28,40€
52525	1/2" 430mm	0.85	10	20	1500		13,80€



PIESĂ DE SCHIMB

REF.	"					€
11945	1/2"	0.15	25	100	-	7,00€

PENTRU 52526

REF.	"					€
11946	1/2"	0.06	25	300	-	4,50€

PENTRU 52525

REF.	"					€
11947	3/4"	0.51	10	40	960	19,00€

PENTRU 52524



54343

31,00€

1.15	-	6	594

1/2"	450-600 mm		N
------	------------	--	---

BARĂ DE DISRUPTOR EXTENSIBILĂ 1/2" 450-600 MM



51479

31,80€

0.65	12	24	1056

1/2"	260-410mm
------	-----------

PRELUNGITOR EXTENSIBIL DE 1/2" CU CAP SEMIROTUND

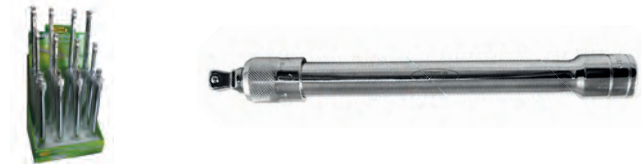

PREZENTAT ÎNTR-UN EXPOZANT DE 12 UNITĂȚI

51805

17,00€

0.33	4	20	640

SET DE PRELUNGITOARE 1/4" CU CAP SEMIROTUND

1/4"	50, 75, 100, 152, 227mm	
------	-------------------------	--

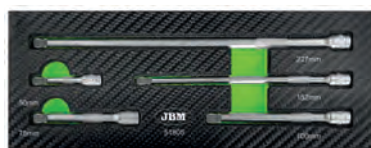

51447

16,00€

0.34	5	20	960

MODUL DE PRELUNGITOARE DE 1/4" CU CAP NORMAL

1/4"	50, 75, 100, 152, 227mm	
------	-------------------------	--



51448

52,00€

2.38	-	5	300

MODUL DE PRELUNGITOARE 1/2" CU CAP SEMIROTUND

1/2"	50, 125, 250, 380, 510mm	
------	--------------------------	--



PIESE DISPONIBILE

REF.	mm				€
12995	50	0.03	5	100	7,00€
12996	75	0.04	20	100	7,00€
12997	100	0.06	20	100	7,50€
12998	152	0.08	5	100	9,00€
12999	227	0.11	5	100	9,50€

PIESE DISPONIBILE

REF.	mm				€
14026	50	0.03	10	100	5,50€
14027	75	0.04	-	50	5,60€
10264	100	0.05	10	100	2,00€
14029	152	0.07	-	50	8,50€
14030	227	0.11	-	50	9,50€

PIESE DISPONIBILE

REF.	mm				€
14978	50	0.10	5	100	7,50€
14979	125	0.20	5	50	9,00€
14980	250	0.40	5	25	13,00€
14981	380	0.60	5	20	22,50€
14982	510	0.60	5	10	27,50€

54302

11,50€

0.45	10	40	650

SET DE 6 ȘURUBELNIȚE DE PRECIZIE

6 PCS	CrV		
-------	-----	--	--

	+ x3 PH00, PH0, PH1
	- x3 SL2, SL3, SL4



N

SCULE DE MÂNĂ

52500

19,00€

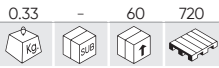

SET DE 8 ȘURUBELNIȚE SCURTE

8
PCS



INCLUDE

- x3 PH00x25, PH0x25, PH1x25
- x5 SL0.4x2x25, SL0.4x2.5x25, SL0.5x3x.25, SL0.5x3.5x25, SL0.8x4x25

53917

9,00€

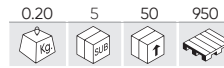

SET DE 7 ȘURUBELNIȚE LUNGI

7
PCS



INCLUDE

- x3 PH00, PH0, PH1
- x4 SL.1.4, SL2.0, SL.2.4, SL3.0

53694

18,40€

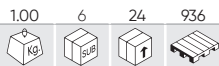

ȘURUBELNIȚĂ DE IMPACT 1/2"

8
PCS CrV 1/2"



INCLUDE

- x1 1/2"
- x3 PH 2x36mm, 3x36mm, 3x70mm
- x3 SL 7x36mm, 8x36mm, 8x70mm

54126

39,00€

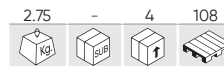

SET DE ȘURUBELNIȚE DE IMPACT MAGNETICE

12
PCS GO-THROUGH



INCLUDE

- x6 PH0x75mm, PH1x75mm, PH2x38mm, PH2x100mm, PH3x125mm, PH4x200mm
- x6 SL3.2x75mm, SL5x75mm, SL6x38mm, SL6x100mm, SL8x150mm, SL9.5x200mm

53010

18,00€

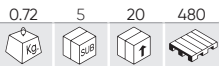

SET DE ȘURUBELNIȚE CU MÂNERE INTERSCHIMBABILĂ

11
PCS



INCLUDE

- x2 PH1, PH2
- x2 4x6, 5x7mm
- x3 T10x15, T20x25, T30x40
- x3 H4x4mm, H5x5mm, H6x6mm
- x1

50902

13,00€



SET DE 4 ȘURUBELNIȚE LATE DE IMPACT

4
PCS 3", 4", 6", 8"



ȘURUBELNIȚE STELATE CU MODUL DE CARBON EVA

53943

21,50€

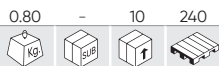

- PH4x200, PH3x150, PH2x100, PH2x38, PH1x80, PH0x120, PH1x100

53944

19,50€

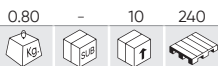

- SL9x200, SL4x125, SL5x100, SL5x80, SL6x38, SL6x100, SL8x150mm

53945

18,90€



- T8x75, T9x75, T10x75, T15x75, T20x75, T25x100, T27x100

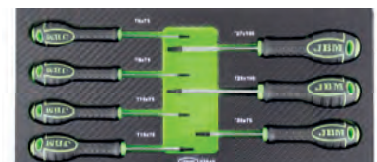
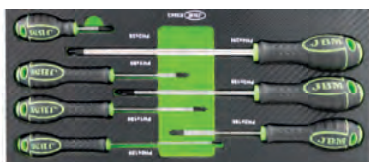

54060 6,00€

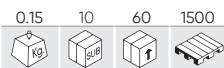

ȘURUBELNIȚĂ REVERSIBILĂ LATĂ - INELARĂ 6X150MM



54061 6,00€

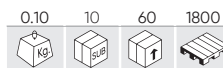

ȘURUBELNIȚĂ REVERSIBILĂ LATĂ - INELARĂ 6X100MM

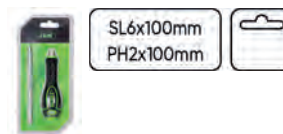

54071 26,50€



SET DE 6 ȘURUBELNIȚE ȘOC (3 CRUCE + 3 PLATE)



INCLUDE

- ⊕ x3 PH3x150, PH2x100, PH1x75mm
- ⊖ x3 SL8x150, SL6.5x100, SL5.5x75mm

54070 18,00€



SET DE 6 ȘURUBELNIȚE (2 CRUCE + 4 PLATE)



INCLUDE

- ⊕ x2 PH1x80, PH2x100mm
- ⊖ x4 SL6.5x150, SL5.5x125, SL4x100, SL3x80mm

52170 16,00€



ȘURUBELNIȚĂ FLEXIBILĂ

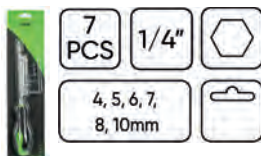

52169 25,00€



SET DE 3 ȘURUBELNIȚE FLEXIBILE

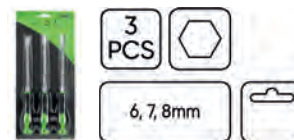

53575 16,00€



ȘURUBELNIȚĂ FLEXIBILĂ



- x3 1/4" 4 mm
- 5 mm
- 7 mm

SCULE DE MÂNĂ

53225

3,50€

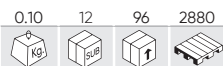

MAGNETIZATOR/DEMAGNETIZATOR



51812

46,00€



SET DE 5 CLEȘTI



INCLUDE

A	x1	160mm
B	x1	160mm
C	x1	180mm
D	x1	200mm
E	x1	250mm

CLEȘTE DE SIGURANȚĂ VÂRF DREPT



INTERIOR

REF.	DESCRIERE					€
51018	7" 180mm	0.14	5	100	1800	7,05€
52964	9" 225mm	0.23	6	60	1440	9,45€
53549	13" 330mm	0.45	5	30	-	14,30€



EXTERIOR

REF.	DESCRIERE					€
51017	7" 180mm	0.17	5	100	1800	6,80€
52966	9" 225mm	0.28	6	60	1800	9,45€
53547	13" 330mm	0.50	5	30	-	14,70€



CLEȘTE DE SIGURANȚĂ VÂRF CURBAT



INTERIOR

REF.	DESCRIERE					€
51021	7" 180mm	0.16	5	100	-	7,05€
52965	9" 225mm	0.24	6	60	1440	9,20€
53550	13" 330mm	0.45	5	30	-	14,70€



EXTERIOR

REF.	DESCRIERE					€
51020	7" 180mm	0.13	5	100	1600	6,65€
52967	9" 225mm	0.24	6	60	1440	9,40€
53548	13" 330mm	0.50	5	30	-	15,60€



PATENT DE TĂIAT DIAGONAL

REF.	DESCRIERE					€
53905	6" 160mm	0.20	6	60	1440	7,30€
53906	7" 180mm	0.20	6	60	1560	8,65€



PATENT CU VÂRF ALUNGIT

REF.	DESCRIERE					€
53908	6" 160mm	0.15	6	60	1440	7,25€
53909	8" 200mm	0.20	6	60	1440	9,70€



PATENT UNIVERSAL

REF.	DESCRIERE						€
53911	6" 160mm	0.20	6	60	1440		8,80€
53967	8" 200mm	0.30	6	60	1440		10,20€
54015	7" 180mm	0.20	6	60	1920		10,20€



15454

35,40€

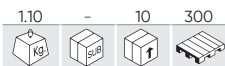

8"

MODUL CLEȘTI SEEGER EVA 8"

REF.	DESCRIERE						€
10526	CLEȘTE SEEGER INTERIOR VÂRF DREPT 8"	0.21	5	50	-		10,00€
10642	CLEȘTE SEEGER EXTERIOR VÂRF DREPT 8"	0.22	5	50	-		10,00€
10643	CLEȘTE SEEGER INTERIOR VÂRF CURBAT 8"	0.21	5	50	-		10,00€
10644	CLEȘTE SEEGER EXTERIOR VÂRF CURBAT 8"	0.22	5	50	-		10,00€



53389

31,50€



SET DE CLEȘTI SEEGER CU VÂRF INTERSCHIMBABIL



CLEȘTE REGLABIL TIP PAPAGAL

REF.								€
52052	515mm	140mm	1.88	5	10	400		53,00€
50567	250mm	40mm	0.34	10	60	1500		9,60€



52846

37,80€

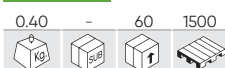

CLEȘTE EXTRALUNG SISTEM FOARFECĂ-DREPT

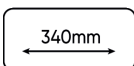

52847

41,00€



CLEȘTE EXTRALUNG SISTEM FOARFECĂ-CURBATĂ 45°

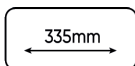

52272

24,60€



SET DE CLEȘTI CU VÂRF DE 0°, 45°, 90°



SCULE DE MÂNĂ

53390

34,50€

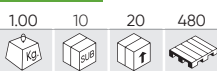

CLEȘTE PENTRU COLIERE ELASTICE



REF.	DESCRIERE					€
14180	SET DE PIESE DE SCHIMB PENTRU REFERINȚĂ 53390	0,01	-	100	-	7,90€

51995

24,50€



CLEȘTE PENTRU COLIERE ELASTICE



REF.	DESCRIERE					€
14179	SET DE PIESE DE SCHIMB PENTRU REFERINȚĂ 51995	0,01	-	100	-	8,50€

53396

18,30€

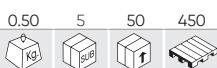

CLEȘTE PENTRU COLIERE ALE ȚEVILOR DE EȘAPAMENT

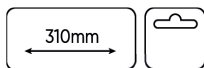

52791

18,00€

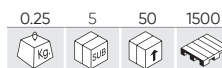

CLEȘTE PENTRU COLIERE CLICK-R

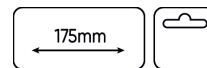

54376

12,00€



INSTRUMENT DE BANDARE ARTICULAȚIE CV CU CUTTER

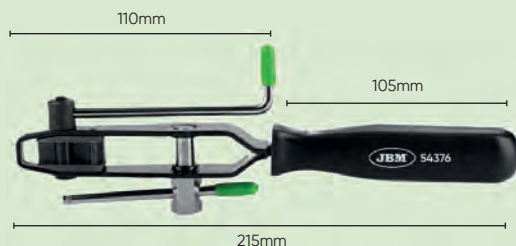
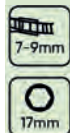

54311

13,00€



CLEȘTE PENTRU COLIERE TIP URECHE



54330

12,50€



CLEȘTE DE ETANȘARE A TIJEI DE SUPAPĂ

280 mm

OPEL, VW, FORD



54279

6,00€



CLEȘTE PT EXTRAȚIE DE BECURI

100°



54479

36,50€

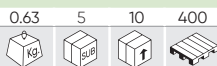

N

CLEȘTE PENTRU BENZI METALICE CU AUTOBLOCARE



52412

5,00€

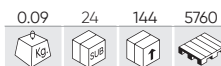

MINI CLEȘTE MULTIUTILIZATOR 105MM

INCLUDE

- x2 Șurubelnițe late
- x1 Șurubelniță stelată
- x1 Deschizător sticle
- x1 Deschizător conserve
- x1 Pila 25mm
- x1 Cuțit 40mm
- x1 Ferăstrău 40mm



52050

98,00€



SET DE CLEȘTI PENTRU COLIERE

PIESE DISPONIBILE

REF.	DESCRIERE	Kg	Sub	cm	mm	€
A 13707	CLEȘTE PENTRU COLIERE ELASTICE CU VÂRF ROTATIV	0.25	10	40	-	14,00€
B 13708	CLEȘTE PENTRU COLIERE ELASTICE	0.24	6	48	-	14,00€
C 13709	CLEȘTE PENTRU COLIERE ELASTICE CU VÂRF DREPT	0.24	6	48	576	14,00€
D 13710	CLEȘTE PENTRU COLIERE ELASTICE 45°	0.70	6	48	1536	14,00€
E 13712	CLEȘTE PENTRU EXTRAGEREA TUBURILOR	0.21	10	40	-	14,00€
F 51995	CLEȘTE PENTRU COLIERE ELASTICE	0.53	5	40	480	24,50€
G 52791	CLEȘTE PENTRU COLIERE CLICK-R	0.25	5	50	1500	18,00€



52619

23,10€



CLEȘTE PENTRU COLIERE TIP URECHE



Găuri de 1/2" în mână pentru a fi folosite ca cheie.
Uvertură: 0-20 mm



52812

65,00€



CLEȘTE PENTRU COLIERE TIP URECHE



Adaptor de 3/8" pentru strângere cu clichet.
Uvertură: 34 mm



53487

16,70€



PLIERS PENTRU CONDUCTE ALIMENTARE COMBUSTIBIL



52508

38,40€



CLEȘTE SPECIAL PENTRU FRÂNE



TAB ANTIBLOCARE

52509

36,20€



SCULE DE MÂNĂ

52625

9,00€

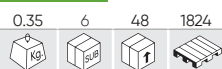

CLEȘTE DE FRÂNĂ CU TAMBUR



51355

19,00€



CLEȘTE SPECIAL PENTRU CONTRAGREUTĂ



52982

53,00€

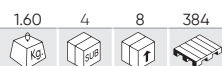

SET DE 3 CLEȘTE REGLABIL AUTOBLOCANT



53445

17,10€



SET DE CLEȘTI PENTRU DECONECTAREA CONDUCTEI PRINCIPALE DE COMBUSTIE



x1 5/16" Ø 8mm

x1 3/8" Ø 10mm

x1 APLICAȚIE SPECIALĂ



51972

12,00€



CLEȘTE PENTRU DEZIZOLAT CABLURI AUTOAJUSTABIL



0.25~2.5mm²

08-6mm



52152

13,50€



FOARFECĂ DE TĂIAT CABLU

ACERO INOXIDABLE
STAINLESS STEEL

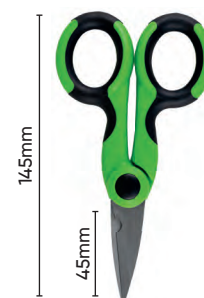

53411

5,00€

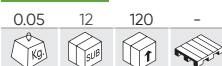

CLEȘTE MINI PT DEZMEMBRAREA CABLULUI



53412

4,00€



CLEȘTE MINI PT DEZMEMBRAREA CABLULUI



CLEȘTI MINI PT DEZMEMBRAREA CABLULUI

REF.	DESCRIERE					€
53602	360mm - Ø 125mm ²	0.60	-	5	300	30,50€
53603	550mm - Ø 250mm ²	1.75	-	5	300	45,00€
53604	800mm - Ø 500mm ²	3.70	-	5	120	118,00€



TĂIETOR DE TIJE

REF.	DESCRIERE					€
52955	12" - 300mm	0.77	-	20	200	19,80€
52956	14" - 350mm	0.95	-	20	200	19,60€
52957	18" - 450mm	1.47	-	10	360	23,80€
52958	24" - 600mm	2.40	-	8	210	28,20€
52959	30" - 750mm	3.78	-	5	100	42,00€
52960	36" - 900mm	5.15	-	5	105	46,00€



53385 19,30€

0.15 6 54 1026

CLEȘTE PENTRU EXTRAGEREA CLIPSURILOR DE PLASTIC DE CAROSERIE



53976 9,00€

0.20 6 60 1440

CLEȘTE SPECIAL PENTRU TERMINALE LUNG 6" - 160MM



52761 8,00€

0.25 12 72 1800

CLEȘTE DE SERTIZAT PENTRU TERMINALE IZOLATE ȘI NEIZOLATE 9"



53932 8,00€

0.25 12 72 1296

CLEȘTE DE SERTIZAT PENTRU TERMINALE IZOLATE ȘI NEIZOLATE 9"



52762 9,00€

0.25 12 72 1800

CLEȘTE DE SERTIZAT PENTRU TERMINALE NEIZOLATE 8-3/4"

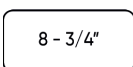

16111 19,20€

0.61 - 10 200

MODUL CLEȘTI DEZIZOLAT+TĂIAT CABLU PT. CĂRUȘIOARE EVA CU SCULE



SCULE DE MÂNĂ

54254

43,00€

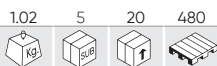

CLEȘTE TERMINAL CU VÂRF INTERSCHIMBABIL

7
PCS

INCLUDE

- CLEȘTE DE 9"
- VÂRF DE 0,15-6MM°
- VÂRF DE 10-35MM°
- VÂRF DE 0,5-6MM°

- VÂRF 0,5-10MM°
- VÂRF 0,5-4MM°
- ȘURUBELNITĂ PH2X150



54112

18,00€

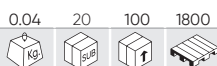

EXTRACTOR DE TERMINALE CU ȘASE CONECTOARE

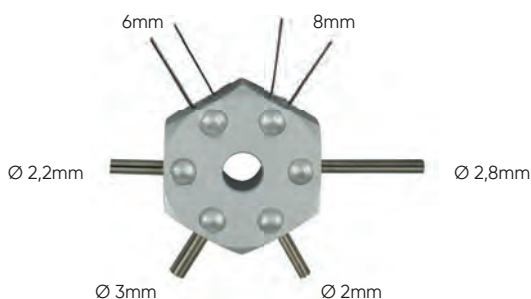

54142

15,20€



EXTRACTOR O-RING, SPATULĂ ȘI LEVIER PLAT (6 BUCĂȚI)

6
PCS

INCLUDE

- 2 vârfuri cu cârlig
- 2 vârfuri drepte
- 2 vârfuri înclinate
- 6 vârfuri cu părghii



RECUPERATOR FLEXIBIL

REF.	DESCRIERE	Ø	—					€
51525	RECUPERATOR FLEXIBIL CU MAGNET	A	7mm	500mm	0.14	10	60 960	9,80€
51526	RECUPERATOR FLEXIBIL VÂRF CU 4 GHEARE	B	20mm	500mm	0.10	12	144 2016	9,80€
52473	RECUPERATOR FLEXIBIL CU MAGNET ȘI LED	C	15mm	545mm	0.18	10	60 960	9,90€

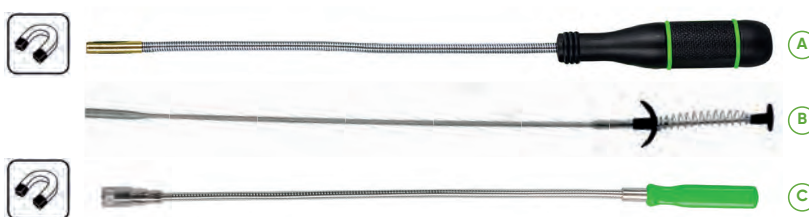

SCULE DE INSPECȚIE

REF.	DESCRIERE	Ø	—					€
51272	DISPOZITIV TELESCOPIC CU MAGNET ȘI LED	A	18mm	90-810mm	0.05	12	72 1512	7,50€
52472	RECUPERATOR EXTENSIBIL CU MAGNET	B	10mm	135-600mm	0.15	12	108 4320	4,90€
52468	OGLINDĂ DE INSPECȚIE TELESCOPICĂ ARTICULATĂ	C	50mm	280-445mm	0.09	12	48 1536	5,90€



15706

31,00€



MODUL DE INSTRUMENTE DE RIDICARE MAGNETIZATE – 5 BUC.



15799

28,30€

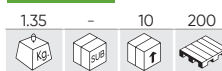

MODUL DE CIURGI EVA - FIBRĂ DE CARBON



CIOCANE PROFESIONALE CU MÂNER DIN FIBRĂ

REF.	DESCRIERE					€
52182	2Kg - 297mm	2.20	6	12	504	24,00€
52184	4Kg - 880mm	4.31	-	4	128	43,00€
52185	6Kg - 895mm	6.97	-	4	72	55,00€
52186	8Kg - 900mm	8.68	-	2	72	72,00€



CIOCAN DIN PLASTIC FĂRĂ RECUL

REF.	DESCRIERE					€
52425	Ø 40mm	0.70	6	12	768	33,30€
52426	Ø 60mm	1.50	2	12	288	52,00€
52427	Ø 70mm	2.02	2	12	204	64,00€



FEȚE DE SCHIMB P/ CIOCANUL DIN PLASTIC

REF.	mm					€	REF.	mm					€	REF.	mm					€
11212	Ø 40	0.02	5	100	-	5,00€	11213	Ø 60	0.08	5	50	-	10,60€	11214	Ø 70	0.11	5	50	-	12,50€



LĂCĂTUȘ CU MÂNER DIN LEMN

REF.	DESCRIERE					€
51674	505g	0.60	6	36	864	7,75€
52565	1000g	1.13	6	24	720	11,50€



CAP DREPT ȘI SEMIROTUND

REF.	DESCRIERE					€
51504	454g	0.55	4	40	800	8,50€
51918	1000g	1.25	6	18	648	12,50€



CIOCAN PROFESIONAL FĂRĂ RECUL

REF.	DESCRIERE					€
52180	1,35Kg - 355mm	1.45	6	12	432	19,00€
52181	1,80Kg - 370mm	1.81	6	12	300	22,50€
52183	2,20Kg - 405mm	2.30	6	12	288	26,20€



TOPOARE CU MÂNER DIN LEMN

REF.	DESCRIERE					€
52188	360mm	0.82	4	24	875	15,50€
52460	410mm	1.17	4	24	864	16,60€
52461	700mm	2.00	4	12	240	25,70€



SCULE DE MÂNĂ

52830

24,00€

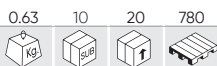

FERĂSTRĂU ARC CU MÂNER ERGONOMIC



PREZENTAT ÎNTR-UN EXPOZANT DE 10 UNITĂȚI

52831

18,00€

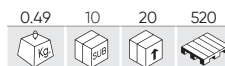

FERĂSTRĂU ARC



PREZENTAT ÎNTR-UN EXPOZANT DE 10 UNITĂȚI

REF. DESCRIERE

12060 LAME PT. FERĂSTRĂU ARC
REF.52830 + 52831 + 51675

0.02 100 800 - 2,50€

53591

5,50€

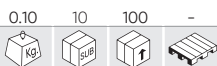

DISPOZITIV PENTRU ÎNDEPĂRTAREA IZOLAȚIEI DE PE FIRE

- Interval de tăiere: 8-28mm.
- Lungimea produsului: 170mm.
- Lungimea pânzei: 20mm.
- Adâncimea cărligului: 5mm.



52786

14,60€

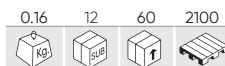

CUȚIT CU SISTEM PT. SPART GEAMURI ȘI TĂIAT CENTURI DE SIG.



PREZENTAT ÎNTR-UN EXPOZANT DE 12 UNITĂȚI

TAIETOR PENTRU TEAVĂ

REF.	DESCRIERE	kg	box	cm	mm	€
52878	3-32mm	0.22	10	50	1500	11,20€
52879	3-35mm	0.24	10	50	1500	10,10€
52877	Ø MAX: 42mm	0.43	6	48	624	15,80€
53517	Ø MAX: 30mm	0.13	10	60	600	9,50€



52885

18,00€

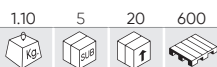

SET DE 12 PERFORATOARE - METRIC

12 PCS

3, 4, 5, 6, 7, 8, 9, 10,
12, 14, 16, 19mm



54331

27,00€



N

SET DE 3 CUTER PROFESIONIȘTI



	LAMEI	DIMENSIUNEA LAMEI	LUNGIME	GREUTATE
A	x4	60x19mm	175mm	115,5g
B	x1	100x10mm	160mm	129,7g
C	x4	60x19mm	175mm	115,5g

PIESE DISPONIBILE

REF.	DESCRIERE	Icon 1	Icon 2	Icon 3	€
16342	SET DE 10 LAME DE SCHIMB PENTRU REF.54331	0.01	10	100	2,50€
16343	SET DE 10 LAME DE SCHIMB TRAPEZOIDALE PENTRU REF.54331	0.01	10	100	2,50€

51909

2,46€

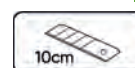
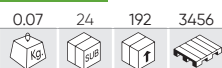

CUTTER PROFESIONAL



PREZENTAT ÎNTR-UN EXPOZANT DE 24 UNITĂȚI



PIESE DISPONIBILE

REF.	DESCRIERE	Icon 1	Icon 2	Icon 3	€
16642	SET DE 10 LAME DE SCHIMB PENTRU REF.51909	0.01	10	100	1,00€

DALTĂ

REF.	DESCRIERE	Icon 1	Icon 2	Icon 3	Icon 4	€
53120	150mm	0.35	6	24	1200	6,00€
53121	250mm	0.55	6	24	864	7,35€
53122	350mm	0.90	6	12	720	9,50€



ACERO 45C

53083

64,00€

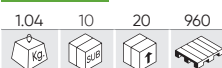

SET DE 4 DĂLȚI

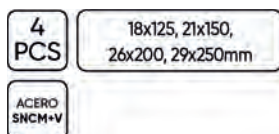

54089

17,50€



SET DE 5 DĂLȚI



PIESE DISPONIBILE

REF.	mm	Icon 1	Icon 2	Icon 3	€
15783	155x10	0.09	6	24	3,50€
15784	155x11	0.09	6	24	3,50€
15785	155x12	0.09	6	24	3,50€
15786	155x14	0.09	6	24	3,50€
15787	155x16	0.09	6	24	3,50€



SCULE DE MÂNĂ

53095

20,50€



SET DE 6 DORNURI CILINDRICE



54099

13,80€



SET DE 5 DORNURI CILINDRICE

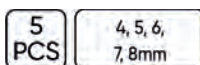

15737

45,00€



MODUL DE DĂLȚI ȘI DISPOZITIVE DE SCOS CUIE



52049

14,00€



SET DE 5 DORNURI CONICE



13667

17,60€



MODUL EVA CLEȘTE NITUIT + NITURI PENTRU CĂRUCIOARE CU SCULE



53993

77,00€



CIOCAN DE NITUIT ARTICULAT MULTIFUNCȚIONAL

- Cap rotativ 360°
- Compact, facilitează lucrul în spații mici
- Proiectat pentru operare cu o singură mână

INCLUDE

- Biți de nituri standard 2,4 mm (3/32") - 3,2 mm (1/8") - 4,0 mm (5/32") - 4,8 mm (3/16")
- Dorn pentru piulițe de nit M3x0.5 - M4x0.7 - M5x0.8 - M6x1
- Dorn pentru nituri M6x1 - M5x0.8 - M4x0.7
- 3 chei fixe 5,5x8,5 mm - 12x17 mm - 15x19 mm
- Suport ax M6x1 - M5x0.8 - M4x0.7 - M3x0.5"



52596

114,00€



CLEȘTE POPNITURI 400MM / 16"



52597

146,00€



CLEȘTE POPNITURI AUTOMATIC 440MM / 17"



PIESĂ DE SCHIMB PENTRU 52595, 52596, 52597

REF.	DESCRIERE				€
13226	M3	0.03	-	100	4,50€
13227	M4	0.04	20	100	4,50€
13228	M5	0.04	20	100	4,50€
13229	M6	0.04	20	100	4,50€

REF.	DESCRIERE				€
13230	M8	0.04	20	100	4,50€
13231	M10	0.05	-	100	4,50€
13232	M12	0.05	-	100	4,50€



52463

26,10€



CLEȘTE BĂTUT NITURI 300MM / 12"



52464

42,00€

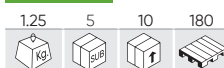

CLEȘTE BĂTUT NITURI 400MM/16"

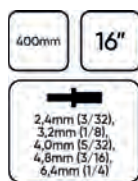

53331

31,80€



CLEȘTE PENTRU NITURI EXTENSIBIL 10" 250MM

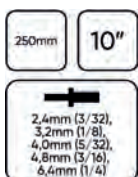

53332

34,50€

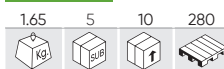

CLEȘTE BĂTUT NITURI 8" 200MM



SCULE DE MÂNĂ

52595

64,00€



CLEȘTE POPNITURI PROFESIONAL 200MM /8"

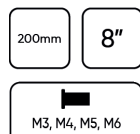

52462

25,30€



CLEȘTE DE NITUIT PROFESIONAL 200MM/8"



52609

29,00€

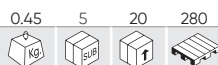

SET DISPOZITIV DE NITUIT + NITURI DE PLASTIC

Ø 6,6mm x 17,2mm (10u.)
Ø 6,3mm x 25,2mm (10u.)
Ø 5mm x 17,2mm (10u.)
Ø 5mm x 15,8mm (10u.)



PIESE DISPONIBILE

REF.	Ø	KG	SUB	CM	CM	€
13674	6x19,3mm	0.04	25	2500	0,50€	
13675	6x17,8mm	0.01	25	500	0,50€	
13676	6x25,5mm	0.01	100	1000	0,50€	
13677	6x24,5mm	0.03	25	1000	0,50€	
13678	6x24mm	0.01	25	1000	0,50€	

52575

119,00€

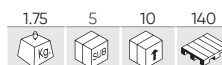

PISTOL NITUIT PNEUMATIC



- Putere de traciune: 1586LBS / 720 KGS.
- Lungime tijă: 9/16 " - 14MM.
- Max. strângere: 60FT IB / 23-69NM.
- Admisie aer: 1/4 ".
- Consum aer: 0.03CFM/0.86L/MIN.

INCLUDE

- 2 Multiunelte
- Lipit rapid
- Oringuri



NIVEL

DIN ALUMINIU

REF.	DESCRIERE	KG	SUB	CM	CM	€
53613	500mm	0.55	5	30	1260	19,50€
53614	600mm	0.60	5	30	840	21,50€
53615	800mm	0.85	5	20	600	34,60€



DIN ALUMINIU CU MAGNET

REF.	DESCRIERE	KG	SUB	CM	CM	€
53616	500mm	0.30	5	60	1260	10,40€
53617	600mm	0.30	5	60	840	9,25€
53618	800mm	0.35	5	30	600	13,90€

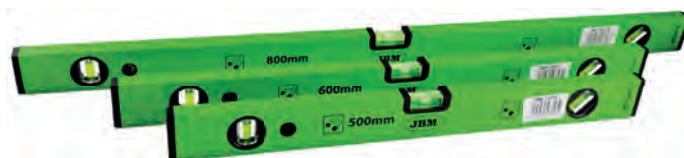

EXHIBITOR PENTRU NIVELURI

REF.	KG	SUB	CM	CM	€
14183	0.80	-	10	-	31,00€



BANDA METRICA

REF.	DESCRIERE					€
53025	3m x 16mm	0.13	12	48	2016	3,50€
53026	5m x 25mm	0.26	12	48	2016	5,80€
53027	7,5m x25mm	0.40	12	48	1500	9,00€



PREZENTAT ÎNTR-UN EXPOZANT DE 12 UNITĂȚI



52433 4,80€

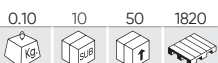

TRUSĂ DE LERE, -20 (0.05-1.0 MM)

0,05-1mm



52638 9,95€



CLEȘTE DE PERFORAT ROTATIV

Ø 2, 2.5, 3, 3.5, 4, 4.5mm



52318 73,00€

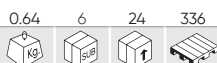

DISPOZITIV MAGNETIC PENTRU REGLAREA UNGHIIULUI DE FUGĂ

-6° / +6°



52904



MICROMETRU DE ADÂNCIME CU SUPOR MAGNETIC

61,00€



REF. DESCRIERE

REF.	DESCRIERE					€
13704	MICROMETRU DE ADÂNCIME PENTRU REF. 52904	0.10	-	50	1500	21,00€

ȘUBLER

REF.				€
50724	0.30	5	50	28,00€
50937	0.24	10	50	10,50€

150mm



50724
DIGITAL



50937
MECANIC



52873
MECANIC



53042
DIGITAL

CALIBRE DE PROFUNDIDADE

REF.				€
52873	0.04	5	300	11,00€
53042	0.05	10	100	9,90€

GONIOMETRU

REF.				€
52583	0.20	4	48	8,50€
52794	0.48	6	24	28,00€



52583



52794
MAGNETIZAT

SCULE DE MÂNĂ

51951

15,60€



SET DE 3 SPATULE



53339

9,50€



SET DE 4 SPATULE DE OȚEL



53589

12,00€



CAPSATOR INDUSTRIAL



ÎNĂLȚIMEA CAPSELOR: 4-14mm



52700

20,50€



SET PENTRU BERCUIT CONDUCTE FRÂNĂ

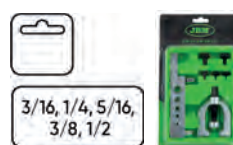

REF. DESCRIERE

REF.	DESCRIERE					€
14167	1000 BUC. CAPSE PENTRU ART. 53589 (11,3 X 0,7 X 8 MM)	0.10	50	100	-	2,50€

51853

18,00€



SET DE 5 PILE



52760

4,10€

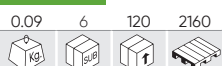

PERII DE SÂRMĂ



52515

9,10€



PERII DE SÂRMĂ



52905

28,00€



APARAT DE ÎNDOIT TUBURI 6-8-10MM



GRADE MARCATE

TUBURI DE ALUMINIU, CUPRU ȘI OȚEL

MOBILIER DE ATELIER

- 72 CĂRUCIOARE CU SCULE
- 83 SETURI DE SCULE
- 90 ACCESORII / PIESE DE SCHIMB
- 93 MASĂ DE LUCRU
- 95 DEPOZITARE
- 99 TABURETI / TĂRGI
- 100 NICOVALE / MENGHINE



54327

2.788,00€



N

SISTEM DE DEPOZITARE MODULAR PENTRU ATELIERE (18 BUC)



DULAP MOBIL CU 6 SERTARE CU SUPRAFAȚĂ DE CAUCIUC

DIMENSIUNILE TOTALE



AGĂȚĂTOR PĂTRAT

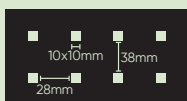

DIMENSIUNILE SPECIFICE

	A	B	C	D	E	F	G
ÎNĂLȚIME	1890mm	340mm	340mm	38mm	900-950mm	750-880mm	900-950mm
LUNGIME	600mm	680mm	680mm	2040mm	680mm	666mm	680mm
LĂȚIME	500mm	280mm	25mm	500mm	500mm	460mm	500mm

DIMENSIUNI INTERIOR

	A1	B1	E1	E2	E3	F1	F2	G1
ÎNĂLȚIME	1890mm	340mm	58mm	136mm	216mm	58mm	137mm	715mm
LUNGIME	600mm	680mm	567mm	567mm	567mm	567mm	567mm	596mm
LĂȚIME	500mm	280mm	408mm	408mm	408mm	408mm	408mm	475mm

PANOURILE DE SCULE SUNT COMPATIBILE CU CÂRLIGELE NOASTRE: REF.16354, 16355, 16356, 16357



LIVRAT FĂRĂ DISPOZITIVUL

PIESE DE SCHIMB ȘI ACCESORII

REF.	DESCRIERE					€
16490	DULAP ÎNALT (REF. 54327)	56.20	-	1	-	650,00€
16491	DULAP DE COLȚ 800X800X338MM (REF.54327)	22.00	-	1	-	307,00€
16492	DULAP DE COLȚ CU PLACĂ MDF (REF.54327)	59.40	-	1	-	675,00€
16493	DULAP CU 3 SERTARE CU SUPORT PENTRU ROLE DE HÂRTIE (REF. 54327)	41.20	-	1	-	436,00€
16494	DULAP DE PERETE (REF. 54327)	10.40	-	1	-	139,00€
16496	PLACĂ MDF 1360X500X38MM (REF. 16627/16628/16500)	19.40	-	1	-	127,00€
16497	PLACĂ MDF 680X500X38MM (REF. 16627/16628/16500)	9.80	-	1	-	77,00€
16498	SET PANOU CU ȘTIFTURI 3 BUC. 680X338X25MM (REF.54327)	6.00	-	1	-	84,00€
16499	SET PANOU CU ȘTIFTURI 6 BUC. 775X338X25MM (REF.54327)	13.00	-	1	-	162,00€
16500	DULAP CU 2 UȘI (REF.54327)	33.60	-	1	-	463,00€
16516	SET PANOU CU ȘTIFTURI 4 BUC. PENTRU DULAP DE COLȚ (REF. 16492)	9.20	-	1	-	121,00€
16561	BARĂ SUPORT (REF.54327)	7.80	-	4	-	36,50€
16627	DULAP CU 4 SERTARE (REF.54327)	43.50	-	1	-	225,00€
16628	DULAP CU 6 SERTARE (REF.54327)	49.00	-	1	-	382,00€
16629	MASĂ DE LUCRU MDF 2040X500X38MM (REF.54327)	27.80	-	1	-	419,00€
16600	PLACĂ DIN OȚEL INOXIDABIL 2040X500 MM (REF.54327)	33.00	-	1	-	252,00€



CĂRUCIOR PENTRU SCULE CU 12 SERTARE

53939 1.280,00€

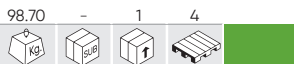

PLIN

172 PCS

DIMENSIUNI INTERIOR 1A COLUMNĂ

A SERTAR MIC (X4)



B SERTAR MEDII (X1)



C SERTARE MARI (X1)



DIMENSIUNILE TOTALE



53868 1.090,00€



VID

172 PCS

DIMENSIUNI INTERIOR 2A COLUMNĂ

D SERTAR MIC (X4)



E SERTAR MEDII (X1)



F SERTARE MARI (X1)



AGĂȚĂTOR PĂTRAT

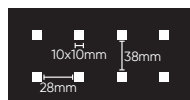

CU EVA MODULE:

53708

325,00€



SET DE 4 MODULE EVA DIN CARBON PENTRU TROLER CU UNELTE

INCLUDE

REF.	Box	Box	Box	€
14296	6.05	4	80	118,00€
14297	3.30	4	96	87,00€
14298	2.10	4	96	51,50€
14299	3.25	4	96	87,00€

14296



PIESE DISPONIBILE



14297



PIESE DISPONIBILE



14298



PIESE DISPONIBILE



14299



PIESE DISPONIBILE



PENTRU MAI MULTE INFORMAȚII

PAGINĂ 83

CĂRUCIOR DE SCULE 7 SERTARE - XL

53912 1.280,00€

74.50 - - 4

53869 990,00€

74.50 - 1 4

53913 1.280,00€

74.50 - - 4

53870 990,00€

74.50 - 1 4

PLIN

199 PCS XL

VID

199 PCS XL

PLIN

199 PCS XL

VID

199 PCS XL



DIMENSIUNI INTERIOR

SERTAR MIC (X5)



SERTAR MARI (X2)



AGĂȚĂTOR PĂTRAT

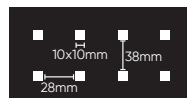

DIMENSIUNILE TOTALE



CU EVA MODULE:

INCLUDE

REF.				€
14296	6.05	4	80	118,00€
14297	3.30	4	96	87,00€

REF.				€
14298	2.10	4	96	51,50€
14299	3.25	4	96	87,00€

REF.				€
15122	1.70	10	200	74,00€
15155	2.45	10	180	59,00€

REF.				€
15161	2.10	10	180	62,00€
15514	0.05	10	360	9,35€

14296

PIESE DISPONIBILE

15122

PIESE DISPONIBILE

14297

PIESE DISPONIBILE

15161

PIESE DISPONIBILE

14298

PIESE DISPONIBILE

15155

PIESE DISPONIBILE

14299

PIESE DISPONIBILE

15514

DULAP CU 7 SERTARE - VERDE

172 PCS 300Kg

N

54389 790,00€

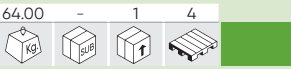

54503 490,00€

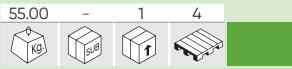

PLIN

VID

DIMENSIUNI INTERIOR

SERTAR MIC (X5)



SERTAR MARI (X2)

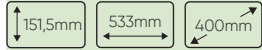

CAPACITATEA DE ÎNCĂRCARE A SERTARULUI: 35KG.
CAPACITATE TOTALĂ DE ÎNCĂRCARE: 300KG.

DIMENSIUNILE TOTALE

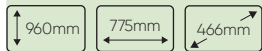

AGĂȚĂTOR PĂTRAT

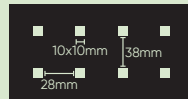

CU EVA MODULE:

53708

325,00€

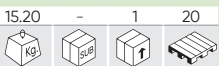

SET DE 4 MODULE EVA DIN CARBON PENTRU TROLER CU UNELTE

INCLUDE

REF.	kg	sub	box	pallets	€
14296	6.05	4	80	118,00€	
14297	3.30	4	96	87,00€	
14298	2.10	4	96	51,50€	
14299	3.25	4	96	87,00€	

14296



PIESE DISPONIBILE



14297



PIESE DISPONIBILE

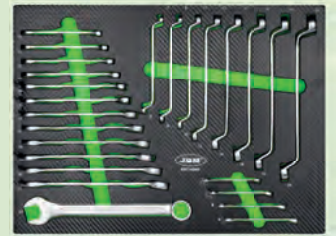

14298



PIESE DISPONIBILE



14299



PIESE DISPONIBILE



PENTRU MAI MULTE INFORMAȚII

PAGINĂ 83

CĂRUCIOR PENTRU SCULE CU 7 SERTARE

53661 790,00€

65.50 - 1 4

PLIN

53761 490,00€

52.50 - 1 4

VID

53767 790,00€

56.00 - 1 4

PLIN

53768 490,00€

56.00 - 1 4

VID

53686 790,00€

65.00 - 1 4

PLIN

53762 490,00€

55.50 - 1 4

VID

53904 790,00€

65.00 - 1 4

PLIN

54006 490,00€

55.00 - 1 4

VID

DIMENSIUNI INTERIOR

SERTAR MIC (X5)



SERTAR MARI (X2)



CAPACITATEA DE ÎNCĂRCARE A SERTARULUI: 30KG.
CAPACITATE TOTALĂ DE ÎNCĂRCARE: 70KG.

DIMENSIUNILE TOTALE



AGĂȚĂTOR PĂTRAT

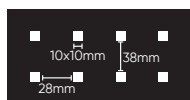

CU EVA MODULE:

53708 325,00€

15.20 - 1 20

SET DE 4 MODULE EVA DIN CARBON PENTRU TROLER CU UNELTE

INCLUDE

REF.	Kg	1	20	€
14296	6.05	4	80	118,00€
14297	3.30	4	96	87,00€
14298	2.10	4	96	51,50€
14299	3.25	4	96	87,00€

14296

PIESE DISPONIBILE

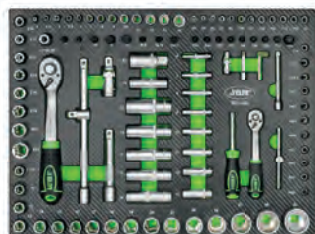

14297

PIESE DISPONIBILE



14298

PIESE DISPONIBILE



14299

PIESE DISPONIBILE



**PENTRU MAI MULTE
INFORMAȚII**

PAGINĂ 83

CĂRUCIOR DE SCULE CU 7 SERTARE SPECIAL PENTRU CAMIOANE

54240 1.887,00€

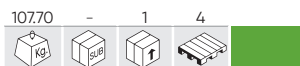

PLIN

54237 1.887,00€



PLIN

54238 1.887,00€



PLIN

54239 1.887,00€



PLIN

DIMENSIUNI INTERIOR

SERTAR MIC (X5)



SERTAR MARI (X2)



CAPACITATEA DE ÎNCĂRCARE A SERTARULUI: 30KG.
CAPACITATE TOTALĂ DE ÎNCĂRCARE: 70KG.

DIMENSIUNILE TOTALE



AGĂȚĂTOR PĂTRAT

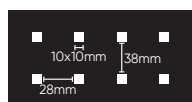

CU EVA MODULE:



54134

1.415,00€

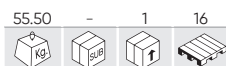

SET DE SCULE PENTRU REPARAREA CAMIOANELOR

INCLUDE

REF.	Box	Box	Pallet	€
15730	10.22	2	48	289,00€
15731	5.20	2	48	214,00€

REF.	Box	Box	Pallet	€
15732	6.40	2	48	293,50€
15733	3.55	2	48	113,00€

REF.	Box	Box	Pallet	€
15734	9.40	2	48	288,50€
15735	10.00	2	48	152,00€

REF.	Box	Box	Pallet	€
15736	14.80	2	40	488,50€

15730



15731



15732



15733



15734



15735



15736



PENTRU MAI MULTE
INFORMAȚII

PAGINĂ 84



CĂRUCIOR PENTRU SCULE CU 7 SERTARE VDE SPECIAL

54236 1.856,00€

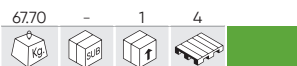

PLIN

54233 1.856,00€

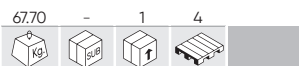

PLIN

54234 1.856,00€

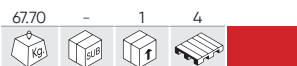

PLIN

54235 1.856,00€

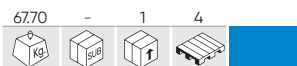

PLIN

DIMENSIUNI INTERIOR

SERTAR MIC (X5)



SERTAR MARI (X2)

CAPACITATEA DE ÎNCĂRCARE A SERTARULUI: 30KG.
CAPACITATE TOTALĂ DE ÎNCĂRCARE: 70KG.

DIMENSIUNILE TOTALE



AGĂȚĂTOR PĂTRAT

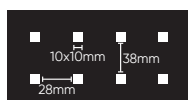

INCLUDE

REF.	DESCRIERE	UNI.					€
52162	TERMOMETRU DIGITAL CU LASER -50°C LA 550°C	1	0.17	6	72	576	38,00€
53940	STAND BARIERĂ PENTRU LANȚ PVC - GALBEN / NEGRU	4	0.55	-	6	90	13,20€
54326	LANȚ PVC - 7M - GALBEN / NEGRU	4	0.30	-	20	720	7,30€
53942	ZA PLASTICĂ DE LANȚ NEGRU	8	0.01	50	5000	75000	0,50€
54093	MODUL EVA CU UNELTE IZOLATE VDE 26 BUC. (ACETAT DE VINIL ETILEN)	1	3.25	-	4	80	441,00€
54114	TESTER REZISTENȚA IZOLAȚIE	1	1.48	-	10	100	248,00€
54129	COVORAȘ IZOLANT CLASA 0	1	0.03	10	50	-	110,00€
54130	MĂNUȘI IZOLANTE PENTRU LUCRĂRI DE TENSIUNE T9	1	0.35	-	1	100	58,00€
54132	ECRAN DE PROTECȚIE IZOLATOR PENTRU LUCRĂRI DE TENSIUNE	1	0.70	-	1	72	190,00€
54241	STĂLP DE SALVARE IZOLAT - 45KV	1	1.10	-	1	50	120,00€

PENTRU MAI MULTE
INFORMAȚII

PAGINĂ 345

DULAP CU 7 SERTARE CU SET DE INSTRUMENTE PENTRU REGLAREA SINCRONIZĂRII

53951 1.794,00€

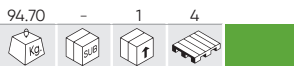

PLIN

53952 1.794,00€

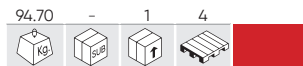

PLIN

54501 1.794,00€

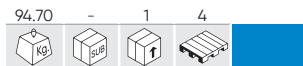

PLIN

54502 1.794,00€

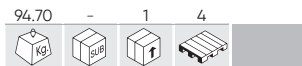

PLIN

DIMENSIUNI INTERIOR

SERTAR MIC (X5)



SERTAR MARI (X2)



CAPACITATEA DE ÎNCĂRCARE A SERTARULUI: 30KG.
CAPACITATE TOTALĂ DE ÎNCĂRCARE: 70KG.

DIMENSIUNILE TOTALE



AGĂȚĂTOR PĂTRAT

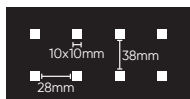

CU EVA MODULE:

53775

1.109,00€

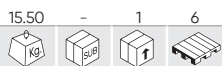

SET DE 6 INSTRUMENTE PENTRU SINCRONIZAREA MOTORULUI

INCLUDE

REF.	Kg	m³	pcs	€
53769	5.90	3	36	178,00€
53770	6.15	3	36	198,00€

REF.	Kg	m³	pcs	€
53771	4.05	3	36	158,00€
53772	6.40	3	36	229,00€

REF.	Kg	m³	pcs	€
53773	6.60	3	36	298,00€
53774	6.95	3	36	190,00€

PENTRU MAI MULTE INFORMAȚII

PAGINĂ 297



53769



RENAULT / NISSAN / OPEL / VOLVO

53770



FORD / SEAT / VOLKSWAGEN / MAZDA / VOLVO

53771



FIAT / FORD / CITROËN / PEUGEOT

53772



FORD / VAG / MAZDA / VOLVO

53773



FIAT / ALFA / LANCIA / OPEL / SUZUKI / FORD

53774



OPEL / CHEVROLET / SAAB / FIAT / LANCIA / SUZUKI / FORD

54295

500,00€

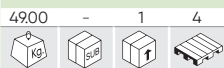

N

CĂRUCIOR DE SCULE CU 7 SERTARE EGALE - VERDE - VID

DIMENSIUNILE TOTALE

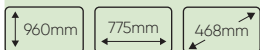

AGĂȚĂTOR PĂTRAT

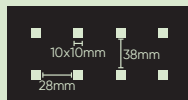

DIMENSIUNI INTERIOR



54296

520,00€



N

CĂRUCIOR DE SCULE CU 8 SERTARE EGALE - VERDE - VID

DIMENSIUNILE TOTALE

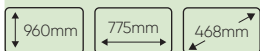

AGĂȚĂTOR PĂTRAT

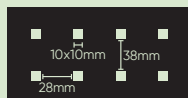

DIMENSIUNI INTERIOR



54297

540,00€

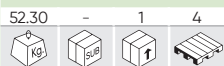

N

CĂRUCIOR DE SCULE CU 9 SERTARE EGALE - VERDE - VID

DIMENSIUNILE TOTALE

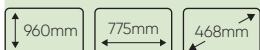

AGĂȚĂTOR PĂTRAT

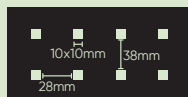

DIMENSIUNI INTERIOR



53672

440,00€

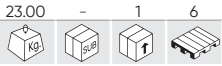

97 PCS

CĂRUCIOR DE SCULE MODULAR

3 MODULURI INDEPENDENTE ECHIPATE CU:



	1/2"	x11	8,10,11,12,13,14,16,17,19,21,22mm
	1/4"	x13	4,4.5,5,5.5,6,7,8,9,10,11,12,13,14mm
	1/2"	x1	
	1/4"	x1	
	1/2"	x2	125,300mm
	1/4"	x2	50,100mm
		x1	180mm
		x1	160mm
		x2	160mm, 180mm
		x2	PH2x125, PH1x100mm
		x2	6x150mm, 5x100mm
		x9	8,9,10,11,12,13,14,17,19mm
		x1	250mm
		x1	300g
		x1	250mm
		x1	200mm
		x8	1,5x8mm
		x1	3mm
	1/4"	x32	
	1/4"	x1	
	1/4"	x1	
	1/4"	x1	
	1/2"	x1	
	1/4"	x1	



A CUTIE DE INSTRUMENTE DIN MODULE EVA + TAVĂ SUPERIOARĂ DETAȘABILĂ



B 2 SERTARE CU INSTRUMENTE DIN MODULE EVA



C COMPARTIMENT CU DESCHIDERE FRONTALĂ



53867

1.095,00€

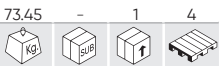

CĂRUCIOR DE SCULE CU 9 SERTARE SI SEPARATOARE - VERDE

DIMENSIUNILE TOTALE

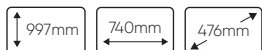

DIMENSIUNI INTERIOR



REF.	mm	UNI.			€
15073	174x53mm	21	0.05	200	1,00€
15076	396x53mm	18	0.30	50	3,50€

AȚI PUTEA DORI, DE ASEMENEA...

REF.	mm			€
15070	67x53mm	0.05	200	0,50€
15071	103x53mm	0.05	200	0,60€
15072	138x53mm	0.05	200	0,70€
15074	210x53mm	0.10	200	1,00€
15075	280x53mm	0.10	200	1,20€

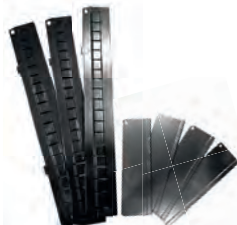

CU SEPARATOARE ORGANIZARE LIBERĂ

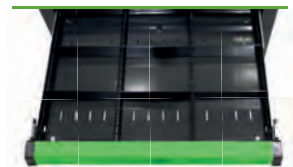

AGĂȚĂTOR PĂTRAT

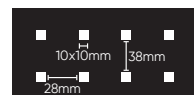



SETURI DE UNELTE CU MODUL DIN FIBRĂ DE CARBON

53708 325,00€

15.20 - 1 20

SET DE 4 MODULE EVA DIN CARBON PENTRU TROLER CU UNELTE

INCLUDE

14296 118,00€

6.05 - 4 80

	1/2"	x17	x10, 11, 12, 13, 14, 15, 16, 17, 18, 19, 20, 21, 22, 24, 27, 30, 32mm
	1/4"	x13	4, 4.5, 5, 5.5, 6, 7, 8, 9, 10, 11, 12, 13, 14mm
	1/2"	x5	14, 15, 17, 19, 22mm
	1/4"	x8	6, 7, 8, 9, 10, 11, 12, 13mm
	1/2"	x8	E10, E11, E12, E14, E16, E18, E20, E24
	1/4"	x5	E4, E5, E6, E7, E8
	7/16"	x2	1/2" - 1/4"
	1/2"	x2	125, 250mm
	1/4"	x2	50, 100mm
		x2	
	1/2"	x1	
	1/2"	x2	16, 21mm

		x2	PH1, PH2
		x2	PZ1, PZ2
	1/4"	x4	3, 4, 5, 6mm
		x3	SL4, SL5.5, SL6.5
		x8	T8, T10, T15, T20, T25, T27, T30
		x2	PH3, PH4
		x2	PZ3, PZ4
	8mm	x5	7, 8, 10, 12, 14mm
		x3	SL8, SL10, SL12
		x5	T40, T45, T50, T55, T60
		x1	1/4"
		x1	1/4"
	1/2"	x1	8mm
		x3	1.5, 2, 2.5mm

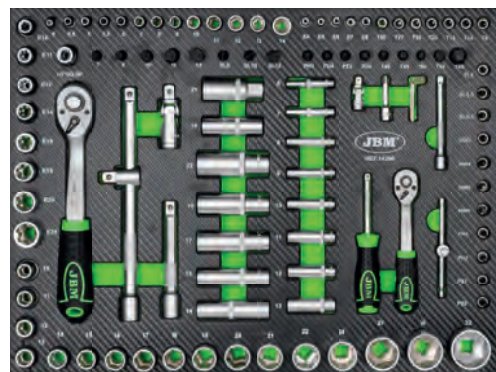

14297 87,00€

3.30 - 4 96

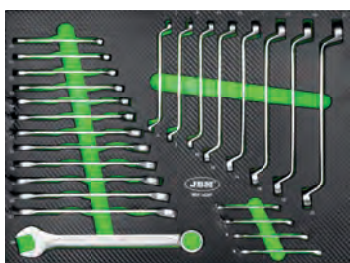

	6x7, 8x9, 10x11, 12x13, 14x15, 16x17, 18x19, 20x22mm
	6, 7, 8, 10, 11, 12, 13, 14, 15, 17, 19, 22mm

14298 51,50€

2.10 - 4 96



		PH0x75, PH1x100, PH2x100, PH3x150, PH4x200
		6, 7, 8, 10, 11, 12, 13, 14, 15, 17, 19, 22mm
		2x38mm
		6x38mm
		1.5, 2, 2.5, 3, 4, 5, 6, 8, 10mm
		10, 15, 20, 25, 27, 30, 40, 45, 50mm

14299 87,00€

3.25 - 4 96



	35mm		8"
	450g		10"
	10"		7.5"
	8"		3m
	8"		

54134

1.415,00€

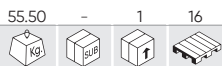

SET DE SCULE PENTRU REPARAREA CAMIOANELOR

INCLUDE

15730

289,00€

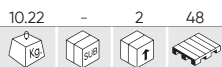

	55mm	H5, H6, H7, H8, H10, H12
	65mm	H14
	70mm	H16, H17, H18, H18, H20
	30mm	H4, H5, H6, H7, H8, H10, H12 M5, M6, M8, M10, M12 T20, T25, T30, T40, T45, T50, T55
	75mm	H4, H5, H6, H7, H8, H10, H12 M5, M6, M8, M10, M12 T20, T25, T30, T40, T45, T50, T55
	1/2" x9	E10, E11, E12, E14, E16, E18, E20, E22, E24
	1/2" x10	10, 11, 12, 13, 14, 15, 16, 17, 18, 19mm

	1/2"	x3	50, 125, 250mm
	1/2"	x1	430mm
	1/2"	x1	10mm
	3/4"	x5	21, 24, 27, 34, 36mm
	3/4"	x4	24, 30, 32, 36 mm
			1/2x10, 3/8x10mm
			1/2x10, 3/8x10mm
	3/8"		10mm
	1/4"		300, 380, 450mm
	1/4"		
	1/2"		12



15731

214,00€

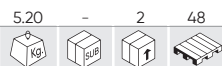

	6x7, 8x9, 10x11, 12x13, 14x15, 16x17, 18x19, 20x22, 21x23, 24x27, 25x28, 30x32mm
	6, 7, 8, 10, 11, 12, 13, 14, 15, 17, 19, 22, 24mm

15732

293,50€

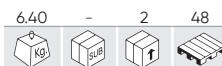

	10, 13, 17mm
	10x11, 12x13, 14x17mm
	E10xE12, E14xE18, E20xE24
	8x10, 11x13, 14x15, 16x17, 18x19mm
	27, 30, 32, 36mm
	10, 13, 17, 19mm

15733

113,00€

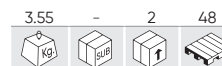

	PH0x75mmL, PH1x75mmL, PH2x100mmL, PH2x38mmL, PH3x150mmL, PH4x200mmL
	SL3.5x75mmL, SL5x75mmL, SL6x100mmL, SL6x38mmL, SL8x150mmL, SL9.5x200mmL
	10x11, 12x13, 14x15mm
	10x11, 12x13, 14x15, 16x17, 18x19mm

15734

288,50€

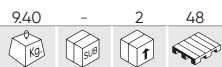

	1kg
	24, 27, 30, 32, 36, 41mm
	3/4" 500mm
	3/4" 500mm
	1.5, 2, 2.5, 3, 4, 5, 6, 8, 10mm

15735

152,00€

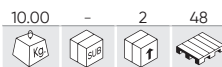

	220mm		250mm
	330mm		6" - 160mm
	330mm		7" - 180mm
	330mm		0°/45°/90°
	330mm		300mm

15736

488,50€

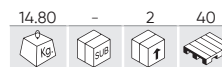

	1/2"	78mm	13,14,15,16,17,18,19,21,22,24mm
	3/4"	78mm	22,24,27,30,32,33,36,38,46mm
	1/2"	90mm	51,60mm
	1/2"		T40,T45,T50,T60,T70
	1/2"	78mm	H6,H8,H14,H17
	3/4"	100mm	T80,T90,T100
	1/2"	40mm	M18
	1/2"(M)x3/4"(H)	-	3/4"(M)x1/2"(H)
	1/2"	-	3/4"
			125mm

15681

134,00€

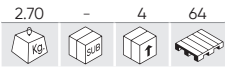

	H3, H4, H5, H6, H7, H8		7, 8, 10, 12, 14mm
	M8, M10, M12		PH3, PH4
	PH0, PH1, PH2, PH3		PZ3, PZ4
	PZ0, PZ1, PZ2, PZ3		8mm
	1/2" SL4, SL5.5, SL6.5, SL7		SL8, SL10, SL12
	T8, T9, T10, T15, T20, T25, T27, T30, T40		T40, T45, T50, T55, T60, T70
	T8, T9, T10, T15, T20, T25, T27, T30, T40		T40, T45, T50, T55, T60, T70
	TS10, TS15, TS20, TS25, TS27, TS30, TS40, TS45, TS50		H7 (230mmL), H10, H11, H13 (140mmL), H14, H17, H19, H22, H24 (55mmL)
	1/2" 8mm		M9 (100mmL), M10, M12, M14 (140mmL), M16 (53mmL), M16 (100mmL)
	3/8" 8mm		1/2" R7, R8 (240mmL), R9 (100mmL), R10 (140mmL)
	1/4" 6mm		T30 (300mmL), T40, T45, T50, T55, T60, T70 (140mmL), T80 (100mmL)
	1/2" M18		HT5 (160mmL)

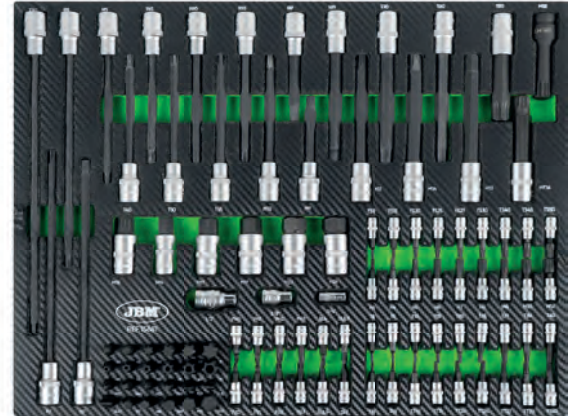

15122 74,00€

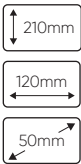
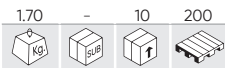

x12 8, 9, 10, 11, 12, 13, 14, 15, 16, 17, 18, 19mm

15155 59,00€

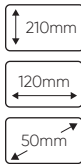
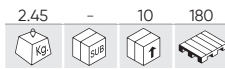

x11 8, 10, 11, 12, 13, 14, 15, 16, 17, 18, 19mm

15156 70,00€

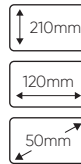
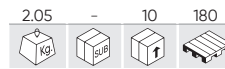

x4 21x23, 24x27, 25x28, 30x32mm

15157 42,00€

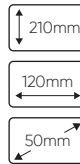
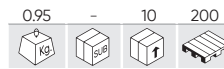

x7 6x8, 10x12, 13x14, 15x17, 19x21, 22x24mm

15158 59,00€

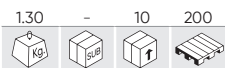

x7 8, 10, 11, 13, 14, 17, 19mm

15159 44,00€

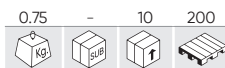

x5 8x10, 11x13, 14x15, 17x19, 20x22mm

15160 42,00€

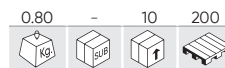

x6 8x9, 10x11, 12x13, 14x15, 16x17, 18x19mm

15161 62,00€

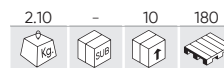

x4 27, 29, 30, 32mm

15316 58,00€

0.85 - 10 260

210mm
120mm
50mm

x3 8, 9, 10, 11, 12, 13, 14, 15, 16, 17, 18, 19mm

53943 21,50€

0.80 - 10 240

210mm
120mm
50mm

x7 PH4x200, PH3x150, PH2x100, PH2x38 PH1x80, PH0x120, PH1x100

53944 19,50€

0.80 - 10 240

210mm
120mm
50mm

x7 SL9x200, SL4x125, SL5x100, SL5x80, SL6x38, SL6x100, SL8x150mm

53945 18,90€

0.60 - 10 240

210mm
120mm
50mm

x7 T8x75, T9x75, T10x75, T15x75, T20x75, T25x100, T27x100

15454 35,40€

1.10 - 10 300

210mm
120mm
50mm

x1 8" x1 8"
x1 8" x1 8"

15541 27,60€

0.95 - 10 220

210mm
120mm
50mm

x1 7" - 180mm
x1 8" - 200mm
x1 8" - 200mm

15706 31,00€

0.55 - 10 240

210mm
120mm
50mm

x1 180 - 770mm x1 280 - 870mm
x1 130 - 640mm x1 170-580mm
x1 495mm

15737 45,00€

1.70 - 10 200

210mm
120mm
50mm

x1 6x180mm
x2 8x180, 10x180mm
x3 6x180, 8x180, 10x180mm
x3 2x160, 16x175, 19x180mm

15315 28,20€

1.05 - 10 260

210mm
120mm
50mm

x1 8" x1 8"
x1 8" x1 8"
x1 8"

15514 9,35€

0.05 - 10 360

210mm
120mm
50mm

VID

54158 38,00€

1.70 - 10 200

210mm
120mm
50mm

3/8" x1 10mm
1/2" x1 10mm
30mm x7 4, 5, 6, 7, 8, 10, 12mm
75mm x7 4, 5, 6, 7, 8, 10, 12mm
30mm x8 T20, T25, T30, T40, T45, T50, T55, T60
75mm x8 T20, T25, T30, T40, T45, T50, T55, T60
30mm x5 M5, M6, M8, M10, M12
15mm x5 M5, M6, M8, M10, M12

15162 30,20€

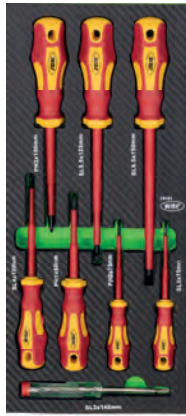
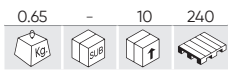

- ⊖ **x4** SL3x75, SL4x100, SL5.5x125, SL6.5x150mm
- ⊕ **x3** PH0x75, PH1x80, PH2x100mm
- ⌵ **x1** 140mm

54093

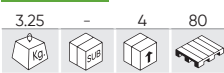

- ⊖ **3/8"** x10 45mm 8, 10, 11, 12, 13, 14, 16, 17, 18, 19, 21, 22mm
- ⊖ **x2** 4x100, 5,5x125mmL
- ⊖ **x2** PH1x80, PH2x100mm
- ⌵ **x1** 185mm
- ⌵ **x1** 52mm
- ⌵ **x1** 185mm
- ⌵ **x6** 7x86, 8x99, 10x109, 12x127, 14x141, 17x156mm
- ⌵ **1/2"** x1 125mm
- ⌵ **3/8"** x1 200mm
- ⌵ **3/8"** x1 200mm

15799 28,30€

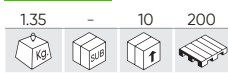

- ⌵ **x1** 450g
- ⌵ **x1** 35mm

16111 19,20€

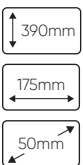
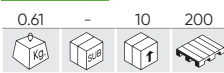

- ⌵ **x1** 220mm
- ⌵ BV1.25
- ⌵ BV2
- ⌵ RV2-4
- ⌵ RV2-4L
- ⌵ SV2-4
- ⌵ SV5.5-6
- ⌵ MDD2-250
- ⌵ FDD2-250

51805 17,00€

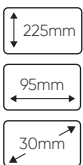
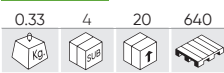

- ⌵ **x5** 50, 75, 100, 152, 227mm

51447 16,00€

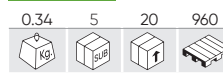

- ⌵ **x5** 50, 75, 100, 152, 227mm

51448 52,00€

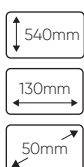

- ⌵ **x5** 50, 125, 250, 380, 510mm

52912 91,00€

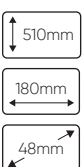

- x6** E6xE7 (200mmL), E8xE10 (235mmL), E11xE12 (290mmL), E14xE16 (370mmL), E18xE20 (410mmL), E22xE24 (420mmL)

54066 83,00€

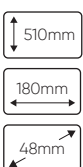

- x7** 8mm (23,5mmL), 10mm (29,3mmL), 12mm (32,8mmL), 13mm (34,9mmL), 14mm (36,7mmL), 17mm (41mmL), 19mm (42mmL)

51864 64,00€

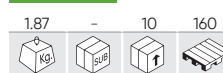

- x6** 10x11mm (290mmL), 12x14mm (330mmL), 13x15mm (368mmL), 16x18mm (407mmL), 17x19mm (407mmL), 22x24mm (430mmL)

54032 84,00€

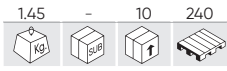

400mm
180mm
50mm



x12 8mm (89mmL), 9mm (94mmL), 10mm (95mmL), 11mm (99mmL), 12mm (102mmL), 13mm (107mmL), 14mm (114mmL), 15mm (117mmL), 16mm (123mmL), 17mm (125mmL), 18mm (130mmL), 19mm (135mmL)

15083 8,50€



380mm
175mm
50mm



VID

15084 68,00€

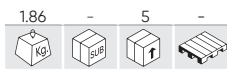

380mm
175mm
50mm

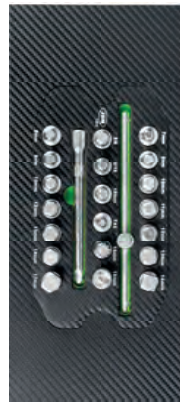

x2 5/16", 3/8"
x7 7, 8, 10, 11, 12, 13, 14mm
x1 10mm
x1 10mm
x7 8, 9, 10, 12, 13, 14, 17mm
x1 T45
x1 M16
x1 200mm
x1 150mm

53979 34,60€

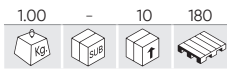

390mm
340mm
50mm

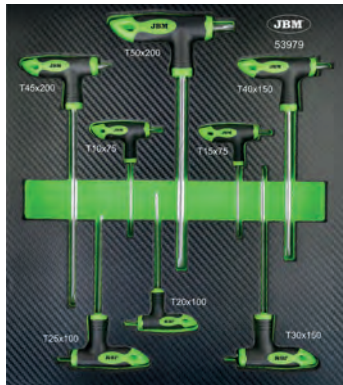

x8 T10x75, T15x75, T20x100, T25x100, T30x150, T40x150, T45x200, T50x200mm

53980 34,60€

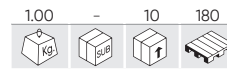

390mm
340mm
50mm



x8 H2x100, H2.5x100, H3x100, H4x150, H5x150, H6x200, H8x200, H10x200

MODULEVA

11996 48,00€

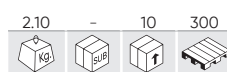

390mm
175mm
50mm



x10 6x7, 8x9, 10x11, 12x13, 14x15, 16x17, 18x19, 20x22, 24x27, 30x32mm

11997 39,00€

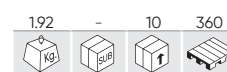

390mm
175mm
50mm



x8 6x7, 8x9, 10x11, 12x13, 14x15, 16x17, 18x19, 20x22mm

11998 49,00€

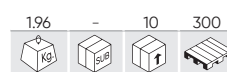

390mm
175mm
50mm



x17 6, 7, 8, 9, 10, 11, 12, 13, 14, 15, 16, 17, 18, 19, 20, 21, 22mm

13668 18,70€

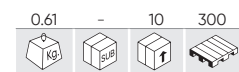

390mm
175mm
50mm



x1 3m
x1 230mm
x1 50mm
x1 250mm

11994 33,00€

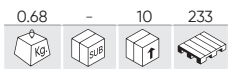

- x1 1/4" x1 250mm
- x1 1/4" x1 125mm
- x1 1/4"
- x13 4, 4.5, 5, 5.5, 6, 7, 8, 9, 10, 11, 12, 13, 14mm

14114 19,30€

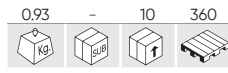

- x1 10"
- x1 10"

13667 17,60€

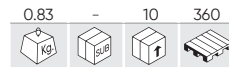

- x1 253mm
- 2x6, 3x7, 3x9, 6x10mm

13923 7,45€

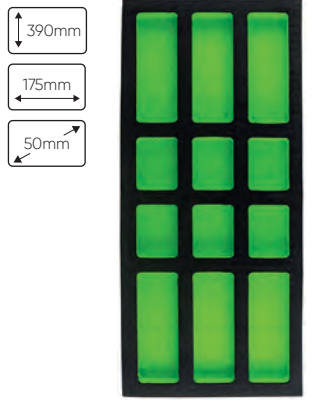
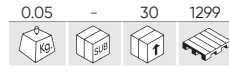

- VID

53671 41,00€

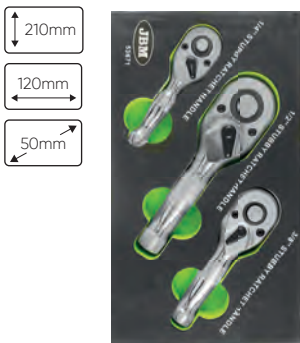
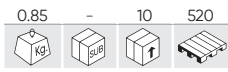

- x3 1/4" - 85 mm
- 1/2" - 135 mm
- 3/8" - 102 mm

53620 88,00€

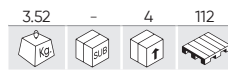

- x17 6, 7, 8, 9, 10, 11, 12, 13, 14, 15, 16, 17, 18, 19, 20, 21, 22mm
- x8 6x7, 8x9, 10x11, 12x13, 14x15, 16x17, 18x19, 20x22mm

MODULURI DIN PLASTIC

10732 18,70€

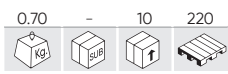

- x1 3m
- x1 230mm
- x1 50mm
- x1 250mm

10735 20,30€



- x1 8"
- x1 8"
- x1 8"
- x1 8"

TABLĂ PERFORATĂ PANOURI

REF.	mm					€
52419	A 1000x600mm	7.07	-	1	30	80,00€
52420	B 1500x600mm	10.80	-	2	35	108,00€
52421	C 2000x600mm	14.00	-	1	38	172,00€

AGĂȚĂTOR PĂTRAT

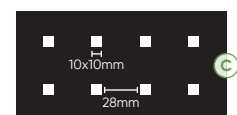
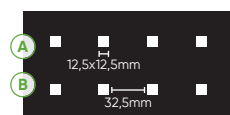
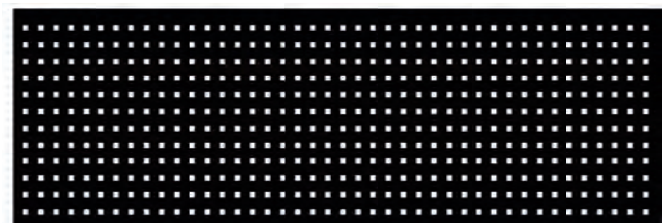

ACCESORII

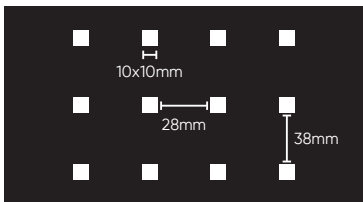

15068 15,20€

0.65	-	25	500



15069 32,80€

1.65	-	1	80



15313 14,00€

0.60	-	1	340

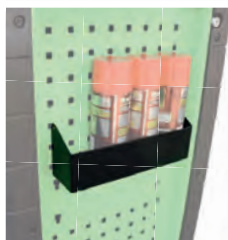

14354 14,00€

0.60	-	1	184



16359 10,00€

0.20	1	30	-	N

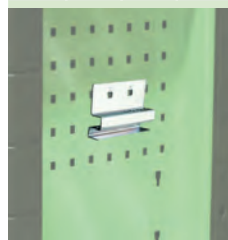

16361 16,50€

0.60	1	30	280	N

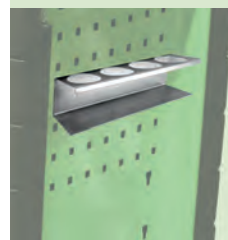

16362 20,00€

2.00	1	30	-	N



16363 14,50€

0.40	1	30	-	N



16344 43,00€

2.00	-	4	72	N



16358 12,00€

0.45	1	30	-	N

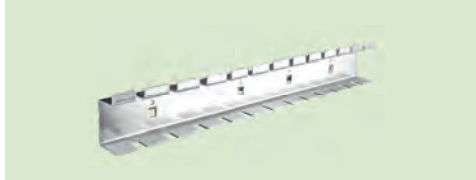

16360 12,00€

0.38	1	30	15	N



16354 1,50€

0.50	10	100	-	N

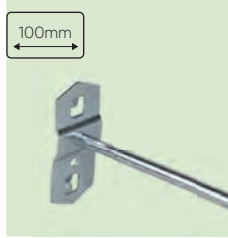

16355 2,00€

0.10	10	100	-	N

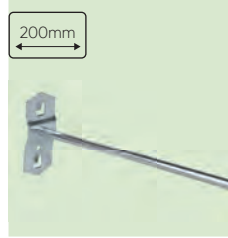

16356 2,50€

0.01	10	100	-	N

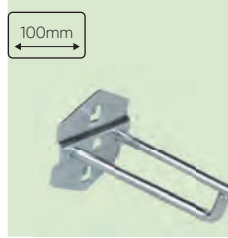

16357 2,50€

0.10	10	100	-	N

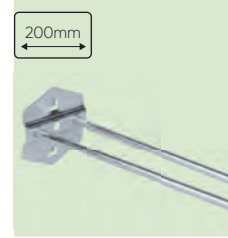

ACCESORII

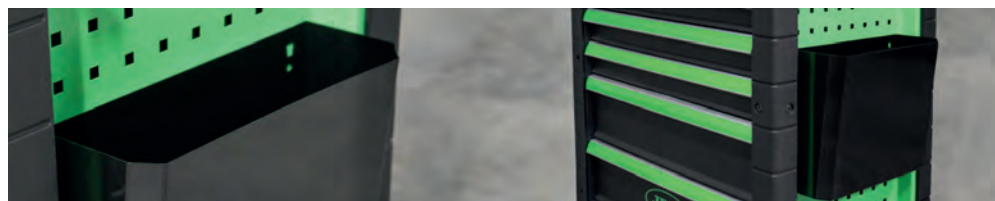
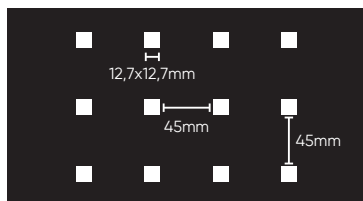

16161 17,50€

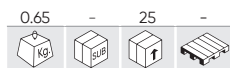

16162 35,10€

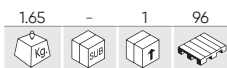

16163 10,20€

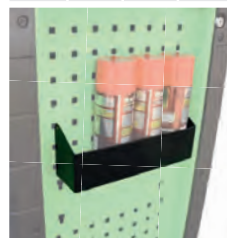

16188 39,60€

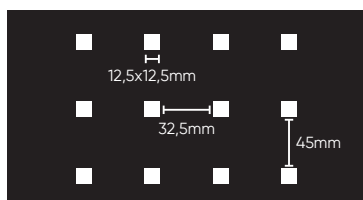

51655 4,10€



51976 1,63€



51658 4,50€



51422 2,97€



52634 5,25€

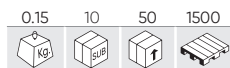

51975 2,27€

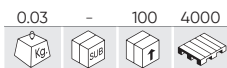

51419 2,79€

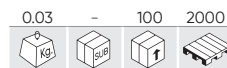

51656 3,65€

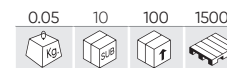

51654 4,80€

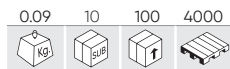

52635 4,80€

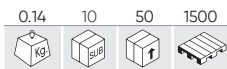

51657 5,85€

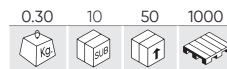

51653 5,10€

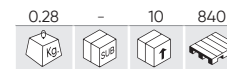

PIESE DE SCHIMB

REF.	DESCRIERE					€
14578	SET DIN 2 INSERTI MARI PENTRU RULMENȚI PENTRU 53661, 53686, 53904, 54006	1.05	-	25	-	12,50€
14580	CAPAC SUPERIOR PENTRU ART. 53661 - 53686 - 53904 - 54006 - 54389	2.60	-	3	39	41,00€
14783	PROTECTOR DREAPTA PENTRU ART. 53686, 53661, 53904, 54006, 54389	0.25	-	50	-	5,50€
15023	ROATĂ FIXĂ PENTRU NR. 53765, 53766, 53870	0.65	-	10	-	12,50€
15024	ROATĂ PIVOTANTĂ PENTRU NR.53765, 53766, 53870	0.95	-	8	-	15,00€
15025	ROATĂ FIXĂ PENTRU NR. 53900, 53901	0.65	-	10	-	12,50€
15026	ROATĂ PIVOTANTĂ PENTRU NR.53900, 53901	0.95	-	8	-	15,00€
15030	MÂNER PENTRU NR. 53765, 53766	0.30	-	50	-	8,00€
15033	MÂNER ÎNGUST PENTRU NR.53868	0.14	-	50	-	6,00€
15034	CAPAC SUPERIOR PENTRU NR. 53868	2.00	-	2	-	57,00€
15035	MÂNER PENTRU NR. 53869	0.36	-	20	-	8,50€
15036	MÂNER PENTRU NR. 53870	0.36	-	20	-	8,50€
15037	MÂNER PENTRU NR. 53900, 53901	0.10	-	-	-	8,00€
15038	CAPAC SUPERIOR PENTRU NR. 53869, 53870	2.00	-	2	-	34,50€
15040	ROATĂ FIXĂ PENTRU NR. 53904, 54006, 54389	0.66	-	10	-	12,50€
15041	ROATĂ PIVOTANTĂ PENTRU NR.53904, 54006, 54389	0.98	-	8	-	15,00€
15042	MÂNER PENTRU NR. 53904, 54006	0.10	-	1	-	7,50€
15050	MÂNER PENTRU NR. 53661, 53686	0.10	-	50	-	9,50€
15058	PROTECTOR LATERAL PENTRU NR. 53868	0.36	-	-	-	7,50€
15065	PROTECTOR LATERAL PENTRU NR.53869, 53870	0.28	-	12	-	6,50€
16387	MÂNER PENTRU NR. 54389	0.40	-	-	-	10,50€



LACĂȚ

SCURT

REF.	DESCRIERE					€
53403	38mm	0.15	8	96	3168	6,50€
53405	32mm	0.10	8	96	3168	5,30€
53406	50mm	0.30	8	48	1728	8,55€
53407	63mm	0.35	8	48	3168	12,70€
53408	75mm	0.48	3	24	840	19,30€

LUNG

REF.	DESCRIERE					€
53404	38mm	0.15	8	96	3168	6,50€
53409	50mm	0.30	8	48	3168	9,00€

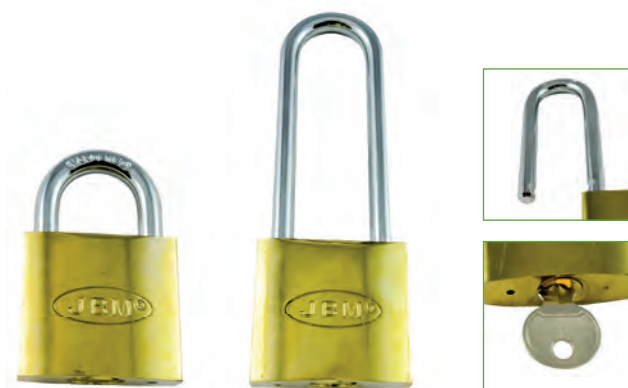

LACĂȚ REZISTENT LA APĂ

REF.	DESCRIERE					€
53399	30mm	0.90	8	48	3168	3,50€
53400	40mm	0.20	8	48	499	5,70€
53401	50mm	0.35	8	48	499	7,40€
53402	65mm	0.05	10	40	499	9,60€



54388

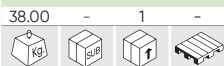

366,00€

N

CĂRUCIOR DE DIAGNOSTICARE

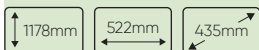

Cărucior de atelier multifuncțional cu patru tăvi și un compartiment cu cheie. Este potrivit pentru a plasa laptopuri, testere și încărcătoare de baterii.

Are două mânere și roți rotative care facilitează transportul într-un mod foarte confortabil. Include, de asemenea, un panou perforat, un suport pentru role de hârtie și două tăvi laterale pentru depozitarea sculelor.

MĂSURĂTORILE RAFTULUI SUPERIOR	433x398mm
DIMENSIUNI PANOU PERFORAT	430x475mm
TOTAL RAFTURI	4
CAPACITATEA RAFTULUI SUPERIOR:	20Kg
DIAMETRUL ROȚILOR	101mm
ROȚI CU FRÂNE	2



REF. DESCRIERE

REF.	DESCRIERE	Kg	Dimensiuni	Q	€
16481	ROATA CU FRÂNĂ PENTRU REF. 54388	11.60	-	20	14,00€
16482	ROATĂ PENTRU REF. 50818	2.80	-	20	13,50€

51576

125,00€

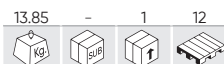

CĂRUCIOR MOBIL PENTRU SCULE CU 3 TĂVI



190mm

52373

252,00€



CĂRUCIOR MOBIL PENTRU SCULE CU 3 TĂVI MAXI



190mm

51738

850,00€

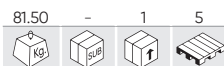

MASĂ DE LUCRU CU 3 SERTARE

DIMENSIUNILE TOTALE



DIMENSIUNI SERTARE INTERIOR



REF. DESCRIERE

REF.	DESCRIERE	Kg	Dimensiuni	Q	€
15144	COVORAȘ DE MASĂ DE LUCRU DIN CAUCIUC NR. 51738	2.50	-	100	30,00€

51737

699,00€

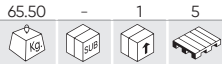

MASĂ DE LUCRU CU 2 SERTARE



DIMENSIUNILE TOTALE



DIMENSIUNI SERTARE INTERIOR



REF. DESCRIERE

REF.	DESCRIERE	1.90	-	100	100	20,45€
15145	SET DE 2 COVORAȘE DE MASĂ DE LUCRU DIN CAUCIUC NR. 51737					

53674

447,00€

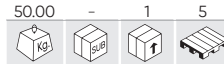

MASĂ DE LUCRU CU 1 SERTARE



DIMENSIUNILE TOTALE



DIMENSIUNI SERTARE INTERIOR



REF. DESCRIERE

REF.	DESCRIERE	1.35	-	100	100	16,20€
15146	COVOR DE CAUCIUC PENTRU MASA DE LUCRU, NR. 53674					

51035

799,00€

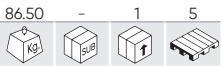

MASĂ DE LUCRU CU PANOU DE SCULE



DIMENSIUNILE TOTALE



AGĂȚĂTOR PĂTRAT

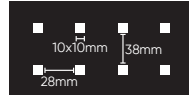

DIMENSIUNI SERTARE INTERIOR

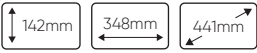

54328

199,00€



BANC DE LUCRU PLIABIL CU PANOU POSTERIOR



N

DIMENSIUNILE TOTALE

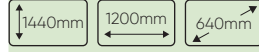

AGĂȚĂTOR PĂTRAT

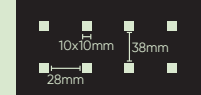

DIMENSIUNILE STRĂNS

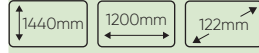

SUPRAFATA DE LUCRU

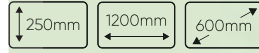

LIVRAT FĂRĂ DISPOZITIVUL

50957

22,00€

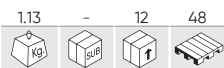

CUTIE DIN PLASTIC PENTRU SCULE CU 24+2 COMPARTIMENTE



- 24 compartimente de 8x5,5 cm.
- 2 compartimente de 15x7,5 cm.
- Variabile de la 26 la 5 separații.

50959

14,00€

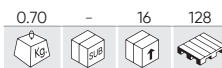

CUTIE DIN PLASTIC PENTRU SCULE CU 20+1 COMPARTIMENTE



- 20 compartimente de 6x7 cm.
- 1 compartiment de 35x7 cm.
- Variabile până la 4 separații.

51051

34,80€

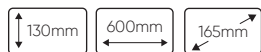
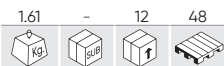

ORGANIZATOR CU 5 COMPARTIMENTE



SERTARELE NU SE SEPARĂ

51050

285,00€

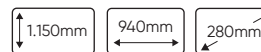
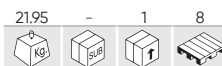

ORGANIZATOR CU PICIOR, CU 47 COMPARTIMENTE

COMPARTIMENTE MARI
 Total: 15
 Dimensiuni: 24x14,5x13 cm
 Dimensiunea raftului: 84x14x24 cm
 Total rafturi: 3

COMPARTIMENTE MICI
 Total: 32
 Dimensiuni: 16x10x7,5 cm
 Dimensiunea raftului: 84x16x8 cm
 Total rafturi: 4



51574

52,00€

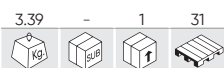

CUTIE PT. SCULE CU 5 COMPARTIMENTE



DIMENSIUNILE TOTALE

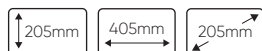

DESCHIS



CUTIE PENTRU SCULE

REF.							€
54393	750x200x220mm - 9Kg	7.70	-	1	15	92,00€	
54394	530x200x220mm - 5,2Kg	5.70	-	1	22	64,00€	
54395	450x200x220mm - 4,5Kg	6.20	-	1	24	53,00€	



51575

317,00€

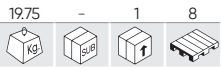

CUTIE PENTRU SCULE CU 6 SERTARE

DIMENSIUNILE TOTALE



SERTAR MIC (X3)

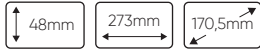

SERTAR MEDII (X2)



SERTARE MARI (X1)



51600

109,00€

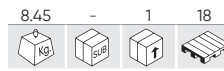

CUTIE PT. SCULE CU 3 SERTARE FRONTALE

DIMENSIUNILE TOTALE

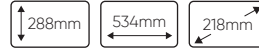

DIMENSIUNI SERTARE INTERIOR



53782

14,00€

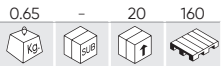

RUCSAC PENTRU INSTRUMENTE ELECTRICE - MARE



53253

98,00€

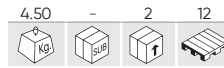

VALIZA PENTRU UNELTE

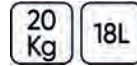

54080

53,50€

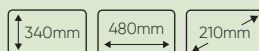
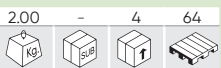

N

GEANTĂ PENTRU UNELTE

20L



54374

75,50€



N

RUCSAC PENTRU UNELTE

15 Kg





RUCSAC PENTRU INSTRUMENTE

REF.	DESCRIERE					€
53702	RUCSAC PENTRU INSTRUMENTE ELECTRICE - MIC	1.00	-	5	180	28,50€
53703	RUCSAC PENTRU INSTRUMENTE ELECTRICE - MEDIU	1.40	-	5	120	41,00€
53704	RUCSAC PENTRU INSTRUMENTE ELECTRICE - MARE	1.65	-	5	120	42,00€

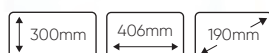

53903

59,00€

1.65	-	10	100

SET DE 3 TAVE PENTRU INSTRUMENTE, FLEXIBILE ȘI ANTIDERAPANTA

3
PCS

REF.	DESCRIERE					€
15010	285x137x27mm	0.40	-	20	360	16,50€
15011	285x202x27mm	0.45	-	20	320	18,00€
15012	543x300x27mm	1.05	-	10	120	31,50€

TAVĂ MAGNETICĂ PLIABILĂ

REF.	DIAMETRU SUPERIOR	DIAMETRU BAZĂ	DIMENSIUNE DESFACERE	DIMENSIUNE STRĂNGERE					€
52516	225mm	88mm	135mm	43mm	0.42	6	24	1152	28,00€
52517	135mm	53mm	90mm	31mm	0.10	12	72	1152	6,00€



50787 8,00€



TAVĂ ROTUNDĂ
MAGNETIZATĂ Ø150MM



50788 14,50€



TAVĂ DREPTUNGHIUARĂ
MAGNETIZATĂ



52466 11,00€



RECIPIENT MAGNETIC

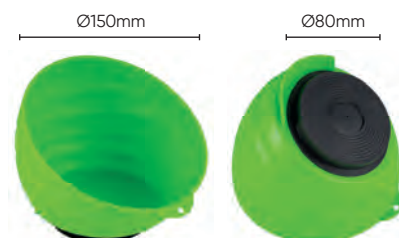

53958 6,50€

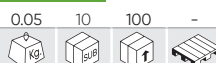

SET DE 5 MAGNEȚI



50789 29,00€



BARĂ MAGNETICĂ PENTRU INSTRUMENTE



53192 52,00€



COVORAȘ PLIABIL



DIMENSIUNILE TOTALE



MĂSURI DE PLIERE



- SPUMĂ EVA.

53191 14,80€



COVORAȘ INDIVIDUAL



DIMENSIUNILE TOTALE



- SPUMĂ EVA.

50843

79,00€

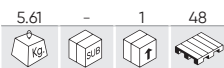

SCAUN PNEUMATIC REGLABIL



Ø 295mm

Ø 380mm



50844

65,00€

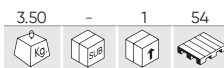

BANCHETĂ CU ROTILE



DIMENSIUNILE TOTALE



52148

65,00€

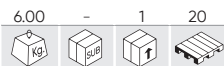

TARGĂ DIN PLASTIC



DIMENSIUNILE TOTALE



50808

77,00€



TARGĂ PLIABILĂ DIN METAL



DIMENSIUNILE TOTALE



REF. DESCRIERE



11971 ROȚI PENTRU 52148

0.20 5 50 - 3,60€

53211

75,00€

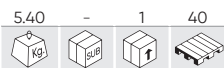

TARGĂ PLIABILĂ CONVERTIBILĂ



DIMENSIUNILE TOTALE

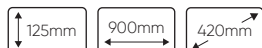

MĂSURI DE PLIERE

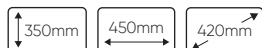

52542

109,00€

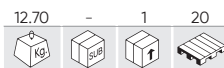

TARGĂ SERVICE AUTO



DIMENSIUNILE TOTALE



MĂSURI DE PLIERE



52869

52,00€

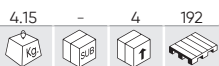

MENGINĂ FIXĂ 100MM



52870

100,00€



MENGINĂ FIXĂ 150MM



53031

59,00€

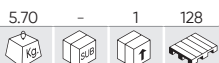

MENGINĂ CU BAZA ROTATIVĂ 4"



53032

126,00€



MENGINĂ CU BAZA ROTATIVĂ 6"



52871

258,00€

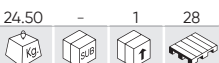

MENGINĂ FIXĂ 150MM RAPIDĂ



DESCHIDERE
IMEDIATĂ PRIN LEVIER
+ BAZA ROTATIV

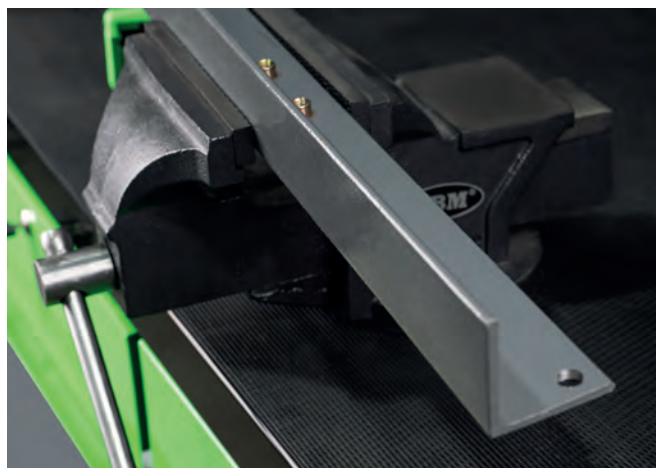

NICOVALĂ PROFESIONALĂ

REF.	Kg.	mm					€
52308	50Kg	190x625x140mm	47.00	-	1	24	440,00€
52309	100Kg	245x790x180mm	100.00	-	1	8	941,00€

OȚEL



SCULE ELECTRICE FĂRĂ FIR

- 102 ÎNȘURUBARE
- 106 PERFORARE
- 108 ȘLEFUIRE/LUSTRUIRE
- 110 DEBITARE
- 113 SCULE SPECIALE
- 118 SCULE PENTRU GRĂDINĂRIT
- 122 BATERII / ÎNCĂRCĂTOARE
- 123 ACCESORII / CONSUMABILE



**FOLOȘIȚI-LE CU BATERII JBM:
O SINGURĂ BATERIE POTRIVITĂ PENTRU TOATE INSTRUMENTELE**

TREI TIPURI DE BATERII ȘI DOUĂ TIPURI DE ÎNCĂRCĂTOR.
ALEGEȚI-L PE CEL PREFERAT!



60046C

339,00€

5,00 - 4 40



N

CHEIE CU IMPACT FĂRĂ FIR 1/2" 550NM CU CARCASĂ

INCLUDE

REF.	DESCRIERE					€
60013	BATERIE LI-ION 4.0 AH	0.75	-	5	700	80,00€
60016	ÎNCĂRCĂTOR 20 V - 4A	0.80	-	5	210	49,00€
60046	CHEIE DE IMPACT FĂRĂ BATERIE 1/2" 550NM	1.50	-	4	200	174,00€

Acest instrument este conceput pentru strângerea și slăbirea piulițelor și șuruburilor care necesită un cuplu mare de strângere. Este prevăzut cu o lumină de lucru cu LED și un selector pentru direcția de rotație care permite, de asemenea, blocarea declanșatorului și prevenirea pornirii accidentale a instrumentului.

Are 5 viteze diferite, 3 pentru strângere și 2 pentru slăbire, permițându-vă să reglați viteza în funcție de operațiunea care trebuie efectuată. În plus, datorită mânerului ergonomic, se obține o mai bună aderență și precizie.

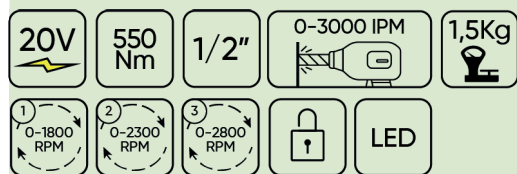

MOTOR BRUSHLESS

ILUMINARE CU LED-URI

COMUTATOR DE DIRECȚIE ÎNAINTE ÎNAPOI

MÂNER ERGONOMICA

5 TREPTE DE VITEZĂ DIFERITE

CÂRLIG PENTRU CUREA

COMPARTIMENTARELE DIN CAZURILE NOASTRE SUNT COMPATIBILE CU BATERII DE 4.0AH ȘI 6.0AH.



60046

174,00€

1,50 - 4 200



N

CHEIE DE IMPACT FĂRĂ BATERIE 1/2" 550NM

BATERIA NU ESTE INCLUSĂ.



PIESE DISPONIBILE

FOLOȘIȚI-LE CU BATERII JBM: O SINGURĂ BATERIE POTRIVITĂ PENTRU TOATE INSTRUMENTELE

TREI TIPURI DE BATERII ȘI DOUĂ TIPURI DE ÎNCĂRCĂTOR.
ALEGEȚI-L PE CEL PREFERAT!



60044C

485,00€

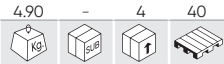

CHEIE DE IMPACT FARA FIR 1/2" 1300NM CU CARCASA

INCLUDE

REF.	DESCRIERE					€
60013	BATERIE LI-ION 4.0 AH	0.75	-	5	700	80,00€
60016	ÎNCĂRCĂTOR 20 V - 4A	0.80	-	5	210	49,00€
60044	CHEIE DE IMPACT 1/2" 1200NM CU MOTOR FĂRĂ PERII	3.25	-	5	90	330,00€

Acest instrument a fost proiectat pentru a strânge și a slăbi șuruburi și piulițe care necesită aplicarea unui cuplu mare. Este echipat cu un motor brushless X-TorQ de nouă generație care permite desurubarea șuruburilor și piulițelor blocate sau foarte strânse până la 2 ori mai rapid. Robust și durabil, cu o carcasă de aluminiu protejată cu elastomer în partea frontală.

Vine echipat cu o lumină de lucru LED și un selector pentru direcția de rotație care permite, de asemenea, blocarea trăgaciului și prevenirea unei porniri accidentale a instrumentului. Dispune de 5 trepte diferite, 3 pentru strângere și 2 pentru slăbire, permițând ajustarea vitezei în funcție de operația ce urmează a fi efectuată. Dublul ciocan de nou design furnizează mai multe lovituri pe minut și mai puține vibrații.

Noul inel de fixare a cheii tubulare: schimbarea mai rapidă a tuburilor și prinderea mai sigură. Balansul perfect al instrumentului și greutatea, potrivite pentru lucrările care necesită tuburi de dimensiuni mari și niveluri ridicate de cuplu. Carligul de dimensiuni mari este util pentru a agăța mașina pe structuri metalice sau pe centura de lucru. În plus, datorită mânerului ergonomic, se obține o prindere mai bună și o precizie mai mare.

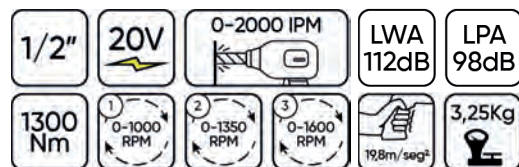

MOTOR BRUSHLESS

ILUMINARE CU LED-URI

COMUTATOR DE DIRECȚIE ÎNAINTE ÎNAPOI

MÂNER ERGONOMIC

5 TREPTE DE VITEZĂ DIFERITE

CÂRLIG PENTRU CUREA

COMPARTIMENTARELE DIN CAZURILE NOASTRE SUNT COMPATIBILE CU
BATERII DE 4.0AH ȘI 6.0AH.

60044

330,00€



CHEIE DE IMPACT 1/2" 1200NM CU MOTOR FĂRĂ PERII

BATERIA NU ESTE INCLUSĂ.



60048C

560,00€

715	-	4	32

N

CHEIE CU IMPACT FĂRĂ FIR 3/4" 1300NM CU CARCASĂ

INCLUDE

REF.	DESCRIERE					€
60015	BATERIE LI-ION 6.0 AH	1.00	-	20	630	138,00€
60016	ÎNCĂRCĂTOR 20 V - 4A	0.80	-	5	210	49,00€
60048	CHEIE DE IMPACT 3/4" 1300NM CU MOTOR FĂRĂ PERII	3.26	-	4	64	366,00€

Această unealtă a fost concepută pentru a strânge și slăbi șuruburile și piulițele care necesită un cuplu de strângere ridicat. Este echipat cu o lumină de lucru cu LED și un selector de direcție de rotație care permite, de asemenea, blocarea declanșatorului pentru a preveni pornirea accidentală a unelei.

Are 5 trepte diferite, 3 pentru strângere și 2 pentru slăbire, permițând reglarea vitezei în funcție de operația de efectuat. În plus, datorită mânerului său ergonomic, se obține o mai mare aderență și precizie.



MOTOR BRUSHLESS

ILUMINARE CU LED-URI

COMUTATOR DE DIRECȚIE ÎNAINTE ÎNAPOI

MÂNER ERGONOMIC

5 TREPTE DE VITEZĂ DIFERITE

CÂRLIG PENTRU CUREA

COMPARTIMENTARELE DIN CAZURILE NOASTRE SUNT COMPATIBILE CU BATERII DE 4.0AH ȘI 6.0AH.



60048

366,00€

3.26	-	4	64

N

CHEIE DE IMPACT 3/4" 1300NM CU MOTOR FĂRĂ PERII

BATERIA NU ESTE INCLUSĂ.



PIESE DISPONIBILE

60005

132,00€

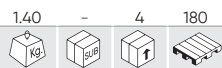

INSTRUMENT PERCUTANT FĂRĂ PERII

BATERIA NU ESTE INCLUSĂ.

Acest instrument este destinat pentru strângerea rapidă a șuruburilor și piulițelor și este util în special în timpul lucrului cu elemente de fixare lungi și materiale dure. Șurubelnița este echipată cu iluminare cu LED a zonei de lucru pentru un lucru mai comod și precis, mandrină hexagonală cu schimbare rapidă de 1/4" inci pentru instalarea rapidă și îndepărtarea duzei, precum și cu declanșator cu funcție de blocare pentru a preveni pornirea accidentală a sculei.

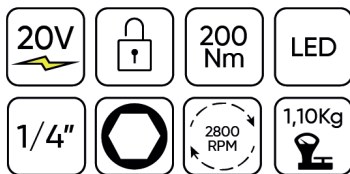

- A MOTOR BRUSHLESS
- B ILUMINARE CU LED-URI
- C COMUTATOR DE DIRECȚIE ÎNAINTE ÎNAPOI
- D MĂNER ERGONOMICĂ
- E 5 TREPTE DE VITEZĂ DIFERITE
- F CÂRLIG PENTRU CUREA
- G BATERIA NU ESTE INCLUSĂ

ACCESORII ȘI
PIESE DE SCHIMB

PAGINĂ 126



60024

190,00€



CLICHET DE 1/2" - CU BATERIE SI MOTOR 12V BRUSHLESS

BATERIA NU ESTE INCLUSĂ.

Acest instrument este destinat pentru înșurubarea/deșurubarea elementelor de fixare în locuri greu accesibile.

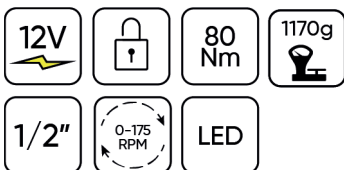

- A CHEIE PĂTRATĂ DE 1/2"
- B SCHIMBAREA DIRECȚIEI: ÎNAINTE / ÎNAPOI
- C LUMINA DE LUCRU ÎNCORPORATĂ CU LED-URI
- D INDICATOR DE NIVEL AL BATERIEI
- E COMUTATOR DE BLOCARE
- F VITEZA VARIABILĂ
- G PROTECȚIE LA SUPRASARCINĂ

INCLUDE

REF.	DESCRIERE					€
60025	ÎNCĂRCĂTOR 12V - PENTRU REF. 60026	0.30	5	4	700	31,60€
60026	BATERIE LI-ION 2.0 A*H SAMSUNG - PENTRU REF. 60024	0.20	5	40	1400	37,90€



60023

212,00€

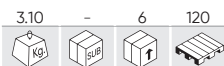

CIOCAN ROTOPERCUTOR CU MOTOR FĂRĂ PERII

BATERIA NU ESTE INCLUSĂ.

Acest instrument este destinat pentru găurirea cu ciocanul și mărunțirea betonului și cărămidii, precum și pentru găurirea obișnuită a altor materiale precum oțelul, lemnul, metalul, ceramica și plasticul.



- A MOTOR BRUSHLESS
- B DISPOZITIV DE MĂSURAT ADÂNCIMEA
- C CAPAC DE PROTECȚIE CONTRA PRAFULUI
- D MANDRINĂ CU FIXARE RAPIDĂ PENTRU INSTRUMENT CU COADĂ SDS
- E COMUTATOR MOD DE LUCRU
- F COMUTATOR DIRECȚIE DE ROTAȚIE
- G MÂNER ERGONOMICĂ
- H ILUMINARE CU LED-URI
- I BATERIA NU ESTE INCLUSĂ



INCLUDE

- 1 BUC. CAPAC DE PROTECȚIE ÎMPOTRIVA PRAFULUI
- 1 BUC. DISPOZITIV DE MĂSURAT ADÂNCIMEA
- 1 BUC. MÂNER SUPPLEMENTAR
- 1 BUC. DALȚĂ CU VÂRF ASCUȚIT
- 1 BUC. DALȚĂ PLATĂ
- BURGHIE SDS: Ø8 / 10 / 12 X 150 MM



PIESE DISPONIBILE

ACCESORII ȘI
PIESE DE SCHIMB

PAGINĂ 123

60006

182,00€



MAȘINĂ DE GĂURIT CU PERCUȚIE, DOUĂ VITEZE ȘI CU MOTOR BRUSHLESS

BATERIA NU ESTE INCLUSĂ.

Acest instrument este destinat pentru găurirea lemnului și a metalului, efectuarea periașilor de percție în principal în zidărie, beton, piatră și cărămidă roșie, precum și pentru strângerea / desfacerea și slăbirea șuruburilor și piulițelor.



- A MOTOR BRUSHLESS
- B ILUMINARE CU LED-URI
- C COMUTATOR DE DIRECȚIE ÎNAIȚE ÎNAPOI
- D MÂNER ERGONOMICĂ
- E CÂRLIG PENTRU CUREA
- F BATERIA NU ESTE INCLUSĂ



Mâner suplimentar



PIESE DISPONIBILE

ACCESORII ȘI
PIESE DE SCHIMB

PAGINĂ 124

60047C

318,00€



N

MASINA DE GAURIT CU PERCUTIE 2 VITEZE , CU BATERIE SI VALIZA

INCLUDE

REF.	DESCRIERE					€
60013	BATERIE LI-ION 4.0 AH	0.75	-	5	700	80,00€
60016	ÎNCĂRCĂTOR 20 V - 4A	0.80	-	5	210	49,00€

Acest instrument a fost conceput pentru a face găuri pe diferite tipuri de materiale. Poate efectua sarcini de găurire în lemn și metal și sarcini de găurire cu impact, mai frecvente în zidărie, în beton, piatră și cărămidă roșie. De asemenea, poate strânge, slăbi sau îndepărta piulițe și șuruburi. Pentru a face acest lucru, dispune de un inel de reglare care vă permite să alegeți dintre 20 de setări diferite ale cuplului.

Are un selector de viteză și un selector înainte/înapoi pentru a seta direcția de rotație la stânga sau la dreapta. Dacă este setat pe poziția de mijloc, acest selector blochează comutatorul de declanșare pentru a preveni o pornire accidentală a instrumentului.

Este echipat cu o lumină LED pentru o mai bună vizualizare a zonei de lucru. Ca accesorii, are un cârlig pentru curea și un mâner auxiliar pentru o prindere mai bună.



MOTOR BRUSHLESS

ILUMINARE CU LED-URI

COMUTATOR DE DIRECȚIE ÎNAINTE ÎNAPOI

MÂNER ERGONOMICA

5 TREPTE DE VITEZĂ DIFERITE

CÂRLIG PENTRU CUREA

MÂNER SUPPLEMENTAR

COMPARTIMENTARELE DIN CAZURILE NOASTRE SUNT COMPATIBILE CU BATERII DE 4.0AH ȘI 6.0AH.



PIESE DISPONIBILE

ACCESORII ȘI
PIESE DE SCHIMB

PAGINĂ 124

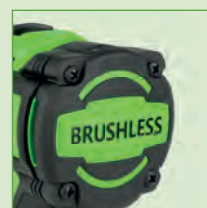

60009

168,00€



MAȘINĂ DE POLISAT ȘI LUSTRUIT CU MOTOR FĂRĂ PERII

BATERIA NU ESTE INCLUSĂ.

Instrumentul este destinat pentru procese de finisare, cum ar fi lustruirea și rotunjirea colțurilor și marginilor, precum și pentru obținerea suprafețelor netede cu ajutorul unui disc și un substrat de lustruire.



- A MOTOR BRUSHLESS
- B COMUTATOR DE TURĂȚIE CU 9 TREPTE:
800, 1000, 1200, 1400, 1600, 1800, 2000, 2200 ȘI 2400 RPM
- C COMUTATOR DE SECURITATE
- D MĂNER MOALE
- E MĂNER SUPPLEMENTAR ÎN FORMĂ DE D
- F BUTON DE BLOCARE A AXULUI PRINCIPAL
- G SUBSTRAT DE ȘLEFUIT
- H BATERIA NU ESTE INCLUSĂ



CHEIE HEXAGONALĂ

PIESE
DISPONIBILE

60033

104,00€



RÂȘNIȚĂ CU BATERII FĂRĂ PERII

BATERIA NU ESTE INCLUSĂ.

Acest instrument este conceput pentru șlefuirea lemnului, fierului, plasticului și a materialelor similare cu șmirghel adecvat. Această mașină de șlefuit este proiectată cu trei viteze, are un mâner confortabil și un sac de praf încorporat.

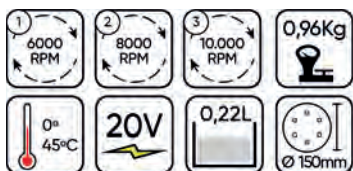

- A MOTOR BRUSHLESS
- B COMUTATORUL ON /BUTON DE CONTROL AL VITEZEI
- C COMUTATORUL OFF
- D COLECTOR DE PRAF
- E BAZĂ
- F BATERIA NU ESTE INCLUSĂ

PIESE
DISPONIBILE

60049C

329,00€



N

POLIZOR UNGHIULAR CU MOTOR FĂRĂ PERII 125MM CU VALIZĂ

INCLUDE

REF.	DESCRIERE					€
60013	BATERIE LI-ION 4.0 AH	0.75	-	5	700	80,00€
60016	ÎNCĂRCĂTOR 20 V - 4A	0.80	-	5	210	49,00€

BATERIA NU ESTE INCLUSĂ.

Polizorul unghiular fără fir este conceput pentru a efectua toate tipurile de lucrări de tăiere, lustruire și șlefuire. Include un mâner frontal și un capac de protecție.

8000 min⁻¹

CAPACUL DISCULUI DE RECTIFICARE

MÂNER SUPPLEMENTAR

BATERIA NU ESTE INCLUSĂ

COMPARTIMENTARELE DIN CAZURILE NOASTRE SUNT COMPATIBILE CU BATERII DE 4.0AH ȘI 6.0AH.



PIESE DISPONIBILE

ACCESORII ȘI PIESE DE SCHIMB

PAGINĂ 127



60028

142,00€



POLIZOR UNGHIULAR CU MOTOR BRUSHLESS - 125MM

BATERIA NU ESTE INCLUSĂ.

Polizorul unghiular fără fir este conceput pentru a efectua toate tipurile de lucrări de tăiere, lustruire și șlefuire. Include un mâner frontal și un capac de protecție.



CHEIA



PIESE DISPONIBILE

ACCESORII ȘI PIESE DE SCHIMB

PAGINĂ 127



60019

178,00€

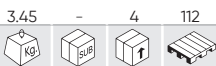

FIERĂSTRĂU ALTERNATIV CU MOTOR FĂRĂ PERII

BATERIA NU ESTE INCLUSĂ.

Acest instrument este destinat pentru tăierea unei varietăți largi de materiale și se caracterizează printr-o aplicare largă. Construcția asigură o înlocuire rapidă și comodă a pânzei de ferăstrău datorită clemei de strângere rapidă, și se caracterizează prin viteza de tăiere reglabilă în funcție de operația efectuată.



- A MOTOR BRUSHLESS
- B PÂNZĂ DE FERĂSTRĂU
- C SABOT
- D CLEMĂ DE STRĂNGERE RAPIDĂ
- E BUTONUL DE BLOCARE A BUTONULUI DE PORNIRE
- F MÂNER MOALE
- G BATERIA NU ESTE INCLUSĂ



PIESE
DISPONIBILE

ACCESORII ȘI PIESE DE SCHIMB

PAGINĂ 128

INCLUDE

- 1 BUC. LAMA PENTRU LEMN
- 1 BUC. LAMA PENTRU METAL

60020

175,00€



MAȘINĂ DE RABOTAT FĂRĂ PERII

BATERIA NU ESTE INCLUSĂ.

Acest instrument este destinat pentru lucrul cu lemnul. Vă permite să obțineți o suprafață netedă a lemnului și, dacă este necesar, să-i oferiți o formă conică.

Rindeaua este echipată cu o bază din aliaj de aluminiu pentru poziționarea precisă, un sistem de colectare a prafului pentru colectarea prafului după prelucrarea lemnului și un buton de blocare a trăgaciului pentru a preveni pornirea accidentală a sculei.

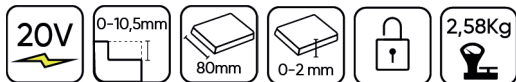

- A MOTOR BRUSHLESS
- B BUTON DE BLOCARE
- C BUTON DE REGLARE A ADÂNCIMII DE EȘANTIONARE
- D GHIDAJ DE TĂIERE PARALELĂ
- E GHIDAJ DE ADÂNCIME DE ÎMBINARE
- F MÂNER DE REGLARE A GHIDAJULUI DE ÎMBINARE
- G PORT DE ÎNDEPĂRTARE A PRAFULUI
- H CANELURĂ ÎN FORMĂ DE V
- I BATERIA NU ESTE INCLUSĂ



PIESE
DISPONIBILE

INCLUDE

- 1 BUC. BUTONUL DE REGLARE A ADÂNCIMII DE ÎMBINARE
- 1 BUC. GHIDAJ PARALEL
- 3 BUC. BUTOANE DE REGLARE
- 1 BUC. CHEIE
- 1 BUC. ȘURUB

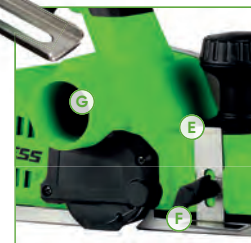

60010

170,00€

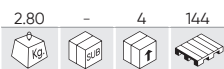

FIERĂSTRĂU PENDULAR CU MOTOR BRUSHLESS

BATERIA NU ESTE INCLUSĂ.

Acest instrument este proiectat pentru tăierea unor astfel de materiale, precum lemnul, oțelul, plasticul și metalul.

Trafoorul este echipat cu un mecanism cu pendul în 4 poziții: 3 poziții pentru tăiere orbitală și 1 poziție pentru tăiere directă, ceea ce vă permite să alegeți viteza optimă de tăiere a pânzei în funcție de duritatea materialului.

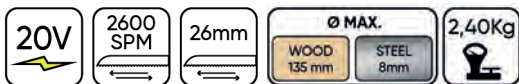

- A MOTOR BRUSHLESS
- B CAPAC DE PROTECȚIE A PÂNZEI DE FERĂSTRĂU
- C CLEMĂ DE STRÂNGERE RAPIDĂ
- D PÂNZĂ DE FERĂSTRĂU
- E REGULADOR AL CURSULUI BASCULABIL
- F PÂRGHIE DE REGLARE A SABOTULUI
- G BUTONUL DE BLOCARE A BUTONULUI DE PORNIRE
- H BATERIA NU ESTE INCLUSĂ



PIESE
DISPONIBILE

ACCESORII ȘI PIESE DE SCHIMB

PAGINĂ 128



INCLUDE

- 1 BUC. DISC PENTRU LEMN
- 1 BUC. GHIDAJ DE MARGINE
- 1 BUC. TUB DE COLECTARE A PRAFULUI

60007

170,00€



FIERĂSTRĂU CIRCULAR CU BATERIE

BATERIA NU ESTE INCLUSĂ.

Acest instrument este destinat pentru tăierea lemnului. Ferăstrău circular cu un diametru de 165mm cu 24 de dinți este ideal atât pentru tăieturi drepte longitudinale / transversale, cât și pentru tăierea panourilor și panourilor din lemn sub un unghi de 45°.



- A MOTOR BRUSHLESS
- B PÂRGHIA CAPACULUI INFERIOR DE PROTECȚIE
- C SABOT
- D CAPAC INFERIOR DE PROTECȚIE
- E MÂNER DE BLOCARE A UNGHILUI DE TĂIERE
- F MÂNER ANTERIOR
- G BUTON DE BLOCARE A TRĂGACIULUI
- H BATERIA NU ESTE INCLUSĂ



PIESE
DISPONIBILE

ACCESORII ȘI PIESE DE SCHIMB

PAGINĂ 128



INCLUDE

- 1 BUC. 165 MM 24T TCT DISC
- 1 BUC. GHIDAJ DE MARGINE
- 1 BUC. CHEIE HEXAGONALĂ

60011

175,00€

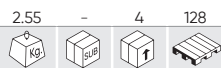

FIERĂSTRĂU CIRCULAR MINIATURAL CU MOTOR FĂRĂ PERII

BATERIA NU ESTE INCLUSĂ.

Acest instrument este destinat pentru tăierea lemnului. Ferăstrău circular cu un diametru de 115 mm cu 24 de dinți este ideal atât pentru tăieturi drepte longitudinale / transversale, cât și pentru tăierea panourilor și panourilor din lemn sub un unghi de 45°. Fierăstrăul are, de asemenea, un buton de blocare a trăgaciului pentru a preveni pornirea accidentală a sculei și o carcasă din aluminiu.



- A MOTOR BRUSHLESS
- B CAPACUL INFERIOR DE PROTECȚIE AL DISCULUI DE TĂIERE
- C PÂRGHIA CAPACULUI INFERIOR DE PROTECȚIE
- D PLACĂ DE SUPT
- E CAPACUL SUPERIOR DE PROTECȚIE AL DISCULUI DE TĂIERE
- F GHIDAJ PENTRU DESPICĂ
- G BUTON DE BLOCARE
- H BATERIA NU ESTE INCLUSĂ



INCLUDE
MECANISM DE BLOCARE
MÂNER MOALE
CARCASA SUPERIOARĂ
ȘI INFERIOARĂ DIN ALUMINIU
SISTEM DE COLECTARE A
PRAFULUI



PIESE
DISPONIBILE

**ACCESORII ȘI
PIESE DE SCHIMB**

PAGINĂ 128

60022

470,00€

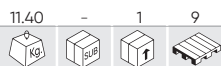

FIERĂSTRĂU DE DEBITAT CU GLISARE CU MOTOR FĂRĂ PERII

BATERIA NU ESTE INCLUSĂ.

Acest instrument este destinat pentru tăierea lemnului și a materialelor similare. Instrumentul vă permite să tăiați secțiuni oblice atunci când este necesară o tăietură înclinată de-a lungul suprafeței piesei de prelucrat, tăieri sub un unghi, utilizate, de regulă, pentru îmbinările care formează un unghi de 90°, precum și tăieturi combinate atunci când este necesară o tăiere unghiulară concomitent, atât de-a lungul marginii, cât și a suprafeței frontale a piesei de prelucrat.

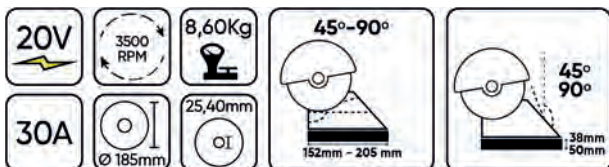

INCLUDE

- 1 BUC. FIERĂSTRĂU CIRCULAR CU 40 DE DINȚI
- 1 BUC. CLEMĂ
- 1 BUC. CHEIE PENTRU DISCUL DE TĂIAT
- 1 BUC. PUNGĂ DE COLECTARE A PRAFULUI



PIESE
DISPONIBILE

**ACCESORII ȘI
PIESE DE SCHIMB**

PAGINĂ 128



60032

123,00€

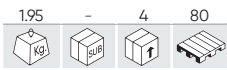

PISTOL DE SILICON CU BATERII

BATERIA NU ESTE INCLUSĂ.

Pistolul pentru silicon cu acumulator este conceput pentru a umple orice fisuri sau crăpături într-o mare varietate de materiale, cum ar fi metalul, sticla, lemnul și ceramica.



- A SUPORT CARTUȘ
- B PISTON
- C TIJA PISTONULUI
- D MÂNERUL TIJEI PISTONULUI
- E DECLANȘATORUL DEPLASĂRII TIJEI PISTONULUI
- F SELECTOR DE VITEZĂ
- G ILUMINARE LED
- H BATERIA NU ESTE INCLUSĂ

PIESE
DISPONIBILE

60038

255,00€



PISTOL BATERIEPENTRU GRESAT

BATERIA NU ESTE INCLUSĂ.

Acest instrument prezintă un pistol cu grăsime și este proiectat în scopuri de lubrifiere. Datorită designului fără fir și funcționării de la baterie poate fi ușor transportat și manipulat oriunde.



- A RUOTA DI REGOLAZIONE DELLA PORTATA DEL GRASSO
- B PULSANTE DI BLOCCO
- C LED DI ILLUMINAZIONE
- D TUBO FLESSIBILE
- E TUBO DI LUBRIFICAZIONE
- F VALVOLA DI SFIATO DI SICUREZZA
- G BATERIA NU ESTE INCLUSĂ

PIESE
DISPONIBILE

60041

77,00€



INSTRUMENT MULTI-FUNCȚIONAL OSCILANT FĂRĂ FIR

BATERIA NU ESTE INCLUSĂ.

Împreună cu un instrument multifuncțional oscilant, puteți utiliza diverse dispozitive care vă permit să efectuați o varietate de sarcini. Instrumentul este deosebit de util pentru striparea, măcinarea și tăierea profundă în locuri greu accesibile.

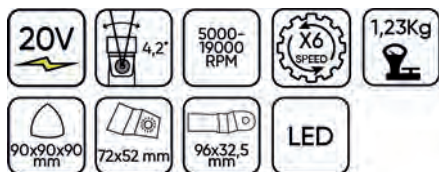

- A MOTOR BRUSHLESS
- B MANETA DE PRINDERE
- C CLEMĂ DE BLOCARE
- D ROATĂ DE REGLARE PENTRU SELECTAREA VITEZEI
- E LUMINA DE LUCRU
- F SUPORTUL INSTRUMENTULUI
- G BATERIA NU ESTE INCLUSĂ

**INCLUDE**

- 1 BUC. PÂNZA FERESTRĂULUI
- 1 BUC. FOAIE DE ȘLEFUIT
- 1 BUC. PLACĂ DE ȘLEFUIT
- 1 BUC. RĂZUIȚOR
- 1 BUC. ȘAIBĂ
- 1 BUC. MÂNER

60037

222,00€



PISTOL BATERIE DE ÎMPUȘCAT CUIE/STAPLER

BATERIA NU ESTE INCLUSĂ.

Acest instrument este conceput pentru atașarea cartonului, materialului izolat, țesăturii, foliei metalice subțire, pielii și materialilor similare pe suprafețe de lemn sau materiale asemănătoare lemnului, prin tragerea cu impact puternic sau folosind aer comprimat.



- A ILUMINARE LED
- B ȘTIFT DE SIGURANȚĂ
- C MAGAZIE
- D INDICATOR CU LED
- E SELECTOR MOD DE ACTIVARE
- F ÎNTRERUPĂTOR ILUMINARE LED
- G BATERIA NU ESTE INCLUSĂ

**ACCESORII ȘI
PIESE DE SCHIMB**

PAGINĂ 127

CAPSE DE TIP UȘOR CU DIMENSIUNEA ÎNGUSTĂ A VÂRFULUI 18

MAX. LUNGIMEA CAPSEI	40 mm
LĂȚIMEA MAXIMĂ A SECȚIUNII TRANSVERSALE A CAPSEI	1.2 mm
GROSIMEA MAXIMĂ A SECȚIUNII TRANSVERSALE A CAPSEI	1 mm
MAX. DIMENSIUNEA PĂRȚII SUPERIOARE A CAPSEI	6 mm

CUIE FĂRĂ DIMENSIUNEA CAPACULUI 18

MAX. LUNGIMEA CUIELOR	50 mm
LĂȚIMEA MAXIMĂ A SECȚIUNII TRANSVERSALE A CUIULUI	1.25 mm
GROSIMEA MAXIMĂ A SECȚIUNII TRANSVERSALE A CUIULUI	1.05 mm

60042

106,00€

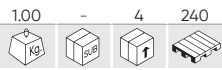

PISTOL TERMIC CU BATERII

BATERIA NU ESTE INCLUSĂ.

Pistolul pentru silicon cu acumulator este conceput pentru a umple orice fisuri sau crăpături într-o mare varietate de materiale, cum ar fi metalul, sticla, lemnul și ceramica.

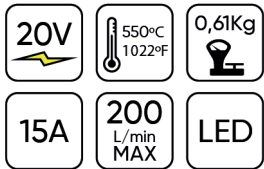

- A CAPAC FRONTAL
- B DUZA
- C ILUMINARE LED
- D INTERBLOCAREA COMUTATORULUI DE ALIMENTARE
- E CÂRLIG METALIC
- F BATERIA NU ESTE INCLUSĂ



PIESE DISPONIBILE

60043

123,00€



PISTOL DE VOPSIT FĂRĂ FIR

BATERIA NU ESTE INCLUSĂ.

Acest instrument este conceput pentru pulverizarea vopselei pe suprafețe interioare și exterioare.



- A REGULATOR DE DEBIT (VITEZĂ)
- B REZERVOR
- C BLOCARE REZERVOR
- D FILTRU DE AER
- E BATERIA NU ESTE INCLUSĂ



PIESE DISPONIBILE

FOLOȘIȚI-LE CU BATERII JBM: O SINGURĂ BATERIE POTRIVITĂ PENTRU TOATE INSTRUMENTELE

TREI TIPURI DE BATERII ȘI DOUĂ TIPURI DE ÎNCĂRCĂTOR.
ALEGEȚI-L PE CEL PREFERAT!

*Baterii și ÎNCĂRCĂTOARE NEINCLUSE în scule.



60001

88,00€



ASPIRATOR PORTABIL

BATERIA NU ESTE INCLUSĂ.

Acest aspirator electric fără fir este conceput pentru curățarea oricăror materiale sigure pentru sănătate.



- A COLECTOR DE PRAF
- B BUTONUL DE EXTRAGERE A COLECTORULUI DE PR
- C ÎNTRERUPĂTOR PRINCIPAL
- D CARCASA MOTORULUI
- E DUZĂ CU FANTĂ
- F DUZĂ-PERIE
- G DUZĂ PENTRU PODEA
- H TUB PRELUNGITOR
- I BATERIA NU ESTE INCLUSĂ



INCLUDE

REF.	DESCRIERE					€
14950	TUB PRELUNGITOR PENTRU REF. 60001	0.08	5	10	-	6,50€
14951	DUZĂ CU FANTĂ PENTRU REF. 60001	0.01	-	10	-	9,50€
14952	DUZĂ DE PODEA PENTRU REF. 60001	0.15	-	5	-	19,00€
14953	PERIE PENTRU REF. 60001	0.05	-	10	-	8,50€

60003

110,00€



POMPĂ ELECTRICĂ PENTRU UMFLAREA ROȚILOR

BATERIA NU ESTE INCLUSĂ.

Acest umflator vă permite să umflați roți de mașini și motociclete, mingii, bărci gonflabile, saltele gonflabile etc.



- A LUMINĂ LED
- B BUTON DE ALIMENTARE CU LUMINĂ LED
- C SELECTOR DE MOD DE LUCRU
- D BUTOANE DE SELECTARE A PRESIUNII
- E CONECTOR USB
- F FURTUN DE ÎNALTĂ PRESIUNE
- G FURTUN DE MARE CAPACITATE
- H PRIZA BRICHETA DE 12V
- I BATERIA NU ESTE INCLUSĂ



INCLUDE



60004

79,00€



LAMPĂ DE LUCRU CU DIODĂ ELECTROLUMINISCENTĂ

BATERIA NU ESTE INCLUSĂ.

Această lanternă cu LED-uri de lucru este destinată pentru a crea iluminatul necesar în zona de lucru și în alte locuri. Când bateria este descărcată, luminatorul poate fi conectat la o rețea de 230 V cu un cablu de rețea, aflat pe partea din spate a unității.

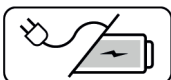

- A ÎNTRERUPĂTOR (PORNIRE / OPRIRE)
- B CAPUL ROTATIV AL LUMINATORULUI DE LUCRU
- C MATRICE CU DIODĂ ELECTROLUMINISCENTĂ
- D BLOCARE LATERALĂ A POZIȚIEI
- E CABLU DE REȚEA
- F BATERIA NU ESTE INCLUSĂ



PIESE DISPONIBILE

REF. DESCRIERE

REF.	DESCRIERE	kg	box	unit	€	
15049	STAND PENTRU LAMPĂ DE LUCRU CU DIODĂ ELECTROLUMINISCENTĂ (ART. 60004)	2.10	-	4	120	37,40€

60035

30,00€



LAMPĂ LED PORTABILĂ PENTRU LUCRU

BATERIA NU ESTE INCLUSĂ.

Lanternă de lucru cu LED este proiectată pentru a oferi iluminare necesară în zona de lucru și în alte locuri. Lanterna este alimentată de o baterie litiu-ion, făcând-o portabilă și ideală potrivită pentru orice spațiu de lucru sau situații în care alimentarea cu energie electrică este limitată.

Difuzorul lămpii cu LED oferă un flux luminos de 500 și 1000 de lumeni, iar mecanismul de pivotare al lămpii (90°) vă permite să reglați unghiul dorit de înclinare. De asemenea, setul de livrare include un mâner moale pentru o manevrare mai confortabilă și un cârlig pentru agățare la un alt obiect.



- A DIFUZOR
- B MECANISM PIVOTANT
- C CÂRLIG PENTRU AGĂȚAT
- D COMUTATORUL ON / OFF
- E BATERIA NU ESTE INCLUSĂ



PIESE DISPONIBILE



60039

265,00€

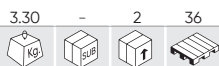

BATERIE SPĂLATOR CU PRESIUNE

BATERIA NU ESTE INCLUSĂ.

Mașina de spălat cu presiune cu motor fără perii este proiectată pentru curățarea vehiculelor, echipamentelor, uneltelor, mobilierului de grădină etc.

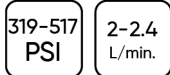

- A MOTOR BRUSHLESS
- B DUZĂ ROTATIVĂ CU 5 POZIȚII
- C CUPLAJ CU ELIBERARE RAPIDĂ A DUZEI
- D TUB
- E INDICATOR DE PRESIUNE
- F COMUTATOR SELECTOR DE PRESIUNE
- G COMUTATOR DE BLOCARE
- H CUPLAJ CU ELIBERARE RAPIDĂ A FURTUNULUI
- I BATERIA NU ESTE INCLUSĂ



PIESE DISPONIBILE



60027

99,00€



PULVERIZATOR ELECTRIC INDUSTRIAL PURTAT ÎN SPATE CU REZERVOR 15 L

BATERIA NU ESTE INCLUSĂ.

Instrumentul este potrivit pentru dezinfectarea caselor, a locurilor publice, a fermelor zootehnice, grădinilor, etc., și permite de a distruge toate particulele periculoase, de a preveni răspândirea acestora și, concomitent, împiedică înmulțirea insectelor și dezvoltarea bolilor. Mâner inteligent care asigură blocarea pentru funcționarea continuă. De asemenea, setul de livrare include 4 duze cu un flux și performanță specifice, în funcție de cerințele impuse: 1 duză conică tubulară, 1 duză conică tubulară dublă, 1 duză reglabilă cu 4 orificii, 1 duză în evantai.



- A MÂNER PENTRU TRANSPORT UȘOR
- B PERNĂ PENTRU SPATE RESPIRABILĂ ȘI ERGONOMICĂ
- C CAPAC DE UMLERE CU DISPOZITIV DE BLOCARE
- D SUPORT TELESCOPIC PENTRU PULVERIZARE
- E BATERIA NU ESTE INCLUSĂ

NU ACCEPTĂ BATERII DE 6,0 AH

INCLUDE



60029

240,00€

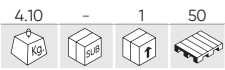

AKKUS FŪRÉSZCU MOTOR FĂRĂ PERIE

BATERIA NU ESTE INCLUSĂ.

Acest instrument pentru exploatare forestieră este conceput pentru sarcini cum ar fi doborârea copacilor, curățirea cracilor, debitarea trunchiurilor și tăierea copacilor. Instrumentul este echipat cu un mâner pentru reglarea tensiunii barei de ghidare și a lanțului, cu o frână de lanț pentru a opri lanțul în caz de recul și cu un dispozitiv de prindere a lanțului pentru a-l prinde în caz dacă acesta se va rupe sau se va desprinde. În plus este dotat cu un sistem automat de lubrifiere a lanțului și cu un buton de blocare a declanșatorului pentru a preveni pornirea accidentală. Instrumentul constă dintr-o bară de ghidare, un lanț și protecție pentru a proteja atât bara, cât și lanțul în timpul transportului și depozitării.



- A MOTOR BRUSHLESS
- B LANȚ DE FERĂSTRĂU
- C BARA DE GHIDARE
- D FRÂNĂ LANȚ / PROTECȚIE FAȚĂ
- E MÂNER FRONTAL
- F BUTON DE BLOCARE
- G CAPACUL REZERVORULUI DE ULEI
- H BATERIA NU ESTE INCLUSĂ



INCLUDE



PIESE DISPONIBILE

60030

112,00€

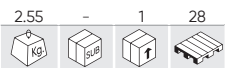

SUFLANTĂ BATERIE

BATERIA NU ESTE INCLUSĂ.

Acest instrument este conceput pentru curățarea terenului de frunze, iarbă, hârtie și materiale similare. Design-ul cu alimentare prin baterii și greutate redusă face transportul dispozitivului dintr-un loc în altul foarte ușor. Proiectat cu un comutator de volum debit de aer ridicat/ scăzut și un mâner cu înveliș moale pentru o manipulare ușoară.



- A MOTOR BRUSHLESS
- B TUB
- C VÂRFUL TUBULUI SUFLANTEI
- D CARCASĂ
- E BATERIA NU ESTE INCLUSĂ

NU ACCEPTĂ BATERII DE 6,0 AH

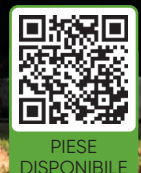

PIESE DISPONIBILE

60031

142,00€



FOARCINE BATERIE PENTRU SPELLER

BATERIA NU ESTE INCLUSĂ.

Acest instrument este destinat executării rapide și ușoare a sarcinilor de grădinarit, cum ar fi curățarea, tunsul sau tăierea gardurilor vii sau tușurilor. Design-ul cu alimentare prin baterii și greutate redusă face transportul dispozitivului dintr-un loc în altul foarte ușor. Setul include un capac de protecție a lamei, care menține mașina de tuns gardul viu în condiții bune, o manta de protecție, care îndepărtează crengile tăiate și alte resturi de la mâinile și ochii operatorului și un mâner opțional care oferă un control mai mare și condiții de lucru mai confortabile. În plus, conform designului mașina de tuns gardul viu este echipată cu două întrerupătoare și un buton de blocare, care previne pornirea accidentală a instrumentului.



- A MOTOR BRUSHLESS
- B LAMA TĂIETOARE
- C SUPORT LAMĂ
- D CARCASĂ
- E MÂNER AUXILIAR
- F ÎNTRERUPĂTOR SUPLIMENTAR
- G BUTON DE BLOCARE
- H MÂNERUL DIN SPATE
- I BATERIA NU ESTE INCLUSĂ



INCLUDE
CAPAC DE PROTECȚIE



60040

440,00€



MAȘINĂ AGRICULTURALĂ MULTIFUNCȚIONALĂ CU BATERIE (4 ÎN 1)

BATERIA NU ESTE INCLUSĂ.

Mașina de grădină electrică multifuncțională 4 în 1 este proiectată pentru o serie de sarcini în aer liber, cum ar fi degajarea spațiilor verzi, tăierea gardurilor vii, tăierea ramurilor etc. Este un produs ideal pentru întreținerea generală a grădinii.

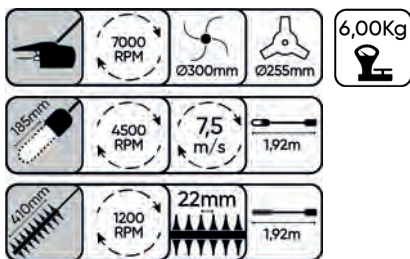

- A MOTOR BRUSHLESS
- B CAPAC DE PROTECȚIE
- C LAMĂ CU TREI DINȚI
- D LAMĂ
- E FIERĂSTRĂU
- F MÂNERE
- G MOTOCOASĂ DE TĂIAT ARBUȘTI
- H CAP DE COSIT
- I FOARFECĂ DE TUNS GARD VIU
- J FIERĂSTRĂU CU BARĂ
- K BATERIA NU ESTE INCLUSĂ



52598

1.080,00€

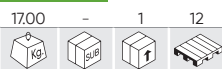

ROBOT - MAȘINĂ DE TAIAT IARBA

Mașină de tuns iarba robotizată, modernă și funcțională, perfectă pentru îngrijirea și întreținerea gazonului și a spațiilor verzi. Este echipat cu un motor alimentat de o baterie puternică de 5200 Ah, pentru o autonomie de aproximativ 150 de minute. Are trei lamele din oțel pentru o tăiere tăiere eficientă. Acest sistem de tăiere mărunțește foarte fin iarba și apoi o eliberează direct pe jos, dându-i gazonului un aspect impecabil, fără necesitatea de a arunca resturile la gunoi. În plus, cu această tundere, iarba depusă pe gazon se va descompune și va deveni îngrășământ pentru ea însăși, creând un ciclu biologic complet și natural. Dispozitivul permite o instalare ușoară, fără lucrări și fără unelte.

5200 mAh Capacitate de stocare a energiei	1400m ² Suprafața de lucru	IP X4	DC 15-25.5V Tensiune de alimentare	2,5h	22m/min
115,44W Consum de energie	AC 100-240V 50/60Hz	7,5Kg	2h	70 dB(A)	50-35,5-24 cm



CONEXIUNEA APP



- A MOTOR BRUSHLESS
- B BUTON DE BLOCARE STOP
- C STAȚIE DE ÎNCĂRCARE
- D ROATA DIN SPATE
- E CAPACUL MÂNERULUI



PIESE DISPONIBILE

60045

298,00€



MAȘINĂ DE TUNS IARBA FĂRĂ FIR

BATERIA NU ESTE INCLUSĂ.

Această mașină de tuns iarba fără fir vă ajută să vă păstrați grădina în stare perfectă. Este echipată cu un motor fără perii care crește eficacitatea și reduce nivelul de zgomot. De asemenea, este foarte ușoară și ușor de utilizat.

40V	800W	35L	11,6 Kg.
3.300 RPM	6x 25-75mm	152 - 203mm Ø	370mm Ø
96 dB(A)	IP X1	4.0A	11,40Kg



- A MOTOR BRUSHLESS
- B MAȘINĂ DE TUNS IARBA
- C MÂNER
- D SAC DE PRINDERE A IERBII

FUNȚIONEAZĂ CU 2 BATERII DE 4AH (NU SUNT INCLUSE)



PIESE DISPONIBILE

**FOLOȘIȚI-LE CU BATERII JBM:
O SINGURĂ BATERIE POTRIVITĂ
PENTRU TOATE INSTRUMENTELE**

TREI TIPURI DE BATERII ȘI DOUĂ TIPURI DE ÎNCĂRCĂTOR.
ALEGEȚI-L PE CEL PREFERAT!

**Baterii și ÎNCĂRCĂTOARE NEINCLUSE în scule.*



BATERIE LI-ION



INDICATOR DE ALIMENTARE



PROTECȚIE ÎMPOTRIVA SCURT-CIRCUITULUI



PROTECȚIE ÎMPOTRIVA SUPRAÎNCĂLZIRII



PROTECȚIE LA SUPRAÎNCĂRCARE



60012

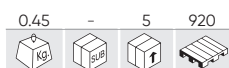

48,00€



60013

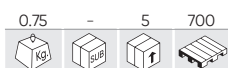

80,00€



60015



138,00€

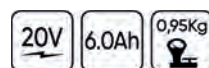

PENTRU REF. 60024

60026

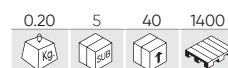

37,90€

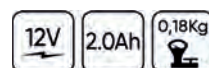

ÎNCĂRCĂTOR



INDICATOR DE ALIMENTARE



PROTECȚIE ÎMPOTRIVA SCURT-CIRCUITULUI



PROTECȚIE ÎMPOTRIVA SUPRAÎNCĂLZIRII



PROTECȚIE LA SUPRAÎNCĂRCARE



60016



49,00€



ÎNALTĂ PERFORMANȚĂ

60017



64,00€

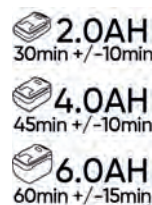

PENTRU REF. 60026

60025

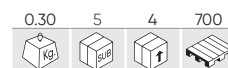

31,60€

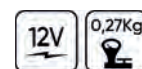

ACCESORII PENTRU STAND



REF. DESCRIERE	mm						€
14622 SUPORT PENTRU REF. 60001, 60003, 60004, 60020	320x180	A	0.95	-	10	360	17,00€
14623 CÂRLIG PENTRU REF. 60005, 60006, 60018	70x84	B	0.10	-	10	800	8,00€
14624 JGHEAB PENTRU REF. 60007, 60010, 60011	290x160	C	0.65	-	10	300	17,00€
14625 CÂRLIG PENTRU REF. 60008, 60009	40x200x100	D	0.50	-	10	700	14,00€
14626 CÂRLIG PENTRU REF. 60023	115x70	E	0.10	-	10	-	7,00€
16364 CÂRLIG CU UN CAPĂT 280MM	280		0.20	-	200	-	3,50€

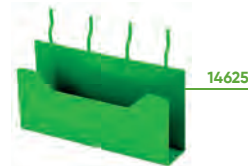
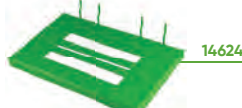

PIESE DE SCHIMB



60023

DALTĂ SDS-PLUS

REF. DESCRIERE				€
14837 DALTĂ CU CAPĂT ASCUȚIT SDS-PLUS 14X250MM	0.25	10	100	3,30€
14838 DALTA CU CAP PLAT SDS-PLUS 20X250MM	0.25	10	100	3,40€
14839 DALTĂ CU CAPĂT ASCUȚIT SDS-PLUS 40X250MM	0.29	10	50	4,70€
14840 DALTĂ CU CANELURĂ SDS-PLUS 250MM	0.27	10	50	3,35€



14837



14838



14839



14840

53850

14,90€



SET DE BURGHII SDS PLUS PENTRU CIOCAN ROTOPERCUTOR



PIESE DISPONIBILE

REF.	mm				€
14826	Ø 5x110mm	0.05	125	500	1,50€
14828	Ø 6x110mm	0.05	25	500	1,50€
14829	Ø 6x160mm	0.04	25	500	1,50€
14830	Ø 8x110mm	0.04	25	500	1,50€
14831	Ø 8x160mm	0.05	25	500	1,50€
14832	Ø 10x160mm	0.05	25	200	2,00€
14920	Ø 12x160mm	0.10	100	200	2,50€

AȚI PUTEA DORI, DE ASEMENEA...

REF.	mm				€
14825	Ø 4x110mm	0.05	100	200	1,50€
14827	Ø 5x160mm	0.04	25	500	2,00€
14833	Ø 10x210mm	0.10	20	200	2,05€
14834	Ø 12x210mm	0.10	100	200	2,50€
14835	Ø 14x210mm	0.10	20	125	3,00€
14836	Ø 16x210mm	0.14	20	120	3,50€



SCULE ELECTRICE FĂRĂ FIR

14841

2,58€

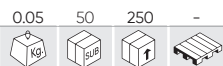

ADAPTOR SDS-PLUS PENTRU MANDRINA
MAȘINII DE GĂURIT 1/2"



14842

9,50€



MANDRINĂ MAȘINII DE GĂURIT CU
SCHIMBARE RAPIDĂ 2-13 MM 1/2"-20 UNF
(FILET MIC UNIFICAT)

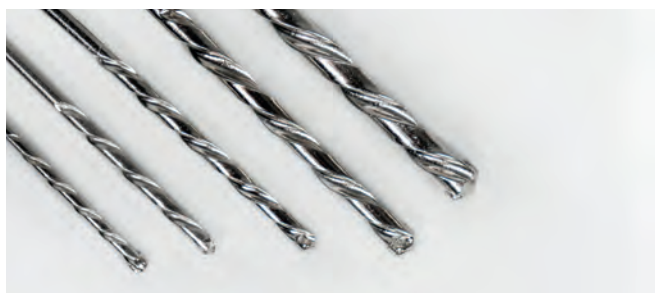

60006
60047C

53860

3,65€

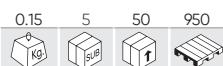

SET DE BURGHII PENTRU BETON 4-10 MM



PIESE DISPONIBILE

REF.	mm				€
14908	Ø 4x75mm	0.01	50	100	0,60€
14909	Ø 5x80mm	0.01	50	100	0,80€
14910	Ø 6x100mm	0.01	50	100	1,00€
14912	Ø 8x120mm	0.05	50	100	1,55€
14914	Ø 10x120mm	0.04	20	100	2,10€

AȚI PUTEA DORI, DE ASEMENEA...

REF.	mm				€
14915	Ø 11x150mm	0.05	20	100	2,65€
14916	Ø 12x150mm	0.06	20	100	2,95€
14917	Ø 13x150mm	0.10	20	100	3,45€



53861

5,45€

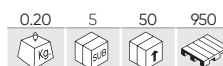

SET DE BURGHII PENTRU BETON 3-10 MM



PIESE DISPONIBILE

REF.	mm				€
14907	Ø 3x60mm	0.01	50	100	0,50€
14908	Ø 4x75mm	0.01	50	100	0,60€
14909	Ø 5x80mm	0.01	50	100	0,80€
14910	Ø 6x100mm	0.01	50	100	1,00€
14911	Ø 7x100mm	0.01	50	100	1,30€
14912	Ø 8x120mm	0.05	50	100	1,55€
14913	Ø 9x120mm	0.05	50	100	1,90€
14914	Ø 10x120mm	0.04	20	100	2,10€



53859

67,00€



SET DE FIERĂSTRAIE CIRCULARE BIMETALICE CU ADAPTOARE



	x6	22, 29, 35, 44, 51, 68mm
	x2	14-30mm, 32-152mm



PIESE DISPONIBILE

REF.	mm				€
14901	22mm	0.04	10	50	3,60€
14902	29mm	0.08	10	50	4,65€
14903	35mm	0.10	10	50	5,25€
14904	44mm	0.12	10	50	6,85€
14905	51mm	0.12	10	50	8,50€
14906	68mm	0.19	10	50	10,20€
14934	14-30mm	0.07	10	50	4,25€
14935	32-152mm	0.20	10	50	8,45€

SET DE BURGHII ELICOIDALE HSS 4341

53852

207,00€

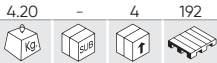

1x34, 1.5x40, 2x49, 2.5x57, 3x61, 3.5x70, 4x75, 4.5x80, 5x86, 5.5x93, 6x93, 6.5x101, 7x109, 7.5x109, 8x117, 8.5x117, 9x125, 9.5x125, 10x133mm

53856

62,00€

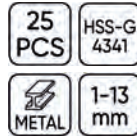
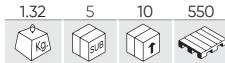

1x34, 1.5x40, 2x49, 2.5x57, 3x61, 3.5x70, 4x75, 4.5x80, 5x86, 5.5x93, 6x93, 6.5x101, 7x109, 7.5x109, 8x117, 8.5x117, 9x125, 9.5x125, 10x133, 10.5x133, 11x142, 11.5x142, 12x151, 12.5x151, 13x151mm

53854

27,00€

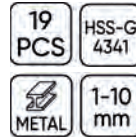
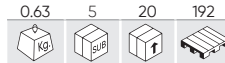

1x34, 1.5x40, 2x49, 2.5x57, 3x61, 3.5x70, 4x75, 4.5x80, 5x86, 5.5x93, 6x93, 6.5x101, 7x109, 7.5x109, 8x117, 8.5x117, 9x125, 9.5x125, 10x133mm

PIESE DISPONIBILE

REF.	mm				€
14868	Ø 1x34mm	0.01	50	400	0,55€
14869	Ø 1.5x40mm	0.01	50	400	0,60€
14870	Ø 2x49mm	0.01	50	400	1,00€
14871	Ø 2.5x57mm	0.01	50	400	1,00€
14872	Ø 3x61mm	0.01	50	400	1,00€
14873	Ø 3.5x70mm	0.01	50	400	1,00€
14874	Ø 4x75mm	0.01	50	400	1,00€
14875	Ø 4.5x80mm	0.01	50	400	1,50€
14876	Ø 5x86mm	0.01	50	300	1,50€
14877	Ø 5.5x93mm	0.02	50	300	1,50€
14878	Ø 6x93mm	0.02	25	400	2,00€
14879	Ø 6.5x101mm	0.02	25	400	2,00€
14880	Ø 7x109mm	0.03	25	400	2,50€
14881	Ø 7.5x109mm	0.03	25	400	2,50€
14882	Ø 8x117mm	0.04	25	400	3,00€
14883	Ø 8.5x117mm	0.04	25	400	3,50€
14884	Ø 9x125mm	0.05	25	400	3,65€
14885	Ø 9.5x125mm	0.05	25	400	4,00€
14886	Ø 10x133mm	0.06	25	400	4,60€
14887	Ø 10.5x133mm	0.07	25	400	5,00€
14888	Ø 11x142mm	0.08	25	400	6,00€
14889	Ø 11.5x142mm	0.09	25	400	6,50€
14890	Ø 12x151mm	0.10	25	300	7,00€
14891	Ø 12.5x151mm	0.09	25	200	7,50€
14892	Ø 13x151mm	0.09	25	200	8,00€

SET DE BURGHII ELICOIDALE HSS 4241 NEGRU

53851

88,00€



1x34, 1.5x40, 2x49, 2.5x57, 3x61, 3.5x70, 4x75, 4.5x80, 5x86, 5.5x93, 6x93, 6.5x101, 7x109, 7.5x109, 8x117, 8.5x117, 9x125, 9.5x125, 10x133mm

53855

24,80€

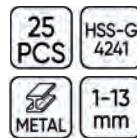
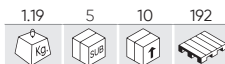

1x34, 1.5x40, 2x49, 2.5x57, 3x61, 3.5x70, 4x75, 4.5x80, 5x86, 5.5x93, 6x93, 6.5x101, 7x109, 7.5x109, 8x117, 8.5x117, 9x125, 9.5x125, 10x133, 10.5x133, 11x142, 11.5x142, 12x151, 12.5x151, 13x151mm

53853

14,40€

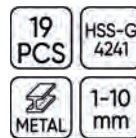
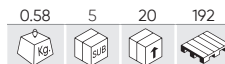

1x34, 1.5x40, 2x49, 2.5x57, 3x61, 3.5x70, 4x75, 4.5x80, 5x86, 5.5x93, 6x93, 6.5x101, 7x109, 7.5x109, 8x117, 8.5x117, 9x125, 9.5x125, 10x133mm

PIESE DISPONIBILE

REF.	mm				€
14843	Ø 1x34mm	0.01	50	400	0,50€
14844	Ø 1.5x40mm	0.01	50	400	0,50€
14845	Ø 2x49mm	0.01	50	400	0,50€
14846	Ø 2.5x57mm	0.01	50	400	0,50€
14847	Ø 3x61mm	0.01	50	400	0,50€
14848	Ø 3.5x70mm	0.01	50	400	0,50€
14849	Ø 4x75mm	0.01	50	400	1,00€
14850	Ø 4.5x80mm	0.01	50	400	1,00€
14851	Ø 5x86mm	0.01	50	300	1,00€
14852	Ø 5.5x93mm	0.01	50	300	1,00€
14853	Ø 6x93mm	0.02	25	400	1,00€
14854	Ø 6.5x101mm	0.02	25	400	1,00€
14855	Ø 7x109mm	0.02	25	400	1,00€
14856	Ø 7.5x109mm	0.03	25	400	1,00€
14857	Ø 8x117mm	0.03	25	400	1,50€
14858	Ø 8.5x117mm	0.04	25	400	1,50€
14859	Ø 9x125mm	0.04	25	400	1,50€
14860	Ø 9.5x125mm	0.05	25	400	2,00€
14861	Ø 10x133mm	0.05	25	400	2,00€
14862	Ø 10.5x133mm	0.06	25	400	2,00€
14863	Ø 11x142mm	0.07	25	400	2,50€
14864	Ø 11.5x142mm	0.07	25	400	2,50€
14865	Ø 12x151mm	0.08	25	300	2,50€
14866	Ø 12.5x151mm	0.09	25	200	3,00€
14867	Ø 13x151mm	0.09	25	200	3,00€

SET DE BURGHIE CU FILET HSS-CO5 COBALT

N

54348 291,00€



170 PCS HSS CO5

METAL 1-10 mm

54314 82,00€



25 PCS HSS CO5

METAL 1-13 mm

54313 43,00€



19 PCS HSS CO5

METAL 1-10 mm

PIESE DISPONIBILE

REF.	mm				€
16318	Ø 1x34mm	0.50	25	400	0,50€
16319	Ø 1.5x40mm	0.50	25	400	0,50€
16320	Ø 2x49mm	0.50	25	400	0,50€
16321	Ø 2.5x57mm	0.50	25	400	1,00€
16322	Ø 3x61mm	0.50	25	400	1,00€
16323	Ø 3.5x70mm	0.50	25	400	1,00€
16324	Ø 4x75mm	0.05	25	400	1,50€
16325	Ø 4.5x80mm	0.50	25	400	1,50€
16326	Ø 5x86mm	0.50	25	400	2,00€
16327	Ø 5.5x93mm	0.50	25	400	2,00€
16328	Ø 6x93mm	0.50	25	400	2,50€
16329	Ø 6.5x101mm	0.50	25	400	3,00€
16330	Ø 7x109mm	0.50	25	400	3,50€
16331	Ø 7.5x109mm	0.50	25	400	3,50€
16332	Ø 8x117mm	0.50	25	400	4,00€
16333	Ø 8.5x117mm	0.05	5	200	4,50€
16334	Ø 9x125mm	0.50	25	200	5,50€
16335	Ø 9.5x125mm	0.50	25	200	6,00€
16336	Ø 10x133mm	0.50	25	200	6,50€
16583	Ø 10.5x133mm	0.07	25	200	8,50€
16584	Ø 11x142mm	0.07	25	200	10,50€
16585	Ø 11.5x142mm	0.08	25	200	11,50€
16586	Ø 12x151mm	0.10	25	200	13,00€
16587	Ø 12.5x151mm	0.10	25	200	14,00€
16588	Ø 13x151mm	0.11	25	200	15,00€



1x34, 1.5x40, 2x49, 2.5x57, 3x61, 3.5x70, 4x75, 4.5x80, 5x86, 5.5x93, 6x93, 6.5x101, 7x109, 7.5x109, 8x117, 8.5x117, 9x125, 9.5x125, 10x133mm

1x34, 1.5x40, 2x49, 2.5x57, 3x61, 3.5x70, 4x75, 4.5x80, 5x86, 5.5x93, 6x93, 6.5x101, 7x109, 7.5x109, 8x117, 8.5x117, 9x125, 9.5x125, 10x133, 10.5x133, 11x142, 11.5x142, 12x151, 12.5x151, 13x151mm

1x34, 1.5x40, 2x49, 2.5x57, 3x61, 3.5x70, 4x75, 4.5x80, 5x86, 5.5x93, 6x93, 6.5x101, 7x109, 7.5x109, 8x117, 8.5x117, 9x125, 9.5x125, 10x133mm

53857

27,00€



SET S2 BIȚI PERCUTANȚI CU SCHIMBARE RAPIDĂ - ACOPERIRE NEAGRĂ

57 PCS S2



ÎN INTERPRET 6 UNITĂȚI



INCLUDE

	x9	PH	25mm	1x3, 2x3, 3x3
	x9	PZ	25mm	1x3, 2x3, 3x3
	x4	H	25mm	3, 4, 5, 6
	x6	SL	25mm	4x2, 5x2, 6x2
	x14	TX	25mm	10x2, 15x2, 20x2, 25x2, 27x2, 30x2, 40x2
	x7	T	25mm	10, 15, 20, 25, 27, 30, 40
	x7		65mm	PH2, PH3, PZ1, PZ2, T20, T25, SL6
	x1		60mm	

* DE ASEMENEA, ESTE COMPATIBILĂ CU REF. 60005

53858

28,80€



SET S2 BIȚI PERCUTANȚI CU ADAPTOARE - ACOPERIRE NEAGRĂ

33 PCS S2



ÎN INTERPRET 6 UNITĂȚI



INCLUDE

	x4	PH	25mm	1, 2x2, 3
	x3	PZ	25mm	1, 2, 3
	x4	H	25mm	3, 4, 5, 6
	x4	SL	25mm	3, 4, 5, 6
	x6	TX	25mm	10, 15, 20, 25, 30, 40
	x6		75mm	T15, T20, T25, PH2, PZ2, SL5
	x4		48mm	6, 7, 8, 10mm
	x1		60mm	
	x1		80mm	

* DE ASEMENEA, ESTE COMPATIBILĂ CU REF. 60005

54346

11,50€

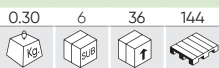

N

SET DE 3 PERII DE CURĂȚARE PENTRU BURGHIE

3 PCS PP 1/4"

- A Ø 88mm
- B Ø 100mm
- C Ø 50mm



60037

SET CUIE FĂRĂ CAP

REF.	mm				€
53999	25x1,25mm	0.20	-	50	2,00€
54000	30x1,25mm	0.25	-	50	2,50€
54002	38x1,25mm	0.30	-	50	3,00€

1000 PCS

SET DE SCOABE

REF.	mm				€
54008	25x6mm	0.45	-	40	3,50€
54010	32x6mm	0.55	-	40	4,50€
54011	38x6mm	0.65	-	40	5,00€

1000 PCS



60028
60049C

15014

20,00€



M14 115-230 mm

PIULIȚĂ DE BLOCARE RAPID-DETAȘABILĂ M14 PENTRU POLIZOR UNGHIULAR



SCULE ELECTRICE FĂRĂ FIR

PENTRU METAL

REF.	PENTRU	DESCRIERE					€
14893	60008	T42 - 115x2,5mm	0.05	50	100	-	2,00€
14894	60028	T42 - 125x2,5mm	0.05	50	200	-	1,20€
14895	60008	T27 - 115x6mm	0.15	25	100	-	1,90€
14896	60028	T27 - 125x6mm	0.78	25	100	-	2,10€

PENTRU OȚEL INOXIDABIL

REF.	PENTRU	DESCRIERE					€
14897	60008	T41 - 115x1mm	0.01	50	400	-	0,88€
14898	60028	T41 - 125x1mm	0.03	50	400	-	0,98€
14899	60008	T41 - 115x1,6mm	0.03	50	400	-	0,88€
14900	60028	T41 - 125x1,6mm	0.04	50	400	-	0,98€



14893

T27	80 m/s	13300 RPM
Ø115mm	Ø22,23mm	



14894

T42	80 m/s	12200 RPM
Ø125mm	Ø22,23mm	



14897

T41	80 m/s	13300 RPM
Ø115mm	Ø22,23mm	



14898

T41	80 m/s	12200 RPM
Ø125mm	Ø22,23mm	



14895

T42	80 m/s	13300 RPM
Ø115mm	Ø22,23mm	



14896

T27	80 m/s	12200 RPM
Ø125mm	Ø22,23mm	



14899

T41	80 m/s	13300 RPM
Ø115mm	Ø22,23mm	



14900

T41	80 m/s	12200 RPM
Ø125mm	Ø22,23mm	



PENTRU METAL (OȚEL INOXIDABIL, ALUMINIU, CUPRU)

REF.	PENTRU	DESCRIERE					€
14988	60007	24T 165mm	0.25	20	40	2400	8,00€
14989	60011	24T 115mm	0.10	20	100	3600	6,00€
14990	60022	40T 185mm	0.30	20	40	2200	10,50€
14993	60010	T118A	0.05	20	200	7200	5,00€
14995	60019	150mm 24TPI	0.05	20	200	8400	8,00€

PENTRU LEMN

REF.	PENTRU	DESCRIERE					€
14985	60007	24T 165mm	0.25	20	40	2400	6,00€
14986	60011	24T 115mm	0.10	20	100	3600	4,00€
14987	60022	40T 185mm	0.30	20	40	2200	8,50€
14991	60010	T244D	0.05	20	200	7200	2,00€
14994	60019	150mm 6TPI	0.05	20	200	8400	3,50€



14989

	x24	7000 RPM
Ø115mm	Ø10mm	



14988

	x24	7000 RPM
Ø165mm	Ø20mm	



14990

	x40	7000 RPM
Ø185mm	Ø25,4mm	



14955

	24TPI	10mm CORN H&A H&A CUT
150mm		



14994

	6TPI	150mm CORN H&A H&A CUT
150mm		



14991

	T244D	100mm CORN H&A H&A CUT
100mm		



14993

	T118A	8mm CORN H&A H&A CUT
76mm		



14986

	x24	7000 RPM
Ø115mm	Ø10mm	



14985

	x24	7000 RPM
Ø165mm	Ø20mm	



14987

	x40	7000 RPM
Ø185mm	Ø25,4mm	

ILUMINAT

- 130 LĂMPI DE INSPECȚIE
- 132 LANTERNE DE CAP
- 134 LAMPĂ DE MĂRIRE CU LED
- 135 REFLECTOARE CU LED
- 136 LĂMPI DE CAPOTĂ
- 137 GIROFARURI
- 139 LAMPI DE LUCRU CU LED
- 142 SEMNALIZARE
- 144 ACCESORII ȘI PIESE DE SCHIMB

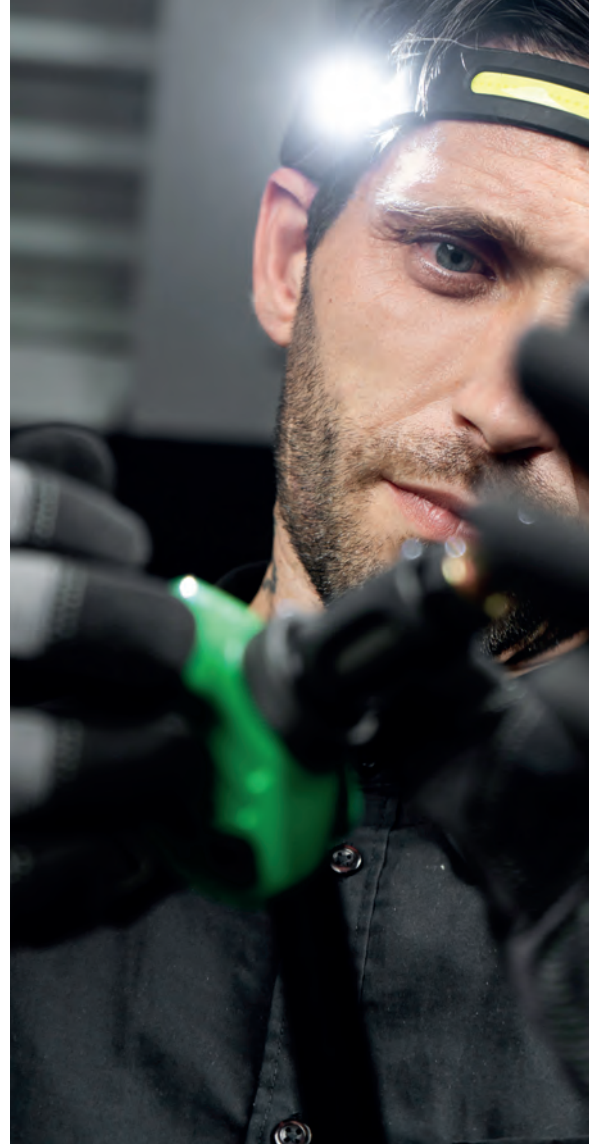

53734

23,70€

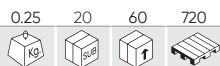

LANTERNĂ PORTABILĂ - 400LM



BAZĂ ROTATIVĂ
MAGNETIZATĂ
360°

SELECTOR DE
INTENSITATE A
LUMINII

ÎNCĂRCĂTOR
USB

CU CÂRLIG

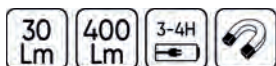

LED COB
400Lm - 2,5H

LED COB
30Lm - 10H

LI-ION
3.7V 2.600mah



ÎN INTERPRET
20 UNITĂȚI



53519

42,00€

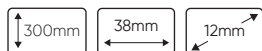
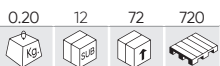

LANTERNĂ PORTABILĂ ULTRA COMPACTĂ

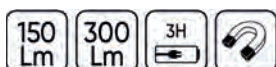

150Lm - 4H

300Lm - 2H

LI-POLI
3.7V 800mA

LED
3W COB

100V
240V

50-60
Hz

6500± 400
KELVIN

IP
44

68-71
ICR

5V
0.6A



ÎN INTERPRET
12 UNITĂȚI

52536

57,00€

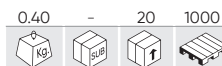

LANTERNĂ PORTABILĂ ȘLIM LED COB CU
BATERIE REÎNCĂRCABILĂ



INTENSITY 1
3H

INTENSITY 2
4H

LITHIUM
3.7V 1.900mA

LED
2W COB



DISEÑO REGISTRADO
REGISTERED DESIGN



51889

49,00€

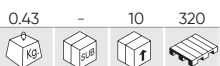

LANTERNĂ DE LUCRU PORTABILĂ 24+6
LEDURI, CU DUBLU MAGNET ÎN SPATE,
SUPPORT ȘI BAZĂ MAGNETICĂ



80
Lm

3-4H

80Lm - 5H

LED
24+6

LITHIUM
3.7V 2200mah



53216

49,00€



LANTERNĂ PORTABILĂ COB CU BAZĂ
ARTICULATĂ



170Lm - 4H

LED
2W COB

LITHIUM
3.7V 2.000mA

LITHIUM
5V 1000mA



LANTERNĂ PORTABILĂ CU BAZA ARTICULATĂ

54122 38,00€

0.39 12 24 384

300 Lm	3-4H		
LED 3W - 7H	COB 3W - 2,5H		
LITHIUM 3.7V 2.000mA	6500± 400 KELVIN		
IP 44	68-71 ICR	100V 240V	5V 1A

54123 40,00€

0.39 12 24 384

500 Lm	6-7H		
LED 3W - 14H	COB 5W - 3H		
LITHIUM 3.7V 4.000mA	6500± 400 KELVIN		
IP 44	68-71 ICR	100V 240V	5V 1A

54124 47,00€

0.39 12 24 384

1000 Lm	6-8H		
LED 3W - 14H	COB 10W - 3H		
LM 1000 5min	900 30min	700 145min	
LITHIUM 3.7V 4.000mA	6500± 400 KELVIN		
IP 44	68-71 ICR	100V 240V	5V 1A



ÎN INTERPRET 12 UNITĂȚI



REF. DESCRIERE

14031 ADAPTOR DE REȚEA USB

0.10 10 100 1152 7,90€

54379 28,00€

0.23 12 48 1440

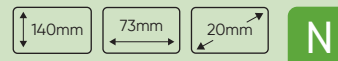

LUMINĂ DE LUCRU DE 10 W COB REÎNCĂRCABILĂ CU ENERGIE SOLARĂ

80-800 Lm	5,2V	0,5W	
3,5H	4-12H	BANCO DE ENERGIA POWER BANK	
80Lm 3W COB	800Lm 10W COB		
x1 LI-POLI 3.7V - 4000mAh			



ÎN INTERPRET 12 UNITĂȚI

53776 19,10€

0.15 12 48 1872



LANTERNĂ PORTABILĂ CU BATERIE

90 Lm	300 Lm	2,5H	
300Lm 5W COB - 3H	LI-ION 3.7V 1500mah		
250Lm 3W COB - 3,5H	ABS	TPR	
90Lm 3W LED - 6H			



ÎN INTERPRET 12 UNITĂȚI



54344

10,50€

0,10	10	100	1200

CASCĂ CU LAMPĂ FRONTALĂ CU LED

120 Lm	60 Lm	25 Lm
--------	-------	-------

LM 120	60	25
40min	6-8h	8-10h

3.7V 250mAh	2H
-------------	----

LUZ DISPERSA SCATTERED LIGHT	1W
---------------------------------	----



UNITATE DE LUMINĂ
DETAȘABILĂ

POLIESTER (65%)
ACRILIC (35%)



N

52987

20,00€

0,17	10	40	720

LANTERNĂ PORTABILĂ CU BATERIE

120 Lm	2,5H
--------	------

120Lm - 2,5H	
--------------	--

LITHIUM 3.7V 1.000mAh	LED 3W COB
--------------------------	---------------



ÎN INTERPRET
10 UNITĂȚI



53780

14,50€

0,45	5	20	300

LANTERNĂ LED DE LUCRU 400LM

400 Lm	6W	220V 240V
--------	----	--------------

IP 20	50 Hz
-------	-------

6000± 7000 KELVIN

H05RN-F 2x0.75mm ² - 5m

CABLU
HRĂNIRE 2,5M



52384

29,00€

0,33	-	20	600

LANTERNĂ PORTABILĂ EXTRAFINĂ
CU LED COB

- Lungime cablu : 5m
- DC Lungime cablu : 0,1 M
- DC Lungime cablu la pensete : 0,3M

200 Lm	12V 24V
--------	------------

LED 3W COB

75mm	325mm	90mm
------	-------	------



53217

47,00€

0,30	-	20	620

LANTERNĂ PORTABILĂ COB

200 Lm	4H	LED 2W COB		LITHIUM 3.7V 2.200mah	LITHIUM 5V 1.000mah
--------	----	---------------	--	--------------------------	------------------------



45mm	380mm
------	-------

54004

16,00€

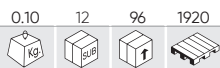

FAR COB

COB 350Lm -5W COB	LED 90Lm -3W XPE
COB 350Lm - 2,5H 150Lm - 5 H Flash - 8 H	LED XPE 150Lm - 4H 60Lm - 8 H
LI-ION 3.7V 1.200mA	Gel de silice Silica gel
2m	IP X4



BUTON SENZOR DE MIȘCARE

Apăsăți pentru a activa.
Apăsăți pentru a dezactiva.
Treceți mâna în fața butonului
pentru a aprinde și opri lumina.

- Material: silicagel
- Indicator de putere, indicator de inducție
- Mod de activare a senzorului de mișcare
- Cablu USB de încărcare inclus în setul de livrare



ÎN INTERPRET
12 UNITĂȚI

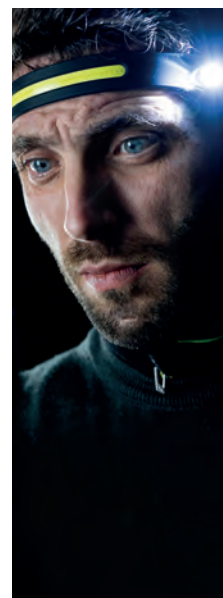

53569

18,00€

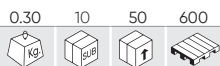

FAR 800 LM (COB + CREE)

REGULATOR DE FOCALIZARE
3 MODURI LUMINOASE
BATERII REÎNCĂRCABILE
INDICATOR APRINS



MAX 800 Lm	2,5H	150m
LED COB + CREE	x2 18650	
High Low Flash COB		



53568

12,00€

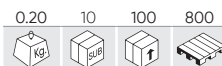

FAR 350 LM

REGULATOR DE FOCALIZARE
3 MODURI LUMINOASE

MAX 350 Lm	2,5H	150m
High Low Flash SOS		
LI-ION 2000mAh		



54267

9,50€

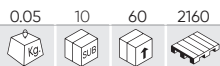

MĂNUȘA CU LUMINĂ LED

70 Lm	120 mAh	+20H
LED	DERECHA RIGHT	
x2 CR2016 INCLUIDAS / INCLUDED		
x2 LED 3.0V		



53974

38,00€

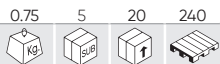

LAMPĂ DE LUCRU REÎNCĂRCABILĂ



4 MODURI DE ILUMINARE
100% 50% SOS FLASH



MULTIPOZIȚIE



52555

2,38€

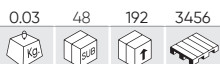

LANTERNĂ DE PLASTIC CU 9 LEDURI



ÎN INTERPRET
12 UNITĂȚI

52558

2,38€

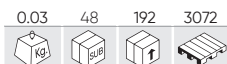

51326

4,40€



LANTERNĂ CU 21 LEDURI



ÎN INTERPRET
12 UNITĂȚI

BATERIE DE SCHIMB

REF.	DESCRIERE	KG	CM	CM	CM	€
51258	"AAA" R03 1,5V	0.01	60	2400	134400	0,15€

PENTRU REF. 51326, 52233, 52555, 52558

REF.	DESCRIERE	KG	CM	CM	CM	€
10923	9V	0.05	10	500	-	1,10€

PENTRU REF. 52162, 52450, 51929, 50942



53427

5,00€

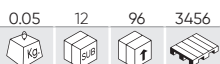

MINI LANTERNĂ CU 6 LEDURI MAGNETIZATĂ



ÎN INTERPRET
12 UNITĂȚI



51573

2,50€



LANTERNĂ CU DINAM ȘI 2 LEDURI

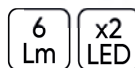

PREZENTARE:
ÎN CUTIE INDIVIDUAL



53227

28,00€

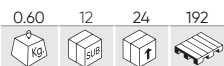

LUPĂ LED DE MASĂ

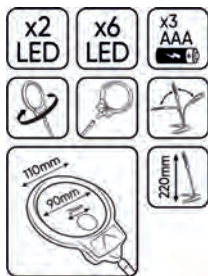

53085

30,00€

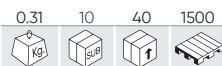

LUPĂ LED



STAND PENTRU LANTERN LED

REF.	Max.	Min.	kg	box	pallet	€
53506	1830mm	840mm	2.40	-	8	36,00€
52254	2770mm	1290mm	3.51	-	4	64,00€



53505

77,00€



LANTERN LED 50 W



54039

154,00€

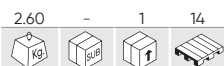

LAMPĂ LED INDUSTRIALĂ

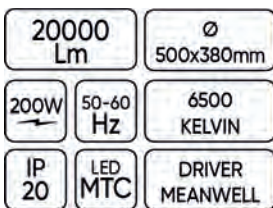

54133

547,00€



SET DE 6 LĂMPI INDUSTRIALE CU LEDURI 54039

6 PCS



REF. DESCRIERE

15385 GLUGĂ DE ÎNLOCUIRE PENTRU 54039



54088

132,00€



LAMPĂ LED INDUSTRIALĂ

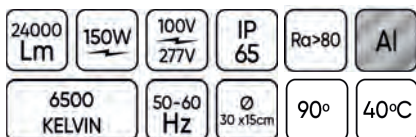

54270

42,00€

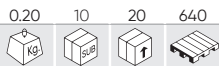

580mm

LANTERNĂ CU DIODĂ ELECTROLUMINISCENTĂ CU SUPTOR MAGNETIC

1000 Lm 3-4H

LED 1000Lm- 2H LED 400Lm- 5H

x2 LI-ION 3.7V - 1200mAh USB TYPE-C



54271

54,00€

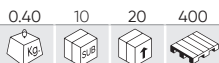

1200-1800mm

LANTERNĂ MAGNETICĂ CU BANDĂ PENTRU CAPOTĂ

1000 Lm 3-4H

LED 1000Lm- 2H LED 400Lm- 5H

x2 LI-ION 3.7V - 1200mAh USB TYPE-C



ARTICULAT

53707

153,00€



1050mm

LANTERNĂ MAGNETICĂ PENTRU CAPOTĂ

1000 Lm 7-8H 6H ABS

LED 3x5W COB 350Lm 700Lm 1000Lm

x4 LI-ION 3.7V - 2600mAh



3 MODURI LUMINOASE
BATERIE RECHARGEABLE
LUMINILE INDICATOARE ALE STĂRII BATERIEI

CREȘTEȚI SEMNIFICATIV VIZIBILITATEA ÎN ZONA DE LUCRU
PERMITE DIRECȚIONAREA INDIVIDUALĂ A BECULUI ACOLO UNDE ESTE NECESAR
CU SUPTOR MAGNETIC PENTRU A VĂ ADAPTA ORICĂREI SITUȚII



53570

154,00€



1170-1750mm

LANTERNĂ LED DE INSPECȚIE PT CAPOTĂ

1000 Lm 7-8H 6H

LED 3x5W COB 400Lm 800Lm 1200Lm

x4 LI-ION 3.7V - 2600mAh



3 MODURI LUMINOASE
BATERIE RECHARGEABLE
LUMINILE INDICATOARE ALE STĂRII BATERIEI

CREȘTEȚI SEMNIFICATIV VIZIBILITATEA ÎN ZONA DE LUCRU
PERMITE DIRECȚIONAREA INDIVIDUALĂ A BECULUI ACOLO UNDE ESTE NECESAR



54173 87,00€

0.75 5 20 240

N

SEMNALIZATOR LED REÎNCĂRCABIL BAZĂ MAGNETICĂ

- FUNCȚII:
 FUNCȚIE 1: FLASH
 FUNCȚIE 2: BLOCAREA DOUBĂ
 FUNCȚIE 3: ROTAȚIE

20W 5V x45 LED

PC ABS 2-3H 2-3H

LI-ION 7.4V - 2200mA -30°C 50°C IP 65



REF. DESCRIERE

16053	CABLU USB TIP A / ȘTECHER ROTUNDE 5,5MM	0.05	10	100	2,85€
-------	---	------	----	-----	-------

54172 81,00€

0.80 5 20 240

N

SEMNALIZATOR LED REÎNCĂRCABIL BAZĂ FLEXIBILĂ

- FUNCȚII:
 FUNCȚIE 1: FLASH
 FUNCȚIE 2: BLOCAREA DOUBĂ
 FUNCȚIE 3: ROTAȚIE

20W 5V x45 LED

PC ABS 2-3H 2-3H

LI-ION 7.4V - 2200mA -30°C 50°C IP 65



REF. DESCRIERE

16052	CABLU USB TIP A / ȘTECHER ROTUNDE 3,5MM	0.05	10	100	2,09€
-------	---	------	----	-----	-------

53691 36,00€

0.70 - 20 320

SEMNALIZATOR LED MAGNETIC

- FUNCȚII:
 FUNCȚIE 1: FLASH
 FUNCȚIE 2: BLOCAREA DOUBĂ
 FUNCȚIE 3: ROTAȚIE



x8 LED 18W 12V 24V IP 66

112mm 125cm -30°C 50°C

4m PC ECE R10 ECE R65



53690 34,00€

0.55 - 20 200

SEMNALIZATOR LED 12-24V CU BAZĂ FLEXIBILĂ

- FUNCȚII:
 FUNCȚIE 1: FLASH
 FUNCȚIE 2: BLOCAREA DOUBĂ
 FUNCȚIE 3: ROTAȚIE



x8 LED 18W 12V 24V IP 66

182mm 125cm -30°C 50°C

PC ECE R10 ECE R65



52375 38,00€

0.70 - 20 240

170mm Ø140mm

SEMNALIZATOR LED INTERMITENT DE 12-24V CU ALIMENTARE PRIN BRICHETĂ AUTO

- LENTILE ABS-BAES.
 - TULIPA ANTI-RUPERE.
 - CABLU: SPIRALA DE 2,5M + PRIZA DE BRICHETĂ AUTO.
 - CONSUM: 9W.

- FUNCȚII:
 FUNCȚIE 1: ROTAȚIE
 FUNCȚIE 2: BLIȚ DUBLU
 FUNCȚIE 3: 6 CLIPEȘTE

12V 24V 9W

170mm Ø 140cm IP 56

2,5m PC/ABS ECE R10



BAZĂ MAGNETIC

52456 36,00€

0.60 - 20 160

240mm Ø128mm

SEMNALIZATOR LED GIROFAR 12-24V BAZĂ FLEXIBILĂ

- LENTILE PC.
 - TULIPA ANTI-RUPERE.
 - CONSUM: 8W.

- FUNCȚII:
 FUNCȚIE 1: ROTAȚIE
 FUNCȚIE 2: BLIȚ DUBLU
 FUNCȚIE 3: 6 CLIPEȘTE

12V 24V 8W PC/ABS

240mm Ø 128cm IP 56

ECE R10



ABS - BAES
 BAZĂ FLEXIBILĂ

ILUMINAT

51964

28,00€

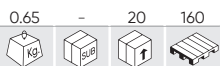

SEMNALIZATOR LED CU BAZĂ FLEXIBILĂ H1 12V 55W



Tulipă anti-rupere
Lentile: PC
Firul lentilei cu sigiliu de durată
T/min : 40
Sistem de pinion / Sistem de vierme
Bec H1, 12V 55W
Bază cu filet
Consum de energie : 3.0 Amp



ABS - BAES
BAZĂ FLEXIBILĂ

51965

29,50€



SEMNALIZATOR LED CU BAZĂ FLEXIBILĂ H1 24V 70W



Tulipă anti-rupere
Lentile: PC
Firul lentilei cu sigiliu de durată
T/min : 40
Sistem de pinion / Sistem de vierme
Bec H1, 24V 70W
Bază cu filet
Consum de energie : 3.0 Amp



ABS - BAES
BAZĂ FLEXIBILĂ

51962

25,00€



SEMNALIZATOR FĂRĂ CABLU H1 12V 55W



Tulipă anti-rupere
Lentile ABS - BAES
Firul lentilei cu sigiliu de durată
T/min : 40
Sistem de pinion / Sistem de vierme
Bec H1, 12V 55W
Consum energie : 3.0 Amp



51963

29,00€

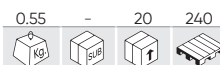

SEMNALIZATOR LED FĂRĂ CABLU H1 24V 70W



Tulipă anti-rupere
Lentile ABS - BAES
Firul lentilei cu sigiliu de durată
T/min : 40
Sistem de pinion / Sistem de vierme
Bec H1, 24V 70W
Consum energie : 3.0 Amp



51960

34,00€



SEMNALIZATOR LED CU CABLU MAGNETIC H1 12V-55W



Tulipă anti-rupere
Lentile ABS - BAES
Firul lentilei cu sigiliu de durată
Rpm : 40
Sistem de pinion / Sistem de vierme
Bec: H1, 12V 55W
Cablul: Spirală de 4m cu alimentator de brichetă auto
Consum energie: 3.0 Amp



51961

34,00€



GIROFAR CU CABLU MAGNETIC H1 24V 70W

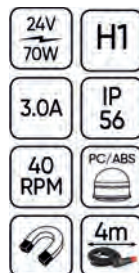

Tulipă anti-rupere
Lentile ABS - BAES
Firul lentilei cu sigiliu de durată
Rpm : 40
Sistem de pinion / Sistem de vierme
Bec: H1, 24V 70W
Cablul: Spirală de 4m cu alimentator de brichetă auto
Consum energie: 3.0 Amp



SEMNALIZATOR LED INTERMITENT

REF.						€
52827		0.50	-	20	400	46,00€
52828		0.54	-	20	320	43,00€
52910		0.50	-	20	320	39,00€

- CU 3 COMUTATOARE DE FUNCȚIE.
- 3 MODURI DE INTERMITENȚĂ:
ROTAȚIE
6 CLIPEȘTE
MODUL DUAL FLASH



51966

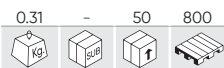

18,00€

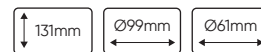

SEMNALIZATOR LED INTERMITENT 12V - 110V



- Lentile ABS - BAES.
- XENON.
- Consum energie: 3.0 A.



CU BAZA TULIPEI FILETATĂ

ACCESORII PENTRU

REF.	DESCRIERE					€
11103	BEC DE SCHIMB PENTRU REF. 51966	0.01	-	100	-	6,00€
10766	BEC DE SCHIMB PENTRU REF.51960, 51962	0.01	-	200	-	1,59€
10750	CONECTOR PENTRU GIROFAR CU REF. 51964, 51965, 52456	0.25	-	50	-	13,00€
10751	CONECTOR PENTRU GIROFAR CU REF. 51964, 51965, 52300 ŞI 52456	0.30	-	50	-	15,00€
52843	BARĂ EXTENSIBILĂ	0.90	-	20	1500	31,60€
51969	TULIPĂ PORTOCALIE DE SCHIMB PENTRU GIROFARURI CU REF. REF. 51960, 51961, 51964	0.12	-	50	1000	14,00€
11324	TULIPĂ ALBASTRĂ DE SCHIMB PENTRU GIROFARURI CU REF. 51960, 51961, 51964	0.13	-	100	-	17,50€
11325	TULIPĂ ROŞIE DE SCHIMB PENTRU GIROFARURI CU REF. 51960, 51961, 51964	0.12	-	50	451	17,50€



PROIECTOR DE LUCRU CU LED PĂTRAT, LUMINĂ DIFUZĂ

53428

18,00€

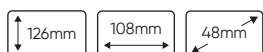
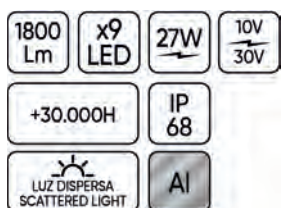
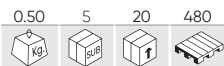

53429

18,00€

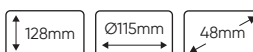
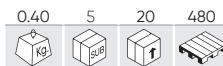

52566

28,00€

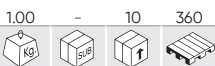

1450 Lm x9 LED 27W 10V/40V
 +30.000H IP 68
 LUZ DISPERSA SCATTERED LIGHT AI

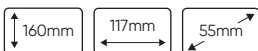

52567

29,00€

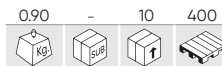

1450 Lm x9 LED 27W 10V/40V
 +30.000H IP 68
 LUZ DISPERSA SCATTERED LIGHT AI

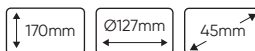

52302

25,40€

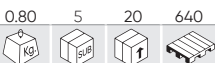

1450 Lm x9 LED 27W 10V/40V
 +30.000H IP 68
 LUZ DISPERSA SCATTERED LIGHT AI

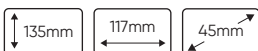

52303

26,40€

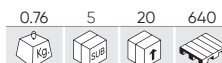

1450 Lm x9 LED 27W 10V/40V
 +30.000H IP 68
 LUZ DISPERSA SCATTERED LIGHT AI

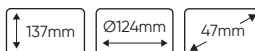

53049

89,00€



3600 Lm x4 LED 40W 9V/36V
 +30.000H IP 68
 LUZ DISPERSA SCATTERED LIGHT AI



53052

158,00€



7200 Lm x8 LED 80W 9V/36V
 +30.000H IP 68
 LUZ DISPERSA SCATTERED LIGHT AI

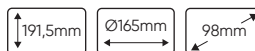

53045

35,00€

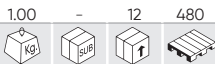

2800 Lm x16 LED 48W 10V/40V
 +20.000H IP 67
 LUZ DISPERSA SCATTERED LIGHT AI

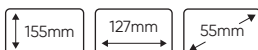

53046

39,00€

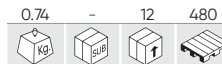

2272 Lm x16 LED 24W 9V/36V
 +20.000H IP 68
 LUZ DISPERSA SCATTERED LIGHT AI



PROIECTOR DE LUCRU CU LED LUMINĂ CONCENTRATĂ

52568

28,00€

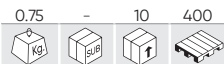

1450 Lm	x9 LED	27W	10V / 30V
+30.000H	IP 68		
LUZ CONCENTRADA SPOTLIGHT		Al	

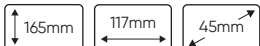

52569

28,00€

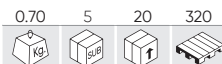

1450 Lm	x9 LED	27W	10V / 30V
+30.000H	IP 68		
LUZ CONCENTRADA SPOTLIGHT		Al	

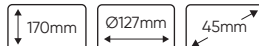

53048

89,00€

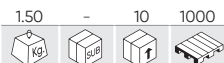

3600 Lm	x4 LED	40W	9V / 36V
+30.000H	IP 68		
LUZ CONCENTRADA SPOTLIGHT		Al	

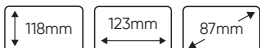

53051

158,00€



7200 Lm	x8 LED	80W	9V / 36V
+30.000H	IP 68		
LUZ CONCENTRADA SPOTLIGHT		Al	

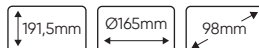

52415

19,00€

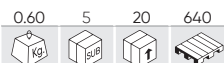

1450 Lm	x9 LED	27W	10V / 40V
+30.000H	IP 68		
LUZ CONCENTRADA SPOTLIGHT		Al	

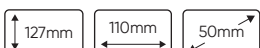

52414

19,00€

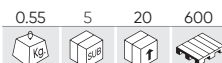

1450 Lm	x9 LED	27W	10V / 40V
+30.000H	IP 68		
LUZ CONCENTRADA SPOTLIGHT		Al	

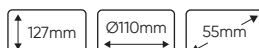

53047

330,00€



3200 Lm	x10 LED	50W	12V / 24V
6500 KELVIN	280cm	IP 67	
LUZ CONCENTRADA SPOTLIGHT		Al	

ROTATIV

VITEZĂ REGLABILĂ DE MIȘCARE

DISTANȚĂ 100M



54161

90,00€



BARĂ TELESCOPICĂ DE SEMNALIZARE PENTRU REMORCĂ DE 1,4 LA 2,1M



REGULAMENTUL	OMOLOGARE
3	E9*3R02/17*23444*00
4	E9*4R00/19*23444*00
6	E9*6R01/29*23444*00
7	E9*7R02/27*23444*00
10	E9*10R06/00*22232*02

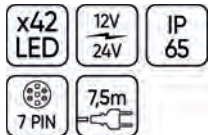

54163

80,00€

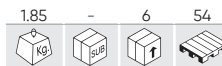

BARĂ PENTRU REMORCĂ DE 1.100X140MM CU LĂMPI TRIANGULARE LED



REGULAMENTUL	OMOLOGARE
3	E9*3R02/17*23444*00
4	E9*4R00/19*23444*00
6	E9*6R01/29*23444*00
7	E9*7R02/27*23444*00
10	E9*10R06/00*22232*02

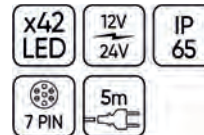

50910

45,00€



BARĂ PENTRU REMORCĂ DE 1100X140MM CU LĂMPI TRIANGULARE



REGULAMENTUL	OMOLOGARE
4	E4*4R-0024080
6	E4*6R-0124080
7	E4*7R-0224080
10	E9*10R06/02*23498*00

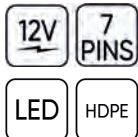

52838

56,00€

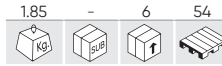

BARĂ PENTRU REMORCĂ DE 1.100X140MM CU LĂMPI TRIANGULARE LED



OMOLOGARE
E4*7R-0218756



KIT MAGNETIC LĂMPI REMORCĂ LED

CABLU LUNG: 7,5M
CABLU ÎNTRE LĂMPI: 2,5M

54162

81,00€



OMOLOGARE
E9*7R02/27*23444*00



51886

44,00€



REGULAMENTUL	OMOLOGARE
3	E4*3R-023749
4	E4*4R-0024080
6	E4*6R-0124080
7	E4*7R-0224080
10	E9*10R06/02*23498*00

52839

64,00€

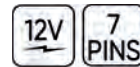
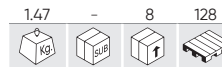

REGULAMENTUL	OMOLOGARE
3	E4*3R-0218756
4	E4*4R-0018756
6	E4*6R-0118756
7	E4*7R-0218756
10	E9*10R06/02*23199*01

54044 99,00€

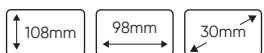
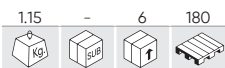

SET DIN DOUĂ LĂMPI MAGNETICE FĂRĂ FIR SPATE



OMOLOGARE

E9*10R05/01*16210*02

53151 14,00€

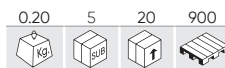

LED PENTRU BARA DE TRACTARE



- 4 functii:
- Albastru: Poziții și matricula.
- Roșu: Lumina pentru frânare.
- Galben: Intermitente.
- Alb: Masa.

LED PENTRU BARA DE TRACTARE

REF.					€
54160L	STÂNGA	0.20	5	20	17,50€
54160R	DREAPTA	0.20	5	20	17,50€

- 4 funcții:
- Negru: Poziții și matricula.
- Roșu: Lumina pentru frânare.
- Verde: Intermitente.
- Alb: Masa.

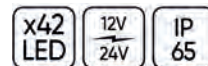

OMOLOGARE

E9*7R02/27*23444*00
E9*10R06/01*23199*00



53536 34,00€

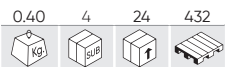

TESTER LUMINI REMORCĂ 7/13 PINI



REF. DESCRIERE

14753 7 ÎNCĂRCĂTOR DE PIN PENTRU REF. 53536 0.20 - 50 - 13,00€

51929 22,00€

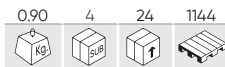

TESTER LUMINI REMORCĂ 7 PINI



PRIZĂ REMORCĂ

PRIZĂ VEHICUL

AVERTIZOR ACUSTIC AUTO 12V-80V

REF.	DB	IP	V	°C				€
51967	97DB	IP65	12V-80V	-30/70°C	0.20	50	1200	16,00€
51968	107DB	IP65	12V-80V	-30/70°C	0.23	50	1000	16,00€



- Rezistent la diferite condiții meteorologice.
- Posibilitate de spălare cu apă sub presiune.
- Protejat împotriva polarității inverse.
- Sigilate cu rășini epoxidice.



51967



51968

54078



68,00€



LUMINĂ DE SIGURANȚĂ PENTRU ELEVATOR



Lanternă de securitate de formă ovală cu 2 LED-uri albastre. Lanternul proiectează pe pământ lumină direcțională albastră pentru avertizarea trecătorilor.

O astfel de lumină de avertizare contribuie la prevenirea coliziunilor și a accidentelor cu implicarea stivuitoare și a persoane, de asemenea, sporește siguranța într-un mediu de producție, în special în zonele moarte. Ideal convite pentru zone cu obstacole.



MUFELE DE BRICHETĂ ȘI TRANSFORMATOR

REF.	DESCRIERE					€
10961	ÎNCĂRCĂTOR DE REȚEA PENTRU REF. 51889 ȘI 52257	0.08	-	50	-	13,00€
11107	ALIMENTATOR BRICHETĂ AUTO PENTRU REF. 51889	0.06	-	250	-	4,50€
11989	ALIMENTATOR BRICHETĂ AUTO PENTRU PORTABILA DE LUCRU CU REF. 52536	0.04	-	200	-	2,00€
13839	ADAPTOR CU CONECTOR USB 110V/60HZ	0.04	-	200	-	8,50€
14031	ADAPTOR DE REȚEA USB	0.10	10	100	1152	7,90€
14032	USB ÎNCĂRCĂTOR AUTO	0.10	10	100	1200	12,00€
14033	CABLU USB TIP A/ MICRO-B	0.10	10	100	500	4,50€
16052	CABLU USB TIP A / ȘTECHER ROTUNDE 3.5MM	0.05	10	100	-	2,09€
16053	CABLU USB TIP A / ȘTECHER ROTUNDE 5.5MM	0.05	10	100	-	2,85€



10961



11107



11989



13839



14031



14032



14033



16052

16053

SCULE PNEUMATICE

- 147 ÎNȘURUBARE
- 151 PERFORARE
- 152 TĂIERE / DEBITARE
- 153 ȘLEFUIRE/LUSTRUIRE
- 156 PISTOALE DE SUFLAT CU AER
- 158 ÎNTREȚINEREA ANVELOPELOR
- 160 ALTELE
- 163 ROLE / FURTUNURI DE AER
- 165 CUPLE CONECTARE
- 166 ACCESORII ȘI CONSUMABILE



JBM RECOMANDĂ UTILIZAREA ULEIURILOR LUBRIFIANTE PENTRU OPTIMIZAREA PERFORMANȚEI ȘI EXTINDERA VIEȚII UNELTELOR

REF.14534 REF.14560

PAGINĂ 161



53520

228,00€

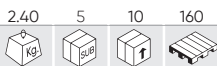

PISTOL DE IMPACT 1/2" (1756NM) - COMPOSITE



COMPOSITE
1756Nm

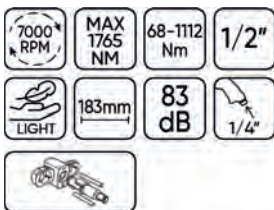

REF. DESCRIERE

14121 SET DE UNELTE PENTRU INSTRUMENT PNEUMATIC - 51207 / 53520 0.75 - 20 26,00€

51207

289,00€

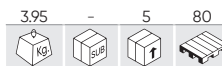

SET CHEIE DE IMPACT COMPOZITĂ DE 1/2" + CAPETE



COMPOSITE
1756Nm



REF. DESCRIERE

14121 SET DE UNELTE PENTRU INSTRUMENT PNEUMATIC - 51207 / 53520 0.75 - 20 26,00€

51206

228,00€

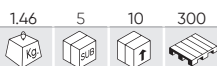

PISTOL MINI DE IMPACT 1/2" COMPOSITE



COMPOSITE
1302Nm

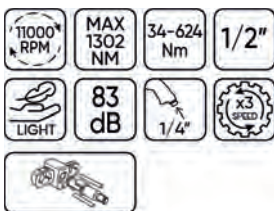

REF. DESCRIERE

14120 SET DE UNELTE PENTRU INSTRUMENT PNEUMATIC - 51206 0.15 - 5 22,00€

53588

178,00€

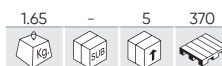

PISTOL DE IMPACT DE 1/2" MODEL NANO (1302NM)



1302Nm

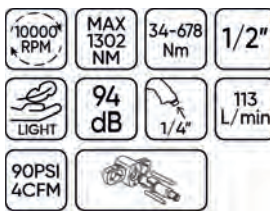

REF. DESCRIERE

14165 SET DE UNELTE PENTRU INSTRUMENT PNEUMATIC - 53588 0.05 - 20 26,50€

JBM RECOMANDĂ UTILIZAREA ULEIURILOR LUBRIFIANTE PENTRU OPTIMIZAREA PERFORMANȚEI ȘI EXTINDERA VIEȚII UNELTELOR

REF.14534 REF.14560

PAGINĂ 161



53733 238,00€

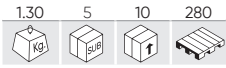

CHEIE PNEUMATICĂ UNGHIULARĂ CU PERCUȚIE 1/2"



650Nm



REF. DESCRIERE 0.03 - 20 22,50€

14633 SET DE UNELTE PENTRU INSTRUMENT PNEUMATIC - 53733

54340 296,00€

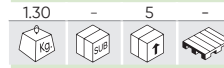

N

PISTOL CU IMPACT ARTICULAT DE 1/2"



813 Nm



REF. DESCRIERE 0.07 - 15 32,50€

16341 SET DE UNELTE PENTRU INSTRUMENT PNEUMATIC - 54340

54397 249,00€

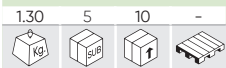

N

PISTOL CU IMPACT COMPACT 1/2"



1004Nm

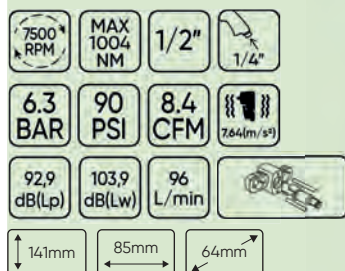

REF. DESCRIERE 0.10 - 20 17,00€

16564 SET DE UNELTE PENTRU INSTRUMENT PNEUMATIC - 54397

53689 238,00€

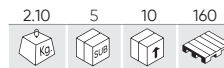

PISTOL DE IMPACT 1/2" (1950NM) - COMPOSITE



COMPOSITE 1950Nm



REF. DESCRIERE 0.01 - 20 19,00€

14618 SET DE UNELTE PENTRU INSTRUMENT PNEUMATIC - 53689

SCULE PNEUMATICE

53608

98,00€

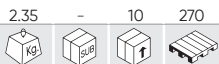

PISTOL DE IMPACT DE 1/2" 1200NM

1200Nm

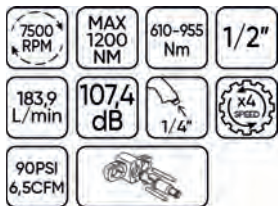

REF. DESCRIERE



€

14583 SET DE UNELTE PENTRU INSTRUMENT PNEUMATIC - 53608 0.01 - 20 6,00€

53726

128,00€

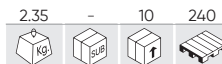

PISTOL DE IMPACT DE 1/2" 1650NM

1650Nm

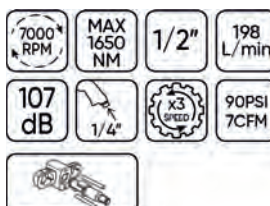

REF. DESCRIERE



€

15564 KIT DE REPARAȚIE SCULE PNEUMATICE - 53726 0.05 - - 11,90€

51212

488,00€



PISTOL DE IMPACT 3/4" COMPOSITE

2034Nm

COMPOSITE



REF. DESCRIERE



€

14122 SET DE UNELTE PENTRU INSTRUMENT PNEUMATIC - 51210 / 51212 1.12 - 50 34,00€

51211

560,00€



PISTOL DE IMPACT 1" COMPOSITE

2034Nm

COMPOSITE

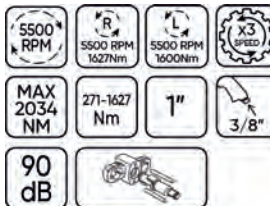

REF. DESCRIERE



€

14123 SET DE UNELTE PENTRU INSTRUMENT PNEUMATIC - 51211 / 51213 1.16 - 20 33,00€

51210

650,00€



PISTOL IMPACT DE 3/4" + PRELUNGITOR DE 15CM COMPOSITE

2034Nm

COMPOSITE

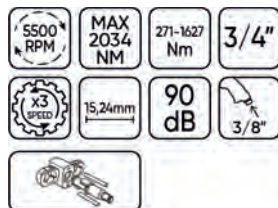

REF. DESCRIERE



€

14122 SET DE UNELTE PENTRU INSTRUMENT PNEUMATIC - 51210 / 51212 1.12 - 50 34,00€

51213

690,00€



PISTOL IMPACT DE 1" + PRELUNGITOR 19CM COMPOSITE

2034Nm

COMPOSITE

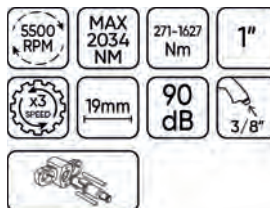

REF. DESCRIERE



€

14123 SET DE UNELTE PENTRU INSTRUMENT PNEUMATIC - 51211 / 51213 1.16 - 20 33,00€

53681

743,00€

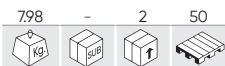

1" CHEIE PNEUMATICĂ UȘOARĂ PENTRU CAMIOANE



2441Nm



REF.	DESCRIERE				€
14336	SET DE UNELTE PENTRU INSTRUMENT PNEUMATIC - 53681	1,17	10	10	58,00€

52814

528,00€



PISTOL DE IMPACT PENTRU CAMIOANE 1" 3260NM



3260Nm



REF.	DESCRIERE				€
14153	SET DE UNELTE PENTRU INSTRUMENT PNEUMATIC - 52814	0,05	-	15	20,50€

53343

285,00€

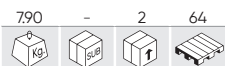

PISTOL DE IMPACT DE 3/4"

1600Nm

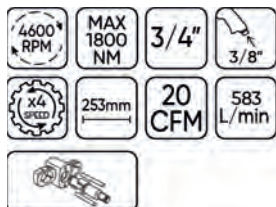

51222

128,00€



PISTOL DE IMPACT 1/2" DUBLU BLISTER

101Nm



REF.	DESCRIERE				€
14131	SET DE UNELTE PENTRU INSTRUMENT PNEUMATIC - 51222	0,01	-	10	24,00€

52156

140,00€



TRUSĂ DE 16 PIESE PNEUMATICE CU PISTOL DE IMPACT ȘI CLICHET

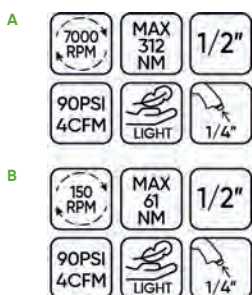

x10 9, 10, 11, 13, 14, 17, 19, 22, 24, 27mm

52165

118,00€



PISTOL DE IMPACT DE 1/2"

680Nm



54336

259,00€



CLICHET PNEUMATIC CU ARTICULAȚIE DE 1/2"

95Nm



REF. DESCRIERE

16273 SET DE UNELTE PENTRU INSTRUMENT PNEUMATIC - 54336

0.15 - 15 12,50€

N

51214

148,00€



CLICHET MINI DE 1/4" COMPOSITE

40,7Nm

COMPOSITE



REF. DESCRIERE

14124 SET DE UNELTE PENTRU INSTRUMENT PNEUMATIC - 51214 0.25 - 10 20,50€

51215

119,00€



CLICHET PNEUMATIC DE 1/2"

14-68Nm



REF. DESCRIERE

14125 SET DE UNELTE PENTRU INSTRUMENT PNEUMATIC - 51215 0.03 - 10 19,50€

52167

48,00€

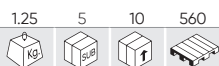

CLICHET PNEUMATIC DE 1/2"

61Nm



53784

148,00€



CLICHET MINI DE 1/2" COMPOSITE

40,8Nm

COMPOSITE



REF. DESCRIERE

14779 SET DE UNELTE PENTRU INSTRUMENT PNEUMATIC - 53784 0.05 - 10 33,00€

51221 199,00€

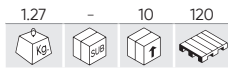

MAȘINĂ DE GĂURIT PNEUMATICĂ LA 90°

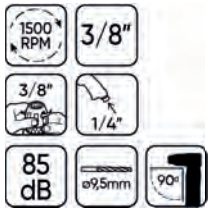

REF. DESCRIERE 0.40 - 10 21,00€
14130 SET DE UNELTE PENTRU INSTRUMENT PNEUMATIC - 51221

51220 240,00€

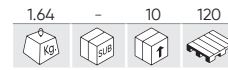

MAȘINĂ DE GĂURIT PNEUMATICĂ REVERSIBILĂ COMPOSITE



REF. DESCRIERE 0.01 - 10 12,50€
14129 SET DE UNELTE PENTRU INSTRUMENT PNEUMATIC - 51220

53573 36,00€

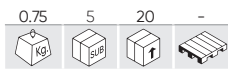

BURGHIU PNEUMATIC DIRECT, 3/8 "



52159 64,00€

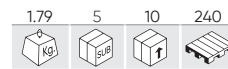

MAȘINĂ DE GĂURIT PNEUMATICĂ REVERSIBILĂ DE 1/2"



52527 82,00€

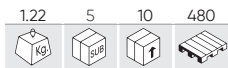

MAȘINĂ DE GĂURIT PNEUMATICĂ REVERSIBILĂ DE 3/8" ÎN UNGHII DE 90°



52160 48,00€

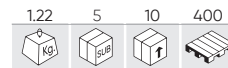

MAȘINĂ DE GĂURIT PNEUMATICĂ REVERSIBILĂ DE 3/8"



FREZĂ PNEUMATICĂ PENTRU SUDURĂ CU DESPLASARE BIȚI CENTRA

52724 381,00€



REF. DESCRIERE 0.10 - 500 17,00€
13817 BURGHIE 52275 - 6.5 MM

52725 349,00€



REF. DESCRIERE 0.10 - 500 20,50€
13818 BURGHIE 52275 - 8MM

52718

48,00€

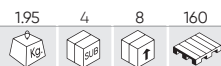

SET CIOCAN PNEUMATIC CU 9 PIESE



- A 21mm
- B 1,8mm
- C 21mm
- D 21mm



52953

38,00€

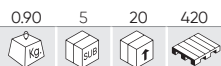

TĂIETOR PNEUMATICE DE 3"



REF.	DESCRIERE	kg	sub	unit	€
12987	BLADE OARA TĂIETOR PNEUMATICE DE 3" (REF. 52953)	0.02	50	500	1,50€

53140

98,00€

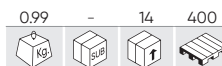

MAȘINĂ DE TĂIAT PNEUMATICĂ



REF.	DESCRIERE	kg	sub	unit	€
14013	REFLEXAREA DISCULUI PENTRU REF. 53140	0.01	-	1000	3,50€

53541

168,00€

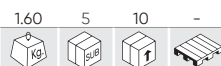

FOARFECHE PNEUMATICE PENTRU METAL



REF.	DESCRIERE	kg	sub	unit	€
14136	SET DE UNELTE PENTRU INSTRUMENT PNEUMATIC - 53541	0.01	-	5	12,00€

52574

69,00€



FERĂSTRĂU PNEUMATIC



REF.	DESCRIERE	kg	sub	unit	€
11956	5 PÂNZE FERĂSTRĂU CU 24 DINȚI PT. LEMN	0.03	10	300	5,50€
11957	SET DE 5 PÂNZE PENTRU FERĂSTRĂU CU 32 DINȚI PT. FIER	0.01	10	250	5,50€

51216

650,00€

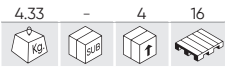

MAȘINĂ PNEUMATICĂ UNIVERSALĂ



ACCESORII

REF.	DESCRIERE				€
51388	PERIE UNGHI DE 23MM PENTRU REF. 51216	0.10	100	800	22,00€
51389	PERIE UNGHI DE 11MM PENTRU REF. 51216	0.05	1	800	22,00€
51390	PERIE FINĂ LATĂ DE 23MM PENTRU REF. 51216	0.05	100	800	22,00€
51391	PERIE FINĂ LATĂ DE 11MM PENTRU REF. 51216	0.04	1	800	22,00€
51392	PERIE RĂZUITOARE DE VOPSEA PENTRU REF. 51216	0.20	100	800	34,00€
51393	PERIE RĂZUITOARE DE VOPSEA DE APĂ PT. REF. 51216	0.10	50	800	34,00€
51439	ADAPTOR PT. ROATĂ DE 23MM	0.10	100	800	26,00€
51440	ADAPTOR PT. ROATĂ DE 11MM	0.10	1	800	28,00€
51441	ADAPTOR PT. ROATĂ NEAGRĂ DUBLĂ	0.10	1	800	26,00€
51442	ADAPTOR PT. ROATĂ NEAGRĂ SIMPLĂ	0.10	50	800	28,00€

REF.	DESCRIERE				€
14126	SET DE UNELTE PENTRU INSTRUMENT PNEUMATIC - 51216	0.01	-	10	54,00€

INCLUDE

Diferite Tipuri de Perii (Pentru pregătirea suprafețelor metalice)
 11 mm Perie de sârmă (fină)
 23 mm Perie de Sârmă (fină)
 11 mm Perie de sârmă (groasă)
 23 mm Perie de sârmă (groasă)
 Gumă de șters
 Gumă de șters vopsea pe bază de apă
 Adaptor de 23 mm pentru gumă de șters
 Adaptor de 11 mm perie de sârmă
 Șlefuitor Cauciuc Negru (până la 6 piese)
 Adaptor unic de Șlefuitor cauciuc
 Adaptor de bandă din cauciuc dublu

53576

189,00€



3" SET-URI PENTRU MAȘINĂ DE LUSTRIRE PNEUMATICĂ ÎN MINIATURĂ



REF.	DESCRIERE				€
A	14162 PERNĂ DE LUSTRIRE DIN LÂNĂ ART. 53576	0.05	-	50	25,50€
B	14163 PERNĂ BURETE MOALE PENTRU ART. 53576 - ALBĂ	0.50	5	50	25,50€
C	14164 PERNĂ BURETE DURĂ PENTRU ART. 53576 - GALBEN	0.50	5	50	25,50€
D	14330 DISC VELCRO PENTRU 53625	0.01	5	50	3,50€
14154	SET DE UNELTE PENTRU INSTRUMENT PNEUMATIC - 53576	0.05	-	10	42,00€

53646

69,00€

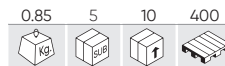

3 SET-URI PENTRU MAȘINĂ DE LUSTRIRE PNEUMATICĂ ÎN ATURĂ

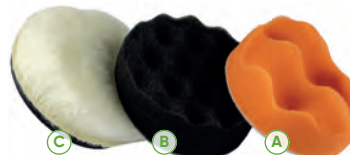

REF.	DESCRIERE				€
A	14286 PERNĂ BURETE MOALE PENTRU ART. 53646	0.01	10	200	2,99€
B	14287 PERNĂ BURETE DURĂ PENTRU ART. 53646	0.00	10	200	2,99€
C	14288 PERNĂ DE LUSTRIRE DIN LÂNĂ ART. 53646	0.01	10	200	6,00€
D	14289 DISC VELCRO PENTRU 53625	0.04	-	200	6,10€

53626

18,00€

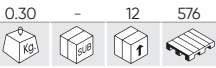

SET PENTRU RESTAURAREA FAPTURILOR

14 PCS

INCLUDE

- x2 Roți de șlefuit p800
- x2 Roți de șlefuit p1200
- x2 Roți de șlefuit p2000
- x2 3,0 MI lichid de protecție uv
- x2 Adaptor (3/8 "și 1/4")
- x1 85 G pastă de lustruire
- x1 Bandă adezivă
- x1 Roată de lustruire din lână
- x1 Disc de burete alb



ÎN INTERPRET
12 UNITĂȚI



SERIE262

199,00€

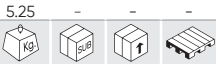

KIT LUSTRIRE: MAȘINĂ DE LUSTRIRE PNEUMATICĂ + 12 SET PENTRU RESTAURAREA FAPTURILOR

53626

53646

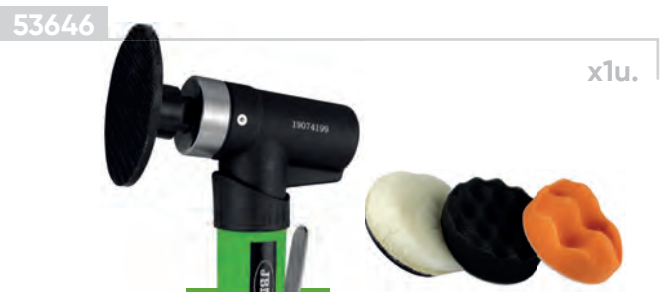

52676

98,00€

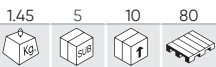

MAȘINĂ DE ȘLEFUIT ORBITAL AUTO-ASPIRARE

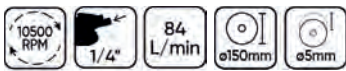

- Corp din aluminiu cu mâner din cauciuc.
- Excelent randament de curățare cu pungă și furtun.



52675

84,00€

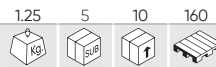

MAȘINĂ DE ȘLEFUIT ORBITAL ADĂPTABILĂ LA ASPIRATOR



52758

88,00€

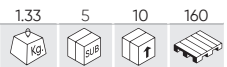

MAȘINĂ DE ȘLEFUIT ORBITAL ADĂPTABILĂ LA ASPIRATOR



51226

233,00€

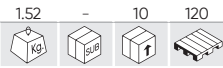

MAȘINĂ DE ȘLEFUIT PNEUMATICĂ

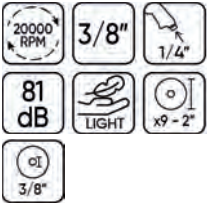

REF. DESCRIERE

14133 SET DE UNELTE PENTRU INSTRUMENT PNEUMATIC - 51226 0,01 - 10 16,50€

51245

99,00€

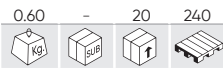

MINI POLIZOR 3/8" 6MM



REF. DESCRIERE

14135 SET DE UNELTE PENTRU INSTRUMENT PNEUMATIC - 51245 0,01 - 10 12,50€

52157

48,00€

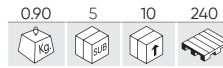

TRUSĂ DE 16 PIESE CU POLIZOR DREPT PNEUMATIC



52171

39,00€

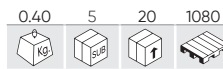

MINI POLIZOR PNEUMATIC 1/4"

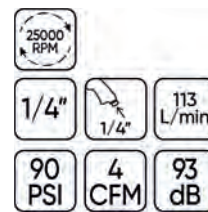

53141

68,00€

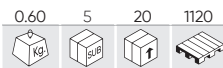

MAȘINĂ DE GĂURIT PNEUMATICĂ



52528

49,00€

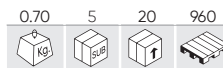

POLIZOR / BIAX PNEUMATIC UNGHIULAR



53137

38,00€

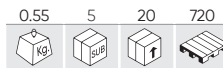

MINI POLIZOR ELECTRIC



51218

288,00€

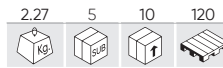

POLIZOR UNGHIULAR COMPOSITE

COMPOSITE



REF. DESCRIERE

14127 SET DE UNELTE PENTRU INSTRUMENT PNEUMATIC - 51218 0,01 - 10 32,50€

SCULE PNEUMATICE

54255

68,00€

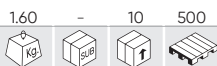

SET COMPLET DE ACCESORII PENTRU PISTOLUL DE GRESAT

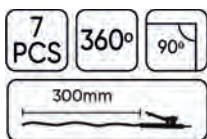

50751

43,00€

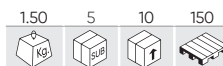

POMPĂ DE GRESARE PNEUMATICĂ

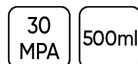

52490

6,65€

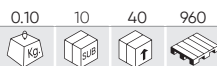

PISTOL DE AER 100MM

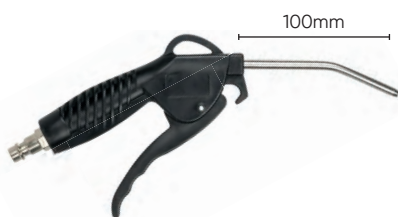

ÎN INTERPRET
10 UNITĂȚI



52491

10,50€

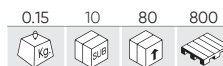

PISTOL DE AER 300MM

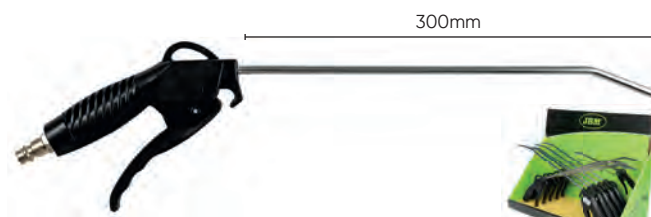

ÎN INTERPRET
10 UNITĂȚI



53611

27,50€



PISTOL DE PULVERIZARE CU DUZĂ LUNGĂ



DEBIT MARE

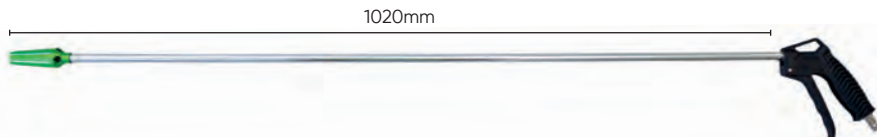

52798

18,00€

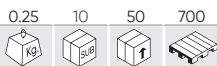

PISTOL DE AER EXTENSIBIL



IMBUS ACOPERIT DE GUMĂ PENTRU A EVITA ZGĂRIETURI

51980

15,00€

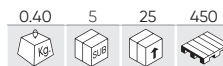

PISTOL DE AER COMPRIMAT CU MANOMETRU



51981

21,50€

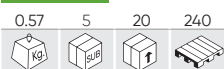

PISTOL DE AER + PISTOL PT. UMFLAT PNEURI



51277

64,00€



KIT DE UNELTE PNEUMATICE



52787

9,00€

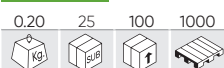

PISTOL DE SUFLAT



51383

11,10€



PISTOL DE SUFLAT CU AER

- Pistol de suflat.
- Reducție pentru conector rapid.
- Reducție pentru furtun.
- Țeavă de 10 cm.
- Țeavă de 20 cm.



ÎN INTERPRET
10 UNITĂȚI



54251

43,00€



PISTOL DE ASPIRAT ȘI SUFLAT



INCLUDE



53205

19,00€



POMPĂ DE SUFLARE CU MARE CAPACITATE



Debit mare

- Pompă debit mare.
- Material corp: aliaj de aluminiu.
- Suprafață: placat cu nichel.

52381

20,50€



PISTOL DE SUFLAT DE 3/8" CU FURTUN DE 5M

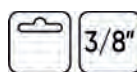

SCULE PNEUMATICE

54248

58,00€

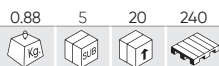

PISTOL PULVERIZATOR DE AER

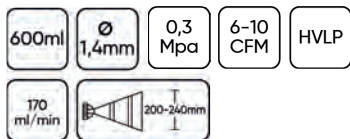

PIESE DISPONIBILE

54249

103,00€

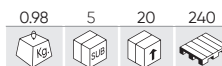

PISTOL PULVERIZATOR DE AER PROFESIONAL

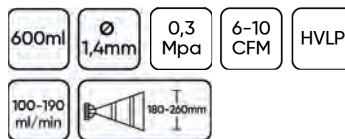

PIESE DISPONIBILE

53606

55,00€

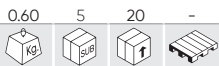

PISTON PNEUMATIC CU AER



SUPAPA DE REGLARE A AERULUI



53449

16,40€

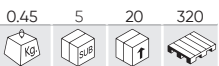

POMPĂ DE AER CU MANOMETRU ANALOGIC

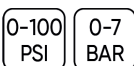

53450

28,30€

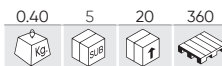

POMPĂ DE AER CU MANOMETRU DIGITAL

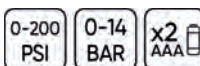

52648

9,00€



VERIFICATOR DE PRESIUNE A PNEURILOR



53416

14,10€



VERIFICATOR DE PRESIUNE PT PNEUMATICE CU TUB (0-10BAR)



53417

26,30€



VERIFICATOR DIGITAL DE PRESIUNE PT PNEUMATICE CU TUB (0-15BAR)

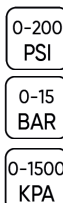

53418

16,90€

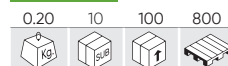

VERIFICATOR DE PRESIUNE PT PNEUMATICE CU TUB (0-15BAR)



51861



199,00€



DISPOZITIV PNEUMATIC FIXARE BURDUF PLANETARĂ

- Material: Aluminiu.
- Deschidere de 20 la 100mm.

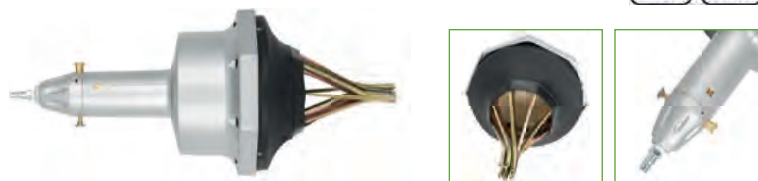

53542



980,00€

DISPOZITIV PNEUMATIC DE DEMONTARE A AVELOPELOR



REF. DESCRIERE

14137 SET DE UNELTE PENTRU INSTRUMENT PNEUMATIC - 53542

kg	sub	unit	€
0.65	5	5	131,00€

52540



221,00€

VENTUZĂ PNEUMATICĂ PT. ÎNDREPTAT LOVITURI LA CAROSERII AUTO

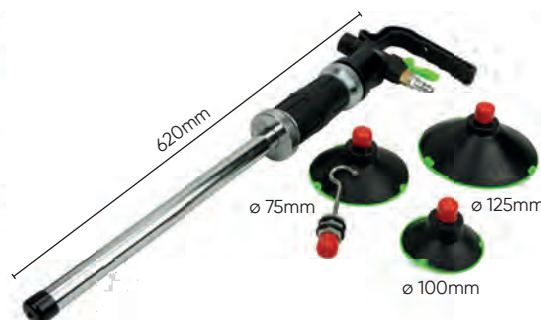
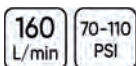

52331



201,00€

SET DE INSTRUMENTE PNEUMATICE

PISTOL DE IMPACT + CIOCAN PNEUMATIC + CLICHET PNEUMATIC + MINI SLEFUITOARE PNEUMATICA + PISTOL DE SUFLAT + PISTOL DE SUFLAT DREPT + ACCESORII



SCULE PNEUMATICE

52543

182,00€



PISTOL PT. CURĂȚAREA FILTRELOR DE PARTICULE

- Universal.
- Capacitate maximă: 650cc.
- Furtun de nailon de 4x6x2.7m.
- Rang de presiune de lucru: 3 bar - 7 bar.
- Corp inoxidabil de lungă durată + Bază de aluminiu.



REF. DESCRIERE

REF.	DESCRIERE	Kg	L	Unit	€
90003	LICHID DESCARBONIZARE	1.08	-	12	35,20€
90004	LICHID NEUTRALIZARE	0.50	-	12	25,80€

53625

68,00€

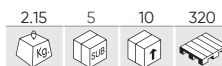

CIOCAN PNEUMATIC DEMULTIPLICATOR



REF. DESCRIERE

REF.	DESCRIERE	Kg	L	Unit	€
14188	AC PENTRU ART. 53625	0.01	50	500	0,50€

53593

41,00€



PISTON PNEUMATIC DE SABLARE

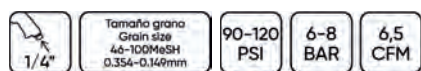

INCLUDE

- 1x pistol șlefuitor.
- 1x Picker Sand.
- 2x 850 barci cu nisip.

- Șepci 4x: pentru explozie, pentru sablare, pentru sablare în colț exterior, pentru sablare în colț interior.

REF. DESCRIERE

REF.	DESCRIERE	Kg	L	Unit	€
14168	BALON PENTRU NISIP (PENTRU ART. 53593)	0.95	-	20	7,00€

53202

15,70€



SERINGĂ DE ULEI



- Pistol de curățare a motorului.
- Pot Material: Oțel.
- Material corp: aliaj de aluminiu.
- Suprafață: Pulbere de acoperire.

53204

81,00€



POMPĂ DE CURĂȚARE



- Masini de curățare arma, Tornado.
- Pot Material: PE.
- Material corp: aliaj de aluminiu.
- Suprafață corporală: lustruită.

52575

119,00€



PISTOL NITUIT PNEUMATIC

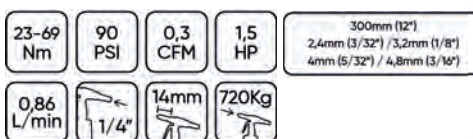

53567 43,00€

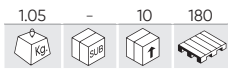

PISTOL DE SILICON PNEUMATIC

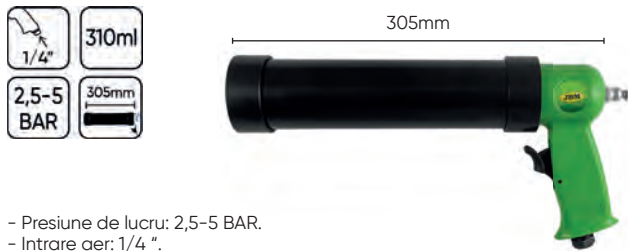

- Presiune de lucru: 2,5-5 BAR.
- Intrare aer: 1/4".
- Capacitatea cartușului: 310ml.

52533 10,00€

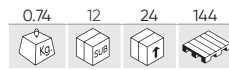

PISTOL PROFESIONAL PENTRU SILICON 300ML



53572 348,00€



INSTRUMENT PNEUMATIC PT. SUPAPE DE ȘLEFUIRE - PERCUSIUNEA ȘI ROTAȚIA

INCLUDE
 1 x Mașină de supapă pneumatică.
 5 x Ventilă (16, 20, 30, 35 și 40 mm).
 5 x Adaptor supape.
 1 x 3 mm Cheie Allen.



REF.	mm				€
14157	16	0.01	-	50	8,30€
14158	20	0.01	-	50	9,95€
14159	30	0.01	-	50	12,60€
14160	35	0.01	-	50	12,80€
14161	40	0.10	-	50	13,70€



54033 49,00€

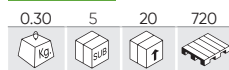

INSTRUMENT PENTRU INTRODUCEREA SUPAPEI ÎN FORĂ

- Diametrul ventuzei: 16, 20, 30, 35, 40 mm
- Diametru ax: 8mm
- Lungime: 128mm
- Viteza de lucru maximă de rotație: 1250rpm



REF.	mm				€
14157	16	0.01	-	50	8,30€
14158	20	0.01	-	50	9,95€
14159	30	0.01	-	50	12,60€
14160	35	0.01	-	50	12,80€
14161	40	0.10	-	50	13,70€



14534 16,50€



ULEI PENTRU UNELTELE PNEUMATICE - 600ML

- Densitate relativă la 15°C: 0,845.
- Viscositate: 12,1 cSt la 40 °C.
- Culoare: Incoloră.



14560 8,80€



ULEI PENTRU UNELTELE PNEUMATICE - 100ML

- Densitate relativă la 15°C: 0,845.
- Viscositate: 12,1 cSt la 40 °C.
- Culoare: Incoloră.



SCULE PNEUMATICE



DISCURI DE TĂIAT

REF.	DESCRIERE					€
51385	DISC DE TĂIAT 4"X1/32" PENTRU REF. 51219	0.01	10	300	800	4,55€
51387	DISC DE TĂIAT DE 3"	0.03	10	300	800	3,25€



DISCURI DE ȘLEFUIRE

REF.	DESCRIERE					€
51386	DISC DE ȘLEFUIRE 5" PENTRU REF. 51218	0.10	-	25	800	5,95€
51443	DISC DE ȘLEFUIRE #60 PENTRU REF. 51226	0.50	25	150	800	5,50€
51444	DISC DE ȘLEFUIRE #80 PENTRU REF. 51226	0.02	-	25	800	5,05€
51445	DISC DE ȘLEFUIRE #120 PENTRU REF. 51226	0.02	-	25	800	5,05€



DISCURI PENTRU MAȘINI DE ȘLEFUIT

REF.	DESCRIERE					€
13499	DISC CU 15 ORIFICII MAȘINI DE ȘLEFUIT	0.10	-	50	1500	12,50€
13500	DISC DE 66 ORIFICII PENTRU MAȘINI DE ȘLEFUIT	0.65	5	50	-	12,90€
12009	DISC CU 6 ORIFICII MAȘINI DE ȘLEFUIT	0.14	-	50	-	11,00€



FILTRU ȘI REGULATOR DE AER

REF.	"					€
53063	1/4"	0.60	5	50	300	36,70€
53064	3/8"	0.63	5	50	300	37,40€
53065	1/2"	0.60	5	50	300	36,90€



FILTRU DE AER, REGULATOR CU LUBRIFIANT

REF.	"					€
53066	1/4"	1.08	5	25	250	61,00€
53067	3/8"	0.50	5	25	250	61,00€
53068	1/2"	1.00	5	25	250	63,00€



53492

380,00€

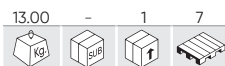

EXPOZANT UNEALTĂ PNEUMATICĂ



LIVRAT FĂRĂ DISPOZITIVUL



52378

10,00€

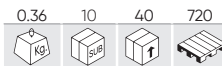

SUPPORT-MAGNETIC



51341 35,00€



53147

41,00€

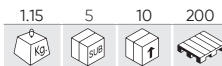

EXPOZANT UNEALTĂ PNEUMATICĂ



LIVRAT FĂRĂ DISPOZITIVUL

53594

54,00€



FURTUN PNEUMATIC, 8MM - 25 M



HYBRID POLYMER
POLÍMERO HÍBRIDO

- Presiunea de lucru: 300PSI / 20bar.
- Presiunea de rupere: 950PSI / 65bar.
- Temperatura de lucru: -40°C / 65°C

- O mare flexibilitate.
- Întoarcere la forma originală.
- Suprafața netedă nu dăunează vopseaua.
- Foarte rezistent.

Diametrul interior: 8mm
Diametrul exterior: 13mm

Pentru a utiliza cu:
REF. 52736 (M8)



53595

61,00€



FURTUN PNEUMATIC, 10MM - 25 M



HYBRID POLYMER
POLÍMERO HÍBRIDO

- Presiunea de lucru: 300PSI / 20bar.
- Presiunea de rupere: 950PSI / 65bar.
- Temperatura de lucru: -40°C / 65°C

- O mare flexibilitate.
- Întoarcere la forma originală.
- Suprafața netedă nu dăunează vopseaua.
- Foarte rezistent.

Diametrul interior: 10mm
Diametrul exterior: 15mm

Pentru a utiliza cu:
REF. 52737 (M10)









REF. DESCRIERE

14169 SET DIN 10 CLAME 8-16 MM

0.10 - 125 - 3,00€

SCULE PNEUMATICE

FURTUN SPIRAL PNEUMATIC

REF.	m			"					€
53629	10m	8mm	5mm	1/4"	0.55	-	6	360	14,30€
53630	15m	8mm	5mm	1/4"	0.65	-	6	240	18,80€
53631	15m	12mm	8mm	1/4"	1.25	-	6	120	33,50€
53632	15m	15mm	10mm	1/4"	2.20	-	6	78	46,00€
53633	15m	15mm	10mm	3/8"	2.10	-	6	78	46,00€
53634	15m	18mm	13mm	1/2"	2.60	-	6	66	63,00€



CU CAPETE PIVOTANTE DE 360 DE GRADE PENTRU O MIȘCARE UȘOARĂ ȘI UȘURINȚĂ DE UTILIZARE

- MATERIALUL FURTUNULUI: PU.
- SUPRAFAȚĂ FILETATĂ: ALAMĂ.





TAMBUR CU FURTUN RETRACTABIL CAPĂȚ



CU
REPARTIȚIE



SUPORT DE
PERETE INCLUS

14772	8,50€
	
	

REF. 53582 / REF. 53583







SUPORT DE
PERETE INCLUS

14771	10,50€
	
	

REF. 53532 / REF. 53581

20+2m

REF.	m	"					€
53582	22m	3/8"	10.85	-	1	14	174,00€
53583	22m	3/8"	10.75	-	1	14	174,00€







12+1m

REF.	m	"					€
53532	13m	3/8"	6.60	-	2	30	119,00€
53581	13m	3/8"	6.70	-	2	30	119,00€



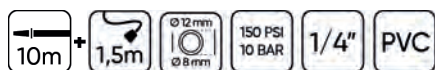

10+1,5m

REF.	m	"					€
53881	11,5m	1/4"	4.50	-	4	48	79,00€
53882	11,5m	1/4"	4.50	-	4	48	79,00€







CONECTOR FURTUN

REF.	DESCRIERE					€
14204	EUR - M6 M 1/4"	0.06	50	200	-	1,50€
14205	EUR - M8 M 3/8"	0.06	50	200	-	1,50€
14206	EUR - M10 M 1/2"	0.05	50	200	-	1,50€
14207	US - M6 M 1/4"	0.05	50	200	-	1,50€
14208	US - M8 M 3/8"	0.06	50	200	-	1,50€
14209	US - M10 M 1/2"	0.05	50	200	-	1,50€



CONECTOR RAPID CU FIXATOR DE PROTECȚIE - CONECTARE FURTUN



REF.	DESCRIERE					€
14201	M6	0.10	25	100	-	4,00€
14202	M8	0.10	25	100	-	4,00€
14203	M10	0.10	25	100	-	4,50€



CONECTOR / FILET

REF.	DESCRIERE				€
13930	CONECTOR CU FILET EXTERIOR, USA - 1/4 " FILET EXTERIOR	0.01	50	100	1,50€
13932	CONECTOR CU FILET EXTERIOR, USA - 3/8 " FILET EXTERIOR	0.10	50	100	2,50€
14076	CONECTOR CU FILET EXTERIOR, USA - 3/8 " FILET INTERIOR	0.10	50	100	1,50€
13933	CONECTOR CU FILET EXTERIOR, USA - 1/2 " FILET EXTERIOR	0.10	50	100	2,00€
13935	CONECTOR CU FILET EXTERIOR, USA - 1/4 " FILET INTERIOR (2 BUC.)	0.05	50	100	2,50€
13936	CONECTOR CU FILET INTERIOR, USA - 1/4 " FILET INTERIOR	0.05	50	100	3,50€
13937	CONECTOR CU FILET INTERIOR, USA - 1/4 " FILET EXTERIOR	0.05	50	100	4,00€
14078	CONECTOR CU FILET INTERIOR, USA - 3/8 " FILET INTERIOR	0.10	50	100	4,00€
14191	CONECTOR CU FILET EXTERIOR, USA - 1/2 " FILET INTERIOR	0.05	50	100	2,00€
14193	CONECTOR CU FILET INTERIOR, USA - 1/2 " FILET INTERIOR	0.10	50	100	4,00€

EUR

REF.	DESCRIERE				€
13931	CONECTOR CU FILET EXTERIOR, EUR - 1/4 " FILET EXTERIOR (2 BUC.)	0.05	50	100	2,50€
14075	CONECTOR CU FILET EXTERIOR, EUR - 3/8 " FILET INTERIOR	0.10	50	100	2,00€
13934	CONECTOR CU FILET EXTERIOR, EUR - 1/4 " FILET INTERIOR (2 BUC.)	0.05	50	100	2,50€
13938	CONECTOR CU FILET INTERIOR, EUR - 1/4 " FILET INTERIOR	0.10	50	200	3,50€
13939	CONECTOR CU FILET INTERIOR, EUR - 1/4 " FILET EXTERIOR	0.10	50	100	4,00€
14077	QUICK-CONECTOR CU FILET INTERIOR, EUR - 3/8 " FILET INTERIOR	0.10	50	100	4,50€
14190	CONECTOR CU FILET EXTERIOR, EUR - 1/2" FILET INTERIOR	0.05	50	100	2,00€
14192	QUICK-CONECTOR CU FILET INTERIOR, EUR - 1/2"	0.10	50	100	4,00€



SCULE PNEUMATICE

CONECTOR RAPID CU FIXATOR DE PROTECȚIE

REF.	DESCRIERE					€
14195	FEMININ - FILET EXTERN 1/4"	0.50	25	100	-	4,00€
14196	FEMININ - FILET EXTERN 3/8"	0.10	25	100	-	4,00€
14197	FEMININ - FILET EXTERN 1/2"	0.10	25	100	-	4,50€
14198	FEMININ - FILET INTERN 1/4"	0.10	25	100	-	4,00€
14199	FEMININ - FILET INTERN 3/8"	0.10	25	100	-	4,00€
14200	FEMININ - FILET INTERN 1/2"	0.10	25	100	-	4,50€



CONECTOR ARTICULAȚIE PENTRU AER COMPRIMAT CU FILET EXTERIOR

REF.	DESCRIERE					€
14314	EUR 1/4"	0.06	25	100	-	5,00€
14315	US 1/4"	0.06	25	100	-	4,50€



14561

0.05	25	50	-

1/4" CUPLAJ DE ULEI



8,80€



CUPLĂ PNEUMATICĂ RAPIDĂ

REF.	DESCRIERE					€
52735	CUPLĂ PNEUMATICĂ RAPIDĂ M6	0.05	25	200	4000	4,85€
52736	CUPLĂ PNEUMATICĂ RAPIDĂ M8	0.10	25	200	4000	5,35€
52737	CUPLĂ PNEUMATICĂ RAPIDĂ M10	0.10	25	200	4000	5,50€



ADAPTOR ARTICULAT

REF.	DESCRIERE					€
12988	ADAPTOR ARTICULAT PNEUMATIC DE 1/2"	0.15	62	125	-	12,00€
13809	ADAPTOR ARTICULAT DE 1/4"	0.10	62	250	-	18,50€
13810	ADAPTOR ARTICULAT DE 3/8"	0.10	62	250	-	20,50€



SCULE DE IMPACT

- 168 TUBULARE DE IMPACT
- 173 SCULE SPECIALE PENTRU ROTI
- 174 ADAPTOARE
- 176 PIESE DE SCHIMB DE TUBULARE DE IMPACT
- 177 SCULE SPECIALE PENTRU CAMIOANE



SCULE DE IMPACT

52694

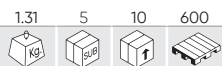

SET DE 3 TUBULARE XZN DE 1/2" DE IMPACT



INCLUDE

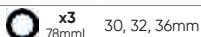

49,00€

52337



SET DE 6 TUBULARE IMPACT DE 1/2" HEX.



INCLUDE

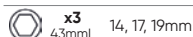

52547



SET DE 8 TUBULARE ȘI CAPETE XZN 1/2" DE IMPACT

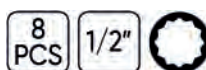

INCLUDE

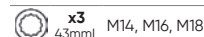
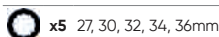

96,00€

52345



SET DE 19 PIESE DE IMPACT DE 1/2" HEX. CU 14 TUBULARE + ADAPTOARE



10, 11, 12, 13, 14, 15, 16, 17, 18, 19, 21, 22, 24, 27mm



109,00€

PIESE DISPONIBILE

REF.	mm				€
14728	10	0.10	5	20	3,80€
14729	11	0.05	10	100	3,80€
14730	12	0.05	10	100	3,80€
14731	13	0.10	5	20	3,80€
14732	14	0.10	5	20	3,80€
14970	15	0.08	5	20	2,50€
14971	16	0.07	5	20	2,50€

REF.	mm				€
11195	17	0.10	10	100	3,70€
14972	18	0.12	5	20	3,50€
11121	19	0.10	10	60	4,10€
14733	21	0.10	5	20	4,30€
14734	22	0.15	5	20	5,40€
11122	24	0.14	10	20	5,45€
11123	27	0.20	10	50	6,50€

REF.	DESCRIERE				€
12937	PRELUNGITOR ANTRENOR DE IMPACT 50MM 1/2"	0.11	10	100	9,50€
14973	PRELUNGITOR ANTRENOR DE IMPACT 150MM 1/2"	0.27	5	20	11,50€
12075	PRELUNGITOR ANTRENOR DE IMPACT 250MM 1/2"	0.45	10	50	15,50€
11962	ADAPTOR DE IMPACT 1/2" F 3/4" M	0.17	10	100	7,50€
11990	ARTICULAȚIE UNIVERSALĂ DE IMPACT DE 1/2"	0.15	10	100	15,30€

53531

109,00€

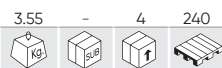

SET DE 19 PIESE DE IMPACT DE 1/2" 12 FEȚE CU 14 TUBULARE + ADAPTOARE

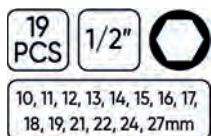
10, 11, 12, 13, 14, 15, 16, 17,
18, 19, 21, 22, 24, 27mm

PIESE DISPONIBILE

REF.	DESCRIERE				€
12937	PRELUNGITOR ANTRENOR DE IMPACT 50MM 1/2"	0.11	10	100	9,50€
14973	PRELUNGITOR ANTRENOR DE IMPACT 150MM 1/2"	0.27	5	20	11,50€
12075	PRELUNGITOR ANTRENOR DE IMPACT 250MM 1/2"	0.45	10	50	15,50€

REF.	DESCRIERE				€
11962	ADAPTOR DE IMPACT 1/2" F 3/4" M	0.17	10	100	7,50€
11990	ARTICULAȚIE UNIVERSALĂ DE IMPACT DE 1/2"	0.15	10	100	15,30€

52341

58,00€



SET 13 PIESE, TUBULARE DE IMPACT DE 1/2" HEX. + ADAPTOR

10, 11, 12, 13, 14, 17,
19, 21, 22, 24mm

PIESE DISPONIBILE

REF.	mm				€
14728	10	0.10	5	20	3,80€
14729	11	0.05	10	100	3,80€
14730	12	0.05	10	100	3,80€
14731	13	0.10	5	20	3,80€
14732	14	0.10	5	20	3,80€

REF.	mm				€
11195	17	0.10	10	100	3,70€
11121	19	0.10	10	60	4,10€
14733	21	0.10	5	20	4,30€
14734	22	0.15	5	20	5,40€
11122	24	0.14	10	20	5,45€

REF.	DESCRIERE				€
14735	1/2" SUPORT PENTRU DUZE DE PERCUȚIE	0.05	5	20	6,50€
12074	PRELUNGITOR ANTRENOR DE IMPACT 125MM 1/2"	0.23	10	60	11,50€
11990	ARTICULAȚIE UNIVERSALĂ DE IMPACT DE 1/2"	0.15	10	100	15,30€

52346

103,00€



SET DE 15 PIESE DE IMPACT CU 12 TUBULARE LUNGI DE 1/2" HEX. + ADAPTOARE



PIESE DISPONIBILE

REF.	mm				€
12061	10	0.14	10	100	9,50€
12062	12	0.15	10	100	9,50€
12063	13	0.15	10	50	9,50€
12064	15	0.17	10	100	9,00€
12065	16	0.30	10	20	9,00€
12066	17	0.20	10	100	9,00€

REF.	mm				€
12067	18	0.22	10	20	9,50€
12068	19	0.21	10	50	9,50€
12069	21	0.25	10	50	9,50€
12070	22	0.27	10	100	10,50€
12071	24	0.30	10	50	11,00€
12072	27	0.36	10	20	12,00€

REF.	DESCRIERE				€
12074	PRELUNGITOR ANTRENOR DE IMPACT 125MM 1/2"	0.23	10	60	11,50€
12075	PRELUNGITOR ANTRENOR DE IMPACT 250MM 1/2"	0.45	10	50	15,50€
11990	ARTICULAȚIE UNIVERSALĂ DE IMPACT DE 1/2"	0.15	10	100	15,30€

53060

34,90€

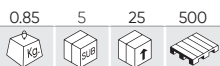

SET 12 TUBULARE IMPACT 1/2" PROFIL REDUS

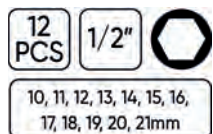

52342

63,00€

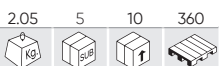

SET 11 TUBULARE DE IMPACT HEX. DE 1/2"

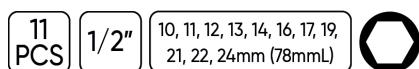

PIESE DISPONIBILE

REF.	mm	kg	sub	pcs	€
12061	10	0.14	10	100	9,50€
14736	11	0.15	5	20	5,00€
12062	12	0.15	10	100	9,50€
12063	13	0.15	10	50	9,50€
14737	14	0.15	5	20	5,00€
12065	16	0.30	10	20	9,00€

REF.	mm	kg	sub	pcs	€
12066	17	0.20	10	100	9,00€
12068	19	0.21	10	50	9,50€
12069	21	0.25	10	50	9,50€
12070	22	0.27	10	100	10,50€
12071	24	0.30	10	50	11,00€



53744

63,00€

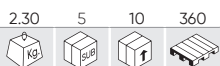

SET DIN 11 BUC. CAPETE DE PERCUȚIE ÎNALTE CU 12 FEȚE 1/2"

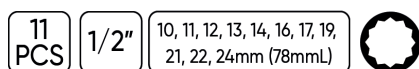

PIESE DISPONIBILE

REF.	mm	kg	sub	pcs	€
14738	10	0.15	10	100	5,50€
14739	11	0.15	10	100	5,50€
14740	12	0.16	10	100	5,55€
14741	13	0.15	10	100	5,55€
14742	14	0.15	10	100	5,55€
14743	16	0.14	10	100	5,15€

REF.	mm	kg	sub	pcs	€
14744	17	0.18	10	50	5,35€
14745	19	0.22	10	50	6,25€
14746	21	0.24	10	50	6,40€
14747	22	0.27	10	50	7,10€
14748	24	0.30	10	50	8,30€



52810

9,00€

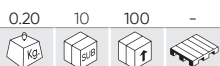

TUBULARE DE IMPACT XZN INVIOLABILĂ M16

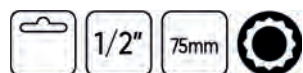

- Tubulară de impact de 75 mm în lung și pătrat de 1/2" pentru extragerea șurubului de golire cu pistol de impact în transmisia vehiculelor VAG, Porsche, Ford etc.

52811

9,90€



TUBULARE DE IMPACT XZN INVIOLABILĂ M18

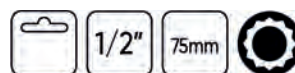

- Pentru extragerea brațului de direcție în vehiculele din grupul VAG.

52546 39,60€



SET DE 6 TUBULARE XZN DE 1/2" DE IMPACT



PIESE DISPONIBILE

REF.	43mmL	kg	sub	q	€	REF.	78mmL	kg	sub	q	€
12931	M14	0.08	10	200	7,50€	12934	M14	0.13	10	200	7,50€
12932	M16	0.08	10	200	7,50€	12935	M16	0.14	10	200	8,00€
12933	M18	0.09	10	200	8,00€	12936	M18	0.16	10	200	8,50€

52344 197,00€

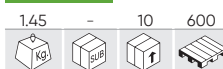

SET DE 13 CHEI TUBULARE DE IMPACT 1/2" HEX. ȘI TORX



INCLUDE

- x5 45mmL 5, 6, 8, 10, 12mm
- x8 45mmL T30, T40, T45, T50, T55, T60, T70, T80

52339 61,00€



SET 8 IMBUSURI DE IMPACT HEX. LUNGI DE 1/2"



PIESE DISPONIBILE

REF.	mm	kg	sub	q	€	REF.	mm	kg	sub	q	€
14004	5	0.30	10	240	9,50€	14008	10	0.11	10	240	9,50€
14005	6	0.09	10	120	10,50€	14009	12	0.12	10	240	9,50€
14006	7	0.09	10	240	9,50€	14010	14	0.14	10	120	11,00€
14007	8	0.10	10	240	9,50€	14011	17	0.18	10	60	11,00€

52340 58,00€



SET 8 IMBUSURI DE IMPACT TORX LUNGI DE 1/2"



PIESE DISPONIBILE

REF.	mm	kg	sub	q	€	REF.	mm	kg	sub	q	€
12938	T25	0.08	10	50	10,00€	12942	T50	0.10	10	60	10,00€
12939	T30	0.10	10	50	10,00€	12943	T55	0.10	10	50	10,00€
12940	T40	0.10	10	50	10,00€	12944	T60	0.12	10	50	10,00€
12941	T45	0.09	10	50	10,00€	12945	T70	0.15	10	50	10,50€

53470 176,00€



SET DIN 8 CAP CHEI TUBULARE CU IMPACT ALUNGITĂ 3/4"

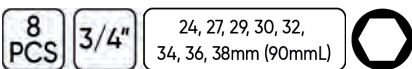

52347 158,00€

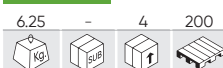

SET DE 8 TUBULARE DE IMPACT HEX. 3/4"

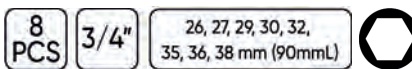

51028

163,00€

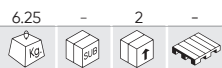

TRUSĂ DE 16 TUBULARE DE IMPACT

16 PCS 3/4"

PIESE DISPONIBILE

REF.	mm				€
14723	H17	0.35	-	10	18,00€
14724	T60	0.30	-	10	18,50€
14725	T70	0.30	-	10	18,50€
14726	T80	10.80	-	10	17,50€

	3/4"	x4	E18, E20, E22, E24
	3/4"	x5	T60, T70, T80, T90, T100
	3/4"	x4	H17, H19, H22, H24
		x2	1 - 3/4"
		x1	4mm



54316

182,00€



N

SET DE 8 TUBULARE DE IMPACT DE 1" LUNGIME

8 PCS 1"



x6	90mmL	24, 27, 30, 32, 33, 36mm
x2	95mmL	38, 41mm



PIESE DISPONIBILE

REF.	mm				€
16304	24	0.60	6	24	31,00€
16305	27	0.70	6	24	31,00€
16571	30	0.77	6	24	32,00€
16572	32	0.95	6	24	33,50€
16574	33	0.94	-	-	34,00€
16575	36	1.00	6	24	34,50€
16576	38	1.25	6	24	35,50€
16577	41	1.32	6	24	36,00€

52348

179,00€



SET DE 8 TUBULARE DE IMPACT DE 1"

8 PCS 1"



x2	58mmL	24, 27mm
x3	62mmL	30, 32, 33mm
x2	65mmL	36, 38mm
x1	68mmL	41mm



PIESE DISPONIBILE

REF.	mm				€
13859	24	0.50	6	24	16,00€
13874	27	0.60	6	72	17,50€
13875	30	0.50	6	18	18,50€
13876	32	0.60	6	24	18,50€
13877	33	0.60	6	96	18,50€
11153	36	0.70	6	18	23,40€
11155	38	0.90	6	12	24,40€
11158	41	0.95	6	18	28,50€

52969

20,70€



SET 3 TUBULARE DE IMPACT HEX. LONG

3 PCS 1/2"

17, 19, 21mm (78mmL)

PIESE DISPONIBILE

REF.	mm				€
12066	17	0.20	10	100	9,00€
12068	19	0.21	10	50	9,50€
12069	21	0.25	10	50	9,50€



53587

44,00€



KIT DE 4 DUZE DE IMPACT PENTRU ROȚI DIN ALIAJE UȘOARE, 1/2 "



PIESE DISPONIBILE

REF.	mm	mm	mm	mm	kg	kg	kg	kg	€
14172	15mm	85mmL	SMART	0.20	10	50	8,50€		
14173	17mm	85mmL	MERCEDES-BENZ	0.20	10	50	9,50€		
14177	22mm	85mmL	OPEL	0.25	10	50	9,50€		
14178	21mm	85mmL	HYUNDAI / KIA	0.25	10	50	9,50€		

52338

41,00€



SET 4 TUBULARE IMPACT DE 1/2" SP. EXTRACȚIE ROȚI



PIESE DISPONIBILE

REF.	mm	kg	kg	kg	€
11314	17	0.22	10	100	8,50€
11315	19	0.25	10	100	8,50€
11316	21	0.26	10	100	8,50€
11628	22	0.27	10	50	9,50€



51336

29,30€



SET 3 TUBULARE IMPACT DE 1/2" SP. EXTRACȚIE ROȚI



PIESE DISPONIBILE

REF.	mm	kg	kg	kg	€
11314	17	0.22	10	100	8,50€
11315	19	0.25	10	100	8,50€
11316	21	0.26	10	100	8,50€

52343

52,00€

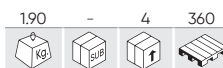

SET DE 12 TUBULARE DE IMPACT DE 1/2" HEX. SPECIAL EXTRACȚIE ROȚI

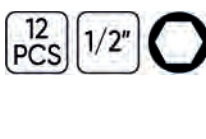

INCLUDE

Hexagon	x3	17, 19, 21mm
	85mmL	
Hexagon	x1	27mm
	42mmL	
Hexagon	x8	10, 11, 13, 14, 17, 19, 22, 24mm
	38mmL	

53988

101,00€



SET 10 TUBULARE IMPACT DE 1/2" SP. EXTRACȚIE ROȚI



INCLUDE

A	1/2"	15mm	F	1/2"	23mm
B	1/2"	17mm	G	1/2"	24mm
C	1/2"	19mm	H	7/8"	TESLA
D	1/2"	21mm	I	17mm	MERCEDES
E	1/2"	22mm	J	21mm	HYUNDAI / KIA



53197

46,00€

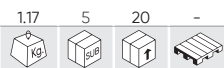

SET DE 4 TUBULARE DE IMPACT PENTRU ȘURUBURI DE SIGURANȚĂ



INCLUDE



53077

62,00€



SET DE PRELUNGITORI CU LIMITA DE CUPLU

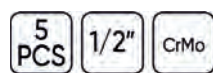

PIESE DISPONIBILE

	REF.	Nm					€
A	13688	100	0.22	-	-	1500	15,50€
B	13687	110	0.22	5	50	-	15,50€
C	13686	120	0.23	5	50	1000	15,50€
D	13685	135	0.25	5	50	1500	15,50€
E	13684	150	0.28	-	50	-	15,50€



AȚI PUTEA DORI, DE ASEMENEA...

	REF.	Nm					€
F	13680	200	0.36	50	50	-	15,50€
G	13681	190	0.35	-	50	-	15,50€
H	13682	175	0.32	-	50	-	15,50€
I	13683	160	0.30	-	50	-	15,50€
J	13689	90	0.20	5	50	1500	15,50€



PRELUNGITOR ANTRENOR DE IMPACT

REF.	mm	"					€
12937	50	1/2"	0.11	10	100	1500	9,50€
12074	125	1/2"	0.23	10	60	-	11,50€
12075	250	1/2"	0.45	10	50	-	15,50€

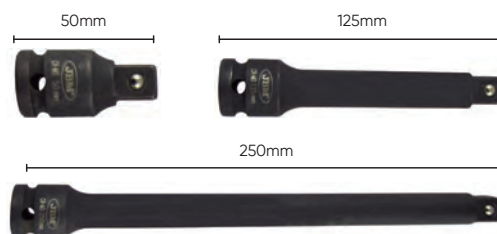

ARTICULAȚIE UNIVERSALĂ DE IMPACT

REF.	"					€
11938	3/4"	0.62	10	50	-	47,00€
11990	1/2"	0.15	10	100	-	15,30€



53043

53,00€

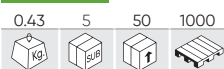

SET DE 3 ARTICULAȚII DE IMPACT CU DUBLĂ POZIȚIE (FIX/ARTICULAT)



53044

121,00€



SET 8 TUBULARE DE IMPACT HEX. CU DUBLĂ POZIȚIE (FIX/ARTICULAT)

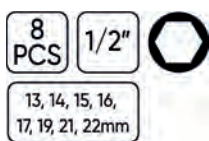

13, 14, 15, 16,
17, 19, 21, 22mm



52545

177,00€



JOC DE 2 ADAPTOARE DE IMPACT

1" 1/2" F - 1" M
1" F - 1" 1/2" M



53743

39,70€



SET DIN 6 DE CAPETE DE PERCUȚIE



PIESE DISPONIBILE

REF.	mm				€
14749	1/4"H - 3/8"M	0.03	20	200	2,00€
14750	3/8"H - 1/4"M	0.05	20	100	2,00€
14751	3/8"H - 1/2"M	0.15	20	100	4,00€
14752	1/2"H - 3/8"M	0.16	10	100	4,00€
11962	1/2"H - 3/4"M	0.17	10	100	7,50€
11964	3/4"H - 1/2"M	0.35	10	100	12,50€

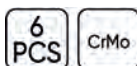

52544

93,00€



SET DE 6 ADAPTOARE



PIESE DISPONIBILE

REF.	mm				€
11962	1/2"H - 3/4"M	0.17	10	100	7,50€
11963	1/2"H - 1"M	0.25	6	54	9,00€
11964	3/4"H - 1/2"M	0.35	10	100	12,50€
11965	3/4"H - 1"M	0.45	6	48	16,00€
11966	1"H - 1/2"M	0.54	6	36	18,00€
11967	1"H - 3/4"M	0.56	4	36	18,00€



TUBULARĂ IMPACT



1"

REF.	mm				€
11153	36	0.70	6	18	23,40€
11154	37	0.73	6	24	21,70€
11155	38	0.90	6	12	24,40€
11156	39	0.74	6	24	28,90€
11157	40	0.78	6	12	26,60€
11158	41	0.95	6	18	28,50€
11159	42	1.00	6	18	30,30€
11160	43	0.95	6	12	27,00€
11161	44	0.90	6	18	32,30€
11162	45	1.10	4	8	29,10€
11163	46	1.00	4	12	32,70€
11164	47	1.05	4	8	30,70€
11165	48	1.00	4	8	34,60€
11166	50	1.21	4	12	30,90€
11167	51	1.18	4	8	38,00€
11168	52	1.18	1	10	41,00€
11169	53	1.27	4	12	39,20€
11170	54	1.33	4	12	40,00€
11171	55	1.44	2	8	51,00€
11172	56	1.47	4	8	48,00€
11173	57	1.44	4	8	47,00€
11174	58	1.58	4	8	47,00€
11175	59	1.58	4	120	49,00€
11176	60	1.75	2	4	56,00€
11177	62	1.63	2	4	55,00€
11178	63	1.75	-	8	53,00€
11179	65	1.87	2	8	65,00€
11180	67	1.93	2	8	59,00€
11181	68	1.93	2	8	65,00€
11182	70	2.05	2	4	73,00€
11183	71	3.10	-	6	70,00€
11184	73	3.27	-	4	87,00€
11185	75	3.34	-	6	97,00€
11186	76	3.35	-	5	91,00€
11187	78	3.47	-	5	98,00€
11188	80	3.60	-	4	103,00€
11189	85	3.80	-	4	121,00€
11190	89	3.80	-	2	138,00€
11191	90	3.90	1	4	149,00€
11192	92	4.85	-	2	152,00€
11193	95	4.90	-	2	183,00€
11194	100	4.43	1	4	176,00€
11621	105	8.50	-	2	290,00€
11622	110	8.13	1	2	399,00€
11623	115	8.62	-	2	489,00€

1" (90mmL)

FOARTE LUNG

REF.	mm				€
13745	28	0.77	6	24	25,20€
13746	30	0.95	6	12	25,40€
13747	32	0.92	6	12	25,40€
13748	33	0.88	6	12	24,90€

1/2"

REF.	mm				€
14728	10	0.10	5	20	3,80€
14729	11	0.05	10	100	3,80€
14730	12	0.05	10	100	3,80€
14731	13	0.10	5	20	3,80€
14732	14	0.10	5	20	3,80€
11195	17	0.10	10	100	3,70€
11121	19	0.10	10	60	4,10€
14733	21	0.10	5	20	4,30€
14734	22	0.15	5	20	5,40€
11122	24	0.14	10	20	5,45€
11123	27	0.20	10	50	6,50€
11124	30	0.20	10	50	7,65€
11125	32	0.23	10	50	8,50€

1/2" (78mmL)

LUNG

REF.	mm				€
12061	10	0.14	10	100	9,50€
14736	11	0.15	5	20	5,00€
12062	12	0.15	10	100	9,50€
12063	13	0.15	10	50	9,50€
14737	14	0.15	5	20	5,00€
12064	15	0.17	10	100	9,00€
12065	16	0.30	10	20	9,00€
12066	17	0.20	10	100	9,00€
12067	18	0.22	10	20	9,50€
12068	19	0.21	10	50	9,50€
12069	21	0.25	10	50	9,50€
12070	22	0.27	10	100	10,50€
12071	24	0.30	10	50	11,00€
12072	27	0.36	10	20	12,00€

3/4"

REF.	mm				€
11126	19	0.25	-	10	11,20€
11127	21	0.30	6	24	13,80€
11128	22	0.35	6	24	14,10€
11129	24	0.32	6	54	14,10€
11130	25	0.45	6	24	13,10€
11131	26	0.32	6	36	14,10€
11132	27	0.30	6	54	13,70€
11133	28	0.40	6	12	12,00€
11134	30	0.41	6	24	15,00€
11135	32	0.45	6	48	17,20€
11136	33	0.50	6	12	15,30€
11137	34	0.50	6	24	18,20€
11138	35	0.50	6	12	18,00€
11139	36	0.50	6	24	18,80€
11140	38	0.55	6	24	20,40€
11141	40	0.55	6	12	18,60€
11142	41	0.60	6	12	21,30€
11143	46	0.75	6	18	26,40€
11144	50	1.00	6	24	33,30€
11145	51	1.10	4	12	35,30€
11146	55	1.23	4	12	37,30€
11147	57	1.25	4	12	41,00€
11148	60	1.40	4	12	47,00€
11149	63	1.32	4	12	45,00€
11150	65	1.35	-	8	55,00€
11151	67	1.49	4	12	57,00€
11152	70	1.49	4	12	57,00€

3/4" (90mmL)

LUNG

REF.	mm				€
13723	19	0.43	6	12	18,50€
13724	21	0.50	6	12	19,20€
13725	22	0.61	6	18	19,20€
13726	24	0.56	6	24	19,00€
13727	26	0.51	6	18	18,70€
13728	27	0.50	6	18	18,50€
13729	29	0.70	6	12	22,00€
13730	30	0.70	6	24	22,00€
13731	32	0.71	6	24	21,60€
13732	33	0.75	6	24	23,80€
13733	34	0.85	6	18	24,90€
13734	35	0.80	6	18	25,70€
13735	36	0.81	6	12	25,80€
13736	38	0.83	6	18	25,90€

1"

REF.	mm				€
11624	65	2.40	1	2	189,00€
11625	85	5.35	1	2	282,00€
12984	105	5.00	1	2	379,00€

1/2" (78mmL)

LUNG

REF.	mm				€
14738	10	0.15	10	100	5,50€
14739	11	0.15	10	100	5,50€
14740	12	0.16	10	100	5,55€
14741	13	0.15	10	100	5,55€
14742	14	0.15	10	100	5,55€
14743	16	0.14	10	100	5,15€
14744	17	0.18	10	50	5,35€
14745	19	0.22	10	50	6,25€
14746	21	0.24	10	50	6,40€
14747	22	0.27	10	50	7,10€
14748	24	0.30	10	50	8,30€
11613	27	0.35	10	20	11,00€
11614	30	0.40	6	24	13,00€
11615	32	0.45	6	24	14,20€
11616	33	0.44	6	12	18,10€
11617	34	0.42	6	24	18,70€
11618	35	0.48	6	18	18,80€
11619	36	0.47	4	48	19,50€

52914 223,00€



ORNAMENTE TUBULARĂ BPW
120MM DR.41MM



120mm
8 FEȚE
PĂTRAT HEX 41mm

52915 199,00€



TUBULARĂ PIULIȚĂ PT. ROATĂ
CAMION BPW 111MM DR.41MM



111mm
OVAL
PĂTRAT HEX 41mm

52916 218,00€



TUBLURARĂ PIULIȚĂ PT.
ROATĂ CAMION BPW 109MM
DR.41MM



109mm
8 FEȚE
PĂTRAT HEX 41mm

52917 122,00€



TUBULARĂ AX DIN SPATE BPW
- CAMION 65MM



65mm
OVAL
DIAGONALĂ 36MM

52918 146,00€



ORNAMENTE TUBULARĂ DIN
SPATE PT. AX BPW 95MM



95mm
PĂTRAT 3/4"

52919 181,00€



TUBULARĂ PIULIȚĂ PENTRU
ROATĂ BPW 110MM 3/4"



110mm
8 FEȚE
PĂTRAT 3/4"

52920 155,00€



TUBULARĂ PENTRU
EXTRAGEREA AUXULUI
RULMENTULUI BPW



80mm
PĂTRAT 3/4"

52921 117,00€



TUBULARĂ PENTRU
EXTRAGEREA PIULIȚEI AXULUI
DIN SPATE BPW 65MM 3/4"



65mm
PĂTRAT 3/4"

52922 180,00€



TUBULARĂ PENTRU
EXTRAGEREA
PIULIȚA PUNȚII SUNTVOR



85mm
6 FEȚE
PĂTRAT 3/4"

52923 59,00€



TUBULARĂ PENTRU
EXTRAGEREA PIULIȚEI DE
SUSPENSIE PT. SCANIA
28X37MM 3/4"



28x37mm
PĂTRAT 3/4"

52924 52,00€



TUBULARĂ PENTRU
EXTRAGEREA PIULIȚEI DE
SUSPENSIE PT. SCANIA
34X46MM 3/4"



34x46mm
PĂTRAT 3/4"

52925 176,00€



TUBULARĂ PT. ROATA DIN
FAȚĂ SCANIA 80MM H41



80mm
8 FEȚE
PĂTRAT HEX 41mm

52926 201,00€



TUBULARĂ PENTRU
EXTRAGEREA ROATA SCANIA
100M 3/4" 8 MARGINI



100mm
8 FEȚE
PĂTRAT 3/4"

52927 59,00€



TUBULARĂ PENTRU
EXTRAGEREA ARBALETA



34x56mm
PĂTRAT 3/4"

52928 172,00€



VASO DE BUJE SCANIA



80mm
8 FEȚE
PĂTRAT 3/4"

52929 185,00€



TUBULARĂ PIULIȚĂ PT. ROATĂ
SCANIA 95MM 3/4" 8 FEȚE



95mm
8 FEȚE
PĂTRAT 3/4"

SCULE DE IMPACT

52930 117,00€



UTIL PT. INSTALAREA
RACORDULUI DIN SPATE A
ULEIULUI ÎN ARBORELE COTOT
LA SCANIA



SCANIA 310/320
RACORD 0366303-R

52931 45,00€

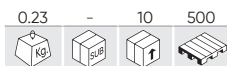

TUBULARĂ CAMION SCANIA
PT. ROTIREA ARBORELLU CU
CAME 1/2"



PĂTRAT 1/2"

52932 45,00€



TUBULARĂ PENTRU SUPAPA
DE INECȚIE
ELECTRO MAGNETICĂ



Ø38mm
PĂTRAT 1/2"

52933 194,00€

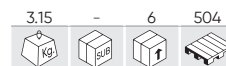

TUBULARĂ DE BUCȘA SCANIA
420



Ø11,6mm - Ø10mm
8 CRENELURI ÎNLĂNȚUITE
PĂTRAT 3/4"
SCANIA 420

53430 286,00€



TUBULARĂ BUCSE PENTRU
IVECO



Ø134mm - Ø110,5mm
118x134mm
IVECO
12 FEȚE

52935 94,00€



TUBULARĂ PIULITA COLIVIE
CAMION BENZ/MAN 60MM



60mm
PĂTRAT 3/4"

52936 199,00€



TUBULARĂ EXTRAGERE BUCȘA
CAMION BENZ/MAN 80-95MM



80-95mm
PĂTRAT 3/4"
6 CRENELURI ÎNLĂNȚUITE

52937 265,00€



TUBULARĂ EXTRAGEREA BUȘEI
DIN SPATE LA CAMION BENZ /
MAN 95-115MM



95-115mm
PĂTRAT 3/4"
6 CRENELURI ÎNLĂNȚUITE

52938 199,00€



TUBULARĂ PENTRU
EXTRAGEREA PIULITEI
DIRECȚIEI
LA CAMION BENZ / MAN



100mm
PĂTRAT 3/4"
6 CRENELURI ÎNLĂNȚUITE

52939 28,00€



TUBULARĂ PENTRU
EXTRAGEREA SUPAPEI DE
INECȚIE SCANIA / BENZ /
MAN



22-28mm
PĂTRAT 1/2"
4 CRENELURI ÎNLĂNȚUITE

52940 235,00€



TUBULARĂ CAMION BENZ/
MAN PARA NUT DIFERENCIAL
TRASEIRO



101mm
PĂTRAT 3/4"
6 CRENELURI ÎNLĂNȚUITE

52941 70,00€



UTIL PENTRU ROTIREA
VOLANULUI DE MOTOR



PĂTRAT 1/2"

52942 105,00€

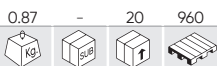

UTIL PENTRU ROTIREA
VOLANULUI DE MOTOR BENZ Y
MAN 3 UNELTE



PĂTRAT 1/2"

52943 75,00€

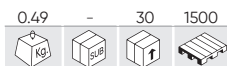

UTIL PENTRU ROTIREA
VOLANULUI



PĂTRAT 1/2"

52934 102,00€

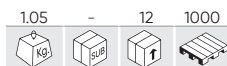

TUBULARĂ PIULITA COLIVIE
CAMION BENS/MAN 56MM



56mm
PĂTRAT 3/4"

REF.	mm			€
52944	30	1.00	20	110,00€
52945	39	2.74	24	281,00€

EXTRACTOR PIVOTI CAMION
ȘI VEHICULE COMERCIALE



52944

PĂTRAT HEX
19mm

52945

PĂTRAT HEX
26mm

CAROSERIE AUTO

180 INSTRUMENTE DE LUCRU PENTRU TINICHIGERIE

183 RESTAURARE FARURI

185 ÎNLOCUIRE GEAMURI

186 REPARAȚII ȘASIU

188 MOBILIER AUXILIAR

191 ÎNTREȚINERE INTERIOARE

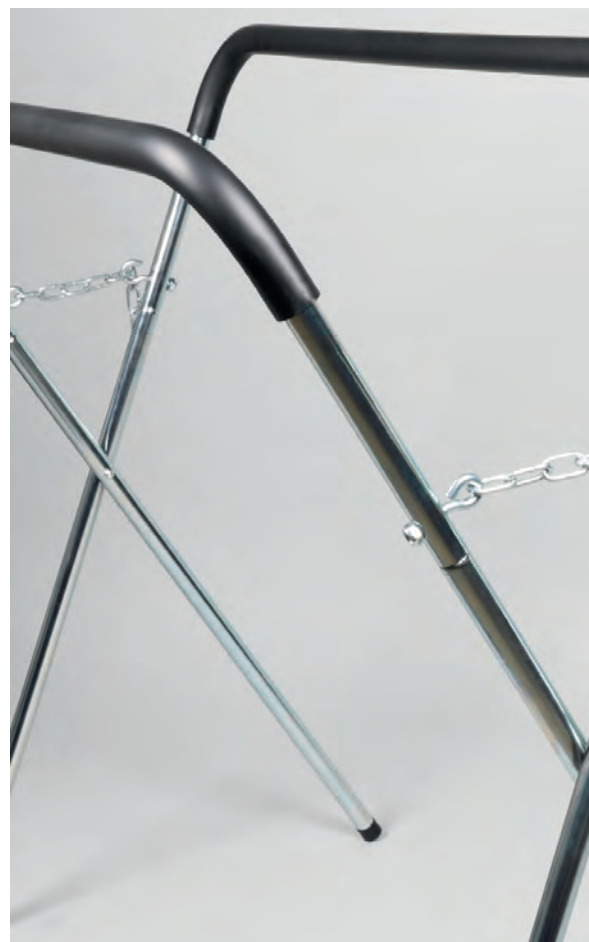
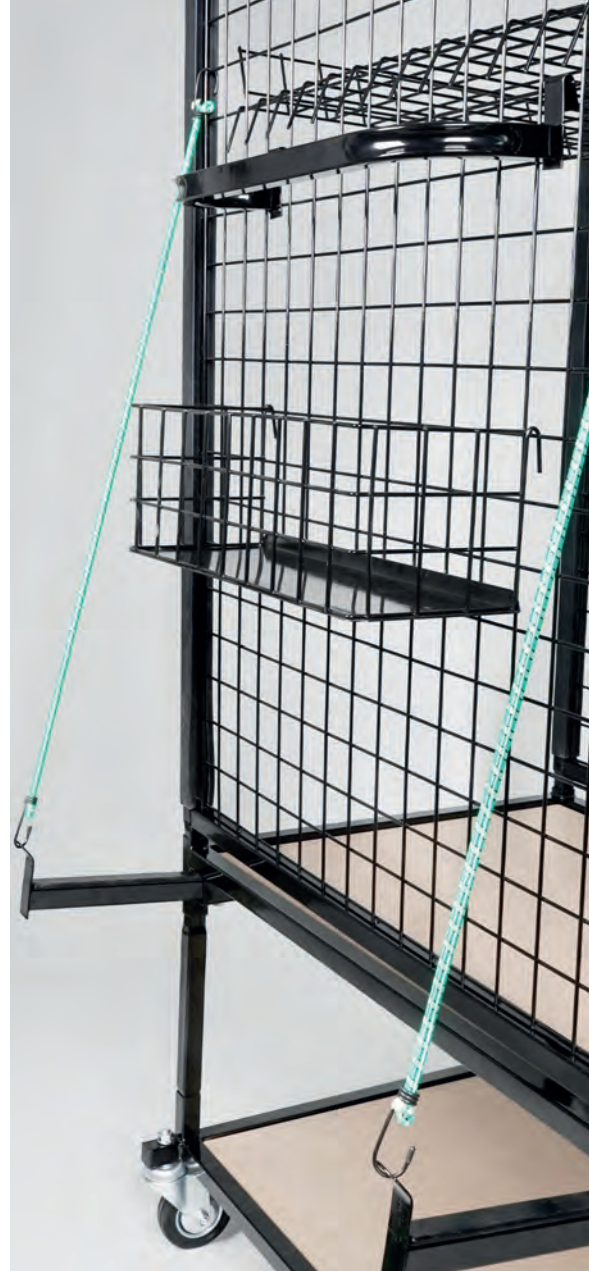

53224

142,00€



SET REPARATOR DE LOVITURI

32 PCS AUDI

PIESE DISPONIBILE

REF. DESCRIERE					€
13842 SET DE 5 SUPORTURI ALBASTRE (REF. 53224)	0.15	10	100	-	8,50€
13843 SET DE 4 SUPORTURI GALBENE (REF. 53224)	0.01	10	100	-	7,00€
13844 SET DE 10 SUPORTURI ROȘII (REF. 53224)	0.05	10	50	-	9,00€
13845 SET DE 5 TIJE DE ÎNCLIEIRE (REF. 53224)	0.02	10	100	-	8,00€



52876

182,00€



SET DE TINICHIGERIE 7 PIESE

PIESE DISPONIBILE

REF. DESCRIERE					€
A 12955 NICOVALĂ CURBATA PENTRU TINICHIGERIE	0.28	-	25	99	27,80€
B 12956 NICOVALĂ PROFILATA PENTRU TINICHIGERIE	0.31	-	25	99	27,80€
C 12957 NICOVALĂ BOMBATA PENTRU TINICHIGERIE	0.37	5	25	99	27,80€
D 12958 NICOVALĂ PANĂ PENTRU TINICHIGERIE	0.41	-	25	-	27,80€
E 12959 NICOVALĂ VIRGULA PENTRU TINICHIGERIE	0.30	5	25	99	27,80€
F 12960 NICOVALĂ CALCAI PENTRU TINICHIGERIE	0.18	-	25	1500	27,80€
G 12961 NICOVALĂ VIRGULA CU MÂNER PENTRU TINICHIGERIE	0.34	-	25	-	27,80€



51131

61,00€



SET DE TINICHIGERIE PENTRU CAROSERII AUTO

PIESE DISPONIBILE

REF. DESCRIERE					€
A 11541 CIOCAN CU CAP LAT	0.43	5	25	-	11,00€
B 11542 CIOCAN VÂRF CREION	0.38	5	25	-	11,00€
C 11543 CIOCAN CU CAP LAT CONIC	0.42	5	25	-	11,00€
D 11544 TAS VERTICAL	0.69	5	25	-	7,00€
E 11545 ARIPA TAS	0.79	5	25	-	11,00€
F 11546 TAS DOUĂ MARGINI	0.81	5	25	-	12,00€
G 11547 PANĂ TAS ÎN 8	0.81	5	25	-	12,00€



53545

35,70€

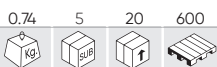

TRUSĂ DE CHEI CU 5 BUCĂȚI CU CAP HEXAGONAL PROLUNGIT 3/8"

5 PCS 3/8"

BMV, FORD, OPEL, VAG, VAUXHALL CrV



8, 10, 12, 13, 14mm (120mmL)



51832 18,00€

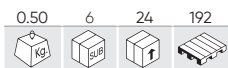

SET DE 4 LEVIERE FINE DIN PLASTIC

4 PCS
 19mm x 273mm
 22mm x 273mm
 25mm x 273mm
 38mm x 273mm



50903 30,80€



SET DE 5 LEVIERE CU MÂNERE DIN PLASTIC

5 PCS
 60, 43, 38, 28, 18cm



52026 31,80€

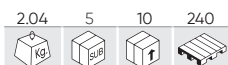

SET DE 2 LEVIERE EXTRALUNGI

2 PCS 90cm

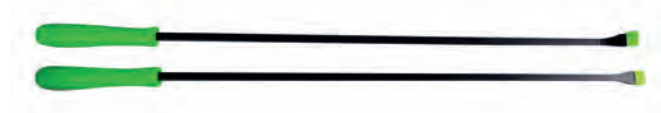

51360 8,05€



LEVIER DE COFRAJ 18"X5/8

18" x 5/8

51361 9,80€



LEVIER DE COFRAJ 24"X3/4

24" x 3/4



52851 9,65€



SET 2 LEVIERE

2 PCS 200mm 225mm

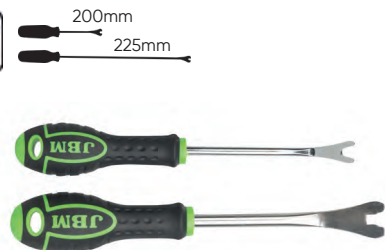

53110 27,30€



SET DE 6 PÂRGHII

6 PCS
 5"x8.5mm
 5"x10.3mm
 5"x4.5mm
 15"x8.5mm
 15"x10.3mm
 15"x4.5mm
 240mm 490mm



50901 16,00€

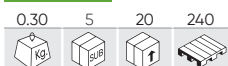

SET 5 LEVIERE DIN PLASTIC DEMONTARE TAPIȚERII

5 PCS

UNIVERSAL
 60x160mm
 63x175mm
 30x200mm
 20x180mm
 20x215mm



52788 39,00€



SET CU 27 CHEI DIN NAILON

27 PCS



52977

137,00€

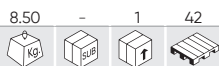

SET DE 4 LEVIERE FOARTE LUNG



52540

221,00€



VENTUZĂ PNEUMATICĂ PT. ÎNDREPTAT LOVITURI LA CAROSERII AUTO

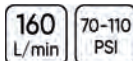

54017

12,00€



INSTRUMENT DE ETANȘARE A ÎMBINĂRILOR DE SILICONIC



KITUL INCLUDE CINCI GARNITURI DE SILICON ÎNLOCUIBILE
3R, 6R, 10R, 13R, 17R



52533

10,00€



PISTOL PROFESIONAL PENTRU SILICON 300ML



53525

12,00€



INSTRUMENT DE BLOCARE A ARCULUI DE GAZ



- Diametrul maxi de deschidere: 10mm.

53655

12,00€



EXTRACTOR PENTRU MÂNERILE UȘILOR VAG



54246

104,00€

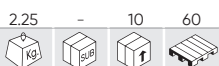

CÂNTAR DE PRECIZIE 5 KG



54247

99,00€



CÂNTAR DE PRECIZIE 2 KG

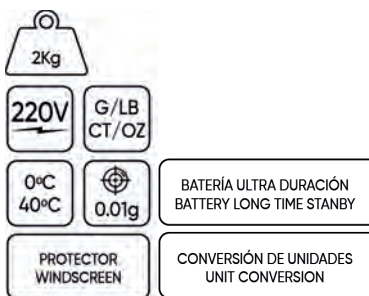

53230

19,70€

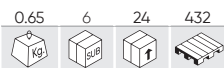

SET DE USTENSILE PENTRU DESCHIDEREA MAȘINILOR



52077

29,50€



SET DE 4 PERNUȚE PNEUMATICE PT. DESCHIS MAȘINI

40-50mm

INCLUDE
Pernuță de 16x16cm
Pernuță de 32x12cm
Pernuță de 19x6cm
Pernuță de 18x4,5cm

- Presiune maximă acceptată: 100 Kg



53486

29,30€



ECRAN PENTRU INSPECȚIA URME DE LOVITURI

Ø 800mm

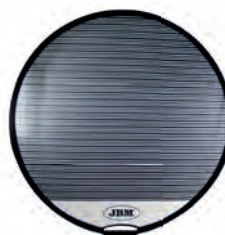

53673

80,00€

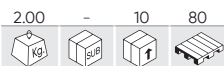

SET PENTRU RESTAURAREA FA-RURILOR

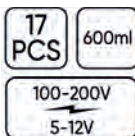

PIESE DISPONIBILE

REF.	DESCRIERE	kg	SUB	cm	cm	€
A	14564 SET DE 6 HÂRTIE DE ȘMIRGHEL PENTRU REF. 53673	0.10	10	100		9,20€
B	14565 ADAPTOR DE CONVERSIE A CURENTULUI ALTERNATIV ÎN CURENT CONTINUU PENTRU REF. 53673	0.20	10	50		26,70€
C	14566 ADAPTOR 12V PENTRU REF. 53673	0.05	10	100		16,70€
D	14567 VAS DE EVAPORARE PENTRU REF. 53673	0.15	10	20		38,00€
E	14568 CAPAC CURBAT CU INEL DE ETANȘARE DIN CAUCIUC PENTRU REF. 53673	0.01	10	200		9,20€
F	14569 CAPAC PLAT CU INEL DE ETANȘARE DIN CAUCIUC PENTRU REF. 53673	0.00	10	200		9,20€
G	14570 PÂLNIE PENTRU REF. 53673	0.01	10	200		4,05€
H	14571 PLACĂ DE RODAT PENTRU REF. 53673	0.05	-	10		9,20€
I	14573 HÂRTIE TEXTURATĂ PENTRU REF. 53673	0.01	10	100		4,05€
J	15375 VAS CU LICHID PENTRU REF. 53673	0.80	4	24		28,00€

15375

28,00€

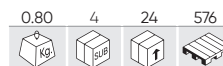

VAS CU LICHID PENTRU REF. 53673

Setul de polymer lichid pentru repararea farurilor este un sistem inovator pentru renovarea farurilor arse până la starea lor inițială, cu un luciu original și un aspect perfect.



UFI: 9600-WOPH-M003-4PRX

LUCIU ORIGINAL ȘI UN ASPECT PERFECT

SET DIN 10 ELEMENTE DE HÂRTIE DE ȘMIRGHEL

REF.	DESCRIERE	kg	SUB	cm	cm	€
14710	GRANULAȚIE 180	0.25	10	100		3,50€
14711	GRANULAȚIE 280	0.20	10	100		3,75€
14712	GRANULAȚIE 360	0.20	10	100		4,00€

REF.	DESCRIERE	kg	SUB	cm	cm	€
14713	GRANULAȚIE 600	0.15	10	100		4,25€
14714	GRANULAȚIE 800	0.15	10	100		4,50€
14715	GRANULAȚIE 1200	0.10	10	100		4,75€



TUTORIAL VIDEO

52740

690,00€

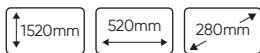
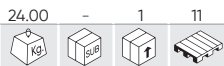

APARAT PENTRU REGLAT FARURI CU LUXOMETRU 152CM



HALOGEN / XENON / LED

- Distanță de măsurare: 50cm.
- Ușoară măsurare a devierilor axului
- Optic a fazei lungi și a fazei scurte.
- Ghiduri de deplasare laterală opționale.
- De asemenea pentru camioane.

52836

1.100,00€

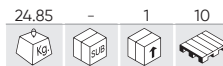

APARAT PENTRU REGLAT FARURI CU DUBLU LASER



HALOGEN / XENON / LED

- De asemenea pentru camioane.

DUBLU LASER
LUXOMETRO DIGITAL
ECRAN DE CONTROL

53626

18,00€



SET PENTRU RESTAURAREA FAPTURILOR



INCLUDE

- x2 roți de șlefuit P800
- x2 roți de șlefuit P1200
- x2 roți de șlefuit P2000
- x2 3,0 ml lichid de protecție UV
- x2 adaptor (3/8 "și 1/4")
- x1 85 g pastă de lustruire
- x1 bandă adezivă
- x1 roată de lustruire din lână
- x1 disc de burete alb

ÎN INTERPRET
12 UNITĂȚI



SERIE262

199,00€

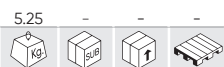

KIT LUSTRIRE: MAȘINĂ DE LUSTRIRE PNEUMATICĂ + 12 SET PENTRU RESTAURAREA FAPTURILOR

53626

x12u.



53646

x1u.



53729

19,10€

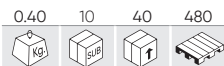

SET DE INSTRUMENTE PENTRU REGLAREA FARURILOR

H6, H7, T25



52262

7,50€

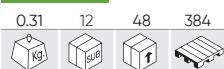

VENTUZĂ UNITARĂ Ø 115MM

40Kg
ø 115mm



52264

18,60€



VENTUZĂ TRIPLĂ Ø 115MM

100Kg
ø 115mm



52295

6,50€

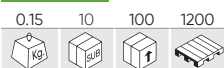

SET DE 2 MINI VENTUZE Ø 60MM

5Kg
ø 60mm



52998

48,00€

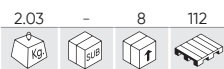

SET DE VENTUZE CU CLICHET 5M X 25MM

80Kg
ø 120mm



53232

39,00€



USTENSILĂ PENTRU ÎNLOCUIREA PARBRIZELOR

7
PCS

INCLUDE

1x Utilaj de extractor de muluri.
1x Levier pentru scoaterea de cauciuc.
1x Cârlig de extragere.
1x 1.8m Fir de tăiere.
2x Mânere pentru tăierea firului.
1x Recipient cu cablu.



13813

7,00€

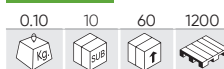

CABLU PENTRU EXTRAGEREA LICHIDULUI DE PARBRIZE

PENTRU REF. 53232



13814

11,00€



UNELTE DE EXTRAGERE PARBRIZE

PENTRU REF. 53232



CAROSERIE AUTO

52321 8,80€

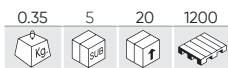

CENTURĂ CU TENSOR ȘI CLICHET 5M X 25MM

5mx25mm



52327 12,00€

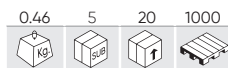

CENTURĂ CU TENSOR ȘI CLICHET 8M X 25MM

8mx25mm



50577 12,60€

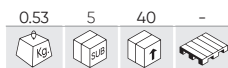

CLEȘTE REGLABIL AUTOBLOCANT

CrV
280mm



52386 23,60€

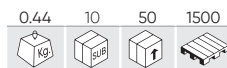

CLEȘTE AUTOBLOCANT CU CIOC GHEARĂ - LISO

CrMo
215mm



52385



JOC DE 6 CLEȘTI CU PRINDERE SPECIALĂ

251,00€

W (195mm)



JJ (195mm)



LL (195mm)



J (210mm)



T (215mm)



L (225mm)



CLEȘTE FIXATOR CU VÂRF

REF.	DESCRIERE							€	
53675	CLEȘTE FIXATOR CU VÂRF DREPT	10"	250mm	70mm	0.75	10	20	300	50,00€
53676	CLEȘTE FIXATOR CU VÂRF ÎNDOIT	10"	250mm	90mm	0.85	10	20	300	44,00€
53677	CLEȘTE FIXATOR CU VÂRF ÎNDOIT ȘI SUPORT ROTATIV	10"	250mm	80mm	0.90	10	20	300	55,00€
53678	CLEȘTE FIXATOR CU VÂRF ALUNGIT ÎNDOIT	10"	300mm	105mm	0.90	10	20	300	52,00€



53675



53676



53677



53678



ÎN INTERPRET
10 UNITĂȚI

52982







SET DE 3 CLEȘTE REGLABIL AUTOBLOCANT

53,00€

3 PCS
37cm 36cm 34cm



CLEȘTE FIXATOR

REF.	DESCRIERE	mm	MATERIAL		T					€
52390	CLEȘTE SPECIAL SUDURĂ	250mm	CrMo	-	-	0.50	5	40	640	35,20€
52474	CLEMĂ DE TRAGERE CAROSERII 5T	190mm	Oțel	0-20mm	5T	3.49	-	5	1500	68,00€
52475	CLEMĂ DE TRAGERE CAROSERII ÎNGUSTĂ 3T	170mm	Oțel	0-25mm	3T	3.60	-	10	1500	62,00€
52476	CLEMĂ DE TRAGERE CAROSERII CAPSULATĂ 5T	220mm	Oțel	0-25mm	5T	3.10	-	10	1500	50,00€
52477	CLEMĂ DE TRAGERE CAROSERII CU AUTOSTRÂNGERE 2T	200mm	Oțel	0-60mm	2T	2.65	-	6	1500	70,00€
52478	CLEMĂ DE TRACȚIUNE CU DUBLĂ TRAGERE 5T	170mm	Oțel	0-20mm	5T	2.90	-	10	1500	49,00€
52479	CLEMĂ TRACȚIUNE MINI 3T 90°	155mm	Oțel	0-20mm	3T	1.18	-	30	1500	24,70€
52480	CLEMĂ DE TRAGERE PĂTRATĂ 90° 3T	210mm	Oțel	0-25mm	3T	2.00	-	10	1500	44,00€
52481	CLEMĂ DE TRAGERE PĂTRATĂ 3T	220mm	Oțel	0-20mm	3T	2.05	-	10	1500	52,00€
52482	CLEMĂ DE TRAGERE CU UNGHI DE 45° 5T	210mm	Oțel	0-10mm	5T	2.13	-	8	1500	44,00€
52483	CLEMĂ DE TRAGERE LATĂ MINI 5T	210mm	Oțel	0-10mm	5T	2.02	-	12	1500	41,00€
52484	CÂRLIG DUBLU PENTRU CAROSERII 3T	275mm	Oțel	0-110mm	3T	1.19	-	11	1500	66,00€
52485	CÂRLIG CU LANȚ TRAS CAROSERII 4T	270mm	Oțel	0-90mm	4T	1.17	-	30	1000	51,00€
52486	CÂRLIG DUBLU CU LANȚ TRAS CAROSERII 3T	280mm	Oțel	0-110mm	3T	1.21	-	11	1500	62,00€
52487	CLEMĂ DE TRACȚIUNE 5T	220mm	Oțel	0-20mm	5T	2.27	-	7	1000	63,00€
52502	CLEȘTE SUDURĂ AUTOBLOCANT	280mm	CrMo	0-110mm	-	0.84	10	30	540	31,40€
52503	CLEȘTE SUDURĂ AUTOBLOCANT TIP C	280mm	CrMo	0-105mm	-	0.85	10	30	540	32,50€
52504	CLEȘTE MENGHINĂ PENTRU SUDURĂ 9"	225mm	CrMo	0-50mm	-	1.14	-	30	480	27,60€
52505	CLEȘTE TINICHIGERIE AUTOBLOCANT	170mm	CrMo	0-40mm	-	0.27	36	72	2160	20,80€
52506	CLEȘTE TINICHIGERIE AUTOBLOCANT TIP C	170mm	CrMo	0-50mm	-	0.28	36	72	2160	16,00€
52507	CLEȘTE TINICHIGERIE CU FĂLCI PLATE	250mm	CrMo	0-80mm	-	0.77	5	30	420	30,10€
52511	CLEȘTE SUDURĂ AUTOBLOCANT 18"	440mm	CrMo	0-225mm	-	1.31	-	20	280	42,00€
52512	CLEȘTE SUDURĂ AUTOBLOCANT TIP C	440mm	CrMo	0-210mm	-	1.31	-	20	280	50,00€



53983

215,00€

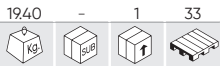

SUPORT PIESE - PARBRIZ ȘI CARCASĂ



12 TIJE DE 630 MM
ACOPERITE CU SPUMĂ DE
POLIETILENĂ EXPANDATĂ
(EPE)

PÂNĂ LA 5 PANOURI SAU
STICLE MARI

ROLE DIN POLIURETAN
(PU) 4 X 4 INCH (DOUĂ
PIVOTANTE CU FRÂNĂ)

53125

477,00€

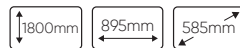
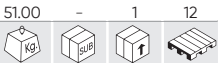

CĂRUȚIOR PENTRU A DEPOZITA PIESE



x4
INCLUS

53124

287,00€



SUPORT DE SUSȚINERE CAROSERII



MĂSURI RIDICATE



MĂSURI LUNGI



50923

454,00€



CĂRUȚIOR PENTRU ROȚI CAROSERII



- Separare: de la 0 la 110cm.

REF. DESCRIERE

12022 ROATĂ DE SCHIMB P/50923



194 - 10 1500 33,70€



53080 99,00€



SUPORT DE SUȚINERE PENTRU PARBRIZ MAȘINĂ



70Kg

52749 79,00€

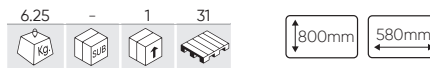

SUPORT PLIABIL PT. ELEMENTE DE CAROSERIE



220Kg

REF.	DESCRIERE	KG	BOX	UNIT	€
11959	SPUMĂ PENTRU SUPORTUL CU REF. 52749	0.08	100		10,50€

53079 89,00€

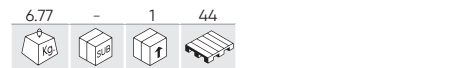

SUPORT DE SUȚINERE CAROSERII ÎN "X"



100Kg

MĂSURI DESFĂȘURAT



MĂSURI DE PLIERE



53736 98,00€



SUPOȚI SUSȚINERE PENTRU BARA DE PROTECȚIE



70mm

LAȚIMEA REGLABILĂ PERMITE CA SUPOȚUL SĂ FIE ADECVAT PENTRU SUSȚINEREA DIFERITELOR TIPURI DE BARE DE PROTECȚIE

LAȚIMEA REGLABILĂ: 75 CM -160CM

INALTIME MAXIMA: 148CM

OȚEL

53685 310,00€



SUPOȚ PENTRU BARA DE PARASTA



REGLAREA BRAȚELOR DE SUȚINERE DE LA 134 - 198CM

4 ROȚI DE 4 INCI (DOUĂ PIVOTANTE CU FRÂNĂ)

OȚEL ACOPERIT CU PULBERE

53134 144,00€



SUPOȚ PENTRU VOPSITORIT



150Kg

- 6 cârlige pentru a atașa bucăți la vopseaua sau uscare.
- Cadru reglabil, care se extinde de la 127cm la 203cm.

53126 243,00€



SUPOȚ BASCULANT VOPSITORIT

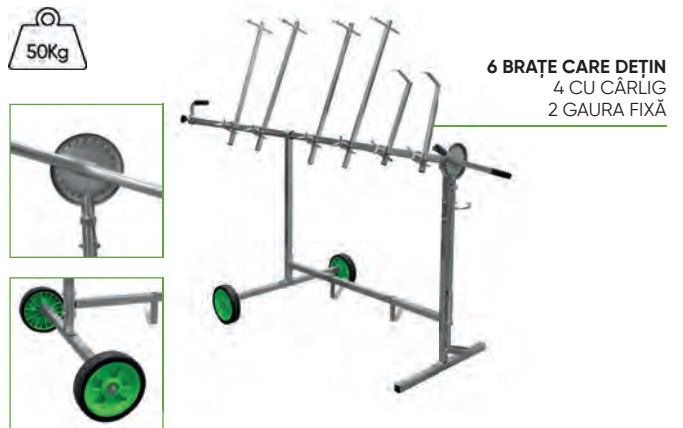

50Kg

6 BRAȚE CARE DEȚIN 4 CU CĂRLIG 2 GAURA FIXĂ

52230

398,00€

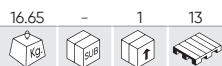

PLATFORMĂ DIN ALUMINIU TELESCOPICĂ

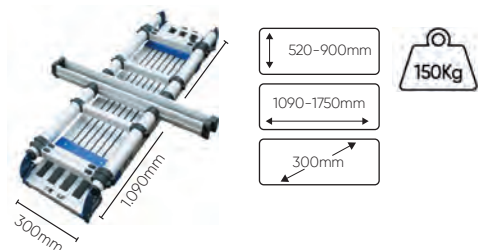

REF. DESCRIERE

REF.	DESCRIERE	10	100	1	13	€
10964	PROTECTOR COLȚ PENTRU PLATFORMA CU REF. 52230	0.01	-	1	-	9,00€
10965	TAMPON TREAPTĂ PENTRU PLATFORMĂ CU REF. 52230	0.01	-	1	-	6,00€
10966	PICIOR DE SCHIMB PENTRU PLATFORMA CU REF. 52230	0.06	-	1	-	13,50€

ÎNDEPLINEȘTE CU: EN 131

50913

195,00€

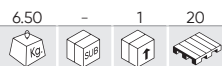

PLATFORMĂ MARE DIN ALUMINIU



ÎNDEPLINEȘTE CU: EN 131

50656

290,00€



SET DE 2 PLATFORME DIN ALUMINIU



ÎNDEPLINEȘTE CU: EN 131

REF. DESCRIERE

REF.	DESCRIERE	10	100	1	10	€
11897	100x30x30cm	4.66	-	1	16	155,00€
15552	130x30x55cm	6.80	-	1	18	181,00€

53922

29,00€



SUPORT PENTRU HÂRTIE PENTRU PERETE

- Oțel inoxidabil
- Rulou: lățime max. 38 cm
- Șuruburi de fixare și piulițe din oțel inoxidabil.
- Dispozitiv de strângere - ABS-plastic, gri.

HÂRTIA NU ESTE INCLUSĂ



53921

39,00€



SUPORT PENTRU HÂRTIE

- Material: oțel inoxidabil
- Rulou: lățime max. 38 cm
- Dispozitiv de strângere - ABS-plastic

HÂRTIA NU ESTE INCLUSĂ



SET SUPORT DE PERETE + MATERIAL PENTRU PROTEJAREA VEHICULELOR

50400 168,00€

12.44 - 1 35



INCLUDE

- 53705 SUPORT DE PERETE
- 51978 ROLĂ CU HUSE DE PROTECȚIE
- 52057 ROLĂ FOLIE PLASTICĂ PENTRU VOLAN
- 52058 MÂNER PENTRU ROLĂ FOLIE ELASTICĂ
- 50409 FUNDE ANONIME DIN HÂRTIE PT. AUTO

50403 98,00€

8.90 - 1 70



INCLUDE

- 52065 SUPORT DE PERETE
- 51978 ROLĂ CU HUSE DE PROTECȚIE
- 52057 ROLĂ FOLIE PLASTICĂ PENTRU VOLAN
- 52058 MÂNER PENTRU ROLĂ FOLIE ELASTICĂ

50410 168,00€

12.44 - 1 35



INCLUDE

- 53705 SUPORT DE PERETE
- 52244 ROLĂ CU HUSE DE PROTECȚIE
- 52057 ROLĂ FOLIE PLASTICĂ PENTRU VOLAN
- 52058 MÂNER PENTRU ROLĂ FOLIE ELASTICĂ
- 50409 FUNDE ANONIME DIN HÂRTIE PT. AUTO

SUPPORT DE PERETE PENTRU HUSE DE PROTECȚIE AUTO

53705 80,00€

4.90 - 1 28



51985 84,00€

4.85 - 1 28



52065 45,00€

2.19 - 1 77



51978 84,00€

9.70 - 1 49

ROLĂ CU HUSE DE PROTECȚIE 25MC 250U.



250 PCS 25 mc

52244 84,00€

9.55 - 1 49

ROLĂ CU HUSE DE PROTECȚIE DESEN ANONIM 25MC 250U.



250 PCS 25 mc

52057 6,80€

0.62 - 24 672

ROLĂ FOLIE PLASTICĂ PENTRU VOLAN

23 mc - Lungime: 200m
- Lățime: 12,5cm
- Grosime: 23mc

52058 4,50€

0.06 10 125 2500

MÂNER PENTRU ROLĂ FOLIE ELASTICĂ CU REF. 52057

23 mc

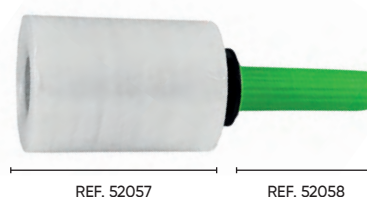

REF. 52057

REF. 52058

CAROSERIE AUTO

50409

26,00€

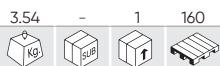

FUNDE ANONIME DIN HÂRTIE PT AUTO

250 PCS



51824

36,80€



HUSE DE PROTECȚIE PENTRU VOLAN , DIN PLASTIC 250U.

250 PCS



50916

0.05 100 400 3200



KIT DE ÎNTREȚINERE AUTO ÎN PUNGĂ INDIVIDUALĂ

5 PCS 20 mc



0,88€

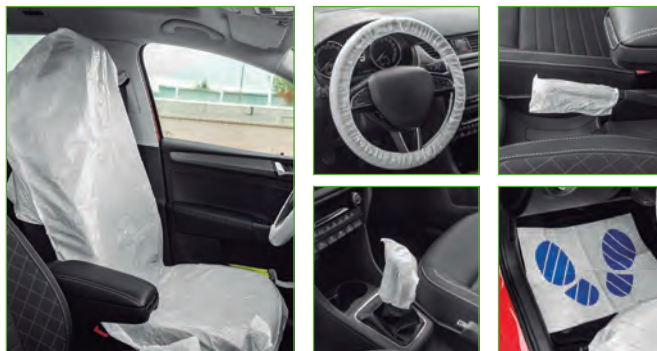

53226

14,90€

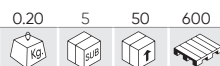

HUSĂ DE TAPIȚERIE



- NYLON.

51622

25,30€



HUSĂ MAGNETICĂ PROTECȚIE 360



4 PUNCTE MAGNETIZATE

DOUĂ FEȚE:
UNA CATIFELATĂ / UNA PLASTICĂ



BARĂ EXTENSIBILĂ MULTIFUNCȚIONALĂ

REF.	Max.	Min.					€
52497	1200mm	530mm	0.29	6	48	480	26,80€
53196	1600mm	710mm	0.37	6	48	384	33,00€



FRÂNE

194 SCULE PENTRU REPOZIȚIONARE FRÂNE

197 PURGATOARE FRÂNE

197 ÎNTREȚINERE



52636

114,00€

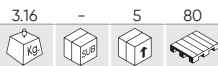
16
PCS

PRESĂ PENTRU PISTOANE DE FRÂNĂ

- 0 General Motors (Ø pistonului 2-1/2 inci)
- 2 Citroën XM/Xantia (F/R), HONDA
Audi (F), Fiat, Alfa romeo (F), Ford Fiesta (F), Isuzu (F), Honda Concesto (F), Jaguar XJ6/ XJ40 (F/R), BMW 318is / 320i / 325T / 518i / 525i-1x / 740i / 850ci / M5 (F), Mercedes BENZ 190/200/300/420/560 serie (F), Mitsubishi Colt (F), Nissan Miera/Stanza/Sunny (F), Rover Austin/Metro200-400 series/Maestra/Montego (F), Toyota Camry (F), Volvo (F), VW Passat/Golf GTI (F)
- 4 Ford Australia/NZ Telstar, Mazda (R), Saab 9000 (R)/Lumina, Toyota, Fiat 164 2.0 (R), Alfa Romeo Prelude/CRS 16i, Honda Saturn (R)/Grand Prix, GM
- 5 Adaptor 3/8"
- 6 Nissan Primera, VW Golf IV
Audi 80/90/V8+100/Coupe E (R), Rover 800 ABS, Subaru L+Z (R), Ford Sierra ABS/Granada/Scorpio ABS (R), Nissan Bluebird 1.8 Turbo/Silvia Turbo/Primer2.0i LS-GS-GSX (R), Peugeot 405 1.9Gi/Gri/Sri/Gtxi/MI 16/605 2.0 Sri (R), Toyota Cecilia/Corolla GT/MR2 (R), VW Golf Gti/Jeta Synchron/Jetta Gti 16v, Passat CL, GL, GT, GT 16v, Corrado 16V scirocca GTX 16V(R), Citroën, Alfa romeo, Fiat, Honda, Jaguar, Renault, Saab, Seat, Lancia.
- 7
- 8 General Motors (Ø pistonului 1-7/8 inci)
- 9 General Motors (Ø pistonului 2-1/8 inci)
- A(Z) Renault (R21-Laguna (R))
- E Nissan Maximas/Cefiro
- F(G) Opel (Rear disk)/ Fiat Stilo
- K Citroën C5
- K1 Renault, Citroën C5

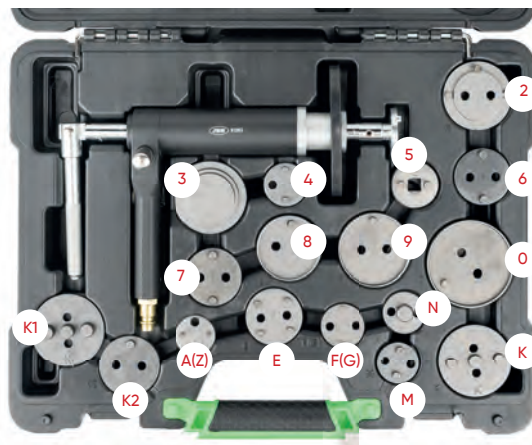

- K2 Renault, Citroën, Audi A8, S8
- M Ford, Mini Cooper, Nissan Primera 03
Saab, Honda, Alfa Romeo 164 2.0 Twin Spark/2.0 Turbo (88-)/3.0 V6, Audi 200 (80-)/Coupe GT SE (82-)/80/90/1Q0/200/Quattro (87-)/90/20V (88-), Ford Mondeo 2.0/Ghia, Lancia Themaalte (85-), Volkswagen Golf II GTI (83-87)/Sirocco 16V (84)
- N

52330

99,00€

50
PCSOPEL PEUGEOT
CITROËN RENAULT

PRESĂ PENTRU PISTOANE DE FRÂNĂ

- 0 General Motors (Ø pistonului 2-1/2 inci)
- 1 Discul
- 2 Citroën XM, Xantia u.a.
- 3 Alfa Romeo,Audi, Austin, BMW, Ford, Honda, Jaguar, Mercedes-Benz. Mitsubishi, Nissan Rover, Toyota, VW
- 4 Alfa Romeo 164 2.0.Ford, Mazda, Saab 9000, Subaru
- 5 Adaptor 3/8"
- 6 Nissan Primera, VW-Golf IV
- 7 Audi 8.0,90,V8 +100, Ford Sierra ABS+ Scorpio ab 85, Honda Prelude, Nissan Silvia 1.8 turbo, Rover 8000, Saab 9000, Subaru L+Z, VW-Golf+ Passat
- 8 General Motors (Ø pistonului 1-7/8 inci)
- 9 General Motors (Ø pistonului 2-1/8 inci)
- 11 Discul pentru Jaguar S Type
- 12 Discul pentru BMW mini
- A Nissan Premira 2.0, Bluebird
- A1 Ford Transit 06,Transit Connect 02,Tourneo Connect 02,Mondeo 00-07,C-Max 03, Focus 04
- B Ford, Lincoln, Subaru
- B1 Ford S-max 06,Scorpio 94-06,Mondeo 07,Kuga 08,Galaxy 00-06,Focus RS 03,Fiesta 01-02,Cougar 98-01
- C Nissan Primera (02), Opel Vectra 02-,Toyota Avensis
- D Citroën, Renault
- E Cefiro, Maxima
- F Peugeot 206 CC / Hdi / Gti. Este nevoie de o cheie de piston 16mm din spate
- F1 Fiat Ducato
- G Opel
- G1 Volkswagen Golf V / VI
Alfa Romeo 155 1.8-2.0 164 TD(93) 164 3.0 V6(91), Audi 80,90,A3,A4,A6,A8, Citroen ZX 2 Qi 16V, Fiat Tipo TD 16V, Uno Turbo (85) Crama TD, Ford Sierra (ABS bak). Granada (85) Crama TD, Ford Sierra (ABS bak). (Australia& NZ) Thunderbird Turbo, Honda CXR, 1.6i-16V (8-90), Accord 1800 (84-85) 2.0i, Prelude 16V (88), Legend V6, Jaguar XJ 4, Oseries, Lancia Dadra 2.0, Ei Tur (93), Delta 1.6 Gti, Nissan, Peugeot, Renault, Seat, Subaru, Volvo V40 6S40.
- J
- K Citroën C5
- K1 Citroën
- K2 Citroën, Renault.
- M Ford
- N Saab, Honda
- O Discul

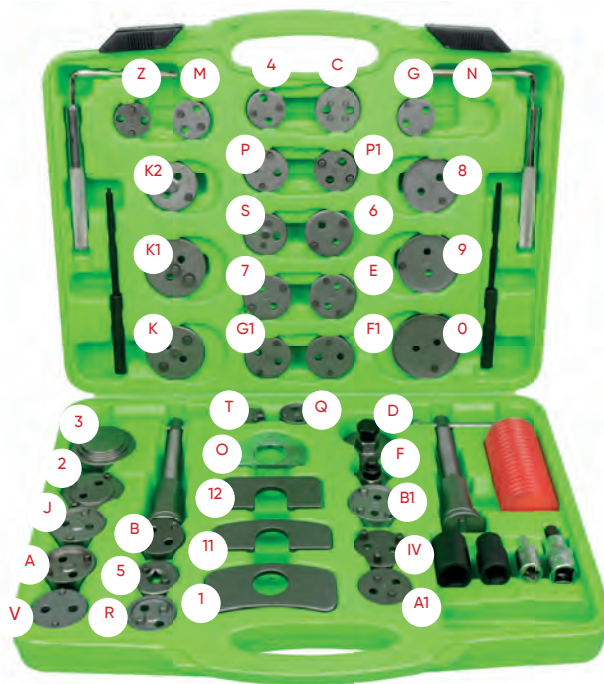

- P Audi, BMW, Ford, Lancia, Piston, Renault, Rover.
- P1 Peugeot 307,308.
Alfa Romeo 164 2.0 1., Fiat Uno, Turbo ie-Barchetta, Ford Escort MK III, IV, Orion, XR31, Focus(98-) push-back pistons, Honda-most models (push-back pistons), Rover-most models(push-back pistons), Subaru Lserie & Serie 2
Ford(Australia& NZ) Teslar, Laser, Mazda 323 Gti. GTXX (86), 929 (82.), RX7(81-), 626
R 16V(87-) 626 GT (86-), 929 V6 (88-), Mitsubishi Galant GL Si, Toyota Celica, Corolla GT, MR2
Audi 100 TQ(91), BMW 740i 8cyl (91), Lancia Delta 1.9 TD (95), Proton 416. Renault-most models, Renault Laguna 2.0 (94), Laguna 2.2. D (95) Safrane 2.0-2.2 TD V6, Rover 623 Si, Volkswagen Golf Gtu Mk I&IV, Passat VR6, Vento GT (92)
- S
- T Rover 220 C Turbo (95)
- V Rover 216 Gti 16V,820 Si 2.0(93),825 SD 2.5 (93)
- Z Renault
- IV Iveco Daily, Volkswagen Passat 2.0 TDI 09-

53978

38,90€

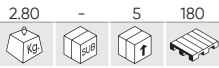

PRESĂ PENTRU PISTOANE DE FRÂNĂ 23 PIESE

0	General Motors (Ø pistonului 2-1/2 inci)
1	Discul
2	Citroën XM, Xantia
3	Alfa Romeo, Audi, Austin, BMW, Ford, Honda, Jaguar, Mercedes-Benz, Mitsubishi, Nissan, Rover, Toyota, VW
4	Alfa Romeo 164 2.0, Ford, Mazda, Saab 9000, Subaru
5	Adaptor 3/8"
6	Nissan Primera, VW.Golf IV
7	Audi 80;90;V8+100, Ford Sierra ABS+Scorpio de 1985, Honda Prelude, Nissan Silvia 1.8 turbo, Rover 8000, Saab 9000, Subaru L+Z, VW Golf + Passat
8	General Motors (Ø pistonului 1-7/8 inci)
9	General Motors (Ø pistonului 2-1/8 inci)
10	VW
A	Renault R21, Laguna
E	Nissan Maxima, Cefiro
F	Opel
K	Citroën C5
K1	Citroën
K2	Citroën
M	Ford
N	Saab, Honda
O	Discul

J Fiat Tipo TD 16V, Uno Turbo(85) Crama TD, Honda CRX, Alfa Romeo 155 1.8-2.0i, 164 TD (93), 164 3.0 V6 (91); Audi 80, 90, & V8's, A3, A4, A6, A8 (pinza traseara); Citroën ZX 2. Qi 16v; Fiat Tipo TD 16V, Uno Turbo (85-), Crama TD; Ford Sierra (ABS bak), Granada (85-); Ford (Australia & NZ) Thunderbird Turbo; Honda CRX, 1.6i-16V (88-90), Accord 1800 (84-85), 2.0i (86-), Prelude 16V (88-), LegendV6; Jaguar XJ serie 40; Lancia Dedra. 2.0 Ei Tur(93), Delta 1.6 Gti. (92), The. majE 16v(92), Thema. 2000 Turbo. Kappa 2.Q-2.4LS, 2.4TD;

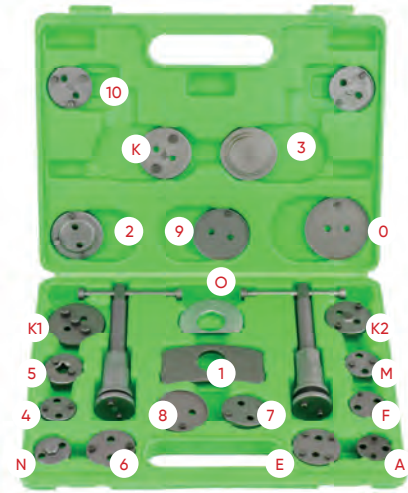

J Nissan 280 ZX (82-84), 300 ZX Turbo (84-89), Bluebird 16V (89-), Silvia 1.8 Turbo (85-88) 100 NZ 2.0 (93), Primera 2.0 GT (94), 200 SX turbo 16V, Maxima 2.0 GX-3.0 GX (95); Peugeot 306; Peugeot 309 Gtj 16S (91), 405. Srif Q. rj, Gil (87-), 405 M.1 16V; Renault Master Van; Rover 216 Gti 16V, 820 Si 2.0 (93), 825 SD 2.5 (93); Saab 9000 CS 2.0(93), 9000 CSE Turbo(93); Seat Toledo GT. 16V-GT 2.0(93), Ibiza 1.8 Gti 16V(95); Subaru Lserie & Serie 2; Volkswagen Passat 2.0 & 2.2 Litre(84), Golf Rallye (-89), Golf II Gti 16V(89-), Vento GT (92), Transporter T4; Volvo S40 & V40

51059

99,00€

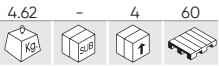

PRESĂ PENTRU PISTOANE DE FRÂNĂ

0	Discul
1	Discul
2	Citroën XM, Xantia (F/R)
3	Alfa Romeo, Audi, Austin, BMW, Ford, Honda, Jaguar, Mercedes-Benz, Mitsubishi, Nissan, Rover, Toyota, VW.
4	Alfa Romeo 164 2,0,Ford,Mazada,Saab 9000,Subaru.
5	Adaptor 3/8"
6	Nissan Primera,VW-Golf IV.
7	Audi 80,90,V8 +100,Ford Sierra ABS+Scorpio ab 85,Honda Prelude Nissan Silvia 1.8 turbo,Rover 8000, Saab 9000, Subaru L+Z, VW-Golf +Passat.
8	General Motors (Ø pistonului 1-7/8 inci)
9	General Motors (Ø pistonului 2-1/8 inci)
11	Discul pentru Jaguar S Type
12	Discul pentru BMW mini
A	1-3/16" disc cu două pini pentru Renault R21, Laguna
B	Ford, Lincoln, Subaru.
C	Mini Austin
D	Citroën, Renault.
E	Cefiro, Maxima
F	Opel Corsa, Astra, Zafiraand Vectra
G	Opel (discul spate)
J	Alfa Romeo 155 1.8-2.0 164 TD(93) 164 3.0 V6(91) Audi,80,90,A3,A4,A6,A8 Citroën ZX 2 Qi 16V,Fiat Tipo TD 16V,Uno Turbo(85) Crama TD, Ford Sierra(ABS bak),Granada (85),(Australia & NZ) Thunderbird Turbo,Honda CRX,1.6i-16V (8-90),Accord 1800(84-85)2.0i,Prelude 16V(88),Legend V6,Jaguar XJ40series,Lancia Dedra 2.0 Ei Tur(93),Delta 1.6Gti,Nissan,Peugeot, Renault,Seat,Subaru,Volvo V40& S40.

K	Citroën C5
K1	Citroën, Renault.
K2	Citroën, Renault.
M	Ford
N	Saab,Honda. Z: Renault
O	GM Motors.
P	Audi, BMW, Ford, Lancia, Proton, Renault, Rover, VW
R	Ford (Australia & NZ) Telstar,Laser, Mazda 323 Gti,GTX(86-),929(82-),RX7(81-),626 16V (87-), 626 GT (86-),929 V6(88-),Mitsubishi Galant GL Si, Toyota Celica,Corolla GT,MR2.
S	Audi 100TQi(91), BMW 740i 8cyl.(91), Lancia Delta 1.9 TD(95), Proton 416, Renault-most models, Renault Laguna 2.0 (94), Laguna 2.2 D(95), Safrane 2.0-2.2 TD V6, Rover 623 Si, Volkswagen Golf Gti Mk 3&4,Passat VR6,Vento GT(92).

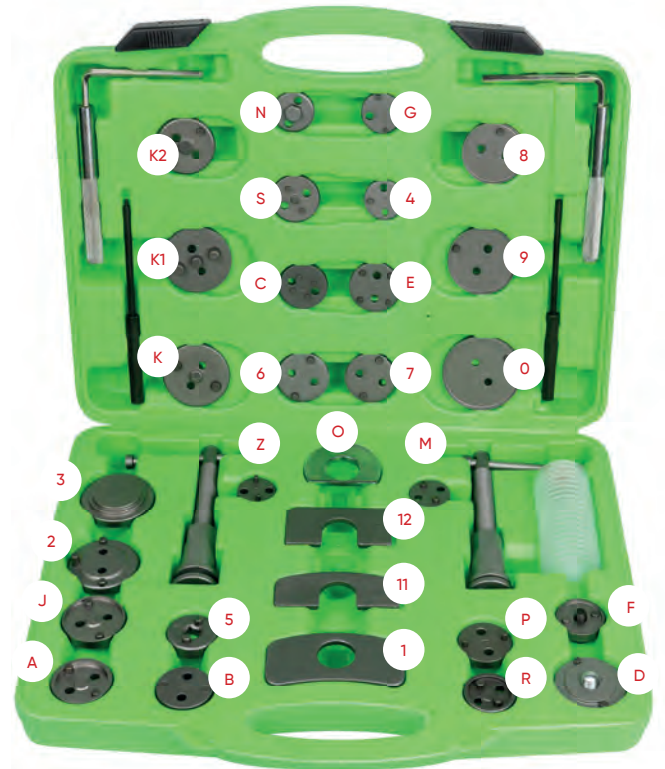

Z BMW, Mini

Sublerul rotire dreapta (cu filet dreapta)

Graiber rotire la stânga (cu filet stânga)

Pin Ø 3.0 / Pin Ø5.5 (100g Grăsime)

52906

38,00€

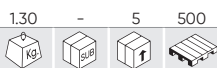

PRESĂ PENTRU PISTOANE DE FRÂNĂ



REF. DESCRIERE

REF.	DESCRIERE	1.30	5	500	€	
12974	PIESĂ DE SCHIMB 2 PINI SET PENTRU PISTOANE DE FRÂNĂ UNIVERSAL (REF. 52906)	0.50	-	50	1500	21,00€
12975	PIESĂ DE SCHIMB 3 PINI SET PENTRU PISTOANE DE FRÂNĂ UNIVERSAL (REF. 52906)	0.17	-	50	-	23,00€



ALFA ROMEO 164 2.0, FORD, MAZDA, SAAB 9000, SUBARU, NISSAN PRIMERA, VW, AUDI, FORD SIERRA ABS + SCORPIO AB 85, HONDA PRELUDE, NISSAN SILVIA 1.8 TURBO, ROVER 8000, SAAB 9000, FORD, OPEL, BMW, LANCIA, PROTON, RENAULT, ROVER, PEUGEOT 307, 308 A3- IVECO DAILY, VOLKSWAGON PASSAT 2.0 TDI 09, RENAULT LAGUNA.

53683

116,00€

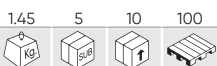

PRESĂ PNEUMATICĂ PENTRU PISTOANE DE FRÂNĂ CU PROFIL REDUS

- Resiune normală de uz: 5 - 8bar.
- Presiune maximă de lucru: 14bar.



51283

78,00€

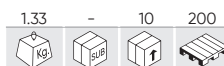

PRESĂ PNEUMATICĂ PENTRU PISTOANE DE FRÂNĂ

- Resiune normală de uz: 5 - 8bar.
- Presiune maximă de lucru: 14bar.



52191

198,00€

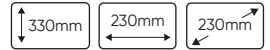
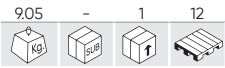

AP. AUTOMAT PT. AERISIT/SCHIMBAT LICHIDUL DE FRÂNĂ

5L

- Presiune (reglabilă) de lucru: de 0 la 4 kg/cm².
- Intrare și ieșire de 1/2".
- Greutate: 5kg.
- 11+2 adaptoare.
- Gamă aplicații: GM, Chrysler, Nissan.



REF. DESCRIERE

52328 DOPURI PT. APARATUL DE AERISIT SIST. DE FRÂNARE PENTRU REF. 52191

2.90 - 4 64 99,00€

52434

125,00€

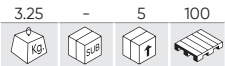
15
PCS

SET PENTRU REPARAÇÃO / ÎNTREȚINEREA DE TRAVÕES

- x2 Chei pentru piulițe de frână
- x1 Clește pentru arc de frână
- x1 Șurubelniță cu impact
- x3 Prize pentru șurubelniță
- x1 Unealta de asamblare
- x1 Surubelnita cu articulatie universal
- x1 Unealta speciala de frana
- x1 Perie de curatat
- x1 Perie de curatare din alama
- x1 Unealta de asamblare
- x1 Clește cablu de frână
- x1 Pila etrier de frana



54135

82,00€

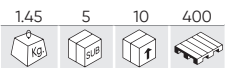
17
PCS

SET DE PRIZE PENTRU ETRIER DE FRÂNĂ

INCLUDE

	x2	14x38, 22x38mm
	x3	11,50x38, 15x38, 20x38mm
	x4	10, 12.50, 14, 19mm
	x1	10mm
	x4	H11x100, H7x70, H7x92, H9x50mm
	x2	7x24, 8x24mm
	x1	9x20mm



AUDI (A4, A5, S5, S8, Q5, Q7), PORSCHE (CAYENNE, MACAN, CAYMAN), MERCEDES BENZ, FORD, BMW, ALFA ROMEO

54372

157,00€

2.56 - 5 120



N

SET TESTER DE FRÂNĂ CU ȘI FĂRĂ ABS

Conceput pentru dezinstalarea etrierilor de frână la înlocuirea plăcuțelor de frână.

APLICAȚII

Audi (TT (2007-), A4 (2001-), A6 (2005-), A8 (2003-), Q7, S5, S6, S8), Porsche (Cayenne, Macan, Cayman), Mercedes-Benz (ML320, Clase C), Ford (Mondeo, Fiesta, Focus, Edge), BMW (Series 3 -generación E36 / 5), Alfa Romeo, Jaguar (XF), Vauxhall, Volkswagen, Chrysler, Mini, SAAB

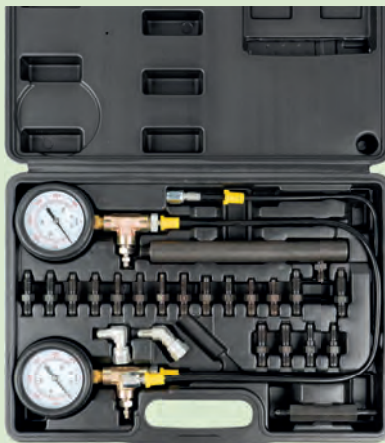

INCLUDE

- x1 Adaptor Teves
- x1 Racord pivotant la 45°
- x1 Racord pivotant la 90°
- x2 Racord drept 7/16-24
- x2 Racord drept 1/4-28
- x2 Racord drept 3/8-24
- x2 Racord drept 5/16-24
- x2 Racord drept M10-1,5 Racord drept
- x2 Racord drept M8-1,25
- x2 Adaptor de purjare M10-1,0
- x2 Racord drept 7/16-20
- x2 Racord drept M7-1,0

52625

9,00€

0.35 6 48 1824



CLEȘTE DE FRÂNĂ CU TAMBUR



- Clește pentru strâns arcul la saboții de frână.
- Pentru demontarea și montarea arcurilor de retur la frânele cu tambur.

52315

16,00€

0.88 5 20 640



DISPOZITIV PT. SCHIMBAREA PLĂCUȚELOR DE FRÂNĂ



- Deschidere maximă: 80mm.

51839

24,00€

0.05 25 100 2400



TESTER PENTRU LICHID DE FRÂNĂ

- Funcționează cu baterii 1xAAA LR03.
- Cu 4 nivele de calitate măsurabile.



52455

16,00€

0.26 10 20 864



SET DE LERE PENTRU PASTILE DE FRÂNĂ

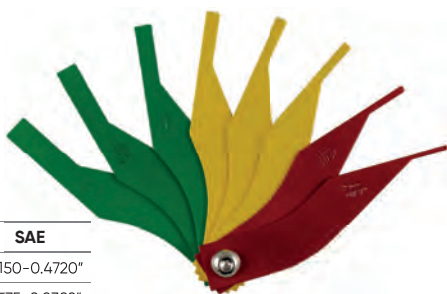

COLOR	METRIC	SAE
Green	8-10-12mm	0.3150-0.4720"
Yellow	4-5-6mm	0.1575-0.2382"
Red	2-3mm	0.0787-0.1181"

52275

38,00€

0.79 - 4 112



AP. MANUAL PT. AERISIT/SCHIMBAT LICHIDUL DE FRÂNĂ

1L



- Temperatura de lucru: 10°C la 50°C.
- Mâner de silicon: 2m.
- Pistol de suflat cu intrare 1/4".
- Presi une aer: 6-12 bar (87 - 174 psi).
- Consum de aer: 180litri/min.

SCULE SPECIALE

- 200 SISTEM DE LUBRIFIERE
- 206 EXTRACTOARE DE INJECTOARE
- 213 BLOC/CHIULASA
- 216 AMBREIAJ
- 217 SISTEMUL DE RĂCIRE
- 219 SISTEMUL DE AER CONDIȚIONAT
- 221 TRANSMISIE
- 223 SUSPENSIE
- 229 EVACUARE
- 231 SISTEMUL ELECTRIC
- 235 REPARAȚII FILETE
- 238 MOTOCICLETĂ
- 238 EXTRACTOARE



54068

120,00€

19
PCS AI

SET DE CHEIE PENTRU FILTRE DIN ALUMINIU PENTRU ULEI, 19 BUC.

REF.	NR DE PIESA	DESCRIERE	CANTOS x Ø				€
15494	05101	Mazda, Mitsubishi	15 x 100,5mm	0.18	-	50	12,50€
15495	0595	Nissan, Toyota	15 x 94,5mm	0.18	-	50	12,50€
15496	0592	Nissan, Subaru	15 x 92mm	0.18	-	50	11,50€
15497	0579	Toyota, Honda, Mitsubishi, Subaru, Mazda, Lsuzu	15 x 79mm	0.14	-	50	11,00€
15498	915	Volvo	16 x 87mm	0.24	-	50	11,50€
15499	901L	Lexus	14 x 79,5mm	0.15	-	50	11,00€
15500	901T	Toyota	14 x 70mm	0.13	-	50	10,00€
15501	901-1	Toyota	14 x 63-64mm	0.10	-	50	10,00€
15502	902	Ford, Mazda	14 x 66,5mm	0.89	-	50	10,00€
15503	1284	Dodge Sprinter (2007-), Mercedes Benz E320 (2007-), Jeep Cherokee 3.0L V6 Common Rail (2007-)	14 x 84mm	0.13	-	50	11,00€
15504	903B	Mercedes Benz	14 x 74mm	0.13	-	50	10,00€
15505	24mm	BMW 5, BMW 7, BMW X5 V8 (N62) (2004-), Saturn (2008), Astra 1.8L ECOTEC, Chrysler 3.6L V6 (2011-), 200, 300, T/C Dodge Jeep	6 x 24mm	0.47	-	50	4,00€
15506	27mm	Mercedes Benz Clase A	6 x 27mm	0.45	-	50	4,00€
15507	30mm	Audi A2, Vw Polo, Lupo 1.4L/1.6L	6 x 30mm	0.44	-	10	4,50€
15508	32,5mm	Opel Astra G, Corsa B, Zafira, Audi, VW 1-36 mm, Opel Omega, Vectra B, Zafira (98-), BMW M43/60)	6 x 32,5mm	0.45	-	50	4,50€
15509	36mm	Opel Omega, Vectra B, Zafira (98-), BMW M43/60, Mercedes Benz Vito CDI, C, E, VW Lupo 1.2 TDI, MAN	6 x 36mm	0.48	-	50	5,00€
15510	38mm	Opel Vectra 2.0D	6 x 38mm	0.50	-	50	5,00€
15511	917	Universal	55-90mm	0.22	-	50	8,00€



51332

98,00€

23
PCS AI

JOC DE EXTRACTOARE PENTRU FILTRE DE ULEI

REF.	NR DE PIESA	DESCRIERE	CANTOS x Ø				€
11374	901	Toyota, Nissan, Fiat Daihatsu	14 x 65mm	0.05	5	20	5,50€
11375	902	Toyota, Daihatsu	14 x 67mm	0.45	5	20	6,50€
11376	903	VW, Mercedes, BMW, Opel, Audi	14 x 74mm	0.20	5	20	5,50€
11377	903-1	GM/AC, Wix, Ford, Isuzu	15 x 75mm	0.09	5	20	5,50€
11378	903-2	VW, Audi, Seat, BMW, Renault	8 x 74mm	0.09	5	20	6,50€
11379	903-3	Audi, Rover, Chrysler	15 x 74mm	0.11	5	20	6,00€
11380	903-4	Toyota, Lexus	14 x 73mm	0.11	5	20	6,50€
11381	903-6	Schlepper, Baumashinen	12 x 75mm	0.10	-	20	6,50€
11382	918	Rover, Chrysler, Audi	15 x 74mm	0.11	5	20	6,00€
11383	904	Nissan, Ford	15 x 79mm	0.50	5	20	6,00€
11384	905	GM, Chrysler	15 x 73mm	0.12	5	20	6,00€
11385	905-1	BMW, Mercedes, Opel, Audi, VW	14 x 74mm	0.10	5	20	5,50€
11386	906	Baumashinen, Schlepper	18 x 84mm	0.10	5	20	6,00€
11387	907	Mitsubishi, Toyota	15 x 89mm	0.13	5	20	6,00€
11388	908	Nissan, Toyota	15 x 91mm	0.14	5	20	6,00€
11389	915	Honda Accord, Mitsubishi, Isuzu	15 x 90mm	0.16	5	20	6,00€
11390	910	Toyota, Alfa Romeo, Ford	15 x 95mm	0.12	5	20	6,00€
11391	911	Fiat, Renault, Citroën	12 x 76mm	0.09	5	20	6,50€
11392	911-1	Subaru, Toyota, Honda, Nissan	15 x 80mm	0.09	5	20	6,00€
11393	914	Mazda, Toyota	15 x 101mm	0.18	5	20	6,00€
11394	909	Isuzu, Nissan	15 x 92mm	0.14	5	20	6,00€



11376



11385

REF.	DESCRIERE				€
14992	CHEIE CU 12 COLȚURI PENTRU NR. 51332/NR.14141	0.14	-	100	8,50€
10955	MECANISM CU CLICHET 1/2" PENTRU EXTRACTOR FILTRU 51332	0.14	-	50	11,00€

TUBULARE EXTRAȚIE FILTRU DE ULEI

REF.	CANTOS x Ø	DESCRIERE					€
52311	42mm	GRUPO VAG	0.13	6	72	1728	19,00€
52312	14 x 74mm	VW, OPEL, MERCEDES, BMW, AUDI	0.10	10	100	1000	9,00€
52313	16 x 86mm	VOLVO 540, 560, 570, 580	0.20	6	68	1008	8,00€
52314	16 x 87mm	BMW, VOLVO	0.20	5	50	600	26,60€
52809	14 x 64,5mm	TOYOTA	0.15	10	100	1000	8,50€
53441	14 x 76mm	-	0.20	5	20	800	9,80€



53008

15,50€

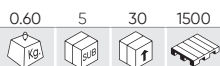

EXTRACTOR FILTRU DE ULEI PENTRU FORD, CITROËN, PEUGEOT 2.0, 2.2 HDI, TDCI



52518

115,00€



EXTRACTOR FILTRU DE CAMION 95-165MM



52615

112,00€



SET DE 9 EXTRACTOARE PT. FILTRU DE ULEI

9 PCS

- Cheie reglabilă cu sens dublu.
- Rang de aplicație: 60-80mm.

1/2"	x1	Universal	63 - 83mm
		Mercedes Benz, Smart	27mm
	x3	GM, Opel, Vauxhall, Mercedes Benz	32mm
		Mercedes Diesel, BMW, Mini, Ford	36mm
		Toyota (Allion, Auris, Corolla, Prius, Voxy, etc.)	64,5mm
3/8"	x3	Toyota, Lexus (6 Zyl.).	64,5mm
		Audi, BMW, Ford, Toyota, Volkswagen, Porsche, Mercedes-Benz	74,2mm
	x1	Hunday, Kia.	88,8mm
	x1	BMW 3+5+X, Volvo	86,6mm



EXTRACTOR FILTRU DE ULEI CU PICIOR ROTUND / LAT

51352

9,80€



1/2" - 3/8"
57-118mm
Ø2-1/4" ~ 5"

51353

11,50€



1/2" - 3/8"
72-136mm
Ø2-1/2" ~ 4"

51923

12,50€



1/2" - 3/8"
72-136mm
Ø2-1/2" ~ 4"

51934

11,50€

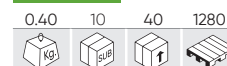

1/2" - 3/8"
57-118mm
Ø2-1/2" ~ 4"

53206

38,20€

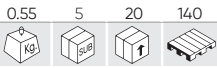

5
PCS

SET 5 JOJE PENTRU VERIFICAT NIVELUL DE ULEI LA BENZ/AUDI

- Pentru a verifica lichidul de transmisie a uleiului din motoarele Audi 100:
 - Vârful (primul 11 mm) arată lectura fluidului rece la 20 ° C.
 - A doua lectură este minimul la 80 ° C.
 - A treia lectură este la maxim 80 ° C.
- Mențineți nivelul vehiculului la verificarea ATF.
- Jojă pentru motor pentru a verifica nivelul uleiului, compatibil cu o gamă largă de motoare, din anul 1988 până în anul 2005, gama Mercedes.



	Mercedes-Benz	920mm	- Codul de transmisie: 716.5,722.7,722.8.
	Mercedes-Benz	930mm	- Anul fabricației: 1988-1997. - Codurile motorului: 103,104,111,119,120,137,604,605,606,611,612,613,628,642,647,648.
	Mercedes-Benz	930mm	- Anul fabricației: 1996-2005. - Codurile motorului: 103,104,111,112,113,119,120,137,271,272,604,605,606,611,612,613,628,642,646,647,648.
	Mercedes-Benz	1200mm	- Codul de transmisie: 722.6.
	Audi	1160mm	- Motoarele AUDI 100.

REF. DESCRIERE

13856	JOJĂ PENTRU VERIFICAREA ULEIULUI AUDI	0.04	5	100	-	7,80€
-------	---------------------------------------	------	---	-----	---	-------

51354

13,20€

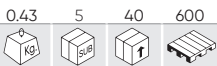

CLEȘTE PENTRU FILTRE DE ULEI

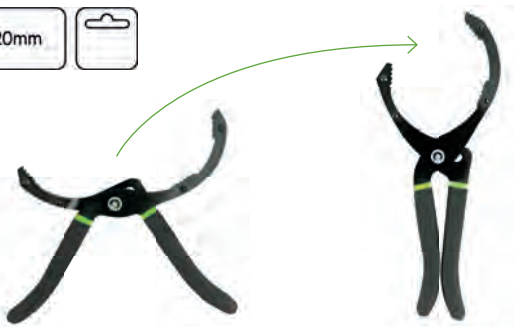

53670

29,50€

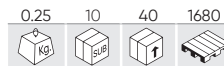

CHEIE PENTRU FILTRU DE ULEI PENTRU VAG
DSG 1/2" 24 MM

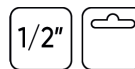

- Set de scule pentru repararea și condiționarea șuruburilor roților, precum și ancorarea acestora la firul feminin al vehiculului; utilă în fire parțial deteriorate.



52269

7,00€

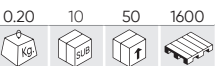

EXTRACTOR FILTRU CU
BANDĂ

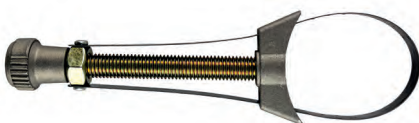

SCHIMB

REF.	mm	Kg	QTY	VOL	€
11106	360mm	0.02	10	50	3,00€

52677

17,00€



EXTRACTOR DE FILTRU
AJUSTABIL Ø65-105MM



SCHIMB

REF.	mm	Kg	QTY	VOL	€
11936	383mm	0.15	5	300	4,00€

52678

18,00€

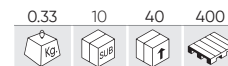

EXTRACTOR DE FILTRU
AJUSTABIL Ø110-155MM

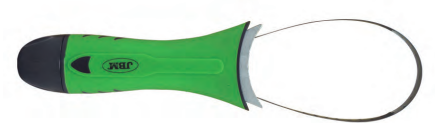

SCHIMB

REF.	mm	Kg	QTY	VOL	€
11937	540mm	0.04	10	100	5,00€

EXTRACTOR FILTRU

52417 28,00€

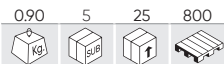

LANȚ DE MARE REZISTENȚĂ

52416 14,00€

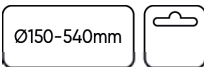
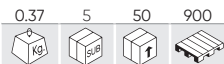

CUREA DE POLIMER
(REZISTENTA MARE)

52607 49,00€

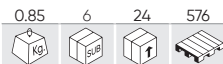

DUBLU LANȚ ARTICULAT

52608 44,00€

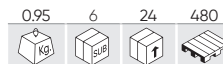

DUBLU LANȚ ARTICULAT

53735



TRUSĂ CHEI BUȘON BAIE DE ULEI, 23PCS

44,00€

23 PCS 3/8"

INCLUDE

	x2	5/16", 3/8"
	x7	7, 8, 10, 11, 12, 13, 14mm
	x1	10mm
	x1	10mm
	x7	8, 9, 10, 12, 13, 14, 17mm
	x1	T45
	x1	M16

	x1	200mm
	x2	75, 150mm

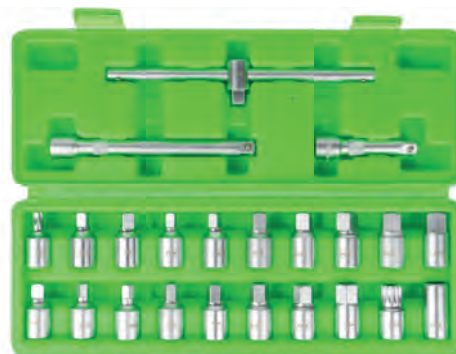

15084



MODUL DE EXTRAGERE A CAPACELOR DE CARTER

68,00€



INCLUDE

	x2	5/16", 3/8"
	x7	7, 8, 10, 11, 12, 13, 14mm
	x1	10mm
	x1	10mm
	x7	8, 9, 10, 12, 13, 14, 17mm
	x1	T45
	x1	M16
	x1	200mm
	x1	150mm



POTRIVIT ȘI PENTRU COLECTOARELE DE ULEI ART.53873 ȘI 53874.

SET REPARATOR DE FILETE PENTRU BUȘON

53235 10,40€



M13



53236 11,50€



M15



53237 12,90€



M17



53238 18,40€



M20



ȘURUB GOLIRE ULEI DIN MASE PLASTICE

5
PCS

REF.	DESCRIERE					€
13969	VAG	0.02	10	100	-	19,00€
53537	BMW	0.05	10	100	4000	14,50€
53538	Ford	0.10	10	100	4000	14,50€
53741	Ford / PSA	0.05	10	100	4000	14,00€



53472 12,00€

0.10	10	100	1200

CHEIE GOLIRE ULEI V.A.G.



52617 7,00€

0.23	6	36	1620

CHEIE PENTRU BAIE DE ULEI

- Citroën, Renault, Peugeot.



53473 36,00€

0.40	10	50	800

SET INSTRUMENTE PENTRU ȘURUBURI GOLIRE ULEI DIN MASE PLĂȘTICE



5
PCS

A	x1	3/8"	80x100mm	Ford	OEM 1830727
B	x1	1/4"	1,5mm	VAG	OEM 06L 103 801
C	x1	1/4"	10mm	BMW	OEM 11137605018
D	x1	3/8"	3mm	Peugeot/Citroën	OEM 9801444780/OEM18711598
E	x1	1/4"	- 3/8"		

52754 54,00€

1.25	-	5	160

COMPRESOR DE PRESIUNE ULEI

0-10
BAR

0-140
PSI

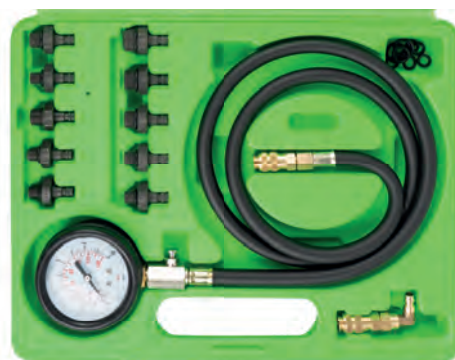

x1	M10x1.0mm	x1	1/8" DIN 2999
x1	M12x1.5mm	x1	1/8" x 27 NPT
x1	M14x1.5mm	x1	1/4" x 18 NPT
x1	M16x1.5mm	x1	3/8" x 20 UNF
x1	M18x1.5mm	x1	1/2" x 20 UNF

51337 50,00€

1.55	-	10	180

SET DE REPARAT FILETE BAIE DE ULEI

24
PCS

- Dopuri de SKS3.
- Filiere de 1 015.
- Șaibe de Cupru.

CONȚINUT

- M13x1,5P
- M15x1,5P
- M17x1,5P
- M20x1,5P
- Filiere: 1 unitate pe dimensiune.
- Dopuri: 5 unități pe dimensiune.
- Șaibe: 10 unități pe dimensiune.

PIESE DISPONIBILE

	REF.	DESCRIERE				€
	A 51400	M15 x 1.5P	0.15	50	100	17,00€
	B 51401	M17 x 1.5P	0.14	50	100	22,00€
	C 51402	M20 x 1.5P	0.10	25	50	20,50€
	D 51403	M13 x 1.5P	0.15	50	100	17,50€
	E 14930	M13 x 1.5P	0.05	10	100	9,50€
	F 14931	M15 x 1.5P	0.05	50	100	8,00€
	G 14932	M17 x 1.5P	0.07	5	100	9,50€
	H 14933	M20 x 1.5P	0.10	5	100	9,50€

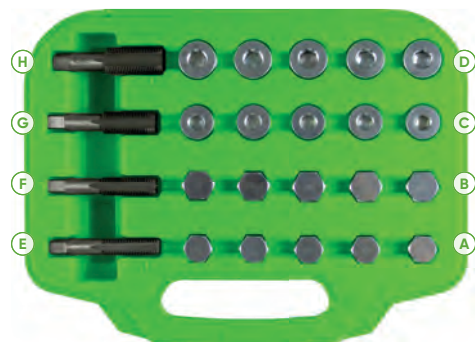

53485

140,00€

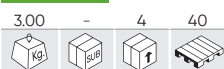

SET DE UMLERE DE ULEI CU PÂLNIE ȘI ADAPTOARE



- A Adaptor filetat M42 x 4.5 pentru Subaru
- B Adaptor filetat M37 x 3,0 (tip scurt) pentru Lotus, Pontiac, Scion, Toyota
- 3- Adaptor Filetat M35 x 4.0 pentru Ford, Jaguar, Land Rover, Mazda
- C Adaptor Filetat M35 x 4.0 pentru Ford, Jaguar, Land Rover, Mazda
- D Adaptor Filetat M32 x 3.5 pentru Acura, Dodge, Ford, Honda, Jaguar, Jeep, Land Rover, Mazda, Nissan
- E Adaptor Baionetă pentru Toyota & Lexus 3.0 & 3.3L V6
- F Adaptor Baionetă pentru Audi, BMW, Mercedes-Benz, Porsche, Volvo, VW
- G Adaptor filetat M30 x 3.0 pentru Dodge Cummins
- H Adaptor filetat (1/2 rotire) pentru Mazda 3 / 6 / CX-5
- I Adaptor filetat (1/2 rotire) pentru for Cadillac, Chevy, Ford, GMC, Hyundai, Jaguar, Land Rover, Mazda, Saab, Mercury
- J Adaptor filetat (1/4 rotire) pentru capacele noi de umplere cu ulei începând cu anul 2008 pe Audi, Seat, Skoda, VW cu motor EA888
- K Adaptor filetat (1/2 rotire) pentru Dodge Hemi 6.4L (2011-) & >3.6L (>2014)
- L Adaptor filetat M37 x 3.0 (tip lung) pentru Lotus, Pontiac, Scion, Toyota

53347

100,00€



SET DE UMLERE DE ULEI CU PÂLNIE ȘI ADAPTOARE



- A Adaptor filetat M42 x 4.5 pentru Subaru
- B Adaptor filetat M37 x 3,0 (tip scurt) pentru Lotus, Pontiac, Scion, Toyota
- C Adaptor Filetat M35 x 4.0 pentru Ford, Jaguar, Land Rover, Mazda
- D Adaptor Filetat M32 x 3.5 pentru Acura, Dodge, Ford, Honda, Jaguar, Jeep, Land Rover, Mazda, Nissan
- E Adaptor Baionetă pentru Toyota & Lexus 3.0 & 3.3l V6
- F Adaptor Baionetă pentru Audi, BMW, Dodge, Mercedes-Benz, Porsche, Volvo, VW

52305

106,00€



SET REPARAȚIE BUJII INCANDESCENTE

16 PCS



- Extractor pentru bujii incandescente rupte în chiuloasă.
- Acest set conține 16 piese, este util pentru extragerea bujiilor incandescente rupte fără a fi necesar dezmontarea chiuloasei de pe motor.
- Unversal, este ideal pentru motoare Mercedes-Benz CDI.
- Extrage bujiile incandescente rupte în chiuloasă M8 și M10.
- Include filet de 1/4" M8 și burghiu în trepte de altă rezistență cu dublă dimensiune M8 și M10.

51494

107,00€



SET EXTRAȚIE INJECTOARE

9 PCS S



- | | | | | | |
|--|------------|------------|--|----------------------|----------|
| | M12 x 1.75 | M8 x 1.5 | | M14 x 1.5 | M8 x 1.5 |
| | M14 x 1.5 | M17 x 1.5 | | M14 x 1.5 | |
| | M14 x 1.5 | M27 x 1.0 | | HRC: Hardness 30 -35 | |
| | M14 x 1.5 | M12 x 1.75 | | 1.75Kg. | |
| | M14 x 1.5 | M8 x 1.5 | | | |

54186

250,00€

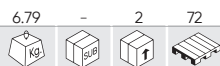

SET DE EXTRACȚIE PNEUMATICĂ PENTRU INJECTOARE

6-8 BAR S 20-30 Nm BOSCH, DELPHI, DENSO, SIEMENS

REF.	DESCRIERE	kg	Sub	U	€
16366	M20X1,0 10MM	0.13	-	30	11,00€
16367	M10X1,5 14MM	0.08	-	30	10,00€
16368	M14X1,5 15MM	0.10	-	30	12,00€
16369	M14X1,5 33MM	0.12	-	30	12,00€
16370	M16X1,5 18MM	0.10	-	-	12,00€
16371	M17X1,0 10MM	0.11	-	30	11,00€
16372	M18X0,75 10MM	0.10	-	30	11,50€
16373	M18X1,5 18MM	0.10	-	30	12,00€
16374	M22X1,5 15MM	0.10	-	30	12,00€
16375	M25X0,5 9MM	0.10	-	30	15,00€
16376	M25X1,0 13MM	0.10	-	30	15,00€
16377	M26X0,75 15MM	0.10	-	30	16,00€
16378	M27X0,75 10MM	0.10	-	30	15,00€
16379	M29X1,0 11MM	0.10	-	30	15,00€
16380	M31X0,75 15MM	0.12	-	30	16,00€

REF.	DESCRIERE	kg	Sub	U	€
16381	M8X1,0 14MM	0.09	-	30	10,00€
16382	M8X1,25 14MM	0.01	-	30	10,00€
16383	M14X1,5 9MM	0.13	-	30	15,00€
16384	M14X1,5 9MM	0.11	-	30	15,00€

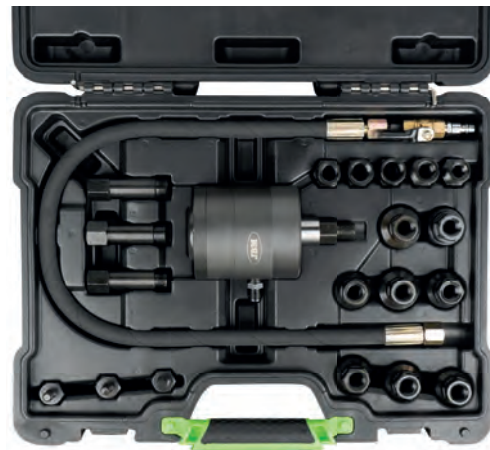

54345

15,00€

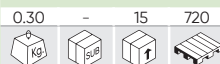

SPRAY DE GHEAȚĂ

-42° 400ml

UFI: MD82-13A7 G004-V27H

Potrivit pentru utilizarea pe suprafețe metalice prin răcirea materialului și promovarea contracției oțelului pentru o îndepărtare ușoară.



16295

30,00€



SET DE 3 ADAPTOARE PENTRU EXTRACTOR DE INJECTOR (REF.54186)



52858

298,00€



SET EXTRACȚIE INJECTOARE

Ciocane	1,6Kg (160mm)
	2,7Kg (460mm)
	5,1Kg (600mm)
Extractoare de gheare cu separare între padele	13,7X18mm (105mm)
	12,7x19mm (130mm)
Cani (6pt)	1/2" - 25, 27, 28, 29, 30mm (100mm)
Adaptor cu filet exterior	M27x1.0
	M25x1.0
Adaptor cu filet intern	M27x1.0
	M17x1.0mm
Injector extractor	⊕ ∅ 35mm
	⊖ ∅ 29mm
Adaptor ciocan culisant pentru extractor intern, extern și cu gheare	

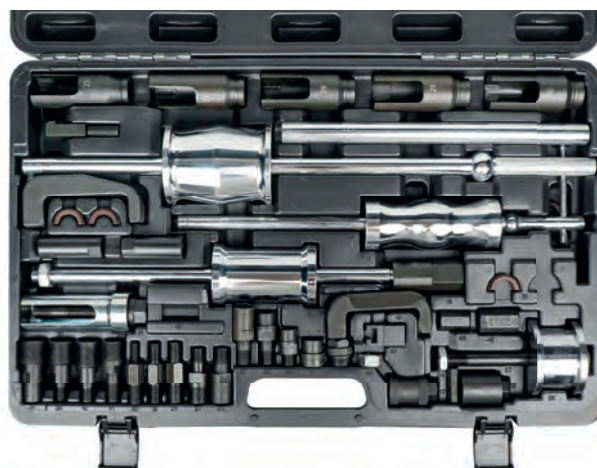

51493

68,00€

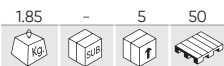

SET / TESTER VERIFICARE INJECTOARE

31
PCS

BOSCH, SIEMENS, DENSO, DELPHI

Scopul acestui instrument este de a măsura cu rapiditate și eficacitate cantitatea retur de combustibil a fiecărui injector în depozit, prin care se poate depista dacă vreun injector este afectat. Adecvat pentru uz în Bosch, Siemens, Denso și Delphi injector.

INCLUDE

- 6 eprubete pentru verificare în faza de pornire
- 6 recipiente cu tub pentru verificare în relanti
- Cutie de depozitare

REF. DESCRIERE



12901 FLACON + CAPAC + FURTUN PENTRU REF.51493 0.03 10 60 - 5,20€



54391

221,00€

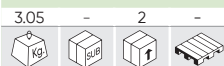

TESTER DE DUZE PENTRU INJECTOARE DIESEL

0-60 MPA
5-8 BAR
0-600 BAR
0-8700 PSI
M12
M14

Acest instrument vă ajută să verificați starea injectoarelor în timp ce aplicați presiune asupra lor. Este special indicat pentru verificarea modelului de atomizare și a presiunii de deschidere a injectoarelor.

x1 M12

x2 M14



54392

1.855,00€

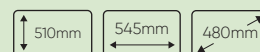
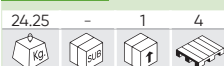

CURĂȚĂTOR ȘI TESTER DE INJECTOARE GDI / EFI

220V
60W
50-60 Hz
0,1-10 BAR
5-8 BAR
<85%
-10°C
40°C

Acest aparat vă permite să curățați și să verificați funcționarea corectă a injectoarelor GDI și EFI. Datorită microcontrolerului său, aparatul poate simula condițiile reale de funcționare a motorului, permițând observarea comportamentului fiecărui injector și detectarea eventualelor defecțiuni.

Pentru curățarea injectoarelor, acesta utilizează curățarea cu ultrasunete, garantând astfel eliminarea completă a oricăror reziduuri care pot fi prezente atât în injectoarele pe benzină, cât și în cele pe motorină. Pentru sistemele EFI, acesta include, de asemenea, un mod de curățare integrată.

TUTORIAL
VIDEO

54220

197,00€

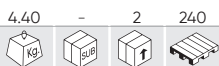

INSTRUMENT DE INSTALARE ȘI ÎNDEPĂRTARE A INJECTORULUI DE COMBUSTIBIL BMW MERCEDES BENZ

MĂRCI	<p>BMW: 135iS (2008-), 335 (2007-), 335Xi (2007-), 535i (2008-), 535Xi (2008-), 550i GT (2010-), 750Li (2009-), 750Li (2009-), X3 3.0i (2007-), X5 (2011-), X5 3.0i (2008-), X6 (2008-)</p> <p>MERCEDES-BENZ: C-CLASS (2007-), CLK / SLK (2007-), E-CLASS (2007-), A / CLA / GLA 45 AMG (2013-), CL / CLS 63 AMG (2010-), E / G / GL 63 AMG (2011-), GLE 63 AMG (2015-), S / SL 63 AMG (2010-), SLK 55 AMG (2012-)</p>
INSTRUMENTE OEM	<p>BMW: 130180(1), 130195(2), 130270(3), 130320(4), 2249115(5)</p> <p>MERCEDES-BENZ: 271589023300(6), 278589003300(7)</p>
CODURILE DE MOTOR	<p>BMW: N14 / N18 / N20 / N47 / N54 / N57 / N55 / N63</p> <p>MERCEDES-BENZ: M133 / M152 / M157 / M270 / M271 / M274 / M276 / M278</p>

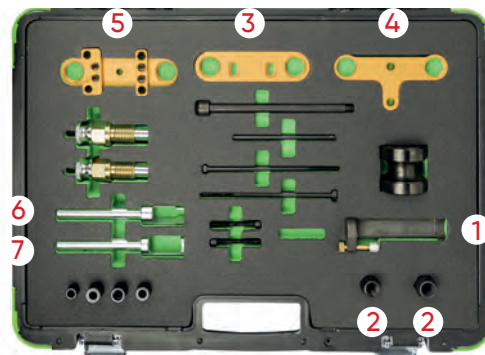

52815

110,00€



SET PENTRU EXTRAGEREA VÂRFULUI DE LA BUJII INCANDESCENTE

22 PCS



53250

85,00€



SET EXTRAȚIE DE RULMENȚI INTERNI ȘI EXTERNI

5 PCS



53069

98,00€









SET EXTRAȚIE INJECTOARE DIESEL PENTRU CITROËN, PEUGEOT

9 PCS

CITROËN, PEUGEOT



-  x1
-  x3
-  x2 Ø 17mm
-  x2 Ø 25mm
-  x2 25mm
-  x1 29mm
-  x1 21mm

52629

99,00€



SET DE EXTRAȚIE A INJECTOARELOR PENTRU MERCEDES

3 PCS

MERCEDES



M16x1.5

52639

123,00€

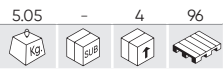

SET PENTRU BRAȚUL DE DIRECȚIE



53464

153,00€



TRUSĂ DE ȘAIBE DE CUPRU PENTRU INJECTOARE 551 PCS

551 PCS

PENTRU MAI MULTE INFORMAȚII

PAGINĂ 387



53501

24,00€

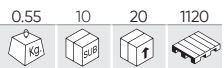

EXTRACTOARE (PRESE) PENTRU POMPĂ DE COMBUSTIBIL DIESEL BMW



OEM 1 13 5 191 | 13 5 192 | 13 5 190 BMW.
BWM: M47 / M47T2 / M47TU / M57 / M57TU.
SERIES: E46 (318D-320D) (1988 - 2005) and E60, E61 (318TD-320TD-525D-530D-530-535) (2000 - 2006).

53009

42,00€

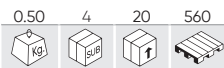

EXTRACTOR DE TUBURI DE INECȚIE DIESEL



53522

24,00€

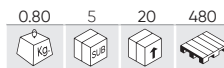

EXTRACTORUL INEELOR DE ETANȘARE A POMPEI INJECTOR



53696

22,00€

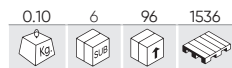

INSTRUMENT REDUCĂTOR PENTRU CLEME DE FURTUN DE TIP HENN



VOLKSWAGEN, AUDI, SEAT, ŠKODA, BMW, PEUGEOT, CITROËN, DACIA, FIAT, FORD, KIA, LEXUS, MAZDA, MERCEDES, NISSAN, OPEL/VAUXHALL, PORSCHE, RENAULT, TOYOTA, VOLVO.

52757

16,00€



CHEIE REGLABILĂ PT. POMPĂ COMBUSTIBIL PE REZERVOR



53490

275,00€

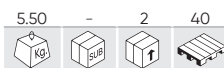

SET PENTRU TESTAREA COMPRESIEI LA MOTORE PETROL ȘI DIESEL

- M24
- M20
- M24
- M20
- Ø 10, 12, 14, 18mm



ALFA ROMEO, BMW, CHRYSLER, CITROËN, DAEWOO, FIAT, FORD, HONDA, HYUNDAI, ISUZU, JEEP, KIA, LADA, LANCIA, LAND ROVER, LDV, MAZDA, MERCEDES, MG, MITSUBISHI, NISSAN, PEUGEOT, RENAULT, ROVER, SAAB, SSANGYONG, SUZUKI, TOYOTA, VAG, VAUXHALL/OPEL, VOLVO

53096

28,80€

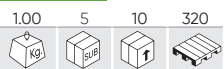

CHEIE FIXĂ PENTRU CISTERNĂ COMBUSTIBIL



54373

395,00€

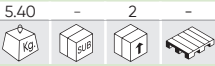

MANOMETRU COMMON RAIL DE ÎNALTĂ PRESIUNE



x2 M12x1,25	x6 M12x1,50
x2 M14x1,25	x6 M14x1,50

Un instrument esențial pentru măsurarea presiunii ridicate generate de cursa de compresie în cilindrul de aer al unui motor diesel. Dispune de o varietate de adaptoare pentru diferite specificații și conexiuni care pot măsura diferite tipuri de motoare diesel

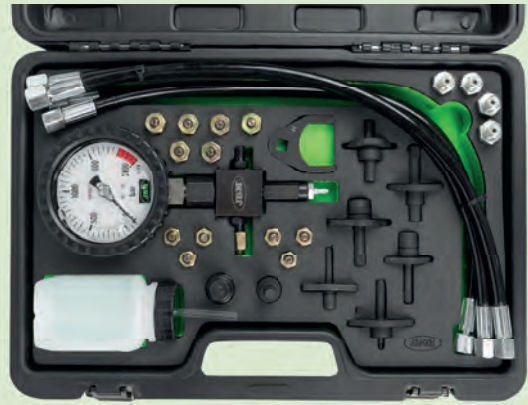

N

54312

191,50€



TESTER COMPRESIE MOTOARE DIESEL



DIAMETRU INTERIOR
10, 12, 14, 18mm
DIAMETRU INTERIOR
M20, M22, M24

ALFA, BMW, FIAT, FORD, LDV, PSA, RENAULT, SUZUKI, SAAB, CHRYSLER, DAEWOO, HYUNDAI, MERCEDES, MITSUBISHI, NISSAN, LANDROVER, MAZDA, IZUSU, OPEL.



52599

230,00€

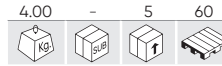

COMPRESMETRU DIESEL SI BENZINA

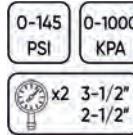

52489

58,00€

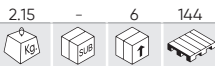

COMPRESMETRU DIESEL

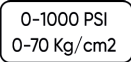

M18x1.5mm
M24x1.5mm
M24x2.0mm
M10x1.0x68mm
M10x1.25x45mm
M10x1.25x54mm
M10x1.25x68mm

FORD, BMW, MERCEDES BENZ, VW, CITROËN, MITSUBISHI, TOYOTA, PEUGEOT, RENAULT, VOLVO, MAZDA.

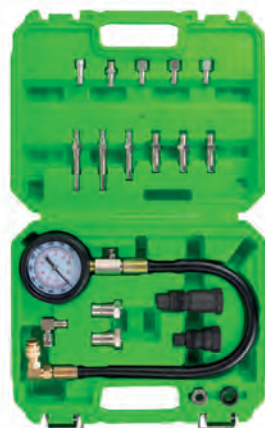

52685

88,00€

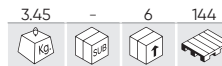

TESTER COMPRESIE MOTOR DIESEL / PT. CAMIOANE



M18
M24



53997

48,00€

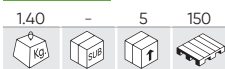

COMPRESMETRU PENTRU CIRCUITE DE BENZINĂ

0-10 BAR 0-140 BAR

LUNGIME	25,5cm (1), 29,5cm (2), 110cm (3)
DIAMETRU EXTERIOR	1,2cm (1), 1,2cm (2)
DIAMETRU INTERIOR	0,6cm (1), 0,6cm (2)



54016

76,00€



POMPĂ DE PRESIUNE VACUUM ÎN DOUĂ DIRECȚII

PRESIUNE MAXIMĂ

40 PSI (3 BAR)

PRESIUNE MINIMĂ

-20 PSI (-0,75 BAR)



52488

28,00€

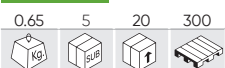

COMPRESMETRU BENZINĂ

0-300 BAR
0-21 Kg/cm2



53489

68,00€



MANOMETRU DE PRESIUNE PENTRU TURBINE DE SUPRAALIMENTARE

-1~3 BAR 2m



52076

111,00€



SET REPARAT FILETE BUJII

- 1 Tijă de folosire - 2un.
- 2 Mâner pentru piesa 8 - 1un.
- 3 Filet M8 x 1,0 - 5un.
- 4 Filet M10 x 1,0 - 5un.
- 5 Filet M10 x 1,25 - 5un.
- 6 Filet M12 x 1,25 - 5un.
- 7 Capete insertie - 3un.
- 8 Adaptor filetat inserat - 1 un.
- A Tarod M14 x 1,25 (pour M12 x 1,25 fil) - 1un.
- B Tarod M12 x 1,25 - 1un.
- C Tarod M12 x 1,0 (filetage M10 x 1,25) - 1un.
- D Tarod M10 x 1,25 - 1un.
- E Tarod M10 x 1,0 (pentru filet M8 x 1,0) - 1un.
- F Tarod M8 x 1,0 - 1un.



REF.	Icon	€
11893	M8x1.0 0.01 5	7,00€
11894	M10x1.0 0.01 5	7,00€
11895	M10x1.25 0.02 5	8,65€
11896	M12x1.25 0.02 5	8,80€

SCULE SPECIALE

52813

79,00€

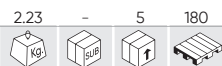

SET FREZE CURATAT INJECTOARE 17 PCS

17 PCS



	x8	14x14, 15x19, 15.5x15.5, 17x17x, 17x17.5, 17x19, 17x19.5, 17x20mm
	x4	15.5x15.5, 17x17, 17.5x20.5, 17x21mm
	x1	19x21.5mm

	x1	19x225mm
	x1	19x170mm
	x1	19mm
	x1	2.5mm

52273

44,00€



SET FREZE CURĂȚAT INJECTOARE

8 PCS

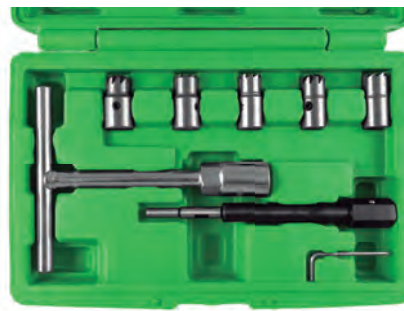

	x3	15x19mm 17x17mm BMW, PSA, Renault, Ford 17x19mm Mercedes CRD
	x2	17x17mm Mercedes 17x21mm Fiat/Iveco

	x1	12mm
	x1	19mm
	x1	

53650

47,00€

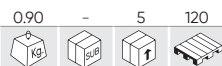

SET PENTRU CURĂȚAREA A ȘEI DUZELOR MOTORULUI

19 PCS



REF.	DESCRIERE					€
14348	SET DIN 3 PERII DE CURĂȚARE DIN ALAMĂ (REF. 53650)	0.05	-	50	-	12,50€
14349	SET DIN 2 PERII DE CURĂȚARE DIN SILICON (REF. 53650)	0.07	-	100	-	20,50€

53330

38,00€



SET PENTRU POMPA INJECTOARE

5 PCS 1/2" 1/4" Cr-V



52801

26,00€



POMPA AMORSARE SISTEM DIESEL



17mm

52821

28,80€



CHEIE DUBLA CU CAP DESCHIS PENTRU INJECTOARE



17mm

SET DE MATRIȚE

Potrivit pentru aplicarea marcajului cu cifre sau cu litere pe orice suprafață metalică prin metoda de indentare sau impact. Zona de lucru rotunjită previne formarea despicăturilor sau crăpăturilor pe suprafața tratată.

<p>52422 24,70€</p> <p>0.82 3 6 540</p>  <p>A-Z & 0-9</p> <p>36 PCS 3/16"</p> <p>5mm</p> 	<p>53119 52,00€</p> <p>1.94 3 6 504</p>  <p>A-Z & 0-9</p> <p>36 PCS 5/16"</p> <p>8mm</p> 	<p>52882 14,00€</p> <p>0.30 10 60 1500</p>  <p>9 PCS 1/4"</p> <p>6mm 0-8</p> 
--	--	--

51120 41,00€

2.10 - 5 120



SET DE CHEI PENTRU ARCURI DE SUPAPE

- Valabil pentru mașini și motociclete.
- Cele 5 adaptoare permit fixarea corectă și ușoară pentru comprimarea arcului de la supapă.

INCLUDE
Compresor de Arcuri.
Adaptor de: 30, 25, 23, 19, 16mm.



52734 51,00€

2.61 - 5 175



PRESĂ PENTRU ARCURI DE SUPAPE 45-145MM



Ø 30mm Ø 25mm
45-145mm

52693 24,50€

0.65 5 20 450



PRESĂ PENTRU ARCURI DE SUPAPE



53251 88,00€

2.80 - 4 60



SET DE UNELTE PENTRU CERCURI DE PISTON

H:3" Ø 53-125mm
H:4" Ø 60-175mm
H:6" Ø 60-175mm



52697 16,00€

0.50 5 40 720



COMPRESOR SEGMENTI (CERC) DE PISTON 6"

6" Ø 60-175mm



150mm

52696 12,00€

0.28 5 40 1200



COMPRESOR SEGMENTI (CERC) DE PISTON 3"

3" Ø 53-175mm



77mm

CLEȘTE PENTRU INELE DE PISTON

REF.	DESCRIERE					€
54273	40-100mm	0.30	6	30	-	10,10€
54274	80-120mm	0.35	6	30	-	11,00€
54275	100-160mm	0.40	6	30	-	13,20€



52591 12,00€

0.10	12	72	1728

APARAT PENTRU ȘLEFUIT CILINDRII DE FRÂNĂ - 2 BRAȚE
1 - 1/8"

1-18"
28,60mm
MAX: Ø 55mm
MIN: Ø 19mm



52592 22,00€

0.20	-	20	480

APARAT PENTRU ȘLEFUIT CILINDRII DE FRÂNĂ - 3 BRAȚE
2"

2"
50,80mm
MAX: Ø 85mm
MIN: Ø 35mm



52593 34,00€

0.47	6	36	648

APARAT PENTRU ȘLEFUIT CILINDRII DE FRÂNĂ - 3 BRAȚE
4"

4"
101,60mm
MAX: Ø 170mm
MIN: Ø 55mm



REF.	DESCRIERE					€
11878	SET DE 2 DISCURI DE LUSTRIRE DE 1-1/8" PENTRU REF. 52591	0.10	25	100	-	4,10€
11879	SET DE 3 DISCURI DE LUSTRIRE DE 2" PENTRU REF. 52592	0.04	25	100	-	5,10€
11880	SET DE 3 DISCURI DE LUSTRIRE DE 4" PENTRU REF. 52593	0.09	25	100	-	10,50€

53662 89,00€

1.78	5	10	80

DETECTORUL DE SCURGERE PENTRU GARNITURA CAPULUI CILINDRILOR

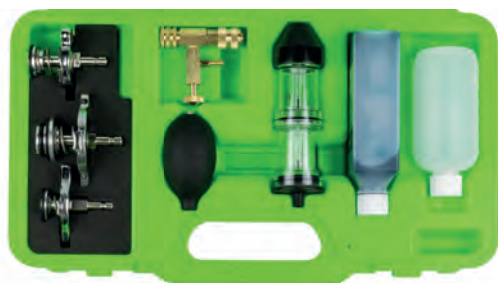

CONȚINE

Flacon rotund de 200 ml.
Flacon patrat de 250 ml.

ADAPTORI

Mic: Suzuki, Toyota, Mitsubishi.
Mediu: Suzuki, Toyota, Mitsubishi, Subaru, Peugeot, Nissan, Lexus, Mazda.
Mare: Ford, GM, Benz, JEEP.

REF.	DESCRIERE					€
14563	LICHID DETECTORUL DE SCURGERE	0.23	5	50	-	18,00€

54347 46,00€

2.00	-	5	100

TESTER DE ETANȘEITATE PENTRU CILINDRI

7 BAR 100 PSI

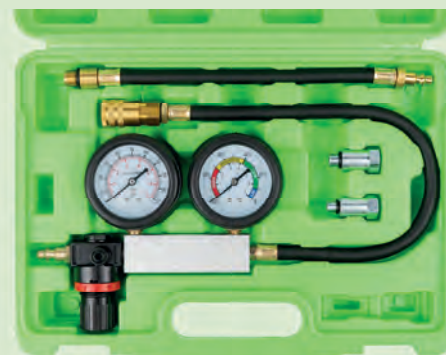

Se utilizează pentru a verifica scurgerile unui cilindru.

M12x1.25
M14x1.2

52832

75,00€

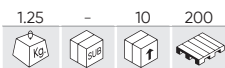

TRUSĂ CHEI CURBATE PENTRU TENSOR
CURELE AUXILIARE / 12 FEȚE CAP
INTERSCHIMBABIL



CAP INTERSCHIMBABIL

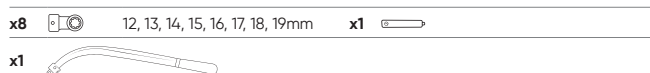

52690

54,00€

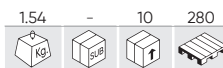

CHEIE PRINDERE FULIE AX CU CAME

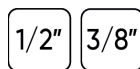

53669

45,00€

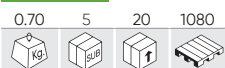

SET DE TUBURI SPECIALIZATE PENTRU
AUTOMOBILE DIN 10 PIESE



- 10S pentru roata dințată intermediară Toyota
- 6S pentru ambreiaje, chiulasa și axul de echilibrare Nissan și Renault
- 8S pentru ambreiaje, chiulasa și axul de echilibrare Nissan și Renault
- 12S pentru ambreiaje, chiulasa și axul de echilibrare Nissan și Renault
- 8TS pentru axul de echilibrare Nissan
- 14mm pentru etrierele de frână Opel Astra G, Opel Zafira și Smart
- 10mm pentru sistemul de frânare și pompa de combustibil Nissan
- 12,5mm pentru sistemul de frânare și pompa de combustibil Nissan
- 19mm pentru etrierele de frână Peugeot, Renault și Citroen
- 20mm pentru brațul inferior suspensie independent Honda Civic

53053

12,00€



CÂRLIGE PENTRU EXTRAGEREA
GARNITURILOR

1x15,5cm/1x16,5cm/1x12cm



53637

85,00€

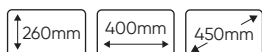

ORGANIZER PENTRU COMPONENTELE
MOTOARELOR SPECIAL PENTRU PIESELE
CHIULASEI

- Special pentru piesele chiulasei.
- Păstrează toate componentele curate și ordonate, deoarece acestea sunt scoase de la chiulasa.
- Economisiți timp. Îți simplifică treaba.



52850

7,80€



SET DE 2 DISPOZITIVE PENTRU ȘLEFUIREA
SUPAPELOR

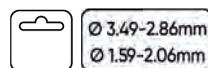

SCULE SPECIALE

51989

49,00€

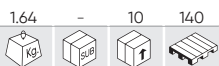

TRUSĂ 38 PERII DE SÂRMĂ ROTUNDE METALICE/PLASTICE

38
PCS

Ø 8, 9, 10, 11, 12, 13, 14, 15, 16, 17, 18, 19mm



- 1 Mâner de 1/4".
- 1 Prelungitor.
- 36 perii.

52760

4,10€

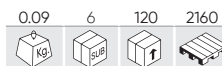

PERIE DE SÂRMĂ



52515

9,10€

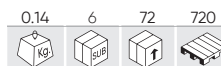

SET DE 3 PERII DE SÂRMĂ

- 1 x Alamă.
- 1 x Nailon.
- 1 x Oțel.



52819

22,00€

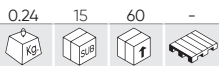

TUBULAR 1/2" PENTRU PRECAMER COMPRESIE MOTOARE DIESEL (MERCEDES)

58
DINȚI



53129

84,00€

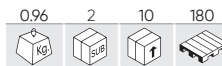

INSTALATOR REGLABIL PENTRU GARNITURI DE ULEI 18-90MM



53875

134,00€

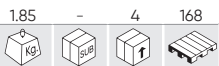

DISPOZITIV PENTRU DEMONTAREA/MONTAREA FLANȘELOR ETANȘATE ALE ARBORELUI COTIT (GRUPA VAG)

MĂRCI	VW: GOLF, TOURAN AUDI: A3, A4
INSTRUMENTE OEM	T10134
CODURILE DE MOTOR	1.4I TURBO 1.4 ȘI 1.6 INJECTIE DIRECTA DE COMBUSTIBIL 1.9/2.0 SDI 2.0 SISTEME DE MOTOARE DIESEL COMMON RAIL



52190

8,00€

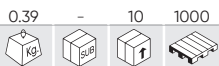

CHEIE AMBREIAJ SPECIALĂ FIAT

220x110mm



52495

14,50€

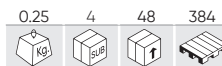

DISPOZITIV CENTRAT AMBREIAJ

- Pentru majoritatea modelelor de autovehicule de pe piață.
- Include 3 adaptoare de diferite diametre.



53001

242,00€

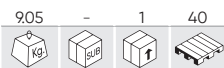

SET PENTRU CENTRAT AMBREIAJE S.A.C.

VW, AUDI, BMV, MERCEDES, VOLVO, RENAULT, OPEL

- Se evită deformări de ambreiaj utilizând Pretensorul.
 - Ajută la comprimarea plăcilor de presiune, la demontarea și montarea ambreiajului, la re poziționarea arcului de reglaj și la centrarea supapei cu ghidajul rulmentului.
 - Adecvat pentru aproape toate ambreiajele SAC (ambreiaj cu reglaj automat).

AVANTAJE
 Întinderea plăcii de presiune a ambreiajului în montare și demontare.
 Repunerea cheii de ajustare cu instrumentul de resetare.
 Centrarea supapei în raport cu ghidajul rulmentului.

CONȚINE
 Pretensor de ambreiaj.
 Centrator cu 3 găuri.
 Dispozitiv pentru reset.
 Set de dispozitive pentru centrare.
 Centrator cu 4 găuri.



53410

92,00€

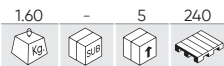

CENTRATOR AMBREIAJE SAC

DIAMETRU DE CENTRARE

x3 15-19, 20-26,6, 23-36mm

ACCESORIILE DIAMETRU

x8 12, 14, 15, 16, 17, 18, 19, 20mm

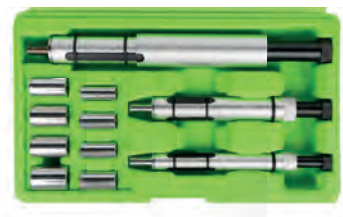

53057

149,00€

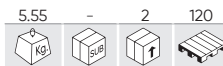

SET PENTRU REPARAREA AMBREIAJULUI DUBLU PENTRU TRANSMISIA DSG DE VAG

- Pentru schimbări servicii DSG Golf (2004), Golf Plus (2005), AUDI A3 (2004), cu 7 trepte de cod transmisii 00, și Touareg (2003-), cu 6 trepte cod de transmisie 08D).
 - OEM referințe utile: T10323, T10373, T10374.



50731

68,00€

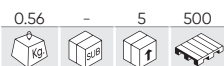

REFRACTOMETRU PENTRU ALCOOL



52963

49,00€



REFRACTOMETRU PENTRU UNIVERSAL

- Etilen glicol:
 -50°C ~ -0°C.
 - Propilen glicol:
 -50°C ~ -0°C.
 - Lichid de curățare:
 -40°C ~ -0°C.
 - UREA AUS32:
 - 30% ~ 35%.
 - Lichid baterie:
 - 1.100 - 1.400 sg/l.



UREA AUS32

53477

36,10€



SET DE 8 CLEȘTI CU FIXER PENTRU FURNIRE

8 PCS
 NYLON

8mm
 10mm
 13mm



53426

39,80€



VERIFICATOR DE PRESIUNE ȘI VID

PRESIÓN PRESSURE 0-0,7Kg/cm² (0-10 PSIG)
 VACÍO VACUUM 0-28 inHg (0-70 cmHg)



SCULE SPECIALE

52066

12,00€

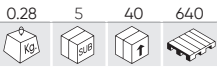

SET CLEȘTI DIN PLASTIC PENTRU FURTUNE AUTO

3 PCS

NYLON



0-20mm
0-35mm
0-70mm

53395

16,00€

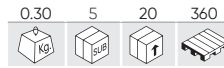

SET CLEȘTI DIN PLASTIC PENTRU FURTUNE AUTO

3 PCS

NYLON



Ø13mm
Ø20mm
Ø35mm

52687

168,00€

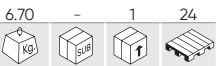

SET DE TESTARE A SCURGERILOR DE PRESIUNE LA SISTEMUL DE RĂCIRE

24 PCS 0-2.5 BAR

- 1 Pompă de presiune cu supapă de descărcare
- 2A Conector 1: atașat pentru conecțiile No.3(R123) y No.4 (R124)
- 2B Conector 2: atașat pentru conecțiile No. 3(R123) y No. 5(R125)
- 3 Mercedes (W123, W126, W124, W201), GM(Buick), Jeep
- 4 Peugeot, Subaru, Chrysler, Acura, GM (Nova, Spectrum, Sprint), Mitsubishi, Nissan, Mazda, Toyota, Infiniti, GEO, Suzuki, Isuzu, Mercedes
- 5 Honda, Toyota, Suzuki, Mitsubishi, Chrysler, Acura
- 6 Mercedes Benz (ML, W163, W164), GM (Achiva, Skylark, Grand Am 1992~2002)
- 7 Volvo, Saab, Sterling, Citroën, Renault, Fiat, Alfa, Jeep
- 8 VW(Vento, T4, Passat-1996, Golf, Beetle, Sharan)
- 9 Audi(A4, A5, A6), BMW 345, VW (Passat - 1997-2002), Porsche(Cayenne)
- 10 BMW (E46, E36, E34, E39, E38, E32, E90)
- 11 Audi, VW
- 12 Internațional, Land Rover, Jaguar
- 13 Mercedes (C, E, S, W140, W220, W124, W210, W211, W215, W216, W221, R230)
- 14 Ford Focus
- 15 Mazda(M3)
- 16 Mercedes clase A (W168)
- 17 BMW E60, E63, E64, E65
- 18 VW SHARAN 1.8T 2.8
- 19 TOYOTA-RAV4, PREVIA Adaptor universal de gumă pentru purjare și umplere ale radiatoarelor



- 20 SAAB
- 21 LAND ROVER
- 22 Kia
- 23 Hunday

54139

147,00€



SET UNIVERSAL DE TESTARE A SCURGERILOR DE PRESIUNE LA SISTEMUL DE RĂCIRE (5 BUC)

5 PCS 0-2.5 BAR 0-35 PSI

x1 17-24mm
x1 28-31.5mm
x1 37-39.5mm
x1 47-48.5mm



53453

7,00€

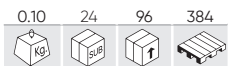

TESTER ANTIGEL

-43°C
131°C



54368



2.329,00€

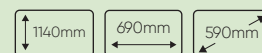

N

MAȘINĂ DE CURĂȚARE A SISTEMULUI DE RĂCIRE

Acest aparat vă permite să curățați și să reumpleți întregul sistem de răcire al vehiculului într-un mod rapid și eficient. Prin generarea presiunii, acesta pompează lichidul de răcire în tot sistemul și îl curăță de diverse depuneri. Este compatibil cu diferite tipuri de lichide de răcire.

Aparatul este conectat la bateria vehiculului la 12 V și are o interfață intuitivă care, împreună cu ecranul tactil, două manometre și două ecrane pentru observarea stării fluidului, îl face foarte ușor de utilizat. Pentru o montare ușoară pe marea majoritate a vehiculelor, sunt disponibili conectori rapizi, țevi și adaptori. Aparatul conține două rezervoare de 20 de litri, unul pentru lichidul de răcire nou și celălalt pentru lichidul de răcire uzat, ambele fiind golite prin aparatul înșiși. În cazul circuitelor care prezintă rugină sau ulei, se recomandă utilizarea de aditivi pentru o mai mare putere de curățare.



PIESE DISPONIBILE



TUTORIAL VIDEO



53539



66,00€

SET DE DETECTARE PENTRU SCURGERE AER CONDIȚIONAT

CONȚINE

- 1 x lampa UV 100Lm.
- 1 x ochelari de vedere UV.
- 1 x seringă pentru introducerea lichidului.
- 1 x adaptor rapid.
- 1 x adaptor cu prelungitor.
- 1 x încărcător.
- 1 x acumulator reîncărcabil.



REF. DESCRIERE

	kg	box	unit	€
15052 BATERIE REÎNCĂRCABILĂ PENTRU NR.53539	0.05	5	10	3,00€
15053 DISPOZITIV DE ÎNCĂRCARE PENTRU NR. 53539	0.08	-	10	10,50€
15054 LAMPĂ PENTRU NR. 53539	0.12	-	50	34,00€
14187 OCHELARI-UV (ART 53539)	0.05	10	120	6,00€
12200 SERINGĂ PENTRU DETECTAREA SCURGERII LICHIDULUI AA/CC REF. 52844	1.10	-	50	14,50€

54291

116.00	-	1	1

5.054,00€

N

MAȘINĂ DE ÎNCĂRCARE A AERULUI CONDIȚIONAT

200V ±10%	R134A R1234YF	3/8 HP	>2 Kg/min	100 L/min
450g/min	800g/min	12,12 cm ³	LCD 360x128mm	50-60 Hz
99%	<85%	180W	-10° 50°	

Această mașină a fost proiectată pentru curățarea, recuperarea agentului frigorific, vidarea, injectarea de ulei și reîncărcarea cu agent frigorific a sistemului de aer condiționat al vehiculului. Este complet automată. Odată ce parametrii pentru fiecare funcție au fost setați, mașina va efectua toate procesele fără ca operatorul să fie atent în permanență.

CARACTERISTICI PRINCIPALE:

- COMPLET AUTOMAT
- UȘOR DE UTILIZAT
- CU FEREASTRĂ DE INSPECȚIE MARE ȘI ILUMINARE DIN SPATE CU LED-URI
- MANOMETRELE FACILITEAZĂ OBSERVAREA VALORILOR PRESIUNII
- RATA RIDICATĂ DE RECUPERARE A GAZULUI ȘI ULEIULUI
- CU AFIȘAJ LCD MARE
- CU BAZĂ DE DATE ȘI IMPRINTĂ
- SOFTWARE-UL ȘI BAZA DE DATE POT FI ACTUALIZATE



PIESE DISPONIBILE



TUTORIAL VIDEO

16309

1.40	-	1	-

149,00€

N

SET DE 2 TUBURI DE PRESIUNE ÎNALTĂ ȘI JOASĂ DE 5 METRI DE LUNGIME (REF.54291)



ADAPTOR PENTRU GAZ 1234YF

R1234YF Adaptor rapid detașabil pentru agentul frigorific din sistemul de climatizare. Construcția rapid detașabilă este echipat cu un autostop intern. Bucșa care protejează împotriva leziunilor corporale și a scurgeri de agent frigorific în cazul separării mufelor sub presiune.

Destinația: condiționarea și răcire aerului.



53499

29,00€

0.20	15	60	2400

ADAPTOR PENTRU GAZ 1234YF (ÎNALT)



- Roșu (presiune înaltă)
- Material: alamă și metal
- Greutate: 194g

53500

29,00€

0.20	15	60	2400

ADAPTOR PENTRU GAZ 1234YF (JOS)



- Albastru (presiune joasă)
- Material: alamă și metal
- Greutate: 175g

53456

98,00€

2.90	-	5	75

SET DE COMPROBARE, UMLERE ȘI VID PENTRU SISTEMUL AACC (BAR)

BAR	LOW: 0-24BAR HIGH: 0-34BAR
PSI	LOW: 0-350PSI HIGH: 0-500PSI

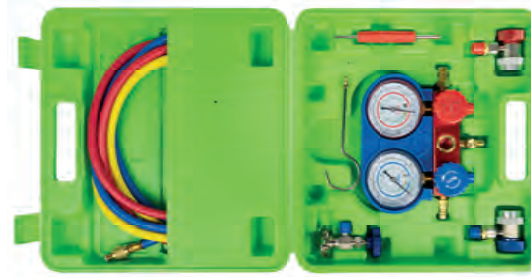

				€
--	--	--	--	---

REF.	DESCRIERE					€
14300	MUFĂ CU CUPLARE RAPIDĂ DE ÎNALTĂ PRESIUNE (POZ. 53456)	0.15	-	100	-	19,00€
14301	MUFĂ CU CUPLARE RAPIDĂ DE JOASĂ PRESIUNE (POZ. 53456)	0.15	-	100	-	19,00€

16316

18,50€



ULEI UNIVERSAL PAG
PENTRU SISTEME DE AER
CONDITIONAT 250ML



N

12977

36,50€



LICHID PENTRU
DETECTAREA SCURGERII
SISTEMULUI AACC 250
ML



- O aplicare de 7.5 ml pentru
fiecare 1.4l de refrigerant.

50807

38,00€

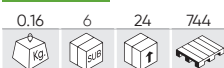

SET ORINGURI / GARNITURI PENTRU AACC



Ø	PCS	Ø	PCS
5.29x1.78	20	8.80x1.90	20
6.07x1.78	20	10.82x1.78	15
6.8x1.9	20	10.77x2.62	15
7.65x1.78	20	11.0x2.0	15
7.80x1.90	20	12.0x2.0	15
8.0x2.0	20	13.9x1.80	10
Ø	PCS		
13.95x2.62	10		
14.0x2.0	10		
15.0x2.0	10		
17.0x2.0	10		
17.17x1.78	10		
17.04x3.53	10		

53599

30,30€



SET DE VULVE CU VENTIL PENTRU
CONDITIONAREA AERULUI

PIESE DISPONIBILE

REF	mm	PCS	€
14594	5x19mm R12	50	2,00€
14595	5x19mm	30	1,50€
14596	5x19mm R12	30	2,00€
14597	6x19mm	3	7,60€
14598	6x26mm	1	17,80€
14599	7x20mm R134A	10	4,50€
14600	6x22mm	5	9,50€
14601	8x22mm	1	11,00€
14602	9x22mm	4	11,00€



53459

66,00€



SET DE DECONECTARE AER CONDITIONAT

DIAMETRU CLEME

x6 8mm (5/16"), 9.5mm (3/8"), 13mm (1/2"), 16mm (5/8"), 19mm (3/4"), 22mm (7/8")

DIAMETRU BLOCATOR

x4 9.5 mm (3/8"), 16mm (5/8"), 13mm (1/2"), 19mm (3/4")



54069

29,50€

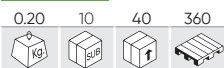

SET DE UNELTE PENTRU CURĂȚAREA
BUTUCULUI, 14 BUC



x1 Duză de 8 mm cu adaptor de 1/2 "

x1 Disc polizor cu ax rotund și cap hexagonal de 8 mm

x2 Garnituri interschimbabile cu bază autoadezivă

x5 Discuri abrazive grosiere, diametru exterior 40 mm

x5 Discuri abrazive cu granulație fină, diametru exterior 40 mm, diametru interior 14 mm

51364

26,00€



EXTRACTOR PT. HOMOCINETICĂ DE
PLANETARE

Ø 31mm

140-240mm



53638

243,00€

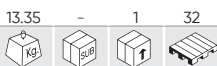

EXTRACTOR HIDRAULIC A ROȚILOR DINȚATE

- Acest kit include 3 extractoare / ciocane special concepute pentru a simplifica îndepărtarea butucului roții și eliberarea arborelui butucului fără a-l deteriora:
- Ax hidraulic
- Șurub
- Ciocan de impact
- Pentru extracție manuală sau hidraulică.
- Cu o capacitate maximă de 10 tone.
- Ciocan de 4 kg.
- Lungimea barei: 57cm.
- Pentru 3, 4, 5 și 6 găuri.



REF. DESCRIERE



15253 FUSION HIDRAULIC PENTRU NR. 53384/53638

1.35 1 10 62,00€

54384

32,50€



CURĂȚĂTOR DE BUTUCI DE ROATĂ

Acesta vă ajută să curățați rugină și corozivitatea care se găsesc pe butucul roții. Este prevăzut cu o bandă Velcro pentru a instala cu ușurință discul abraziv.

Diametrul exterior: 150 mm
Diametrul interior: 90 mm
Viteza maximă: 500 RPM



N

REF. DESCRIERE



16448 DISC DE CURĂȚARE A BUTUCULUI ROȚII (REF. 54384) 0.11 16 64 16,50€

52829

19,00€



DISPOZITIV FIXARE BURDUF PLANETARĂ

ÎN AFARA

Ø 10cm

INTERIOR

Ø 9,5cm

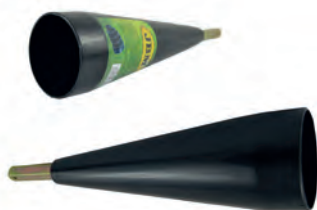

52541

45,00€



VERIFICATOR MECANIC DE PIVOȚI (ROTULE)



- Pentru a depista jocul in rulmenți, bucle, rulmenți de roată, articulații axiale, stabilizatori, etc.



51121

27,30€



PRESĂ PENTRU ARCURI DE SUSPENSII

- Gheare și Prezoane forjate din aliaj.
- Construite din aliaj de fier și carbon (tratați termic).
- Indicată pentru utilizarea în spații cât mai reduse, rezistență superioară și siguranță în timpul utilizării.
- Deschidere maximă 250mm.

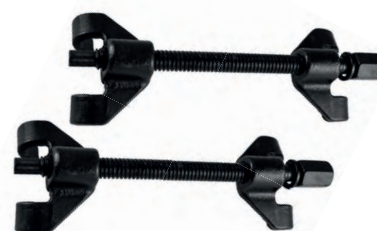

270mm

50827

387,00€

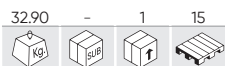

PRESĂ HIDRAULICĂ PT. ARCURI SAU AMORTIZOARE DE SUSPENSIE



- Capacitate: 1T (2200 lbs)
- Diametru arc comprimat: 200mm
- Lungime compresie: 200-500mm

53742

1.325,00€

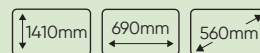

N

PRESĂ HIDRAULICĂ PT. ARCURI SAU AMORTIZOARE DE SUSPENSIE 1T



- Capacitate de ridicare: 1000 kg
- Max. lungime de lucru: 450 mm
- Cursa cilindrului: 420 mm
- Diametrul arcului: Ø102-165 mm
- Direcția de înfășurare: în sensul acelor de ceasornic
- Tip de funcționare: pneumatic
- Presiunea aerului: 6,5-9 bar (94,27-130,53 psi / 0.65-0.9 MPa)
- Mod de operare: pedală de picior

53394

598,00€



SET DE COMPRIMAT ARCURI

- Bratul telescopice și suprafețele antiderapante care permit o aderență solidă a arcurilor.
- Claw-uri echipate cu o protecție plastică interschimbabilă pentru a evita deteriorarea vopselei de andocare.
- Împiedică îndoirea arcurilor în timpul comprimării.
- Universal, acoperă 90% din parcul auto.
- Poate fi folosit atât pentru arcuri drepte cât și conice.

INCLUDE

Dispozitiv / piston.
Trei perechi de clești cu capace din plastic.



POTRIVIT PENTRU UTILIZAREA CU SCULE PNEUMATICE

52227

247,00€



SET COMPRIMAT ARCURI MCPHERSON

- Specificatii:
Capacitate maximă : 2500N.
Un corp principal.
Un suport prelungitor.
3 perechi de mandibule.
- Perechea 1: Jug de prindere arc: 80-115mm. Greutate: 1,45 kg.
- Perechea 2: Jug de prindere arc: 110-195mm. Greutate: 2,2 kg.
- Perechea 3: Jug de prindere arc: 140-195mm. Greutate: 2,3 kg.

BMW, TOYOTA, FORD, MITSUBISHI, VW, AUDI, SAAB, NISSAN,
HONDA ACCORD, SUBARU, VOLVO, OPEL, PORSCHE.



NU UTILIZAȚI CU AER PISTOL

SCULE SPECIALE

52270

109,00€



PRESĂ BUCȘE PENTRU VAG



Ax, Prelungitor de ax, piuliță de împingere M10x1.25

Cap adaptor din oțel carbo

Separator

Piesă de presiune

Mandrină de centrare din aliaj de aluminiu

52432

35,00€



PRESĂ PT. EXTRAS ȘI MONTAT BUCȘE PENTRU VAG



- Util pentru Volkswagen Polo model 2002.

- Facilitează schimbarea bucșelor din cauciuc de la brațele de suspensie din față.

EXTRACTOR

REF.	DESCRIERE	MAX	MIN					€
51368	EXTRACTOR AXIAL DE ARTICULAȚII DE DIRECȚIE	42mm	33mm	0.41	5	50	2700	19,00€
51369	DISPOZITIV DEMONTAT / MONTAT AX PLANETAR	42mm	35mm	0.55	6	36	756	28,00€
51414	EXTRACTOR PENTRU PREZOANE	20mm	15mm	0.59	5	40	1440	14,00€



51368



51369



51414

52834

195,00€

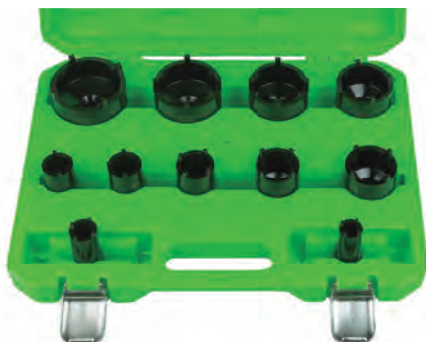

TRUSĂ DE TUBULARE CU CRENELURI EXTERIOR

11 PCS 1/2" Cr-Mo

x11 22x3.3mm, 26x3.8mm, 30x4.3mm, 33x4.0mm, 37x4.8mm, 44x5.3mm, 50x5.8mm, 56x5.8mm, 63x6.3mm, 69x6.8mm, 75x6.8mm

52835

272,00€



SET DE TUBULARE CU CRENELURI ÎNLĂȚUITE

10 PCS 1/2"

x10 26x5.3mm, 1.2x6.25mm, 34.2x6.3mm, 38.2x6.65mm, 42.2x7.3mm, 50.1x8.25mm, 58.2x9.8mm, 74.6x11.9mm, 82.2x13.25mm, 87.7x13mm

DISPOZITIV PENTRU DEMONTAT BARA DE DIRECȚIE

REF.	DESCRIERE					€
52640	Ø 28-35mm	1.80	-	4	256	52,00€
52641	Ø 35-45mm	2.20	-	4	140	55,00€



EXTRACTOR DE BRAȚE DE DIRECȚIE

REF.	DESCRIERE					€
52874	Ø 9-20mm	1.20	4	20	1500	82,00€
52875	Ø 14-23mm	1.25	5	20	1500	79,00€



53635

6.50	-	2	80

85,00€

440-630mm

EXTRACTORUL RULMENȚILOR DE ANVELOPE CU CURSORUL CU IMPACT

- Masă glisantă: 4 kg.
- Gama de diametru: 100-115mm.
- Pentru șuruburile M12.



51490

36,00€

1.88	-	5	360

SET EXTRACTOARE PENTRU PIVOȚI (ROTULE)



MÂNER DETAȘABIL

FURCI: 11/16, 15/16 ȘI 1-1/8

53384

165,00€

7.30	-	2	62

EXTRACTOR ARTICULAȚII SFERICE HIDRAULIC

- Deschiderea: 100mm.
- Lățimea: 35mm.



REF. DESCRIERE

15253	FUSION HIDRAULIC PENTRU NR. 53384/53638				€
		1.35	1	10	62,00€

53208

126,00€

0.95	5	20	-

SET PREZOANE ANTIFURT PENTRU BMW

22 PCS **BMW** 41-60



APLICATII

BMW Serie 1 F20/F21
BMW Serie 3 F30/F31
BMW Serie 4 F32/F34/F36

BMW Serie 5 F10/F11
BMW Serie 6 F12/F13
BMW Serie 7 F01/F02/F04

x20 41, 42, 43, 44, 45, 46, 47, 48, 49, 50, 51, 52, 53, 54, 55, 56, 57, 58, 59, 60

53207

118,00€

1.55	5	10	330

SET PREZOANE ANTIFURT PENTRU VW

23 PCS **VW**



x1	B51 / 6PT		
x1	B52 / 7PT		
x1	B53 / 8PT		
x1	B54 / 9PT		
x1	B55 / 10PT		
x1	B56 / 11PT		
x1	B57 / 12PT		
x1	B58 / 13PT		
x1	B59 / 14PT		
x1	B60 / 15PT		
x1	B61 / 16PT		
x1	B62 / 17PT	x1	ABC3 / 14PT
x1	ABC0 / 10PT	x1	ABC4 / 15PT
x1	ABC1 / 11PT	x1	ABC5 / 16PT
x1	ABC2 / 13PT	x1	ABC6 / 17PT
		x1	ABC7 / 19PT
		x1	ABC8 / 20PT
		x1	ABC9 / 21PT

SCULE SPECIALE

52802

54,00€

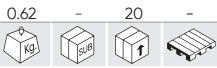

SET PREZOANE ANTIFURT PENTRU BMW

10 PCS BMW



x1	30/13 PT
x1	31/15 PT
x1	32/16 PT
x1	33/17 PT
x1	34/18 PT

x1	35/19 PT
x1	36/20 PT
x1	37/21 PT
x1	38/22 PT
x1	40/23 PT

53328

76,00€

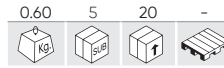

SET PREZOANE ANTIFURT PENTRU MERCEDES

12 PCS

MERCEDES



APLICATII

A, B, C, GLK, CLC, CLS, CLK, E, SL, SLK, M, C300, C250, C350, E320, 204, 211, 212, R

51998

38,00€

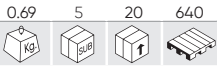

SET TUBULARE TWIST DE 3/8" PT EXTRAȚIE A PIULIȚELOR / ȘURUBURILOR DE BLOCARE

10 PCS 3/8" Cr-Mo

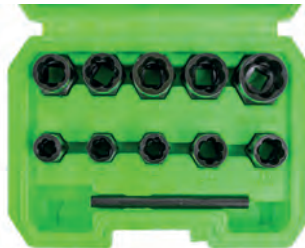

PIESE DISPONIBILE

REF.	mm	Kg	Sub	Len	€
16737	9mm	0.07	-	100	12,00€
11434	10mm	0.04	-	100	12,00€
11435	11mm	0.04	-	100	12,00€
11436	12mm	0.04	-	100	12,00€
11437	13mm	0.04	-	100	12,00€

REF.	mm	Kg	Sub	Len	€
11438	14mm	0.06	-	100	12,00€
11439	15mm	0.06	-	100	12,00€
11440	16mm	0.06	-	100	12,00€
11441	17mm	0.08	-	100	12,00€
11442	19mm	0.09	-	100	12,00€

52962

42,00€

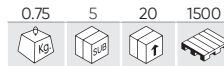

SET TUBULARE STRIATE 3/8" PT. ȘURBURI UZATE ȘI ANTIFURT 6-19MM

11 PCS 3/8" Cr-Mo



PIESE DISPONIBILE

REF.	mm	Kg	Sub	Len	€
11450	6mm	0.07	-	100	12,00€
12093	8mm	0.07	-	100	12,00€
11434	10mm	0.04	-	100	12,00€
11435	11mm	0.04	-	100	12,00€
11436	12mm	0.04	-	100	12,00€
11437	13mm	0.04	-	100	12,00€

REF.	mm	Kg	Sub	Len	€
11438	14mm	0.06	-	100	12,00€
11439	15mm	0.06	-	100	12,00€
11440	16mm	0.06	-	100	12,00€
11441	17mm	0.08	-	100	12,00€
11442	19mm	0.09	-	100	12,00€

52823

124,00€

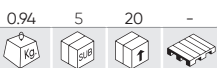

SET PREZOANE ANTIFURT PENTRU AUDI

22 PCS VAG

A, B, C, E, F, G, H, I, J, L, M, N, P, Q, R, S, T, V, W, X



x20 A, B, C, E, F, G, H, I, J, L, M, N, P, Q, R, S, T, V, W, X

54317

124,00€

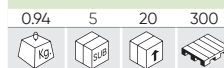

SET PREZOANE ANTIFURT PENTRU VAG

22 PCS VAG CR-MO

521,522,523,524,525,526,527,528,529,530,531,532,533,534,535,536,537,538,539,540



x20 521,522,523,524,525,526,527,528,529,530,531,532,533,534,535,536,537,538,539,540

52153

46,00€

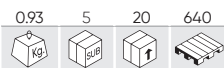

SET TUBULARE STRIATE 1/2" PT. ȘURUBURI UZATE ȘI ANTIFURT

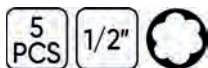

PIESE DISPONIBILE

REF.	mm				€	REF.	mm				€
11443	17mm	0.02	25	100	14,00€	11446	23mm	0.03	25	100	15,00€
11444	19mm	0.02	25	100	14,00€	11447	27mm	0.03	25	100	15,50€
11445	21mm	0.02	25	100	15,00€						



54253

166,00€



SET DE UNEȘTE PENTRU ÎNLĂTURAREA PREZOANELOR DE SIGURANȚĂ LA ROȚI

Kit ușor de utilizat, capabil să îndepărteze orice piuliță de blocare a roții. Include o husă care protejează roata de deteriorare; trei lame cu două fețe pentru a se modela direct în forma prizei; o șurubelniță cu impact; și un pumn. De asemenea, conține două dimensiuni de lame de tăiere cu impact pentru a se potrivi cu majoritatea piulițelor de blocare a roților prin tăiere pe marginea exterioară.

UNIVERSAL: Produce o gamă largă de dimensiuni, tipuri și profile, inclusiv cele cu gulere pivotante.

PIESE DISPONIBILE

REF.	DESCRIERE				€
16300	CUTTER A ȘI MANDRINĂ (REF. 54253)	0.15	-	100	7,60€
16301	CUTTER B ȘI MANDRINĂ (REF. 54253)	0.15	-	100	7,60€
16302	CUTTER C (REF. 54253)	0.05	-	100	7,60€



54299

227,00€

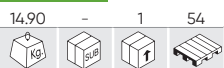

SET DE DEMONTARE ȘI INSTALARE A BUTUCULUI DE ROATĂ ȘI A RULMENȚILOR



	5,3cm		8,6x10,9cm
	5,8cm	B	8,2x10cm
	6,5cm		7,1x9,45cm
	6,6cm		8,9x17,6cm
A	Ø 2,3mm	C	9,9x17,6cm
	7,1cm		12x17,8cm
	7,3cm	D	Ø 2,3mm 9,5cm
	7,8cm	E	Ø 8,6mm 9,55cm
	8,3cm	F	2,4x28cm

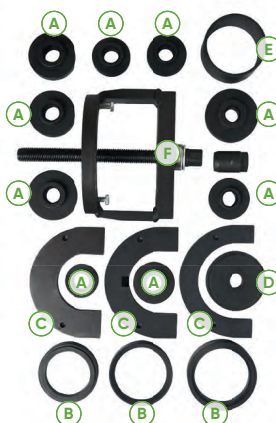

SCULE SPECIALE

51919

89,00€



MULTIPLICATOR DE FORȚĂ CU PRELUNGITOR

4
PCS



- Material: 40CR.
- Puterea maxima: 5800Nm.
- Puterea de lucru: 3800Nm.
- Raport de multiplicare 1:56.
- Include tubulare de 32mm și 33mm de 1".

52796

98,00€

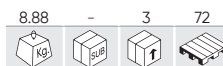

MULTIPLICATOR DE FORȚĂ ARTICULAT

5
PCS 6000
Nm



- Util pentru camioane cu capac și protector de roată.
- Avertizează deteriorarea jantei.
- Unic pe piață.
- Adaptare Ușoară la orice vehicul universal.
- Util pentru înșurubare și deșurubare.

INCLUDE

- 1x tubulară 1" 32mm.
- 1x tubulară 1" 33 mm.

51958

422,00€



MULTIPLICATOR DE FORȚĂ CLICHET DE 3/4" + REDUCTOR DE 1/2"

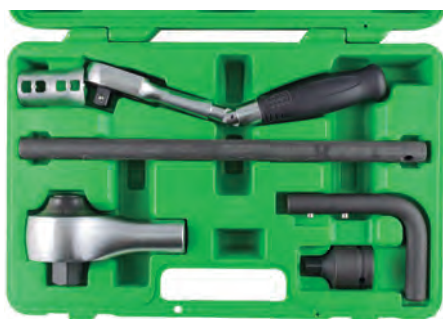

INCLUDE

- 1x Raport de multiplicare.
- 1x Clichet manual.
- 1x Adaptor 1/2" M x 3/4" F.
- 1x Kit eliberare.
- 1x Prelungitor 90°.
- 1x Prelungitor 350mm.

CARACTERISTICE

- Relație de transmisie 1: 4.
- Relație de multiplicare 1: 3.3.
- Forță max. de intrare: 303 Nm.
- Forță max. de ieșire: 1.000 Nm.

52012

68,00€



MULTIPLICATOR DE FORȚĂ JUNIOR

1/2"



PENTRU AUTOMOBILE

INCLUDE

- 1x Raport de multiplicare.
- 1x Prelungitor de 90°.
- Chei tubulare de 17, 19 și 21 mm.

- Raport de multiplicare: 1: 18.
- Forță max. ieșire: 360 Nm.
- Forță max. torsiune: 800 Nm.

EXTRACTOR

REF.	DESCRIERE	mm	Max.	Min.						€
52642	EXTRACTOR UNIVERSAL DE PIVOȚI	17-22mm	60mm	20mm	1.32	5	10	660		32,00€
52699	EXTRACTOR ARTICULAȚII SFERICE	18-22mm	50mm	15mm	0.80	5	30	1140		22,00€



52642



52699

51123 91,00€

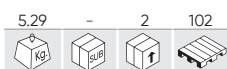

SET DE 5 EXTRACTOARE DE PIVOȚI (ROTULE)



- Set de 5 extractoare versatile.
- Permite extracția ușoară a celor mai tradiționale tipuri de articulații de pivoți.
- Tipul de separator de la junta preseii permite retragerea jantei preseii fără a strica încărcătoarele și alte piese de alt tip ce alte extractoare pot provoca.

53488 61,00€



INSTRUMENT PENTRU REGLAREA CAMBER



x1	75mm	Seat - Toledo VW - Jeta / Golf
x1	85mm	Seat - Cordoba VW - Polo / 95>
x1	115mm	Chrysler - Voyager
x1	22mm	

51902 84,00€



PÂRGHIE DE EXTRAȚIE A ARTICULAȚIEI SFERICE A BRAȚULUI

- Lungime: 118cm.
- Diam. Tub: 3,5cm.
- Distanță de ancoraj: 50, 45, 40, 35, 30cm.
- Ancoră de 15x13cm.



REF. DESCRIERE

10953 PIESĂ DE SCHIMB CÂRLIG PENTRU REF. 51902

0.83	-	25	-	12,50€
------	---	----	---	--------

51119 62,00€



SET 7 PIESE PT. SIST. DE INJECȚIE ȘI SONDĂ - LAMBDA

7 PCS 1/2" 3/8"

x1	1/2"	29x9 ~ 90mm
x1	1/2" ~ 7/8"	50mm
x1	1/2"	27x12 ~ 78mm
x1	3/8" ~ 7/8"	6 ~ 90mm
x1	3/8" ~ 7/8"	6 ~ 80mm
x1	3/8" ~ 7/8"	30mm
x1	3/8" ~ 1"	74mm
x1	1" ~ 1/16"	74mm



52637 48,00€



DISPOZITIV DE MĂRIRE ȚEAVĂ EȘAPAMENT

x1	1-1/8" - 1-3/4"
x1	1-1/2" - 2-1/2"
x1	2-1/8" - 3-1/2"



51491

154,00€



SET 14 PIESE PT. SISTEME DE INECȚIE ȘI SONDĂ - LAMBDA

14 PCS

17x78mm	12PT	Renault
19x78mm	12PT	VW, Polo, Audi, Seat, Mazda
20x78mm	6PT	Deschis, Japon
27x78mm	6PT	Deschis, Japon
21x90mm	12PT	Seat, Audi, VW, Skoda, Alfa Romeo, Mitsubishi
22x78mm	12PT	Seat, Audi, VW, Skoda, Opel
22x110mm	12PT	Mercedes, Citroën, Peugeot, Ford, Nissan, Mazda, Mitsubishi, Seat, Audi, VW...



51991

54,00€

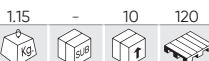

ALINEATOR DE DIRECȚIE

- Lungime totală deschis: 1950mm.
- Lungime totală închis: 1100mm.
- Dimensiunea șurubului: M6x15mm.
- Tub exterior de 20x20 din aluminiu.
- Tub inferior de 16x16 din fier zincat.



53118

231,00€



SET PENTRU DEMONTAREA AMORTIZOARELOR

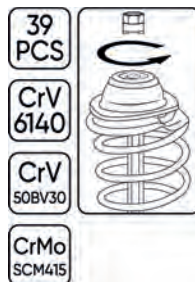

52822

32,00€



CHEIE ARTICULATĂ PENTRU SONDĂ LAMBDA 22MM



HEDER ARTICULAT

52849

8,50€



SET DE 2 CÂRLIGE PENTRU A EXTRAGE ÎN ȚEAVA DE EȘAPAMENT



52852

6,80€

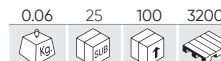

SET DE 2 CÂRLIGE PENTRU EXTRAGERE A CAUCIUCULUI DE PE ȚEAVA DE EȘAPAMENT



51347

9,90€

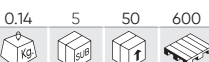

STETOSCOPI PENTRU MECANICĂ

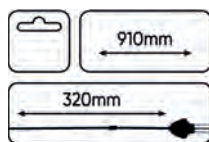

- Amplifică și localizează zgomote interne mecanice și de trecere a fluidelor.
- Localizează repede de unde vine zgomotul motorului.
- Se pot asculta și zgomotele produse de trecerea lichidelor, pierderi de gaz, presiune de aer sau vapor.
- Mâner de probă a loviturilor.



53249

192,00€

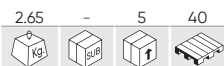

STETOSCOPIE ELECTRIC

Complet pentru detectarea defecțiunilor la galeri de admisie / evacuare, injectori, radiatoare etc. Permite monitorizarea simultană a mai multor puncte ale vehiculului, facilitând sarcina operatorului în găsirea și diagnosticarea defecțiunilor. Sonde cu coduri de culori care fac operațiunea ușoară pentru operator.

CARACTERISTICI

Lungimea cablului senzorului: 4,8 m
Lungimea sondei sonore: 14 cm
Baterii de 9V (incluse)
Numărul de senzori: 6
Potrivit pentru conector de 3,5 mm
Lungimea reglabilă a microfonului: 21cm

x1	Testere audio	x6	Mic Canale de Box Microfon
x1	Căști	x1	Fixarea velcro pentru senzori
x6	Clipuri pentru microfoane	x1	Grămezi pătrate



52293

98,00€

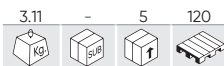

SET CHEI PENTRU ALTERNATOR 30 PIESE

A	x1	H38x3 Pins - 20mmL
B	x1	H17x4 Pins - 30mmL
C	x1	3/8" Dr. x H10
D	x1	1/2" Dr. x H10
E	x9	M10xH12 (64mmL), T50xH12 (64mmL), H10xFH10 (68mmL), H8xH10 (75mmL), M8xH10 (75mmL), M10xH10 (75mmL), H10xH10 (75mmL), T40xH10 (75mmL), T50xH19 (75mmL)
F	x3	1/2" Dr. T50 - 17mm x T33 - 100mmL, 1/2" Dr. M10 - 17mm x T33 - 100mmL, 3/8" Dr. M10 - 12mm x T31 - 85mmL,
G	x4	1/2" Dr. T50 - 140mmL, 1/2" Dr. M10 - 140mmL, 1/2" Dr. T50 - 200mmL, 1/2" Dr. M10 - 200mmL
H	x5	H17xH21 (30mmL), H15xH28 (30mmL), H19xH28 (30mmL), H21xH28 (30mmL), H22xH28 (30mmL)
I	x2	H22 (30mmL), H17 (35mmL)
J	x3	H22x22mm x T33 (300mmL), H15x15mm x T33 (30mmL), 15mm x T33 (30mmL)

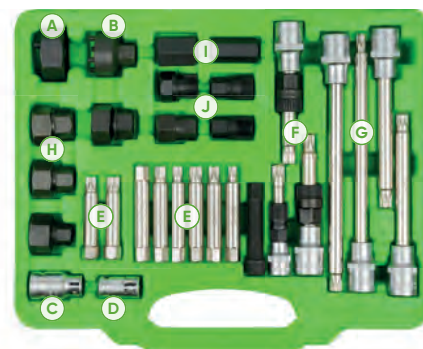

51259

58,00€



SET CHEI PENTRU ALTERNATOR 18 PIESE

PIESE DISPONIBILE

REF.	DESCRIERE				€
10485	TUBULARĂ XZN M10 PENTRU 51259	0.10	5	100	8,10€
10486	TUBULARĂ TORX T50 CU PRELUNGIRE PENTRU 51259	0.15	5	50	8,00€
10494	TUBULARĂ CU PRELUNGITOR 14 CM PENTRU 51259	0.16	-	-	6,50€
10495	TUBULARĂ H10 PENTRU 51259	0.06	-	-	3,00€
10496	TUBULARĂ H8 PENTRU 51259	0.06	5	50	3,00€
10497	TUBULARĂ M10 PENTRU 51259	0.06	5	100	3,00€
10498	TUBULARĂ M8 PENTRU 51259	0.06	5	50	3,00€
10499	TUBULARĂ T40 PENTRU 51259	0.05	5	60	3,00€
10500	CAPETE T50 PT. 51259	0.06	5	100	3,00€
10501	TUBULARĂ 3/8" M10 PENTRU 51259	0.08	5	100	8,10€
10502	TUBULARĂ M10 75MML PENTRU 51259	0.06	-	20	3,50€

INCLUDE

A	x3	T50x110mm (1/2"), M10x110 (1/2"), M10x90mm (3/8")	E	x1	1/2"x10mm
B	x1	M10x140mm	F	x1	M10x65mm
C	x2	19, 22mm	G	x6	T40, T50, M8, M10, H8, H10 (10x75mm)
D	x3	22x28, 19x28, 21x28mm	H	x1	H22

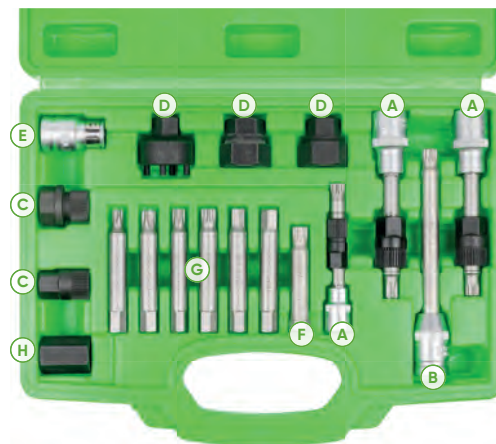

SCULE SPECIALE

51495

59,00€

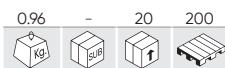

EXTRACTOR BOBINE DE INDUCȚIE PENTRU VW



- Scoaterea sau instalarea bobinelor de aprindere la motoare de injecție VW CYL 8 și 12 / 5 și 6 CYL, VW GOLF, BORA, 4 și 5 CYL. VW Passat, 6 CYL, Sharan VW, Touareg, Phaeton.
- Scoaterea sau instalarea bobinelor de aprindere de potențial VW Polo, Golf 1.4, 1.6i, 1.4i CADDY, BORA 1.4, 1.6i Phaeton, Passat, Touran 1.6i, Transporter T4.



CLESTE CONECTORI BUJII INCANOESENTE

REF.	DESCRIERE				€
52816	CLESTE CONECTORI BUJII INCANOESENTE ÎN UNGHII- 235MM	0.27	6	36	28,10€
52817	CLESTE CONECTORI BUJII INCANOESENTE - DREPT DE 250MM	0.28	6	36	23,50€



52621

11,00€

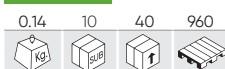

DISPOZITIV PENTRU CURĂȚAT BORNE ACUMULATOR



52319

8,80€



DISPOZITIV PENTRU REPARAREA BORNELOR DE ACUMULATOR



CHEIE MAGNETIZATĂ PENTRU BUJIE

REF.	"	mm					€
52316	3/8"	250mm - Ø14mm	0.20	12	48	2880	18,90€
52317	3/8"	250mm - Ø16mm	0.30	12	48	2880	19,90€



TUBULARĂ DE BUJIE HEX.

REF.	"	mm					€
10054	1/2"	16mm	0.08	10	100	-	2,90€
10055	1/2"	21mm	0.14	10	100	-	3,90€



52691

54,00€



SET DE TUBULARE ARTICULATE PENTRU BUJII

CU SISTEM MECANIC MANUAL

3/8"	8mm (82mm)	3/8"	12mm (82mm)
3/8"	9mm (82mm)	3/8"	14mm (82mm)
3/8"	10mm (82mm)	3/8"	16mm (82mm)



CHEIE ARTICULATĂ PENTRU BUJII

REF.	DESCRIERE					€
54381	CHEIE ARTICULATĂ PENTRU BUJII 14 MM	0.35	10	40	-	5,00€
54382	CHEIE ARTICULATĂ PENTRU BUJII 16 MM	0.35	10	40	-	5,00€
54383	CHEIE ARTICULATĂ PENTRU BUJII 21 MM	0.39	10	40	-	5,00€



N

54380

0.00	10	50	-

SET DE 9 CHEI CU MÂNER ÎN FORMĂ DE T (7-19MM)

119,00€



N

PIESE DISPONIBILE

REF.	mm				€	REF.	mm				€
16430	7	0.17	10	50	20,50€	16565	14	0.17	10	50	19,50€
16431	8	0.17	10	50	20,50€	16566	19	0.17	10	50	22,50€
16432	10	0.17	10	50	20,50€						
16433	11	0.17	10	50	20,50€						
16434	13	0.17	10	50	20,50€						
16435	15	0.17	10	50	21,50€						
16436	17	0.17	10	50	21,50€						

9
PCS

CrV

7, 8, 10, 11, 13,
14, 15, 17, 19mm**51501**

0.88	5	20	240

SET DE 12 PIESE MONTAT / DEMONTAT AIRBAG

38,00€

12
PCS

- Vărfuri 0.5 PC 1/4" x 87 mm (L):
2x Torx: T25 (pentru BMW), T30 (pentru Audi, Opel, Renault, VW).
2x Torx (inviolabil): T25H (pentru BMW), T30H (pentru AUDI, BMW, Mercedes, Opel).
1x Hex: 5mm (pentru AUDI).

- 0.7 PC Cheie extracție:
1x pentru Airbag conducător. 1999-04 tip de caroserie de VW Passat, JETTA, GOLF.
2x pentru VW Passat B5, POLO, LUPO ; AUDI A4, A6, Skoda Superb.
2x pentru VW GOLF 4, New Beetle, SEAT, SKODA FABIA, AB Oktavia BJ.99.
1x pentru VW GOLF 4 (BJ, 1998-2004), VW PASSAT BJ.1997 AB, AB BORA BJ.1999.
1x pentru U.A VW- MODEL: AB PASSAT BJ.2000.

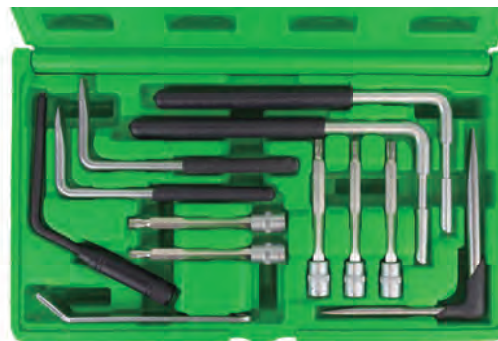
**53388**

1.50	-	5	120

SET DE 52 PIESE PENTRU EXTRAGEREA APARATELOR RADIO

90,00€

52
PCS

BLAUPUNKT, CLARION, SKODA, BMW, AUDI, GFUNDIG, JVC, PIONEER, VOLKSWAGEN, MERCEDES, OPEL DOPPEL-KUGEL-INBUS, PORSCHE, BECKER, KENWOOD, SONY, PANASONIC, FIAT BRAVA, FORD.



51126

18,00€

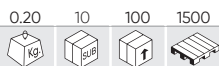

SET DE ACCESORII PT. DEMONTAT APARATE RADIO

10
PCS

BLAUPUNKT, PEUGEOT, CLARION, SKODA, ALPINE, BMW, OPEL, AUDI, GFUNDIG VDO, JVC, PIONEER, VOLKSWAGEN, MERCEDES, PORSCHE, RENAULT, BECKER.



53393

118,00€

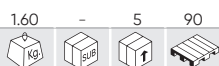

SET DE 23 EXTRACTOARE DE PAPUCI ELECTRICI

23
PCS



BMW, AUDI, VOLKSWAGEN, MERCEDES, OPEL, PORSCHE, JAGUAR, SAAB, SEAT, FORD, SKODA, RENAULT, CITROËN, CHRISLER, FIAT, HONDA, MAZDA, MITSUBISHI, TOYOTA.

53391

86,00€



SET DE 19 EXTRACTOARE DE PAPUCI ELECTRICI

19
PCS



x19 A, B, C, D, E, F, G, H, I, J, K, L, A1, B2, C3, D4, E5, F6, G7

51986

11,90€

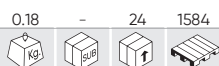

SPRAY CU GAZ PENTRU TORȚĂ GAZ 200ML

200ml



51920

18,00€

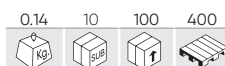

TORȚĂ GAZ



53474

94,00€

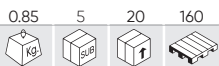

STROBOSCOP DIGITAL

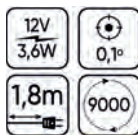

53240

58,00€

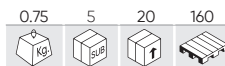

PISTOL STROBOSCOPIC



53663

8,00€

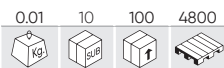

INSTRUMENT PENTRU DEMONTAREA CONECTORILOR VAG



- Instrument pentru dezasamblarea conectorilor din vehiculele grupului VAG fără a le deteriora.



TRUSĂ REPARAȚIE FILETE

53041

37,60€

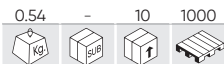

M14 x 1,25

BUJILE SPECIALE



51898

139,00€

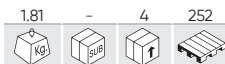

M18 x 2,5



51899

137,00€



M20 x 2,5



51896

82,00€

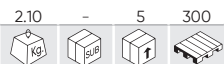

SET REPARAȚII FILETE

115 PCS



CONȚINE PE DIMENSIUNE

Burghiu.
Tarod.
Insertor filet.
Pin ghidare.
Insertie filetată din oțel inoxidabil.

CONȚINE

25 x M5x0.8
25 x M6x1
25 x M8x1.25
25 x M10x1.5
10 x M12x1.75

51897

122,00€



SET REPARAȚII FILETE

39 PCS



CONȚINE PE DIMENSIUNE

Burghiu.
Tarod.
Insertor filet.
Pin ghidare.
Insertie filetată din oțel inoxidabil.

CONȚINE

9 x M12x1.75
9 x M14x2
9 x M16x 2.0

FILETE

REF.	DESCRIERE	0.01	10	100	4800	€
52016	FILETE M5X0,8	0.01	10	300	72000	2,10€
52017	FILETE M6X1,0	0.01	500	1000	21000	2,40€
52018	FILETE M8X1,25	0.01	10	500	21000	2,60€
52019	FILETE M10X1,5	0.01	10	500	21000	3,20€
52021	FILETE M12X1.75	0.05	100	500	21000	3,40€
52022	FILETE M14X2.0	0.03	100	300	12600	4,50€
52023	FILETE M16X2.0	0.05	60	300	12600	6,60€
52024	PIESĂ DE SCHIMB HELICOIL M18X2.5	0.08	-	10	21000	10,60€
52025	FILETE M20X2.5	0.10	-	60	21000	13,00€

SCULE SPECIALE

50793

94,00€

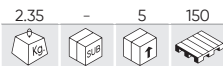

60
PCS

SET DE TAROZI ȘI FILIERE ÎN MM ȘI ȚOLI CU 60 PIESE

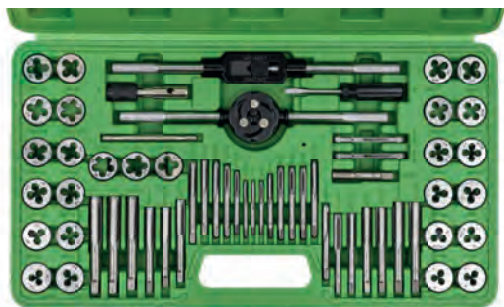

- x1 Tarod NPT (țoli): 1/8-27.
- x1 Filieră TNP (țoli): 1/8-27.
- x1 Suport de Tarozii mixt: M3 ~ M12 și 3/16" ~ 1/2".
- x1 Suport de Tarozii mixt tip T: M3 ~ M6 6-32 și 4-40.
- x1 Suport Filiere mixt Ø25mm
- x1 Șurubelniță.
- x1 Set de lere pentru măsurat filet în mm.
- x1 Set de lere pentru măsurat filet în țoli.
- x10 Seturi de tarozii (mm): M3x0.5, M4x0.7, M5x0.8, M6x1.0, M7x1.0, M8x1.25, M9x1.25, M10x1.0, M10x1.5, M12x1.75.
- x10 Tarozii UNC (țoli): 4-40, 6-32, 8-32, 10-24, 12-24, 1/4-20, 5/16-18, 3/8-16, 7/16-14, 1/2-13.
- x6 Filiere UNF (țoli): 10-32, 1/4 -28, 5/16-24, 3/8-24, 7/16-20, 1/2-20.
- x10 Filiere (mm): M3x0.5, M4x0.7, M5x0.8, M6x1.0, M7x1.0, M8x1.25, M9x1.25, M10x1.0, M10x1.5, M12x1.75.
- x10 Filiere UNC (țoli): 4-40, 6-32, 8-32, 10-24, 12-24, 1/4-20, 5/16-18, 3/8-16, 7/16-14, 1/2-13.
- x6 Filiere UNF (țoli): 10-32, 1/4-28, 5/16-24, 3/8-24, 7/16-20, 1/2-20.

50792

105,00€

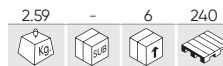

58
PCS

SET DE TAROZI ȘI FILIERE CU 58 PIESE ACOPERITE CU UN STRAT DE TITAN



- x1 Tarod tip NPT : 1/8-27.
- x1 Filieră tip NPT : 1/8-27.
- x1 Suport tarozii : M4~M12.
- x1 Suport tarozii tip T : M3~M6.
- x1 Suport Filiere : 25 mm O/D.
- x1 Șurubelniță.
- x1 Set de lere pentru măsurarea filetelor.
- x34 Tarozii : M2x0.4 (x2), M3x0.6 (x2), M3x0.5 (x2), M3.5x0.6 (x2), M4x0.75 (x2), M4x0.7 (x2), M5x0.8 (x2), M6x0.75 (x2), M6x1.0 (x2), M7x0.75 (x2), M7x1.0 (x2), M8x1.0 (x2), M8x1.25 (x2), M10x1.25 (x2), M10x1.5 (x2), M12x1.25 (x2), M12x1.75 (x2)
- x17 Filiere : M2x0.4, M3x0.6, M3x0.5, M3.5x0.6, M4x0.75, M4x0.7, M5x0.8, M6x0.75, M6x1.0, M7x0.75, M7x1.0, M8x1.0, M8x1.25, M10x1.25, M10x1.5, M12x1.25, M12x1.75

51496

8,00€

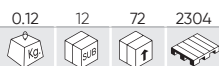

EXTRACTOR DE ȘURUBURI RUPTE

- N°1 1/8" - 1/4" (M 3-6)
- N°2 1/4" - 5/16" (M 6-8)
- N°3 5/16" - 7/16" (M 8-11)
- N°4 7/16" - 9/16" (M 11-14)
- N°5 9/16" - 3/4" (M 14-18)



53502

38,70€

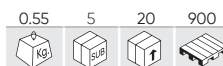

SET EXTRACTOARE PENTRU SCULE TĂIERE FILET

- #2 M5
- #3 M6
- #4 M8
- #5 M10
- #6 M12
- #7 M14
- #8 M16
- #9 M20
- #10 M22



53055

33,00€

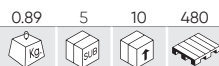

APARAT PENTRU DEMONTAREA ȘI NITUIREA LANȚURILOR DE MOTOCICLETE

PINI 2.2mm, 2.9mm, 3.8mm



54280

156,50€

7
PCS

N

SET DE REPARARE A FILETULUI BUJIEI DE APRINDERE

PIESE DISPONIBILE

REF.	DESCRIERE					€
16237	M8X1,0 115MM	0.10	10	40	23,00€	
16238	M10X1,0 115MM	0.10	10	40	23,00€	
16239	M12X1,25 140MM	0.15	10	40	23,00€	
16240	M12X1,25 270MM	0.30	10	40	26,00€	
16241	M14X1,25 140MM	0.15	10	40	23,00€	
16242	M14X1,25 270MM	0.35	10	40	26,00€	
16243	M18X1,5 90MM	0.10	10	40	23,00€	

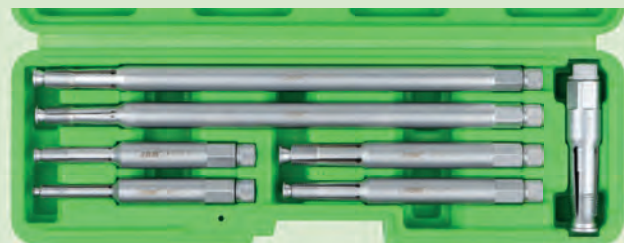
**52833**

39,30€

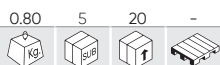
**SET EXTRACTOARE ȘURUB PREZOANE RUPT**

1/2"



PIESE DISPONIBILE

REF.	mm				€
14211	6mm	0.10	20	100	11,00€
14212	8mm	0.10	20	100	12,00€
14213	10mm	0.20	20	100	12,00€
14214	12mm	0.20	20	100	14,00€

53524

51,00€

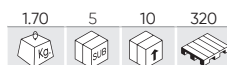
**SET DIN 4 DISPOZITIVE PENTRU TĂIEREA PIULIȚELOR**

PIESE DISPONIBILE

REF.	mm					€
14049	9-12 mm (1/8" - 1/2")	0.10	-	50	-	8,00€
14050	12-16 mm (1/2" - 5/8")	0.20	-	50	-	10,50€
14051	16-22 mm (5/8" - 7/8")	0.44	25	50	-	18,00€
14052	22-36 mm (7/8" - 1-1/16")	0.65	-	20	-	19,50€

53652

53,00€

**SET PENTRU RESTABILIREA FILETELOR PE CRAMPOANELE ROȘILOR**

PIESE DISPONIBILE

REF.	DESCRIERE				€
14340	ȘURUB DE REPARAȚIE M12X1.25 - PSA (REF. 53652)	0.05	-	20	10,50€
14341	ȘURUB DE REPARAȚIE M12X1.5 - MERCEDES BENZ / BMW (REF. 53652)	1.14	-	20	10,50€
14342	ȘURUB DE REPARAȚIE M12X1.75 - VOLVO (REF. 53652)	1.12	-	20	10,50€
14343	ȘURUB DE REPARAȚIE M14X1.5 - VAG (REF. 53652)	1.29	-	20	10,50€
14344	DISC DE REPARAȚIE M12X1.25 (REF. 53652)	0.49	-	20	11,00€
14345	DISC DE REPARAȚIE M12X1.5 (REF. 53652)	0.50	-	20	11,00€
14346	DISC DE REPARAȚIE M14X1.5 (REF. 53652)	0.46	-	20	11,00€



SCULE SPECIALE

54003

104,00€

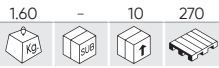

SET DE REPARARE A FILETULUI INTERNE ȘI EXTERNE



- x1 M14x1.5
- x1 M16x1.5
- x1 M18x1.5
- x1 M20x1.5
- x1 M22x1.5
- x1 M24x1.5
- x1 M27x2.0
- x1 M28x1.5



53665

19,00€

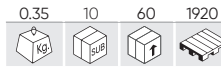

ELIBERATOR PENTRU LANȚURILE DE MOTOCICLETE (25-60)



53666

28,00€

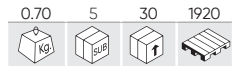

ELIBERATOR PENTRU LANȚURILE DE MOTOCICLETE (60-100)



53054

6,00€

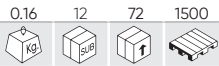

CHEI TUBULARE SPECIALE PENTRU MOTOCICLETE



53086

9,00€

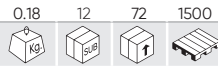

CHEIE PENTRU MOTOCICLETĂ



YAMAHA, KAWASAKI,
BMW, SUZUKI, HONDA

52454

12,90€

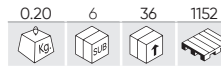

EXTRACTOR PT. BRAȚUL STERGĂTORULUI DE PARBRIZ



53664

38,00€

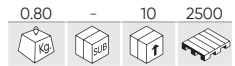

EXTRACTOR UNIVERSAL DE SCRIPETE



Arbore cu diametrul de 16 mm
cu bilă de centrare și cap șurub
hexagonal de 24 mm.

51125

88,00€

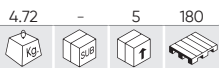

SET EXTRACTOARE GHILOTINĂ

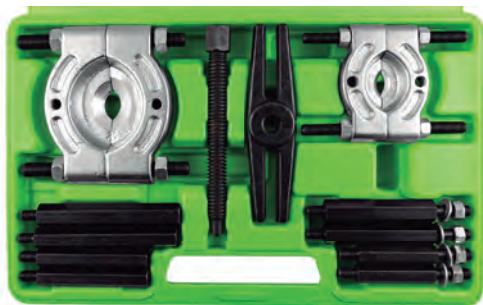

SET INCH

- x2 1/4", cu 30 mm și 50 mm.
- x1 Șurub de 3/8" de 9.5x125 - 24 UNF.
- x1 Cap de 3/8" x 16 UNC.

SET 2 INCH

- x1 1/4" - 3 1/2", cu 50 x 75 mm.
- x1 Șurub de 1/2" de 12.7x135 - 20 UNF.
- x1 Cap de 3/8" x 16 UNC.

GHILOTINĂ EXTRACTOARE DE RULMENȚI

REF.	DESCRIERE				€
52626	75-105mm	3.65	-	5 800	46,00€
52627	105-150mm	6.50	-	2 231	120,00€



EXTRACTOARE CU 2 GHEARE

REF.	DESCRIERE	—	I					€
52727	EXTRACTOR CU 2 GHEARE 25-70MM	25-70mm	50mm	0.20	10	60	1200	34,60€
52728	EXTRACTOR CU 2 GHEARE 25-130MM	25-130mm	110mm	1.20	5	10	500	68,00€
52729	EXTRACTOR CU 2 GHEARE 60-200MM	60-200mm	160mm	3.26	-	3	240	128,00€
52730	EXTRACTOR CU 2 GHEARE 80-350MM	80-350mm	225mm	8.55	-	2	108	288,00€

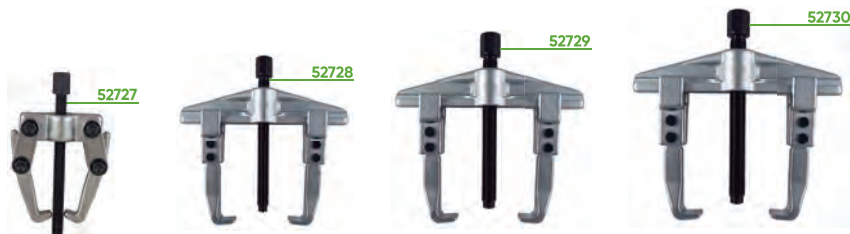

REF.	DESCRIERE					€
53146	EXPOZANT EXTRACTOARE	0.70	5	10	140	30,50€

EXTRACTOARE CU 3 GHEARE

REF.	DESCRIERE	—					€
52731	EXTRACTOR CU 3 GHEARE 50-100MM	50-100mm	0.90	4	24	504	38,00€
52732	EXTRACTOR CU 3 GHEARE 70-150MM	70-150mm	2.54	5	20	200	58,00€
52733	EXTRACTOR CU 3 GHEARE 95-200MM	95-200mm	5.20	-	4	112	98,00€



EXTRACTOARE CU 3 GHEARE CONVERTIBILE ÎN 2 REVERSIBIL

REF.	DESCRIERE	T					€
52010	EXTRACTOARE CU 3 GHEARE CONVERTIBILE ÎN 2 REVERSIBIL 2T	2T	0.50	4	40	360	80,00€
52296	EXTRACTOARE CU 3 GHEARE CONVERTIBILE ÎN 2 REVERSIBIL 5T	5T	1.57	4	8	120	119,00€
52297	EXTRACTOR CU 3 GHEARE CONVERTIBIL ÎN 2 REVERSIBIL 7T	7T	3.33	-	6	36	172,00€
52298	EXTRACTOARE CU 3 GHEARE CONVERTIBIL ÎN 2 REVERSIBIL - SCURTĂ ȘI LUNGĂ	2T	2.65	3	6	396	177,00€



53701

188,00€

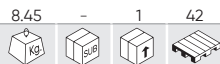

SET UNIVERSAL DE DISPOZITIVE EXTRACTOARE DE PRINDERE CU 2/3 CAPTURI

- Interval de lucru 2 tălpi: 45-120mm.
- Interval de lucru 3 tălpi: 50-130mm.
- Adâncime de prindere: 100, 200, 250mm.

CONTINE

- Ghidaj central pentru 3 tălpi.
- Ghidaj central pentru 2 tălpi.
- Prizon: 275mm.
- Prizon: 165mm.
- Tălpi lungi cu dispozitiv de prindere: 250mm.
- Tălpi medii cu dispozitiv de prindere: 200mm.
- Tălpi scurte cu dispozitiv de prindere: 100mm.

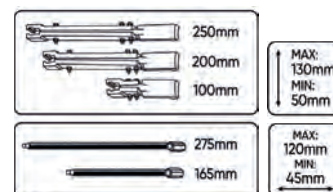

REF. DESCRIERE

REF.	DESCRIERE	kg	box	quantity	€
14611	VÂRF DE CAPTURARE PENTRU REF. 53701	0.10	-	50	12,00€
14612	ȘURUB 165 MM PENTRU REF. 53701	0.15	-	20	11,00€
14613	ȘURUB 275 MM PENTRU REF. 53701	0.30	-	20	13,50€

53062

99,00€

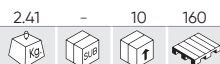

EXTRACTOR DE RULMENȚI CU SFERE FALSE

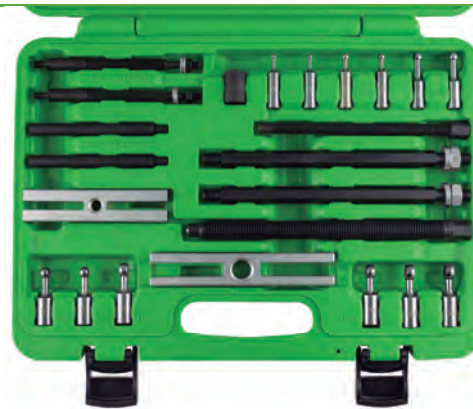

51140

64,00€



EXTRACTOR CU PRINDERE PRIN FILET

- Este un extractor universal cu prindere prin filet și pătrat de susținere împotriva rotirii.
- Permite reglarea axei centrale atunci când este cuplat.
- Folosind bara de șurub centrat pentru a deșurubă rola.
- Șuruburi de fixare: M6, M8.



51500

29,00€



EXTRACTOR FULII CU CANAL

- Apt pentru utilizarea în arbori cotiți, alternatoare, unități de AACC și pompe de apă.
- Brațurile scurte permit un acces ușor în zone dificile.
- Desenat pentru extracția arborelui cotit înepenit și scripetelor auxiliare.
- Rang: 40-160mm.



40-168mm

52494

227,00€

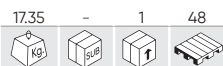

PRESĂ UNIV. PT. EXTRAS/MONTAT BUCȘE ȘI RULMENȚI SUSPENSIE

- Utol pentru instalarea și deinstalarea bușelor și rulmenților de suspensie.
- Conține furtune de diferite dimensiuni și diferite tije filetate metrice.
- Dimensiuni: M10, M12, M14, M16, M18.

ADAPTOARE (DIAMETRU EXTERIOR/INTERIOR):

90/80, 85/75, 82/72, 80/70, 78/68, 76/66, 74/64, 72/62, 70/60, 68/58, 66/56, 64/54, 62/52, 60/50, 58/48, 56/46, 54/44, 52/42, 50/40, 48/38, 46/36, 44/34

REF.	DESCRIERE	Kg	m³	Unit	€
12926	PREZON M10 P/52494	0.46	-	20 1500	21,50€
12927	PREZON M12 PENTRU REF.52494	0.52	-	20 -	21,50€
12928	PREZON M14 PENTRU REF.52494	0.60	-	30 1500	22,00€
12929	PREZON M16 PENTRU REF.52494	0.66	-	20 -	23,00€
12930	PREZON M18 PENTRU REF.52494	0.89	-	30 -	23,50€



51124

88,00€



EXTRACTOR DE RULMENȚI CU PRINDERE INTERIOARĂ

5
PCS

UNIVERSAL



CONȚINE

Extractor Universal (38,5mm).
Adaptor de 3/8" la 1/2" (10-14 mm).
Adaptor de 9/16" la 11/16" (15-19 mm).
Adaptor de 5/8" la 1" (18-25 mm).
Adaptor de 1" la 1 1/4" (25-32 mm).

52624

28,00€



EXTRACTOR CU PRINDERE PRIN FILET

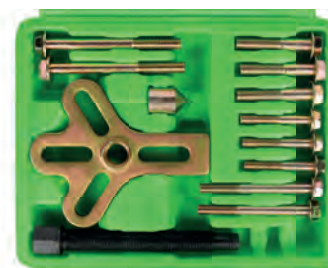

x2	Șuruburi 5/16" de 4"
x2	Șuruburi 1/4" de 3"
x3	Șuruburi 1/4" de 2"
x3	Șuruburi 5/16" de 2"
x1	5" Șurub de presiune din aliaj de aluminiu
x1	Vârf rotativ 3/4"

53058

193,00€

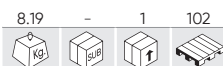

JOC DE MONTAJ PENTRU RULMENȚI



x49	Ø 18, 19, 20, 21, 22, 23, 24, 25, 26, 27, 28, 29, 30, 31, 32, 33, 34, 35, 36, 37, 38, 39, 40, 41, 42, 43, 44, 45, 46, 47, 48, 49, 50, 51, 52, 53, 54, 55, 56, 57, 58, 59, 60, 61, 62, 63, 64, 65, 74mm
x1	Mâner metalic (pentru utilizare cu un ciocan) cu diametrul de Ø 12mm

53056

127,00€



JOC DE EXTRAGERE ȘI INSTALARE A RULMENȚILOR



x9	Ø 55.5, 59, 62, 65, 66, 71.5, 73, 78, 84mm	x1	Ø 69mm
x2	Ø 75.5, 83mm	x1	295mm

SCULE SPECIALE

52551

151,00€

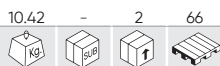

TRUSĂ PENTRU MONTAT / DEMONTAT RULMENȚI



- x13** Dimensiuni disc: 50, 55, 60, 64, 67, 70, 72, 74, 75, 78, 82, 84, 88mm
- x4** Cilindri: 76, 82, 92, 101 mm
- x1** Bolt: 32 mm
- x1** Piuliță: 38 mm
- x1** Șurub întărit pentru utilizare cu unealta de impact.
- x1** Arbore din oțel-fosfat pentru a preveni coroziunea.

53463

98,00€

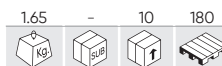

SET DE EXTRACTOARE PENTRU ȘTERGĂTOARE DE PARBRIZ



- VW: Polo, Lupo, Touareg, Porsche Cayenne.
- Opel: Astra G, Zaphira B, Corsa C, Vectra C.
- Honda: Jazz, CRV, FRV, Accord, Turnier.
- BMW: Al 5-lea model din UE 39 până în 2005. Al șaptelea model din E 38 până în 2005
- Audi: A3, A4, A5, A6. Audi Q7.
- Ford: Galaxy, Alhambra.
- Mercedes: A-Class, B-Class.

51349

37,30€

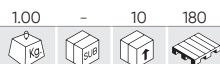

TRUSĂ ADAPTOARE PENTRU MONTAT RULMENȚI



- x13** 42 - 38mm, 40 - 35mm, 36 - 32mm, 30 - 28mm, 24 - 22mm, 27 - 25mm, 18 - 16mm, 20 - 18mm, 22 - 20mm, 12 - 10mm, 14 - 12mm, 16 - 14mm, 17 - 15mm

53059

52,00€

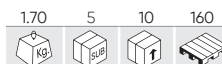

JOC PENTRU INSTALAREA RULMENȚILOR ȘI GARNITURILOR DE ETANȘEITATE



- x9** Ø 39.5, 44.5, 50, 59, 63, 65, 72, 76, 81mm

52056

66,00€



TRUSĂ 8 TUBULARE DE IMPACT 1" PENTRU MULTIPLICATOR DE FORȚĂ

PIESE DISPONIBILE

REF.	DESCRIERE	kg	box	box	box	€
16385	TUBULARE DE IMPACT 22MM PENTRU MULTIPLICATOR DE FORȚĂ 1" 52056	0.50	-	50	-	10,00€
16386	TUBULARE DE IMPACT 24MM PENTRU MULTIPLICATOR DE FORȚĂ 1" 52056	0.45	-	50	-	11,50€
10674	TUBULARE DE IMPACT 27MM PENTRU MULTIPLICATOR DE FORȚĂ 1" 52056	0.59	-	50	-	9,50€
10675	TUBULARE DE IMPACT 30MM PENTRU MULTIPLICATOR DE FORȚĂ 1" 52056	0.55	-	50	-	9,50€
10672	TUBULARE DE IMPACT 32MM PENTRU MULTIPLICATOR DE FORȚĂ 1" 52056	0.66	-	50	-	9,50€
10673	TUBULARE DE IMPACT 33MM PENTRU MULTIPLICATOR DE FORȚĂ 1" 52056	0.67	-	50	-	9,50€
16388	TUBULARE DE IMPACT 38MM PENTRU MULTIPLICATOR DE FORȚĂ 1" 52056	0.70	-	50	-	11,50€
16389	TUBULARE DE IMPACT 41MM PENTRU MULTIPLICATOR DE FORȚĂ 1" 52056	0.75	-	-	-	11,50€



STRUMENTE DE SINCROZARE

- 244 FIAT/ALFA ROMEO
- 249 BMW/MINI
- 258 PSA
- 261 FORD
- 267 JAGUAR/LAND ROVER
- 269 JEEP/CHRYSLER
- 270 MERCEDES-BENZ
- 273 RENAULT/DACIA/NISSAN
- 278 OPEL/VAUXHALL
- 283 VAG
- 295 ALTELE
- 297 INSTRUMENTE AUXILIARE



53303

89,00€



SET DISTRIBUȚIE PE LANȚ FIAT / OPEL

MĂRCI	FIAT: 1.9D/JTD (MOTOR PEUGEOT), 2.4D. ALFA ROMEO: 145, 146, 156 JTD. GM: GM 1.3, 1.6, 1.9, 2.0, 2.4 CDTI (2004 -).
INSTRUMENTE OEM	EN-46789 (1), EN-46789-100 (2), EN-46785 (3), EN-46788 (4), EN-46781 (5), EN-46789 (6)
CODURILE DE MOTOR	GM: K1.3 CDTI Z13DT COMMON RAIL ENGINE. 1.9 CDTI / 04-12 - Z19DT Z19DTH Z19DTJ Z19DTL 2.0 CDTI / 08-12 - A20DT LBS / LBX / LBY / LCDV SAAB: 1.9 TID.

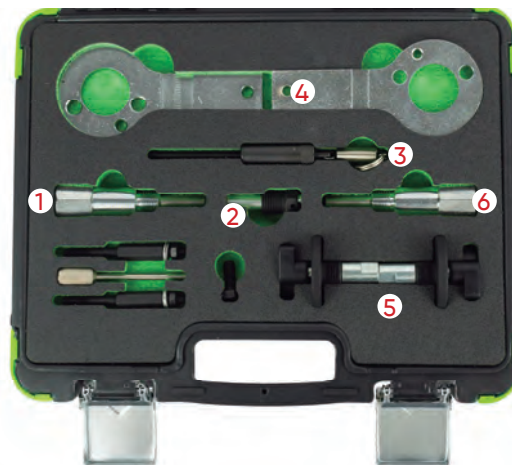

53304

279,00€



SET DISTRIBUȚIE PE LANȚ FIAT

MĂRCI	FIAT
INSTRUMENTE OEM	1 860 874 000 (1), 1 860 895 000 (2), 1 860 898 000 (3), 1 860 905 000 (4), 1 860 845 000 (5)
CODURILE DE MOTOR	PETROL: FIAT BRAVA , BRAVO, BARCHETTA, CARGO, COUPE, MAREA, PALIO, WEEKEND, PUNTO, MULTILA, STILO, IDEA, DOBLO TWIN CAM ENGINES - 1.2, 1.4, 1.6, 1.8, 16V GASOIL: FIAT BRAVA, BRAVO, MAREA, WEEKEND, PALIO, PUNTO, MULTIPLA, DOBLO, ULYSSE, DUCATO, STILO JTD DIESEL ENGINES - 1.9D/TD . 1.9JTD . 2.4TD/JTD.

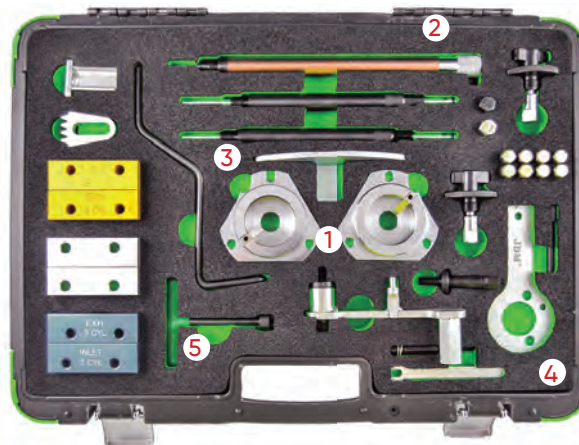

53306

53,00€



SET DISTRIBUȚIE PE LANȚ FIAT 1.2 16V

MĂRCI	FIAT: FIAT 1.2L 16V, FIAT PUNTO / BRAVA / BRAVO / STILO
INSTRUMENTE OEM	1860992000 (1) (2), 1871000900 (3), 1860987000 (4), 186985000 (5)
CODURILE DE MOTOR	176 B9.000, 182 B2.000, 188 A5.000



53308

55,00€

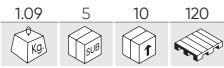

SET DISTRIBUȚIE PE LANȚ ALFA ROMEO

MĂRCI	ALFA ROMEO: 145,146,147,155,156, 1.4 1.6 1.8 2.0 TS, 1.4/1.6 16V; 145/146/147/155/156 (96-10), 1.8 16V; 145/146, (96-01), 155/156 (96-06), SPIDER/GTV (98-05), 2.0 16V; 145/146 (96-01), 147 (01-10), 155/156 (95-02), 166 (98-07), SPIDER/GTV (96-05), PÚRPURA / PURPLE: 1.4, 1.6 // AZUL / BLUE: 1.8, 2.0
INSTRUMENTE OEM	1822149000 (1), 1822154000 (2), 1825041000 (3), 1825042000 (4)
CODURILE DE MOTOR	Z1.4/1.6-321.02, 321.03, 321.04, 335.03, 676.01 1.8/2.0-323.01, 672.04, 162.01, 323.10, 671.06, 322.01, 671.02, 322.05, 341.03, 363.01.

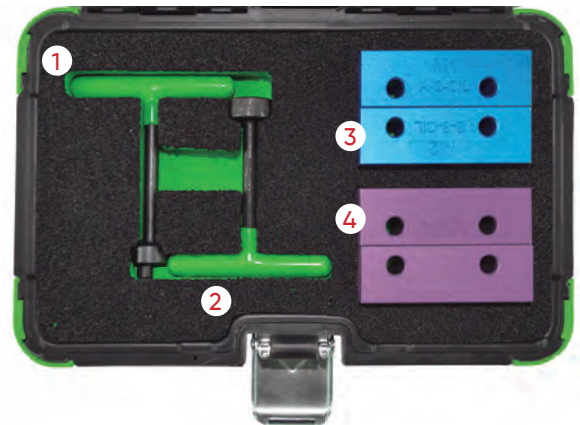

53309

285,00€

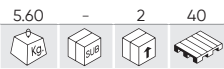

SET DISTRIBUȚIE PE LANȚ ALFA/FIAT/LANCIA 1.4, 1.6, 1.8, 2.0 16V

MĂRCI	ALFA ROMEO: 145,146,147,155,156, 1.4 1.6 1.8 2.0 TS, 1.4/1.6 16V; 145/146/147/155/156 (96-10), 1.8 16V; 145/146, (96-01), 155/156 (96-06), SPIDER/GTV (98-05), 2.0 16V; 145/146 (96-01), 147 (01-10), 155/156 (95-02), 166 (98-07), SPIDER/GTV (96-05), PURPUR: 1.4, 1.6 // BLAU: 1.8, 2.0 FIAT: BARCHETTA (96-00), BRAVA (95-00), BRAVO (95-0 0), COUPE (96-01), MAREA (96-00), MAREA WEEKEND (96-00), PUNTO/PUNTO CLASSIC (99-06), STILO (01-08) LANCIA: DEDRA (95-99), DELTA (96-99), KAPPA (98-02), LYBRA (99-06).
INSTRUMENTE OEM	1.4 16V: 335.03 1.6 16V: 321.02, 321.03, 321.04, 372.03, 676.01 1.8 16V: 322.01, 322.05, 671.06, 182A2.000, 183A1.000, 183A6.000, 188A6.000, 192A4.000 2.0 16V: 162.01, 323.01, 323.1, 341.03, 363.01, 672.04 2.0 20V: 175A3.000, 182A1.000, 182B7.000, 185A8.000.

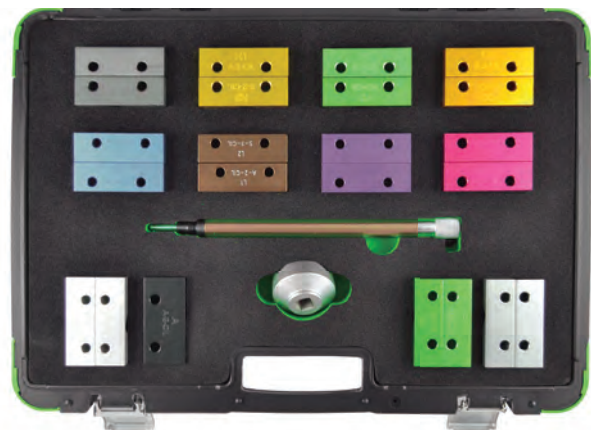

53310

498,00€



SET DISTRIBUȚIE PE LANȚ FIAT/ALFA/LANCIA

MĂRCI	ALFA FIAT LANCIA	ALLA, BARCHETTA, BRAVO, BRAVA, COUPE, DELTA, DEDRA, PUNTO, SPIDER, GT
INSTRUMENTE OEM	1860845000 (1), 1822154000 (2), 1860905000 (3), 1860992000 (4), 1860895000 (5), 1860874000 (6), 1860985000 (7), KM571A (8), 1860896000 (9), 0153A (10)	
CODURILE DE MOTOR	1.2 / 16V, 1.4 / 12V, 1.6 / 16V, 1.6 ECO. 1.8, 2.0 / 16V, 2.0 / 20V, 2.4 / 20V, 3.0 / V6.	



53312

127,00€



SET DISTRIBUȚIE PE LANȚ FIAT/ALFA/FORD

MĂRCI	FIAT: NEW 500 (07-09), IDEA (04-09), LINEA (07-09), GRANDE PUNTO (07-09), DOBLO 1 CARGO (05-09), PANDA EV02 (05) FORD: KA 1.2 DURATEC (09) ALFA ROMEO
INSTRUMENTE OEM	1 860 987 000 (1), 2 000 004 400 (2), 2 000 015 800 (3), 2 000 004 300 (4), 2 000 004 500 (5)
CODURILE DE MOTOR	1.2: 169A4.000 / 199A4.000 . 1.4: 350A 1.000 / 188A4.000-EV02.

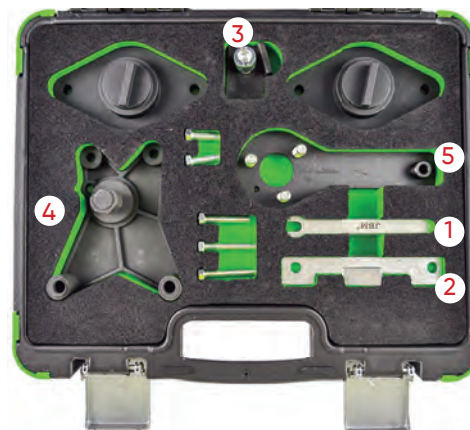

53319

18,00€

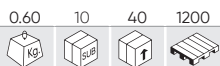

KIT DISTRIBUȚIE PE LANȚ FIAT IVECO 2.3, 3.0 JTD

MĂRCI	FIAT: 2.3 / 3.0 JTD. IVECO: DAILY.
INSTRUMENTE OEM	99360614, 1 860 617 000, 99360615, 2 000 018 200.
CODURILE DE MOTOR	F1AE0481C, F1AE0481D, F1AE0481N, F1CE0481A/D.

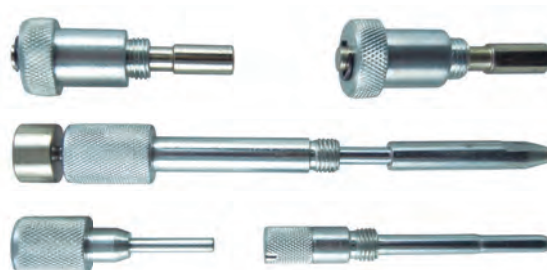

54202

68,00€



SET INSTRUMENTE DE REGLARE A MOTOARELOR PENTRU FIAT/ALFA ROMEO/LANCIA

MĂRCI	ALFA ROMEO: GIULIETTA (10-14), MITO (08-17). FIAT: 500 (07-19), 500L (12-19), 500C (07-19), 500 ABARTH (08-17), BRAVO (07-14), BRAVA/BRAVO (98-02), DOBLO/DOBLO CARGO (10-19), EGEA (15-20), GRANDE PUNTO (07-10), GRANDE PUNTO ABARTH (07-10), IDEA (04-12), LINEA (07-10), MAREA/WEEKEND (98-00), PALIO WEEKEND (01-06), PANDA (07-11), PUNTO (97-08), STILO (01-08), TIPO (15-20). LANCIA: DELTA (08-12), MUSA (04-13), YPSILON (96-11).
INSTRUMENTE OEM	2.000.004.500 (1), 1.860.985.000 (2), 1.860.992.000 (3), 1.860.987.000 (4), 2.000.015.800 (5)
CODURILE DE MOTOR	1.2 16V:176B9.000, 182B2.000, 188A5.000. 1.4 16V / T-JET: 169A3.000, 192B2.000, 198A1.000, 198A4.000, 199A6.000, 198A8.000, , 312A1.000, 312A3.000, 843A1.000, 955A1.000.

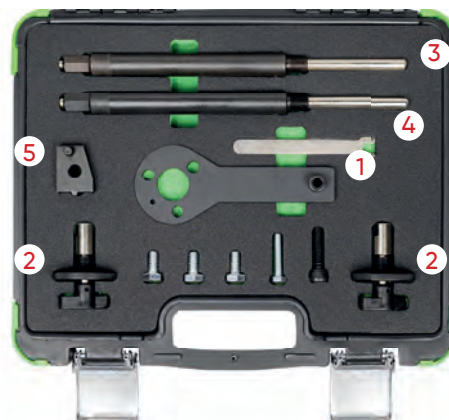

54203

91,00€



SET INSTRUMENTE DE REGLARE A MOTOARELOR PENTRU ALFA ROMEO/LANCIA 1.8 TBI

MĂRCI	ALFA ROMEO: 159(09-12), BRERA(09-11), GIULIETTA(10-19), SPIDER(09-11), 4C(13-19). LANCIA: DELTA(09-14).
INSTRUMENTE OEM	2 000033500 (1), 2000 003000 (2), 1860898 000 (3).
CODURILE DE MOTOR	ALFA ROMEO 1,75 TBI: 939B1.000, 940A1.000, 940B2.000, 960A1.000 LANCIA 1,75 DI TURBO JET: 939B1.000

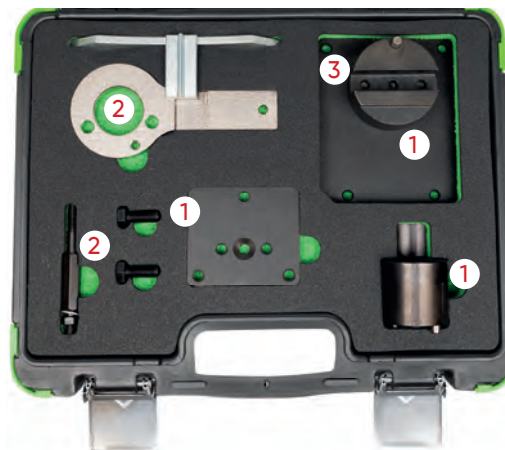

54211

74,00€

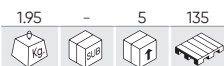

SET INSTRUMENTE DE REGLARE A MOTOARELOR PENTRU FIAT/FORD/OPEL/SUZUKI 1.3L

MĂRCI	FIAT: PUNTO (2003-2007) / PANDA (2003-2009) / IDEA (2004-2006) / DOBLO (2004-2006). FORD: KA. VAUXHALL / OPEL: AGILA (2003-2008) / CORSA C (2003-2007) / CORSA D (2006-2009) / COMBO C (2003-2009) / ASTRA H (2004-2009) TIGRA B (2004-2009) / MERIVA (2004-2009). SUZUKI: IGNIS (2003-2009) / WAGON R (2003-2009) / SWIFT (2003-2010).
INSTRUMENTE OEM	1871000200 / 303-1469 / KM-662-C (1), EN 46785 / KM 955 / 09912-38300 (2), 1871000900 / 1860985000 / 303-1472 / EN 46781 / 09917-68610 (3), 1870900400 (4), 1870900300 / 303-1468 (5)
CODURILE DE MOTOR	FIAT: 1.3 JTD 188A9.000 / 169A.000 / 188A8.000 / 199A3.000. FORD: 1.3 TDCI. VAUXHALL / OPEL: 1.3 CDTI Z13DT / Z13DTH / Z13DTJ. SUZUKI: 1.3 CDTI Z13DT.



54212

39,40€



SET INSTRUMENTE DE REGLARE A MOTOARELOR PENTRU FIAT/LANCIA 1,4 12V

MĂRCI	MAREA/MAREA_WEEKEND(96-20), BRAVA(95-98), BRAVO(95-98). LANCIA: YPSILON(96-20)
INSTRUMENTE OEM	1860899000 (1), 1860901000 (2)
CODURILE DE MOTOR	1.4 12V : 182A3.000, 182A5.000.

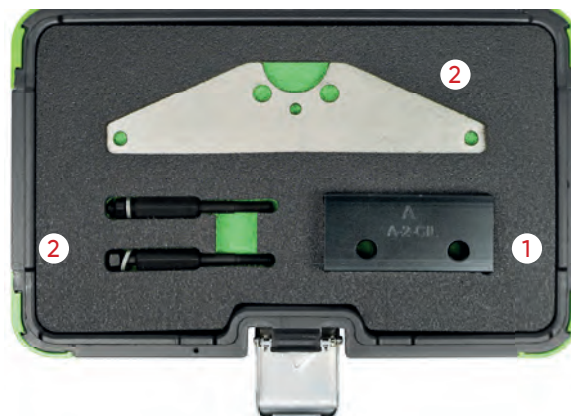

54215

57,00€

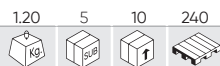

SET INSTRUMENTE DE REGLARE A MOTOARELOR PENTRU ALFA ROMEO/FIAT 1.4 MULTIAIR

MĂRCI	ALFA ROMEO GIULIETTA, MITO / FIAT PUNTO, PUNTO EVO 1.4 (TURBO) MULTIAIR (105/135/163/170PS)
INSTRUMENTE OEM	ALFA ROMEO / FIAT: 1860987000 (1), 2000034400 (2), 2000004500 (3)
CODURILE DE MOTOR	940A2.000 / 940A2.000 / 955A8.000 / 955A8.000 / 940A2.000 / 955A8.000 / 955A2.000 / 955A7.000 / 955A6.000 / 955A8.000



54216

49,00€

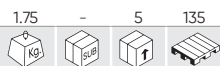

SET INSTRUMENTE DE REGLARE A MOTOARELOR PENTRU FIAT/OPEL/ALFA 1.9, 2.4L 16V

MĂRCI	OPEL 1.9, ALFA-ROMEO 1.9-2.4 L DIESEL, FIAT 1.9- 2.4 L DIESEL
INSTRUMENTE OEM	OPEL EN-46788 / FIAT 1.860.905.000 / 1.860.905.010 (1) FIAT 1.860.898.000 (2) OPEL EN-46789 / FIAT 1.870.896.900 (3) OPEL KM 6130 / KM 6349 (4)
CODURILE DE MOTOR	OPEL 1.9 CDTI Z19DT, Z19DTH, Z19DTJ ALFA-ROMEO 1.9 Y 2.4 L : 323.02, 371.01, 342.02, 325.01, 362.02, 182B9.000, 937A2.000, 937A3.000, 192A5.000, 192B1.000, 937A4.000, 937A5.000, 939A2.000, 939A1.000, 939A7.000, 939A8.000, 839A6.000, 841C.000 FIAT 1.9 Y 2.4 L : 182B4.000, 182B9.000, 185A6.000, 186A6.000, 186A8.000, 186A9.000, 188A2.000, 188A7.000, 188B2.000, 192A1.000, 192A3.000, 192A5.000, 192A8.000, 192A9.000, 192B4.000, 192B5.000, 198A2.000, 198A3.000, 198A6.000, 199A5.000, 223A7.000, 937A5.000, 939A1.000, 939A2.000, 939A3.000, 939A7.000



54430

34,00€

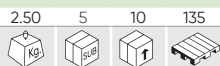

INSTRUMENT DE SINCRONIZARE PENTRU ALFA ROMEO/FIAT/LANCIA 0.9 TWIN AIR

MĂRCI	ALFA ROMEO: MITO (2001-2018) CHRYSLER: YPSILON (2011-2015) FIAT: 500/500C (2010-2020), 500L/500L LIVING/500L MPW (2012-2018), PUNTO (2012-2018), PANDA (2012-) LANCIA: YPSILON (2011-2018)
INSTRUMENTE OEM	2 000 035 100 (1) 2 000 035 200 (2) 2 000 035 300 (3)
CODURILE DE MOTOR	Q.9: 199B6.000, 199B7.000, 312A2.000, 312A4.000, 312A5.000, 312A6.000, 312A7.000



53259

97,00€

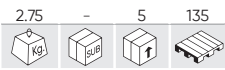

SET DISTRIBUȚIE PE LANȚ BMW N42, N46 1.8, 2.0

MĂRCI	BMW 1 SERIES: 118I E81/82/87/88 (04-14), 120I E81/82/87/88 (04-14). BMW 3 SERIES: 316I/TI COMPACT E46 (01-07), 318I/TI COMPACT E46 (01-07), 318I, E90/91/92/93 (05-12), 320I E90/91/92/93 (05-12). BMW 5 SERIES: 520I E60/61 (07-10), Z4 2.0 E85/86 (04-09). BMW X SERIES: X1 SDRIVE 18I E84 (10-12), X1 XDRIVE 18I E84 (10-12), X3 2.0 E83 (05-10).
INSTRUMENTE OEM	119350 (1), 119340 (2), 119291 (3), 119292 (4), 119270 (5), 115120 (6), 119190 (7), 119293 (8)
CODURILE DE MOTOR	1.8: N42; B18A, N46; B18. / 2.0: N42; B20A, N46; B20, B20B, N46T; B20, B20B, B20BD, B20BZ, B20O2, B2O2.

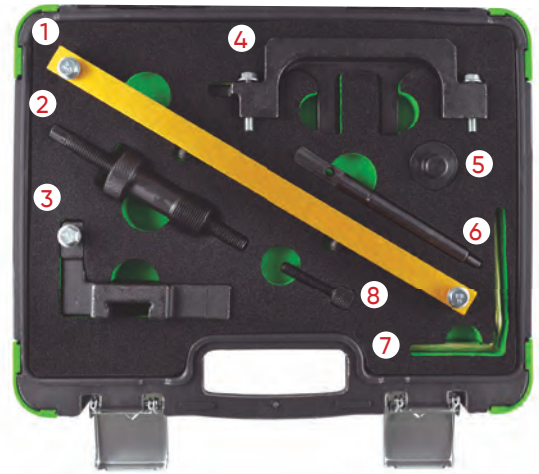

53260

168,00€

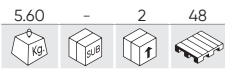

SET DISTRIBUȚIE PE LANȚ BMW N43 1,6/2,0

MĂRCI	BMW 1 SERIES: 116I E81/82/87/88 (07-12), 118I E81/82/87/88 (06-14), 120I E81/82/87/88 (06-14). BMW 3 SERIES: 316I E90/91/92/93 (07-11), 318I E90/91/92/93 (07-13), 320I E90/91/92/93 (07-14). BMW 5 SERIES: 520I E60/61 (07-10).
INSTRUMENTE OEM	118690 (118691/118692/118693) (1), 118710 (118711/118712) (2), 113340 (3) (4), 118700 (5), 119340 (119341/119342) (6), 115120 (7).
CODURILE DE MOTOR	1.6: N43 B16A/AA, B16AA, B16AA/OO. 2.0: N43 B20A, B20A/AA, B20AA, B20AY, B20KO, B20UO.

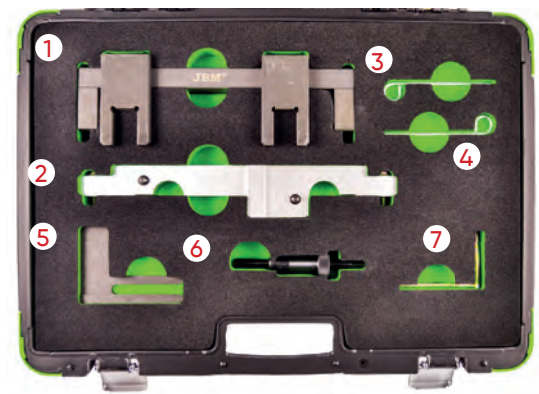

53261

214,00€

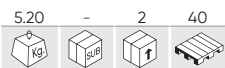

SET DISTRIBUȚIE PE LANȚ BMW N42, N46 1.8, 2.0

MĂRCI	BMW 1 SERIES: 118I E81/82/87/88 (04-14), 120I E81/82/87/88 (04-14). BMW 3 SERIES: 316I/TI COMPACT E46 (01-07), 318I/TI COMPACT E46 (01-07), 318I E90/91/92/93 (05-12), 320I (E90/91/92/93 (05-14). BMW 5 SERIES: 520I E60/61 (07-10). BMW X SERIES: X1 E84 SDRIVE 18I (10-12), X1 E84 XDRIVE 18I (10-12), X3 E83 2.0 (05-10). BMW Z SERIES: Z4 2.0 E85/86 (04-09).
INSTRUMENTE OEM	119190 (1), 119310 (2), 119302 (3)
CODURILE DE MOTOR	2.0: N42 B18A, N42 B20A, N46 B18, N46 B20, N46 B20B, N46T B20, N46T B20B, N46T B20BD, N46T B20BZ, N46T B20O2, N46T B2O2

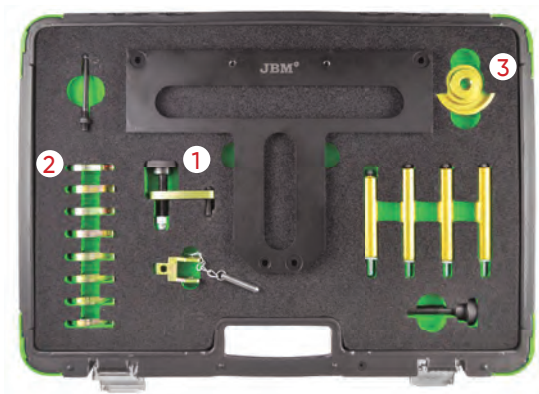

53262

251,00€

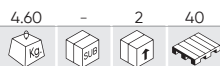

SET DE DISTRIBUȚIE A ARBORELUI CU CAME BMW M52TU, M54, M56

MĂRCI	M52TUB25: 1997-2001 E46 323i/323Ci/323Ti (M52T); 1998-2001 E39 523i (M52TU); 1998-2001 E36/7 Z3 (M52TU). M52TUB28: 1997-2001 E46 328i/328Ci (M52TU); 1997-2001 E36/7 Z3 2.8 (M52B28/Z3); 1998-2001 E39 528i (M52TU); 1998-2001 E38 728i (M52TU). M54B22: 2001-2003 E46 320i/320Ci; 2001-2003 E39 520i; 2001-2002 E36 Z3 2.2i; 2003-2005 E85 Z4 2.2i; 2003-2005 E60/E61 520i. M54B25: 2001-2002 E36/7 Z3 2.5i; 2001-2005 E46 325i/325Xi; 2001-2006 E46 325Ci; 2001-2004 E46 325Ti; 2001-2004 E39 525i; 2003-2004 E60/E61 525i/525Xi; 2004-2006 E83 X3 2.5i; 2004-2006 E85 Z4 2.5i. M54B30: 2001-2005 E46 330i/330Xi; 2001-2006 E46 330Ci; 2001-2003 E39 530i/2001-2002 E36 Z3 3.0i; 2003-2005 BMW E60 530i; 2003-2006 E85 Z4 3.0i; 2001-2006 E53 X5 3.0i.
INSTRUMENTE OEM	116150 (1), 113450 (2), 113292 (3), 116180 (4), 114220(5)

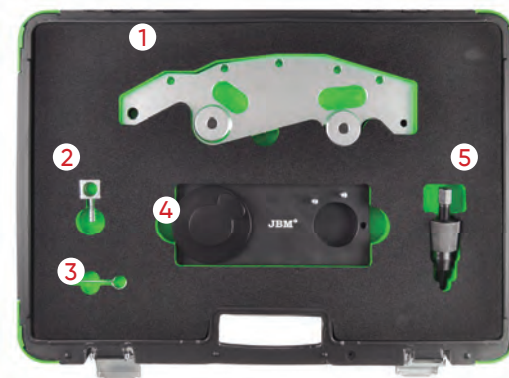

53263

57,00€

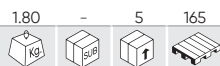

SET BLOCAJ PT ARBOREL CU CAME BMW M47 LAND ROVER TD4,TD6

MĂRCI	BMW 1 SERIES: 118D E87 (04-07), 120D E87 (04-07). BMW 3 SERIES: 318D/TD COMPACT E46 (01-05), 318D/TD E90/91 (05-08), 320D/TD COMPACT E46 (98-05), 320D/CD E90/91 (05-08), 325D E90/91/92/93 (02-10), 330D/CD E46/90/91/92/93 (99-07), 335D E90/91/92 (06-11). BMW 5 SERIES: 520D E39/60/61 (00-09), 525D/XD E39/60/61 (00-10), 530D/XD E46/60/61 (98-10), 535D E60/61 (04-10). BMW 6 SERIES: 635D E63/64 (07-11). BMW 7 SERIES: 730D/LD E38/65/66 (98-08). BMW X SERIES: X3 2.0D E83 (04-07), X3 3.0D/SD E83 (03-10), X5 3.0D E53/E70 (00-10), X6 3.0D E71/72 (08-10), X6 3.5D E71/72 (08-10). LAND ROVER: FREELANDER TD4 (00-06), RANGE ROVER TD6 (02-06). MG/ROVER: MG-ZT/T (01-05), ROVER 75 CDT/CDTI (99-05). VAUXHALL/OPEL: OMEGA-B (01-03).
INSTRUMENTE OEM	112300/12-108, 12-171/KM-813 (1), 113340/12-172/KM-823 (2) (3), 116322/12-174/KM-6267 (4) 116320 (5)
CODURILE DE MOTOR	BM - 2.0D: M47, M47T2, M47TU / 2.5D: M57, M57T2, M57TU / 3.0D: M57, M57T2, M57TU LAND ROVER - 2.0D: 204D3 (TD4) / 3.0D: 306D1 (TD6) MG/ROVER- 2.0D: M47R / 2.0D CDT: M47R VAUXHALL/OPEL- 2.5D: Y25DT



53264

143,00€



SET DISTRIBUȚIE PE LANȚ BMW N62, N73

MĂRCI	BMW 5 SERIES: 540i E60/61 (05-10), 545i E60/61 (03-06), 550i E60/61 (05-10). BMW 6 SERIES: 645i E63/64 (03-06), 650i E63/64 (05-11). BMW 7 SERIES: 735i E65/66 (02-05), 740i E65/66 (05-10), 745i E65/66 (02-05), 750i E65/66 (05-08), 760i E65/66 (02-08). BMW X SERIES: X5 4.4 E53 (03-07), X5 4.8 E53/E70 (04-10).
INSTRUMENTE OEM	119463 (1), 119462 (2), 119340 (3), 119461 (4), 119190 (5)
CODURILE DE MOTOR	3.6 V8: N62 B36A 4.4 V8: N62 B44A 4.0 V8: N62 B40A 4.8 V8: N62 B48B 6.0 V12: N73 B60A

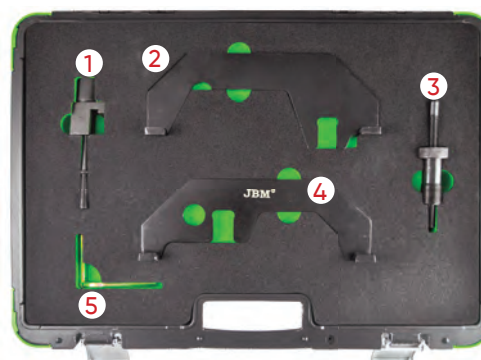

53265

195,00€

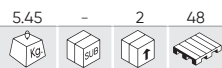

SET DISTRIBUȚIE PE LANȚ BMW DIESEL M47, M57, M41, M51

MĂRCI	BMW
INSTRUMENTE OEM	113360 (1), 116321 (2), 135190 (3), 135191 (4), 135192 (5), 116322 (6), 112300 (7), 113340 (8)
CODURILE DE MOTOR	M41 / M51 / M47TU / M47TU T2. M57TU T2 3.01 1998 - 2008.

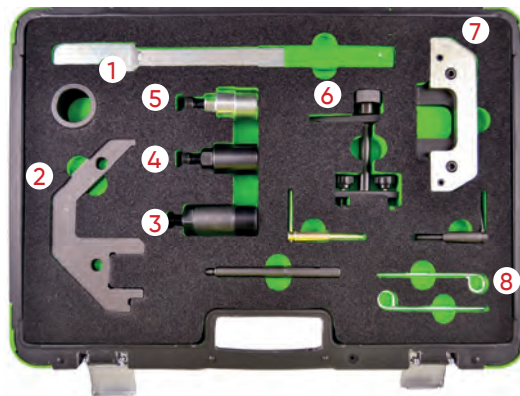

53266

224,00€



SET DISTRIBUȚIE PE LANȚ BMW M42, M43, M50, M51, M52

MĂRCI	BMW
INSTRUMENTE OEM	113240 (1), 115490 (2), 113190 (3), 112300 (4) (5), 113292 (6), 113320 (7)
CODURILE DE MOTOR	PETROL: M42, M43, M50, M52, M60. DIESEL: M51

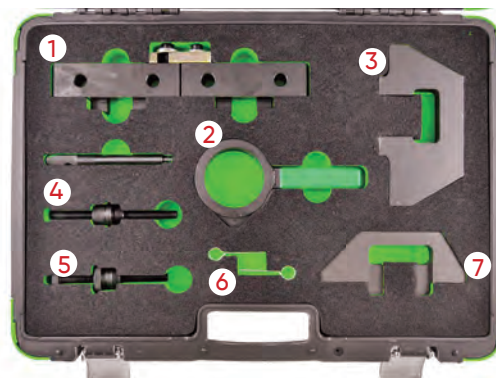

53267

277,00€



SET DISTRIBUȚIE PE LANȚ BMW M40, M43, M42, M44, M52, M54, M56

MĂRCI	BMW SERIES: 3, 5, 7, X, Z
INSTRUMENTE OEM	114220 (1), 112300 (2), 113240 (3), 115490 (4), 113292 (5), 113450 (6)
CODURILE DE MOTOR	M40. M44. M50. M52. M54. M56.

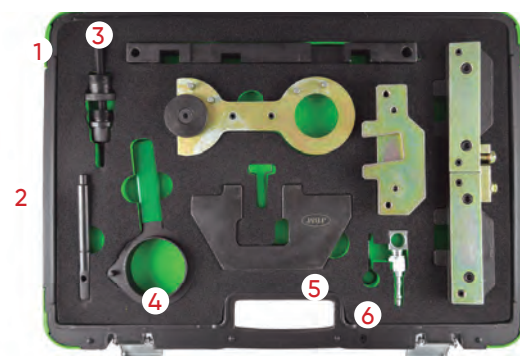

53269

50,00€

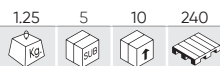

SET DISTRIBUȚIE PE LANȚ BMW N47, N47S, N57

MĂRCI	<p>BMW 1 SERIES: 116D E81/82/87/88 (08-12), 118D E81/82/87/88 (07-14), 120D E81/82/87/88 (07-14), 123D E81/82/87/88 (07-14). BMW 2 SERIES: 218D (11-14), 220D (11-14), 225D (11-14). BMW 3 SERIES: 316D E90/91/92/93 (09-12), 318D E90/91/92/93 (07-12), 320D E90/91/92/93 (07-12), 325D E90/91/92/93 (10-14), 330D/XD E90/91/92/93 (08-14). BMW 5 SERIES: 520D E60/61 (07-10), 525D F10/11 (10-12), 530D F10/11 (10-13), 530DGT F07 (09-12), 535D F10/11 (10-17), 535DGT F07 (10-12). BMW 7 SERIES: 730D/LD F01/02/04 (08-12), 740D F01/02/04 (09-12), 740D XDRIVE F01/02/04 (09-12), 750D XDRIVE F01/02/04 (12-15). BMW X SERIES: X1 SDRIVE 18D E84 (09-15), X1 SDRIVE 20D E84 (09-12), X1 XDRIVE 18D E84 (09-15), X1 XDRIVE 20D E84 (09-15), X1 XDRIVE 23D E84 (09-12), X3 2.0D E83 (07-10), X3 XDRIVE 18D E83 (08-10), X3 XDRIVE 30D E83 (11-12), X3 XDRIVE35D F25 (11-17), X5 3.0D E70 (10-13), X5 XDRIVE 40D X5 F15 M50D (13-17), E70 (10-13), X6 XDRIVE 30D E71/72 (10-14), X6 XDRIVE 40D E71/72 (10-14), X6 F16 M50D (14-17). BMW MINI: PACEMAN (13-17), COUNTRYMAN (10-17), MINI (10-15), ROADSTER (12-14), CLUBMAN (10-14), CLUBVAN (12-14).</p>
INSTRUMENTE OEM	118760 (1), 118740 (2), 116480 (3), 115320 (4)
CODURILE DE MOTOR	<p>1.6 D: N47; C16K1, C16U1. 2.0 D: N47; C20K1, C20U1N47; D20, D20A, D20B, D20D, D20K1, D20O0, D20O1, D20T1, D20U0, D20U1, N47S D20T0, N47T; D20, D20O1, D20U1. 3.0 D: N57; B30B, B30B/T0, B30C, D30BT0, D30O0, D30O1, D30T0, D30T1, D30U0.</p>



54206

113,00€

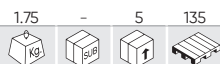

SET INSTRUMENTE DE REGLARE A MOTOARELOR PENTRU BMW/MINI 1.5 , 2.0L

MĂRCI	<p>BMW - 1 SERIES - 114D, 116D, 214D - (F20/ 21) - (2015- 2017) - 2 SERIES - 216D, 118D, 125D - (F22/ 23/ 45/ 46) - (2014-2017) - 3 SERIES - 218D, 220D, 225D - (F30/31/34) - (2015-2017) - 4 SERIES - 316D/320D/325D - (F32, 33, 36) - (2015-2017) - 5 SERIES - 420D, 425D, 418D - (F10, 11) - (2014-2017) - X1 SERIES - 518D - (F48) - (2015-2017) - X3 SERIES - (F25) - (2014-2017) - EFFICIENT DYNAMICS - X4 SERIES - (F26) - (2014-2017) - XDRIVE - X5 SERIES - (F15) - (2015-2017) - SDRIVE MINI - CLUBMAN - (F54) - (2015-2017) - ONE D CONVERTIBLE - (F57) - (2016-2017) - COOPER D/ SD MINI HATCH (F55, 56) - (2014-2017)</p>
INSTRUMENTE OEM	114120 (1), 2347904 (2), 2365488 (3), 2288380 (4), 118760 (5), 118740, 118030 (6)
CODURILE DE MOTOR	<p>1.5: B37 D15A, B37 C15A 2.0: B47 D20A, B47 D20B, B47 C20A, B47, B47 C20B</p>

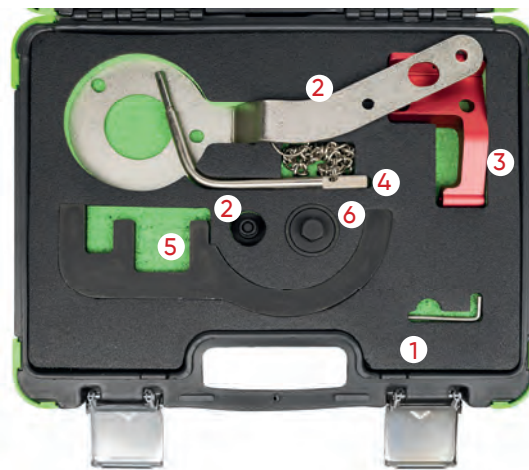

GASEȘTE UȘOR KITUL TĂU DE DISTRIBUȚIE

INTRODUCEȚI ÎN BROWSERUL WEB CODUL DE SCULE OEM SAU CODUL DE MOTOR AL MAȘINII DUMNEAVOASTRĂ ȘI GĂSIȚI KITUL DE DISTRIBUȚIE COMPATIBIL

54219

60,00€

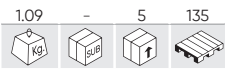

SET INSTRUMENTE DE REGLARE A MOTOARELOR PENTRU BMW/MINI/CITROËN/PEUGEOT

MĂRCI	BMW MINI PSA
INSTRUMENTE OEM	115140 (1), 119280 (2), 119330 (3), 113340 (4), 114360 (5)
CODURILE DE MOTOR	BMW 1.6 (N40 / N45 / N45T, B16, B16A, B16AC) 1.8 / 2.0 (N42 / N46 / N46T) 2.0 / 3.0 (N51 / N52 / N52-COMPONENTE / N53 / N54) PSA 1.4 / 1.6 16V (EP3 / EP6 / EP6DT / EP6DTS) MINI 1.4 / 1.6 (N12 / N14)



54222

59,00€

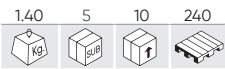

INSTRUMENT DE REGLARE MOTOR PENTRU MINI 1.6

MĂRCI	BMW: MINI COOPER S(07-10) PEUGEOT: 207(06-10), 307(06-10), GT(06-10), THP(06-10), GTI(06-10) CITROËN: DS3(06-10), C4(06-10), GRANDE PICASSO TPH(06-10)
INSTRUMENTE OEM	119550(1), 119551(2), 119552(3), 119590(4)
CODURILE DE MOTOR	N14 B16A , N14 B16CD , N14 B16TO

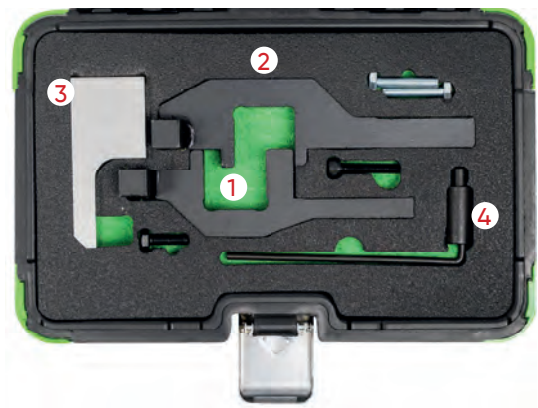

54227

122,00€



INSTRUMENT DE REGLARE MOTOR PENTRU BMW/MINI N13, N18, PSA

INSTRUMENTE OEM	EN-52127-2, EN-52588, E1 100, G 1376A, T10550/2, T10550/3, 0 496 709, 0109 2B, 0197 A11, 0197 A3, 0197 A31, 0197-A1, 0197-A1Z, 0197-A11, 0197A2, 0197-A31, 0197-A32, 0197-A33, 0197-BZ, 0197-M, 0197-N, 11 7 440 (1), 11 9 340 (2), 11 9 540, 11 9 551, 11 9 590, 1376-A, 2 299 362 (3)
CODURILE DE MOTOR	N12 B14A, N13 B16A, N14 B16A, N14 B16C, N16 B16A, N18 B16A, N18 B16C, 5FA (EP6CDT), 5FD (EP6DTS), 5FE (EP6CDT), 5FE (EP6CDTM), 5FF (EP6DTS), 5FG (EP6CDTR), 5FH (EP6C), 5FK (EP6C), 5FK (EP6CB), 5FL (EP6C), 5FM (EP6CDTM), 5FN (EP6CDT), 5FP (EP6), 5FR (EP6DTE), 5FS (EP6C), 5FT (EP6DT), 5FU (EP6CDTX), 5FV (EP6CDT), 5FW (EP6), 5FX (EP6DT), 5FY (EP6DTS), 5GF (EP6FADTX), 5GF (EP6FADTXD), 5GG (EP6FADTX), 5GM (EP6FDTX), 5GN (EP6FDTR), 5GP (EP6FDTR), 5GR (EP6FDTX), 5GT (EP6FDTX), 5GW (EP6FDT), 5GY (EP6FADTXD), 5GY (EP6FDT), 5GY (EP6FDTM), 5GZ (EP6FDT), 8FN (EP3C), 8FP (EP3C), 8FR (EP3C), 8FS (EP3)



54228

187,00€



SET INSTRUMENTE DE REGLARE A MOTOARELOR PENTRU BMW/MINI 1.2, 1.5, 2.0, 3.0

MĂRCI	BMW: 1 SERIES (2015 - 2019), 2 SERIES (DESDE 2014), 3 SERIES (DESDE 2015), 4 SERIES (DESDE 2015), 5 SERIES (DESDE 2017), 6 SERIES (DESDE 2017), 7 SERIES (DESDE 2015), I8 (DESDE 2014), X1 (DESDE 2015), X2 (DESDE 2018), X3 (DESDE 2017), X4 (DESDE 2018) AND Z4 (DESDE 2019); MINI: CLUBMAN (DESDE 2015), HATCH (DESDE 2014), CONVERTIBLE (DESDE 2016) AND COUNTRYMAN (DESDE 2017)
INSTRUMENTE OEM	2 358 122 (1), 2 357 904 (2), 2 365 488 (3), 2 288 380 (4), 11 4 120 (5).
CODURILE DE MOTOR	BMW: 1,5 B38 A15A, B38 B15A, B38 K15A ,1,6 B48 B16A, 2,0 B48 A20A, B48 A20B, B48 A20E, B48 B20A, B48 B20B , 3,0 B58 B30A, B58 B30B, B58 B30C MINI: 1,2 B38 A12A , 1,5 B36 A15A, B38 A15A , 2,0 B46 B20A, B48 A20A, B48 A20B



54293

17,50€



SUPORT PENTRU ARBORELE COTIT PENTRU BMW

MĂRCI	BMW 1 SERIES E81/82/87/88: 116D (2008-2012),118D (2007-2012),120D (2007-2014), 123D (2007-2014) BMW 1 SERIES E22: 218D (2011-2014), 220D (2011-2014), 225D (2011-2014) BMW 3 SERIES E90/91/92/93: 316D (2007-2012), 318D (2007-2014),320D (2007-2012), 325D (2010-2012), 330D (2008-2014) BMW 5 SERIES E60/61: 520D (2007-2010) BMW 5 SERIES F10/11: 525D (2010-2013), 530D (2010-2013),530D XDRIVE (2011-2015), 535D (2010-2013), 535D XDRIVE (2011-2015),M550D XDRIVE (2012-2015) BMW 5 SERIES F07: 535D GT (2009-2015) BMW 7 SERIES F01/02/04: 730D (2008-2012), 740D (2009-2012),750D XDRIVE (2012-2015) BMW X1 E84: 18D SDRIVE (2009-2015), 20D SDRIVE (2009-2015), 18D XDRIVE (2009-2015), 20D XDRIVE (2009-2015), 23D XDRIVE (2009-2012) BMW X3 E83: 2.0D (2007-2008), 18D XDRIVE (2008-2010) BMW X5 E70: 3.0D XDRIVE (2010-2013), 40D (2010-2013) BMW X6 E71/71: 30D XDRIVE (2010-2014), 40D XDRIVE (2010-2014)
INSTRUMENTE OEM	T10016
CODURILE DE MOTOR	2,0: N47D20C, N47D20D 2,0D: N47, D20A, D20A/KO, D20B, D20B/TO, D20C,D20O0, D20O1, D20U0, D20U1 D20K1 3,0D: N57, D30U0, D30O0, D30O1, D30T0, D20T0,D30A, D30A/O0, D30B , D30B/T1, D30C, D30C/ S1,D30A0/O0, D30A0/O1



54398

41,00€



SET DE BLOCARE A VOLANTULUI / SCRIPETELUI ARBORELUI COTIT PENTRU BMW/MINI

MĂRCI	MINI HATCH (14-21), CABRIOLET (16-19), CLUBMAN (15-19), COUNTRYMAN (17-19)
INSTRUMENTE OEM	11 6 480 (1) 11 9265 (2) 11 4 180 (3) 11 9 810 (4) 11 9 811 (4)
CODURILE DE MOTOR	BMW: 116i (15-19), 116d (15-19), 118d (15-19), 120d (15-19), 125d (15-19), M140i (16-19), 214d (15-19), 216i (18-19), 216d (14-20), 218d (17-19), 218i (15-21), 220d, (14-20), 225d (15-20), M240i (16-19), 316d (15-19), 318i (15-19), 320d (15-19), X1 (15-20),X2 (18-19), X3 (14-18), X4 (17-20), X5 (15-18), i8 (14-18) 325d (16-20),330i (15-20), 340i (15-19), 418i (15-20), 420d (15-20), 425d (16-18), 430i (16-20),440i (16-19), 518d (14-17), 525d (17-20), 530i (17-18), 540i (17-19), 620d (18-20), 630i (17-19), 640i (17-19), 725d (16-19), 730i, (15-19), 740i (15-19)



54399

56,50€

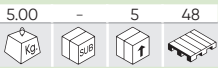

N

INSTRUMENT DE SINCRONIZARE PENTRU BMW/ROVER/OPEL 2.5D

MĂRCI	BMW: 318TDS (94-00) , 325TD (91-99) , 325TDS (91-99) , 525TD (90-03) , 525TDS (90-03) , 725TDS (95-02) RANGE ROVER: P38 (94-02) VAUXHALL/OPEL: OMEGA-B (94-01)
INSTRUMENTE OEM	KM811 (1), 113320 (1), 12112 (1) KM822 (2), 113360 (2), 12115 (2) KM813 (3), 115120 (3), 112300 (3), 12108 (3) KM823 (4), 113340 (4), 12172 (4)
CODURILE DE MOTOR	256T, 25DT, M41/174T1, M51/256T1, M51/256T1L, X25DT

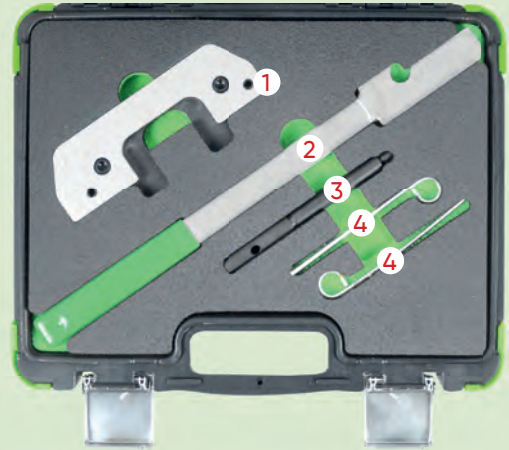

54400

141,00€

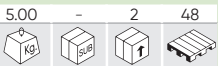

N

INSTRUMENT DE SINCRONIZARE PENTRU BMW N20, N26

MĂRCI	BMW: 1 SERIES 125I - F20/21 (2012-2016) 2 SERIES COUPE 220I, 228I - F22 (2014-2016) 2 SERIES CABRIOLET 220I 228I - F23 (2015-2016) 3 SERIES 320I 328I XDRIVE - F30/31 (2012-2015) 3 SERIES GRAN TURISMO 320I, 328I/XDRIVE - F34 (2013-2016) X4 XDRIVE 20I, 28I (F26) 2014 - 2018, X5 XDRIVE40E (F15) 2015 - 2018, Z4 SDRIVE18I, 20I, 28I (E89) 2011 - 2017 4 SERIES COUPE 420I, 428I/XDRIVE - F32(2013-2016), 4 SERIES CABRIOLET 420I, 428I/XDRIVE-F33 (2014-2016) 4 SERIES GRAN COUPE 420I, 428I/XDRIVE F36 (2014-2016) 5 SERIES 520I, 528I/XDRIVE(F10/11) 2010 - 2017, 5 SERIES GRAN TURISMO 528I-(F07) 2013 - 2016, X1 SDRIVE16I, 18I, 20I, XDRIVE20I, 28I-(E84) 2011 - 2015, X3 SDRIVE18I, 20I, XDRIVE20I, 28I (F25) 2011 - 2017
INSTRUMENTE OEM	11 9 340/341 (1), 11 9 340A (1), 11 9 341 (1), 119340 (1) 2 212 830 (2) 2 212 831 (3) 2 219 548 (4)
CODURILE DE MOTOR	1,6 N20 B16A 2,0 N20 B20 N20 B20A N20 B20A N20 B20B N20 N20B/UO N20 B2000 N20 B2000 N26 B20 B26 B20A

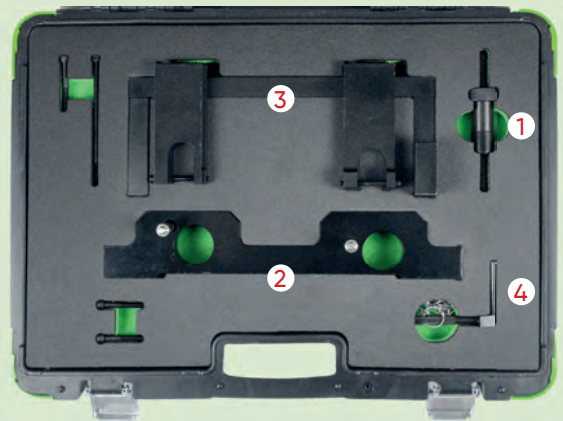

54401

57,00€



N

INSTRUMENT DE SINCRONIZARE PENTRU BMW/MINI N13, N18

MĂRCI	BMW 114i (2012-2015) BMW 116i (2012-2015) BMW 118i (2011-2015) BMW 316i (2012-2015) MINI CLUBMAN (R55) (2011-2014) MINI COOPER S (R56/57) (2010-2015) MINI COUNTRYMAN (R60) (2012-2016) MINI COUPE COOPER S (R58) (2012-2015) MINI PACEMAN (R61) (2013-2017) MINI ROADSTER (R59) (2012-2015)
INSTRUMENTE OEM	11 7 440 (1), 117440 (2), 11 9 340 (3), 11 9 590 (4), 49 6 709 (5)
CODURILE DE MOTOR	N13 B16A N18 B16A N18 B16/MO N18B16A/MO N18B16C N18B16C/TO N18B16MO

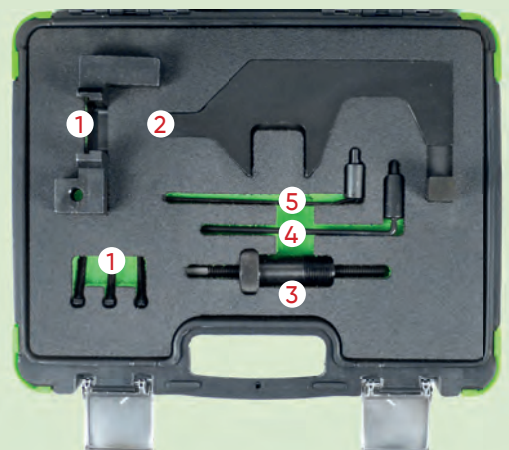

INSTRUMENTE DE SINCRONIZARE

54402

201,00€



N

INSTRUMENT DE SINCRONIZARE PENTRU BMW N51, N52, N53, N54, N55

MĂRCI	E60: 523I, 523LI, 525I, 525LI, 525XI, 528I, 528XI, 530I, 530LI, 530XI, 535I, 535XI E61/E63: 523I, 525I, 525XI, 530I, 530XI, 535XI, 630I E64/E65: 630I, 730I E66/E70: 730LI, X5 3.0SI E81/E82: 130I, 135IS E83: X3 2.5I, 2.5SI, 3.0I, 3.0SI E85/E86: Z4 2.5I, 2.5SI, 3.0I, 3.0SI, Z4 3.0SI E87/E90: 130I, 323I, 325I, 325XI, 328I, 328XI, 330I, 330XI, 335I, 335XI E91: 323I, 325I, 325XI, 328I, 328XI, 330I, 330XI, 335I, 335XI E92: 323I, 325I, 325XI, 328I, 328XI, 330I, 330XI, 335I E93: 325I, 328I, 330I, 335I
INSTRUMENTE OEM	110300 (1) 114280 (2) 114285 (3) 114290 (4) 114390 (5) 118520 (6) 119190 (7) 119340 (8)
CODURILE DE MOTOR	N51/N52/N53/N54/N55

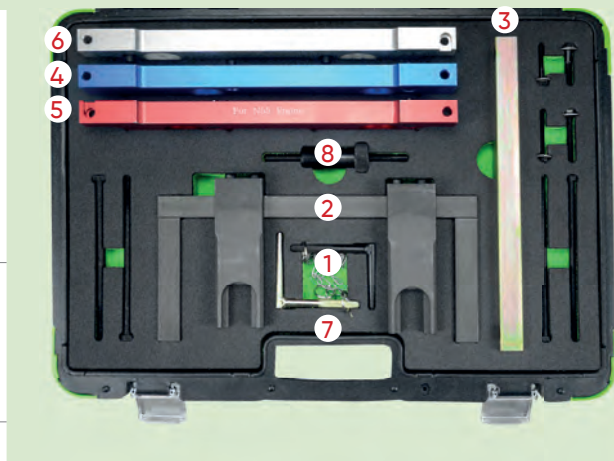

54403

225,00€



N

INSTRUMENT DE SINCRONIZARE PENTRU BMW M60

MĂRCI	BMW 5 SERIES: 530I, 540I (E34) (1992 – 1996), 535I, 540I (E39) (1996 – 2003) BMW 7 SERIES: 730I, 735I, 740I (E38) (1994 – 2002), 730I, 740I (E32) (1992 – 1994) BMW 8 SERIES: 840I (E31) (1993 – 1999) LAND ROVER/RANGE ROVER: (L322) (2002 – 2005) X5: 4.4, 4.6 (E53) (1999 – 2004)
INSTRUMENTE OEM	11 2 445 (1), 11 2 441/445 (1), LRT -12 223/2 (1) 11 2 441 (2), 12 223/1 (2), LRT 12-223/1 (2) 11 2 442 (3), 11 2 442/446 (3), 12 223/3 (3), LRT 12 223/3 (3) 11 2 446 (4), 12 223/4 (4), LRT 12 223/4 (4), LRT 12 224 (4) 11 3 390 (5), 113390/117380 (5), 12 222 (5), LRT 12 222 (5) 11 5 180 (6), 12 227 (6), LRT 12 227 (6) 11 2 300 (7), 11 5 120 (7), 12 108 (7), 12 171 (7), KM 813 (7), LRT 12 108 (7), LRT 12 171 (7) 11 6 420 (8), 12 226 (8), LRT 12 226 (8) 11 6 452 (9), 12 228/1 (9), LRT 12 228/1 (9) 11 6 451 (10), 12 228/2 (10), LRT 12 228/2 (10) 11 3 310 (11), 12 220 (11), LRT 12 220 (11) 11 6 440 (12), 12 224 (12), LRT 12 2214 (12) 11 7 380 (13), 12 221 (13), LRT 12 221 (13)
CODURILE DE MOTOR	BMW 3.0: 30 8S 1 BMW 3.5: 35 8S 1, 35 8S 2 BMW 4.0: 40 8S 1 BMW 4.4: 44 8S 1, 44 8S 2 BMW 4.6: 46 8S 1 RANGE ROVER: V8/44 8S 2



54404

131,00€



N

INSTRUMENT DE SINCRONIZARE PENTRU BMW N62, N73

MĂRCI	SERIES 5, SERIES 6, SERIES 7, X5
INSTRUMENTE OEM	119461 (1), 119462 (2), 119463 (3), 119190 (4), 119340 (5), 119451 (6), 119452 (7), 119453 (8), 119454 (9), 113460 (10), B117207 (11)
CODURILE DE MOTOR	N62 B36A, N62 B40A, N62 B44A, N62 B48A, N62 B48B, N73 B60A

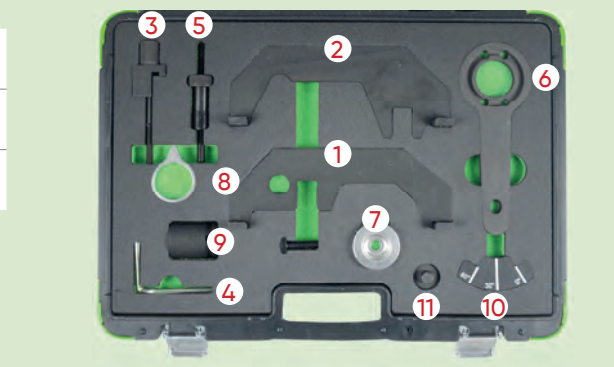

54405

111,00€

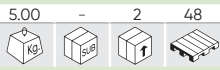

N

INSTRUMENT DE SINCRONIZARE PENTRU BMW N63, N74

MĂRCI	SERIES 5, SERIES 6, SERIES 7, X5, X6
INSTRUMENTE OEM	11 9 891 (1) 11 9 892 (1) 11 9 893 (2) 11 9 190 (3) 11 8 090 (4)
CODURILE DE MOTOR	N63, N74

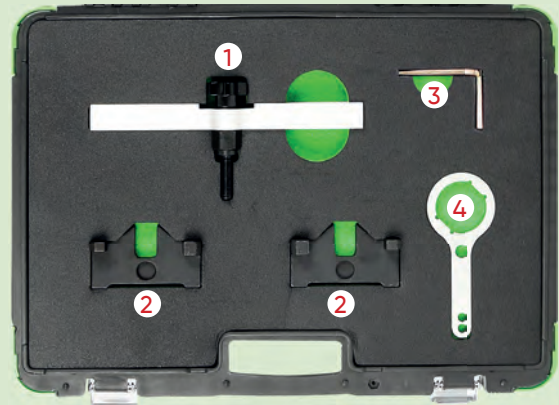

54406

73,00€



N

BLOCATOR VOLAN MOTOR BMW/MINI

MĂRCI	<p>BMW 1 SERIES: F20/21 (12-15), 116i (04-12), 118i (04-14), 120i (04-14), 130i (05-07), 135i (07-11), 116D (08-12), 118D (04-14), 120D (04-14), 123D (07-14), M COUPE (11-12)</p> <p>BMW 3 SERIES: F30/31 (12-15), 316Ti (04-14), 316i (04-11), 316D (09-12), 318i (04-07), 318Ti/COMPACT (04-04)</p> <p>BMW 3 SERIES: 318D (03-12), 318TD (03-07), 320D (01-07), 320D COMPACT (01-05), 318i (05-13), 320D (07-14), 320i (05-14), (05-14), 320Si(05-06)</p> <p>BMW 3 SERIES: 323i (05-11), 325i (05-14), 325D (06-10), 330D (05-08), 330i (06-13), 335D (05-13), 335i (05-11)</p> <p>BMW 4 SERIES: 420i F32 (13-15), 428i F32 (13-15), 420i F33 CABRIOLET (14-15), 428i F33 CABRIOLET (14-15), 420i F36 (14-15), 428i F36 GRAN COUPE (14-15)</p> <p>BMW 5 SERIES: F10/11 (10-15), 520D (05-10), 520i (07-10) 523i (03-10), 525D (05-10), 525i (05-10), 525i (07-10), 530D (03-10), 530i (05-10), 535D (04-10)</p> <p>BMW 6 SERIES: 630i (04-11), 635D (07-11)</p> <p>BMW 7 SERIES: 730D (05-08), 730i (02-08) BMW X SERIES: X1 E84 (09-15), X3 E83 (03-14), X5 E53 (03-14), X3 F25 (11-15), X6 E71/72 (08-10)</p> <p>BMW Z SERIES: Z4 E85/86 (04-09), Z4 (E89) (11-15)</p> <p>MINI: MINI (03-06)</p>
INSTRUMENTE OEM	11 8 180 (1), 11 8 181 (2), 11 8 182 (3), 11 8 183 (4), 11 8 184 (5), 11 8 185 (6)
CODURILE DE MOTOR	BMW: M47T2, M57T2, M67, N43, N45, N45T, N46, N46T, N47, N51, N52, N53, N54 MINI: W17 DIESEL



54324

11,00€



N

INDICATOR DE UZARE A LANȚULUI DE DISTRIBUȚIE MINI

MĂRCI	MINI: CLUBMAN (2007-2014), CLUBVAN (2012-2014), COUNTRYMAN (2010-2017), COUPÉ (2011-2015), MINI (2006-2015), PACEMAN (2013-2017), ROADSTAR (2012-2015)
INSTRUMENTE OEM	2353281 (1)
CODURILE DE MOTOR	1.4: N12 B14AB, N12 B14 1.6: N12 B16A, N16 B16A, N16 B16M0, N16 B16U0, N16 B16A/MO, N16 B16KO, N16 B16A/MO, N18 B16A, N18 B16A/MO, N18 B16C, N18 B16A/MO, N18, N18 B16M0, N18 B16C/T0



53268

92,00€

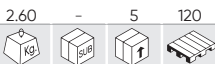

KIT DISTRIBUȚIE PE LANȚ BMW/MINI/PSA 1.4, 1.6

MĂRCI	BMW/MINI: MINI CLUBVAN R55 (12-14), MINI CLUBMAN R55 (08-14), MINI COUNTRYMAN R55 (07-10), MINI CLUBMAN R56/R57 (07-15), MINI R56/R57 (08-15), MINI COUPE R58 (11-15), MINI ROADSTER R59 (08-15), MINI CLUBMAN R60 (10-14), MINI CLUBVAN R60 (12-14), MINI ROADSTER R61 (13-15), MINI PACEMAN R61 (14-15), MINI COUNTRYMAN R60 (10-17). CITROËN: C4 (08-11), C4 PICASSO (08-13) C4 GRAND PICASSO (13-15). PEUGEOT: 207 (06-14), 207CC (07-15), 308 (07-15), 3008 (09-15), 5008 (09-15).
INSTRUMENTE OEM	BMW/MINI: 115590 (1), 119340 (2), 119551 (3) CITROËN: 0197-A1, 0197-A3, 0197-B. PEUGEOT: 0197-A1, 0197-A3, 0197-BZ.
CODURILE DE MOTOR	1.4: N12B14, N14B14AB. 1.6: EP3(8FS), EP3C(8FR), EP6(5FW), EP6C(5FS), EP6CDT(5FV), EP6DT(5FT), EP6DT(5FX), EP6DTS(5FY), N14B16A, N14B16CD, N14B16TO, N14B16CD/TO, N16B16A, N16B16KO, N16B16A/MO, N16B16A/MO, N16B16M0, N16B16U0.



53313

139,00€



KIT DISTRIBUȚIE PE LANȚ CITROEN/PEUGEOT

MĂRCI	CITROËN: AX, BX, BOXER, BERLINGO, C25, DISPATCH, EVASION, J5, JUMPY, JUMPER, RELAY, SAXO, SYNERGIE, VISA, XM, XSARA, XANTIA, XZ, ZX. PEUGEOT: 106, 205, 206, 305, 306, 307, 309, 405, 406, 605, 607, 806, EXPERT, PARTNER, SOLARA, TALBOT.
INSTRUMENTE OEM	7099TM (1), 0188X (2), 0188P (3), 0189AZ (4), 0188H (5), 0132AJ1 (6), 0189A (7), 0188PM (8), 21-260 (9), 4527-TS1 (10), M8X70 (11), 0188K (12), 0188J (13), 0132Q (14), 4507-TL (15), 4507-TJ (16), 9044-T (17), 4507-TJ (18), 5711-TA (19), 7014-TJ (20), 7017-TR (21), 0188X (22), 7017-TW (23), 7014-TM (24), 0189L (25)

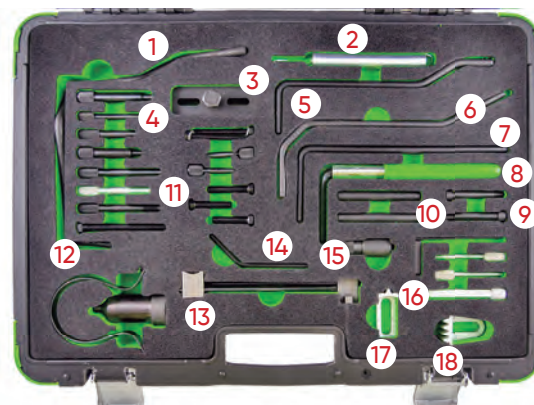

53314

98,00€



KIT DISTRIBUȚIE PE LANȚ CITROEN/PEUGEOT 1.8, 2.0

MĂRCI	CITROËN: C4 PICASSO/GRAND PICASSO (06-10), C5 II (04-08), C8 (05-10), DISPATCH/JUMPY (07-11), XSARA 2.0 16V, C5 1.8/2.0/HPI, XSARA PICASSO 1.8/2.0 16V (02-05). PEUGEOT: 406 1.8 16V (00-04), 407 (06-10), 807 2.0 16V (02-05).
INSTRUMENTE OEM	0189S2 (1), 0188J (2), 0188J2 (2), 0189S1 (3), 21-260 (4), 0189B (5), 0188M (6), 0188AH (7), 0189R (8)
CODURILE DE MOTOR	1.8 16V: EW7A(6FY). 2.0 16V: EW10A(RFJ), EW10ABE4(RFH), EW10J4S (RFK).

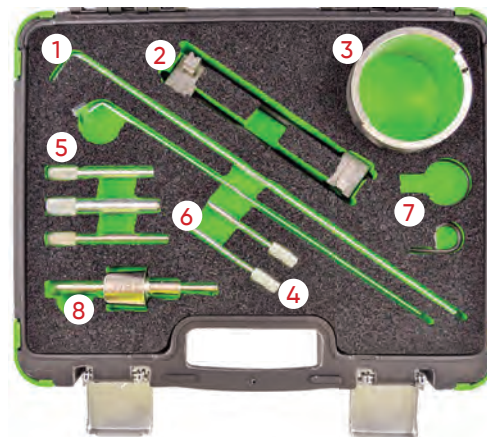

53876

64,00€

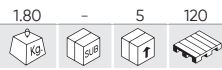

KIT DISTRIBUȚIE PE LANȚ CITROËN/PEUGEOT 1.0, 1.2 VTI

MĂRCI	CITROËN: C3 (III) PEUGEOT: 208, 308, 2008 SUV (2012-2014)
INSTRUMENTE OEM	0109-2A (1) 0109-2B (2)
CODURILE DE MOTOR	1.0/1.2 VTI. EBO, (ZMZ), EB2, (HMZ)



54288

72,50€

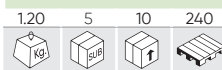

N

INSTRUMENT DE SINCRONIZARE PENTRU PSA 1.2 GDI PURETECH

MĂRCI	CITROËN: BERLINGO IV (18-20), C1 II (14-18), C3 III (12-17), C3 IV (16-18), C4 CACTUS (14-20), C4 AIRCROSS (18-20), C-ELYSEE (12-18), DS3 (12-18) PEUGEOT: 108 (14-18), 208 (12-21), 2008 (13-21), 301 (12-20), 308 (13-21), 3008 (16-21), 508 (19-21), 5008 (14-21), PARTNER III (15-18) PARTNER IV (18-21) RIFTER (19-21) TOYOTA: AYGO (14-18) GM: CROSSLAND X (17-20), COMBO E (18-20), GRANDLAND X (17-20)
INSTRUMENTE OEM	CITROËN: G-0109-6 (2), 0109-2B (1), 0109-2C (3), 0109-2D (4), 0197-N (1) PEUGEOT: G-0109-6 (2), 0109-2B (1), 0109-2C (1), 0109-2D (4), 0197-N (1) VAUXHALL: EN-52127-2 (1), EN-52809 (2)
CODURILE DE MOTOR	1.2 VTI: 1PP(HM01), EB2 (HMZ), EB2DTS(HNY), EB2 (HMW), EB2M (HMY), EB2 (HMZ), EB-2DTS(HNY), HMP (EB2FB), HMT(EB2D), HMU(EB2D),HMV (EB2M), HMY (EB2M), HMZ (EB2), HMZ (EB2D), HMZ (EB2F),HMZ (EB2FB) 1.2 E-VTI: HMZ (EB2F), EB2F (HMZ) 1.2 PURETECH THP: HNZ (EB2DT) 1.2 PURETECH VTI: EB2ADS (HNS), EB2D(HMT), EB2ADJ (HNP),EB2ADT (HNK), EB2ADTX (HNN), EB2DTS (HNW), EB2DTM (HNW),EB2DTSM (HNW), EB2FA (HMR), EB2FAD (HMH), EB-2FAD (HMM),EB2DT (HNZ), EB2F (HMX), EB2F (HMT), EB2F(HMZ), EB2DTS(HNY),EB2M(HMY)



REF. DESCRIERE

16400 PSA CALIBRU DE VERIFICARE CUREA DE TRANSMISIE (REF. 54288)

0.03 10 500 6,50€

54323

119,00€

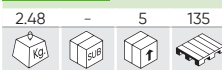

N

KIT DISTRIBUȚIE PE LANȚ PSA 1.0, 1.2 VTI, 1.2 GDI PURETECH

MĂRCI	CITROËN: C1 II (2014-2018), C3 III (2012-2017), C3 IV (2016-2018), C4 CACTUS (2014-2020), C4 AIRCROSS (2018-2020), C-ELYSEE (2012-2018), DS3 (2012-2018), BERLINGO IV (2018-2020), GM: CROSSLAND X (2017-2020), COMBO E (2018-2020), GRANDLAND X (2017-2020) PEUGEOT: 108 (2014-2018), 208 (2012-2021), 2008 (2013-2021), 301 (2012-2020), 308 (2013-2021), 3008 (2016-2021), 508 (2019-2021), 5008 (2014-2021), PARTNER III (2015-2018), PARTNER IV (2018-2021), RIFTER (2019-2021) TOYOTA: AYGO (2014-2018).
INSTRUMENTE OEM	EN-52127-2 (1), 0109-2B (1) J-0109-2C (2) J-0109-2D (3) EN-52127-1 (4), 0109-2A21 (4) G-0109-6 (5)
CODURILE DE MOTOR	B12XHL (EB2DT), B12XHT (EB2DTS), D12XHL (EB2ADT), D12XHL (HNP/EB2ADT), D12X-HT (EB2ADTS), EBO (ZMZ), EBOF (ZMZ), EB2ADT (HNK), EB2ADT (HNP), EB2ADTD (HNK), EB2ADTS (HNS), EB2ADTX (HNN), EB2DT (HNZ), EB2DTM (HNW), EB2DTS (HNW), EB2DTS (HNY), EB2DTSM (HNW), EB2FA, EB2FAD, F12XHT (EB2ADTS), F12XHT (HNS/EB2ADTS), HMM (EB2FAD), HMM (EB2FAD), HMP (EB2FB), HMR (EB2FA), HMT (EB2), HMT (EB2F), HMU (EB2D), HMU (EB2FD), HMV (EB2M), HMW (EB2), HMX (EB2F), HMY (EB2M), HMZ (EB2), HMZ (EB2F), HNJ (EB2ADTXM), HNK (EB2ADT), HNK (EB2ADTD), HNK/EB2ADTD, HNL (EB2ADTSM), HNN (EB2ADTX), HNP (EB2ADT), HNS (EB2ADTS), HNS/EB2ADTS, HNT (EB2ADTS), HNV (EB2DT), HNV (EB2DTM), HNW (EB2DTS), HNW (EB2DTSM), HNX (EB2DT), HNX (EB2DTS), HNY (EB2DTS), HNZ (EB2DT), HN02, ZMZ (EBO), ZMZ (EBOF), 1PP (HM01)

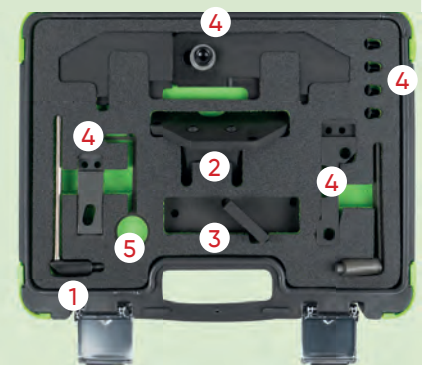

54213

19,80€

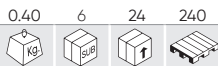

SET INSTRUMENTE DE REGLARE A MOTOARELOR PENTRU ROVER/PEUGEOT/FORD/VOLVO 2.0, 2.2L D

MĂRCI	PEUGEOT: 807 (05-11), 407 (05-11), 607 (05-09).CITROËN: C4 (04-10), C5 II (04-10). LAND ROVER: FREELANDER (06-10). VOLVO: S40 (03-10), V50 (06-10), C70 (06-10), S80 (07-10), C30 906-10), V70 (07-10).FORD: S MAX 2.2 (08-10), GALAXY 2.2 (08-10), MONDEO 2.2, 2.0 (07-10).
INSTRUMENTE OEM	PSA 0188.M, FORD 303-735, 303-1277, VOLVO 999-7122 (1) PSA 0188.X, FORD 303-1059, 303-1270, VOLVO 999-7121 (2) PSA 0188.F, FORD 303-393A, 303-393-01, 303-1272, VOLVO 999-7119/7120 (3)
CODURILE DE MOTOR	PEUGEOT: DW10UTED4 (RHK), DW10BTED4 (RHR)DW12B-TED4 (4HS), (4HP), (4HT), (4HR). CITROËN: DW10BTED4 (RHR). LAND ROVER:DW12BTED4, 224DT. VOLVO:D420T 2.0D. FORD: QXBA(2.2), QXWA(2.0), QXBB(2.0),Q4BA(2.2), QXWA(2.0), QXWB(2.0), AZBA(2.0), AZBC(2.0), AZWA(2.0)

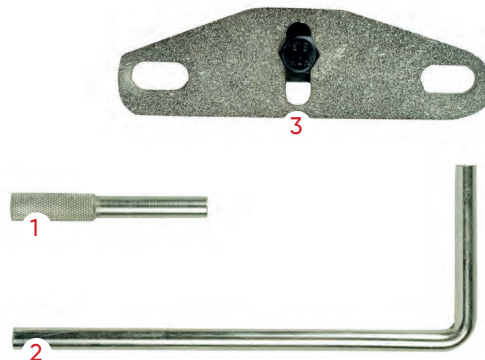

54432

43,00€



INSTRUMENT DE SINCRONIZARE PENTRU PSA 2.7, 3.0 HDI

MĂRCI	CITROËN C6 JAGUAR S-TYPE (X200) 2004 - 2008, XF S (X250) 2008 - 2015, XF S (X260) 2015 - 2020, XJ6 TDV1 (X350/358) 2005 - 2010, XJ (X351) 2010 - 2020, F-PACE S 30D (X761) 2016 - 2020 LAND ROVER: DISCOVERY 3 TDV6 (L319) 2004 - 2009, DISCOVERY 4/DISCOVERY SDV6, TDV6 (L319) 2009 - 2017, DISCOVERY SD6, TD6 (L462) 2017 - 2021, RANGE ROVER SDV6, SDV6 HYBRID, TDV6 (L405) 2012 - 2021, RANGE ROVER SPORT SDV6, TDV6 (L320) 2005 - 2013 PEUGEOT 407, 607 COUPE RANGE ROVER VELAR D275, D300 (L560) 2017 - 2021, RANGE ROVER SPORT SDV6, SDV6 HYBRID, TDV6 (L494) 2013 - 2021
INSTRUMENTE OEM	303 11117 (1), 303 11116 (2), 303 1132 (3), 303 1126 (4), 0195H (4), 0195C (5), 0195K (6), 0188-K (7)
CODURILE DE MOTOR	2.7: DT17 TED4 (UHZ), DT17BTED4 (UHZ) 3.0: DT20C (X8C/X8Z), DT20CTED4 (X8Z)

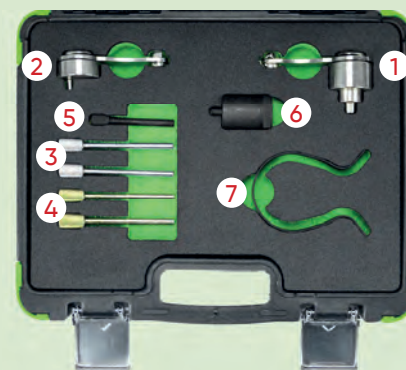

54433

18,00€



INSTRUMENT DE SINCRONIZARE PENTRU PSA 1.0, 1.1, 1.2, 1.4, 1.6, 2.0

MĂRCI	CITROËN BERLINGO 2008 - 2011, C2 2003 - 2010, C-ELYSEE 2012 - 2016, C3 PLURIEL 2003 - 2010, C4 2004 - 2011, NEMO 2008 - 2015, XSARA 2000 - 2005 PEUGEOT 106 1998 - 2003, 206 1998 - 2009, 207 2006 - 2013, 306 1998 - 2003, 307 2000 - 2008, 1007 2005 - 2010, PARTNER 1998 - 2011, BIPPER 2008 - 2015
INSTRUMENTE OEM	0132QY (1), 4507 TA (1), 0132AK (2), 0153AK (2), 0188K (2), 0189K (2), 1870 900 100 (2), 4533 TAD (2), MOT 1436 (2) 3MM PIN (3), 0132AB (4), 0178D (4), 0194A (4), 77440010400 (4), 1860.617000 (4), 11 9 790 (4), 21-260 (4), 303-732 (4), 4527 TS2 (4), 49 JEO2 018 (4), 5711 TD (4), 99360608 (4), 999 7169 (4), KM-6349 (4), 0132AJ1 (5), 0187B (5), 0189B (5), 0194B (5), 09919 58120 (5), 21 263 (5), 303 735 (5), 3031277 (5), 49 JEO2 021 (5), 607589011500 (5), 8MM DRILL BIT (5), 8MM PIN (5), 999 7122 (5), EN-52137 (5), MOT. 1430 (5), MOT 1430 (5), 0123-RZ (6), 0132R (6), 0153AA (6), 0153AB (6), 0153G (6), 0153ZY (6), 10MM PIN (6), 4507 TB (6), 7014 TN, 9767 27 (6), M10 X 70MM (6), 0132Q (7), 0132QZ (7), 132Z (7), 4507 TA (7)
CODURILE DE MOTOR	1.0: TU9 (C1A), TU9/K (C1A), TU9M (CDY/CDZ), TU9MZ (CDY/CDZ), TU9M/L (CDZ), TU9M/L3 (CDY) 1.1: TU1A (HFV/HFX), TU1JP (HFV/HFY/HFZ), TU1JP/L4 (HFX), TU1/K (H1A), TU1M (HDZ), TU1M/L (HDZ), TU1M/L3 (HDY/HDZ), TU1M/Z (HDZ), TU1M+ (HDY/HDZ) 1.4: ET3J4 (KFU), ET3JP4 (KFU), TU3A (KFT/KFV/KFW), TU3FJ2 (K6B/KFZ), TU3FM (KDY), TU3JP (KFW/KFV/KFX), TU3JP/IFL4 (KFX)TU3JP/L3 (KFX), TU3JP/L4 (KFX), TU3JP/IFL4 (KFX), ET3J4 (KFU), TU3M (KDX), TU3M/Z (KDY) 1.6: ECS5 (NFP), ECS5F (NFP), TU5J2 (NFY/NFW), TU5J4 (NFU), TU5JP (NFT/NFZ), TU5JP/L3 (NFZ), TU5JP/L4 (NFT/NFV), TU5JP4 (NFU), TU5JP4B (NFR), TU5JP4S (NFS), TU5JP4/L3 (NFX), TU5JP4/L4 (NFU/NFX), XU5JP (BFZ) 1.8: XU7JB (LFX), XU7JP (LFW), XU7JP/L3 (LFZ), XU7JP4 (LFY), XU7JP4/L3 (LFY) 2.0: XU10J/C/Z (RFU), (RGX), XU10J2E/V (RGX), XU10J2U (RFL), XU10J4R (RFR/RFV), XU10J4R/L3 (RFV), XU10J4RS/L3 (RFS)

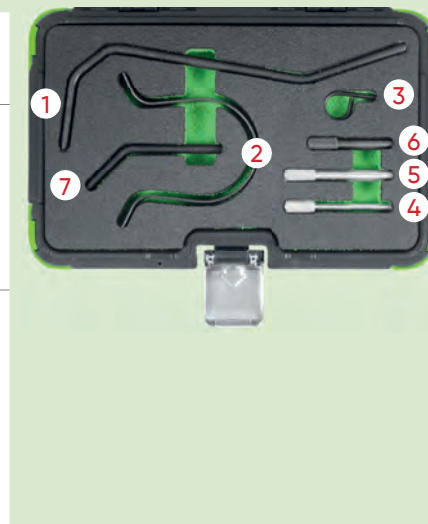

53293

134,00€

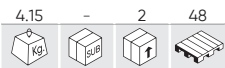

SET DISTRIBUȚIE PE LANȚ FORD

MĂRCI	B-MAX (12-17), C-MAX (07-17), COUGAR (98-01), COURIER (00-02), ESCORT (94-98), FIESTA (95-17), FOCUS (98-17), FOCUS C-MAX (03-07), FUSION (02-12), GALAXY (06-15), GRAND C-MAX (10-17), KUGA (08-15), MAVERICK (01-07), MONDEO (93-15), ORION (94-94), PUMA (97-02), S-MAX (06-15), TOURNEO CONNECT (02-15), TRANSIT (06-11), TRANSIT CONNECT (02-16), ECOSPORT (13-15), TOURNEO COURIER (14-15), GRAND TOURNEO COURIER (13-15).
INSTRUMENTE OEM	303-376 (21-162B) (1), 303-1059 (2), 303-193 (21-104) (3), 303-393-01 (4), 303-1054 (5), 303-1097 (6), 303-748 (7), 303-734 (21-262) (8), 303-651 (21-229) (9), 303-393A (21-168) / 303-393-02 / 303-507 (21-210) / 303-620 (21-163)/ 303-732 (21-260) / 303-735 (21-263).
CODURILE DE MOTOR	PETROL: AODA/B, ASDA, ASDB, CFBA, CGBA/B, CHBA/B, CJBA/B, CSDA/B, DHA, DHB, DHC, DHD, DHE, DHF, DHG, EDBB, EDBD, EDDB, EDDC, EDDD, EDDF, EYDB, EYDC, EYDD, EYDE, EYDF, EYDG, EYDI, EYDJ, EYPA, EYPC, F8JA, F8JB, FHA, FHD, FHE, FHF, FUJA, FUJB, FXDA/C, FXDB/D, FXJA, FXJB, FYDA/C, FYDB/D, FYJA, FYJB, HWDA, HWDB, L1F, L1J, L1L, L1N, L1Q, L1T, L1V, L1W, M7JA, M7JB, MHA, MHB, NGA, NGB, NGC, NGD, QQDA/B/C, QQDB, RKA, RKB, RKF, RKH, RKJ, RKK, HXDA. GASOIL: F6JA, F6JB, F6JC, HHJA, HHJB, G8DA, HHDA, HHDB, RTN, RTQ, RTP, C9DC, BHDA/B, BHPA, C9DA/B, F9DA/B, FFBA, FFDA, HCPA, HCPB, KKDA, P7PA, P9PA, QYWA, R2PA, R3PA, RWPA, G6DA, G6DB, G6DC, AZWA, QXWA.

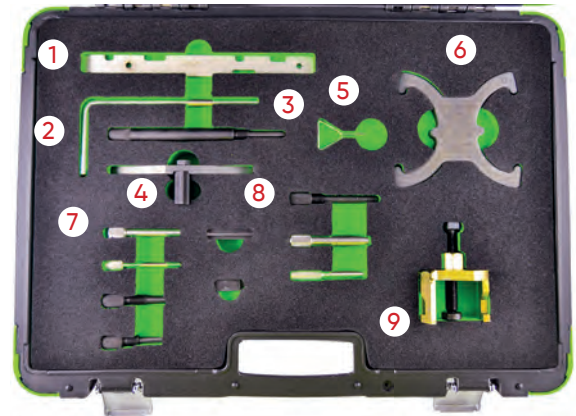

53294

119,00€

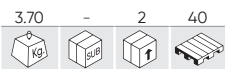

SET DISTRIBUȚIE PE LANȚ FORD MAZDA

MĂRCI	FORD: COURIER (00-02), C-MAX (03-10), FIESTA (02-11), FOCUS (98-11), FUSION (02-11), GALAXY (06-10), KUGA (06-10), MONDEO (07-10), S-MAX (06-10), TOURNEO CONNECT (02-13), TRANSIT CONNECT (02-13) PEUGEOT: BIPPER (08-10) DISPATCH/JUMPY III (07-12) EXPERT III (07-12) NEMO (08-10) PARTNER I/II (05-11) PARTNER III (08-16) 107 (05-10) 1007 (05-10) 206 (01-12) 206+ (09-13) 206 CC (05-07) 207 (06-13) 207 CC (07-15) 208 (11-15) 307 (01-08) 308 (07-15) 308 CC (09-15) 407 (05-11) 508 (04-15) 2008 (13-15) 3008 (09-15) 4008 (12-15) 5008 (09-15). MAZDA: 2 (02-15), 3 (09-14) CITROËN: C1 (05-10), C2 (03-10), C3 I/II (02-10), C3 III (10-15), C3 PLURIEL (04-10), C3 PICASSO (09-12), C4 (04-11), C4 II (11-15), C4 PICASSO (06-12), C4 GRAND PICASSO (10-12), DS3 (09-12), DS4 (11-12), DS5 (12-15), C5 II (04-08), C5 III (04-12), XSARA II (02-04), XSARA PICASSO (04-10)
INSTRUMENTE OEM	FORD: 303-376B (1), 303-193 (2), 303-393 (3), 303-732 (4), 303-651 (5), 303-393/01, 303-1059, 303-734, 303-735, MAZDA: 303-732, 303-734, 303-735. PSA: 0194-A, 0194-C, 0194B.
CODURILE DE MOTOR	1.4D TDCi/Hdi: DV4TD(8HT), DV4TD(8HX), DV4TD(8HZ), DV4TD(8HW), DV4TED4(8HX), DV4TED4(8HV), DV4TED4(8HY), DV4C(8HP), DV4C(8HR), DV4TED(8HS), F6JA, F6JB, F6JC. 1.6D TDCi/HDi: DV6TED4(9HZ), DV6ATED4(9HX), DV6TED4(9HY), DV6DTE4(9HP), DV6C(9HR), DV6CATED(9HX), DV6C(9HL), DV6TED(9HP), DV6ATED(9HY), DV6TED4(9HV), DV6TED4(9HX), DV6C(9HD), DV6C(BHX), DV6C(BHZ), DV6(9HR), DV6BTED4(9HW), DV6DTED(9HJ), DV6ETED(9HN), DV6ATED4BU(9HS), DV6BTED4(9HT), DV6BUTED4(9HT), DV6TED4B(9HV), DV6UTED4(9HX), DV6TED(9HD), DV6UTED4(9HU), DV6D(9HP), DV6TED4(9HV), DV6C (9HD), DV6TED4(9HW), DV6AT(9HX), DV6ATED(9HX), DV6CTED(9HC), DV6AUTED4(9HX), DV6TED4B, DV6DTE4(9HF), HHJA, HHJB, G8DA, G8DB, HHDA, HHDB, MZ-CD, Y6. 1.8D TDCi/HDi: BHPA, C9DA/B, FFBA, G6DA, G6DB, G6DC, HCPA, HCPB, KKDA, P7PA, P9PA, R2PA, R3PA, RWPA. 1.8d: C9DC, RTN, RTQ. 1.8D Td: C9DA/B, C9DC. 2.0D TDCi/HDi: AZWA, G6DA, G6DB, G6DC, RHE(DW10CTED4), QXWA, QXWB.

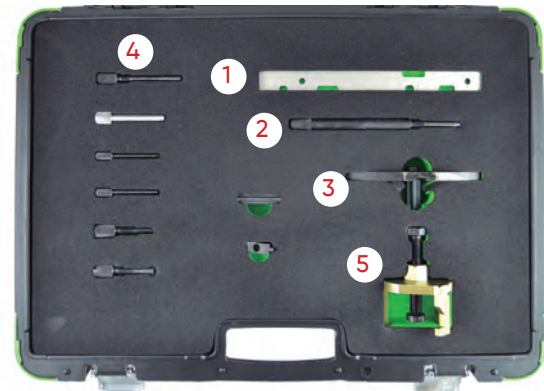

53318

24,00€



EXTRACTOR PINION PT AROBRELE CU CAME FORD

MĂRCI	FORD
INSTRUMENTE OEM	F8M, F8Q, S8U, S9U.



53295

77,00€

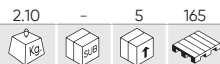

SET DISTRIBUȚIE PE LANȚ FORD 1,8TDDI, TDCI

MĂRCI	C-MAX (07-10), COURIER (00-02), FIESTA (00-02), FOCUS (98-11), FOCUS C-MAX (03-07), GALAXY (06-10), MONDEO (07-10), S-MAX (06-14), TOURNEO CONNECT (02-13), TRANSIT CONNECT (02-13).
INSTRUMENTE OEM	303-193 (21-104) (1), 303-393 (21-168) (2), 303-376 (21-162B) (3), 303-652 (21-230) (4), 310-095 (23-067) (5)
CODURILE DE MOTOR	1.8D TDCI: BHPA, F9DA, F9DB, FFBA, FFDA, FFWA, HCPA, HCPB, KHBA, KKDA, KKDB, P7PA, P9PA, P9PB, QYBA, QYWA, R2PA, R3PA, RWPA, RWPC. 1.8D TDCI ECONETIC: KHBA. 1.8D TDI: BHDA, BHDB, BHPA, C9DA, C9DB, C9DC. 1.8D TURBO: C9DC, RTN, RTP, RTQ.



53296

60,00€



SET DE DISTRIBUȚIE PT POMPA DE INECȚIE FORD/JAGUAR DURATORQ

MĂRCI	FORD: MONDEO (00-07), TRANSIT (00-14). CITROËN: RELAY, JUMPER III (06-13). FIAT: DUCATO (06-11).	JAGUAR: X-TYPE (03-10). PEUGEOT: BOXER III (06-12). LAND ROVER: DEFENDER TD4 (06-11). LDV: CONVOY (02-06).
INSTRUMENTE OEM	303-1151 (1), 303-679A/21-238 (2), 303-732 (3), 303-675/21-234 (4), 303-698/21-251 (5)	
CODURILE DE MOTOR	1.2D DI/TDDI/TDCI: ABFA, D3FA, F3FA, D5BA, D6BA, F1FA, FMBA, FMBB, HJBA, HJBB, HJBC, HJBE, N7BA, N7BB. 2.2D TDCI/ECONETIC: BG, CYFA, CYFB, CYFC, DRFA, DRFB, DRFC, P8FA, P8FB, PGFA, PGFB, QJBA, QJBA (BG), QJBB, QJBC, QJBD, QVFA, QWFA, SRFA, SRFB, SRFC, SRFD, SRFE, UHFA. 2.2D HDI/JTD: P22DTE (4HM), P22DTE (4HU), P22DTE (4HV). 2.4D DI/TDCI: DOFA, D2FA, D2FB, D4FA, F4FA, FXFA, H9FA, H9FB, H9FD, JXFA, JXFC, PHFA, PHFC. 2.4D TD/TDI: ZSD 424. 2.4D TD4: 244DT.	

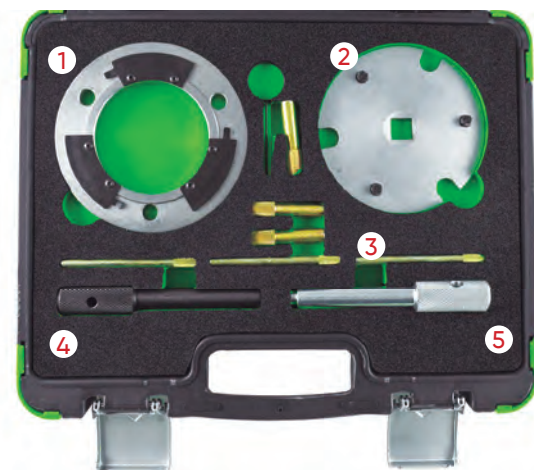

54419

57,00€

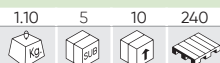

EXTRACTOR/INSTALATOR GARNITURI DE ETANȘARE A ARBORELUI COTIT FRONTAL FORD DURATORQ 2.0, 2.2, 2.4, 3.2

MĂRCI	FORD MONDEO 2000 - 2007 RANGER 2011 - ON TRANSIT 2000 - 2006 TRANSIT 2006 - 2014 TRANSIT 2014 - 2019 TRANSIT/TOURNEO CUSTOM 2012 - 2016
INSTRUMENTE OEM	21 238 (1), 303-679A (1), 303-682 (2)
CODURILE DE MOTOR	2.0 Di ABFA D3FA F3FA 2.0 TDCI FMBA FMBB HJBA HJBB HJBC N7BA N7BB SDBA F1FA 2.0 TDDi D5BA D6BA 2.2 TDCI QJBA QJBB QJBC QJBD GBVAJQJ GBVAJQJ GBVAJQV JQW CVRA CVRB CYFA CYFB CYFC CYRA CYRB DRFA DRFB DRFC DRFE DRRB DRRB P8FA P8FB PGFA PGFB QVFA QWFA SRFA SRFB SRFC SRFD SRFE UHFA UHFB 2.4 Di D2FA D2FB D4FA DOFA F4FA FXFA 2.4 TDCI H9FA H9FB H9FD JXFA JXFC 3.2 TDCI SAFA SA2R SA2S SA2W SAFA SAFB



54420

102,00€



N

SET DE REGLARE A COMBUSTIBILULUI - FORD/VOLVO 2.5 (EURO 4)

MĂRCI	FORD: FOCUS 2.5 RS / ST, MONDEO 2.5, S-MAX 2.5, GALAXY 2.5 ST (2005-) VOLVO: C30 (06-10), C70 (98-10), S40 (96-10), S60 (00-09), S70 (97-07), S80 (98-06), V40 (96-10), V50 (04-10), V70 (97-07), XC70 (02-07), XC90 (02-10)
INSTRUMENTE OEM	303-1178 (1), 999 5452 (1), MOT 1337 (1) 303-1182 (2), 999 5451 (2), MOT 1340 (2) 303-1179 (3), 999 5433 (3) 303-1183 (4)
CODURILE DE MOTOR	FORD: 2.5 Turbo (Euro 4), HUBA / HUWA / HYDA / JZDA VOLVO: 1.6 (B4164S), 1.8 (B4184S), 1.9T (B4194T), 2.0 (B4204S / B4204T), 2.0T (B5204T3 / B5204T4 / B5204T5), 2.3 (B5234FS), 2.3T (B5234T3 / B5234T7 / B5234T9) VOLVO: 2.4 (B5244S / B5244S2 / B5244S4 / B5244S5 / B5244S7), 2.4T (B5244T / B5244T3 / B5244T4 / B5244T5 / B5244T7), 2.5R (B5254FS), 2.4D (D5244T9 / D5244T8 / D5244T13)

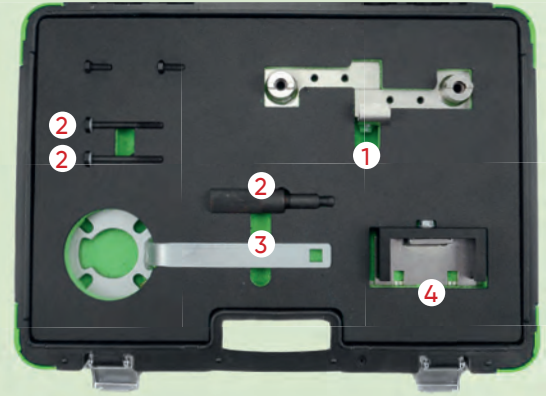

54421

52,00€



N

DISPOZITIVUL DE INSTALARE A CUREI AUXILIARE FORD/VOLVO 1.4 1.6

MĂRCI	FORD 1.4, 1.6 (FOCUS, C-MAX, MONDEO) VOLVO 1.6 (S40, C30, V50)
INSTRUMENTE OEM	303-1179
CODURILE DE MOTOR	B4164S3, FUJA, FXJA, FYJA C12HM7AD, C12LM7AA, ZH12FUJA, ZH12FUJB, ZH12M7JB C14HDEZ, C14HHADB, ZH14ASDA, ZH14FXDA, ZH14FXDB, ZH-14FXDC, ZH14FXDD, ZH14FXJA, ZH14FXJB 16HDEZ, CH16HDEZ, C16HHDEY, ZH16FYDA, ZH16FYDB, ZH16FY-DC, ZH16FYDD, ZH16FYDH, ZH16FYJA, ZH16FYJB, ZH16HWDA, ZH16HXDA



54424

64,50€

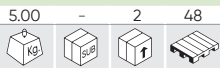

N

INSTRUMENT DE SINCRONIZARE PENTRU FORD 2.0 ECOBOOST

MĂRCI	FOCUS, GALAXY, MONDEO, S-MAX
INSTRUMENTE OEM	303-1504 (1) 303-1600 (2), 300-1565 (2) 303-1521 (3) 303-748 (4) 303-1595 (5) 2MM TENSIONER (6)
CODURILE DE MOTOR	MGDA, R9CB, R9CD, R9CF, R9CH, R9DA, R9DB, R9DC, R9DD, TNBA, TNBB, TNCC, TNCD, TNCF, TNWA, TNWB, TPBA, TPWA, TVDA, XQDA

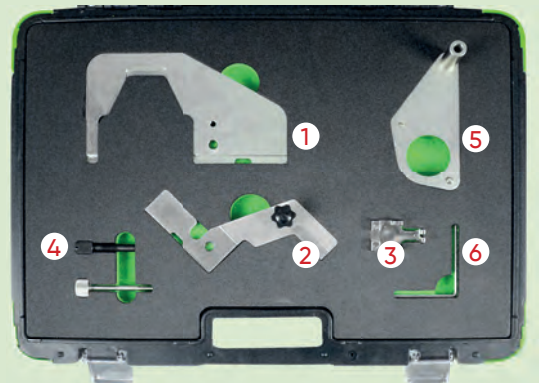

53324

12,50€

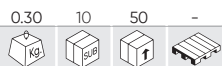

SET DISTRIBUȚIE PE LANȚ FORD

MĂRCI	FORD: B-MAX (15-17), C-MAX (07-10), COUGAR (98-01), FIESTA (95-17), FOCUS (98-11), FOCUS C-MAX (03-07), FUSION (02-12), GALAXY (06-15), MAVERICK (01-07), MONDEO (93-15), PUMA (97-02), S-MAX (06-15), TOURNEO CONNECT (02-06), TRANSIT (06-12), TRANSIT CONNECT (02-06). MAZDA: 121 ZG (95-00), 2 DY (02-07), 3 BK (03-09), 3 BL (09-15), 5 CR (05-10), 5 CW (10-12), 6 GG/GY (02-07), 6 GH (07-15), MPV LW (02-05), MX-5 NC (05-16), TRIBUTE EP (04-06). VOLVO: C30 (06-13), S40 (06-12), S80 (07-11), V50 (04-12).
INSTRUMENTE OEM	FORD: 303-1054, 303-507 (21-210), 303-620 (21-163), 303-574, 303-748, 303-376 (21-162B), 303-376B MAZDA: 49 JE01 061, 303-574, 49 JE02 061, 303-465, 49 JE01 054 VOLVO: 999 7152, 999 7151.
CODURILE DE MOTOR	1.4 / 1.6



53653

207,00€



SET DISTRIBUȚIE PE LANȚ FORD

MĂRCI	FORD: FIESTA, FOCUS, B-MAX, ECOSPORT.
INSTRUMENTE OEM	303-1605 (1), 303-1606 (2), 303-1604 (3), 303-1602 / 503-393A / (21-168) (4), 303-1054 (5), 303-732 (6)
CODURILE DE MOTOR	M1DD, M1JA, M1JC, M1JE, M1JHM1JJ, M1DA, M2DA, M2DB, M2DC, SFDBSFJA, SFJB, SFJC, SFJD

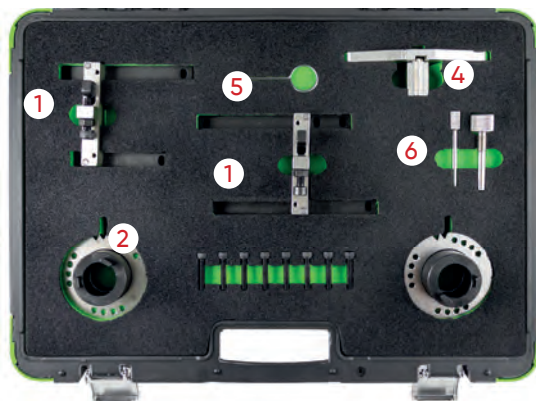

54201

37,60€

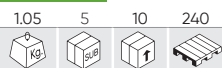

SET DE INSTRUMENTE DE SINCRONIZARE A MOTORULUI FORD

MĂRCI	FORD: C-MAX(07 - 10), C-MAX/GRAND C-MAX(10-18), FIESTA(08-18), FOCUS/FOCUS C-MAX(04-11), FOCUS(11-18), MONDEO(07-15)
INSTRUMENTE OEM	303-1097 (1), OEM 303-1054 (2), OEM 303-1059, 303-1270, 0188X, 999-7121 (3), OEM 303-748, 999-7152, 21-259 (4), OEM 303-735, 999 7122, 0187B, 0189B, 0132AJ1, 21-263, 0188M, MOT 1430, 303-1277, 0194B (5)
CODURILE DE MOTOR	11.6 TI-VCT HXDA (2003-2007) ,2.0 TDCI , G6DA, G6DB, G6DC 2003-2007



54204

124,00€

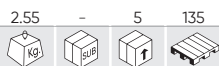

SET INSTRUMENTE DE REGLARE A MOTOARELOR PENTRU FORD 2.0 ECOBLUE

MĂRCI	FORD EDGE, FOCUS, GALAXY, S-MAX (FROM 2018); KUGA, MONDEO, RANGER (DESDE 2019); TRANSIT, TRANSIT CUSTOM AND TOURNEO CUSTOM (DESDE 2016); TODOS CON MOTOR ECOBLUE TDCI ; AWD, FWD Y RWD.
INSTRUMENTE OEM	303-1637 (1), 303-1650 (2), 303-1643 (3).
CODURILE DE MOTOR	BCCC,YLCB,YLDA,YLF6,YLFA,YLFB,YLFS,YLR6,YLRA,YMCB,YM-F6,YMFA,YMFB,YMFS,YMHA,YMRA,YNCA,YNF6,YNFA,YNFB,YNFS,Y-NR6,YNRA

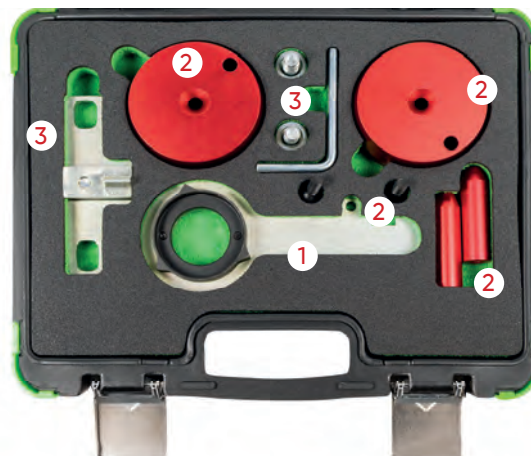

54208

76,00€

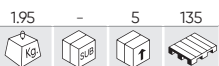

SET INSTRUMENTE DE REGLARE A MOTOARELOR PENTRU FORD 2.0 ECO BOOST SCTI, TI-VCT

MĂRCI	FORD: GALAXY(2010)MONDEO (2010) S MAX (2010) FOCUS(2011)
INSTRUMENTE OEM	303-748 (1), 303-1504 (2), 303-1565 (3), 303-1521 (4)
CODURILE DE MOTOR	TNWA, TNWB, TPWA, TNBA, TPBA, MGDA, XQDA

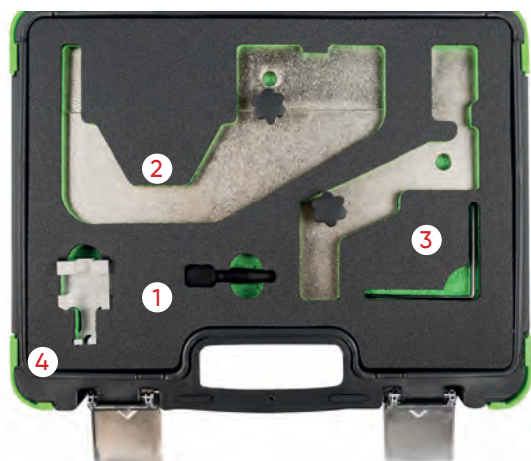

54209

29,70€

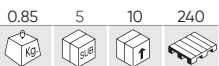

SET INSTRUMENTE DE REGLARE A MOTOARELOR PENTRU FOR/MAZDAD 2.2, 3.2 TDCI

MĂRCI	FORD_RANGER 3.2L (2011-2016) FORD_RANGER 2.2L (2011-2015) FORD_TRANSIT 2.2L (2006-2016) FORD_EVEREST 3.2L (2015) FORD_RANGER 3.2L (2011) MAZDA BT-50 (2011) MAZDA BT-50 3.2L (2011-2016)
INSTRUMENTE OEM	303-675/21-234,303-698/21-251 (1), 303-1587 (2)
CODURILE DE MOTOR	CYFA,CYFB,DRFA,DRFB,P8FA,P8FB,PGFA,PGFB,QVFA,QWFA,SR-FA,SRFB,SRFC,SRFD,SEFE,UHFA,CYFC,DRFC,USRA

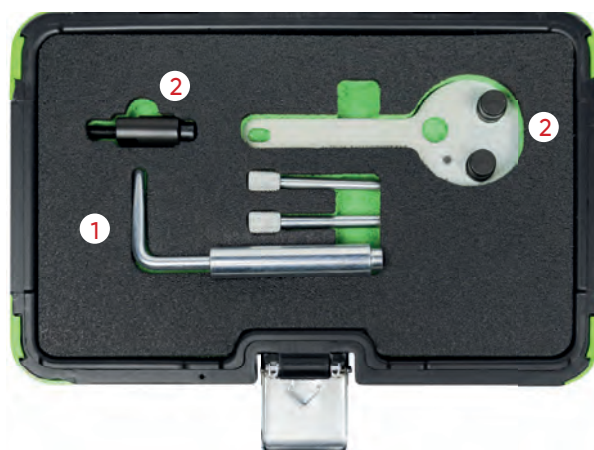

54223

149,00€



INSTRUMENT DE BLOCARE A PINIONULUI ARBORELUI CU CAME AL MOTORULUI PENTRU FORD 1.5T

MĂRCI	FORD, 1.5L DURATEC, ECOSPORT, FIESTA, FOCUS
INSTRUMENTE OEM	303-1639 (1), 303-1643 (2), 303-1647 (3), 303-1648 (4)
CODURILE DE MOTOR	2.2 / 2.5

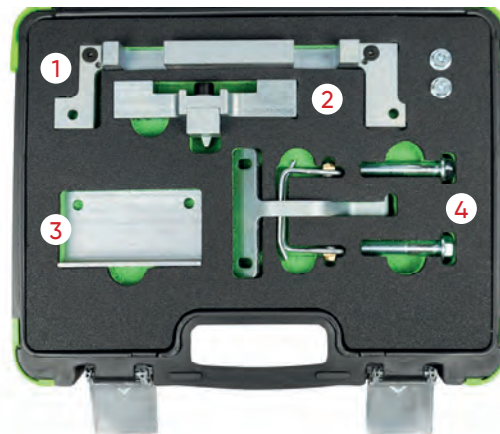

54224

64,50€



SET INSTALARE/ÎNDEPĂRTARE POMPĂ DE INECȚIE PENTRU FORD 2.0

MĂRCI	FORD: TRANSIT (17-18), TOURNEO CUSTOM (16-18), TRANSIT CUSTOM (16-18)
INSTRUMENTE OEM	303-1635 (1)/3, 3.3--1635 (2)/1, 303-1635 (3)/2, 303-1635/6 (4)
CODURILE DE MOTOR	YLFS, YMFS, YNFS, YLF6, YMF6, YNF6, YLR6, YMR6 AND YNRS.

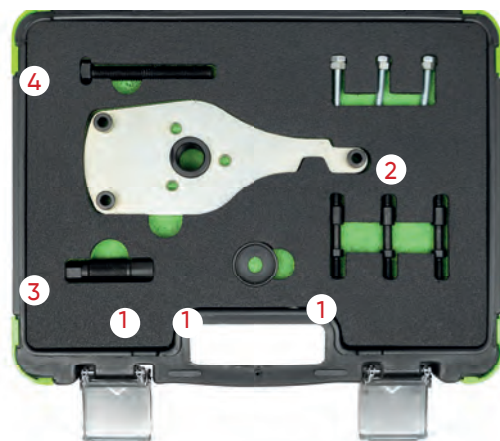

54260

277,00€

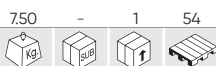

SET MULTIPLICATORI DE CUPLU 5:1 PENTRU MOTOARELE FORD ECOBOOST



1.0 EcoBoost
1.0 Duratec
2.0 Duratec

2.0 Durator-TDCi
2.0 EcoBlue Diesel



53297

45,00€

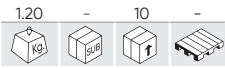

SET DISTRIBUȚIE PE LANȚ JAGUAR/LAND ROVER

MĂRCI	JAGUAR: MS TYPETDVI. LAND ROVER: DISCOVERY 2.7 TDV6. RANGE ROVER: SPORT 2.7 TDV6.
INSTRUMENTE OEM	303-1117 (1), 303-1116 (2), 303-1132 (3), 303-1126 (4) (5)
CODURILE DE MOTOR	276DT, 306DT.

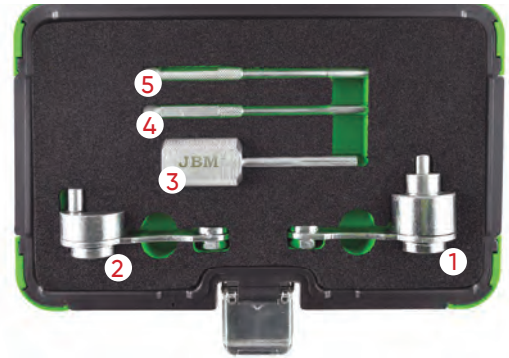

53298

91,00€

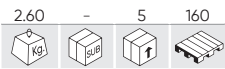

SET DISTRIBUȚIE PE LANȚ LAND ROVER

MĂRCI	MOTOARE DIESEL: 200 TDI. 300 TDI. 2.5
	<ul style="list-style-type: none"> - Cutie de transmisie manuală EDC. - 200 TDI. 300 TDI. 2.5 Motoare diesel. - Arborele de deformare a arborelui cotit. - Instrument de blocare pentru pompa de injecție. - Șurub de sincronizare a pompei de injecție 200/300 TDI. - Instrument de sincronizare a motorului 200/300 TDI. - Instrument de sincronizare a pompei DPS 2.5. - Instrument de sincronizare a volantului motorului 2.5.



54422

140,00€



KIT DE REGLARE A AXEI DE ECHILIBRARE JAGUAR/LAND ROVER 2.0D

MĂRCI	JAGUAR: E-PACE D150, D180, D240 (X540) (2017-), F-PACE 20D, 25D, E-PERFORMANCE (X761) (2016-), XE 20D, 25D, E-PERFORMANCE (X760) (2015-), XF 20D, 25D, E-PERFORMANCE (X260) (2015-) LAND ROVER: DEFENDER SD4 D200, SD4 D240 (L663) (2019-2021), DISCOVERY SPORT ED4, SD4, TD4, D150, D180, D240 MHEV (L550) (2015-), DISCOVERY SD4, TD4 (L462) (2017-2021) RANGE ROVER: EVOQUE ED4, SD4, TD4 (L538) (2015-2019), EVOQUE D150, D180, D240 MHEV (L551) (2019-), SPORT SD4 (L494) (2016-2018), VELAR D180, D240 (L560) (2017-)
INSTRUMENTE OEM	JLR-303-1662 (1) JLR303-1663-1 (2) JLR303-1663-2 (3) JLR303-1663-3 (4) JLR-303-1664 (5) JLR-303-1665 (6)
CODURILE DE MOTOR	2.0: AJ200D,AJ200/204DTA,AJ200/2004DTD 2.0: AJ-200D/204DT, AJ-200D/204DTA



54423

108,00€



N

INSTRUMENT DE SINCRONIZARE PENTRU LAND ROVER 3.6D

MĂRCI	RANGE ROVER SPORT; 3.6 (TDV8) DIESEL (2006-2011) RANGE ROVER; 3.6 (TDV8) DIESEL (2006-2011)
INSTRUMENTE OEM	303-1236 (1) 303-1243 (2) 303-1239 (3) 303-1238 (4)
CODURILE DE MOTOR	368DT

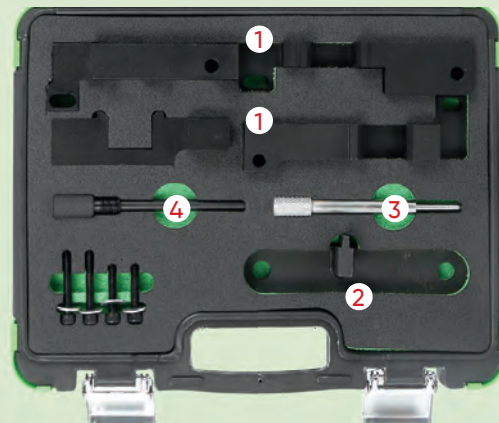

54425

124,00€



N

INSTRUMENT DE SINCRONIZARE PENTRU LAND ROVER FREELANDER V6/ROVER KV6 2.0L, 2.5L

MĂRCI	LAND ROVER: FREELANDER (2000-2006) MG: ZR (2004-2005), ZS (2001-2005), ZT (2001-2005) ROVER: 45 (1999-2005), 75 (1999-2005), 825 (1996-1999)
INSTRUMENTE OEM	LRT 12-175 (1) LRT 12-187 (2) LRT 12-195 (3) LRT 12-196 (4) LRT 12-198 (5) LRT 12-232 (6)
CODURILE DE MOTOR	LAND ROVER: 2,5 KV6 MG: 2,0 KV6, 2,5 KV6 ROVER: 2,0 KV6 2,5 KV6

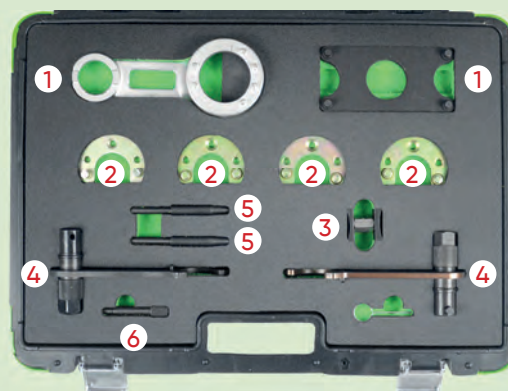

54426

69,00€



N

INSTRUMENT DE SINCRONIZARE PENTRU JAGUAR/LAND ROVER 3.2, 3.5, 4.0, 4.2, 4.4

MĂRCI	DAIMLER: V8 (97-03), SUPER V8 (97-03), SUPER EIGHT (05-10). JAGUAR: S-TYPE (99-08), XF (08-09), XJR (97-10), XJ8 (97-10), XKR (98-09), XK8 (96-09) LAND ROVER: DISCOVERY III (04-09) RANGE ROVER (05-09), RANGE ROVER SPORT (05-09)
INSTRUMENTE OEM	303530 (1) 303531 (2) 303532 (3) 303533 (4) 303645 (5) 303654 (6) T40011 (7)
CODURILE DE MOTOR	3.2: AC,KB,KC 3.5: RB 4.0: BC, CC,CE,DC,EC,GB,GC,LB,LC,MA,MB,NB,NC,PA,PB 4.2: 1B,2B,3B,1G,5G,9G,HB,HG,SB,TB,PC,428PS 4.4: 448PN

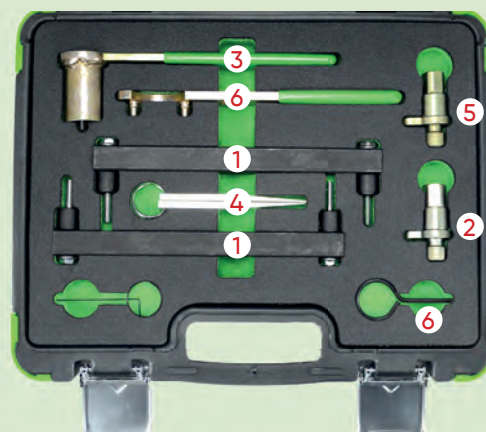

54427

113,00€



N

INSTRUMENT DE BLOCARE A SCRIPETELUI ARBORELUI COTIT JAGUAR/LAND ROVER 4.0, 4.2, 4.4

MĂRCI	DAIMLER: V8; 4.0 (97-98) JAGUAR: S-TYPE; 3.2, 3.5, 4.2 V8 (99-08), XF; 3.2, 3.5, 4.2 V8 (08-09), XJ; 3.2, 3.5, 4.2 V8 (97-08), XJ8; 4.0 (97-98), XK; 3.2, 3.5, 4.2 V8 (97-08), XK8; 4.0 (97-98) LAND ROVER: DISCOVERY3; 4.2, 4.4 LA V8 (05-09) RANGE ROVER; 4.2, 4.4 SPORT LS V8 (05-09), RANGE ROVER; 4.2, 4.4 LM V8 (06-08)
INSTRUMENTE OEM	LRT 12 080 18G 1437 18G 1437 2 303 191 303 191 03 303 191 04 303 588 303 893
CODURILE DE MOTOR	AJ26, AJ27, AJ28, AJ34 30G,36D,42D,56D,58D,94D,428PS,448PN



54428

31,00€



N

INSTRUMENT DE SINCRONIZARE PENTRU CHRYSLER/JEEP 2.8 CRD

MĂRCI	CHRYSLER GRAND VOYAGER 2008 - 2015 DODGE NITRO 2007 - 2011 JEEP CHEROKEE 2008 - 2013, WRANGLER 2007 - 2018
INSTRUMENTE OEM	VM 9991 (1) VM 9992 (2)
CODURILE DE MOTOR	VM64C, ENS, ENS (51C), 49C, 50C, ENS VM10D, ENS VM11D



54429

55,00€



N

INSTRUMENT DE SINCRONIZARE PENTRU CHRYSLER/JEEP 3.0D

MĂRCI	CHRYSLER 300 C 2012 - 2015 JEEP GRAND CHEROKEE 2011 - ON
INSTRUMENTE OEM	VM 10338 1 (1) VM 10338 2 (2) VM 10359A (3), VM 10359 (3) VM 10339 (4), VM 10359 (4)
CODURILE DE MOTOR	3.0 CRD: EXF 3.0 CRD/MULTIJET: EXF VM23D, EXF VM44D, EXF VM44D, EXF VM63D

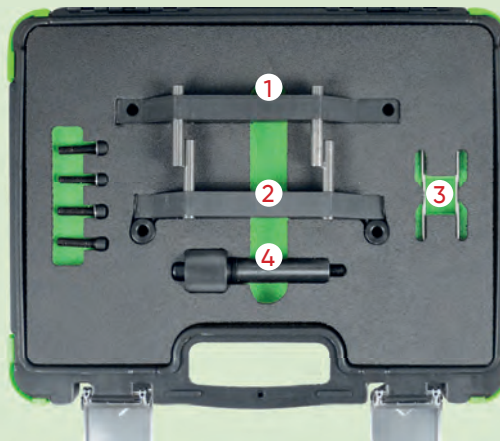

54207

38,90€

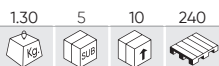

SET INSTRUMENTE DE REGLARE A MOTOARELOR PENTRU CHRYSLER/ JEEP LDV 2.5 CRD

MĂRCI	CHRYSLER: VOYAGER (01-08), GRAND VOYAGER (01-08) JEEP: CHEROKEE (01-08) LDV: MAXUS (05-09)	
INSTRUMENTE OEM	VM 9660 (1), VM1052 (2), VM1053 (3), VM1068 / VM1089 (4), VM1080 (5), VM8873 (6)	
CODURILE DE MOTOR	2.5D CRD: R2516C, R2516K, R2516LVM39/40B.	2.8D CRD: R2816C5.05A, R2816K4.



53270

70,00€

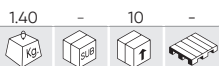

KIT DISTRIBUȚIE PE LANȚ MERCEDES/CHRYSLER/ JEEP

MĂRCI	MERCEDES CHRYSLER JEEP
INSTRUMENTE OEM	112589034000 (1), 601589024000 (2), 111589031500 (3)
CODURILE DE MOTOR	HERR.: 112 589 03 40 00; 112, 113, 137, 155, 156, 272/979, 273, 629, 642/992. HERR.: 601 589 02 40 00: 102, 103, 104, 111, 601, 602.91/93/94/96/983, 603.91/93/96/97, 604, 605, 606, 611, 612/965/966, 613. HERR.: 111 589 03 15 00: 111, 119, 604, 605, 606, 611/980, 612, 613, 628, 629, 640, 642/922, 612.965/966, 646, 647, 648 .

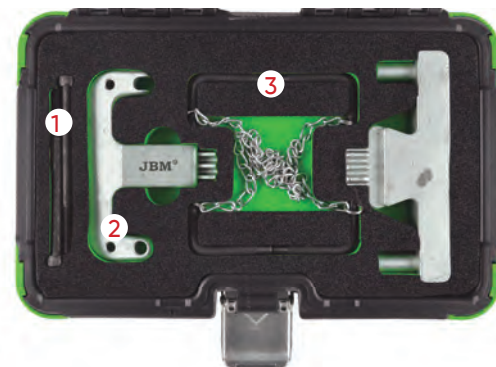

53271

227,00€



KIT DISTRIBUȚIE PE LANȚ MERCEDES BENZ M271

MĂRCI	MERCEDES
INSTRUMENTE OEM	271 589 003100 (1), 271589014000 (2), 271589001500 (3), 156589006100 (4)
CODURILE DE MOTOR	M271. E18ML 2002. DE18ML 2003 - 2005. E16ML 2008. DE18LA 2009.

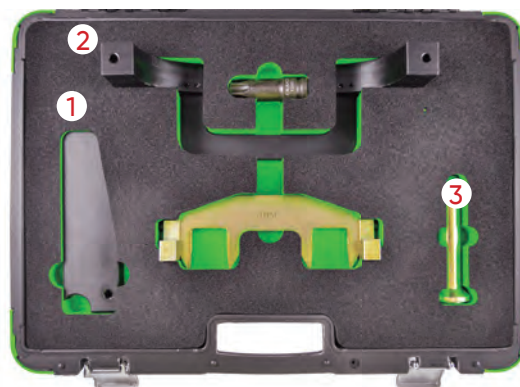

53272

195,00€

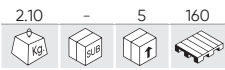

KIT DISTRIBUȚIE PE LANȚ MERCEDES AMG 156

MĂRCI	MERCEDES
INSTRUMENTE OEM	156589006100 (1), 156589003200 (2), 156589016300 (3), 156589006900 (4)
CODURILE DE MOTOR	BENZ AMG 156.ML 63 AMG.S 63L AMG.S 63. AMG. R 63 AMG L 4MATIC. R63 AMG 4MATIC. E 63 AMG. CLS 63 AMG. CLK 63 AMG BLACK SERIES. CLK 63 AMG CABRIO. CL 63 AMG.

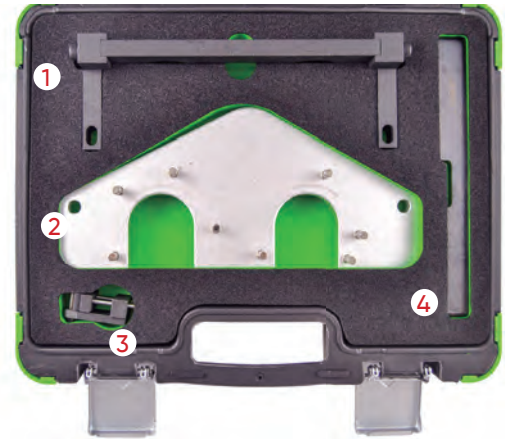

53273

75,00€

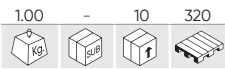

KIT DISTRIBUȚIE PE LANȚ MERCEDES M276, M157, M278

MĂRCI	MERCEDES		
INSTRUMENTE OEM	27658901400		
CODURILE DE MOTOR	<table border="0"> <tr> <td>CL 500 / 63 AMG (C 216) 2010–2013. S 500 / 63 AMG (C 217) 2014. CLS 300 (C 218) 2012. E 300 / 350 / 400 (C/A 207) 2011. CLS 350 / 400 / 500 / 63 AMG (C/X 218) 2011–2014. SLK 350 (R 172) 2011. SL 350 / 400 / 500 / 63 AMG (R 231) 2012. S 500 PLUG-IN HYBRID (V 222) 2014. ML 300 / 350 / 500 / 63 AMG (W 166) 2011.</td> <td>C 400 (W 205) 2014. E 400 HYBRID (W 212) 2012. G 63 AMG (W 463) 2012. E 300 / 350 / 400 / 500 / 63 AMG (W/S 212) 2011. C 350 (W/S/C 204) 2011. S 350 / 500 / 63 AMG (W/V 221) 2010. S 400 / 63 AMG (W/V 222) 2013. R 350 BlueEFFICIENCY (W/V 251) 2012. GL 450 / 500 (X 166) 2012. GLK 350 (X 204) 2011.</td> </tr> </table>	CL 500 / 63 AMG (C 216) 2010–2013. S 500 / 63 AMG (C 217) 2014. CLS 300 (C 218) 2012. E 300 / 350 / 400 (C/A 207) 2011. CLS 350 / 400 / 500 / 63 AMG (C/X 218) 2011–2014. SLK 350 (R 172) 2011. SL 350 / 400 / 500 / 63 AMG (R 231) 2012. S 500 PLUG-IN HYBRID (V 222) 2014. ML 300 / 350 / 500 / 63 AMG (W 166) 2011.	C 400 (W 205) 2014. E 400 HYBRID (W 212) 2012. G 63 AMG (W 463) 2012. E 300 / 350 / 400 / 500 / 63 AMG (W/S 212) 2011. C 350 (W/S/C 204) 2011. S 350 / 500 / 63 AMG (W/V 221) 2010. S 400 / 63 AMG (W/V 222) 2013. R 350 BlueEFFICIENCY (W/V 251) 2012. GL 450 / 500 (X 166) 2012. GLK 350 (X 204) 2011.
CL 500 / 63 AMG (C 216) 2010–2013. S 500 / 63 AMG (C 217) 2014. CLS 300 (C 218) 2012. E 300 / 350 / 400 (C/A 207) 2011. CLS 350 / 400 / 500 / 63 AMG (C/X 218) 2011–2014. SLK 350 (R 172) 2011. SL 350 / 400 / 500 / 63 AMG (R 231) 2012. S 500 PLUG-IN HYBRID (V 222) 2014. ML 300 / 350 / 500 / 63 AMG (W 166) 2011.	C 400 (W 205) 2014. E 400 HYBRID (W 212) 2012. G 63 AMG (W 463) 2012. E 300 / 350 / 400 / 500 / 63 AMG (W/S 212) 2011. C 350 (W/S/C 204) 2011. S 350 / 500 / 63 AMG (W/V 221) 2010. S 400 / 63 AMG (W/V 222) 2013. R 350 BlueEFFICIENCY (W/V 251) 2012. GL 450 / 500 (X 166) 2012. GLK 350 (X 204) 2011.		



54318

105,00€

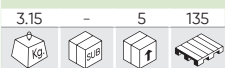

MAȘINĂ DE NITUIRE A LANȚULUI DE DISTRIBUȚIE

MĂRCI	CHRYSLER JEEP MERCEDES
INSTRUMENTE OEM	112 589 026 300 (1) 103 589 016 300 (2) 602 589 026 300 (3) 602589023300 (4) 602589003900 (5) 602589046301 (6)
CODURILE DE MOTOR	CHRYSLER/JEEP: 2.2D, 2.7D, 3.0D CRD (DIESEL). MERCEDES: 1.7D, 2.1D, 2.2D, 2.7D, 3.0D, 3.2D, 3.9D, 4.0D CDI (DIESEL)

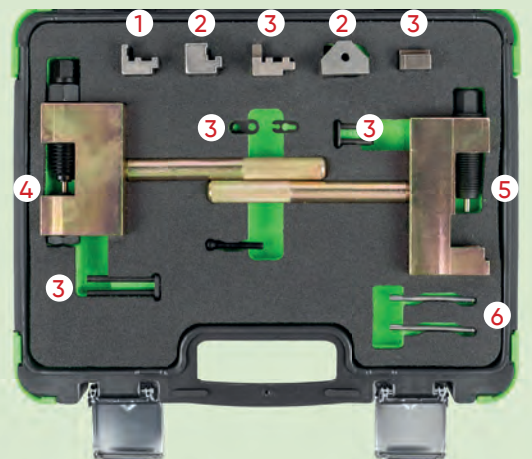

54414

97,50€



N

INSTRUMENT DE SINCRONIZARE PENTRU MERCEDES M651

MĂRCI	A CLASS (2012-2018), B CLASS (2012-2019), C CLASS (2009-2015), C CLASS (2014-2018), CLA COUPE (2013-2019), CLS (2011-2018), E CLASS (2009-2016), GLA (2014-2020), GLC (2015-2019), GLE (2015-2019), GLK (2008-2015), M CLASS (2011-2015), S CLASS (2010-2013), S CLASS (2013-2017), SLC (2016-2017), SLK (2012-2016), SPRINTER (2009-2018), SPRINTER (2018-), V CLASS (2014-), VIANO (2010-2015), VITO (2010-2015), VITO (2014-) MERCEDES-BENZ
INSTRUMENTE OEM	608 31 800 (1) 608 31 830 (2) 608 31 810 (3) 608 31 820 (4) 651 589 00 40 00 (5)
CODURILE DE MOTOR	1.8: 651.901 2.1: 651.900, 651.910, 651.911, 651.912, 651.913, 651.916, 651.921, 651.922, 651.924, 651.930, 651.940, 651.950, 651.955, 651.956, 651.957, 651.958, 651.960, 651.961, 651.980 2.2: 651.925

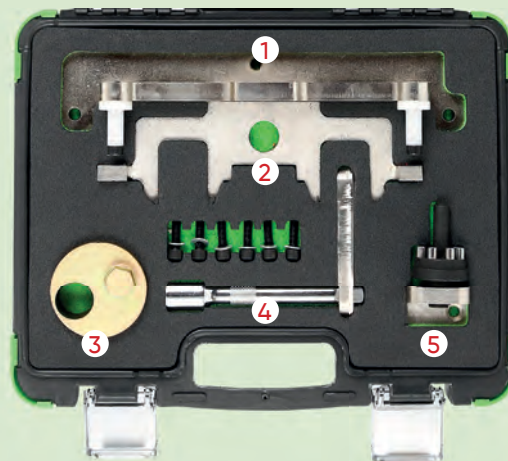

54415

60,00€



N

INSTRUMENT DE SINCRONIZARE PENTRU MERCEDES M651

MĂRCI	GLA X156 200/220 CDI, GLK X 204 200/220/250 CDI, ML W166 250, SLK R172 250 CDI, SPRINTER W906 210/310/510/213/313 CDI, SPRINTER W906 513/216/316/416/516 CDI, V-CLASS W/V 639 2.0/2.2 CDI, VITO W/V 639 110/113/116 CDI MERCEDES-BENZ: A-CLASS W176 180/200/220 CDI, B-CLASS W246 200/220 CDI, C-CLASS W/S/C 204 180/200/220/250 CDI, CLA C117 200/220 CDI, CLD C/X 218 220/250, E-CLASS W/S 212 200/220/250 CDI E-CLASS C/A 207 220/250 CDI, E-CLASS W212 250/300 BLUETEC
INSTRUMENTE OEM	651589004000 (1) 651589014000 (2)
CODURILE DE MOTOR	1,8 651.901 2,1 651.900 651.910 651.911 651.912 651.913 651.916 651.921 651.922 651.924 651.925 651.930 651.940 651.950 651.955 651.956 651.957 651.958 651.960 651.961 651.980

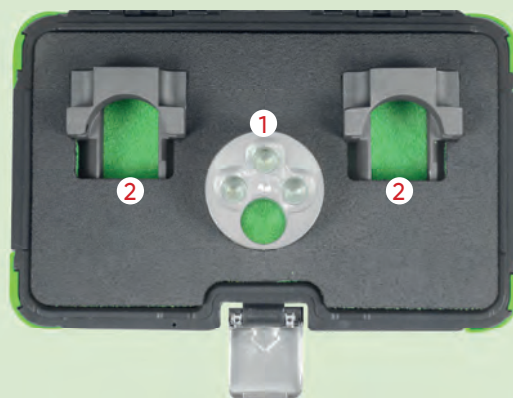

54416

31,00€



N

INSTRUMENT DE SINCRONIZARE PENTRU MERCEDES M642

MĂRCI	G-CLASS (461/463) 2007-2015, GL-CLASS (164/166) 2006-2016, GLE/GLE COUPE (166/292) 2020 GLK (204) 2008-2015, GLS (166) 2016-2019, M-CLASS (164/166) 2005-2015, R-CLASS (251) 2005-2013, S-CLASS (221/222) 2005-2017, SPRINTER (906) 2006-2018, VIANO (639) 2005-2015, VITO (639) 2006-2015 MERCEDES-BENZ: C-CLASS (203/204) 2004-2014, CLK (209) 2005-2009, CLS (219/218) 2005-2018, E-CLASS (211/212/213) 2005-2018, E-CLASS COUPE/CABRIOLET (207) 2009-2017
INSTRUMENTE OEM	642589003100 (1)
CODURILE DE MOTOR	642.820 642.822 642.826 642.830 642.832 642.834 642.835 642.836 642.838 642.850 642.852 642.853 642.854 642.855 642.856 642.858 642.861 642.862 642.867 642.868 642.870 642.872 642.884 642.886 642.890 642.896 642.910 642.920 642.921 642.922 642.930 642.932 642.940 642.950 642.960 642.961 642.970 642.975 642.990 642.992 642.993

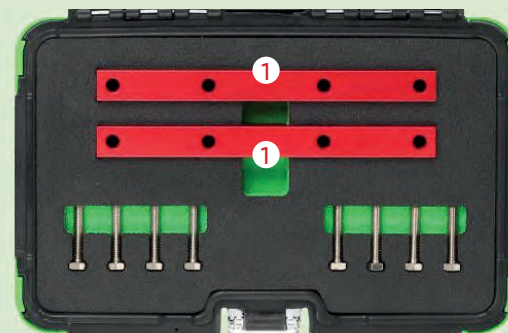

54417

153,00€



N

INSTRUMENT DE SINCRONIZARE PENTRU MERCEDES M133, M270, M274

MĂRCI	MERCEDES.BENZ A -CLASS (W176) (2012), MODEL A180/A200 MERCEDES.BENZ B CLASS (W246) AS OF 2011, MODEL B180/B200
INSTRUMENTE OEM	270589006100 (1)
CODURILE DE MOTOR	M133 M270 M274

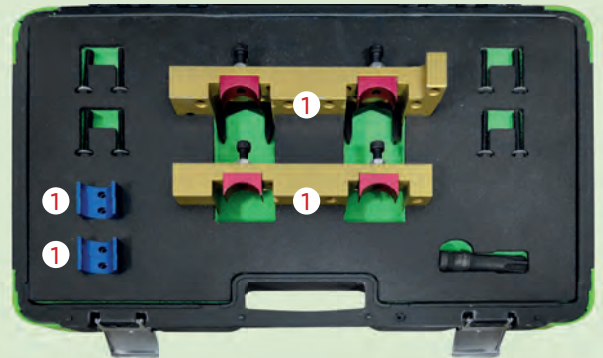

54418

37,00€

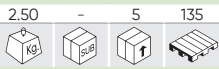

N

INSTRUMENT DE SINCRONIZARE PENTRU MERCEDES M112, M113

MĂRCI	C-CLASS (202) 2.4/2.6/2.8/3.2/4.3 - 1998-00, CLK (208) 3.2/4.3/5.4 - 1997-03, E-CLASS (210) 2.4/3
INSTRUMENTE OEM	112589003200 (1) 112589013200 (2) 112589000100 (3)
CODURILE DE MOTOR	MERCEDES.BENZ: M112, M113

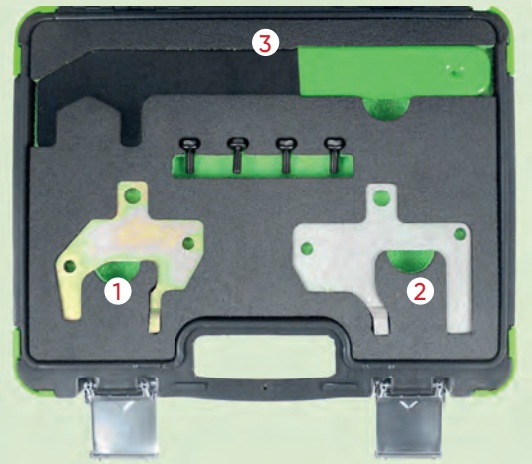

51488

16,00€

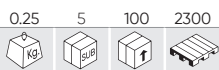

BOLȚURI BLOCAJ MOTOARE RENAULT /NISSAN/DACIA/SUZUKI

MĂRCI	RENAULT: CAPTUR, CLIO II.III.IV, ESPACE/GRAND ESPACE III.IV, FLUENCE, KADJAR, KANGOO, LAGUNA I,II,III, LOGAN/ LOGAN MCV, MEGANE I,II,III,IV, MODUS/GRAND MODUS, SCENIC/ GRAND SCENIC I,II,III,IV, TWING II, TRAFIC II, MASTER II 1.5DCI & 1.9 DCI. DACIA: DOKKER, DUSTER, LODGY, LOGAN, SANDERO 1.5DCI NISSAN: ALMERA, CUBE, JUKE, KUBISTAR, MICRA, NOTE, NV200/EVALIA, PRIMERA, TIIDA, INTERSTAR, PRIMASTAR 1.5DCI & 1.9 DCI SUZUKI: GRAND VITARA, JIMNY 1.5DDIS & 1.9DDIS
INSTRUMENTE OEM	MOT1489, MOT1430, MOT1054.
CODURILE DE MOTOR	K9K, F8Q, F9Q - benzină, Clío, R19, Laguna 1.8/2.0 F3R F3P



53289

45,00€

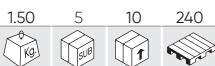

SET DISTRIBUȚIE PE LANȚ RENAULT 1.4, 1.6, 1.8, 2.0 16V

MĂRCI	<p>RENAULT: ESPACE/GRAND ESPACE (98-02), ESPACE/GRAND ESPACE IV (02-10), KANGOO/TREKKA (01-09), LAGUNA (98-01), LAGUNA II (01-07), LAGUNA III (07-13), MEGANE (99-03), MEGANE II (02-10), MEGANE III/SPORT (08-13), MEGANE/SCENIC (99-00), SCENIC/RX4 (99-03), SCENIC/GRAND SCENIC II (03-09), TRAFIC II (01-11), TWINGO II (08-14), VEL SATIS (00-10), WIND (10-14)</p> <p>DACIA: LOGAN/MCV (05-11).</p> <p>NISSAN: KUBISTAR X76 (03-09), PRIMASTAR (02-11).</p> <p>VAUXHALL/OPEL: JETTA, TOURAN, GOLF, GOLF PLUS, POLO, PASSAT, TIGUAN, SCIROCCO.</p>
INSTRUMENTE OEM	MOT1489 (1), MOT1054 (2), MOT1496 (3)
CODURILE DE MOTOR	<p>1.4 16V K4J: 730, 732, 740.</p> <p>1.6 16V K4M: 752, 753, 760, 761, 764, 788, 812, 813, 854, 856.</p> <p>1.8 16V F4P: 720, 722, 760, 770, 771, 772, 773, 774, 775.</p> <p>2.0 16V F4R: 700, 701, 712, 713, 714, 715, 720, 722, 730, 732, 736, 738, 740, 741, 744, 746, 747, 762, 763, 764, 765, 766, 767, 770, 771, 780, 790, 791, 792, 820, 830, 832, 867.</p> <p>2.0 16V F4R(11): 720, 722, 764, 765, 774, 776, 784, 786, 787, 794, 795, 796, 797, 800, 802, 810, 811, 870, 872, 874, 886, 887, 896, 897.</p>

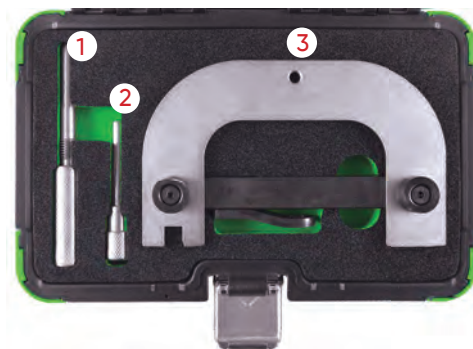

53290

51,00€

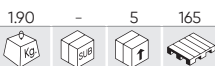

SET DISTRIBUȚIE PE LANȚ RENAULT/VOLVO 16V, 20V

MĂRCI	<p>RENAULT: LAGUNA 2.0 16V / 2.5 20V (1996-1999), SAFRANE 2.0 16V / 2.5 20V (1996-2001)</p> <p>VOLVO: 850 (1992-1997), C70 (1998-2002), S40 (1996-2004), V40 (1996-2004), S60 (2001-2005), S70 (1997-2000), S80 (1999-2005).</p>
INSTRUMENTE OEM	MOT1348 (1), MOT1337 (2), MOT1340 (3)
CODURILE DE MOTOR	<p>RENAULT: N7Q 704/710/711(2.0 16V), N7U 700/701(2.5 20V).</p> <p>VOLVO: B4164S, B4164S2, B4184S, B4184S2, B4184S3, B4184S9, B4184S10, B4194T, BS194T2, B420S4, B4204S2, B4204T, B4204T2, B4204T3, B4204T5, B5202FS, B5204FT, B5204T2, B5204T3, B5204T4, B5204T5, B5234FS, B5204FT, B5234T3, B5234T4, B5234T5, B5234T6, B5234T7, B5234T8, B5234T9, B5244S, B5244S2, B5244SG, B5244SG2, B5244T, B5244T3, B5244T4, B5244T5, B5244T7.</p>

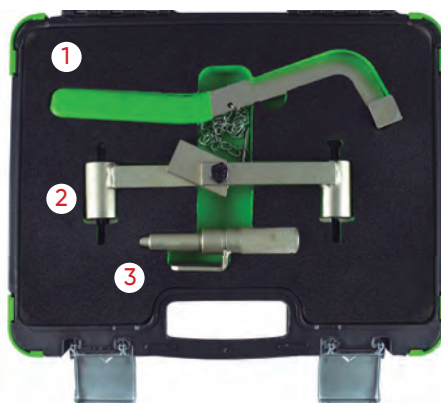

53291

68,00€

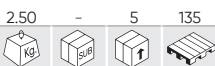

SET DISTRIBUȚIE PE LANȚ RENAULT

MĂRCI	RENAULT: CLIO, LAGUNA, MEGANE
INSTRUMENTE OEM	MOT1496 (1), MOT1489 (2), MOT861/1863 (3), MOT1490(4)
CODURILE DE MOTOR	K4J, K4M, F4P, F4R.

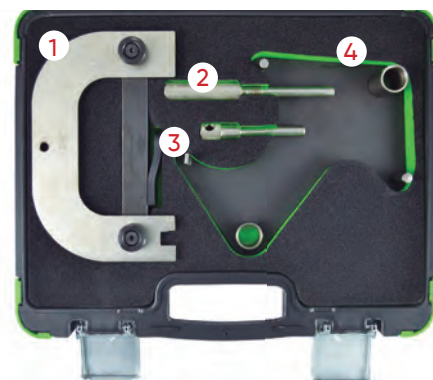

53292

116,00€

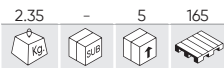

SET DISTRIBUȚIE PE LANȚ RENAULT/OPEL 2.2, 2.5 TDI DCI

MĂRCI	RENAULT: LAGUNA II, ESPACE, MASTER, TRAFIC, 2.2 / 2.5 DCI OPEL: VIVARO, MOVANO, DIESEL: 2.2 / 2.5 DTI, ASTRA B, VECTRA B, SIGNUM, ZAFIRA, 2.2 16V
INSTRUMENTE OEM	KM6205 (1), KM6204 (2), KM6077 (3)
CODURILE DE MOTOR	2.2 / 2.5

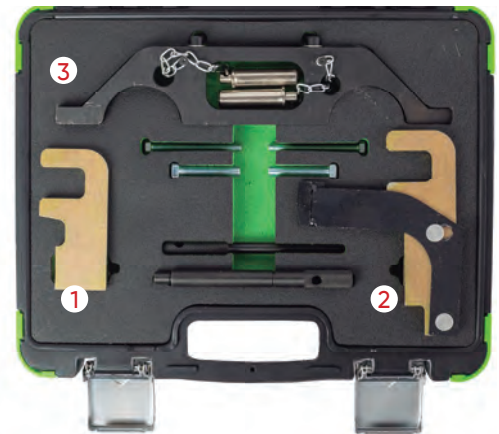

53111

97,00€

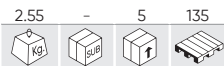

SET DISTRIBUȚIE PE LANȚ RENAULT/NISSAN/OPEL/VAUXHALL 2.0, 2.3 DCI, CDTI, M9R, M9T

MĂRCI	NISSAN: PRIMASTAR X83 (06-15), QASHQAI/QASHQAI+2 J10 (07-14), X-TRAIL T31 (07-14). VAUXHALL/OPEL: MOVANO-B (10-17), VIVARO (06-15). RENAULT: ESPACE/GRAND ESPACE IV (06-10), KOLEOS (08-15), LAGUNA LL (05-07), LAGUNA LLL (07-14), MASTER LLL (10-15), MEGANE LL (06-10), SCENIC/GRAND SCENIC LL (06-09), SCENIC/GRAND SCENIC LLL (09-15), TRAFIC LL (06-14), VEL SATIS (05-10)
INSTRUMENTE OEM	MOT1769 (1), EN-48334 (2), MOT1766 (3), EN-48330 (3), KM-6130 (4), EN-48332 (5), MOT1773 (6), EN-48831 (6)
CODURILE DE MOTOR	2.0D DCI M9R: 630, 780, 782, 784, 786, 788, 830, 832, 833, 834, 835, 836, 838, 855, 856. 2.0D CDTI M9R: 630, 780, 782, 784, 786. 2.3 BI-CDTI: LP6/M9T706, LW7/M9T706. 2.3D DCI M9T: 670, 672, 676, 678, 680, 686, 690, 692, 694, 698.



53523

91,00€



SET PENTRU BLOCAREA MOTOARELOR DIESEL RENAULT / NISSAN/OPEL 1.6 DCI

MĂRCI	RENAULT: ESPACE/GRAND ESPACE IV (06-10), KALEOS (08-11), LAGUNA LL (05-07), LAGUNA LLL (07-12), MASTER LLL (10-12), MAGANE LL (06-10), SCENIC/GRAND SCENIC LL (06-09), SCENIC/GRAND SCENIC LLL (09-12), TRAFIC LL (06-12), VEL SATIS (05-10) NISSAN: PRIMASTAR X83 (06-10), QASHQAI/QASHQAI+2 J10 (07-10), X-TRAIL T31 (07-12). VAUXHALL / OPEL: MOVANO-B (10-12), VIVARO (06-12).
INSTRUMENTE OEM	MOT1969 (1), MOT1970 (2), MOT1770, MOT1773, EN-48330, EN-48332, EN-48334, EN-48831, KM-6130
CODURILE DE MOTOR	M9R 2.0DCI: 610, 615, 630, 700, 721, 740, 742, 760, 761, 762, 763, 780, 782, 784, 786, 788, 800, 802, 803, 805, 808, 816, 830, 832, 833. M9T 2.3DCI: 670, 672, 676, 678, 680, 686, 690, 692, 694, 698.



54210

84,00€



INSTRUMENT DE BLOCARE A PINIONULUI ARBORELUI CU CAME AL MOTORULUI PENTRU RENAULT 1.8, 2.0 16V

MĂRCI	RENAULT LAGUNA II (2001 - 2009), MEGANE II (2002 - 2009), Scenic (2002 - 2009)
INSTRUMENTE OEM	MOT 1509-01 (1), 1509 (2)
CODURILE DE MOTOR	700, 701, 712, 713, 714, 715, 720, 721, 722, 722, 730, 732, 736, 738, 740, 741, 744, 746, 747, 760, 761, 762, 763, 764, 765, 766, 767, 770, 771, 773, 774, 774, 775, 776, 784, 786, 787, 790, 792, 794, 797, 830, F4P, F4R



54225

133,00€



SET DE BLOCARE A VOLANTULUI / SCRIPETELUI ARBORELUI COTIT PENTRU RENAULT/NISSAN

MĂRCI	NISSAN: PRIMASTAR (06-15), QASHQAI/QASHQAI+2 (07-14), X-TRAIL (07-14), NAVARA (15-16), NV400 (11-16) RENAULT: ESPACE V (15-16), CLIO (06-16), FLUENCE (09-15), LAGUNA (05-15), LATITUDE (10-15), MEGANE (06-15), SCENIC/ GRAND SCENIC (06-15), ESPACE/GRAND ESPACE IV (02-15), KOLEOS (08-16), TRAFIC II (07-15), VEL SATIS (00-10), MASTER III (10-16)
INSTRUMENTE OEM	MOT 1431(1), MOT 1716(2), MOT 2019(2), MOT 1789(3), MOT 919-02(4)
CODURILE DE MOTOR	1.4:H4.JT700 1.6:M5M400, M5M450 2.0:M4R700, M4R701, M4R704, M4R711, M4R713, M4R714, 2.0D:M9R726, M9R730, M9R735, M4R737, M9R740, M4R746, M9R742, M9R744, M9R746, M9R748, M4R750, M4R751, M4R752, M4R753, M4R754, M9R610, M9R613, M95615, M9R630, M9R750, M9R760, M9R761, M9R762, M9R762, M9R763, M9R700, M9R721, M9R722, M9R724, M9R756, M9R780, M9R782, M9R800, M9R802, M9R803, M9R804, M9R805, M9R806, M9R808, M9R809, M9R811, M9R812, M9R814, M9R815, M9R816, M9R817, M9R820, M9R824, M9R828, M9R830, M9R832, M9R833, M9R834, M9R835, M9R836, M9R838, M9R839, M9R844, M9R845, M9R846, M9R849, M9R854, M9R855, M9R856, M9R857, M9R858, M9R859, M9R865, M9R866, M9R784, M9R786, M9R788 2.3D:M9T670, M9T672, M9T676, M9T678, M9T680, M9T686, M9T690, M9T692, M9T694, M9T696, M9T698, M9T700, M9T702, M9T706, M9T708, M9T870, M9T880, M9T890, M9T896, M9T898, M9T899, YS23DDT, YS23DDTT 2.5:2TR700, 2TR702, 2TR703, 2TR704, 2TR705, 2ZV604, V4U604, VQ25 3.5:V4Y701, V4Y711, V4Y713, V4Y715



GASEȘTE UȘOR KITUL
TĂU DE DISTRIBUTIE

INTRODUCEȚI ÎN BROWSERUL WEB CODUL
DE SCULE OEM SAU CODUL DE MOTOR AL
MAȘINII DUMNEAVOASTRĂ ȘI GĂSIȚI KITUL DE
DISTRIBUTIE COMPATIBIL

54289

38,00€

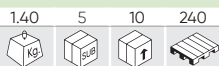

N

SET DE BLOCARE A VOLANULUI DE INERȚIE PENTRU MERCEDES/RENAULT/DACIA/NISSAN

MĂRCI	DACIA DOKER 2015 + DACIA DUSTER 2015+ DACIA LODGY 2015+ DACIA LOGAN 2013/-2020 DACIA SANDERO 2013+ MERCEDES-BENZ A-CLASS 2018+ MERCEDES-BENZ B-CLASS 2019+ MERCEDES-BENZ CLA 2019+ MERCEDES-BENZ GLA 2019+ MERCEDES-BENZ GLB 2019+ RENAULT ARKANA 2019+ RENAULT CAPTUR 2018+ RENAULT CLIO V 2019 + RENAULT KADJAR 2018+ RENAULT MEGANE IV 2017+ RENAULT SCENIC/GRAND SCENIC IV 2018+ RENAULT TALISMAN 2018+
INSTRUMENTE OEM	MOT.2188 (1)
CODURILE DE MOTOR	HR13DDT, H4Bt 400, H4Bt 408, H4Bt 410, H4Bt 411, H4M 730, H4M 738, H4M 740, H5H 450, H5H 470, H5H 480, 282.914



54438

40,00€



N

INSTRUMENT DE SINCRONIZARE PENTRU RENAULT/NISSAN 3.0DCI

MĂRCI	NISSAN: NAVARA PICK UP, PATHFINDER, INFITI RENAULT: LAGUNA, LATITUDE
INSTRUMENTE OEM	MOT 1880 (1) MOT 1970 (2) MOT 1874 (3)
CODURILE DE MOTOR	V9X, V9X 791, 891

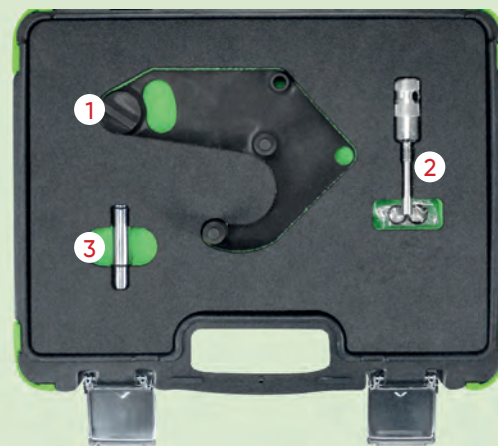

54439

32,50€

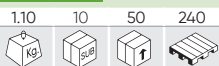

N

DISPOZITIVĂ DE BLOCARE A ROȚII DE TRANSMISIE A ARBORELUI COTIT RENAULT/DACIA 0.9, 1.0, 1.2, 1.6 TCE

MĂRCI	DACIA DOKKER 2012 - 2019, PLUMERO 2013 - 2018, LOGIA 2012 - 2018 RENAULT CAPTURAR 2013 - 2019, CLIO IV 2012 - 2019, KADJAR 2015 - 2018, KANGOO II 2013 - EN, MEGANE III 2012 - 2017, MEGANE IV 2016 - 2020, ESCÉNICO/GRAN ESCÉNICO III 2012 - 2017, ESCÉNICO/GRAN ESCÉNICO IV 2016 - 2018, TWIN-GO III 2014 - EN
INSTRUMENTE OEM	MOT. 2006 (1) MOT. 2054 (1) 281589004000 (1)
CODURILE DE MOTOR	0.9TCE: H4B 453, H4Bt 400, 401, 408, 410, 411, 451. 1.0TCE: H4D, H4D 400, 450, 460, 470 1.2TCE: H5Ft 400, 403, 404, 405, 408, 410, 412. 1.6TCE: H4M 429, 438, 440, 729, 730, 738, 740, 748, 749

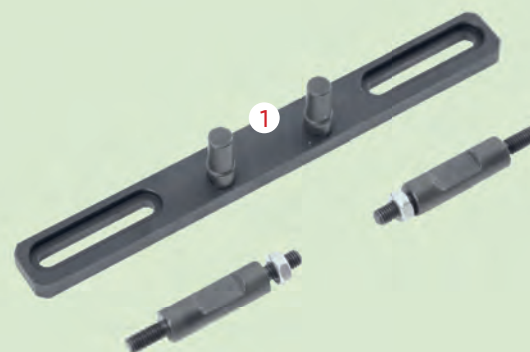

53299

291,00€

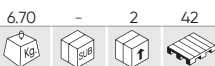

SET DISTRIBUȚIE PE LANȚ OPEL/VAUXHALL

MĂRCI	OPEL / VAUXHALL
INSTRUMENTE OEM	EN-46788 (1), KM927 (2), EN-46789 (3), KM929 (4), EN-46785 (5), EN-46788 (6), 1 860 985 000 (7), KM932 (8), KM933 (9), EN-49978 (10), KM933 (11)
CODURILE DE MOTOR	1.3 CDTI 16V, 1.9 CDTI, 2.0 DTI, 2.2 DTI.

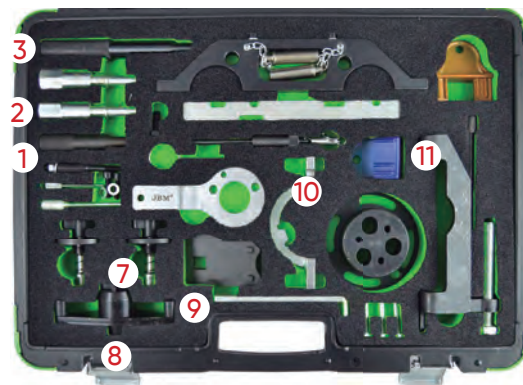

53300

41,00€

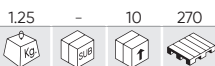

SET DISTRIBUȚIE PE LANȚ OPEL/VAUXHALL/CHEVROLET 2,0CDI

MĂRCI	OPEL VAUXHALL CHEVROLET
INSTRUMENTE OEM	EN-48245 (1), EN-48246 (2), 205083060 (3) (4) (5) (6)
CODURILE DE MOTOR	OPEL / VAUXHALL: Z20DM, Z20DMH CHEVROLET: LLWZ20DMH, RA 420 , Z20SI, Z 20S3, Z 20S4, Z 20S5

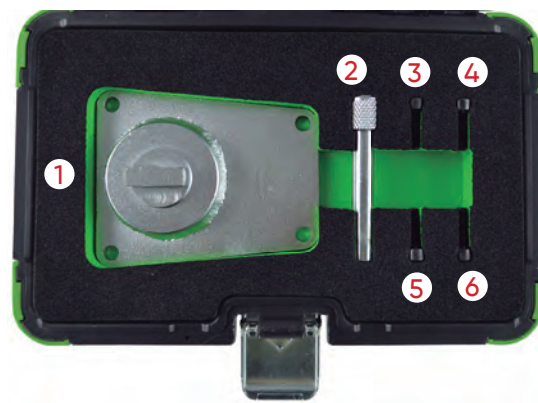

53301

44,00€



SET DISTRIBUȚIE PE LANȚ SUZUKI/OPEL 1.0, 1.2, 1.4

MĂRCI	SUZUKI: WAGON R (05-08). VAUXHALL / OPEL: AGILA (00-08), ASTRA-G (98-06), ASTRA G CLASSIC II (03-10), ASTRA-H (04-11), COMBO (04-12), CORSA-B (97-00), CORSA-C (00-07), CORSA-D (06-12), MERIVA-A (04-10), TIGRA-B (04-10).
INSTRUMENTE OEM	KM-953/09919-58310 (1), KM-952/09912-38310 (2), KM-954/09919-08310 (3), KM-6130 (4), KM-955/09919-58320 (5)
CODURILE DE MOTOR	1.0 12V: X10XE, Z10XE, Z10XEP. 1.2 16V: X12XE, Z12XE, Z12XEP. 1.4 16V/ECOFLEX: Z14XEL, Z14XEP.

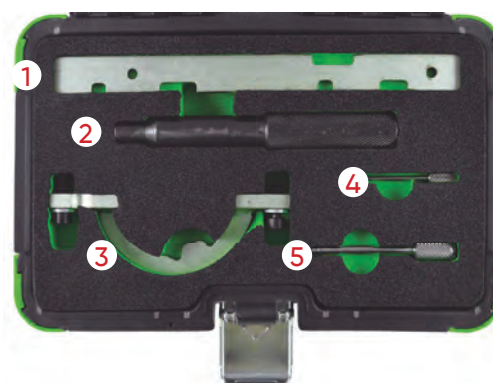

53302

44,00€

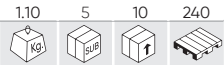

SET DISTRIBUȚIE PE LANȚ FIAT/ALFA ROMEO/VAUXHALL/OPEL/SAAB JTD

MĂRCI	SAAB: 9-3 (04-08), 9-5 (05-08). VAUXHALL / OPEL: ASTRA-H, VECTRA-C, SIGNUM (04-07), ZAFIRA-B (05-07).
INSTRUMENTE OEM	EN46789/32 025 008 (1) (3), EN46788/32 025 009 (2), KM6349 (4)
CODURILE DE MOTOR	Z19DT, Z19DTH, Z19DTL.



53305

136,00€

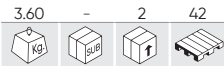

SET DISTRIBUȚIE PE LANȚ SAAB/OPEL/VAUXHALL

MĂRCI	VAUXHALL / OPEL: ANTARA (06-10), CALIBRA (93-98), CAVALIER/VECTRA-A (93-95), OMEGA-B (94-03), SIGNUM (03-05), SINTRA (96-99), VECTRA-B (95-02), VECTRA-C (02-05). SAAB: 900 (93-98), 9000 (95-97), 9-5 (98-03)
INSTRUMENTE OEM	KM-800-1 (1), KM-800-2 (2), KM-800-20 (3), KM-800-10 (4), 83 95 006 (5), KM-800-30 (6), MKM-6038, 83 95 006 (7)
CODURILE DE MOTOR	2.5 V6: SAAB: B2581, VAUXHALL/OPEL: C25XE, X25XE. 2.6 V6: VAUXHALL/OPEL: Y26SE. 3.0 V6: SAAB: B308E, B308I, VAUXHALL / OPEL: X30XE. 3.2 V6: VAUXHALL/OPEL: Y32SE, .



53307

38,50€

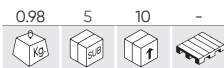

SET DISTRIBUȚIE PE LANȚ ALFA/OPEL/VAUXHALL 1.6, 1.8 16V

MĂRCI	OPEL / VAUXHALL: CORSA-D, AGILA, ASTRA-G-H, MERIVA, ZAFIRA-B, VECTRA-C, SIGNUM, INSIGNA	1.6, 1.8
	CHEVROLET: AVEO, CRUZE, ORLANDO	1.4, 1.6, 1.8
	ALFA ROMEO: 159 FIAT: CROMA	1.8
INSTRUMENTE OEM	E10290 (1), 23056-06 (2) (3), E10230 (4), 23164-04 (5), 23174-01 (6), 23056-05 (7)	
CODURILE DE MOTOR	OPEL / VAUXHALL: Z16LEL, Z16LER, Z16LET, Z16XE1, Z16XEP, Z16XER, A16XER, 18XER, A18XER, 2HO/A18XEL. CHEVROLET: G14D, LDD, LXV (F16D4), 2HO(Z18XER). ALFA / FIAT: 939A4.000.	

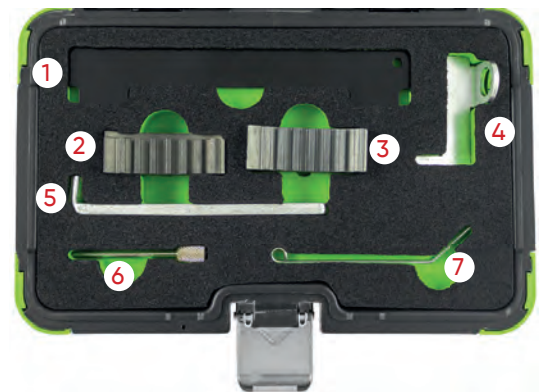

53316

34,00€

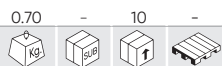

SET DISTRIBUȚIE PE LANȚ FIAT/OPEL/VAUXHALL 2.2 16V LANȚ

MĂRCI	OPEL: ASTRA-G (2000-2006), ASTRA-H (2006-2011), SIGNUM (2003-2008), VECTRA-B (2000-2002, VECTRA-C (2002-2008), ZAFIRA-A (2000-2005), ZAFIRA-B (2005-2012), SPEEDSTER (2000-2006). VAUXHALL: VX220 (2000-2006). FIAT: CROMA (2005-2009).
INSTRUMENTE OEM	VAUXHALL / OPEL: Z22SE, Z22YH FIAT: 194A1.000.



53317

34,00€

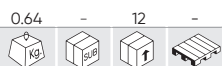

OPEL/VAUXHALL 2.2 ANTIFREEZE PUMP BLOCKER

MĂRCI	OPEL 2.2 Lanț VAUXHALL 2.2 Lanț
-------	------------------------------------



53452

26,50€



SET DISTRIBUȚIE PE LANȚ OPEL/FORD/FIAT/ ALFA ROMEO/LANCIA/SUZUKI

MĂRCI	VAUXHALL/OPEL 1.3 CDTI: AGILA, CORSA, COMBO (03-08), ASTRA-H(05-08), MERIVA, TIGRA-B(04-08) SUZUKI 1.3 DDIS: IGNIS, WAGON R(03-08), SWIFT(04-08) FORD: 1.3 TDCI FIAT/ALFA ROMEO/LANCIA: 1.3 JTD MULTIJET
INSTRUMENTE OEM	104-A EN 46781 (1) , EN 46785 (2)

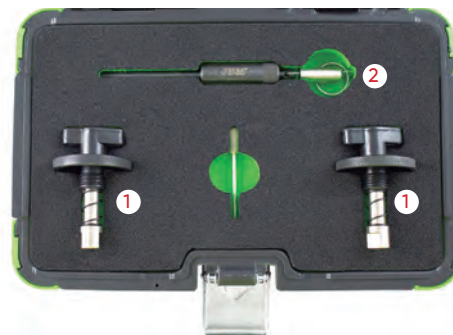

53651

91,00€



SET DISTRIBUȚIE PE LANȚ OPEL/VAUXHALL 1.0, 1.2, 1.4 TURBO

MĂRCI	OPEL: ADAM, AMPERA, ASTRA-J, AVEO, CORSA-D, INSIGNIA, MERIVA-B, MOKKA, ZAFIRA-C TOURER
INSTRUMENTE OEM	EN 49977-100 (1), EN 49977-200 (2), EN 49978 (3), KM 952 (4), KM 953-A (5), KM 955-1 (6), KM 955-2 (7).
CODURILE DE MOTOR	1.0: A10XEP (LDB) 1.2: A12XEL (LWD), A12XER (LDC) 1.4: A14XEL (L2Z), A14XER (LDD), LDU A14NEL (LUH), A14NET (LUJ), TWINPORT / ECOFLEX ENGINES A14XFL (LUU), A14NEL (LDD), A14NEL (LUJ), A12XEL (L2Q)



54205

49,00€

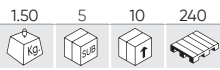

SET INSTRUMENTE DE REGLARE A MOTOARELOR PENTRU VAUXHALL/OPEL 1.6 CDTI

MĂRCI	VAUXHALL/OPEL: Astra J (13-18), Astra K, (15-19), GTC (15-18), Insignia A (15-17), Insignia- B (17-20), Meriva B (13-17), Mokka (14-16), Mokka X (16-20), Zafira C Tourer (13-19).
INSTRUMENTE OEM	EN-6349, EN-6130 (1), EN-51143 (2), EN-51140 (3), EN-50513 (4), EN-51188 (5)
CODURILE DE MOTOR	B16DTC, B16DTE, B16DTH, B16DTJ, B16DTL, B16DTN, B16DTR and B16DTU. D16DTH, D16DTI, D16DTJ, D16DTN, D16DTR, D16DTU

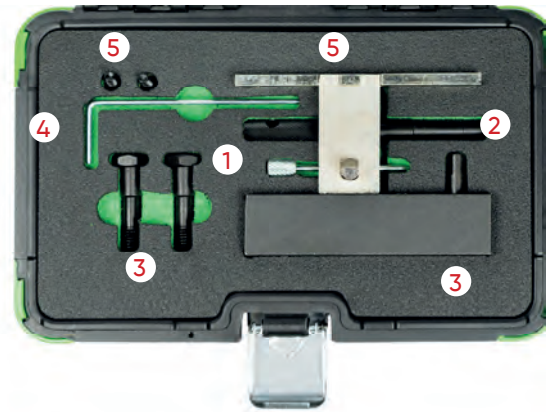

54214

96,00€

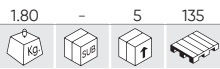

KIT DE ȘAIBE PENTRU OPEL/ISUZU 1.6D, 1.7D

MĂRCI	ASTRA, CAVALIES, VECTRA-A(87-00), ISUZU, NOVA, CORSA / COMBO, STRA, CAVALIER, VECTRA, FRONTERA, MONTEREY, MIDI, BRAVA (88-04)
INSTRUMENTE OEM	VAS 6079 (1), KM 951 (2), KM 851 (3), 23-029 (4), KM 661-2 (5), KM 661 (6)
CODURILE DE MOTOR	OPEL : 16DA, 17D, 17DR, X17DTL ISUZU : 4EC1, 4EE1, 4JB1, 4XJ1, 4JA1, 4JG1, 4FC1, 4FD1, 4FG1, Z17DT, Y17DT/DTL

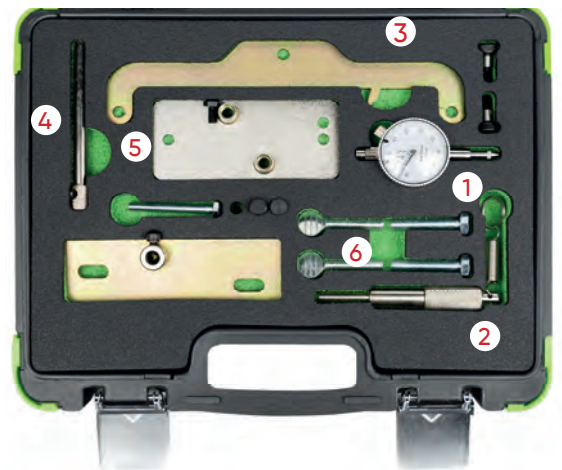

54217

104,00€



SET INSTRUMENTE DE REGLARE A MOTOARELOR PENTRU VAUXHALL/OPEL/SAAB 2.0, 2.2 DTI

MĂRCI	VAUXHALL/OPEL: ASTRA-G (98-06), FRONTERA-B (98-04), OMEGA-B, (98-03), SIGNUM (03-05), SINTRA (98-99), VECTRA-B (97-02), VECTRA-C (02-05), ZAFIRA-A (99-05), SAAB: 9-3 (98-04), 9-5 (02-06)
INSTRUMENTE OEM	SAAB: 83 95 394 (1), 83 95 337 (2), 83 95 352 (3), 83 95 386 (4) VAUXHALL/OPEL/SAAB: KM-927 (2), KM-929 (3), KM-932 (4), KM-933 (1)
CODURILE DE MOTOR	OPEL: X20DTH, X20DTL, Y20DTH, Y20DTL, X22DYH, Y22DTH, Y22DTR SAAB: D223L



54221

111,00€

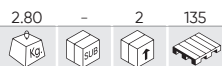

SET INSTRUMENTE DE REGLARE A MOTOARELOR PENTRU VAUXHALL/OPEL 1.3 CDTI

MĂRCI	VAUXHALL/ OPEL 1.3 CDTI Corsa E Diesel Engine From 2015
INSTRUMENTE OEM	KM-662-C (1), EN-50515 (2), EN-51500 (3), EN-46775 (4), KM-955-1 (5), EN-46785 (6)
CODURILE DE MOTOR	LKU B13DTE, LKU B13DTR



54434

48,50€



INSTRUMENT DE SINCRONIZARE PENTRU OPEL 1.0, 1.4

MĂRCI	VAUXHALL/OPEL ADAM 2014 - 2019, ASTRA-K 2015 - 2019, CORSA-E 2015 - 2019, INSIGNIA-B 2017 - 2020, MOKKA X 2016 - 2019, VIVA (KARL) 2015 - 2020
INSTRUMENTE OEM	EN-51367 (1) EN-51298 (2) EN-51632 (3)
CODURILE DE MOTOR	1.0 L5Q/B10XE, L5Q/D10XE, LE1/B10XFL, LE1/B10XFT, LE1/B10XFL, LE1/D10XFL, LE1/D10XFT, LE1/F10XFL, LE1/F10XFT, LWT/B10XL 1.4 LE2/B14XFL, LE2/B14XFT, LE2/D14XFL, LE2/D14XFT, LFE/B14XNT, LFE/D14XNT, LV7/B14XE 1.5 LFV/B15XHT, LFV/D15XHL, LFV/D15XHT

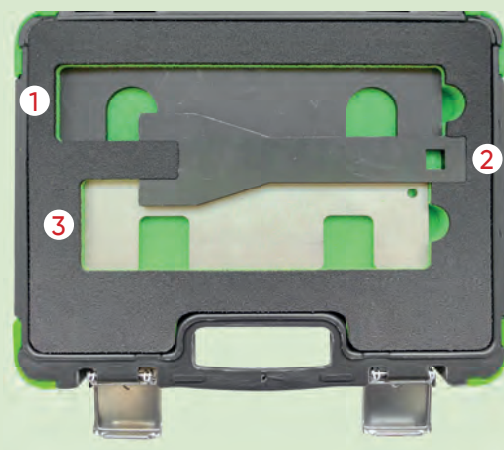

54435

14,50€



INSTRUMENT DE SINCRONIZARE PENTRU OPEL/CHEVROLET/SAAB 1.4, 1.6, 1.8 ECOTEC

MĂRCI	CHEVROLET: LACETTI (2005-2010), NUBIRA (2005-2010) OPEL/VAUXHALL: ASTRA-G (1998-2004), ASTRA-H (2004-2007), COMBO-C (2005-2012), CORSA-C (2000-2007), MERIVA-A (2003-2010), SIGNUM (2003-2007), TIGRA-B (2004-2010) VECTRA-B (1995-2002), VECTRA-C (2002-2008), ZAFIRA-A (1999-2005), ZAFIRA-B (2006-2013) SAAB: 9-3 (2003-2010)
INSTRUMENTE OEM	KM-911 (1) KM-6130 (2) KM-852 (3), EN-852 (3)
CODURILE DE MOTOR	1.4: X14XE, Z14XE 1.6: X16SEJ, X16XEL, Y16XE, Z16XE, Z16YNG 1.8: F18D3 1.8: X18XE1, Z18XE, Z18XEL, X18E1 1.8: Z18XE

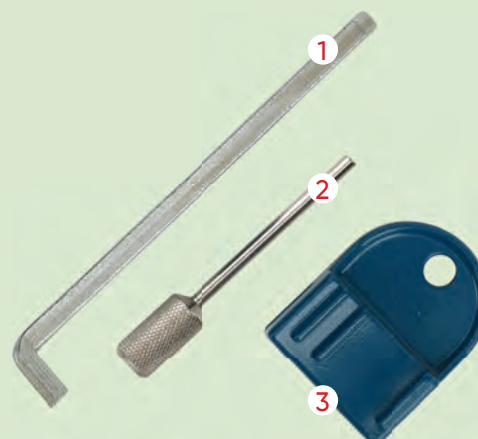

54436

124,00€



N

INSTRUMENT DE SINCRONIZARE PENTRU OPEL 1.6 SIDI

MĂRCI	VAUXHALL ASTRA-J 2013 - 2017,ASTRA-K 2015 - 2019,CASCADA 2013 - 2019,GTC 2015 - 2019,INSIGNIA 2013 - 2017,INSIGNIA-B 2018 - 2020,ZAFIRA-C TOURER 2014 - 2019
INSTRUMENTE OEM	EN 51153 (1) EN 50513 (2) EN 51148 (3) EN 51147 (4)
CODURILE DE MOTOR	1,6 LWC/A16SHT LVP/A16XHT LWC/B16SHL LWC/B16SHT LVP/B16XHT LWC/D16SHJ LWC/D16SHL LWC/D16SHT

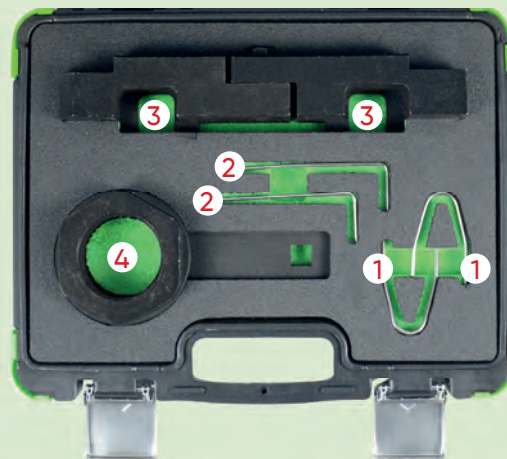

54437

110,00€



N

INSTRUMENT DE SINCRONIZARE PENTRU OPEL/CHEVROLET/SAAB 2.0, 2.4

MĂRCI	CHEVROLET CAPTIVA 2011 - 2015,HHR 2008 - 2009, MALIBU 2012 - 2015 SAAB 9-3 (02-12) 2010 - 2012,9-5 (10-12) 2010 - 2012 VAUXHALL/OPEL ANTARA 2011 - 2016,ASTRA-J 2012 - 2017,GTC (15-19) 2015 - 2019,INSIGNIA-A (08-17) 2008 - 2013
INSTRUMENTE OEM	EN-48585 (1) EN 43653 (2), J 43653 (2) EN 955 10 (3), KM 955 (3) EN-955-20 (4), KM 955-20 (4) EN 45027 1 (5), J 45027 1 (5) EN 45027 (6), EN45027 2 (6), J 45027 2 (6) EN 49212 (7), EN 49212 1 (7) EN 49212 (8), EN 49212 2 (8) EN 48953 (9)
CODURILE DE MOTOR	LHU/A20NFT 2.0: LDK/A20NHT 2.0: LDK/A20NHT, LHU/A20NET, LHU/A20NFT, LHU/B20NFT 2.4: A24XE (LE5), A24XF (LE9) 2.4: LE5,LE9

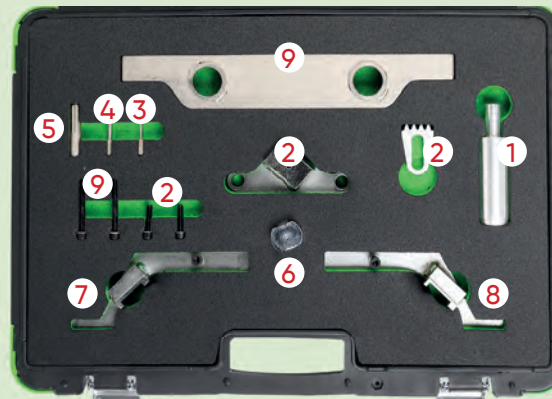

52271

18,00€

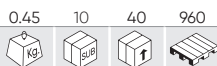

SET BLOCAJ DISTRIBUȚIE VAG

MĂRCI	AUDI: A2 1.4TDI (02-06), A3 1.9, 2.0TDI (02-08), A4 1.6TDI (02-05), A4 1.9, 2.0TDI (04-08), A6 1.9TDI (02-05). SEAT: ALTEA 1.9SDI/TDI (05-08), LEON 1.9,2.0TDI (05-08), TOLEDO 1.9SDI/TDI (05-08). SKODA: FABIA 1.4TDI (03-06), OCTAVIA II 2.0TDI (03-06) VW :BEETLE 1.9TDI (02-08), BORA 1.9TDI (02-08), FOX 1.4TDI (02-08), GOLF 1.9, 2.0TDI (02-08), LUPO 1.4TDI (02-08), POLO 1.4, 1.9TDI (02-08), SHARAN 1.9TDI (02-08).
INSTRUMENTE OEM	AUDI: AMF, ASZ, ATD, AVB, AVF, AWX, AXR, AZV, BHC, BKC, BKD, BKE, BLB, BMN, BNA, BPW, BRB, BR, BRD, BRE, BRF, BUY, BVA, BVF, BVG. SEAT: BJB, BKC, BLS, BMM, BXE SKODA: AMF, AZV, BKD VW: AJM, AMF, ANU, ARL, ASZ, ATD, AUJ, AVB, AVF, AWX, AXR, BAY, BMS, BNM, BNV, BWB



51489

12,00€

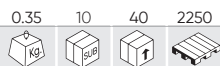

DISPOZITIV BLOCARE DISTRIBUȚIE VAG 1.4, 1.6

MĂRCI	VW: LUPO 99 , POLO 95, CADDY 96, POLO CLASSIC, VARIANT 96, BEETLE 1.4L 99, GOLF 1.4L, 1.6L 98 Y 1.4L, BORA, 1.6L 99. AUDI: A2.
INSTRUMENTE OEM	T10016
CODURILE DE MOTOR	1.4 / 1.6 16V



53274

30,50€



SET DISTRIBUȚIE PE LANȚ VOLKSWAGEN/SEAT/SKODA 1,2L

MĂRCI	VOLKSWAGEN 1.2: LUPO / POLO / EOS / FOX. SEAT 1.2: IBIZA / CORDOBA SKODA 1.2: FABIA
INSTRUMENTE OEM	T10123 (1) (2), T10120 (3), T10121 (4)
CODURILE DE MOTOR	AWY / BMD / AZQ / BME.



53275

35,50€

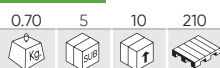

SET DISTRIBUȚIE PE LANȚ VW-AUDI

MĂRCI	DODGE: CALIBER (06-11) FORD: GALAXY (02-06) MITSUBISHI: GRANDIS (05-10), LANCER (05-10), OUTLANDER (07-10). SEAT: ALHAMBRA (00-15), ALTEA/ALTEA XL (04-15), CORDOBA (02-09), IBIZA (02-15), LEON (00-13), TOLEDO (04-11). SKODA: FABIA (00-14), FABIA II (07-15), OCTAVIA (00-10), OCTAVIA II (04-15), PRACTIK (10-15), RAPID (11-15), ROOMSTER (07-15), SUPERB (02-08), SUPERB II (08-15), YETI (09-14). AUDI: A1 (10-15), A2 (00-06), A3 (01-13), A4/ALLROAD (01-16), A5 (08-15), A6 (11-14), TT (08-14), Q3 (11-15), Q5 (08-15), A6 (10-14). VOLKSWAGEN: AMAROK (10-16), BEETLE (02-15), BORA (02-08), CADDY/MAXI (03-15), EOS (06-15), FOX (05-11), GOLF (02-15), GOLF PLUS (05-14), JETTA (05-15), LUPO (02-05), PASSAT/CC (02-15), POLO (99-14), SCIROCCO (08-14), SHARAN (02-15), TIGUAN (07-15), TOURAN (03-15), TRANSPORTER (03-17).
INSTRUMENTE OEM	DODGE: 9882, 9883. FORD: 310-085/23-059, 303-1054. MITSUBISHI: MB995206, MB995208, MB995209. VAG: T10100 (4), T10050 (1), 3359 (3/6)/T20102, T10115 (3), T10060A (2)/T40098, T20167.
CODURILE DE MOTOR	1.2D TDi CR: CFWA. 1.4D TDi PD: AMF, BAY, BMS, BNM, BNV, BWB. 1.6D TDi CR: CAYA, CAYB, CAYC, CAYD, CAYE, CLNA. 1.9D TDi PD: AJM, ANU, ARL, ASZ, ATD, AUY, AVB, AVF, AVQ, AWX, AXB, AXC, AXR, BJB, BKC, BLS, BLT, BMT, BPZ, BRM, BRR, BRS, BRU, BSU, BSV, BSW, BTB, BVK, BXE, BXF, BXJ. 2.0D TDi CR/TDi PD: AZV, BDJ, BDK, BEW, BGW, BHW, BKD, BKP, BKQ, BLB, BMA, BMM, BMN, BMP, BMR, BNA, BPW, BRA, BRC, BRD, BRE, BRF, BRT, BSS, BST, BSY, BUJ, BUZ, BVA, BVE, BVF, BVG, BVH, BWC, BWV, CAAA, CAAB, CAAC, CAAD, CAE, CAG, CAGB, CAGC, CAHA, CAHB, CBAA, CBAB, CBAC, CBBA, CBBB, CBDA, CBDB, CBDC, CBEA, CCHA, CCHB, CDBA, CDCA, CEGA, CFCA, CFFA, CFFB, CFFD, CFFE, CFGB, CFGC, CFHA, CFHB, CFHC, CFHD, CFHE, CFHF, CFJA, CGLA, CGLB, CGLC, CGLD, CJAA, CJCA, CJC, CJC, CJC, CLCA, CLCB, CLJA, CLLA, CNEA, ECD, ECD/BSY, ECD/BYL, ECE/BWD.

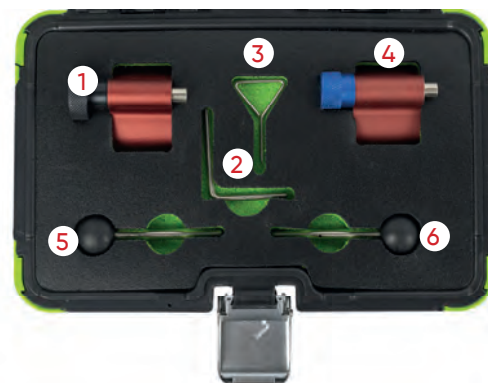

53276

160,00€

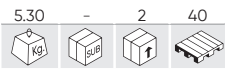

SET DISTRIBUȚIE PE LANȚ AUDI SKODA

MĂRCI	MOTOR AUDI, VW: V6 2.0, 2.8, 3.0T FSI. AUDI QS: 2.0, A6L 2.8, 3.0T.
INSTRUMENTE OEM	3418 (1), 3458 (2), T10100 (3), T10123 (4), T10121 (5), 3242 (6), 3551 (8), T10020 (9), T10098 (10), 3078 (12), 2064 (13), 3369 (14), T10092 (15), T40011 (17), 2065A (18), T10016 (19), 3359 (20), T10008 (21), T10050 (22) T10265 (23), T10264 (24), T10060A (25), T10120 (27), 3366 (28)
CODURILE DE MOTOR	2.0, 2.8, 3.0

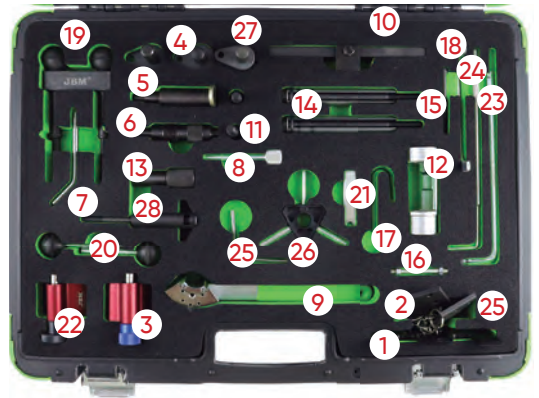

53277

45,00€

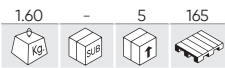

SET DE UNELTE PENTRU CUREA DE DISTRIBUȚIE VW-AUDI

MĂRCI	BENZINĂ	AUDI: 80, 100, A3, A4, A6 1.6, 1.8/TURBO, 2.0, 2.0 16V, A3, A4 1.6 (96-). SEAT: IBIZA/CORDOBA, TOLEDO, ALHAMBRA, INCA 1.6, 1.8, 1.8 16V, 2.0, 2.0 16V, IBIZA/ CORDOBA, LEON, TOLEDO 1.6 (99-), ALHAMBRA 2.0 (00-). VOLKSWAGEN: POLO CLASSIC, SCIROCCO, CORRADO, GOLF, JETTA, VENTO, PASSAT, SHARAN, TRANSPORTER 1.6, 1.8/TURBO, 1.8 16V, 2.0, 2.0 16V, POLO CLASSIC, GOLF, BORA, BEETLE 1.6 (97-), 2.0 (99-). SKODA: OCTAVIA 1.6 (97-), 2.0 (99-).
	DIESEL	AUDI: 80, 100, A3, A4, A6 1.9 TURBO D, 1.9TDI, 2.5TDI, A3, A4, A6 2.0TDI, A2, A3, A4, A6 1.2TDI, 1.4TDI, 1.9TDI (99-). SEAT: IBIZA/CORDOBA, LEON, TOLEDO, ALHAMBRA, INCA 1.7SDI, 1.9D/TD /SDI/TDI. EQRD: GALAXY (02-06). SKODA: FELICIA, OCTAVIA 1.9D/TDI. VW: POLO, POLO CLASSIC, GOLF, JETTA, VENTO, BORA, BEETLE, PASSAT, SHARAN, CADDY, TRANSPORTER 1.5D, 1.6D/ TURBO, 1.7D/SDI, 1.9SDI/TDI, GOLF, PASSAT 2.0TDI.
INSTRUMENTE OEM	T10020 (1), 3387 (2), V159 (3), T10060/T100604 (4), T10115 (5), T40011 (6)	
CODURILE DE MOTOR	2.0, 2.8, 3.0	



53278

143,00€



SET DISTRIBUȚIE PE LANȚ AUDI 2.8, 3.2 FSI, 3.0 TFSI

MĂRCI	A2, A4, A4 QUATTRO, A6 (2004-2007) A2, A3, A4, A3 FSI (2004-2007) A4, A6, A8 3.2 FSI A6 L QUATTRO 2.4 A6 2.4, A6 2.4 QUATTRO (2004-2007) A4 3.2 FSI (2004-2007) A6 3.2 FSI (2004-2007) A8 3.2 FSI (2005-2007)
INSTRUMENTE OEM	T10172 (1), 3212 (2), T40070 (3), T40069 (4), T40071 (5), T10172/2 (6)
CODURILE DE MOTOR	AUK / BDW / BDX / BKH / CAJA / CALA

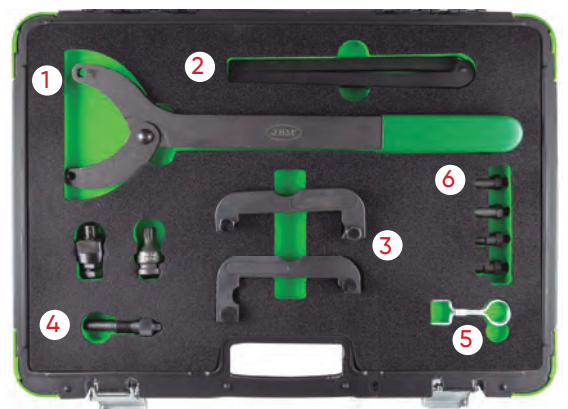

53279

97,00€

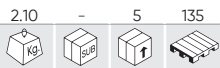

SET DISTRIBUȚIE PE LANȚ VW/AUDI 1.8, 2.0, TSI, TFSI

MĂRCI	AUDI: A3 (96-09), A4 (94-09), A6 (95-11), S3 (99-13), TT (98-14). SEAT: ALHAMBRA (97-10), ALTEA/ALTEA XL (06-09), CORDOBA (99-02), EXEO (09-10), IBIZA (99-02), LEON (99-13), TOLEDO (99-09). SKODA: OCTAVIA/OCTAVIA TOUR (98-10), OCTAVIA II (04-09). VOLKSWAGEN: BEETLE (99-11), BORA (97-04), EOS (06-10), GOLF (97-12), GOLF PLUS (05-09), JETTA (05-09), PASSAT (96-10), SCIROCCO (09-14), SHARAN (97-10), TOURAN (03-09).
INSTRUMENTE OEM	T10020 (1), T10252 (2), T10092 (3), T10115 (4), T40011 (4), 3366 (5), T10060 (6)
CODURILE DE MOTOR	1.8: ADR, AFY, AGN, AJP, APG, APT, AQE, ARG, ARH, AVV. 1.8T: AEB, AGU, AJH, AJL, AJQ, AMK, AMU, ANB, APP, APU, APX, APY, AQA, AQX, ARX, ARY, ARZ, AUM, AUQ, AVC, AWC, AWWT, AWU, AYP, BAM, BFV, BVP, BVR. 2.0 TSI: AXW, BHD, BLR, BLX, BLY, BMB, BVX, BVY, BVZ. 2.0 TFSI/S/R/TSI: AXX, BPY, BWA, BGB, BPG, BPJ, BUL, BWE, BWT, BYK, BHZ, BZC, BWJ, BYD, CDLA, CDLB, CDLC, CDLD, CDLF, CDMA.



53280

112,00€



SET ALINIERE PT ARBORELE CU CAME VW/AUDI 3.0 V6

MĂRCI	AUDI: A4 (01-08), A6 (01-08), A8 (03-10).
INSTRUMENTE OEM	3387 (1), T40030 (2) (4), T40026 (3), T40028 (5)
CODURILE DE MOTOR	3.0 V6 30V: ASN, AVK, BBJ, BGN.



53281

55,00€



SET ALINIERE PT ARBORELE CU CAME VW/AUDI

MĂRCI	VOLKSWAGEN: 2.5 TDi V6 AUDI: A4, A6, A8
INSTRUMENTE OEM	3369 (1), 3242 (2), 3458 (3)
CODURILE DE MOTOR	AFB/AKN



53282

48,00€

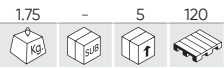

SET DE TURNARE VAG GRUP 1.2, 1.4, 1.6

MĂRCI	SEAT: ALHAMBRA (10-15), ALTEA/ALTEA XL (08-15), IBIZA/ CORDOBA (08-12), LEON (07-13), TOLEDO (07-15). VOLKSWAGEN: BEETLE (11-15), CADDY/CADDY MAXI (10-15), EOS (06-12), GOLF (03-12), GOLF PLUS (03-14), GOLF V ESTATE (07-13), GOLF VI CABRIOLET (10-15), JETTA (06-14), PASSAT (05-11), POLO (02-14), SCIROCCO (08-12), TIGUAN (07-12), TOURAN (03-15). SKODA: FABIA II (07-15), OCTAVIA II (04-15), PRAKTIK (10-15), RAPID (12-15), ROOMSTER (06-15), SUPERB II (09-14), YETI (09-14). AUDI: A1 (10-15), A3 (03-13).
INSTRUMENTE OEM	T10171 (1), T10170 (2), T40011 (3)
CODURILE DE MOTOR	1.2 TFSI: CBZA, CBZB, CBZC. 1.4 FSI: AXU, BKG, BLN. 1.4 TFSI: BLG, BMY, BWK, CAVA, CAVB, CAVC, CAVD, CAVE, CAVF, CAXA, CAXC, CDGA, CSMA. 1.6 FSI: BAG, BLF, BLP, BTS.



53283

92,00€



KIT DE ȘTANȚARE GRUP VAG 2.7, 3.0 TDI

MĂRCI	VOLKSWAGEN: TOUAREG, PHATEON VAG: DIESEL 2.7 / 3.0 V6 AUDI: A4, A5, A6
INSTRUMENTE OEM	3242 (1), T40060 (2) (3), 3359 (4), T40058 (5), T40061 (6), T40062 (7), T40049 (8)
CODURILE DE MOTOR	ASB, BKN, BKS, BWZ, BNG, BPP, BSG, BUG, BUN, CAWA, CAMB, CANA, CANB, CANC, CAND, CAPA, CARA, CARS, CASA, CASE, CASC, CAM, CC/HA, CCWA, CCWB, CDYA, CDVB, CDVC, CEXA, CGKA, CGKB.

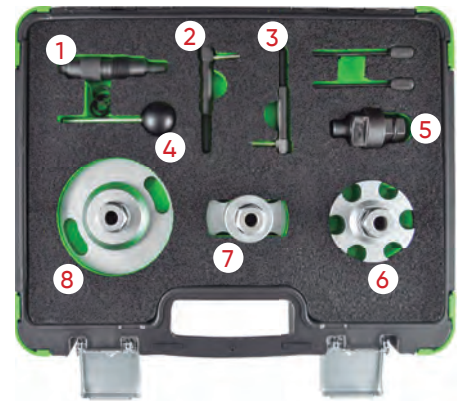

53284

306,00€

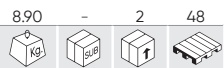

KIT DE FRETARE GRUP VAG 2.5 TDI

MĂRCI	VOLKSWAGEN: TOUAREG (03-10), TRANSPORTER (03-09).
INSTRUMENTE OEM	T10225 (1), T10199 (2), T10234 (3), T10226 (4), T10193 (5), T10194 (6), T10199/01 (7), T10226 (8)
CODURILE DE MOTOR	2.5D TDI PD: AXD, AXE, BAC, BLJ, BLK, BNZ, BPC, BPD, BPE.

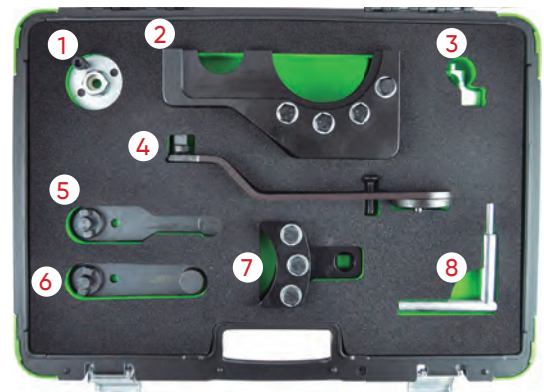

53285

56,00€

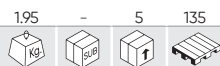

SET DISTRIBUȚIE PE LANȚ VAG 2.4, 2.5, SDI, TDI

MĂRCI	VOLKSWAGEN: CRAFTER (06-13), LT (96-06), TRANSPORTER (90-03).
INSTRUMENTE OEM	2065A (1), T50009 (2), T10025 (3), 3248/3419 (4), 2064 (5), 3355 (6)
CODURILE DE MOTOR	2.4D: AAB, AJA. 2.5D SDI: AGX. 2.5D TDI: ACV, AHD, AHY, AJT, ANJ, APA, AUF, AVR, AXG, AXL, AYC, AYY, BBE, BBF. 2.5D TDI CR: BJJ, BJK, BJL, BJM.



53286

87,00€



SET DISTRIBUȚIE PE LANȚ VAG 1.8, 2.0 TSI, TFSI

MĂRCI	VOLKSWAGEN: 1.8 / 2.0 TSI / TFSI.
INSTRUMENTE OEM	T10368 (2), T10354 (3), T40271 (1)(4), T10352/2 (5), T10352/1 (6), T10352 (7), T40196 (8) (9) (10) (11), T40267(12) (13), T40098 (14), T10060A (15), T40011 (15)
CODURILE DE MOTOR	BYT, BZB, CABA, CABB, CABD, CADA, CAEA, CAEB, CAWA, CAWB, CBFA, CCTA, CCZA, CCZB, CCZC, CDA, CDAB, CDHA, CDHB, CDNB, CDNC, CDND, CESA, CETA, CFKA, CGYA, CJEB, CJBA, CJSB.

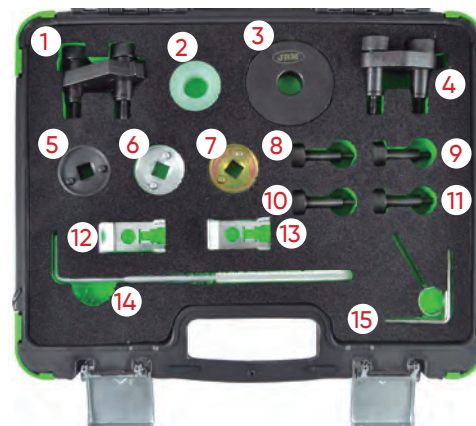

53287

245,00€



SET DISTRIBUȚIE PE LANȚ VW/AUDI 1.8, 2.0L TURBO

MĂRCI	VOLKSWAGEN AUDI	1.8 / 2.0 TURBO
INSTRUMENTE OEM	T10355 (1), T40196 (2), T40271 (3) (4), T10352 (5), T10352/1 (6), T10352/2 (7), T10368 (7), T40267 (8), T10354 (9), T40265 (10), T40011 (11) (14), T40098 (12), T10060A (13)	
CODURILE DE MOTOR	BYT, BZB, CABB, CABD, CADA, CAEA, CAEB, CAWA, CAWB, CBFA, CCTA, CCZA, CCZB, CCZC, CDA, CDAB, CDHB, CDNB, CDNC, CDND, CESA, CETA, CFKA, CGYA, CJEB, CJA, CJSB.	

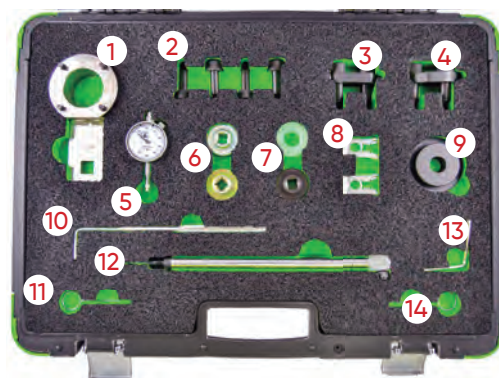

53288

72,00€

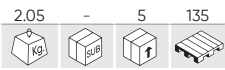

SET DISTRIBUȚIE PE LANȚ VAG VAG 1.6, 2.0 TDI COMMON RAIL

MĂRCI	SEAT: EXEO, LEON, ALTEA, TOLEDO, IBIZA. VOLKSWAGEN: JETTA, TOURAN, GOLF, GOLF PLUS, POLO, PASSAT, TIGUAN, SCIROCCO. SKODA: ROOMSTER, FABIA, PRAKTIK, OCTAVIA, YETI, SUPERB. AUDI: A1, A3, A4, A5, Q5, A6, TT.
INSTRUMENTE OEM	T10264 (1), T10265 (2), T20102 (3), T10052 (4), T10051 (5), T10255 (6), T10050 (7), T10100 (8), T40098 (9)
CODURILE DE MOTOR	1.2 TDI CR, 1.6 D TDI CR, 2.0 D TDI CR CAGA, CAGB, CAGC, CAHA, CAHB, CFHC, CBAA, CBAB, CFFB, CGLA, CGLB, CJCA, CJCB, CAAA, CBAA, CBAB, CBAC, CBBA, CBBB, CBDA, CBDB, CBDG, CCHA, CEGA, CJAA, CAAB, CAAC, CFJA, CFWA, CAYB, CAYC, CAYA.

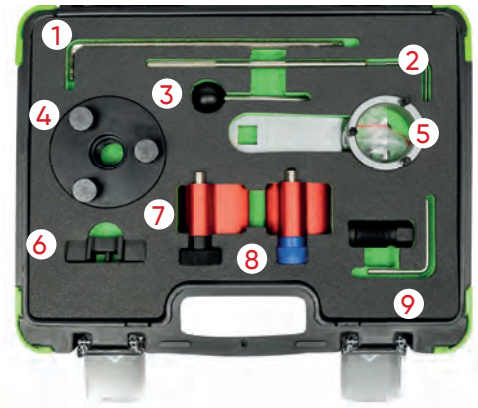

53320

12,00€

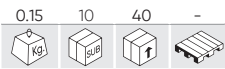

UNEALTĂ DE BLOCAJ PT ARBORELE CU CAME GRUP VAG

MĂRCI	SEAT: ALHAMBRA, ALTEA, AROSA, CORDOBA, IBIZA, LEON, TOLEDO 1.4/1.9/2.0 TDI. VW: PASSAT 1.9. AUDI: A4/A6 1.9.
INSTRUMENTE OEM	T10008, T20102, T10100.



53321

10,50€

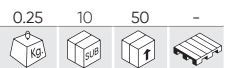

UNEALTĂ PT REGLAREA TENSIUNII CURELEI VAG

MĂRCI	AUDI: A4/1.8T, 2.0 1999-2004 A6/1.8T 2002-2004 A4/3.0 (2002 -), A6/3.0 (2002 -), A8/7.0 (2003 -). VW: GOLF PASSAT 2.0 TDI DIESEL, GOLF 88-97, PASSAT 92-97, VW T4/2.0 1992-2004.
INSTRUMENTE OEM	T10020



53325

7,50€

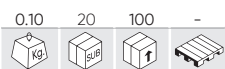

UNEALTĂ DE SINCRONIZARE A FULIILOR VW AUDI 35MM

MĂRCI	AUDI: 100 ('91-), A6 (2.5 TDI) 2.3, 2.4, 2.5, 2.8, 2.9D TDI (1991-2003) VW: LT, TRANSPORTER
INSTRUMENTE OEM	3355
CODURILE DE MOTOR	AAB, AAT, ACU, ACV, AEL, AET, AGX, AHG, AHY, AJA, AJT, ANJ, APA, APL, AUF, AVT, AXG, AXL, AYC.



53326

16,00€

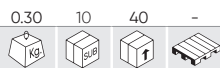

SET DISTRIBUȚIE PE LANȚ VW/AUDI

MĂRCI	VW: V6 2.5TDi. AUDI: V6 2.5TDi, V8 3.3TDi.
INSTRUMENTE OEM	3458 (1), 3242 (2)



53327

11,00€



SET DISTRIBUȚIE PE LANȚ VAG 1.2

MĂRCI	SEAT: IBIZA 1.2 6V/3CYL (2002-09), CORDOBA 1.2 12V/3CYL (2002-13). VW: POLO 1.2 6V-12V/3CYL (2002-14). SKODA: FABIA 1.2 6V-12V/3CYL (2002, 2003-), FABIA II 1.2 6V/3CYL (2007-13), ROOMSTER 1.2 12V/3CYL (2006-13), PRAKTIK 1.2 6V/3CYL (2007-13).
INSTRUMENTE OEM	T10123
CODURILE DE MOTOR	1.2 6V: AWY, BMD, BBM, CHFA, CHFB 1.2 12V: AZQ, BME, BVX, BZG, CEVA, CGPA, CGPB, CGPC.



53648

107,00€



SET FIXARE DISTRIBUȚIE PENTRU VAG 1.0, 1.2, 1.4 TSI

MĂRCI	AUDI: A1 (12-15), A1 SPORTBACK (12-15), A3 (13-15), A3 SPORTBACK (12-15). SEAT: IBIZA (12-15), LEON (12-15), TOLEDO (12-15). SKODA: FABIA (10-13), OCTAVIA II (10-13), OCTAVIA III (10-15).
INSTRUMENTE OEM	T10060A (1), T10340 (2), T10476 (3), T10494 (4), T10499 (5), T10504/1 (6), T10504 (7), T10504/2 (8).
CODURILE DE MOTOR	1.2 TSI: C.JZA, C.JZB. 1.4 TSI: CGGA, CHPA, CMBA, CPVA, CRJA, CXSA. 1.4 TSI ACT: CPTA.

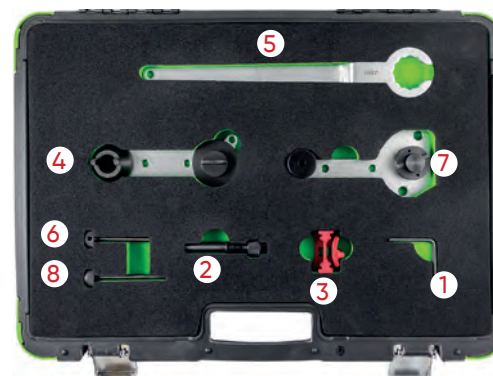

53649

89,00€

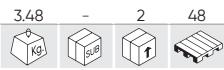

SET DE SCULE PENTRU SINCRONIZAREA MOTORULUI VAG GROUP

MĂRCI	AUDI SEAT	SKODA VW
INSTRUMENTE OEM	T10340 (1), T10476 (2), T10477 (3), T10487 (4), T10494 (5), T10499 (6)	
CODURILE DE MOTOR	1.0 MPI: CHYA. 1.0 TSI: CHZE, CHZC, CHZA, CHZB, CHZC, CHZD, CHZJ. 1.2 TSI: CJZB, CJZC, CYVA, CJZA, CJZD, CYVB. 1.4 TSI: CZCC, CMBA, CZCA, CHPA, CPTA (ACT), CZDA, CVNA, CZEA (ACT).	

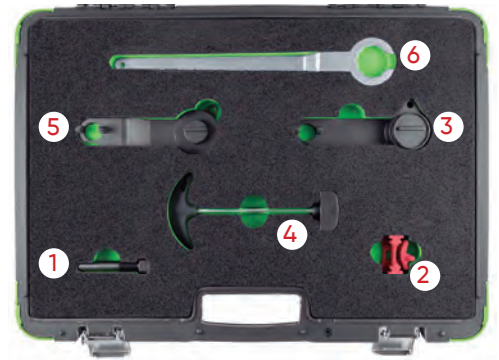

53706

98,00€

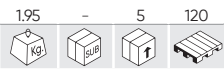

KIT DE INSTRUMENTE DE ALINIARE A ARBORELUI CU CAME VAG 1.4, 1.6, 2.0 TDI COMMON RAIL

MĂRCI	VOLKSWAGEN: GOLF ALLTRACK, GOLF SPORTSVAN, GOLF VII, GOLF VII KOMBI, PASSAT, POLO. AUDI: A1, A1 SPORTBACK, A3, A3 CABRIOLET, A3 LIMOUSINE, A3 SPORTBACK, TT, TT ROADSTER. SEAT: IBIZA, IBIZA V SPORTCOUPE, IBIZA V ST, LEON, LEON SC, LEON ST, TOLEDO IV. SKODA: FABIA, FABIA KOMBI, OCTAVIA, OCTAVIA COMBI, RAPID, RAPID SPACEBACK.
INSTRUMENTE OEM	OEM 3204 (1), OEM 3359 (2), OEM T10490 (3), OEM T10051 (4), OEM T10060A (5), OEM T10264 (6), OEM T10265 (7), OEM T10492 (8), OEM T40098 (9).
CODURILE DE MOTOR	1.4, 1.6, 2.0 TDI CR CXXB, DBKA, DCXA, CGLE, CKFB, CKFC, CLHA, CLHB, CNHA, CNHC, CRBD, CRFA, CRFC, CRKA, CRKB, CRLB, CRLC, CRMB, CRUA, CRVA, CRVC, CSUA, CSUB, CUNA, CUPA, CUSA, CUSB, CUTA, CUUD, CXEB, DBKA, DCXA, DCZA, DFSD.

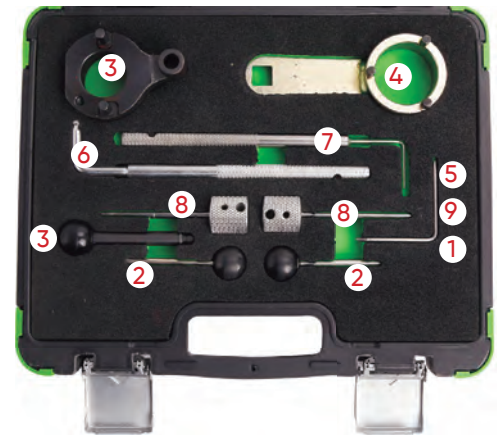

54092

24,00€



SET DE CONTROL ȘI REGLARE FAZA DE DISTRIBUȚIE GAZE PENTRU MOTOR 1.2 TFSI PRODUCĂTOR VAG

MĂRCI	AUDI: A1, A3, A3 SPORTBACK, A3 CABRIO SEAT: ALTEA, ALTEA XL, IBIZA, LEON, TOLEDO SKODA: FABIA II, OKTAVIA II, PRAKTIK, RAPID, RAPID SPACEBACK, ROMMSTER, YETI VW: BEETLE, CADDY, CADDY MAXI, GOLF PLUS, GOLF VI, GOLF VI CABRIO, GOLF VI ESTATA, JETTA, POLO, TOURAN
INSTRUMENTE OEM	T10340(1), T10414(2), T10341(3)
CODURILE DE MOTOR	CBZA, CBZB, CBZC



54199

94,00€

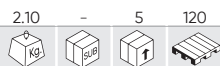

SET INSTRUMENTE DE REGLARE A MOTOARELOR PENTRU VAG TFSI, FSI

MĂRCI	AUDI: A1 (10-15), A1 SPORTBACK (10-15), A3 CABRIOLET (10-13), A3 (10-15), A3 SPORTBACK (03-13) SEAT: ALTEA/ALTEA XL (10-15), IBIZA (10-15), LEON (10-13), TOLEDO (12-15) SKODA: FABIA II (10-15), PRAKTIK (10-15), RAPID (12-15), RAPID SPORTBACK (12-15), OCTAVIA II (04-13), YETI (09-15), YETI OUT-DOOR (13-15) VW: BEETLE (11-15), CADDY/CADDY MAXI (10-15), EOS (07-15), GOLF V (03-13), GOLF V ESTATE (07-09), GOLF VI (10-13), GOLF VI ESTATE (10-13), GOLF VI CABRIOLET (11-15), GOLF PLUS (05-14), JETTA (05-14), PASSAT (05-15), POLO (09-14), SCIROCCO (08-14), TIGUAN (07-15), TOURAN (03-15)
INSTRUMENTE OEM	T10414 (1), VAS 6079 (2), T10170 (3), T10171/ T10171A (4), T40011 (5), T10340 (6), T10341 (7)
CODURILE DE MOTOR	1.2 TFSI: CBZA, CBZB, CBZC 1.4 FSI/TFSI: BLG, BMY, BWK, CAVA, CAVB, CAVC, CAVD, CAVE, CAVF, CAXA, CAXC, CDGA, CSMA 1.6 FSI: BAG, BLF, BLP



54218

142,00€



INSTRUMENT DE ASAMBLARE A AMORTIZORULUI DE VIBRAȚIE VAG

MĂRCI	AUDI, SEAT, SKODA, VOLKSWAGEN
INSTRUMENTE OEM	T10531/1 (1), T10531/2 (2), T10531/3 (3), T10531/4 (4)
CODURILE DE MOTOR	1.8L TFSI: BZB, CDAA, BPU, BYT, CABA, CABB, CDHA, CDHB, CABD, DAJB, CJSB, CJSB, CJEB, CJEE, CJED, CYGA, CDAC, CJSC, CGYA, DAJA 2.0L TFSI: CAWB, CCZA, CBFA, CCTA, CDNB, CDNC, CDND, CJXA, CJXE, CJXH, CHHB, CHHA, CULA, CFKA, DEDA, CHJA, CAWA, CCZC, CCZD, CPSA, CJK, CJKB, CESA, CETA, CFPA, CNCD, CPLA, CYRB, CYRC; CNCE, CYNB, CYPB, CULB, CULC, CNCB, CWZA, CJXF, CJXC, CJXB, CJXG, CHHC, CCZB

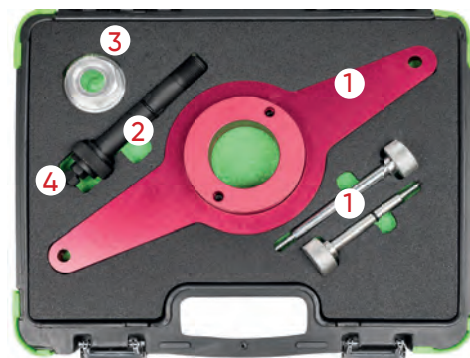

54407

397,00€

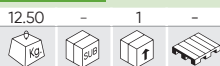

SET DE SCULE PENTRU ASAMBLAREA ARBORELUI CU CAME PENTRU VAG/PORSCHE

MĂRCI	AUDI, PORSCHE, SEAT, SKODA, VOLKSWAGEN 1.2 - 1.6 - 2.0 - 2.7 - 3.0 - 4.0 - 4.2 COMMON RAIL
INSTRUMENTE OEM	T40094, T40094/1 (1), T40094/2 (2), T40094/3 (3), T40094/4 (4), T40094/5 (5), T40094/6 (6), T40094/7 (7), T40094/8 (8), T40094/9 (9), T40094/10 (10), T40094/11 (11), T40094/12 (12), T40095 (13), T40096 (14), T40096/1 (15)
CODURILE DE MOTOR	ASB, ASE, BKN, BKS, BMK, BNG, BPP, BSG, BTR, BUG, BUN, BVN, CAAA, CAAB, CAAC, CAAD, CAAE, CAGA, CAGB, CAGC, CAHA, CAHB, CAMA, CAMB, CANA, CANB, CANC, CAND, CAPA, CARA, CASA, CASB,CASC, CASD, CATA, CAYA, CAYB, CAYC, CAYD, CAYE, CBAA, CBAB, CBAC, CBBA, CBBB, CBDA, CBDB, CBDC, CCFA, CCFC, CCHA, CCHB, CCLA, CCMA, CCWA, CCWB, CDBA, CDCA, CDSB, CDTA, CDTB, CDUC, CDUD, CDYA, CDYB, CDYC, CEGA, CEXA, CFCA, CFFA, CFFB, CFFD, CFFE, CFGB, CFGC, CFGD, CFHA, CFHB, CFHC, CFHD, CFHE, CFHF, CFJA, CFWA, CGKA, CGKB, CGLA, CGLB, CGLC, CGLD, CGLE, CGQB, CJAA, CJCA, CJCB, CJCC, CJCD, CJGA, CJGC, CJGD, CJMA, CKDA, CKTB, CKTC, CKUB, CKUC, CKVB, CKVC, CLAA, CLAB, CLCA, CLCB, CLJA, CLLA, CLNA, CLZB, CMEA, CMFA, CMFB, CMGB, CMHA, CNEA, CNFA, CNRB, CRCA,CSHA, M05/9D(CAS), M05/9E, M05/9E(CRCA), M05/9E(CRCB)

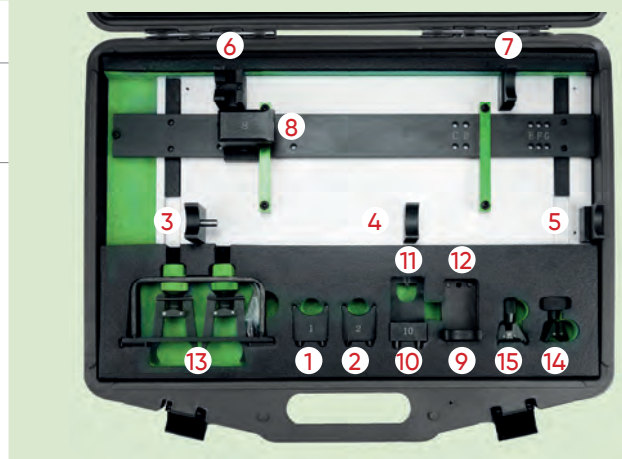

54408

46,00€

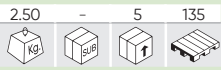

N

SET DE UNELTE PENTRU SINCRONIZAREA MOTORULUI VAG DIESEL 1.7, 1.9, SDI, TDI

MĂRCI	AUDI: A3, A4, A6, CABRIOLET, SEAT: ALHAMBRA, AROSA, CORDOBA, IBIZA, INCA, LEON, TOLEDO, SKODA: FELICIA, OCTAVIA VW: BORA, CADDY, FOX, GOLF, LT, LUPO, PASSAT, POLO, SHARAN, TRANSPORTER, VENTO
INSTRUMENTE OEM	T1020 (1), 2587 (2), 2065A (3), T20044 (4), T10098 (5), T40011 (6), 2064 (7), T3359 (8), T10092 (9), M5x60M (10)
CODURILE DE MOTOR	1.7TDi/SDi: AHB, AHG, AKU, AKW 1.9TDi/SDi: 1X, 1Y, 1Z, ABL, AAZ, AEF, AEY, AFF, AFN, AGD, AHF, AHH, AHU, AGP, AGR, ALE, ALH, AQM, ASV, ASY, ASX, AVG, AYQ 2.4D: 1G, 1S, DW, DV, ACL, ACT

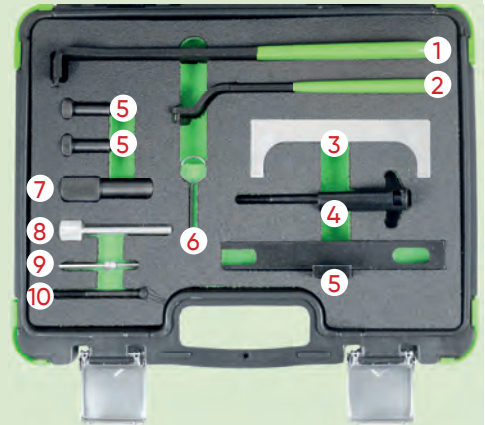

54409

32,00€

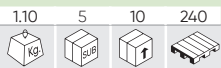

N

INSTRUMENT DE SINCRONIZARE PENTRU VAG 1.4 TSI

MĂRCI	ATECA (2016-) A3 (2012-) SUPERB (2015-) A1 SPORTBACK (2012-2018) LEON/LEON ST (2012-2020) MK5 (2012-2018) Q2 (2016-) Q3 (2015-2018)
INSTRUMENTE OEM	T10340 (1) T10504 (2) T10504/1 (3) T10504/2 (4)
CODURILE DE MOTOR	1.4 TFSI (CoD)-CPTA, CZEA 1.4 TSI (ACT)-CPTA, CZEA

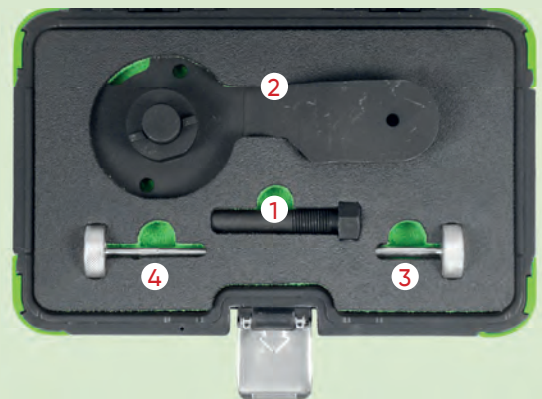

54410

33,50€



N

INSTRUMENT DE SINCRONIZARE PENTRU VAG 2.4, 3.2 FSI

MĂRCI	AUDI: A4, A5, A6, A7, A8, Q5, Q7, R8, RS4, RS5, RS6, S4, S5, S6, S8 VW: TOUAREG
INSTRUMENTE OEM	T40058 (1) T40069 (2) T40071 (3) T40133 (3) T40133/1 (3) T40133/1/2 (3) T40133/2 (3) 40071 (4)
CODURILE DE MOTOR	2.4: BDW 3.2: AUK, BKH, BPK 4.2: BAR, BNS, BVJ, CAUA, CDRA, CFSA, BYH, CNDA 5.0: BUH 5.2: BSM, BUJ, BXA, CMPA, CTPA, CTYA

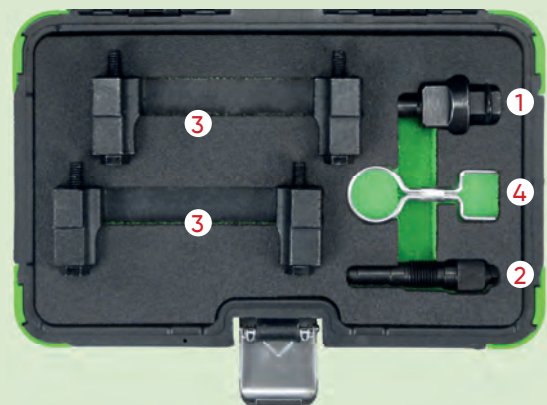

INSTRUMENTE DE SINCRONIZARE

54411

36,00€



N

INSTRUMENT DE SINCRONIZARE PENTRU VAG/PORSCHE 2.4, 2.8, 3.0 TFSI

MĂRCI	AUDI: A4 (2011-2015) A5 (2007-2017) A6 (2007-2018) A7 (2010-2018) A8 (2010-2018) A8 (2010-2018) Q7 (2010-2018) S4 (2009-2017) S5 (2010-2017) S5 (2010-2017) Q5 (2008-2017) SQ5 (2013-2018) PORSCHE: CAYENNE (2010-2014) PANAMERA 2011-2013 VAG: TOUAREG (2010-2014)
INSTRUMENTE OEM	T40133/1 (1) T40133/2 (2) T40058 (3) T40069 (4) T40071 (5)
CODURILE DE MOTOR	AUDI: 2,5 CLXB, CAAA 2,8 BDX, CCDA, CCEA, CHVA, CJBA, CNYA 3,0 CAJA, CAKA, CCAA, CGEA, CGWA, CGWB, CGWC, CGWD, CGXB, CGXC, CHMA, CHMB, CJTB, CJTC, CJWC, CMDA, CMUA, CNA, CREA, CREC, CRED, CTTA, CTUA, CTUD, CTVA, CTWA, CTXA 3,2 CALA, CALB PORSCHE: 3,0 M06/EC VAG: 3,0 CJTA, CGFA

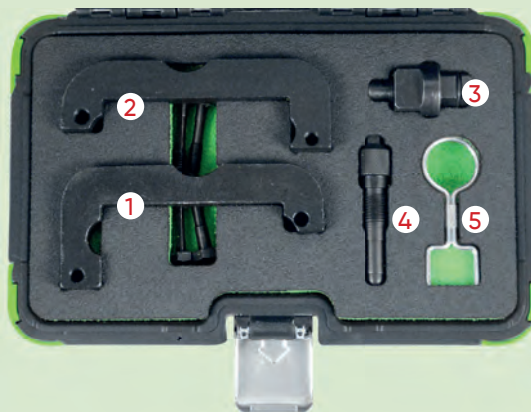

54412

57,00€



N

INSTRUMENT DE SINCRONIZARE PENTRU AUDI 2.5 TFSI

MĂRCI	AUDI: RSQ3 (2013-2015), RSQ3 (2015-2018), RS3 (2010-2013), RS3 (2015-2017), TT (2009,2014)
INSTRUMENTE OEM	T03003 (1) T40264/1/2 (2), T40264/2A (2) T40069 (3) T40011 (4) T40297 (5)
CODURILE DE MOTOR	2,5 TFSI/RS CEPA, CEPB, CTSA, CZGA, CZGB

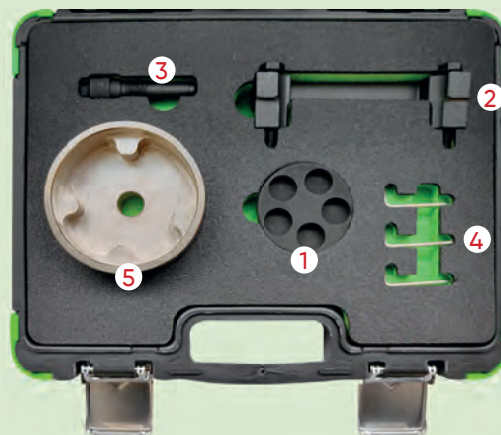

54413

115,00€



N

INSTRUMENT DE SINCRONIZARE PENTRU AUDI 4.0 FSI, TFSI

MĂRCI	AUDI: A8, RS6, RS7, S6, S7, S8 (2012-2018)
INSTRUMENTE OEM	T40071 (1) T40257 (2) T40264/1 (3) T40264/2 (4) T40264/3 (5) T40269 (6) T40272 (7)
CODURILE DE MOTOR	CEUA CEUC CGTA CRDB CTFA CTGA CTGE CWUB CWUC DDTA

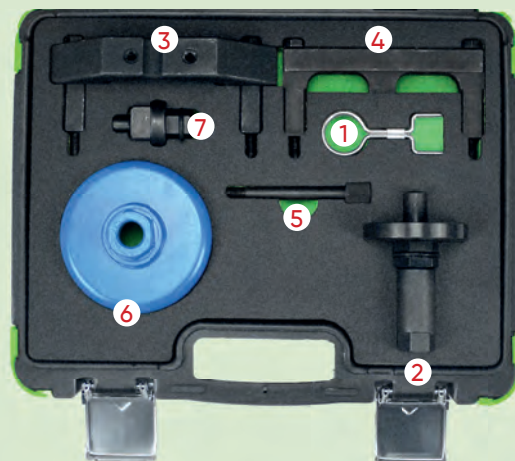

54431

184,00€



N

INSTRUMENT DE SINCRONIZARE PENTRU ALFA ROMEO/MASERATI 2.9

MĂRCI	ALFA ROMEO: GIULIA, STELVIO MASERATI: 3,8T
INSTRUMENTE OEM	1860815000 (1) 2024000090 (2) 2024100000 (3)
CODURILE DE MOTOR	2.9: 670050436,670051007 ,670052721 ,670052722

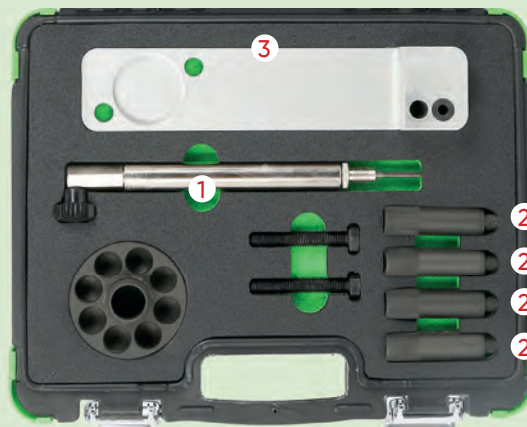

53315

285,00€



KIT DISTRIBUȚIE PE LANȚ VOLVO 3.0, 3.2T6 / LAND ROVER 3.2

MĂRCI	VOLVO: S60 (10-16), S80 (07-15), XC60 (08-15), XC70 (06-15), XC90 (10-14), V60 (10-15), V70 (10-15). LAND ROVER: FREELANDER II (11-14).
INSTRUMENTE OEM	VOLVO: 999-7263 (3), 999-7264 (1), 999-7272 (5), 999-7257 (2), 999-7261 (4). LAND ROVER: 303-1225 (3), 303-1226 (1), 303-1219 (2), 303-1223 (4).
CODURILE DE MOTOR	3.0 TURBO: B6304T2, B6304T4. 3.2: B6324S, B6324S5. 3.2i6: B6324S.

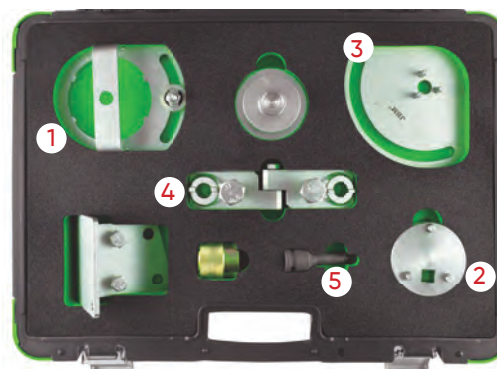

54226

71,00€



SET DE EXTRACȚIE PENTRU SCRIPETE DE POMPĂ DE ÎNALTĂ PRESIUNE PENTRU HYUNDAI/KIA

MĂRCI	HYUNDAI: ACCENT (11-15), ELANTRA (07-10), I20 (09-18), I20 (10-18), I20 COUPE (15-17), I30 (07-19), IX35 (10-16), I40 (11-18) KIA: CARENS (13-18), CEED (07-18), OPTIMA (11-15), PRO-CEED (08-19), RIO (09-17), CERATO (05-07), SOUL (09-14), SPORTAGE (10-18), VENGA (09-18)
INSTRUMENTE OEM	09331-2A000/2A010 (1), 09331-2A010 (1)
CODURILE DE MOTOR	1.1D CRDI: D3FF 1.4D CRDI: D4FC(U1), D4FC(U2) 1.6D CRDI: D4FB(U1), D4FB(U2), D4FB-H(U1), D4FB-H(U2), D4FB-L(U1) 1.7D CRDI: D4FD(U2), D4FD-H(U2), D4FD-L, D4FD-L(U2)



54200

56,00€

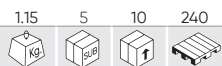

SET INSTRUMENTE DE REGLARE A MOTOARELOR PENTRU PORSCHE

MĂRCI	911 (2001 - 2008), BOXSTER (2002 - 2011), CAYMAN (2006 - 2009)
INSTRUMENTE OEM	9685 (1), 9686 (2), 9595 (3), 9595/1 (4)
CODURILE DE MOTOR	M96/03, M96/05, M96/23, M96/25, M97/20, M96/24, M96/26, M97/01, M97/21, M97/22.



51927

25,00€



APARAT PT. DEMONTAT ȘI MONTAT CURELE AUX. POLI-V



51340

39,30€



CHEIE UNIVERSALĂ PT. FULII, PINIOANE + ADAPTOARE



52616

44,00€

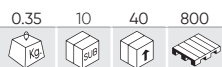

TENSIOMETRU PENTRU CURELE DE DISTRIBUȚIE

- Două scări gradate (daN) cu citire din față și din spate.

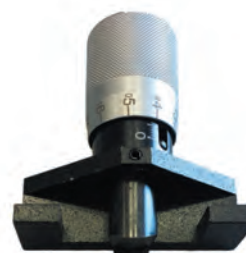

53769

178,00€

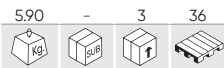

MODUL DE DISTRIBUȚIE PE LANȚ RENAULT/NISSAN/OPEL/VOLVO

MĂRCI	<p>RENAULT: AVANTIME, CLIO, ESPACE, KANGOO, LAGUNA, MASTER, MEGANE, MODUS, SCENIC, TWINGO, TRAFFIC. OPEL/VAUXHALL: MOVANO, VIVARO. DACIA: DOKKER, DUSTER, LOGAN, SANDERO. NISSAN: ALMERA, INTERSTAR, KUBISTAR, MICRA, NOTE, PRIMERA, QASHGAI. VOLVO: S40, V40</p>
INSTRUMENTE OEM	<p>MOT 1312 (1), MOT 1135-01 (2), MOT 1384 (3), MOT 1340 (4), MOT 1543 / KM-6234 / KV113 B0360 (5), MOT 1489 / KV113 B0130 (6), MOT 1536 / KM-6203 (7), MOT 1489 (8), MOT 1054 / KM-6031 / KV113 / B0280 (10), MOT 1318 (11), MOT 910 (12), MOT 910 (14), MOT 1386 (15), MOT 1534 / KM-6205 (16), MOT 1543 / KM-6234 / KV113 B0360 (17), MOT 1543 / KM-6234 / KV113 B0360 (18), MOT 1543 / KM-6234 / KV113 B0360 (19), MOT 1543 / KM-6234 / KV113 B0360 (20), MOT 1386 (22), MOT 1537 / KM-6204 (23), MOT 1348 (24), MOT 1538 (25), MOT 1337 (26), MOT 1496 / MOT 1750 (27), MOT 1490-01 (28), MOT 1200-01 (29)</p>
CODURILE DE MOTOR	<p>PEROL: 2.0 16V, 2.5 20V, 1.4, 1.6 16V, 1.8, 2.0 16V, 1.2, 1.7, 1.8, 2.0 16V, 2.2 GASOIL: 1.9, 2.5, 2.8</p> <p>D4F702/706/708/712/714/716/722/728/730/740/764, D7F700/701/710/720/722/726/730/744/746/764/766, E7F700/704/706/750, E7J601/624/626/634/635/680/700/706/710/711/716/718/719/720/724/726/728/740/742/745/754/756/757/764/770/771/773/780, F3P670/682/700/704/706/708/710/712/714/720/724/755/758/760, F7P704/722, F3R611/722/723/728/729/750/751/752/791/796/797/798, F5R700/701/740, J7R732/733/734/735/768, F7R710/714, J7T600/760/761/762/766/772/780/782, N7Q704/710/711, N7U700/701, K4J700/710/711/712/713/714/715/730/732/740/750/770/780, K4M700/701/704/706/707/708/709/710/711/712/714/716/718/720/724/730/732/734/736/740/742/743/744/745/746/748/750/752/753/754/760/761/762/764/765/766/768/776/782/788/790/791/794/800/801/802/804/812/813/830, K9K700/702/704/706/710/712/714/716/718/722/724/728/729/732/734/740/750/752/760/762/764/766/768/802/804/806, F9Q610/650/664/670/674/71/716/717/718/720/722/730/731/732/733/734/736/738/740/744/748/750/752/754/758/759/760/768/762/770/772/774/780/782/784/786/788/790/799/800/803/804/808/812/816/818/820, G9T600/605/700/702/703/706/707/710/712/720/722/742/743/750, G9U720/724/726/730/750/754, F8M736/760, F8Q600/610/606/620/622/624/630/632/640/644/646/648/662/672/678/680/682/684/692/696/706/714/720/722/730/732/740/742/744/764/768/706/776/784/786/788, J8S620/621/622/758/760/776/778, G8T714/716/740/752/760/790/792/794, S8U720/722/730/731/742/748/750/752/770/772/780/782, S9U700/702/704/714/740, S9W700/702/206/208/212, E5F, E6J, K7M, F4P/F4R, FIN, F2N, F3N, F2R, F3P, F4P, F3R, J5T, J6R, J7R</p>

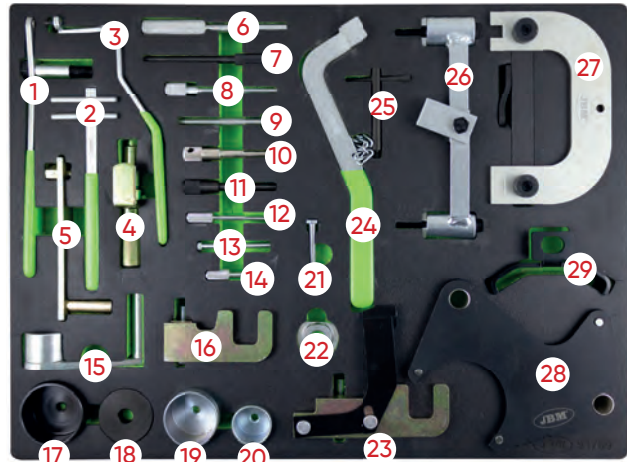

53773

298,00€

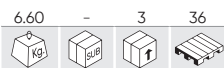

MODUL DE BLOCARE FIAT/ ALFA/LANCIA/OPEL/SUZUKI/FORD

MĂRCI	<p>ALFA: ROMEO 145, 146, 147, 155, 156, 159, 166, SPIDER, GTV, TS, GT, CROSSWAGON Q4 FIAT: PUNTO, GRANDE PUNTO, BRAVA, BRAVO, MAREA, WEEKEND, STILO, DOBLO, CARGO, IDEA, PANDA, MULTIPLA, PALIO, STILO, 500 LANCIA: LYBRA, YPSILON, THESIS, MUSA OPEL: CORSA, AGILA, MERIVA, COMBO, VECTRA, ZARA, ASTRA, INSIGNA, SIGNUM 19 CDTI SUZUKI: IGNIS, SWIFT, WAGON R+ FORD: KA</p>
INSTRUMENTE OEM	<p>1860874000 (1), 1860874000 (2), 2000004400 / 2190754400 (3), 1860863000 (4), 1860898000 (5), 2190754500 (6), 2000004300 (7), 1870900400 (8), 1860703000 (9), 1860933000 (10), 1860845000 (11), 1870900300 (12), 1860905000 / EN-46788 (13), 1895443000 (14), 1860992000 (15), 1870896900 (16), 1860987000 (17), 1860905000 (18), 1860771000 (19), 1860161000 (20), 1860876000 (21), 1860876000 (22), 1871000900 (23), 1860985000 (24), 2000004200 / 2190754200 (25), 1860965000 (29)</p>
CODURILE DE MOTOR	<p>176B9.000, 182B2.000, 188A5.000, 843A1.000, 323.02, 371.01, 182B4.000, 182B9.000, 186A6.000, 188A2.000, 188A7.000, 188B2.000, 192A1.000, 192A3.000, 937A2.000, 939A1.000, 192A5.000, 192B1.000, 198A5.000, 937A5.000, 939A2.000, 325.01, 342.02, 362.02, 185A6.000, 841C.000, 841G.000, 939A3.000, 940A3.000, 940A4.000, 940A5.000, Z19DT/DTH/DTR/DTJ/DTL, 169A1.000, 955A4.000, 350A3.000, 192B4.000, 198A2.000, 350A2.000, 955A3.000, 192A8.000, 198A6.000, 198A3.000, 199B1.000, 199B2.000, 199A2.000, 199A3.000, 199A9.000, 188A3.000, 188A8.000, 188A9.000, 192A9.000, 186A8.000, 186A9.000, 199A5.000, 223A7.000, 223A9.000, 841H.000, 841P.000, 185A2.000, Z13DT, Z13DTJ, Z13DTH, 182A4.000, 182A6.000, 182B6.000, 178B3.000, 186A3.000, 186A4.000, 350A1.000, 169A4.000, 188A4.000, 199A4.000, 199A7.000</p>

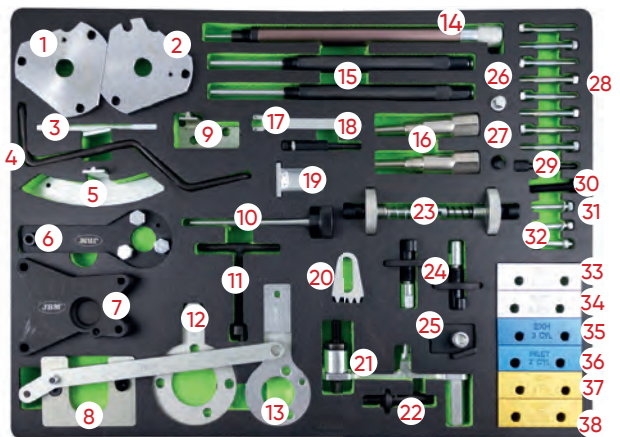

53770

198,00€



MODUL DE DISTRIBUȚIE PE LANȚ FORD/SEAT/VOLKSWAGEN/MAZDA/VOLVO

MĂRCI	FORD: FIESTA, FUSION, COURIER, ESCORT, FOCUS, FOCUS C MAX, PUMA, MONDEO, SIERRA, COUGAR, GALAXY, C-MAX, ORION, TOURNEO CONNECT, TRANSIT, TRANSIT CONNECT. VW: SHARAN. SEAT: ALHAMBRA. MAZDA: I21. VOLVO: S40, V50.
INSTRUMENTE OEM	303-1061 (1), 303-1054 (2), 23-059 / 310-085 (3), 21-105 (4), 323-029 (6), 0194-B / 21-263 / 303-735 / 49 JE 02 021 (7), 0132-AB / 0178-D / 21-151 (9), 0194-C, 21-262, 303-734, 49 JE 02 020 (10), 21-238 / 303-679A / 303-1151 (11), 21-238 / 303-679A / 303-1151 (12), 303-1054 (13), 303-1151 (14), 21-238 / 303-679A (15), 303-393 / 303-393-02 (16), 303-1097 (17), 21-168 / 303-393 (18), 303-0985 (20), 2064 / 23-047 / 310-055 / U20003 (21), 303-652 (22), 21-229, 303-651 (23), 303-748 (24), 21-210 (25), 21-260, 303-732 (26), 21-163, 303-620 (27), 21-234 / 21-251 (28), 303-675 / 303-698 (29), 21-104 / 303-193 (30) / 21-162B / 303-367 / 303-376 (31), 21-162B / 303-376 / 303-376B (32), 23-019 (33), 23-058 / 310-084 (34), 0153-M / 0178-C / 0178-D (35), 0178-B / 5711-TB (36), 21-123 (37), 23-020 (38), 21-234 / 21-251 (39), 303-1059 (40), 23-019 (41), 303-1060 (42), 303-393 / 303-393-01 (43)
CODURILE DE MOTOR	FUJA, FUJB, FXJA, FXJB, FYJA, FYJB, F8JA, F8JB, M7JA, M7JB, DHA, DHB, DHC, DHD, DHE, DHF, DHG, FHA, FHE, LIT, LIV, LIE, LIG, LIH, LIK, RDA, RDB, RKC, RQB, RQC, FXDA/C, FXDB/D, FYDA/C, FYDB/D, FYDH, HWDA1Z, AHU, AVG, AFN, D24, D24T, D24TIC, RFN, RTJ, RTK, RVA, RFK, RKD, B4164S3, DV4TD (8HW/8HX/8HZ), DV4TED4(8HV/8HY), DV6ATED4 (9HX/9HY/9HZ) F6JA, F6JB, F6JC, G8DA, G8DB, KKDA, SNJA, SNJB, STJA, STJB, ASDA, ASDB, FXJC, SPJA, SPJC, FYJC, HWDA, HWDB, SHDA, SHDB, SHDC, JQDA, LQDB, JTDA, JTDB, HXDA, HXJA, HXJB, IQDA/B, IQDB, PNBA, PNDA, RHBA, SIDA, F6JD, TZJA, TZJB, HHDA, HHDB, HHJA, HHJC, HHJD, HHJE, HHJF, RTA, RTB, RTC, RTD, RTE, RTF, RTH, RTJ, RTK, RFN, BHPA, HCPA, HCPB, KKDA, P7PA, P9PA, P9PB, R2PA, R3PA, RWPA, RWPC, F9DA/B, FFBA, FFWA, KHBA, QYBA, QYWA, KKDB, C9DC, RVA, 1Z, AFN, AHU, ANU, AUY, G6DA, G6DB, G6DC, G6DD, G6DE, G6DF, G6DG, UFDB, TXDB, TYDA, UKDB, QXBA, AZBA, KLBA, QXBB, LPBA, AZBC, TYBA, UKBA, UFBA, TXBA, IXDA, QXWA, QXWB, AZWA, KLWA, AZWC, TYWA, UKWA, TXWA, UFWA, UFDA, TXDA, UKDA, Q4BA, KNBA, 4BA, 4BB, 4BC, 4CC, 4FA, 4CA, 4CB, 4DA, 4EA, 4FA, 4FB, 4FC, 4FD, 4GA, 4HB, 4HC, 4EB, 4EC, 4ED, 4GA, 4GB, 4GC, 4GD, 4GE, 4GF, 4HA, 4HD, FMBA/B, D5BA, ABFA, D3FA, D6BA, HJBA/B, F3FA, D2FA, D4FA, F4FA, F5FA, DOFA, QJBA, QJBB, QJBC, QJBD, FXFA, H9FA, H9FB, N7BA, N7BB, MZ-CD 1.6, Y6

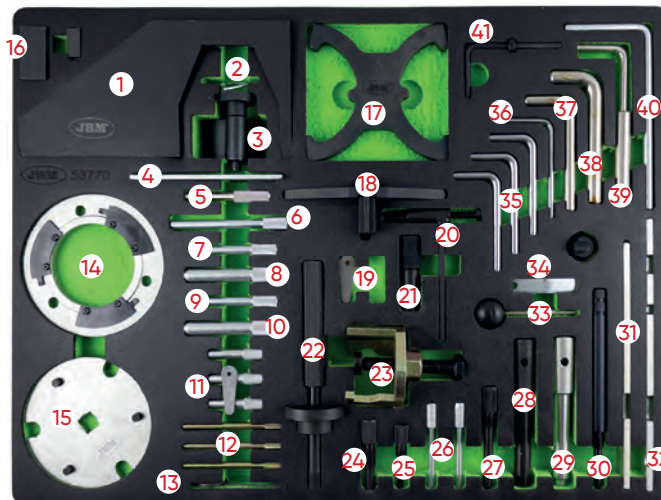

53774

190,00€



MODUL DE DISTRIBUȚIE PE LANȚ OPEL/CHEVROLET/SAAB/FIAT/LANCIA/SUZUKI/FORD

MĂRCI	ALFA: 145, 146, 147, 156, 159, 166, GT, CROSSWAGON Q4 FIAT: PUNTO, GRANDE PUNTO, BRAVO, BRAVA, MAREA WEEKEND, STILO, DOBLÒ, CARGO, MULTIPLA IDEA, PANDA LANCIA: YPSILON, MUSA, LYBRA, THESIS OPEL: CORSA B/C, COMBO, TIGRA, AGILA, TIGRA B, MERIVA, ASTRA F/G/H, ASTRAVAN, SPEEDSTER VX220, ZAFIRA A/B, VECTRA B/C, SIGNUM, OMEGA B, SINTRA, FRONTERA A/B, ASTRAVAN, KADETT, ASCONA, OMEGA, MONTEREY, ANTARA, CROMA, SPEEDSTER VX220 SUZUKI: IGNIS, SWIFT, WAGON R+ FORD: KA CHEVROLET & DAEWOO: EPICA, CAPTIVA, NUBIRA, LACETTI, EVANDA SAAB: 9-3, 9-5 (98-04)
INSTRUMENTE OEM	1860905000 / 1860905010 / EN-46788 (1), KM-6148 (2), KM-6148 (3), 1870900400 / 1871000200 (4), KM-954 (5), KM-J-43651 (6), 1860905000 / 1860905010 / EN-46788 (7), KM-852 (8), KM-853 (9), 1870900300 / 303-1468 (10), EN-46785 / KM-951 (11), KM-932 (12), 1860703000 (13), KM-955 (14), KM-6130 / KM-6349 / KM-6349 (15), KM-927 (16), EN-48245 (17), KM-933 (18), EN-46785 (19), 1860985000 / 1871000900 / EN-46781 (20), 1860985000 / 1871000900 / EN-46781 (21), EN-48246 (22), KM-929 (23), 1870896900 / EN-46789 (24), KM-952 (25), 21-162B / 303-376 / 303-376B (26), KM-933 (27)
CODURILE DE MOTOR	X14XE, Z14XE, X16SEJ, X16XE, X16XEL, Y16XE, Z16XE, Z16YNG, C18XEL, X18XE, X18XE1, Z18XE, Z18XEL, C20SEL, C20XE, X20XE, Z20LEH, Z20LEL, Z20LER, Z20LET, X22SE, Y22SE, Y22XE, Z22XE, D223L, X10XE, Z10XE, Z10XEP, X12XE, Z12XE, Z14XEP, X20DTL, X20DTH, X22DTH, Y20DTL, Y20DTH, Y22DTH, Y22DTR, 169A1.000, 955A4.000, 350A3.000, 192B4.000, 198A2.000, 350A2.000, 198A2.000, 955A3.000, 192A8.000, 198A6.000, 198A3.000, 199B1.000, 199B2.000, 199A2.000, 199A3.000, 199A9.000, 940A3.000, 188A3.000, 939A2.000, 188B2.000, 188A8.000, 188A9.000, 323.02, 371.01, 937A2.000, 182B4.000, 182B9.000, 188A2.000, 188A7.000, 192A9.000, 186A6.000, 186A8.000, 192A1.000, 192A3.000, 192B1.000, 192A5.000, 186A9.000, 939A1.000, 199A5.000, 223A7.000, 223A9.000, 342.02, 362.02, 84TG.000, 84TH.000, 84IP.000, 939A3.000, 185A2.000, 185A6.000, Z13DT, Z13DTJ, Z13DTH, Z19DT, Z19DTH, Z19DTJ, Z19DTL, X10XE, Z10XE, Z10XEP, Z12XE, Z14XEP, X16S2R, Z16SE, 4EC1/T, 4EC1, 4EE1/T, 4EE1, X17DT, Y17DT, Y17DTI, Y17DTL, 16DA, 17D, 17DR/X, 7DTL, X17DTL, 4JX1/4, JG2T, 4FC1/T, 4FD1, X20DTL, Y20DTL, D223L Z20DMH, Z20DM, RA420, Z20S1, 194A1.000, Z22SE, Z22YH



53771

158,00€



MODUL DE DISTRIBUȚIE PE LANȚ FIAT/FORD/CITROËN/PEUGEOT

MĂRCI	<p>FIAT: ULYSSE, SCUDO, DUCATO LANCIA: ZETA, PHEDRA FORD: FIESTA, FUSION, FOCUS, FOCUS C-MAX CITROËN: C15, C1, C2, C3 PLURIEL, C4, C4 PICASSO, C5, C6, C8, DS3, DS4, DS5, XANTIA, XSARA, XSARA PI-CASSO, EVASION, BERLINGO, JUMPY, JUMPER, SAXO, ZX, XM, EVASION, AX PEUGEOT: 107, 1007, 206 CC, 207, 208, 306, 307 CC, 308, 406, 407, 508, 607, 806, 807, PARTNER, EXPERT, BOXER, 206, 106, 605, 205, 405</p>	
INSTRUMENTE OEM	<p>4200-TH (1), 0117-AR (2), 0188-X (3), 0606-A1.A2 (4), 0188-Q2 (5), 0189-S1 (6), 7017-TR (7), 0132-P / 4507-TL (8), 0189-C (9), 0188-J1 (10), 0188-J2 (11), 0178-E (12), 0189-R (13), 0132-AK / 0188-AK / 0189-K / 0153-AK / 4533-TAD / MOT 1436 (14), 0188-AH (15), 0189-S2 (16), 0153-AB / 9041-TZ (17), 0153-M / 0178-C / 0178-D / 7014-TM / 9767-94 (18), 0189-A (19), 4527-TS1 (20), 0153-AB / 9041-TZ (21), 0189-B / 21-163 (22), 0132-AJ1 / 0153-G / 0188-M / 0189-J / 4533-TAC1 / 5711-TA (24), 0189-L (25), 0188-D / 7017-TM (26), 0132-X / 0188-Q1 / 4507-TJ / 9767-89 (27), 0194-B (28), 0132-AB / 0194-A (29), 0194-C / 21-262 / 303-734 (30), 4527-TS2 (31), 0188-E (32), 0153-A / 6012-T / 9765-54 (33), 0134-AF / 0134-Q / 0188-F / 9004-T (34), 0188-P2 / 0188-P / 174 / 7015-T (35), 0153-U 7019-T (36), 0153-N / 0188-Y / 7014-TJ / 7099-TM / 9797-34 (37)</p>	
CODURILE DE MOTOR	<p>F6JA, F6JB, F6JC, G8DA, G8DB, HHDA, HHDB, HHJA, HHJB CITROËN, PEUGEOT: 1.0 / 1.1 / 1.4 / 1.6 / 1.6 16V, 1.4 / 1.6HDI / 1.8 / 1.8 16V / 2.0 / 2.0 TURBO, 1.9D / 2.0HDI / 2.2HDI / 1.8 16V / 2.0 16V TU9 (CDY/CDZ), TU1 (HDY/HDZ/HFX/HFY/HFZ), TU3 (KDX/KDY/KDZ/KFX/KFZ), TU5JP4 (NFU/NFX), TU5 (BDY/BFZ/NFT/NFV/NFW/NFY/NFZ), XU7 (LFW/LFX/LFZ), EW7J4 (RLZ), XU7JP4 (LGY), XU10 (RFL/RFU/RFW/RFX/RGX/RGY), XU10JP4 (RGX/RGY), EW10A (RFJ), EW10J4S (RFK), EW10D (RLZ), EW12J4 (3FZ), ET3JE (KFU), TU3A/JP (KFV/KFW), DV4TD (8HW/8HX/8HZ), DV4TED4 (8HV/8HY), DV6ATED4 (9HX/9HY/9HZ), EW10-CVI (RLZ), EW12 (3FZ), DW8 (WJZ/WJY), DW10 (RHY/RHV/RHZ/RHS/RHM/RHW/RHT/RHR/RHX), DW12 (4HX/4HZ/4HW/4HY), EW7J4 (6FZ), EW10J4 (RFR), EW10J4D (RLZ), DW12TED4 (4HW), DW10ATED (RHT/RHV/RHW/RHX/RHZ)</p>	

53772

229,00€



MODUL DE DISTRIBUȚIE PE LANȚ FORD/VAG/MAZDA/VOLVO

MĂRCI	<p>AUDI: 80, A1, A2, A3, S3, A4, A5, A6, TT, Q5 SEAT: AROSA, IBIZA, CORDOBA, LEON, TOLEDO, ALHAMBRA, ALTEA, INCA (99-04) SKODA: FABIA, OCTAVIA, SUPERB VW: LUPO, POLO, FOX, GOLF, BORA, JETTA, GOLF PLUS, PASSAT, BEETLE, TOURAN, SHARAN, CADDY, CADDY MAXI, TRANSPORTER, GOLF VI CABRIO, TIGUAN FORD: GALAXY</p>	
INSTRUMENTE OEM	<p>T10252 (1), VAS6079 (2), T10121 (3), MP1-1312 / T10098 / T20038 / T20038 (4), T10123 (5), 23-058 / 310-084 / T10008 (6), 2065A / T10008 / U40021 (7), 3418 (8), T10171 (9), 23-059 / 23-059 / 310-085 / T10050 / T10050 (10), 3458 / T30094 (11), T10016 / T10074 / T10074 (12), T10100 (14), T10414 (15), 3366 / T20018 / T20044 (16), 3411 (17), 3369 / T30092 (18), T10341 (19), 3242 / T40069 / T30052 (20), T 40026 (21), 3359 / MP1-301 / T20102 (22), 2064 / U20003 (23), T10120 (24), MP1-1312 / T10098 / T20038 (25), T10170 (26), T00115 / T10264 / T40098 (27), T10092 (28), T00115 / T10264 / T40098 (29), 303-1054 / T10115 (30), T10060 / T10060A (31), 3359 / MP1-301 / T20102 (32), T10340 (33), 2587 (34), 3387 / U30009A (35), 3387 / T10020 (36)</p>	
CODURILE DE MOTOR	<p>ARC, ATN, AUS, AVY, AZD, AFH, BCA, AJV, AKQ, AUA, AUB, AXP, AFH, AFN, AFK, AHW, AHU, APE, AQQ, AUS, AXP, AZD, BBY, BBZ, BCB, ANY, AYZ, AMF, ATL, BAY, BHC, BMS, BNM, BNV, BWB, AJM, AMG, ANU, ARL, ASZ, ATD, ATJ, AUJ, AVB, AVF, AVQ, AWX, AXB, AXC, AXR, BEW, BJB, BKC, BKE, BLS, BLT, BMT, BPX, BRB, BRM, BRR, BRU, BSU, BSW, BTB, BUK, BVK, BXE, BXF, AZV, BDJ, BDK, BGV, BHW, BKD, BKP, BLB, BMA, BMM, BMN, BMP, BMR, BNA, BPW, BRC, BRE, BRF, BRT, BUZ, BE, BVF, BVG, BVH, BWK, BTS, BMY, BLF, BWV, AZV, BGD, AWY, AZQ (55 - 64 PF), AXU, BAG, BKG, BLF, BLN, BLP, BVF, BKF, BNU, BVP, BVR, TZ, CBZA, CBZC, CBZB, CAXA, CAGA, CAGB, CAGC, CAHA, CAYA, CAYB, CAYC, CBAA, CBAB, CBAC, CBBA, CBBB, CBDA, CBDB, CBDC, CBEA, CEGA, CKUB, AZV, BDJ, BHP, BKD, BLB, BMA, BMM, BMN, BMP, BMR, BNA, BPW, BRC, BRE, BRF, BRT, BSS, BUJ, BUZ, BVA, BVE, BVF, BVG, BVH, BWV, ACV, AFB, AGX, AHD, AHY, AHY, AJT, AKE, ANJ, APA, AUF, AXG, AXG, AXL, AYC, AYM, AYY, BAU, BBE, BBF, BCZ, BDG, BDH, BFC, BJJ, BJK, BJL, BJM</p>	

INSTRUMENTE DE SINCRONIZARE

DULAP CU 7 SERTARE CU SET DE INSTRUMENTE PENTRU REGLAREA SINCRONIZĂRII

53951 1.794,00€

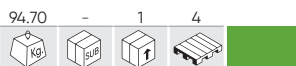

PLIN

53952 1.794,00€

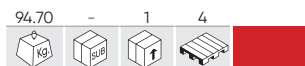

PLIN

54501 1.794,00€

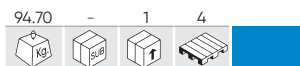

PLIN

54502 1.794,00€



PLIN

DIMENSIUNI INTERIOR

SERTAR MIC (X5)



SERTAR MARI (X2)



CAPACITATEA DE ÎNCĂRCARE A SERTARULUI: 30KG.
CAPACITATE TOTALĂ DE ÎNCĂRCARE: 70KG.

DIMENSIUNILE TOTALE



CU EVA MODULE:

SET DE 6 INSTRUMENTE PENTRU SINCRONIZAREA MOTORULUI

53775 1.109,00€



GASOLINA/PETROL

DIESEL/GASOIL

INCLUDE

REF.	kg	box	boxes	pallet	€
53769	5.90	-	3	36	178,00€
53770	6.15	-	3	36	198,00€
53771	4.05	-	3	36	158,00€
53772	6.40	-	3	36	229,00€
53773	6.60	-	3	36	298,00€
53774	6.95	-	3	36	190,00€

53769



RENAULT / NISSAN / OPEL / VOLVO

53770



FORD / SEAT / VOLKSWAGEN / MAZDA / VOLVO

53771



FIAT / FORD / CITROËN / PEUGEOT

53772



FORD / VAG / MAZDA / VOLVO

53773



FIAT / ALFA / LANCIA / OPEL / SUZUKI / FORD

53774



OPEL / CHEVROLET / SAAB / FIAT / LANCIA / SUZUKI / FORD

PENTRU MAI MULTE INFORMAȚII

PAGINĂ 297

ACCESORII ȘI PIESE DE SCHIMB

PAGINĂ 90

300 Fără TVA



www.jbmcamp.com

ACCESORII PENTRU LUBRIFIANȚI

- 302 POMPE DE ALIMENTARE MOTORINA
- 303 POMPE DE ALIMENTARE CU UREE
- 304 POMPE DE EXTRACȚIE/UMPLERE
- 307 COLECTOARE DE ULEI
- 308 PISTOALE DE ASPIRAȚIE
- 309 GĂLEȚI DE COLECTARE A ULEIULUI
- 310 ALTELE



53697

398,00€

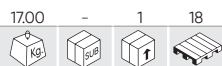

POMPĂ DE ALIMENTARE CU MOTORINĂ CU DUZĂ ȘI CONTOR (200V-240V)



- Tensiune nominală: 200-240V.
- Putere nominală: 550W.
- Flux maxim: 60 l/min.
- Lungime cablu: 2m.
- Lungimea furtunului de aspirație: 2m.
- Lungimea furtunului de presiune: 4m.

CU OPRIRE AUTOMATĂ



PIESE DISPONIBILE

53610

294,00€



POMPĂ DE ALIMENTARE PT MOTORINĂ CU DUZĂ (230V)



- Lungimea furtunului de intrare: 2m.
- Lungimea furtunului de ieșire: 4m.
- Electric.
- Se livrează cu pistol și furtunuri.

CU OPRIRE AUTOMATĂ



PIESE DISPONIBILE

53609

182,50€



POMPĂ DE ALIMENTARE CU MOTORINĂ CU DUZĂ (12V)



- Lungimea furtunului de intrare: 2m.
- Lungimea furtunului de evacuare: 4m.

CU OPRIRE AUTOMATĂ



PIESE DISPONIBILE

54100

265,00€

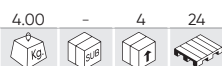

POMPĂ ELECTRICĂ PENTRU MOTORINĂ



- Lungimea țevii de aspirație: 850-1245mm (850-1245mm)
- Lungime furtun: 2m
- Temperatura de lucru: 5° - 40°C (41° - 104°F)
- Tensiune curent continuu: 12V
- Curent alternativ: 100-240V
- Lungime cablu: 4m



53645

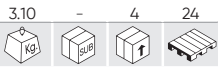

POMPĂ ELECTRICĂ PENTRU UREA AUS32



- Pompa electrică rotativă este predestinată să funcționeze cu medii pe bază de apă, Urea AUS32 DEF și permite pomparea conținutului de la IBC-rezervoare cu un volum de 205 sau 1000-1250 l.
- Construcție compactă și ușoară.
- Siguranță fuzibilă încorporată pentru protecția împotriva suprasarcinii și zgomotului mo-torului.
- Filtru încorporat în tubul de aspirație din oțel inoxidabil, care împiedică pătrunderea mur-dăriei și impurităților, care prin urmare, împiedică deteriorarea.



268,00€



PIESE DISPONIBILE

53644

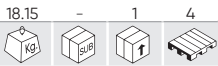

REZERVOR PENTRU UREA AUS32 (75 L)

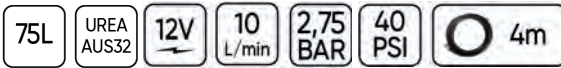

- O construcție autonomă și complet mobilă cu un volum de 75 l și o pompă cu tensiunea de alimentare de 12V (permite obținerea unei productivități de 10 l / min la o presiune de lucru de 40 psi), completată cu un furtun și o supapă de închidere automată.
- Rezervorul este construit din polietilenă, compact, rezistent la coroziune și radiații UV.
- Roțile cu diametru mare (200mm) oferă manevrabilitate ridicată chiar și pe terenuri neuniforme.



1.238,00€



15631

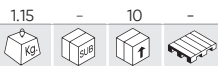

PISTOL AUTOMAT PENTRU ALIMENTARE UREA AUS32 (ART. NR.53645)



98,00€

52329

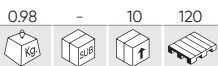

POMPĂ MANUALĂ DE EXTRACȚIE DIN PLASTIC



- Pentru bidoane de 25, 50 și 200L.
- 350ml pe pompare.
- Corp și piston de polipropilenă.
- Măner din plastic ABS.
- Aplicații: Alcoolii, uleiuri, lubrifianți, benzină, diesel, kerosen, etc.
- Conductă de aspirație:
Lungime minimă de 320mm.
Lungime maximă de 900mm.



36,40€



13982

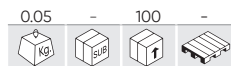

ADAPTOR FILETAT PENTRU TAMBURE DIN MASE PLASTICE

- Prevede ajustarea și compensarea diferitelor filete ale rezervoarelor, butoaielor și pompelor.



4,00€

52601

397,00€

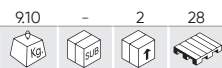

200L

POMPĂ MANUALĂ DE
EXTRACȚIE PNEUMATICĂ

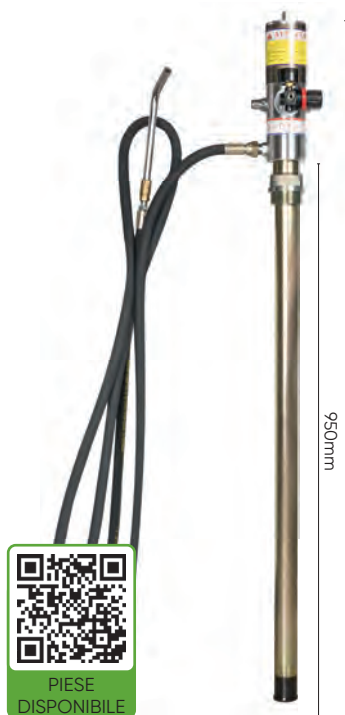

- Presiune Raport : 5 : 1.
- Intrare aer : 1/4".
- Ieșire aer : 1/4".
- Presiune lucru : 6 - 8 bar.
- Presiune Max. : 8 bar.
- Consum de Aer : 250 L/min.
- Capacitate relativă 6 bar : 18 L/min.
- Temperatură ulei : -10~50°C.
- Vâscozitate maximă : 240 SAE.
- Lungimea tubului : 950mm.

50918

341,00€

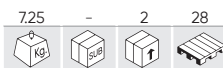

200L

POMPĂ DE ULEI
PNEUMATICĂ

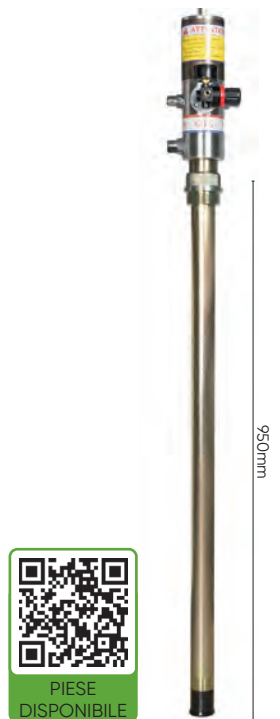

- Presiune Raport : 5 : 1.
- Intrare aer : 1/4".
- Ieșire aer : 1/2".
- Presiune lucru : 6 - 8 bar.
- Presiune Max. : 8 bar.
- Consum de Aer : 250 L/min.
- Capacitate relativă 6 bar : 18 L/min.
- Temperatură ulei : -10~50°C.
- Vâscozitate maximă : 240 SAE.
- Lungimea tubului : 950mm.

50935

595,00€

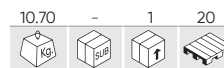

200L

KIT POMPĂ DE
ULEI+FURTUN+PISTOL ULEI
DIGITAL

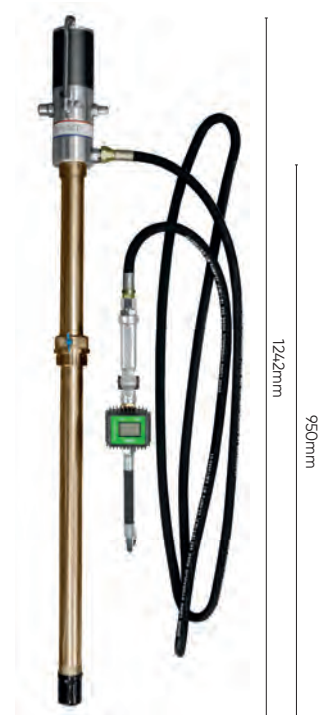

- Lungimea furtunului : 2 m.
- Lungimea tubului : 950 mm.
- Capacitate relativă 6 bar : 18 L/min.
- Raport de Temperatură ulei : -10~50°C.
- Vâscozitate maximă : 240 SAE.
- Presiune Raport : 5 : 1.
- Intrare aer : 1/4".
- Ieșire aer : 1/2".
- Presiune de lucru : 6-8 bar.
- Presiune Max. : 8 bar.
- Consum de aer : 250 L/min.

53566

32,00€

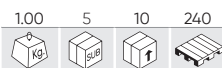

POMPĂ DE ULEI - 12V



- Pompa de ulei (extractor) este un dispozitiv ideal pentru înlocuirea rapidă și calitativă a uleiului.
- Acesta funcționează de la bateria de acumulare a vehiculului (12 V) prin intermediul clemelor (bornelor).
- Uleiul se extrage din motor prin orificiul pentru jojă.
- Utilizați extractorul numai pentru extragerea uleiului de motor, uleiului pentru motoarele diesel și lichidul de răcire.



51253

41,00€

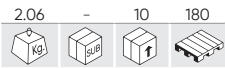

POMPĂ MANUALĂ PENTRU EXTRAȚIE ULEI

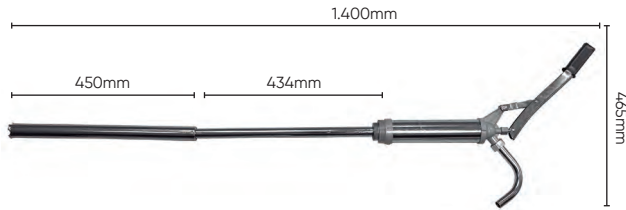

52428

40,00€

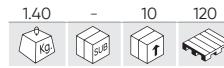

POMPĂ MANUALĂ DE EXTRAȚIE

- Pentru bidoane între 50 și 200 litri
- Debit 400ml pe impuls.
- Aplicații: Uleiuri, lubrifianți, diesel, etc.
- Capacitate de pompare: 32litri x minut
- Adaptor de gură de 2" inclus.
- Conductă de aspirație de 101cm cu intrare de 1 1/4" și ieșire de 1.
- Nu este permis pentru: acizi tari, benzină, leșie.
- Aplicații: uleiuri, lubrifianți, motorină, lichide pe bază de ulei.
- Recomandat pentru: lichid de frână, detergenți, glicerină, acizi ușori, fluide pe bază de ulei.



50917

271,00€

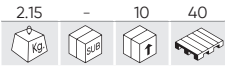

PISTOL DE POMPARE A ULEIULUI CU DEBITMETRU DIGITAL

- Intrare aer: 1/2" BSPF
- Debit: 1-35 L/min
- Presiune de lucru: 6-8 bar
- Presiunea maximă de lucru: 100 bar
- Intervalul de temperatură a uleiului: -10-60 °C
- Vâscozitate maximă: 240 SAE
- Baterie: 2x1,5 V (baterie inclusă)
- Precizia debitmetrului: ±0,5%.
- Repetabilitatea debitmetrului: 0,2%
- Rata de descărcare pe revoluție: 25ml/R



REF. DESCRIERE

REF.	DESCRIERE	kg	L	mm	€
10000	MANOMETRU PISTOL DIGITAL P/50917	2.10	-	7,00€	

53627

22,50€

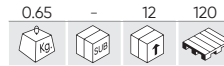

SET PENTRU EXTRAGEREA ULEIULUI ȘI COMBUSTIBILULUI

- Dispozitivul este proiectat și fabricat pentru îndepărtarea rapidă a uleiului, combustibilului cât și uleiului de transmisie / uleiului diferențial din rezervoarele generatoarelor, spălătoare de înaltă presiune, compresoare pneumatice, tractoare de gradina sau vehicule de teren.

1,6L



52797

198,00€

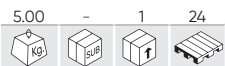

KIT POMPA UMLERE ULEI

- Capacitate: 75L.
- Descărcare: 80cc cicluri.
- Raport de vâscozitate: Până la SAE 140.
- Suportă umplerea și golirea



REF. DESCRIERE

REF.	DESCRIERE	kg	L	mm	€
13234	POMPĂ UMLERE ULEI FĂRĂ ACCESORII P/52797	3.75	24	224,50€	

12044

147,00€

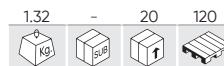

SET ADAPTOARE FOR POMPĂ UMLERE ULEI (15 PIESE)

- ATF101: FORD 1/8 - 27 (NPT).
- ATF102: Universal BMW, Honda, Nissan, etc.
- ATF103: VW/Audi. Skoda.
- ATF104: VW/Audi. Porsche.
- ATF105: VW/Audi, Mini cooper M10x1.0
- ATF106: VW/Audi DSG M24 x 1.5
- ATF107: VW/Audi CVT M22x1.5
- ATF108: Mercedes M12 x 1.5
- ATF109: V/W. Skoda M18x1.5
- ATF110: Audi/VW, Skoda M30x1.5
- ATF111: Universal flexible 300mm. Honda. Hyundai. KIA...
- ATF112: Volvo 5/16 - 24 (UNF)
- ATF113: Toyota, Lexus M18 x 1.5
- ATF114: Nissan, Infinity M8 x 1.0
- ATF115: ATF-Adapter VW Passat



54290

4.307,00€

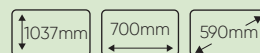

N

MAȘINĂ AUTOMATĂ DE SCHIMBAT ULEIUL DE TRANSMISIE

220V 50Hz	150V	-10°C 50°C	40L	2 L/min	Error de intercambio equivalente Equivalent exchange error ±100ml
<90%	0-150 PSI	5μm	<70dB	70kg	

- Umplerea automată a lichidului de transmisie.
- Identificarea automată a direcției fluidului (intrare/ieșire).
- Spălare automată.
- Schimbarea automată a fluidului nou/folosit.
- Afișarea nivelurilor de presiune a lichidului.
- Afișarea precisă a temperaturii lichidului de transmisie
- Control electronic inteligent
- Bază de date actualizată
- Include adaptoare pentru diferite mărci
- Îmbunătățește performanța sistemului de transmisie automată



TUTORIAL VIDEO



PIESE DISPONIBILE

54367

729,00€



N

SET DE ADAPTOARE PENTRU REF.54290 (105 BUCĂȚI)

INCLUDE



INFORMAȚII TEHNICE

54050

895,00€



MAȘINĂ AUTOMATĂ DE SCHIMBARE A ULEIULUI DE TRANSMISIE

- Fonte de alimentația: 12 V (bateria de carro)
- Potência da bomba: 70W
- Diâmetro do medidor de pressão de óleo: 70 mm (ambos os medidores de pressão de óleo)
- Faixa de medição do medidor de óleo: 0-10 bar (0-150 psi)
- Volume do tanque de óleo fresco: 30 l
- Capacidade do tanque de óleo residual: 30 l



TUTORIAL VIDEO



PIESE DISPONIBILE

53874

398,00€

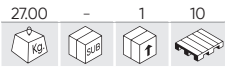

COLECTOR DE ULEI CU SISTEM DE ASPIRAȚIE 90L

90L 8-10 BAR



PENTRU CAMIOANE/VEHICULE

- Presiunea de lucru a aerului 8~10bari
- Nivelul de vid: negativ 0~0,8bari
- Capacitate rezervor: 70L
- Capacitate filtru cu sită pentru colectare 10L
- Volumul cupei de măsurare: 10 litre
- Viteza de aspirație a uleiului în funcție de diametrul sondei: 0,8 l / min (Ø5x3,5 mm); 1 l / min (Ø6x4,5 mm); 1,6 l / min (Ø8x6,5 mm)
- Dimensiuni: 43x49x163 cm
- Mediu: Ulei de motor și ulei de transmisie.
- Temperatura uleiului recomandată de lucru: 40~60°C
- Cu vid de extracție.
- Sistem vizual de măsurare.
- Rezervor de capacitate mare.
- Mâner pentru facilitarea manipulării.
- Role pentru facilitarea transportului.

53873

285,00€

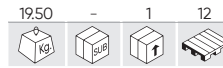

COLECTOR DE ULEI 80L

80L 1-3 BAR



PENTRU CAMIOANE/VEHICULE

- Presiunea de lucru a aerului 1~3 bari
- Capacitate rezervor: 70 l
- Capacitate filtru cu sită pentru colectare 10 litre
- Dimensiuni: 35x48x163 cm
- Mediu: Ulei de motor și ulei de transmisie.
- Rezervor de capacitate mare.
- Mâner pentru facilitarea manipulării.
- Role pentru facilitarea transportului.
- Poate fi utilizat pentru uleiuri la temperaturi ridicate (fără limită).

15084

68,00€

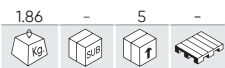

MODUL DE EXTRAGERE A CAPACELOR DE CARTER

	x2	5/16", 3/8"		x7	8, 9, 10, 12, 13, 14, 17mm
	x7	7, 8, 10, 11, 12, 13, 14mm		x1	T45
	x1	10mm		x1	M16
	x1	10mm		x1	200mm
				x1	150mm



53215

19,00€

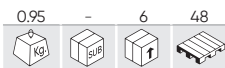

185mm Ø380mm

TAVĂ DIN PVC PENTRU ANTIGEL CAP. 18L

18L



53144

18,00€

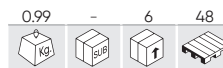

185mm Ø380mm

ULEI COLECTOR 18L

18L



ACCESORII PENTRU LUBRIFIANȚI

54051

39,00€

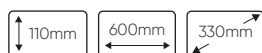

TAVĂ PENTRU ULEI 8 L

8L

PE



51356

48,00€



TAVĂ DIN OȚEL PENTRU LICHIDE

23L



52498

58,00€



POMPĂ MANUALĂ TRANSPARENTĂ



- Fabricată din polipropilen.
- Corp transparent.
- Utilă pentru uzul de uleiuri de transmisie și diferențiale.
- Rezistentă la lichid de frână și antigel.



TUB FLEXIBL

52628

26,50€



POMPĂ MANUALĂ TRANSPARENTĂ



- Adecvată pentru utilizarea în lichid de frână.
- Conector rapid într-un extrem.



TUB FLEXIBL

REF. DESCRIERE

11867 DOUĂ ORINGURI DE SCHIMB PENTRU REF. 52498

0.02 - 100 - 9,00€

51928

14,00€

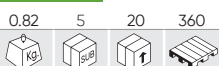

SERINGĂ TRANSFER DE ULEI

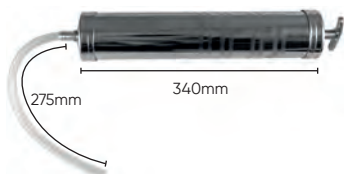

52789

15,20€



POMPA MANUALA EXTRACTIE GASOIL



- Furtun 90cm lung la fiecare capăt.

50924

342,00€

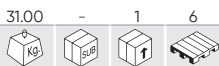

CĂRUȚI PENTRU TRANSPORTAT BIDOANE SP. GRESARE

200L



REZERVOR DE ÎNMAGAZINARE PENTRU BIDOANE

52804
14.50 - 1 5
Kg SUP

343,00€
230L 400Kg

HOMOLOGAT DIBT
1 BIDON VERTICAL



52805
13.35 - 1 6
Kg SUP

426,00€
250L 650Kg

HOMOLOGAT DIBT
2 BIDOANE VERTICALE



52806
17.50 - 1 5
Kg SUP

742,00€
250L 1250Kg

HOMOLOGAT DIBT
NU ESTE ADECVAT PENTRU PALEȚI
4 BIDONAE VERTICALE



53214
16.50 - 1 12
Kg SUP

285,00€

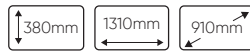

SUPORTURI PENTRU ÎNMAGAZINARE
- 2 REZERVOAREI VERTICALE PENTRU
EUROPALETE

230L 650Kg

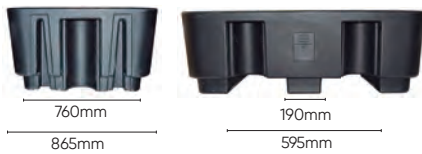

52807
30.00 - 1 7
Kg SUP

1.714,00€

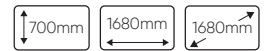

SUPORTURI PENTRU ÎNMAGAZINARE - 1000L

1000L 2500Kg



HOMOLOGAT DIBT



54498
221.00 - 1 -
Kg SUP

6.090,00€

CAPAC REZISTENT IBC

Permite depozitarea containerelor IBC. Asigură o protecție maximă a containerului împotriva intemperiiilor. Cu tavă de colectare a lichidelor cu o capacitate de 2 litri, tavă de retenție integrată și fante de ventilație.

CAPACITATE CONTAINER DE 1000 DE LITRI: 1 UNITATE

CAPACITATE BIDON DE 200 DE LITRI: 4 UNITĂȚI

CAPACITATE TOTALĂ DE ÎNCĂRCARE: 2500KG

2500Kg 2500mm 1775mm 1770mm



CONTAINERUL IBC NU ESTE INCLUS

53612

96,00€



CAPTURA PENTRU BUTOAI (CAPACITATEA DE RIDICARE 500 KG)



- Pentru a manipula butoaiile de ulei.
- Capacitate: 500 kg.
- Tipul vertical de prindere a containerelor.
- Tamburi speciale de 200L.



CANISTRĂ METALICĂ PENTRU COMBUSTIBILI

REF.	L/mm				€
54181	5L - 550x260x350mm	1.45	4	72	25,10€
54182	10L - 570x350x425mm	2.55	4	48	34,70€
54184	20L - 760x370x500mm	4.10	4	24	44,00€



54183

38,20€



CANISTRĂ DE BENZINĂ DE 10L ANTI-BASCULARE

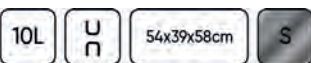

REF.	DESCRIERE					€
15874	FURTUN FLEXIBIL DE UMLERE PENTRU CANISTRA DE BENZINĂ (REF.54181, 54182, 54183, 54184)	0.30	-	50	800	6,50€

52452 8,00€

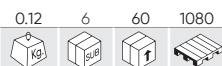

CHEIE PLASTICĂ PENTRU BIDOANE



- Material: Nailon.
- Împotriva scânteilor și împotriva prafului.
- Reliefuri terminate de 3/4" și 2".
- Utilă pentru bidoane de 200L.

53078 18,00€



ROBINET PENTRU BIDON DE 200L



- Prevede golirea rapidă a butoaiilor de 200 litri.
- Este potrivit pentru apă, toate tipurile de uleiuri, alcool sau cetonă, precum și pentru acizi slab concentrați și fluide ușor alcaline.
- Material: PE.
- EPDM-garnitură.
- Arc din oțel inoxidabil.

53518 3,50€

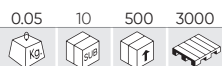

ROBINET PT. BIDON DE ULEI DE 3/4"



- Este potrivit pentru toate tipurile de lichide.
- 3/4" filet exterior.

52453 21,00€



ROBINET PT. BIDON DE ULEI DE 3/4"



- Robinet de siguranță.
- Filet de 3/4".
- Corp din aliaj.
- Garnitură de Nailon.
- Aplicații: Uleiuri, lubrifianți, benzină, diesel, kerosen, etc.
- Valabil pentru Urea AUS32.

52242

12,00€

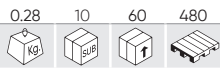

POMPĂ MANUALĂ PENTRU ULEI 500ML

500ml



52243

8,50€

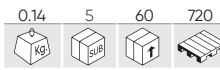

POMPĂ MANUALĂ PENTRU ULEI 250ML

250ml

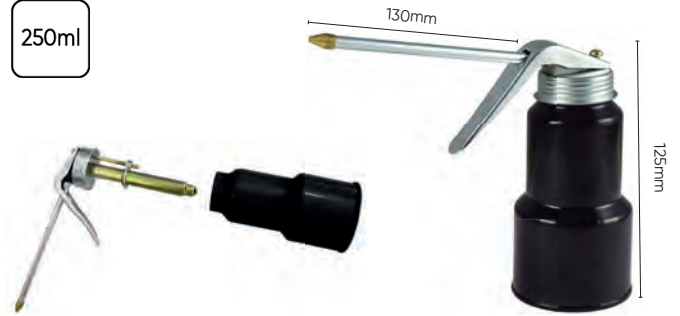

52991

10,50€

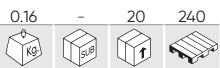

JAR CU GÂT FLEXIBIL 2L

2L



52992

18,00€

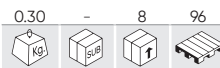

JAR CU GÂT FLEXIBIL 5L

5L



53187

39,00€

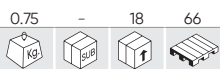

PÂLNIE PENTRU BIDON DE 200 L CU CAPAC ȘI FILTRU

4,5L



53188

7,00€

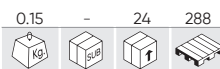

SET DE 3 PÂLNII

Ø 90,130,180mm



52391

5,00€

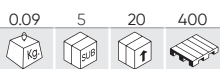

PÂLNIE CARBURANT

950ml



140x15mm



53198

9,50€



PÂLNIE CU TUB FLEXIBIL

1,8L



Ø 180mm



53849

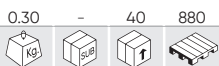

PISTOL COMPACT PENTRU GRESAJ



16,10€

50852

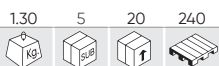

PISTOL MANUAL DE GRESARE CU TUB FLEXIBIL

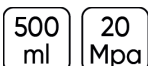

24,50€

50751



POMPĂ DE GRESARE PNEUMATICĂ

- Țeavă rigidă.
- Țeavă flexibilă.
- Presiune : 30 Mpa



43,00€

53592

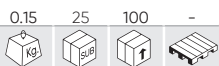

CUPLAREA RAPIDĂ



25,00€

54255

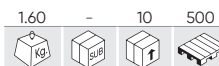

SET COMPLET DE ACCESORII PENTRU PISTOLUL DE GRESAT



68,00€

Se recomandă utilizarea acestuia cu pistoalele de ungere JBM ref. 50751 și 50852, deși este potrivit pentru utilizarea în majoritatea pistoalelor

60038

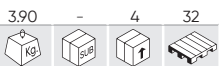

PISTOL BATERIE PENTRU GRESAT

BATERIA NU ESTE INCLUSĂ.

Acest instrument prezintă un pistol cu grăsime și este proiectat în scopuri de lubrifiere. Datorită designului fără fir și funcționării de la baterie poate fi ușor transportat și manipulat oriunde.

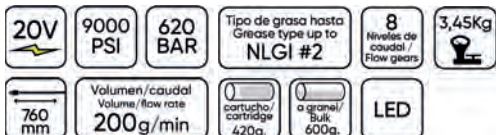

255,00€

SCULE HIDRAULICE

- 314 CRICURI HIDRAULICE
- 316 CRICURI HIDRAULICE TIP BUTELIE
- 317 CRICURI CU CLICHET
- 317 CRIC HIDRAULIC TELESCOPIC
- 318 SUPORTURI PENTRU CRIC AUTO
- 318 ALTELE
- 320 LIZE
- 321 PRESE
- 322 MACARALE
- 323 MESE DE RIDICARE
- 325 RACORD DE CAUCIUC PENTRU RIDICAREA MAȘINII



SCULE HIDRAULICE

53725

248,00€

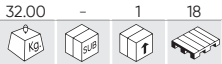

CRIC HIDRAULIC TIP CROCODIL 3T - SISTEM DE DEPLASARE RAPIDĂ



MAX: 465mm
MIN: 133mm



PIESE DISPONIBILE

ÎNDEPLINEȘTE CU: EN 1494:2001

50818

198,00€

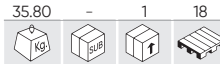

CRIC HIDRAULIC TIP CROCODIL 3,5T



MAX: 495mm
MIN: 133mm



PIESE DISPONIBILE

ÎNDEPLINEȘTE CU: EN 1494:2001

53422

368,00€

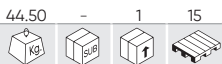

CRIC HIDRAULIC DE 3T. CU PEDAL DE RIDICARE



MAX: 533mm
MIN: 100mm



PIESE DISPONIBILE

50815

88,00€

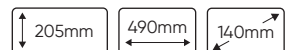

CRIC HIDRAULIC TIP CROCODIL 2T



MAX: 355mm
MIN: 130mm



PIESE DISPONIBILE

53112

298,00€



CRIC HIDRAULIC 3 T CU PEDALĂ



MAX: 520mm
MIN: 140mm



PIESE DISPONIBILE

53968

49,00€

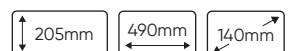

CRIC HIDRAULIC TIP CROCODIL 2T



MAX: 300mm
MIN: 130mm



PIESE DISPONIBILE

ÎNDEPLINEȘTE CU: EN 1494:2001

51895

99,00€

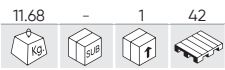

CRIC HIDRAULIC TIP CROCODIL ÎN CUTIE PLASTICĂ 2T.



↑ MAX: 355mm
↓ MIN: 130mm



PIESE DISPONIBILE

50816

88,00€

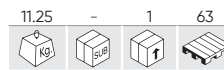

CRIC HIDRAULIC TIP CROCODIL 2T SPECIAL MAȘINI JOASE



↑ MAX: 340mm
↓ MIN: 90mm



PIESE DISPONIBILE

53421

298,00€

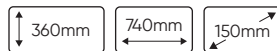
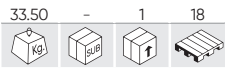

CRIC HIDRAULIC TIP CROCODIL 2T SPECIAL MAȘINI JOASE



↑ MAX: 505mm
↓ MIN: 75mm



PIESE DISPONIBILE

54137

288,00€

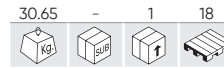

CRIC HIDRAULIC TIP CROCODIL 2,5T SPECIAL MAȘINI JOASE



↑ MAX: 505mm
↓ MIN: 78mm

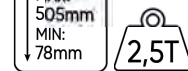

DUBLU PISTON

TUTORIAL DE ÎNTREȚINERE



CRICURI HIDRAULICE PENTRU MAȘINI JOASE

ACESTEA OFERĂ O ADAPTARE OPTIMĂ LA VEHICULELE CU PROFIL REDUS, DATORITĂ ÎNĂLȚIMII LOR REDUSE ȘI DESIGNULUI CURBAT.

SCULE HIDRAULICE

CRIC HIDRAULIC

<p>50819 28,00€</p> <p>2.42 - 6 330</p> <p>↑ MAX: 345mm ↓ MIN: 181mm</p> <p>2T</p>	<p>50820 34,50€</p> <p>3.20 - 6 300</p> <p>↑ MAX: 372mm ↓ MIN: 194mm</p> <p>3T</p>	<p>50821 47,00€</p> <p>4.10 - 5 200</p> <p>↑ MAX: 413mm ↓ MIN: 216mm</p> <p>5T</p>
---	---	---

<p>50822 59,00€</p> <p>5.60 - 4 200</p> <p>↑ MAX: 460mm ↓ MIN: 230mm</p> <p>10T</p>	<p>52304 84,00€</p> <p>7.20 - 2 136</p> <p>↑ MAX: 365mm ↓ MIN: 225mm</p> <p>15T</p>	<p>50823 94,00€</p> <p>10.18 - 2 96</p> <p>↑ MAX: 452mm ↓ MIN: 242mm</p> <p>20T</p>
--	--	--

<p>50824 88,00€</p> <p>8.47 - 2 120</p> <p>↑ MAX: 355mm ↓ MIN: 190mm</p> <p>20T</p> <p>SPECIAL MAȘINI JOASE</p>	<p>50825 154,00€</p> <p>7.62 - 2 96</p> <p>↑ MAX: 465mm ↓ MIN: 285mm</p> <p>30T</p>
--	--

CRICURI HIDRAULICE ÎN CUTIE DIN PLASTIC 2-5T

<p>51905 34,50€</p> <p>2.90 - 6 144</p> <p>↑ MAX: 340mm ↓ MIN: 185mm</p> <p>2T</p>	<p>51906 39,00€</p> <p>3.53 - 4 144</p> <p>↑ MAX: 385mm ↓ MIN: 195mm</p> <p>3T</p>	<p>51907 48,00€</p> <p>4.59 - 4 128</p> <p>↑ MAX: 450mm ↓ MIN: 215mm</p> <p>5T</p>
---	---	---

CRIC CU CREMALIERĂ 3T

REF.	Min.	Max.	mm				€
53895	130mm	330mm	510x265x140	9.15	1	42	107,00€
53896	130mm	645mm	840x265x140	11.60	1	28	127,00€
53897	130mm	1045mm	1220x265x140	13.85	1	21	140,00€
53898	130mm	1320mm	1520x265x140	15.65	1	21	148,00€



ACCESORII

REF.	DESCRIERE				€
15093	SUPPORT PIVOTANT ROATĂ	3.65	1	50	38,00€
15094	SUPPORT PENTRU CRIC	1.35	5	140	39,50€
15095	SUPPORT DE BLOCARE A MÂNERULUI	0.10	50	-	13,00€
15096	DISPOZITIV PENTRU RIDICARE DE ROATĂ	2.00	10	560	40,00€



15093



15094



15095



15096

54001**285,00€**

28.50	-	1	20

CRIC PENTRU CUTII VITEZE 0,5T

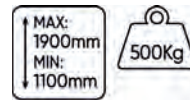

- Interval de ridicare de la 116 la 197 cm.
- Suport dubla poziție.
- Ridicare confortabilă și rapidă cu pedală.
- Supapă cu arc pentru coborâre controlată.
- Permite ridicarea și mutarea cutiilor de viteze, differentialelor, rezervoarelor etc. sigur și stabil.

PIESE
DISPONIBILE**50830****560,00€**

52.10	-	1	6

CRIC HIDRAULIC DE TRANSMISIE 0,5 TON.



- Cu handgrip.
- Rapid.
- Dublu piston.

PIESE
DISPONIBILE

SCULE HIDRAULICE

CRIC CU CREMALIERĂ 3T

REF.	DESCRIERE					€
53779	3T 290-430mm	5.05	-	1	72	36,00€
53845	6T 370-610mm	9.35	-	1	30	64,00€
54143	12T 500-770mm	35.50	-	1	12	249,00€



SET DE 2 SUPORTURI CRIC DE 10 TONE

REF.	DESCRIERE					€
54145	10T 482-775mm	37.90	-	1	4	377,00€
54146	10T 736-1212mm	2.00	-	1	4	492,00€



54147

198,00€



STAND DE RIDICARE 1,8 DE TONE (1220-2146MM)

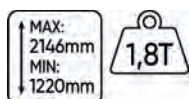

54144

298,00€



SET DE 2 SUPORTURI CRIC DE 22 TONE (338-500 MM)

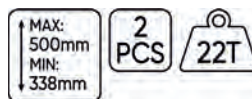

53200

69,00€

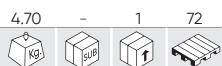

SUPORTI DE SUSȚINERE DE ALUMINIU PENTRU CAROSĂRII DE 3T

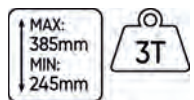

53218

26,00€



CRIC FOARFECĂ 1.5T

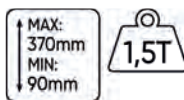

51901

999,00€

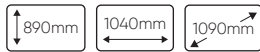
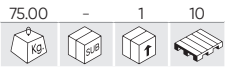

PURTĂTOR HIDRAULIC ROȚI AUTO CAP. 1T.



- Lungime: 1040 mm
- Lățime: 1090 mm
- Înălțime: 890 mm
- Intervalul de ridicare: 50-100 mm
- Diametrul maxim al roții: 1320 mm

SPECIALE PENTRU CAMIOANE



52241

1.690,00€



PURTĂTOR HIDRAULIC ROȚI AUTO 1,5T. SPECIAL PENTRU ROȚI DE CAMION



- Capacitate de încărcare: 1,5 tone
- Intervalul de ridicare: 0-770 mm
- Înălțime de gabarit: 1270 mm
- Lățime de gabarit: 990 mm
- Înălțime de gabarit: 1340 mm
- Diametrul maxim al roții: 2200 mm (86")
- Diametrul minim al roții: 1000 mm (39")
- Lățimea maximă a roții: 800 mm



54257

318,00€

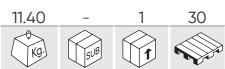

POMPĂ HIDRAULICĂ MANUALĂ

10000 PSI
3/8" NPT

PRESIUNEA DE LUCRU:
- Etapa 1: 0-20 kg/cm³
- Etapa 2: 20-700 kg/cm³

1,8m

DEBIT:
- Etapa 1: 13cc
- Etapa 2: 2.3cc



50835

290,00€

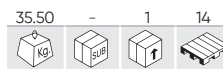

MAȘINĂ HIDRAULICĂ DE ÎNDOIT ȚEAVĂ 12T



PIESE DISPONIBILE

- Presiunea aerului: 0,75 - 0,75mpa
- Dimensiunea penei: 1/2", 3/4", 1", 1-1/4", 1-1/2", 2".
- Bare de îndoire reglabile pentru a se potrivi la distanța dorită.
- Construit din oțel robust capabil de a îndoii țevi de până la 50mm.

53880

598,00€

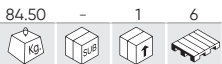

TRANSPALET MANUAL RIDICARE RAPIDĂ

- Capacitate de ridicare: 2500kg
- Lungimea împingătorului: 1150mm
- Mâner: Formă pătrată, cauciucat
- Roată volantă (de întoarcere): PU(200x50mm)
- Roată fixă: dublă, PU (80x70mm)
- Înălțimea minimă a furcii: 85mm
- Înălțimea maximă a furcii: 200mm
- Numărul de curse ale pompei: 8

ACȚIUNE RAPIDĂ
(OȚEL TURNAT)



PIESE
DISPONIBILE

54396

2.250,00€



N

TRANSPALET ELECTRIC



PIESE
DISPONIBILE



INFORMAȚII
TEHNICE

50839

180,00€

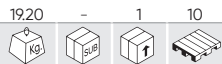

CRIC HIDRAULIC POZIȚIONARE MAȘINĂ
680KG



PIESE
DISPONIBILE



50923

454,00€



CĂRUCIOR PENTRU ROȚI CAROSERII



PIESE
DISPONIBILE



52514

84,00€

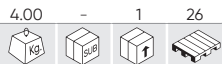

SUPORT PT. ELEVATOR DE MOTOCICLETE



PIESE
DISPONIBILE



51751

99,00€



SUPORT ELEVATOR DE MOTOCICLETE



PIESE
DISPONIBILE



53684

1.880,00€

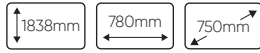
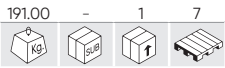

PRESĂ HIDRAULICĂ DE 30 T.

- Capacitatea de încărcare (T): 30.
- Cursa (mm): 160.
- Diapazonul de lucru (mm): 166-1126.
- Lățimea cadrului (mm): 540.
- Cursa laterală (mm): 200.
- Cursă: 150 mm.
- Manual și cu pedale.

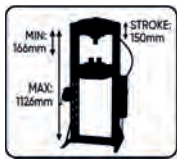

53590

1.190,00€



PRESĂ HIDRAULICĂ DE 20 T.

- Capacitatea de încărcare (T): 20.
- Cursa (mm): 145.
- Diapazonul de lucru (mm): 58-1018.
- Lățimea cadrului (mm): 540.
- Lățimea interioară (mm): 536.
- Cursa laterală (mm): 180.

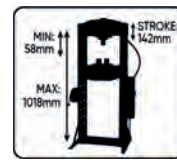

REF. DESCRIERE

14616 BARIERĂ RETICULARĂ PENTRU PRESA HIDRAULICĂ 20 T / 30 T (REF. 53590/53684)



€

96,00€

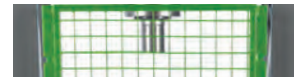

52999

178,00€

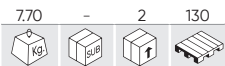

BAZĂ PENTRU PRESĂ

BLOC MARE



BLOC MICI



50827

387,00€

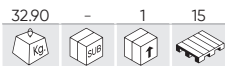

PRESĂ HIDRAULICĂ PT. ARCURI SAU AMORTIZOARE DE SUSPENSIE

- Capacitate: 1T (2200 lbs)
- Diametru arc comprimat: 200mm
- Lungime compresie: 200-500mm



50831

460,00€

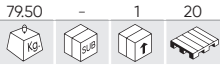

MACARA PLIABILĂ DE 2 T.



PIESE DISPONIBILE

52985

598,00€

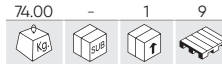

MACARA PLIABILĂ DE 1T



PIESE DISPONIBILE

50631

68,00€

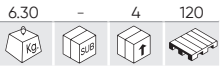

SUPORT PENTRU AGĂȚAT MOTOARE CAP. 750KG



50840

138,00€

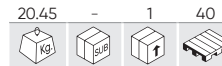

SUPORT PENTRU RIDICAT MOTOARE AUTO 500KG (1750MM)



REF.	DESCRIERE	kg	BOX	BOX	BOX	€
51452	DEGETUL MARE ȘI CÂRLIGUL 3.43	-	1	50	50	69,00€

53682

98,00€

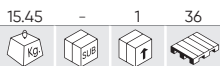

SUPORT PENTRU RIDICAT MOTOARE AUTO 500KG (1480MM)



52055

139,00€

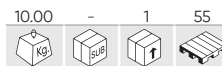

SUPORT PENTRU MOTOR AUTO UNIVERSAL



50836

148,00€

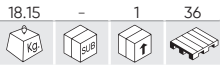

SUPORT PENTRU MOTOR AUTO 340KG



50838

299,00€

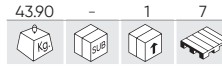

SUPORT MOTOR ROTATIV 900KG



- Dimensiuni pliabilitate:
1000x500x440mm.



CARUCIOR CU PLATAFORMA DE OTEL

54262

88,00€

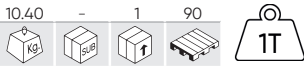

54263

130,00€

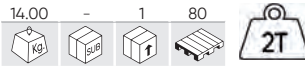

54264

240,00€

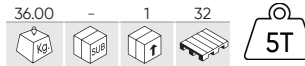

	54262	54263	54264
ÎNĂLȚIME DE RIDICARE	2,8m	2,8m	2,8m
CĂDERI DE LANȚ	1	2	2
MĂSURĂTORI LANȚ		Lanț de încărcare: 6x30mm Lanț de încărcare: 6x30mm	
LUNGIME		Lanț de încărcare: 3m Lanțul de mână: 2,5m	
EFORT PENTRU SARCINA MAXIMĂ	304N	310N	361N
MATERIAL		Lanț de încărcare: Oțel 20Mn2 Lanțul de mână: Oțel Q235	



52845

170,00€

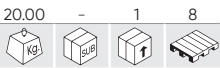

SET DE 2 RAMPE CE RIDICĂ 1 TONĂ

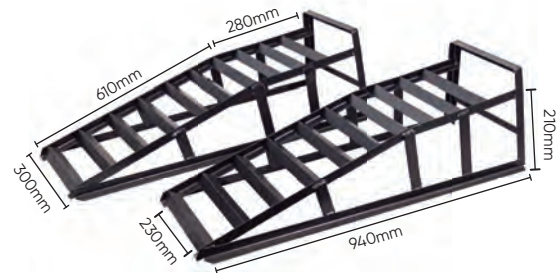

53423

199,00€

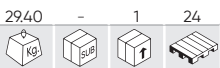

CRIC ATV



53969

96,00€

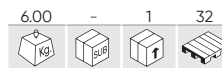

ELEVATOR PENTRU MOTOCICLETE



54386

5.839,00€

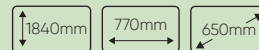
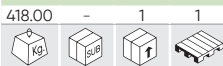

N

LIFT DE ASAMBLARE A BATERIILOR PENTRU VEhicULE ELECTRICE

Acest vehicul electric de tip foarfecă are avantajele ridicării libere, mersului flexibil, funcționării convenabile, stilului frumos și fără poluare. Poate fi utilizat pe scară largă ca platformă de lucru temporară pentru manipularea mărfurilor în ateliere, depozite, depouri de marfă și alte locații de dimensiuni mici. Este un instrument ideal pentru a reduce oboseala, pentru a îmbunătăți eficiența producției și pentru a realiza încărcarea și descărcarea în siguranță.

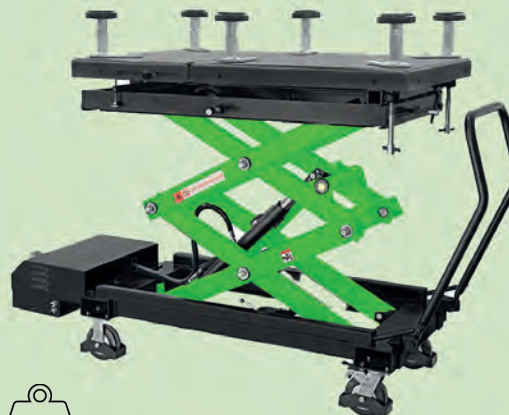

PIESE DISPONIBILE

Caracteristici de încărcare	Sarcina distribuită
Timpe de ridicare (fara sarcina)	60"
Timpe de coborâre (fără sarcină)	45"
Platformă	1290 - 1400x768mm

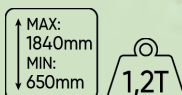

52692

129,00€



CRIC PENTRU MOTOCICLETE



50911

788,00€



ELEVATOR HIDRAULIC PENTRU MOTOCICLETE 365KG

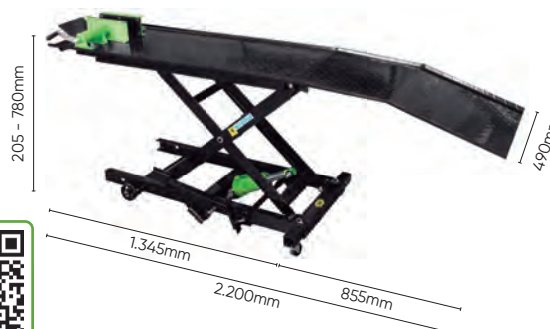

PIESE DISPONIBILE

53246

1.144,00€



MASĂ HIDRAULICĂ 360KG



50630

590,00€



MASĂ HIDRAULICĂ CAP 400KG











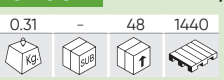

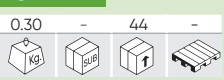

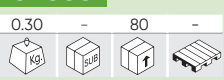

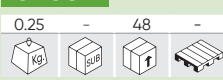





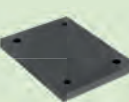

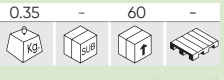
PIESE DISPONIBILE

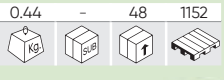
TAMPON DE RIDICARE DE CAUCIUC PENTRU ELEVATOR

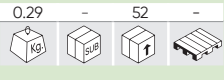

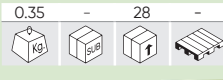
<p>54349 8,00€</p> <p>0.48 - 68 -</p> <p>A 160mm B 120mm C 20mm</p>	<p>54350 12,50€</p> <p>0.67 - 48 -</p> <p>A 160mm B 120mm C 30mm</p>	<p>54351 14,00€</p> <p>0.97 - 32 -</p> <p>A 160mm B 120mm C 40mm</p>	<p>54352 18,00€</p> <p>1.43 - 20 -</p> <p>A 160mm B 120mm C 60mm</p>
<p>54353 23,50€</p> <p>1.85 4 12 -</p> <p>A 160mm B 120mm C 80mm</p>	<p>54354 34,50€</p> <p>2.91 - 8 270</p> <p>A 160mm B 120mm C 120mm</p>	<p>54483 14,00€</p> <p>0.70 - 40 -</p> <p>A 160mm B 120mm C 35mm</p>	<p>54484 26,00€</p> <p>1.75 - 20 -</p> <p>A 160mm B 120mm C 70mm</p>
<p>54485 36,00€</p> <p>2.40 - 8 -</p> <p>A 160mm B 120mm C 100mm</p>	<p>54355 12,00€</p> <p>0.20 - 60 -</p> <p>RAVAGLIOLI/SIRIO/SPACE A 123mm D 108mm B 26mm E 10mm C 104mm</p>	<p>54360 14,00€</p> <p>0.19 - 72 -</p> <p>RAVAGLIOLI/SIRIO/SPACE A 130mm D 125mm B 23mm E 10mm C 121mm</p>	<p>54486 9,50€</p> <p>0.10 - 120 -</p> <p>RAVAGLIOLI/SIRIO/SPACE A 100mm D 85mm B 22mm E 8.5mm C 81mm</p>
<p>54488 15,00€</p> <p>0.25 - 40 -</p> <p>RAVAGLIOLI A 150mm D 135mm B 25mm E 10mm C 128mm</p>	<p>54493 13,50€</p> <p>0.20 - 60 -</p> <p>RAVAGLIOLI A 120mm B 110mm C 27mm</p>	<p>54494 14,00€</p> <p>0.30 - 48 1152</p> <p>RAVAGLIOLI A 145mm B 135mm C 26mm</p>	<p>54357 15,00€</p> <p>0.29 - 60 -</p> <p>TWIN BUSCH A 120mm D 105mm B 30mm E 8.5mm C 100mm F 66mm</p>
<p>54358 18,50€</p> <p>0.36 - 44 -</p> <p>TWIN BUSCH A 140mm D 125mm B 25mm E 10mm C 116mm F 66mm</p>	<p>54361 14,00€</p> <p>0.25 - 52 -</p> <p>TWIN BUSCH A 140mm D 125mm B 28mm E 8mm C 120mm</p>	<p>54363 14,00€</p> <p>0.30 - 44 -</p> <p>ISTOBAL/VELYEN A 155mm D 147mm B 24mm E 6mm C 140mm</p>	<p>54365 12,50€</p> <p>0.20 - 108 -</p> <p>ISTOBAL/VELYEN A 145mm B 10mm C 60mm</p>

TAMPON DE RIDICARE DE CAUCIUC PENTRU ELEVATOR

<p>54359 14,00€</p> <p>0.31 - 48 1440</p>   <p>OMCN</p> <p>A 140mm B 133mm C 27mm</p>	<p>54491 17,50€</p> <p>0.30 - 44 -</p>   <p>OMCN</p> <p>A 145mm B 25mm</p>	<p>54366 18,50€</p> <p>0.30 - 80 -</p>   <p>NASSBAUM/AMI</p> <p>A 125mm D 120mm B 24mm C 90mm</p>	<p>54362 14,00€</p> <p>0.25 - 48 -</p>   <p>CASCOS</p> <p>A 138mm D 130mm B 25mm E 9mm C 120mm</p>
<p>54487 15,00€</p> <p>0.15 - 80 -</p>   <p>ROTARY</p> <p>A 123mm D 112mm B 22mm E 8mm C 90,5mm</p>	<p>54495 18,00€</p> <p>0.25 - 108 3240</p>   <p>ROTARY</p> <p>A 125mm B 15mm C 90mm</p>	<p>54496 16,50€</p> <p>0.10 - 400 2400</p>   <p>ROTARY</p> <p>A 104mm D 80mm B 82mm E 56mm C 8mm</p>	<p>54497 12,50€</p> <p>0.15 - 88 2700</p>   <p>MAHA</p> <p>A 120mm D 113mm B 22mm E 8mm C 102mm F 83mm</p>
<p>54492 19,50€</p> <p>0.35 - 60 -</p>   <p>SLIFT/IME</p> <p>A 125mm D 110mm B 25mm E 9mm C 120mm F 83mm</p>	<p>54356 19,50€</p> <p>0.44 - 48 1152</p>   <p>500E/500X/ JEEP RENEGADE</p> <p>A 55mm B 100mm</p>	<p>54364 14,00€</p> <p>0.29 - 52 -</p>   <p>LAUNCH/TWIN BUSCH/RP TOOLS</p> <p>A 120mm D 108mm B 32mm C 70mm</p>	<p>54489 19,50€</p> <p>0.35 - 28 -</p>   <p>KONI/ROMERICO/CAR-O-LINER</p> <p>A 160mm D 153mm B 29mm E 10mm C 140mm</p>

54490 15,00€

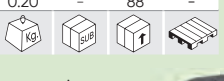
0.20 - 88 -





ATH/HOFMANN/
HERMANN/ J.A.B. BECKER

A 120mm D 110mm
B 19mm E 4mm
C 130mm

54175 34,00€

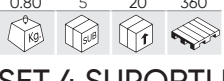
0.80 5 20 360



SET 4 SUPORTI RIDICARE ELEVATOR TESLA

NR TESLA 3/X/S/Y



SCULE ELECTRICE

- 328 DISPOZITIVE DE PORNIRE
- 329 ÎNTREȚINERE BATERII
- 330 MULTIMETRE
- 332 INSPECȚIE VIZUALĂ
- 332 SUDURĂ
- 334 ECHIPAMENTE DE ATELIER
- 337 AER CONDIȚIONAT
- 338 TERMOMETRE
- 338 ALTELE



CABLURI PENTRU REDRESOARE AUTO

CLEMA SOLIDA DE ALAMA

REF.	Ø CABLU	LONG	A	SECȚIUNEA					€
51238	17mm	5m	700	70mm ²	4.95	-	2	84	138,00€
51239	15mm	7m	700	70mm ²	5.90	-	2	72	159,00€

CLEMA DE ALAMA

REF.	Ø CABLU	LONG	A	SECȚIUNEA					€
52069	11mm	2,5m	250	25mm ²	1.55	-	10	240	29,50€
52070	12mm	3m	350	35mm ²	1.95	-	5	160	40,00€
52071	13mm	3m	500	50mm ²	2.35	-	5	90	47,00€

CLEMA SOLIDA DE ALAMA CU PROTECȚIE DE SUPRASARCINĂ

REF.	Ø CABLU	LONG	A	SECȚIUNEA					€
51363	12mm	3m	350	35mm ²	2.63	-	5	120	114,00€
51365	12mm	3m	600	50mm ²	3.10	-	5	90	118,00€



REF.	DESCRIERE					€
14145	CLEME DIN CUPRU	0.20	-	30	-	8,50€
14146	CLEME DIN CUPRU	0.20	-	30	1920	8,00€
14147	CLEME DIN ALAMĂ	0.35	-	15	-	25,00€
14148	CLEME DIN ALAMĂ	0.35	-	15	-	25,00€

53687 **298,00€**

11.35 - 1 14

ÎNCĂRCĂTOR DE VEHICUL 12V

- Tensiune: 12V.
- Acumulator: 22Ah, plumb-acid (1 buc.)
- Curent de pornire: 750A.
- Curent de vârf: 1500A.



PIESE DISPONIBILE

- A CONTORUL DE TENSIUNE INTERN AL BATERIEI
- B BUTON DE VERIFICARE A TENSIUNII INTERNE A BATERIEI
- C COMUTATOR PORNIT / OPRIT
- D LUMINĂ LED ÎNCORPORATĂ: EXTINDE VIZIBILITATEA ZONEI DE LUCRU

53688 **495,00€**

18.05 - 1 14

DEMAROR DE VEHICUL 12/24V

- Tensiune: 12V/24V.
- Acumulator: 22 A*h, plumb-acid AGM (2 buc.)
- Curent de pornire: 12V: 1500A/3000A.
- Curent de vârf: 24V: 750A/1500A.
- Timp de încărcare a bateriei: Încărcare completă a bateriei: 40 ore
- Încărcare până la 10-20%: 6 ore



PIESE DISPONIBILE

- A CONTORUL DE TENSIUNE INTERN AL BATERIEI
- B BUTON DE VERIFICARE A TENSIUNII INTERNE A BATERIEI
- C COMUTATOR PORNIT / OPRIT
- D LUMINĂ LED ÎNCORPORATĂ: EXTINDE VIZIBILITATEA ZONEI DE LUCRU

51816 58,00€



TESTER DE BATERIE DIGITAL

- 150Ah.
- Se aplică la baterii de 12 V.
- Măsurare în SAE (CCA), EN, IEC, DIN, CA.
- Rang : 200~1200 CAA (SAE).
- Volt măsurat : 7 V~15 V.
- Ecran 4 + 3 Leduri (verde, roșu, galben).



51235 49,00€



TESTER DE BATERIE

- Pentru baterii de 6 V și 12 V.
- Încărcare de până la 100 Ah.
- Test Starea Încărcării.
- Test Consum de Încărcare.
- Test de Tensiune Încărcare.
- Test Condiții Baterie.



52884 73,00€



MEMORIE DEPOZIT PENTRU SCHIMBAREA BATERIEI

12V

- Util pentru a menține curent în sistemul electric al vehiculului în timpul.
- Schimbul de baterie.
- Conexiune prin cablu OBDII sau brichetă.



53209 8,50€



HIDROMETRU PENTRU BATERII

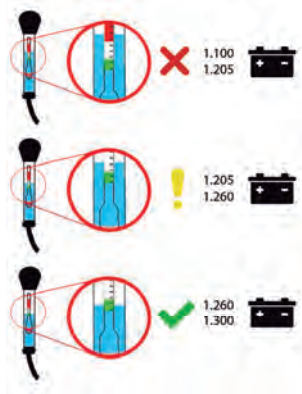

ÎNCĂRCĂTOARE DE BATERII

Compatibil cu Baterii plumb-acid: lichid, heliu, MF și AGM

53927 66,00€

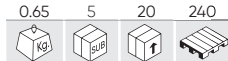

100V 240V 60W 50-60 HZ

7.2 VDC 0.9-3.6A 0°C 40°C

6V 7.2V 12V 14.4V NORM

6V 7.4V 12V 14.7V COLD/AGM



53929 95,00€

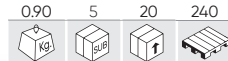

100V 240V 150W 50-60 HZ

14.7 VDC 3.6-7.2A -20°C 40°C

12V 14.4V 24V 28.8V NORM

12V 14.7V 24V 29.4V COLD/AGM



52233

328,00€



TESTER DE BATERIE ȘI ALTERNATOARE CU IMPRINTĂ

- Se aplică la baterii de 6v și 12v.
- Sisteme de încărcare și aprindere de 12v și 24v.
- Rang de operare: 40 - 2000 cca (sae).
- Voltmetru: 1,5v - 30v.
- Joc de cabluri de 180cm.
- Include:
1 rolă de hârtie termică.



AGM, GEL, VRLA, SLI



54040

240,00€

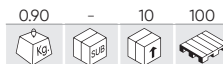

DISPOZITIV DE TESTARE CU FUNCȚIE DE IMPRIMARE

- Aplicabil pentru bateriile de 12V, AGM (cover de sticlă absorbant), GEL (gel), VRLA (acid de plumb ermetic), SLI (electrolit lichid).
- Domeniu de funcționare: 100-2000 curent pornire la rece CCA (SAE)
- Limbi disponibile ale sistemului:
Spaniolă (ES)
Engleză (EN)
Franceză (FR)
Germană (DE)
Italiană (IT)
Portugheză (PT)
Română (RO).
- Aplicabil pentru sistemele de pornire 12/24 V.
- Aplicabil bateriilor de 12V, AGM (cover de sticlă absorbant), GEL (gel), VRLA (acid de plumb sigilat), SLI (electrolit lichid).
- Dispozitiv de testare demaroadă și alternatoare.
- Include: O baterie CR2032.



REF. DESCRIERE

0.10 6 72 €

51842 HÂRTIE TERMICĂ PENTRU IMPRINTĂ REF. 52233-54040

0.10 6 72 6,90€

54256

48,00€



PROTECTOR AUTO CONTRA SUPRATENSIUNII 12/24V



52231

49,00€

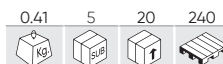

SET DE ACCESORII PENTRU MULTIMETRU

- Kit potrivit pentru majoritatea multimetrelor.

- INCLUDE**
- 2 sonde.
 - 2 cleme mici.
 - 2 cleme lungi.
 - Cabluri prelungitoare.



54114

248,00€

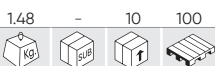

TESTER REZISTENTA IZOLATIE

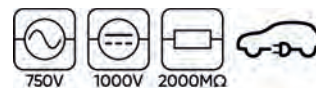

Categoria de instalare:	2
Categoria de măsurare:	CAT III
Altitudine:	Până la 2000 de metri
Afișaj	LCD cu afișaj dublu
Tensiune curent alternativ:	0 - 750V
Tensiune:	0 - 1000V
Rezistență:	0 - 200Ω / 200 - 2000 Ω
Rezistență de izolare:	0 - 200MΩ / 200 - 2000 MΩ
Rată de eșantionare:	de 2,5 ori pe secundă
Ajustare la zero:	Ajustare automată
Temperatură de operare:	00 - 400C (320F - 1040F), umiditate relativă sub 80%
Temperatură de depozitare:	-100C - 600C (140F - 1400F), umiditate relativă sub 70%

Sursă de alimentare:	DC9V (6 baterii 1.5V de tip AA)
Dimensiuni (lungime x lățime x înălțime):	200 x 92 x 50mm



50942

28,00€

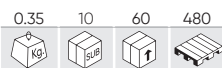

MULTIMETRU DIGITAL

- Digiți: 3 1/2.
- Măsurare: 2 000.
- Date instant.
- Autoînchidere.
- Indicator de baterie.
- Baterii de 9 V.
- Sondă de temperatură.
- Temperatură de la -40 °C la 1000 °C.



AC	AC
200mV, 2V, 20V, 200V, 1000V	20mA, 200mA, 20A
DC	DC
200mV, 2V, 20V, 200V, 750V	20mA, 200mA, 20A
200Ω, 2KΩ, 20KΩ, 200KΩ, 2MΩ, 20MΩ, 2000MΩ	2nF, 20nF, 200nF, 2μF, 20μF, 200μF

52439

227,00€

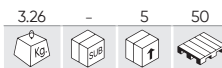

TRUSĂ DE CABLURI ȘI ACC PENTRU MULTIMETRU

- 2 măsurători de rezistență variabile.
- 2 lumini led de verificare.
- 2 SRS substituție și a dispozitivelor de probă.
- 2 clești tip crocodil.
- 2 prize cuplare rapidă.
- 4 sonde.
- 24 conectori formă rapidă.
- 48 conectori formă lată.



52382

19,50€

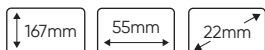
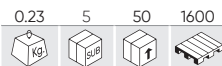

CLEȘTE AMPERMETRIC

- Instrument ideal pentru electricieni.
- Se poate măsura: voltaj AC, voltaj DC, Curent AC, rezistență, diodă, frecvență.
- Mediu de operare: 0°C a 40°C, la <80%RH.
- Mediu de depozitare: -10°C a 40°C, la <85%RH.
- Alimentare: 2 baterii AAA.
- Indicator de baterie descărcată.
- Ecran de 3,5" cu 4 digiți.
- Funcție de curent continuu.
- Măsurarea tensiunii AC/DC.



DCB	600V
ACB	600V
DCA	-
ACA	20A, 200A, 600A
OHM	2KΩ, 200KΩ, 2MΩ

- FUNCȚII:
Live Test de sârmă.

52952

74,00€

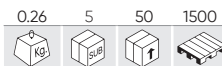

CLEȘTE AMPERMETRIC PROFESIONAL

- Instrument ideal pentru electricieni.
- Se poate măsura: voltaj AC, voltaj DC, Curent AC, rezistență, diodă, frecvență.
- Mediu de operare: 0°C a 40°C, la <80%RH.
- Mediu de depozitare: -10°C a 40°C, la <85%RH.
- Alimentare: 2 baterii AAA.
- Indicator de baterie descărcată.
- Ecran de 3,5" cu 4 digiți.
- Funcție de curent continuu.
- Măsurarea tensiunii AC/DC.



DCB	20V, 600V
ACB	600V
DCA	200A
ACA	200A
OHM	2000Ω

- FUNCȚII:
Live Test de sârmă.
Testul diodei.
Test de continuitate.
Funcție de ADP.
Funcția de detectare a fazei.
Comutator ZERO.

53028

5,80€

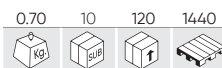

CIRCUIT DE TESTER AUTO 1,8X190MM

6-12-24V
1,8 x 190mm



- Potrivit pentru verificarea polarității.

53029

6,80€

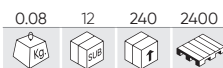

CIRCUIT DE TESTER AUTO 2X115MM

6-12-24V
2 x 115mm



53030

12,00€



CIRCUIT DE TESTER AUTO 3X142MM

6-12-24V
3 x 142mm
LED



53724

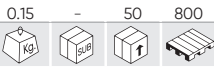

ENDOSCOP CU WIFI

- Endoscop cu funcție de transmitere a imaginii prin Wi-Fi. Posibilitatea de conectare la orice smartphone. Compatibil cu tableta sau computerul.

- Setul de livrare include:
 Camera endoscopică.
 Transmițător Wi-Fi.
 Duză-cârlig.
 Duză-magnet.
 Duză-oglină laterală.

1M CABLU SEMIRIGID



Funcționează cu aplicația JBM:



615,00€

53484

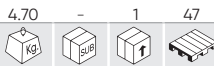

DETECTORUL SCURGERII DE GAZ

- ULEIUL NU ESTE INCLUS.

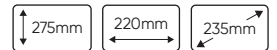

INCLUDE

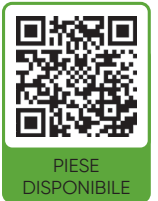

PIESE DISPONIBILE

53977

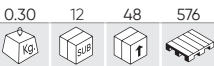

PISTOL DE LIPIT DE 40W

17,50€



- Tensiunea: 220-240V.
 - Lungime: 240mm
 - Cablu: 1,3m
 - Temperatura maximă de lucru: 450° +/- 10%



53111

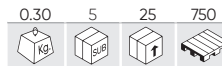

PISTOL DE LIPIT STANIU 100VW

19,00€



- Tensiunea: 220-240V.
 - Lungime: 250mm.
 - Cablu: 1,5m.
 - Temperatura maximă de lucru: 420° +/- 10%.



53145

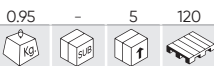

PISTOL DE LIPIT CU CĂLDURĂ 2000W

39,20€



- 220V-240V.
 - 50Hz-60HZ.
 - 2000W.
 - Temperatura de ieșire: 50-600°C.
 - Airflow: 220-480L / min.
 - 2 opțiuni de temperatură: 300 i 600.



53162

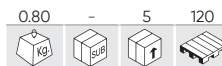

PISTOL DE LIPIT CU CĂLDURĂ DIGITAL 2000W

60,00€



- 220V-240V.
 - 50Hz-60HZ.
 - 2000W.
 - Temperatura de ieșire: 100-600°C.
 - Airflow: 280-480L / min.



53981

143,00€

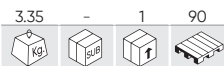

DISPOZITIV PENTRU SUDARE MANUALĂ CU ARC ELECTRIC CU INVERTER DC 100 A

INCLUDE

Suport electrod cu cablu de 2m.
Clemă de împământare cu cablu de 1,5m.
Ciocan cu perie de sârma pentru sudură.
Ecran facial manual.



- ✓ INVERTOR CU TEHNOLOGIA IGBT
- ✓ SUDARE MANUALĂ CU ARC CU CURENT CONTINUU
- ✓ PROTECȚIA ÎMPOTRIVA ARSURII
- ✓ PUTEREA ARCULUI
- ✓ APRINDERE ARC FIERBINTE



53982

219,00€

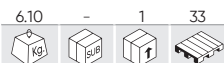

DISPOZITIV PENTRU SUDARE MANUALĂ CU ARC ELECTRIC CU INVERTER DC 160 A

INCLUDE

Suport electrod cu cablu de 2m.
Clemă de împământare cu cablu de 1,5m.
Ciocan cu perie de sârma pentru sudură.
Ecran facial manual.



- ✓ INVERTOR CU TEHNOLOGIA IGBT
- ✓ SUDARE MANUALĂ CU ARC CU CURENT CONTINUU
- ✓ PROTECȚIA ÎMPOTRIVA ARSURII
- ✓ PUTEREA ARCULUI
- ✓ APRINDERE ARC FIERBINTE



53414

49,00€



CASCĂ PENTRU SUDURĂ CU REGULATOR MANUAL



REGULATOR ANALOGIC PENTRU REGLAREA SENSIBILITĂȚII ȘI ÎNTUNECĂRII

53415

188,00€



CASCĂ PENTRU SUDURĂ CU REGULATOR DIGITAL



REGULATOR DIGITAL DE SENSIBILITATE, OBSCURITATE ȘI MIȘCARE

PĂTRAT MAGNETIC 45°, 90°, 135°

REF.	↔	📦	📦	📦	📦	€
54111	75mm	0.35	10	40	1680	4,75€
54113	100mm	0.60	10	20	1100	7,65€



54482

677,00€

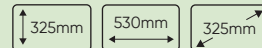
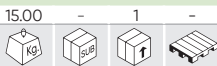

N

CURĂȚĂTOR CU ULTRASUNETE 30L

Acest aparat vă permite să curățați piesele prin emiterea de ultrasunete. Este indicat în special pentru curățarea pieselor cu forme complexe.

PUTERE ULTRASONICĂ: 600 W	ALIMENTARE ELECTRICĂ: 200~240 V (50 HZ)
PUTERE DE ÎNCĂLZIRE: 500 W	NUMĂRUL DE TRANSDUCTORI: 10
CAPACITATE REZERVOR: 30 L	ÎNCĂLZITOR: 0~80 °C
FRECVENȚĂ ULTRASONICĂ: 40 KHZ	MATERIAL: OȚEL INOXIDABIL SUS304
TEMPORIZATOR: 1~30 MIN.	DIMENSIUNI REZERVOR: 500x300x200 mm



53220

260,00€

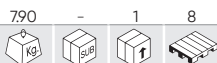

MAȘINĂ DE SPĂLAT PIESE PORTABILĂ

- FORMAT PORTABIL.
- Permite închiderea etanșă la apă pentru a evita pierderile în timpul transportului.
- Comutator de aprindere laterală.
- Filtru de curățare lichid inclus.
- Furtun și furtun de protecție incluse.
- Compartimentul de depozitare.
- Separarea zonelor de lucru, zona de curățare și zona de uscare permite lucrul cu mai multe bucăți odată.

- Capacitate maximă: 27,5 L.
- Conectare la 220V.
- Capacitate de pompare: 1.000 L / h.
- Capacitate de lucru: 20L.
- Furtun lung de 1,10 m.



POLIZOR ELECTRIC

REF.	W	V/W	RPM	HZ	Ø I	Ø II	Ø III	Icon 1	Icon 2	Icon 3	Icon 4	€
53656	450W	230V/450W	2950RPM	50Hz	ø 150mm	ø 20mm	ø 12,7mm	11.05	-	1	50	198,00€
53657	600W	230V/600W	2950RPM	50Hz	ø 200mm	ø 25mm	ø 15,88mm	16.35	-	1	24	248,00€
53658	250W	230V/250W	2950RPM	50Hz	ø 150mm	ø 20mm	ø 12,7mm	6.95	-	1	60	99,00€
53659	250W	230V/250W	2950RPM	50Hz	ø 150mm ø 200mm	ø 20mm ø 40mm	ø 12,7mm ø 20mm	9.70	-	1	15	121,00€



53656
53657



53658



53659

52195

170,00€



POLIZOR ELECTRIC 150MM

- Putere motor 250W.
- Turație 2.950rpm.
- Tensiune alimentare 230V / 50Hz.
- Diametru piatră 150 x 20 x 12.7mm.



53660

146,00€



CADRU DIN OȚEL PENTRU MAȘINI DE CURĂȚARE

- Înălțime: 790mm.
- Dimensiunea plăcii de montare: 250x280mm.



54342

858,00€



N

MAȘINĂ DE CURĂȚARE A PIESELOR CU TERMOSTAT

70-120
PSI0,8
L/minMAX
50°C

8-14L

5
CFM740mm
560mm
452mm

1710mm

790mm

610mm

PIESE
DISPONIBILE

Utilaj conceput pentru spălarea perfectă a pieselor murdare. Include un pistol pneumatic pentru a curăța cu solvent și care poate fi utilizat și pentru a usca piesele cu ajutorul aerului comprimat.

Grație cabinei sale închise, operatorul este complet protejat de stropi și de mirosul solventului. Dispune de un termostat cu ajutorul căruia puteți regla nivelul de temperatură al lichidului de curățare și de lumină în interiorul rezervorului pentru o mai bună vizualizare.

54341

643,00€



N

MAȘINĂ DE SABLAT 220L

100V
240V40-120
PSI15-25
PSI

33L

860mm
560mm
560mm

390mm

905mm

632mm

PIESE
DISPONIBILE

Această mașină de sablat este ușor de utilizat, portabilă și oferă un mediu sigur, gata de utilizare cu mediile abrazive la alegere, având capacitatea de a curăța următoarele părți: piese ruginite, pete etc.

52980

480,00€



150L

MASINA DE SPALAT PIESE 150L

MĂSURILE TOTALĂ A UTILAJULUI

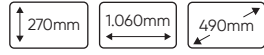

MĂSURILE INTERNE REZERVOR

PIESE
DISPONIBILE

50632

298,00€



100L

MAȘINĂ DE SPĂLAT PIESE

MĂSURILE TOTALĂ A UTILAJULUI

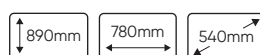

MĂSURILE INTERNE REZERVOR

PIESE
DISPONIBILE

- Debit: 25 l.
- Funcționează cu soluții de curățare a motoarelor solubile în apă.

- Debit: 25 l.
- Funcționează cu soluții de curățare a motoarelor solubile în apă.

51837

195,00€

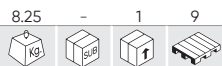

ASPIRATOR INDUSTRIAL 30L. USCAT

30L

Volum (l)	30
Volumul de aspirație pe secundă (l/s)	26
Putere	1x1.200W
Tensiune	230V
Frecvență	50Hz
Aspirație	> 17Kpa
Ø furtun	32mm
Lungime furtun	1,5m
Lungime cablu	4,5m
Etanșare	IPx4



PIESE DISPONIBILE

INCLUDE



* Acest aspirator are un sistem care permite o aprindere automată dacă este conectat la un șefuitor.

51838

667,00€



ASPIRATOR INDUSTRIAL DE 80L. (USCAT ȘI UMED)

80L

Volum (l)	80
Volumul de aspirație pe secundă (l/s)	50
Putere	3x1.000W
Tensiune	230V
Frecvență	50Hz
Aspirație	> 20Kpa
Ø furtun	48mm
Lungime furtun	2m
Lungime cablu	4,5m
Etanșare	IPx4



PIESE DISPONIBILE

INCLUDE



53947

145,00€

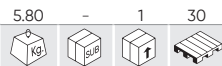

SPĂLĂTOR DE ÎNALTĂ PRESIUNE 1400 W

230V	1400W	MAX 105 Bar	MAX. AGUA WATER 50°C	5,0Kg
MAX 6,8L/min	5m	3m	50 Hz	IP X5

INCLUDE



PIESE DISPONIBILE

- A PISTOL DE PULVERIZARE
- B CABLU DE ALIMENTARE
- C EVACUARE APĂ
- D FURTUN DE PRESIUNE ÎNALTĂ

53948

324,00€

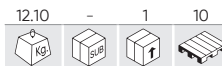

SPĂLĂTOR DE ÎNALTĂ PRESIUNE 2400 W

230V	2400W	MAX 180 Bar	MAX. AGUA WATER 50°C	10,0Kg
MAX 8L/min	5m	8m	50 Hz	IP X5

INCLUDE



PIESE DISPONIBILE

- A FURTUN DE PRESIUNE ÎNALTĂ
- B PISTOL DE PULVERIZARE
- C EVACUARE APĂ
- D CABLU DE ALIMENTARE

53189 128,00€

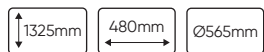
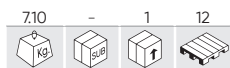

VENTILATOR PE PICIOR

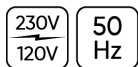

54125 152,00€

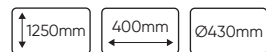
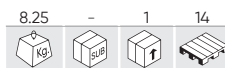

VENTILATOR DE PULVERIZARE A APEI



PIESE DISPONIBILE



53543 13,80€



VENTILATOR PENTRU AUTOVEHICUL - 12 V



X2 VITEZĂ



53190 98,00€



VENTILATOR DE PODEA



54229 48,00€



RADIATOR 2KW



54229
54230

54230 68,00€



RADIATOR 3KW



54231 138,00€



RADIATOR 5KW



54231
54232

54232 248,00€



RADIATOR 9KW

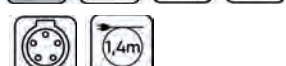

SCULE ELECTRICE

52162

38,00€



TERMOMETRU DIGITAL CU LASER -50°C LA 550°C

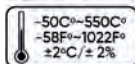

52450

105,00€

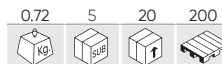

TERMOMETRU DIGITAL CU LASER -50°C LA 1.000°C



53503

12,00€

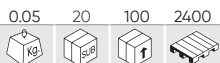

THERMOMETRU DIGITAL CU CONTACT

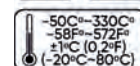

53585

168,00€



ROLĂ / TAMBUR CABLU ELECTRIC

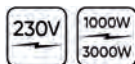
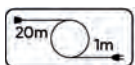

53586

168,00€



ROLĂ / TAMBUR CABLU ELECTRIC 21M

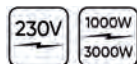
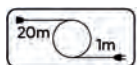

REF. DESCRIERE

14771 SUPORT DE MONTARE PE PERETE PT. BOBINE DE ÎNFĂȘURARE FURTUNURI REF. 53532, 53581, 53585, 53586

0.35 - 30 - 10,50€

53584

119,00€

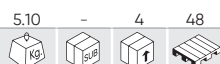

ROLĂ / TAMBUR CABLU ELECTRIC - 12M

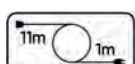

53526

119,00€



ROLĂ / TAMBUR CABLU ELECTRIC 12M

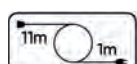

REF. DESCRIERE

14774 SUPORT DE MONTARE PE PERETE PT. BOBINE DE ÎNFĂȘURARE FURTUNURI REF. 53526, 53584

0.40 - 10 - 10,50€

51831 24,00€

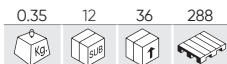

PISTOL DE LIPIT CU ADEZIVE

- Tensiune: 100~230 V.
- Temperatura: 190~230 °C.
- Consum: 60~150 W.
- Diam. conectorului: 2.0~2.3 mm.
- Rang: de 8 la 16g de produs/minut.



REF.	DESCRIERE					€
51859	BLISTER 10U ADEZIV TERMOFUZIBIL PENTRU REF. 51831	0.12	8	32	1520	3,80€

51033 98,00€



ROLĂ / TAMBUR CABLU ELECTRIC 25M



- Protecție de suprasarcină.
- Protecția Copilului.



PRELUNGITOR

REF.	m					€
53166	3m	0.45	5	30	600	10,50€
53167	5m	0.65	5	20	600	12,50€
53168	10m	1.20	-	10	300	19,00€



52643 596,00€



APARAT PENTRU REGROVAT ANVELOPE

REGLABIL DIGITAL

REF.	DESCRIERE				€
11974	PIESĂ DE SCHIMB R1 PENTRU APARATUL DE REGROVAT ANVELOPE CU REF. 52643	0.01	20	500	1,80€
11975	PIESĂ DE SCHIMB R2 PENTRU APARATUL DE REGROVAT ANVELOPE REF. 52643	0.01	20	500	1,80€
11976	PIESĂ DE SCHIMB R3 PENTRU APARATUL DE REGROVAT ANVELOPE CU REF. 52643	0.01	20	500	1,80€
11977	PIESĂ DE SCHIMB R4 PENTRU APARATUL DE REGROVAT ANVELOPE CU REF. 52643	0.01	20	500	1,80€
11978	PIESĂ DE SCHIMB R5 PENTRU APARATUL DE REGROVAT ANVELOPE CU REF. 52643	0.04	20	100	1,80€
11979	PIESĂ DE SCHIMB W1 PENTRU APARATUL DE REGROVAT ANVELOPE CU REF. 52643	0.04	20	500	1,80€
11980	PIESĂ DE SCHIMB W2 PENTRU APARATUL DE REGROVAT ANVELOPE CU REF. 52643	0.04	20	500	1,80€
11981	PIESĂ DE SCHIMB W3 PENTRU APARATUL DE REGROVAT ANVELOPE CU REF. 52643	0.01	20	500	1,80€
11982	PIESĂ DE SCHIMB W4 PENTRU APARATUL DE REGROVAT ANVELOPE REF. 52643	0.01	20	200	1,80€
11983	PIESĂ DE SCHIMB PENTRU REF. 52643	0.04	20	500	1,80€



PIESE DE SCHIMB

REF.	11974	11975	11976	11977	11978
TIP DE LAMĂ	R1	R2	R3	R4	R5
LAMA ROTUND	mm	mm	mm	mm	mm
	A 3	5	6	8	10
	B 7	7	10	12	12
	C 5	8	15	16	18
	D 21	21	23	25	24

REF.	11979	11980	11981	11982	11983
TIP DE LAMĂ	W1	W2	W3	W4	W5
CUȚIT DE PĂTRAT	mm	mm	mm	mm	mm
	A 3	5	7	9	11
	B 7	7	10	12	12
	C 5	6	10	13	15
	D 21	21	22	24	23

52598

1.080,00€

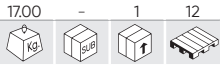

ROBOT - MAȘINĂ DE TAIAT IARBA



5200 mAh capacitate a bateriei battery capacity	1400m ² suprafata de lucru working area	IP X4 rezistenta la apă water resistance	DC 15-25.5V tensiune de lucru working voltage	2,5h autonomia autonomy	22m/min viteza de tăiere cutting speed
115,44W consumul de energie consumption	AC 100-240V 50/60Hz tensiune de alimentare input voltage	7,5Kg greutate weight	2h timp de încărcare charging time	70 dB(A) nivel de zgomot noise level	50-35,5-24 cm înălțimea de tăiere cutting height



CONEXIUNEA APP



- A MOTOR BRUSHLESS
- B BUTON DE BLOCARE STOP
- C STAȚIE DE ÎNCĂRCARE
- D ROATA DIN SPATE
- E CAPACUL MÂNERULUI

54252

199,00€

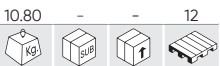

MĂTURĂTOR MANUAL CU ÎMPINGERE

- A CONTAINER DE COLECTARE A MURDĂRIEI
- B CORPUL PRINCIPAL
- C PERIE DE DISC STÂNGA
- D PERIE DE DISC DREAPTA
- E CAPACUL SUPERIOR
- F MÂNER DE ÎMPINGERE SUPERIOR
- G MÂNER DE ÎMPINGERE INFERIOR
- H MÂNER DE TRANSPORT

1800 m ² /h capacitate de curățare cleaning capacity	200 mm PVC diametrul discului disc diameter	50 mm PVC diametrul periei brush diameter
25L capacitate de colectare collection capacity	Ø 260mm diametrul corpului body diameter	650 x15mm mărimi periei brush sizes

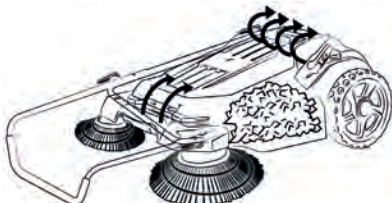

ENERGIE REGENERABILĂ ȘI MOBILITATE

342 CABLURI DE ÎNCĂRCARE A MAȘINILOR ELECTRICE

342 ÎNCĂRCĂTOARE PENTRU MAȘINI ELECTRICE

343 GENERATOR DE ENERGIE

344 SCULE IZOLATE



CABLU DE ÎNCĂRCARE

TIPO 1-2 TYPE 1-2

REF.	DESCRIERE					€
54053	CABLU DE ÎNCĂRCARE ELECTRICĂ PENTRU AUTOMOBIL, 3,6KW, 16 A, DIN TIPUL 1 ÎN TIPUL 2 (SINGLE-PHASE)	2.15	-	5	-	248,00€
54054	CABLU DE ÎNCĂRCARE ELECTRICĂ PENTRU AUTOMOBIL, 7,5KW, 32 A, DIN TIPUL 1 ÎN TIPUL 2 (SINGLE-PHASE)	2.90	-	5	100	268,00€

-25°
+55°

Tipo
1-2

IP66

5m



TIPO 2-2 TYPE 2-2

REF.	DESCRIERE					€
54055	CABLU DE ÎNCĂRCARE ELECTRICĂ PENTRU AUTOMOBIL, 3,6KW, 16 A, DIN TIPUL 2 ÎN TIPUL 2 (SINGLE-PHASE)	2.15	-	5	100	220,00€
54056	CABLU DE ÎNCĂRCARE PENTRU MAȘINĂ ELECTRICĂ, 11KW, 16 A, DIN TIPUL 2 ÎN TIPUL 2 (TRIFAZAT)	2.85	-	5	102	260,00€
54057	CABLU DE ÎNCĂRCARE ELECTRICĂ PENTRU AUTOMOBIL, 7,5KW, 32 A, DIN TIPUL 2 ÎN TIPUL 2 (SINGLE-PHASE)	2.95	-	5	102	248,00€
54058	CABLU DE ÎNCĂRCARE ELECTRICĂ PENTRU AUTOMOBIL, 22KW, 32 A, DIN TIPUL 2 ÎN TIPUL 2 (TRIFAZAT)	3.85	-	5	100	348,00€

-25°
+55°

Tipo
2-2

IP66

5m



ÎNCĂRCĂTOR DE REȚEA

REF.	DESCRIERE					€
52600	ÎNCĂRCĂTOR DE REȚEA 3,6 KW, 16 A, PENTRU MAȘINI ELECTRICE (SINGLE-PHASE)	4.65	-	4	80	884,00€
52902	ÎNCĂRCĂTOR DE REȚEA 7,5 KW, 32 A, PENTRU MAȘINI ELECTRICE (SINGLE-PHASE)	4.90	-	4	40	970,00€
52903	ÎNCĂRCĂTOR DE REȚEA 11 KW, 16 A, PENTRU MAȘINI ELECTRICE (TRIFAZAT)	5.25	-	1	40	1.100,00€

↑ 295mm

← 195mm

↙ 65mm

IP66

-25°
+55°

Tipo
2



54265

1.290,00€

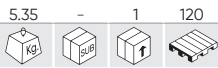

ÎNCĂRCĂTOR DE REȚEA 22 KW, 32 A, PENTRU MAȘINI ELECTRICE (TRIFAZAT)

32A 22 kW Tipo 2

Trifásico
Three-Phase



Alăturați-vă viitorului, cu sistemul nostru de încărcare rapidă pentru mașina dumneavoastră electrică. Design modern și minimalist. Astăzi, cu încărcătorul de perete JBM puteți transforma garajul, curtea din spate sau parcare de la birou într-un loc ușor de utilizat pentru EV/PHEV-ul dumneavoastră.

REF.	DESCRIERE				€
16130	CONTOR DE CURENT PENTRU ÎNCĂRCĂTOR 54265	0.40	-	15	290,00€
16198	CARD DE IDENTIFICARE A FRECVENȚELOR RADIO (CARD RFID) - 54265	0.01	-	-	5,00€

54059

428,00€

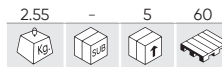

STAȚIE DE ÎNCĂRCARE PORTABILĂ, 16A CU CABLU DE ÎNCĂRCARE TIP 2

16A 3.68 kW IP66
6m -25°/+55° Tipo 2



Cu acest încărcător mobil, încărcați vă vehiculul oriunde vă aflați, cu o priză normală, pentru liniștea dvs. la drum. De asemenea, o soluție rapidă și economică pentru încărcarea mașinilor electrice în atelierul dumneavoastră. Afișajul LCD cu acces la cei mai importanți parametri, cablul integrat de tip 2, designul compact, carcasa extrem de durabilă și lungimea totală a cablului de 6 m reprezintă o garanție a confortului și fiabilității utilizatorului.

REF.	DESCRIERE				€
15460	CARD DE IDENTIFICARE A FRECVENȚELOR RADIO (CARD RFID)	0.01	-	250	5,00€

53970

3.790,00€

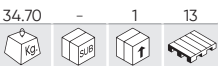

CENTRALĂ DE ALIMENTARE 1920WH/48V 40AH

MPPT	CC-CA	2W(x2) LED	200VAC ±10%	Carga rapidă Fast Charging 54V/10A 3-4H	Carga solar Solar Charging 54V/7.5A 4-5H
50-60 Hz	UNIVERSAL	12V 10A			
3000W	Salida nominal de CA Rated AC output	1920Wh LiFePO4			
5000W	Pico de salida de CA Peak AC output	x2000	Ciclos de carga Battery life cycles		
USB-QC 5V 9V/12V/3A	DC(x2) 12V/10A	Temperatura de descarga Discharging Temperature -10°C/60°C	Temperatura de carga Temperature 0°C/45°C		
USB-Type-C 5V/3A - 9V/2A 12V/1.5A	USB 5V 2.4A*2				



Centrala portabilă prezintă un generator electric puternic, portabil, alimentat cu energie solară. În lipsa razelor solare poate fi încărcat și din orice sursă de energie.

INCLUDE

- ÎNCĂRCĂTOR DE BATERIE
- ÎNCĂRCĂTOR SOLAR PE PANOU SOLAR
- CABLU DE CONECTARE PENTRU ÎNCĂRCĂTOR DE PERETE

COMPATIBIL CU
54321



54321

898,00€

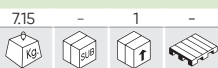

PANOU SOLAR 200 W



200W



REF.	DESCRIERE				€
15448	SET DE 2 CONECTORI MC4 1000V 30A	0.01	-	186	5,50€

53940

13,20€



STAND BARIERĂ PENTRU LANȚ PVC - GALBEN / NEGRU

- Material: PVC.
- Baza gonflabilă.

LANTUL NU ESTE INCLUS.



SEMNALIZARE SPECIALĂ DE ÎNALTĂ TENSIUNE



54326

7,30€

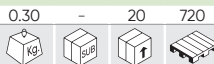

N

LANȚ PVC - GALBEN / NEGRU
7m



53987

9,50€



BANDĂ DE SEMNALIZARE GALBEN/NEGRU - 200M

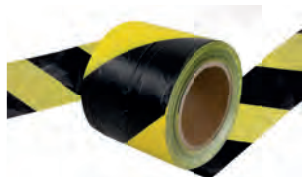

53942

0,50€

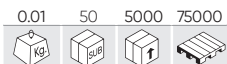

ZA PLASTICĂ DE LANȚ NEGRU



54322

19,00€

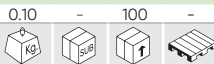

N

SET DE 2 SEMNE DE AVERTIZARE DE ÎNALTĂ TENSIUNE



52382

19,50€

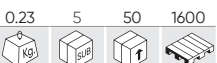

CLEȘTE AMPERMETRIC

DCB	600V
ACB	600V
DCA	-
ACA	20A, 200A, 600A
OHM	2KΩ, 200KΩ, 2MΩ



52952

74,00€

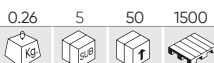

CLEȘTE AMPERMETRIC

DCB	20V, 600V
ACB	600V
DCA	200A
ACA	200A
OHM	2000Ω



50942

28,00€



MULTIMETRU DIGITAL

- Digiți: 3 1/2.
- Măsurare: 2 000.
- Date instant.
- Autoînchidere.
- Indicator de baterie.
- Baterii de 9 V.
- Sondă de temperatură.
- Temperatură de la -40 °C la 1000 °C.



54091

441,00€



KIT DE SCULE CAUCIUCATE CONFORM STANDARDULUI VDE - 26BUC.

26PCS
3/8"
CrV
VDE
GS: Geprüfte Sicherheit
1000V
IEC 60900C



54093

441,00€



MODUL EVA CU UNELTE IZOLATE VDE 26 BUC. (ACETAT DE VINIL ETILEN)

26PCS
3/8"
CrV
VDE
GS: Geprüfte Sicherheit
1000V
IEC 60900C



53154

462,00€



TRUSĂ DE PIESE IZOLATE CU 20 PIESE DE 3/8"

20PCS
3/8"
CrV
VDE
GS: Geprüfte Sicherheit
1000V
IEC 60900C



15162

30,20€



MODUL DE 8 ȘURUBELNIȚE IZOLATE, EVA ÎN FIBRĂ DE CARBON

8PCS
VDE
GS: Geprüfte Sicherheit
1000V
IEC 60900C



52519

25,50€



SET DE 7 ȘURUBELNIȚE IZOLATE 1.000V

7PCS
CrV
VDE
GS: Geprüfte Sicherheit
1000V
IEC 60900:2004

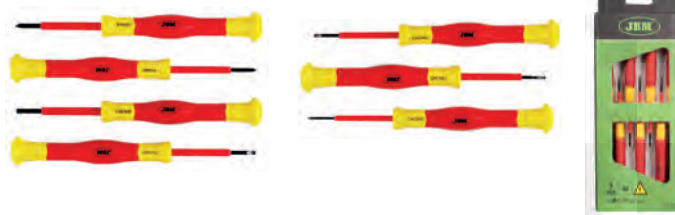

MĂNUȘI IZOLANTE PENTRU LUCRĂRI DE TENSIUNE

REF.	DESCRIERE					€
54130	T.9	0.35	-	1	100	58,00€
54131	T.10	0.40	-	1	100	58,00€

AZC
LATEX
CAT III
CLASS 0
1000V AC / 1500V DC
IEC ELECTRICAL SAFETY
GLOVES 60903-2014 CLASS 0



CUȚIT IZOLAT

REF.	DESCRIERE					€
53164	DREPT	0.10	6	36	1152	16,50€
53165	CURBAT	0.10	6	36	1152	19,60€

CrV
VDE
GS: Geprüfte Sicherheit
1000V
IEC 60900C



CĂRUCIOR PENTRU SCULE CU 7 SERTARE

54236 1.856,00€

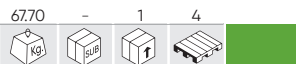

54233 1.856,00€



54234 1.856,00€



54235 1.856,00€

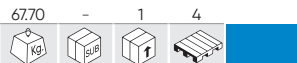

INCLUDE

REF.	UNI.	€	REF.	UNI.	€	REF.	UNI.	€			
A	52162	1	38,00€	E	54093	1	441,00€	I	54132	1	190,00€
B	53940	4	13,20€	F	54114	1	248,00€	J	54241	1	120,00€
C	54326	1	7,30€	G	54129	1	110,00€				
D	53942	8	0,50€	H	54130	1	58,00€				



54386

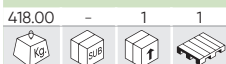

LIFT DE ASAMBLARE A BATERIILOR PENTRU VEHICULE ELECTRICE

Caracteristici de încărcare	Sarcina distribuită
Timp de ridicare (fara sarcina)	60"
Timp de coborâre (fără sarcină)	45"
Platformă	1290 - 1400x768mm



5.839,00€

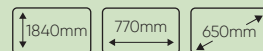

N

1,2T

MAX: 1840mm
MIN: 650mm



PIESE DISPONIBILE

54241

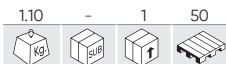

120,00€



STÂLP DE SALVARE IZOLAT - 45KV



54129



110,00€



COVORAȘ IZOLANT CLASA 0

- CLASS 0
- ENROLLABLE ROLLS
- SLIP RESISTANT
- OIL RESISTANT
- RECYCLABLE
- 1000V AC / 1500V DC
- IEC ELECTRICAL SAFETY
- MATting 60903-2024 CLASS 0

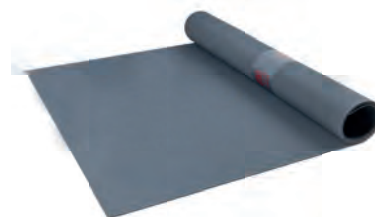

54132

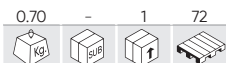

190,00€

ECRAŢ DE PROTECŢIE IZOLATOR PENTRU LUCRĂRI DE TENSIUNE

- ANTI-RALLADURAS / SCRACHING PROOF
- ANTI-VAHO / ANTI FOG
- EN 170:2022
- EN 166:2001
- ANSI Z87.1
- CLASS 1



54114

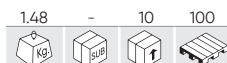

248,00€

TESTER REZISTENTA IZOLATIE

- 2000MΩ
- 1000V
- 750V
- CAT III



ACCESORII PENTRU ATELIER

348 ROLE DE FURTUNURI

349 SCĂRI

350 CĂRUCIOARE ȘI PLATFORME



TAMBUR CU FURTUN RETRACTABIL

REF.	m					€
53582	22m 10.85	-	1	14		174,00€
53583	22m 10.75	-	1	14		174,00€
53532	13m 6.60	-	2	30		119,00€
53581	13m 6.70	-	2	30		119,00€
53881	11m 4.50	-	4	48		79,00€
53882	11m 4.50	-	4	48		79,00€

300 PSI
20 BAR

3/8"

Ø 9.5mm



CU REPARTIȚIE

ROLĂ AUTOMATĂ CU FURTUN PENTRU APĂ

REF.	m					€
53872	16,5m 7.50	-	1	21		118,00€

15m + 1,5m

120 PSI
8 BAR

3/4"

Ø 15.8mm
Ø 11.5mm

PVC



PIESE
DISPONIBILE



TAMBUR CABLU ELECTRIC

REF.	m					€
53586	21m 8.35	-	2	30		168,00€
53585	21m 8.35	-	2	36		168,00€
53584	12m 5.10	-	4	48		119,00€
53526	12m 5.15	-	4	48		119,00€

230V

1000W
3000W

IP44

H07RN-F
3G1.5mm²



CU REPARTIȚIE



ROLĂ AUTOMATĂ CU FURTUN PENTRU ULEI, DE 1/2" 15M

REF.	m					€
50797	16m	26.60	-	1	14	490,00€

- Pe bază de ulei/bobină
- Lungime furtun: 15 + 1 m
- Max. presiune de lucru: 2.450 psi
- Intrare aer: 1/2" BSPT (Filet pentru conducte conice britanice)
- Ieșire aer: 1/2" (filet conic pentru conducte britanice)
- Material: oțel



160 BAR



SCARĂ TELESCOPICĂ

REF.	DESCRIERE					€
51982	SCARĂ TELESCOPICĂ CU 6 SCĂRI - 2M	5.51	-	1	34	120,00€
51983	SCARĂ TELESCOPICĂ CU 10 SCĂRI - 3,2M	9.41	-	1	34	185,00€
51984	SCARĂ TELESCOPICĂ CU 12 SCĂRI - 3,8M	9.78	-	1	22	190,00€

ÎNDEPLINEȘTE CU: EN 131

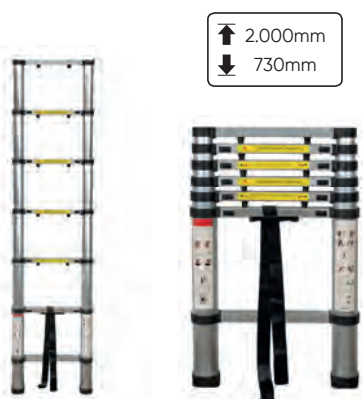

↑ 2.000mm
↓ 730mm

51982

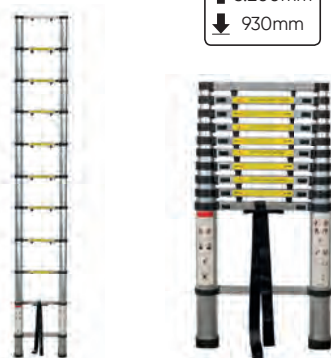

↑ 3.200mm
↓ 930mm

51983



↑ 3.800mm
↓ 1.020mm

51984

52149

14.00	-	1	14
-------	---	---	----



SCARĂ TELESCOPICĂ ÎN "V" PLIANTĂ

- Scară pliantă și ușoară.
- Sistem de pliere prin blocare.
- Fabricată din aluminiu și plastic.
- Înălțime scară strânsă: 835mm.
- Înălțime scară deschisă: 3800mm.



230,00€

ÎNDEPLINEȘTE CU: EN 131

54176

188,00€

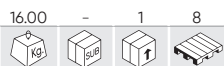

SCARĂ MOBILĂ MULTI-SCOPURI

- Lungime max.: 3.7m
- Capacitate: 150kg
- Material: Aluminiu
- Grosime Aluminiu: 1,2mm
- Spațiul dintre două bare(trepte): 28cm



ÎNDEPLINEȘTE CU: EN 131

INCLUDE

REF. DESCRIERE

15866 SET DE 2 PLATFORME PENTRU REF. 54176

5.00	-	1	-	32,00€
------	---	---	---	--------

50517

129,00€

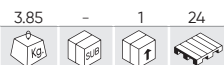

SCARĂ DIN ALUMINIU CU 4 TREPTE

- CU 4 TREPTE
- Înălțime totală: 1,47m.
 - Înălțime max. de lucru: 0,87m.



50518

169,00€



SCARĂ DIN ALUMINIU CU 6 TREPTE

- CU 6 TREPTE
- Înălțime totală: 1,91 m.
 - Înălțime max. de lucru: 1,31m.



52230

398,00€



PLATFORMĂ DIN ALUMINIU TELESCOPICĂ



ÎNDEPLINEȘTE CU: EN 131

MIN



MAX



REF. DESCRIERE

10964 PROTECTOR COLȚ PENTRU PLATFORMA CU REF. 52230

10965 TAMPON TREAPTĂ PENTRU PLATFORMĂ CU REF. 52230

10966 PICIOR DE SCHIMB PENTRU PLATFORMA CU REF. 52230

0.01	-	1	-	9,00€
0.01	-	1	-	6,00€
0.06	-	1	-	13,50€

50656

290,00€

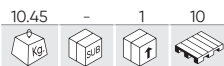

ÎNDEPLINEȘTE CU: EN 131

SET DE 2 PLATFORME DIN ALUMINIU



REF.	cm					€
11897	100x30x30cm	4.66	-	1	16	155,00€
15552	130x30x55cm	6.80	-	1	18	181,00€

50913

195,00€

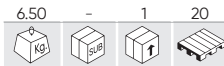

ÎNDEPLINEȘTE CU: EN 131

PLATFORMĂ MARE DIN ALUMINIU



52202

88,00€

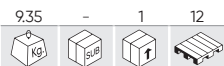

CĂRUCIOR MARFĂ DIN OȚEL, BAZIC CAP. 200KG



REF.	DESCRIERE					€
12055	ROATĂ	1.11	10	160	20,00€	

50924

342,00€



CĂRUCIOR PENTRU TRANSPORTAT BIDOANE SP. GRESARE



52200

88,00€

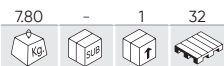

CĂRUCIOR CU PLATAFORMA DE OTEL CAP. 130KG

DESCHIS STRĂNS



54305

232,50€



N

CĂRUCIOR PLIABIL PLATFORMĂ DE ALUMINIU 300KG

DESCHIS STRĂNS



54308

89,00€



N

CĂRUCIOR PLIABIL DIN ALUMINIU 90KG



DESCHIS



STRĂNS

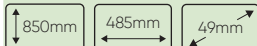

54310

57,00€



N

CĂRUCIOR PLIABIL DIN ALUMINIU 75KG

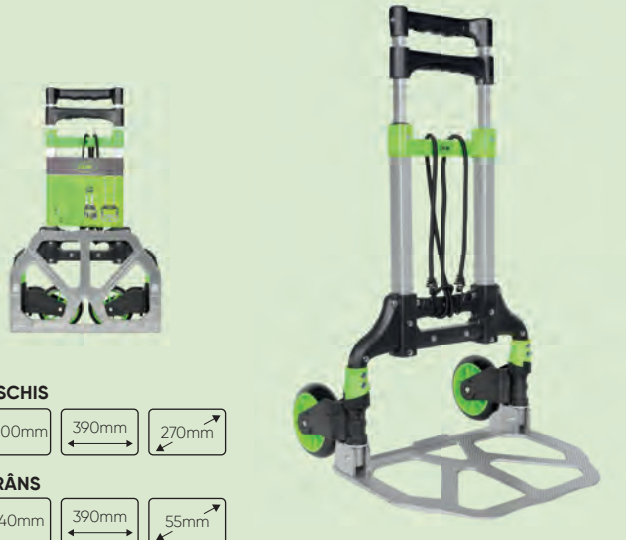

DESCHIS



STRĂNS

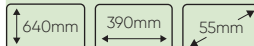

54306

219,50€



N

CĂRUCIOR PLIABIL DIN ALUMINIU 250KG



DESCHIS

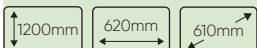

STRĂNS

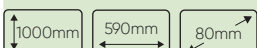

54309

71,00€



N

CĂRUCIOR PLIABIL PENTRU CĂȚĂRĂRI SCĂRI

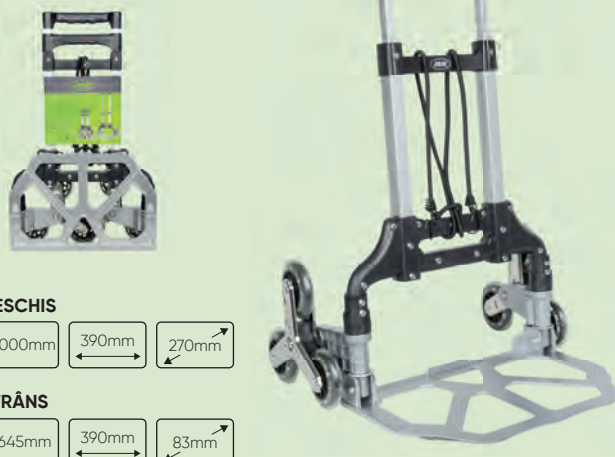

DESCHIS



STRĂNS

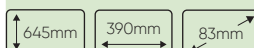

ACCESORII PENTRU AUTOVEHICULE

- 354 SEMNALIZARE
- 355 TRUSE DE URGENȚĂ
- 357 BECURI
- 358 TRUSE DE PRIM AJUTOR
- 359 SIGURANȚĂ
- 359 SETURI DE BURDUFURI ȘI CLEME PENTRU ARTICULAȚII
- 361 COVORAȘE
- 362 ȘTERGĂTOARE
- 363 BICICLETĂ
- 364 ALTELE
- 366 SENZORI DE PARCARE
- 366 TUBURI FLEXIBILE

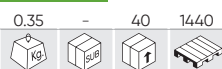

ACCESORII PENTRU AUTOVEHICULE

53778
4,50€

**TRIUNGHI DE SEMNALIZARE
OMOLOGAT 27R032736**



ÎNDEPLINEȘTE CU: E4 27R-032736

52795
5,80€

**TRIUNGHI DE SEMNALIZARE
OMOLOGAT 27R032738**

ÎNDEPLINEȘTE CU: E4 27R-032738

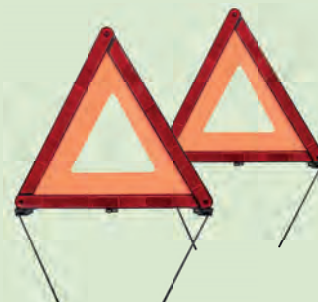
54298
7,50€

**2 TRIUNGHI DE SEMNALIZARE
OMOLOGAT 27R032736**

ÎNDEPLINEȘTE CU: E4 27R-032736

N

VESTĂ REFLECTORIZANTĂ OMOLOGATĂ

ÎNDEPLINEȘTE CU: EN ISO20471:2013

+A1:2016

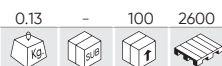
51817
4,50€

BANDA DE MARCARE

50654
4,00€

50966
4,00€

50966C
3,00€

N

DISTINCTIV PENTRU VEhicULE DE TRANSPORTAT MARFĂ

REF.					€
51935		1.04	10	280	135,00€
51936		1.04	10	140	135,00€
51937		1.02	10	280	135,00€

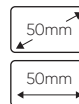
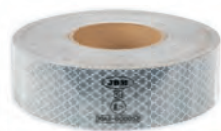

Aprobare: Regulamentul CEPE/ONU 104R

 - Se aplică începând de la 10 iulie 2011 ca urmare a modificării Regulamentului General de Vehicule aprobat prin Real Decretul 2822/1998, din 23 dec. 2010.
 - Bobine indivisibile de 50m.

PLACĂ DE AVERTIZARE V-20 „ÎNCĂRCĂTURI DE MARI DIMENSIUNI”

REF.					€
53636	FABRICAT DIN POLIPROPILENĂ PENTRU O MAI MARE FLEXIBILITATE	0.87	25	700	22,00€
53507	PARTEA FAȚĂ DIN POLIMMETIL METRACRILAT (PMMA) ȘI SPATE DIN ALUMINIU	0.75	25	800	27,00€



KIT DE SECURITATE ȘI DE URGENȚĂ

TRUSA PENTRU KIT DE URGENȚĂ, ALBASTRĂ

REF.						€
51692	550x90x130mm	0.11	-	100	1600	3,55€
51693	550x90x130mm	0.12	-	100	1200	3,55€
51694	550x90x130mm	0.14	-	100	1200	3,55€
51696	550x90x130mm	0.12	-	80	1200	3,55€



PUNGĂ NEAGRĂ CU RIVET SPECIALĂ

REF.						€
11328	557x110x70mm	0.12	-	100	1200	4,00€



53721 18,80€

0.16	20	80	1440

LUMINĂ GIRATORIE DE ALARMĂ CU DIODĂ ELECTROLUMINISCENTĂ

x24 LED 12W 24H	x9 LED 1.8W 5H
-----------------------	----------------------

V16		360°
-----	--	------



ÎN INTERPRET
20 UNITĂȚI



KIT DE URGENȚĂ PUNGĂ PVC

REF.							€
53185	x1	0.69	-	10	200		13,20€
53186	x2	1.04	-	10	200		13,20€

* Reflector triunghiular dublu, obligatoriu numai în Spania.

Fără TVA

CONSULTAȚI VALORILE DE PREȚ
SERIGRAFIE ȘI FOTOLITHOGRAPH NU ESTE INCLUS

PUNGĂ MINI KIT DE URGENȚĂ

REF.						€
53621	550x150mm	0.05	-	100	3200	2,50€
53622	550x150mm	0.05	-	100	3200	2,50€
53623	550x150mm	0.05	-	100	3200	2,50€
53624	550x150mm	0.05	-	100	3200	2,50€



PUNGĂ NYLON

REF.						€
15619	330x100x80mm	0.09	-	100	1500	4,00€



N

KIT DE URGENȚĂ

REF.						€
54534	330x100x80mm	0.37	-	10	200	24,00€



PUNEȚI LOGO-UL

N



PUNEȚI LOGO-UL



KIT DE URGENȚĂ

REF.	△	☐	☐	☐	☐	☐	€	
52768	■	x2	MK H1	1.81	-	10	200	13,80€
52772	■	x2	MK H1	1.88	-	10	200	13,90€
52776	■	x2	MK H1	1.81	-	10	200	13,80€
52780	■	x2	MK H1	1.94	-	10	200	13,90€
52769	■	x2	MK H4	1.01	-	10	200	14,50€
52773	■	x2	MK H4	1.01	-	10	200	14,60€
52777	■	x2	MK H4	1.07	-	10	200	15,50€
52781	■	x2	MK H4	1.14	-	10	200	14,60€
52770	■	x2	MK H7	2.55	-	10	200	23,00€
52774	■	x2	MK H7	0.99	-	10	200	14,80€
52778	■	x2	MK H7	0.99	-	10	200	14,60€
52782	■	x2	MK H7	1.11	-	10	200	14,80€
52771	■	x2	MK H7+H1	2.75	-	10	200	23,40€
52775	■	x2	MK H7+H1	1.01	-	10	200	15,20€
52779	■	x2	MK H7+H1	1.13	-	10	200	17,10€
52783	■	x2	MK H7+H1	1.01	-	10	200	15,20€



H1 (12V)
H4 (12V)
H7 (12V)

* Reflector triunghiular dublu, obligatoriu numai în Spania.

KIT DE URGENȚĂ PUNGĂ CU RIVET

REF.	△	☐	☐	☐	☐	☐	€
53177	■	x1	0.63	-	10	200	11,90€
53178	■	x1	0.64	-	10	200	12,20€
53179	■	x1	0.65	-	10	200	12,20€
53180	■	x1	0.63	-	10	200	12,20€
53181	■	x2	0.98	-	10	200	11,90€
53182	■	x2	0.99	-	10	200	12,20€
53183	■	x2	0.99	-	10	200	12,70€
53184	■	x2	0.98	-	10	200	12,20€



PUNEȚI LOGO-UL

* Reflector triunghiular dublu, obligatoriu numai în Spania.

KIT DE URGENȚĂ PUNGĂ CU RIVET

REF.	△	☐	☐	☐	☐	☐	€
53087	■	x1	0.58	-	10	200	11,20€
53088	■	x1	0.59	-	10	200	11,50€
53089	■	x1	0.61	-	10	200	11,50€
53090	■	x1	0.59	-	10	200	11,50€



PUNEȚI LOGO-UL

KIT DE URGENȚĂ PUNGĂ

REF.	△	☐	☐	☐	☐	☐	€
53091	■	x1	0.52	-	10	200	10,20€
53092	■	x1	0.52	-	10	200	10,20€
53093	■	x1	0.52	-	10	200	10,20€
53094	■	x1	0.52	-	10	200	10,20€



PUNEȚI LOGO-UL

MINI SET CU BECURI AUTO

REF.							€
51613	12V H1 0.90 10 100 1500						2,90€
51615	12V H9 0.09 10 100 1500						5,95€
51612	12V H11 0.09 10 100 1500						5,95€
50523	12V HB3 0.09 10 100 1500						4,70€
50524	12V HB4 0.09 10 100 1500						4,70€
50915	12V H7+H1 0.10 10 100 1800						4,20€
51614	12V H4 0.10 10 100 1800						3,60€
50431	12V H7 0.08 10 100 1800						3,80€
52047	24V H4 0.09 10 100 1500						3,30€
52048	24V H7 0.10 10 100 1500						3,95€



50551



350,00€



DULAP EXPOZITOR CU BECURI PENTRU AUTOTURISME

STOP DE 1 POL
P21W 21 W BA15S 30U.
P21WA 21 W BA15S AMBAR / 10U.
PY21W 21 W BAU15S
CON DESC. / 10U.

STOP DE 2 POLOS
R21/5 W 21/5 W BAY15D 40U.
PLAFONIER
C5W 5 W SV8.5 11X38 22U.

STOP DE 2 POLI
R5W 5 W BA15S 30U.
R10W 10 W BA15S 30U.

LĂMPI INDICATOARE
T4W 4 W BA9S 22U.

LĂMPI CU HALOGEN
H1 55 W P14,5S 10U.
H2 55 W X511 4U.
H3 55 W PK22S 4U.
H4 60/55 W P43T 10U.
H7 55 W PX26D 10U.
HB3 65 W P20D 4U.
HB4 55 W P20D 4U.
H9 65 W PGJ19-5 4U.
H11 65 W PGJ19-2 4U.

FOCAR EUROPEU
T5 1,2 W W2,1X4,6D 20U.
T10 5 W W2,1X9,6D 12U.
T10 3 W W2,1X9,6D 12U.
T13 10 W W2,1X9,6D 10U.
T15 18 W W2,1X9,6D 10U.
T20 21 W W5X16D 10U.
T20A 21 W W5X16D AMBAR 10U.
T20 21/5 W W5X16D 10U.



BEC OBN

REF.	DESCRIERE						€
52365	BEC AUTO OBN H7 55W	0.02	10	200	9000		2,46€
52364	BEC AUTO OBN H1 55W	0.02	10	200	4400		2,86€
52362	BEC AUTO OBN H1 55W	0.01	10	200	14400		1,23€
10766	BEC DE SCHIMB PENTRU REF.51960, 51962	0.01	-	200	-		1,59€
52363	BEC AUTO OBN H3 12V 55W	0.02	10	200	14400		1,23€
53203	LAMPĂ OBN AMBRA 12V 21W BA15S	0.01	10	200	-		0,46€
52369	BEC AUTO OBN 2 POLI 12V 21/5W FĂRĂ SOCLU T20	0.01	10	1000	18000		1,19€
52368	BEC AUTO OBN 12V 21W FĂRĂ SOCLU T20A	0.01	10	1000	18000		1,14€
53007	BEC OBN R5W 12W 5V	0.05	10	200	1500		0,42€
52862	LAMPĂ WEDGE 21W 12V	0.01	10	1000	1500		1,15€
52370	BEC AUTO OBN 12V 21W FĂRĂ SOCLU T20 (AMBER)	0.01	10	1000	18000		1,17€
52864	LAMPĂ WEDGE 12V 21/5W T20	0.01	10	500	1500		1,20€
52865	OBN LAMPĂ WEDGE 10W 12V T13	0.01	10	2000	-		0,50€
52866	LAMPĂ WEDGE 18W 12V T15	0.01	10	2000	256000		0,25€



54042

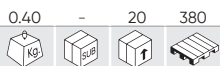

13,00€

44
PCS

KIT DE PRIM AJUTOR DIN13164:2022

- x1 Bandă adezivă pe bobină din 13019-a 5 x 2,5
- x4 Benzi adezive DIN 13019-E 10x6
- x2 Benzi elastice pentru degete 4cmx7cm
- x2 Benzi elastice pentru degete 12cmx2cm
- x2 Benzi elastice rezistente la apă 1,9x7,2cm
- x4 Benzi elastice rezistente la apă de 2,5x7,2cm
- x1 Pansament steril DIN 13151-K 6x8 cm
- x2 Pansament sterile DIN 13151-M 8x10 cm
- x1 Bandaj steril DIN 13151-G 10x12 cm
- x1 Bandaj de prim ajutor DIN 13152-BR 60x40 cm
- x1 Bandaj de prim ajutor DIN 13152-A 60x80 cm
- x2 Pansamente sterile DIN 61634FB6 6 cm x 400 cm
- x3 Pansamente sterile DIN 61634FB6 8 cm x 400 cm
- x1 Pătură de salvare 160x210 cm



- x6 Comprese sterile pentru răni de 10x10 cm
- x2 Bandaje triunghiulare DIN 13168-D
- x1 Foarfeca DIN 58279-A145 145 cm
- x4 Mănuși de unică folosință DIN EN 455-1
- x2 Șervețele umede pentru curățarea pielii
- x1 Listă de conținut
- x1 Ghid de prim ajutor

51246



6,40€

11
PCS

TRUSĂ DE PRIM AJUTOR

- x1 Manual de prim ajutor
- x1 Foarfeca
- x1 Pereche de mănuși
- x2 Șervețele cu alcool
- x2 Plasturi adezive
- x1 25gr. Din bumbac
- x1 Plic cu 5 comprese
- x1 Fașă
- x1 Rolă leucoplast



54072

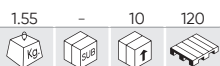

38,50€

67
PCS

KIT DE PRIM AJUTOR DIN13157

- x1 Leucoplast 5 x 25 - DIN13019-A
- x1 Set de pansamente pe bază adezivă 10x6 cm (8 buc.)- DIN13019-E
- x6 Leucoplaste pentru degete 4 x 6,5 cm
- x6 Leucoplaste pentru degete 120 x 20 mm
- x6 Leucoplaste pentru degete 7,2 x 1,9 cm
- x12 Leucoplaste pentru degete 25 x 72 mm
- x1 Set de pansamente de prim ajutor, 6 x 8 cm - DIN13151-K
- x3 Seturi de pansamente de prim ajutor, 8 x 10 cm - DIN13151-M
- x1 Set de pansamente de prim ajutor, compresă sterilă 10 x 12 cm - DIN13151-G
- x1 Compresă sterilă 60 x 80 cm - DIN13152-A
- x3 Pansamente sterile (comprese) 100 x 100 mm, 2 buc / pachet - DIN58953-2
- x2 Bandaje pentru ochi - 55mmx75mm 1,5g
- x1 Compresă rece pentru tratament de urgență, min. 200 Cm2
- x1 Pătură de prim ajutor 160cmx210cm 12 microni
- x2 Bandaje elastice (tifen), 6 cm pe 400 cm - DIN61634 FB6
- x2 Bandaje elastice (tifen), 8 cm pe 400 cm - DIN61634 FB8
- x2 Bandaje triunghiulare 96x96x136 cm - DIN13168-D
- x1 Foarfeca metalice 190 mm - DIN58279-B190
- x2 Pungi de gunoi din plastic, 300 x 400 mm, 45 microni
- x5 Țesături nețesute 20 x 30 cm, min. 15 G/m2
- x1 Mănuși de unică folosință din pvc I-aq1.5 (Set de 4 bucăți) - DIN EN455-1



- x1 Broșură informativă
- x2 Măști chirurgicale DIN EN 14683
- x4 Șervețele pentru curățarea pielii sănătoase

50644 11,60€

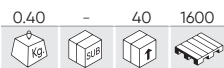

CENTURĂ DE SIGURANȚĂ DE 2 PUNCTE PENTRU AUTOCARE



ÎNDEPLINEȘTE CU: E4-16R-0436213

50717 21,90€

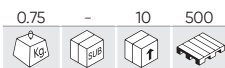

CENTURĂ DE 2 PUNCTE CARE SE STRÂNGE PENTRU AUTOCARE



ÎNDEPLINEȘTE CU: E4-16R-0436232

51266 28,00€

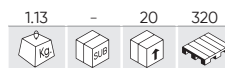

CENTURĂ DE SIGURANȚĂ CARE SE STRÂNGE DE 3 PUNCTE PENTRU AUTOCARE



ÎNDEPLINEȘTE CU: E4-16R-0436232

52259 3,75€

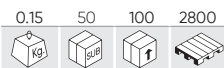

CIOCAN PENTRU SPARGEREA ȘTICLELOR CU SUPORT ȘI CUȚIT PENTU TĂIEREA CENTURILOR DE SIGURANȚĂ

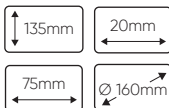

51861 199,00€

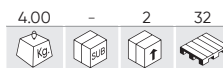

DISPOZITIV PNEUMATIC FIXARE BURDUF PLANETARĂ



- Material: Aluminiu.
- Deschidere de 20 la 100mm.



CLEME

REF.	DESCRIERE					€
11890	CLEMĂ DE 50-125MM	0.01	100	1000	18000	0,55€
11891	CLEMĂ DE 15-45MM	0.01	100	5000	90000	0,50€
52633	KIT DE 2 CLEME	0.02	100	800	14400	1,00€



KIT BURDUF PLANETARĂ UNIV. NEOPREN

REF.	DESCRIERE				€
51703	KIT BURDUF PLANETARĂ UNIV. - PT. FURGONETE	0.28	20	320	10,50€
51705	KIT BURDUF PLANETARĂ UNIV. NEOPREN - P/TURISME	0.23	20	400	8,45€



52644

8,80€



KIT BURDUF DE DIRECȚIE UNIVERSAL



53693

521,00€

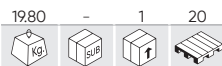

CUTIE 100 BURDUF PLANETARĂ



x100 52633

x100 13738

x100 13879

53698

717,00€



KIT UNIVERSAL DE 100 DE BUCĂȚI DE MANȘON EXTENSIBIL PENTRU FURGONETĂ



x100 52633

x100 13739

x100 13880

53695

504,00€

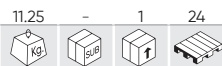

KIT UNIVERSAL DE 80 DE BUCĂȚI DE MANȘON DE DIRECȚIE



x80 52633

x80 13740

x80 13880

SERIE124

710,00€



SERIES SPECIALE PROMOȚIONALE BURDUF



x1 51861

x100 52633

x100 13738

x100 13879

PIESE DE SCHIMB

REF.	DESCRIERE					€
13738	BURDUF DE TRANSMISIE AUTOTURISM UNIVERSAL	0.08	-	150	1800	3,50€
13739	BURDUF DE TRANSMISIE FURGONETĂ UNIVERSAL	0.15	-	100	1600	5,50€
13740	BURDUF CASETĂ DE DIRECȚIE UNIVERSAL	0.10	-	72	-	5,50€
13879	LUBRIFIANT PENTRU CAP DE PLANETARĂ	0.09	-	150	5250	1,38€
13880	PUNGA CU GRASIME PT BURDUF DIRECTIE	0.01	-	600	21000	1,50€

50585

14,70€



COVORAȘ AUTO DIN CAUCIUC UNIVERSAL

- Cauciuc de calitate superioară.
- Foarte rezistent.
- Adaptabil la majoritatea vehiculelor.

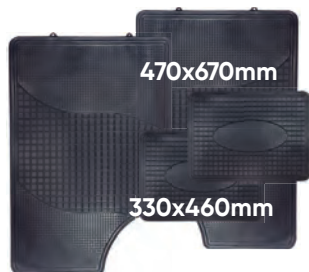

REVERSIBIL!



53241

9,00€



COVORAȘ AUTO DIN CAUCIUC UNIVERSAL

- Cauciuc de calitate superioară.
- Foarte rezistent.
- Adaptabil la majoritatea vehiculelor.



52534

15,00€



JOC COVORAȘE AUTO DIN MOCHETĂ CU BORDURĂ DIN PLASTIC

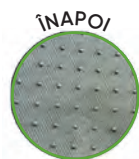

- 2 covorașe față (425x660mm).
- 2 covorașe spate (295x425mm).
- Ușoare, confortabile, cu bordură din plastic revers cu tampoane din cauciuc antialunecare.



52535

16,50€



JOC COVORAȘE AUTO DIN MOCHETĂ CU BORDURĂ DIN MOCHETĂ

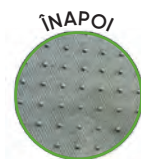

- 2 covorașe față (425x660mm).
- 2 covorașe spate (295x425mm).
- Ușoare, confortabile, cu bordură din plastic revers cu tampoane din cauciuc antialunecare.



52530

14,00€



JOC COVORAȘE AUTO DIN MOCHETĂ

- 2 covorașe față (390mm).
- 2 covorașe spate (365x480mm).
- Ușoare, confortabile, cu bordură.
- Din plastic revers cu tampoane din cauciuc antialunecare.

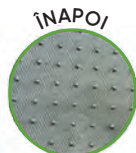

METEXP

62,00€



EXPOZITOR PENTRU COVORAȘE AUTO



LAMĂ UNIVERSALĂ A ȘTERGĂTORULUI DE PARBRIZ



99%

Instalarea ușoară a adaptorului în mai mult de 99% din vehicule.

38dB

Ergonomia și eliminarea pieselor cu greutate reduce zgomotul cu 38db.

30%

Presiunea uniformă a lungimii periei, datorită arcului de oel pentru o vizibilitate mai mare decât periele originale și o performanță superioară de 30%.

100%

100% cauciuc natural rezistent la toate condițiile meteorologice extreme.

160km/h

Design aerodinamic care permite utilizarea până la 160 km/h.

45°

45° unghi de tăiere și precizie transversală de curățare care elimină cele mai mici picături.

REF.	"	mm					€
53745	11"	280mm	0.20	10	50	800	6,40€
53746	12"	310mm	0.20	10	50	800	6,40€
53747	13"	330mm	0.20	10	50	900	6,40€
53748	14"	350mm	0.20	10	50	800	6,60€
53749	15"	380mm	0.20	10	50	900	6,70€
53750	16"	410mm	0.20	10	50	900	6,70€
53751	17"	430mm	0.20	10	50	900	6,80€
53752	18"	460mm	0.25	10	50	800	6,95€
53753	19"	480mm	0.25	10	50	700	7,10€
53754	20"	510mm	0.25	10	50	900	7,40€
53755	21"	530mm	0.25	10	50	600	7,50€
53756	22"	560mm	0.25	10	50	600	7,90€
53757	24"	610mm	0.25	10	50	600	7,90€
53758	26"	650mm	0.30	10	50	600	8,20€
53759	28"	700mm	0.30	10	50	550	8,50€
53760	30"	750mm	0.30	10	50	500	9,60€

11 ADAPTOARE DIFERITE:
PENTRU MAI MULTE APLICAȚII



JBMWBEXP

24,50€



EXPOZANT ȘTERGĂTOARE DE PARBRIZ



53919

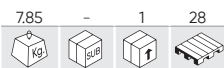

81,00€



STAND PENTRU REPARAȚIE BICICLETE

- Material: oțel Q195, ABS, nailon
- Dimensiuni în stare asamblată: 198x104 cm
- Înălțime reglabilă: 107-188 cm
- Lungimea tubului transversal pivotant: 37cm
- Lungime suport: 69 cm
- Diametrul tubului transversal pivotant: 35mm
- Diametrul tubului telescopic: 35mm
- Diametrul tubului principal: 38mm
- Diametrul tubului suport: 25mm
- Sarcină utilă maximă: 30 kg

DIN MATERIAL ARMAT ABS ȘI DIN NAILON PENTRU ROTIREA BICICLETEI ÎN ORICE UNGHII FĂRĂ A DETERIORA VOPSEAU.

DIMENSIUNILE TĂVII MULTIFUNCȚIONALE PENTRU SCULE 25X13CM

DESIGN ANTIDERAPANT LUNGIMEA 4 PICIOARE



Pentru toate tipurile de biciclete
Bicicletă urbană / rutieră / montană



Tija de fixare reglabilă: 50-90cm

54166

32,40€

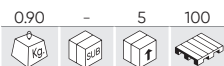

POMPĂ DE PODEA BICICLETĂ



54170

16,50€



POMPĂ MANUALĂ PORTABILĂ PENTRU BICICLETĂ



54073

70,00€

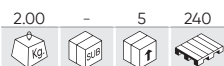

SET DE UNELTE PENTRU BICICLETE - 20 BUC



54074

18,50€



INSTRUMENT MULTIFUNCȚIONAL PENTRU REPARAȚIA BICICLETELOR



54169

13,80€



ANTIFURT BICICLETĂ CU CIFRU



ACCESORII PENTRU AUTOVEHICULE

51858 15,00€

0,96 - 20 288



LOPATĂ PLIANTĂ

- Fabricată din metal rezistent.
- Strânsă: 240mm.
- Deschisă: 580mm.



53033 21,50€

0,63 - 5 50



LOPATĂ EXTENSIBILĂ DIN ALUMINIU

- Fabricată din plastic și aluminiu.
- Strânsă: 85mm.
- Deschisă: 119mm.



52187 21,80€

1,60 - 1 120



LOPATĂ METALICĂ DE 215MM



52251 21,80€

1,74 - 1 120



LOPATĂ METALICĂ DE 215MM - PĂTRATĂ



53964 9,65€

0,70 5 20 240



COARDĂ MULTIUZ 30M 1/4"

ø 1/4"
550Kg



53965 25,80€

1,85 5 10 120



COARDĂ MULTIUZ 30M 1/2"

ø 1/2"
1200Kg



51412 2,10€

0,09 - 100 3000



SUPORT NUMĂR ÎNMATRICULARE

- Dimensiuni: 53,20 cm x 13,70 cm.
- Domeniul de marcare : 52 cm x 1,60 cm.

FOTOLITO ȘI SERIGRAFIA NU SUNT INCLUSE



51697 0,80€

0,03 - 300 6000



RACLETĂ, CURĂȚĂTOR GHEAȚĂ GEAM



50526 4,80€

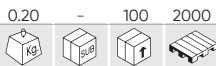

UMBRELĂ PLIANTĂ



50525 1,00€



PELERINĂ IMPERMEABILĂ



51925 1,00€

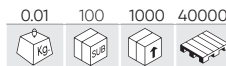

FOARFECĂ MINI DE 9CM



52618 29,00€



SET ORGANIZATOR DE PORTBAGAJ MULTIFUNCȚIONAL

- Cutie din plastic flexibilă 37 litri cu capac (300mm x 490mm).
- Bidon circular cu capac de 180mm de diam. (230mm înălțime).
- Agățător poartă pentru obiecte fără capac (90mm înalt x 260mm lat).
- Tavă rigidă (175mm înaltă x 300mm lată).



53221 4,75€

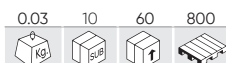

SET LAVETE DIN MICROFIBRĂ 3BUC.



53561 28,00€



STOP ANTI-RETURN



53508 14,00€

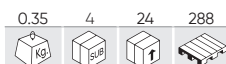

ÎNCĂLȚĂMINTE ANTIALUNICARE



REF.	DESCRIERE	Kg	SUB	f	€
14118	SUPORTUL STOP-ULUI ANTI-RETURN	1.25	4	80	26,00€

51863

54,00€

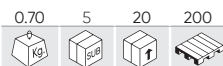

SENZOR DE PARCARE CU DETECTOR VIZUAL ȘI ACUSTIC

- Tensiune nominală: dc 12 v
- Putere: 3,6 w
- Temperatură de lucru: -20° à 70°
- 4 senzori de apropiere.
- Distanță de detecție: 0,3-2,0 m
- Unghi de detecție: h>60°, v>60°.
- Radio frecvență: 315 mhz / 433 mhz.
- Include un indicator cu 2 culori care avizează apropierea de obstacole.
- Senzori de culoare neagră. nu se pot vopsi.



51973

45,00€

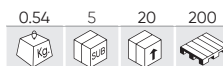

SENZOR DE PARCARE CU DETECTOR ACUSTIC

- Tensiune nominală: dc 12 v
- Putere: 3,6w
- Temperatură de lucru: -20° à 70°
- 4 senzori de apropiere.
- Distanță de detecție: 0,3-2,0 m
- Unghi de detecție: h>60°, v>60°
- Radio frecvență: 315 mhz / 433 mhz.
- Fără indicator vizual.
- Include sonerie de 4cm diametru.
- Senzori de culoare neagră. Nu se pot vopsi.



RACORD FLEXIBIL EȘAPAMENT



REF.	DESCRIERE					€
51706	Ø 25mmL x 300mmL	0.35	-	25	1500	22,80€
51707	Ø 45mmL x 100mmL	0.27	-	25	1200	9,05€
51708	Ø 45mmL x 150mmL	0.38	-	25	-	14,20€
51709	Ø 45mmL x 200mmL	0.50	-	25	-	14,70€
51710	Ø 45mmL x 250mmL	0.65	-	25	600	17,80€
51711	Ø 45mmL x 300mmL	0.71	-	25	-	21,20€
51712	Ø 50mmL x 100mmL	0.30	-	25	-	8,65€
51713	Ø 50mmL x 150mmL	0.45	-	25	-	13,10€
51714	Ø 50mmL x 200mmL	0.56	-	25	-	15,80€
51715	Ø 50mmL x 250mmL	0.70	-	25	-	20,30€
51716	Ø 50mmL x 300mmL	0.83	-	25	450	23,60€

REF.	DESCRIERE					€
51717	Ø 55mmL x 100mmL	0.35	-	25	-	11,20€
51718	Ø 55mmL x 150mmL	0.50	-	25	-	14,80€
51719	Ø 55mmL x 200mmL	0.65	-	25	-	22,00€
51720	Ø 55mmL x 250mmL	0.85	-	25	350	23,50€
51721	Ø 55mmL x 300mmL	1.00	-	25	375	25,00€
51722	Ø 60mmL x 100mmL	0.36	-	25	750	13,10€
51723	Ø 60mmL x 150mmL	0.50	-	25	450	18,70€
51724	Ø 60mmL x 200mmL	0.66	-	25	400	24,40€
51725	Ø 60mmL x 250mmL	0.83	-	25	-	28,30€
51726	Ø 60mmL x 300mmL	0.96	-	25	250	31,40€
51727	Ø 60mmL x 400mmL	1.62	-	25	200	49,00€

DISPONIBILE ÎN CASETA DE UNICĂ

ACCESORII PENTRU ANVELOPE

368 GREUTĂȚI PENTRU ROȚI

369 REPARAȚII PERFORĂRI

370 VALVE PENTRU ANVELOPE

371 DEMONTARE ȘI INSTALARE



ACCESORII PENTRU ANVELOPE

51908

44,00€



SUPORT DE CONTRAGREUTĂȚI - PASTILE DIN FIER 5GRX1.000

- 1.000 pastile de 5g.
- Autoadezive cu 4mm de grosime.
- Dimensiunile suportului: 29,5 cm x 29,5 cm.



Cu magnet pentru reținerea resturilor.

53256

34,00€

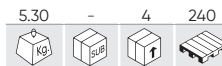

SUPORT DE CONTRAGREUTĂȚI - PASTILE DIN FIER 5G X 1.000

- 1.000 pastile de 5g
- Autoadezive cu 4mm de grosime.
- Dimensiunile suportului: 29,5 cm x 29,5 cm.



CONTRAGREUTATE AUTOADEZIVĂ

REF.	g					€
50600	45g: 3x5g/3x10g	0.05	100	400	36000	0,60€
50601	45g: 3x5g/3x10g	0.05	100	400	48000	0,29€



50600
ZINC



50601
DIN FIER

CONTRAGREUTATE AUTOADEZIVĂ

REF.	g					€
52665	60g: 12x5g	0.06	100	400	20000	0,37€
52666	60g: 4x10g/4x5g	0.06	100	400	20000	0,36€



52665



52666

CONTRAGREUTATE

JANTA UNIV.

REF.	g					€
50760	5g	0.01	100	1600	80000	0,10€
50761	10g	0.01	100	1600	102400	0,19€
50762	15g	0.02	100	800	76800	0,29€
50763	20g	0.02	100	800	64000	0,38€
50764	25g	0.03	100	800	48000	0,49€
50765	30g	0.03	100	600	50400	0,58€
50766	35g	0.04	100	400	32000	0,68€
50767	40g	0.04	100	400	25600	0,78€
50768	45g	0.05	100	400	32000	0,88€
51055	50g	0.05	100	400	2000	0,98€



JANTA ALIAJ

REF.	g					€
50778	5g	0.01	100	1600	80000	0,10€
50779	10g	0.01	100	800	76800	0,19€
50780	15g	0.02	100	1200	60000	0,29€
50781	20g	0.02	100	800	80000	0,38€
50782	25g	0.03	100	600	48000	0,49€
50783	30g	0.03	100	600	30000	0,58€
50784	35g	0.04	100	400	32000	0,68€
50785	40g	0.04	100	400	32000	0,78€
50786	45g	0.05	100	400	32000	0,88€
51604	50g	0.05	100	400	25600	0,98€



CONTRAGREUTATE UNIVERSALĂ PT. CAMION

REF.	g					€
52667	50g	0.05	50	400	25600	0,76€
52668	100g	0.10	25	200	12800	1,49€
52669	150g	0.15	20	160	10240	2,22€
52670	200g	0.20	10	80	5120	2,95€
52671	250g	0.25	10	80	5120	3,70€
52672	300g	0.30	10	80	5120	4,45€



52667



52668



52669



52670



52671



52672

53864

138,00€

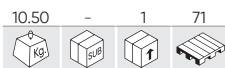

TRUSĂ DE CONTRAGREUTĂȚI ASORTATE

CONTRAGREUTATE DIN ZINC CU CAPSĂ

CONTRAGREUTATE AUTOADEZIVĂ DIN FIER

SPECIAL JANTA UNIVERSAL

SPECIAL JANTA DIN ALIAJ

60gr: 4x10gr 4x5gr - 70u. (ref. 52666)

- 5g - 20 uds (ref. 50760)
- 10g - 20 uds (ref. 50761)
- 15g - 20 uds (ref. 50762)
- 20g - 20 uds (ref. 50763)
- 25g - 20 uds (ref. 50764)
- 30g - 10 uds (ref. 50765)
- 35g - 10 uds (ref. 50766)
- 40g - 10 uds (ref. 50767)

- 5g - 20 uds (ref. 50778)
- 10g - 20 uds (ref. 50779)
- 15g - 20 uds (ref. 50780)
- 20g - 20 uds (ref. 50781)
- 25g - 20 uds (ref. 50782)
- 30g - 10 uds (ref. 50783)
- 35g - 10 uds (ref. 50784)
- 40g - 10 uds (ref. 50785)



51355

19,00€

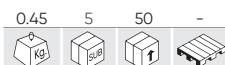

CLEȘTE SPECIAL PENTRU CONTRAGREUTĂ



- Extrage ușor și înlocuiește greutatea.
- Taie și îndoaie cu ușurință.
- Din oțel, rezistent la căldură.
- Include mâner ergonomic.
- Include arc de deschidere pentru a ușura utilizarea acestuia.



53150

24,00€

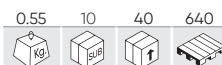

COMPRESOR DE AER



54013

35,00€



SET DE REPARAȚIE GĂURI DE PANĂ - LICHID ȘI COMPRESOR DE AER

REF.	DESCRIERE	Kg	Box	Unit	€
A 15317	GEANTĂ PENTRU SETUL 54013 (53150)	0.10	-	220	4,50€
B 15300	LICHID DE SIGILANȚĂ PUNCTURĂ - 500ML	0.50	-	12	5,00€
C 11960	EXTRACTOR FILET VENTIL	0.01	10	500	1,50€
D 53150	COMPRESOR DE AER	0.55	10	40	24,00€

- Etanșează găuri de pană până la 6 mm în diametru.
- Materialul nu corodează metalul și cauciucul.
- Lichid neinflamabil și rezistent la îngheț, cu o durată lungă de viață.



51814

8,00€



SPRAY REPARĂ ÎNȚEPĂTURI ROȚI 300ML

300ml



52653

3,00€

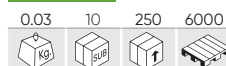

UTIL PENTRU VENTILE

- Pentru montarea și demontarea ventilelor.



52652

2,80€

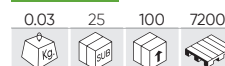

CHEIE PENTRU REPARAT FILET VENTIL



ACCESORII PENTRU ANVELOPE

52662
36,50€

SET DE REPARAȚIE ANVELOPE



- A 1 x burghiu de perforare
- B 1 x burghiu de introducere de fitil
- C 1 x util pentru a umfla anvelope
- D 4 x sticle de aer comprimat 16gr
- E 1 x cuter
- F 10 x fitile
- G 1 x cheie pentru reparat filet ventil

52663
30,00€

SET DE REPARAȚIE ANVELOPE



- A 1 x burghiu de perforare
- B 1 x burghiu de introducere de fitil
- C 1 x capăt burghiu de introducere de fitil
- D 1 x cuter
- E 20 x fitile
- F 1 x lubrifiant

REF.	DESCRIERE					€
12973	FITILE DE SCHIMB PENTRU 52662/52663	0.01	10	500	13500	1,00€
13805	MELC DE INSERȚIE PENTRU FITILE (REF. 52663)	0.50	10	50	-	10,50€
13806	MELC DE PERFORARE (REF. 52663)	0.35	5	50	-	10,50€

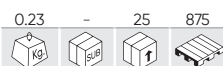
52673
18,00€

SET DE CAPACE ȘI FILTRE PENTRU ANVELOPE



PIESE DISPONIBILE

REF.	DESCRIERE				€
11903	PUNGĂ CU 16U. CAPACE DIN ALUMINIU PT. VENTIL	0.01	1	100	5,00€
11904	PUNGĂ CU 50U. CAPACE VERZI DIN PLASTIC PT. VENTIL	0.10	10	500	2,00€
11905	PUNGĂ CU 50U. CAPACE NEGRE DIN PLASTIC PT. VENTIL	0.01	-	10	1,50€
11906	PUNGĂ CU 50U. FILTRE STANDARD PT. VENTIL	0.04	-	100	8,50€
11907	PUNGĂ CU 50U. FILTRE MARE PRESIUNE PT. VENTIL	0.05	-	100	11,00€
11960	EXTRACTOR FILET VENTIL	0.01	10	500	1,50€

DE ASEMENEA DISPONIBILE

REF.	DESCRIERE				€
11900	CAPAC DIN ALUMINIU PT. VALVULA PNEUMATICĂ	0.01	4	25 250	3,50€
11901	CAPAC DIN PLASTIC VERDE PT. VALVULA PNEUM.	0.01	4	25 500	2,50€
11902	SET DE 4 CAPACE DIN PLASTIC NEGRU PT. VALVULA PNEUM.	0.01	4	25 300	3,50€

VALVE PENTRU ANVELOPE

REF.	DESCRIERE					€
51741	TR413 45mm	0.01	100	1000	48000	0,50€
51742	TR414 51mm	0.01	100	1000	48000	0,50€
51743	TR418 64mm	0.02	100	1000	48000	0,55€



UTIL DIN METAL PENTRU VALVULE PNEUMATICE

REF.	DESCRIERE					€
52649	METAL	0.32	10	50	2250	5,00€
52650	PLASTIC	0.15	10	100	2400	5,00€



52657 37,50€

0.18 5 20 800

SCULĂ PT. SCHIMBAT ANVELOPE



52658 39,70€

0.17 - 20 800

SCULĂ PT. SCHIMBAT ANVELOPE



52659 39,70€

0.26 - 20 1920

SCULĂ PT. SCHIMBAT ANVELOPE



54329 37,50€

0.20 10 100 -

SCULĂ PT. SCHIMBAT ANVELOPE

N

EUR - MADE IN SPAIN

52655 39,70€

0.39 - 25 1500

PÂRGHIE PT. SCOATEREA ANVELOPEI

155-180mm 95mm

52656 39,50€

0.40 5 20 1920

PÂRGHIE MANUALĂ PT. SCOATEREA ANVELOPEI

160mm 170mm 55mm

LEVIER PENTRU VULCANIZARE

REF.	"					€
51362	12" (30,48cm)	0.15	5	60	500	3,00€
51358	16" (40,64cm)	0.47	6	24	1008	7,50€
51359	24" (60,96cm)	0.90	6	30	1440	9,00€



CAP CENTRARE

REF.	mm					€
52645	25x22x2,5mm	0.01	50	1000	38000	0,55€
52646	25x12x2,0mm	0.00	50	1000	80000	0,50€
53037	23x12x2,5mm	0.01	50	1000	35000	0,50€
53038	21x12x2,5mm	0.01	50	1000	35000	0,50€
53039	25x19x2,5mm	0.02	50	1000	35000	0,50€
53040	25x9x2,5mm	0.01	50	1000	35000	0,50€



52664

168,00€

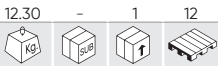

LEVIER PENTRU SCHIMBUL ROȚILOR MARI



53605

141,00€

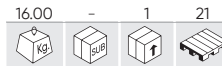

950mm

MAȘINĂ MANUALĂ DE MONTARE A PNEURILOR

- Aplicabilitate: Toate anvelopele de la 8 inci până la pneuri ușoare pentru camioane (7-1/2 inci x 16 inch).
- Permeabilitate: Până la 12,5 L 16.
- Complectitudinea: 1 mâner pentru debortare de dimensiune 37 inci lungime. Instrument de montare / demontare.



52660

126,00€

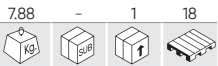

CĂRUȚOR ROȚI PNEUMATICE, CAP. 200KG



52552

128,00€

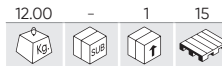

APARAT PT. MONTAT ANVELOPELE PE JANTE

- 87-116 PSI / 6-8 BAR
- MAX 10 BAR / 145 PSI
- 18L
- 20°C / 40°C



REF. DESCRIERE

REF.	DESCRIERE	Kg	Box	Unit	€
13741	DUZĂ REZERVA PENTRU 52552	0.35	-	32	21,00€

53542

980,00€



DISPOZITIV PNEUMATIC DE DEMONTARE A AVELOPELOR



54198

59,00€

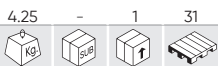

AX CU UNGHIIURI DE FUGĂ PENTRU ROȚI



54136

107,00€

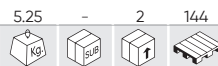

MAȘINĂ MANUALĂ DE MONTARE A PNEURILOR



52842

11,00€

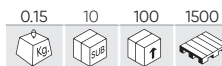

ROLL STRIAT PENTRU REPARAREA PNEURILOR



53419

9,70€

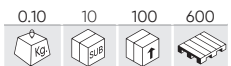

SET DE 3 PROTECTOARE DE JANTE



SIGURANȚĂ ȘI EIP

374 MĂNUȘI/IPE

377 MĂȘTI PT FAȚĂ / DISPENSATORI

379 DELIMITARE

380 OZONOMETRU

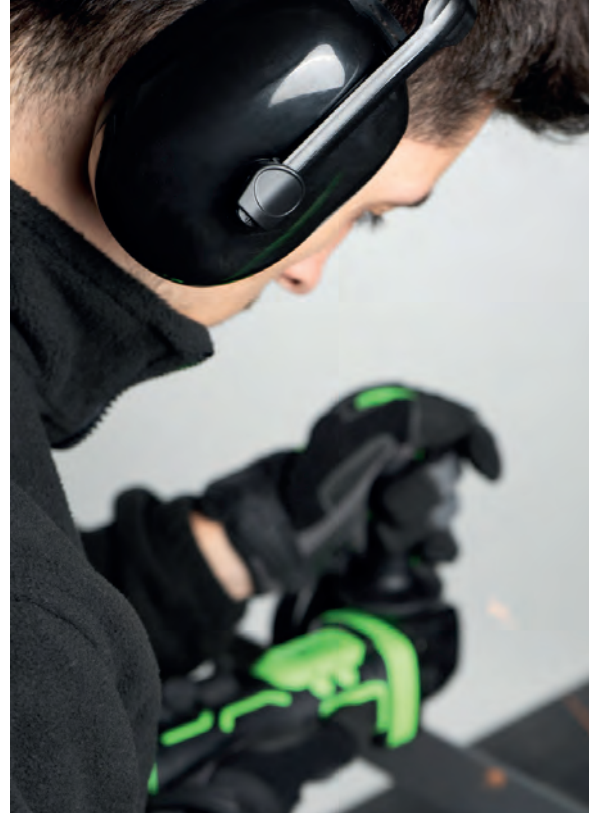



MĂNUȘI DE UNICĂ FOLOSINȚĂ
100% NITRIL

MĂNUȘI DE UNICĂ FOLOSINȚĂ DE NITRIL

3.5MIL
4.2g

REF.	UDS.				€
54294	S 100	0.40	10	500	8,00€
53984	M 100	0.45	10	500	8,00€
53985	L 100	0.50	10	500	8,00€
53986	XL 100	0.55	10	500	8,00€



3.5MIL
4.2g

REF.	UDS.				€
54155	M 100	0.46	10	570	8,00€
54156	L 100	0.50	10	570	8,00€
54157	XL 100	0.55	10	570	8,00€



5MIL
5.5g

REF.	UDS.				€
54151	M 100	0.60	10	500	9,00€
54152	L 100	0.60	10	500	9,00€
54153	XL 100	0.60	10	500	9,00€



MĂNUȘI DE UNICĂ FOLOSINȚĂ DE NITRIL - TEXTURĂ DE DIAMANT

7MIL
8.4g

REF.	UDS.				€
53551	M 100	0.90	10	300	16,00€
53552	L 100	1.00	10	300	16,00€
53553	XL 90	1.00	10	300	16,00€



7MIL
8.4g

REF.	UDS.				€
54177	M 100	0.92	10	300	16,00€
54178	L 100	0.96	10	300	16,00€
54179	XL 90	0.97	10	300	16,00€

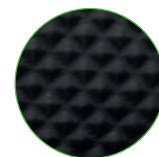

7MIL
8.4g

REF.	UDS.				€
54369	M 100	0.90	10	300	16,00€
54370	L 100	0.88	10	300	16,00€
54371	XL 100	1.05	10	300	16,00€

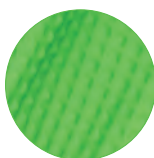

MĂNUȘI DE LUCRU CU PALMA ÎNTĂRITĂ DE POLIURETAN

REF.						€	
51640N	T.8		0.05	12	144	3456	1,54€
51642N	T.9		0.01	12	144	3456	1,54€
51636N	T.10		0.05	12	144	3456	1,54€
51638N	T.11		0.05	12	144	3456	1,54€



MĂNUȘI DE LUCRU CU PALMA ÎNTĂRITĂ DE NITRIL

REF.						€	
51633	T.8		0.04	12	144	3456	1,54€
51634	T.9		0.05	12	144	2592	1,54€
51632N	T.10		0.05	12	144	3456	1,54€
51398N	T.11		0.05	12	144	2592	1,54€



MĂNUȘI TERMICE DE LUCRU

REF.						€	
54192	T.8		0.15	12	144	3456	8,90€
54193	T.9		0.10	12	144	3456	8,90€
54194	T.10		0.15	12	144	3456	8,90€
54195	T.11		0.10	12	144	3456	8,90€



MĂNUȘI DE LUCRU PENTRU ECRANE TACTILE

REF.						€	
52570	T.8		0.03	12	144	3456	2,60€
52571	T.9		0.03	12	144	2592	2,60€
52572	T.10		0.03	12	144	2592	2,60€
52573	T.11		0.04	12	144	2592	2,60€



MĂNUȘI DE PIELE

REF.						€	
52738	T.9		0.10	12	144	2304	5,00€
52739	T.10		0.12	12	144	2304	5,00€



MĂNUȘI DE LUCRU DIN PIELE ȘI PÂNZĂ

REF.						€
52310	0.20	12	120	1920		3,65€



SIGURANȚĂ ȘI EIP

MĂNUȘI DE LUCRU DIN FIR DE BUMBAC

REF.					€
51745	0.05	12	144	4320	0,70€



MĂNUȘI DE LUCRU DIN FIR DE BUMBAC, CU PALMA ÎNTĂRITĂ CU PUNCTE

REF.					€
51785	0.04	12	300	3600	1,00€



MĂNUȘI DE LUCR

REF.					€	
54188	T.8	0.15	12	60	2040	19,00€
54189	T.9	0.15	12	60	720	19,00€
54190	T.10	0.15	12	60	720	19,00€
54191	T.11	0.15	12	60	720	19,00€



PENTRU ECRAN TACTIL



52430

10,90€

0.34	6	24	288

CĂȘTI PENTRU PROTECȚIE AUDITIVĂ



ÎNDEPLINEȘTE CU: EN352 - 1:2003

53785

4,80€

0.05	14	112	896

OCHELARI DE PROTECȚIE CU PROTECȚIA ÎMPOTRIVA ABURII



ÎNDEPLINEȘTE CU: EN166:2002-04

OCHELARI DE PROTECȚIE SPORTIVI, CU PROTECȚIA ÎMPOTRIVA ABURII

REF.					€
53596	0.01	12	144	2016	3,65€
53597	0.01	12	144	2016	3,70€
53598	0.01	12	144	2016	3,95€



ÎN INTERPRET
12 UNITĂȚI



ÎNDEPLINEȘTE CU: EN166:2002-04 / EN166:2003-01



53596



53597



53598

53794

28,00€

0.15	80	1280	

TERMOMETRU INFRARAT PROFESIONAL

- Măsoară temperatura corpului în 1 secundă și fără contact.
- Oprire automată după 1 minut.

TEMPERATURA CORPULUI	32.0°C - 42.2°C (89.6°F - 108°F)
PRECIZIE	±0.2°C (35°C - 42°C)



53862

6,00€

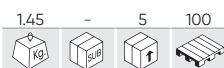

COVOAR PENTRU LICHID DEZINFECTANT

- Măsurile: 85x55x10cm
- Material: TPE
- Capacitate maximă recomandată: 3L
- Capacitate maximă: 8L

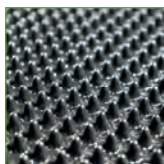

53863

3,00€



COVORAȘ PENTRU USCAT

- Măsurile: 76x48cm
- Material: Poliéster

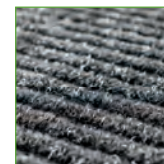

53781

18,00€

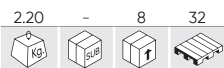

DISPOZITIV AUTOMAT DE ACOPERIRE PENTRU ÎNCĂLȚĂMINTE



REF. DESCRIERE

REF.	DESCRIERE	kg	L	U	€
14781	CAPAC DE ÎNCĂLȚĂMINTE 100PCS	0.25	84	336	990€



53797

0,10€

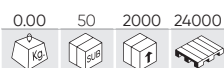

MASCĂ DE PROTECȚIE INDIVIDUALĂ IGIENICĂ (DE O SINGURĂ UTILIZARE)



Prezentare în cutie cu 5 pungi cu câte 10 unități.

UTILIZARE NEMEDICALĂ

EFICACITATEA EFB LA FILTRAREA BACTERIILOR	>98%
REZISTENȚA LA RESPIRAȚIE	35-50 Pa

Acest dispozitiv nu este un produs medical în sensul Directivei 93/42 sau al Regulamentului UE / 2017/745 și nici nu este un echipament de protecție individuală în sensul Regulamentului UE / 2016/425. PENTRU UTILIZARE PERSONALĂ, NU REUTILIZABILĂ.

53957

0,26€

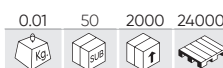

MASCĂ NEAGRA DE PROTECȚIE INDIVIDUALĂ IGIENICĂ (DE O SINGURĂ UTILIZARE)



Prezentare în cutie cu 5 pungi cu câte 10 unități.

UTILIZARE NEMEDICALĂ

EFICACITATEA EFB LA FILTRAREA BACTERIILOR	>90%
REZISTENȚA LA RESPIRAȚIE	63-69 Pa

53946

0,83€

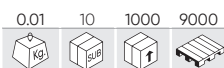

MASCĂ DE PROTECȚIE AUTO-FILTRANTĂ FFP2 - NEGRU



Aprobat conform Regulamentului UE 2016/425
Respectă standardul EN149:2001+A1:2009

53826

16,00€

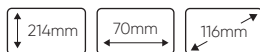
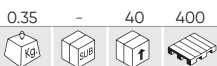

DISTRIBUITOR DE GEL AUTOMAT - 400 ML

- Compatibil cu săpun lichid, alcool, gel și dezinfectant de mână.
- Senzor inteligent de mișcare infraroșu.
- Dozare: 1ml.
- Tensiune : 6V (4 pilas de 1,5V).
- Baterii neincluse.



14793

12,00€



DISTRIBUITOR PENTRU CARAFA



53902

25,00€

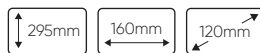
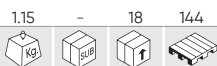

DISTRIBUITOR AUTOMAT - 1200 ML

- Dozaj: 0,7 ml / 1,4 ml
- Distanța de activare a senzorului: 80-120mm
- Tensiune: 6 V, 1,5 A (4 x 1,5 V baterii, dimensiunea tip C - incluse)
- Dimensiuni: 160 x 120 x 295 mm
- Greutate: 1 kg
- Material: ABS



53827

32,00€



SUPORT PENTRU DOZATORUL AUTOMAT DE GEL

- Greutate: 4,3 kg
- Material: ulei
- Culoarea: neagră
- Măsurile ale tăvii: 417x67mm
- Distribuitor suport Măsurători: 480x133 mm
- Diametru de bază: 395mm



REF. DESCRIERE

REF.	DESCRIERE	Kg	Unit	ML	€
15059	ADAPTOR AC/DC 6V 1.5A	0.10	-	200	10,00€
15062	R14 C1.5V BATERIE	0.05	24	480	1,00€

EXTENSIBILE
1.25m - 1.58m

53832

1,81€



GEL DESINFECTANT PENTRU MÂINI 60ML



PREZENTAT ÎNTR-UN EXPOZANT DE 24 UNITĂȚI

53791

4,80€



GEL HIDROALCOHOLIC PENTRU MÂINI 500ML



52493

4,50€

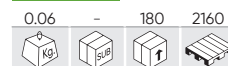

PISTOL DIN PLASTIC PENTRU SPRAY



53940

13,20€



STAND BARIERĂ PENTRU LANȚ PVC - GALBEN / NEGRU

- MATERIAL: PVC
- BAZA GONFLABILĂ

LANȚUL NU ESTE INCLUS.



SEMNALIZARE SPECIALĂ DE ÎNALTĂ TENSIUNE



54322

19,00€



N

SET DE 2 SEMNE DE AVERTIZARE DE ÎNALTĂ TENSIUNE



53987

9,50€



BANDĂ DE SEMNALIZARE GALBEN/NEGRU - 200M

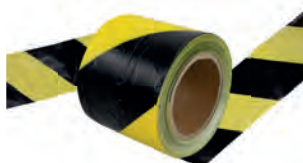

53942

0,50€

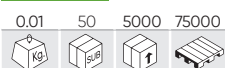

ZA PLASTICĂ DE LANȚ NEGRU



54326

7,30€



N

LANȚ PVC - 7M - GALBEN / NEGRU

7m



53808

16,50€



STAND BARIERĂ PENTRU LANȚ PVC

- MATERIAL: PVC
- BAZA GONFLABILĂ



53914

75,00€



POST DE SEPARARE CU BANDĂ RETRACTILĂ

- Material: oțel
- Diametrul conductatei: 63 mm
- Diametrul bazei: 320 mm
- Înălțime: 910 mm

- Bandă pe 4 laturi
- Lungime bandă: 3 m
- Lățime bandă: 48 mm



53811

8,90€

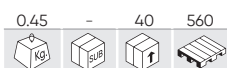

BANDĂ DE SEMNALIZARE ALBĂ-ROȘIE - 200M



53839

0,25€

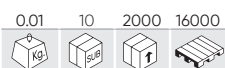

ZA PLASTICĂ DE LANȚ



53809

8,00€



LANȚ PVC - 5M

- Lungime: 5m
- Legătură: 6mm
- Culoare: roșu / alb

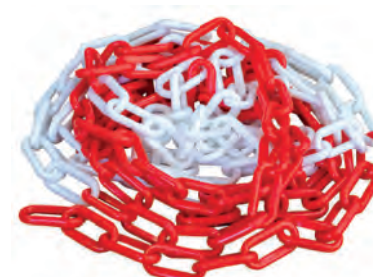

53796

76,00€

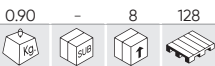

GENERATOR PORTABIL DE OZON 600 MG/H (12V/220V)

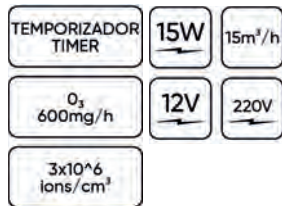

600mg/h

Temporizador/Timer	30/30min	60min	HOLD
--------------------	----------	-------	------

53786

98,00€



GENERATOR PORTABIL DE OZON 5000 MG/H (220V)



5.000mg/h

50m³	20 min
100m³	40 min
150m³	60 min
200m³	80 min
300m³	100 min

REF. DESCRIERE



14775	PLACĂ DE SCHIMB PENTRU GENERATORUL PORTABIL DE OZON (REF. 53786)	0.02	-	1	-	30,50€
-------	--	------	---	---	---	--------

53806

250,00€



GENERATOR PORTABIL DE OZON 20000 MG/H (220V)

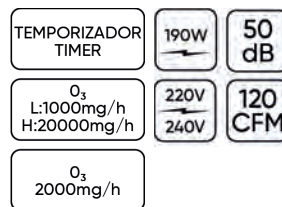

10.000mg/h

50m³	8 min
100m³	16 min
150m³	24 min
200m³	32 min
300m³	48 min
500m³	65 min

20.000mg/h

500m³	30 min
600m³	40 min
700m³	50 min
800m³	60 min
900m³	70 min
1.000m³	80 min

REF. DESCRIERE



14803	PLACĂ DE SCHIMB PENTRU GENERATORUL PORTABIL DE OZON	0.03	-	50	-	43,00€
-------	---	------	---	----	---	--------

53838

38,00€



CUTIE DE TRATAMENT OZON

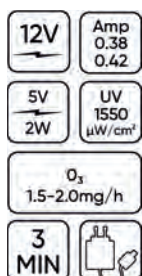

- Lungime de undă ultravioletă: 254nm
- Priză de alimentare: conector Micro-USB
- Cutia este ușor de asamblat și demontat, facilitând astfel transportul acesteia.



DESCHIS

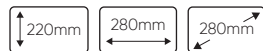

STRĂNS

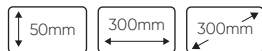

53802

120,00€

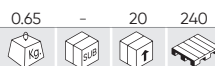

OZONOMETRU

- Precizie: ≤±5% F.S.
- Intervalul de măsurare: 0-50ppm (0-98mg/m³)
- Semnal de alarmă de concentrație scăzută: 5ppm (9.8mg/m³)
- Semnal de alarmă de concentrație ridicată: 10ppm (19.6 mg/m³)
- Timp de răspuns: <30 segundos
- Intervalul de temperaturi de lucru: -10°C - 55°C
- Protecție IP65



DOUĂ NIVELURI DE ALARMĂ CONFIGURABILE PENTRU NIVELURI DIFERITE DE CONCENTRARE

TIMP DE FUNCȚIONARE: >8H
TIMPUL DE ÎNCĂRCARE: 4H-6H



RESPECTĂ: EN61326-1, EN61000-4-2, EN61000-4-3

CONSUMABILE

383 ACE SI INELE FIXARE

384 NITURI

384 ȘURUBURI PIULIȚE ȘAIBE

388 ȘAIBE PENTRU CARTER ȘI MOTOR

391 ALTELE

391 GARNITURI ȘI GARNITURI INELARE

392 CONECTORI PENTRU FURTUNURI

393 ELECTRICE

396 CLEME ȘI AGRAFE DIN PLASTIC



CONSUMABILE

52044

19,00€

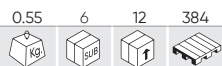

TRUSĂ DE SPLINTURI "R" 150 PIESE



REF.		PCS	€
10793	2,3x43	25	0,25€
10794	3,2x52	20	0,40€
10795	3,8x75	8	0,60€
10882	2x32	42	0,25€
10883	1,6x36	30	0,25€
10884	1,6x42	25	0,25€

52027

14,00€

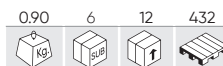

TRUSĂ DE SPLINTURI 365 PIESE



REF.		PCS	€
10796	1,2x25	50	0,07€
10797	1,6x32	50	0,09€
10798	2x40	50	0,12€
10799	2,5x40	50	0,13€
10800	3,2x40	50	0,15€
10801	3,2x50	50	0,17€
10802	4x50	40	0,19€
10803	5x63	10	0,05€
10804	6,3x63	15	0,22€

53348

14,00€

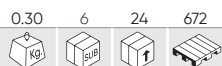

TRUSĂ DE CLIPSURI TIP "E"



	PCS
M1.5 - 1/16"	15
M3 - 1/8"	15
M5 - 3/16"	20
M6 - 1/4"	25
M9 - 3/8"	25
M12 - 1/2"	20
M15 - 5/8"	10
M19 - 3/4"	10
M22 - 7/8"	10

53350

14,00€



TRUSĂ DE CONDUCTORI ELASTICI



1/16" x 3/16"	4	3/16" x 5/8"	5
1/16" x 5/16"	4	3/16" x 1"	5
1/16" x 3/4"	4	3/16" x 1-1/4"	5
5/64" x 1/4"	4	7/32" x 5/8"	4
5/64" x 1/2"	4	7/32" x 1-1/4"	4
5/64" x 1"	4	7/32" x 1-3/4"	4
3/32" x 5/8"	4	1/4" x 5/8"	4
3/32" x 1"	4	1/4" x 1-1/4"	4
3/32" x 1-1/4"	4	1/4" x 1-3/4"	4
1/8" x 5/8"	5	5/16" x 3/4"	4
1/8" x 1"	5	5/16" x 1-1/2"	4
1/8" x 1-1/4"	5	5/16" x 2"	4
5/32" x 5/8"	4	3/8" x 3/4"	2
5/32" x 1"	4	3/8" x 1-1/2"	2
5/32" x 1-1/2"	4	3/8" x 2"	2

53363

34,00€



TRUSĂ DE CONECTORI CLEVIS ȘI SPLINTURI "R"



	PCS
3.5x44	6
2.5x42	20
2.5x58	7
2x3	7

	PCS
8x50	5
9.5x50	18
11x63	5
12.5x50	3

53364

16,00€



TRUSĂ CU CHEI



	PCS
3x3x25	4
3x3x20	4
5x5x30	5
5x5x25	5
5x5x20	5
6x6x40	5
6x6x30	5
6x6x20	5
8x8x40	5
8x8x30	5
10x10x40	5
10x10x30	5
12x12x40	2

53371

29,00€

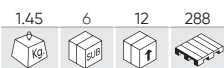

TRUSĂ DE CONECTORI CU INEL

50 PCS



	PCS
5x36	16
6x45	18
8x45	6
11x45	10

53372

26,00€



TRUSĂ DE CHEI

144 PCS



	PCS
M3x50	50
M4x60	30
M5x75	20
M6x50	20
M6x75	16
M8x60	8

53373

14,50€

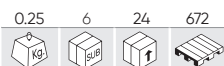

TRUSĂ DE ȘAIBE DINȚATE INTERIOR

260 PCS



	PCS
M3x10	30
M4x12	30
M5x14	40
M6x14	50
M8x18	50
M10x20	40
M12x25	20

53383

11,50€

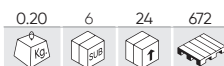

TRUSĂ DE ȘAIBE SEEGER EXTERIOARE

300 PCS



	PCS
M4	50
M6	40
M8	45
M10	30
M12	30
M14	25
M16	25
M18	25
M20	15
M22	15

53382

11,00€



TRUSĂ DE ȘAIBE SEEGER INTERIOARE

300 PCS



	PCS
M4	50
M6	40
M8	45
M10	30
M12	30
M14	25
M16	25
M18	25
M20	15
M22	15

52711

27,50€



TRUSĂ DE POPNITURI DIN PLASTIC

150 PCS



REF.		PCS	€
13674	6x19,3mm	25	0,50€
13675	6x17,8mm	25	0,50€
13676	6x25,5mm	25	0,50€
13677	6x24,5mm	25	0,50€
13678	6x24mm	50	0,50€

52703

22,00€



TRUSĂ DE PIULIȚE NIT POP

235 PCS



REF.		PCS	€
13235	M3	50	0,15€
13236	M4	50	0,15€
13237	M5	50	0,15€
13238	M6	40	0,20€
13239	M8	20	0,20€
13240	M10	15	0,40€
13241	M12	10	0,55€

53360

18,00€



TRUSĂ DE PIULIȚE DE NIT

150 PCS



	PCS
3x9	40
4x11	35
5x13	25
6x15	25
8x18	15
10x21	10

53361

24,00€

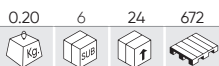

TRUSĂ DE PIULIȚE DE NIT DE ALUMINIU

150 PCS



	PCS
3x9	40
4x11	35
5x13	25
6x15	25
8x18	15
10x21	10

52043

16,50€

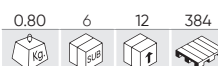

TRUSĂ DE POPNITURI 300 PIESE

300 PCS



REF.		PCS	€
10877	4,8x16,90mm	50	0,25€
10878	4,8x24,80mm	40	0,30€
10879	3,2x9,70mm	90	0,20€
10880	4,8x12,70mm	70	0,20€
10881	4,80x20mm	50	0,25€

53351

12,50€

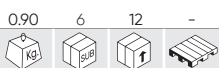

TRUSĂ CU ȘURUBURI ȘI PIULIȚE

240 PCS



	PCS		PCS
M4x12	10	M4	20
M4x20	10	M5	20
M5x16	10	M6	20
M5x25	10	M8	10
M6x20	10	M10	10
M6x30	10		PCS
M8x25	5	M4	20
M8x40	5	M5	20
M10x16	5	M6	20
M10x40	5	M8	10
		M10	10

53354

14,00€



TRUSĂ DE ȘURUBURI AUTOFILETANTE

200 PCS



	PCS
#8x12.5	30
#8x16	30
#8x19	30
#8x25	30
#10x12.5	20
#10x16	20
#10x19	20
#10x25	20

53362

14,00€

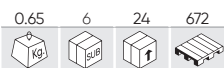

TRUSĂ CU ȘURUBURI ALLEN



	PCS
4x12	25
5x12	25
5x25	20
10x40	3
6x25	10
8x40	5
10x25	3
6x12	10
8x25	5



53365

14,00€

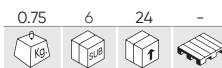

TRUSĂ CU PIULIȚE FLUTURE



	PCS
M4	40
M5	40
M6	25
M8	25
M10	20



53366

14,00€



TRUSĂ CU ȘURUBURI ȘI PIULIȚE TIP U



	PCS
M3.5x8	40
M4.2x16	20
M5x12	15
M6.35x19	10

	PCS
M3.5	20
M3.5 Con muesca/with notch	20
M4	20
M5	15
M6.35	10



53369

14,00€



TRUSĂ CU ȘURUBURI



	PCS
2.8x13mm	65
2.8x16mm	55
3.5x10mm	60
3.5x13mm	65
3.5x16mm	60
3.5x19mm	45
4.2x13mm	50
4.2x16mm	40
4.2x25mm	30
4.2x31mm	20
4.8x19mm	25
4.8x25mm	20
4.8x32mm	15



52029

14,00€



TRUSĂ CU PIULIȚE AUTOBLOCANTE 228 PIESE



	PCS
M3	50
M4	50
M5	40
M6	30
M8	20
M10	15
M12	10
M14	8
M16	5



52028

15,20€



TRUSĂ CU PIULIȚE 243 PIESE



REF.		PCS	€
10805	M3	50	0,10€
10779	M4	50	0,05€
10780	M5	50	0,05€
10781	M6	30	0,05€
10784	M8	20	0,05€
10785	M10	20	0,10€
10786	M12	10	0,15€
10812	M14	8	0,30€
10813	M16	5	0,30€



CONSUMABILE

52032

28,00€



TRUSĂ CU ȘAIBE GROVER NEGRE 1.735 PIESE

1735 PCS



	PCS
3mm	600
4mm	400
5mm	220
6mm	220
8mm	110
10mm	65
12mm	50
14mm	40
16mm	30



53377

20,00€

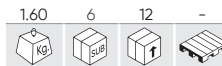

TRUSĂ CU ȘAIBE DE FIER SUPRADIMENSIONATE

240 PCS



	PCS
20x6x1.5	20
20x8x1.5	20
20x10x1.5	20
25x6x1.5	20
25x8x1.5	20
25x10x1.5	20
32x2x1.5	20
32x4x1.5	20
32x6x1.5	20
32x8x1.5	20
32x10x1.5	20
32x10x1.5	20



52158

38,50€



TRUSĂ CU ȘAIBE DIN FIER GALVANIZAT, 475PCS

475 PCS

	PCS		PCS
5x20x1.5	50	6x30x2	25
6x20x1.5	50	7x30x2	25
7x20x1.5	50	8x30x2	25
8x20x1.5	50	4x11x0.98	50
8x25x1.75	50	12x40x3	25
10x30x2.5	25	4x20x1.5	50



51804

58,00€



TRUSĂ DE ȘURUBURI, PIULIȚE ȘI ȘAIBE

828 PCS

REF.	DESCRIERE	PCS	€
10772	ȘURUB ZINCAT DIN 933 8.8 M4X25	25	0,05€
10773	ȘURUB ZINCAT DIN 933 8.8 M5X50	25	0,10€
10774	ȘURUB ZINCAT DIN 933 8.8 M6X50	25	0,10€
10775	ȘURUB ZINCAT DIN 933 8.8 M7X50	15	0,15€
10776	ȘURUB ZINCAT DIN 933 8.8 M8X50	15	0,20€
10777	ȘURUB ZINCAT DIN 933 8.8 M10X50	12	0,20€
10778	ȘURUB ZINCAT DIN 933 8.8 M12X60	20	0,35€
10779	PIULIȚĂ ZINCATĂ DIN 934 M4	50	0,05€
10780	PIULIȚĂ ZINCATĂ DIN 934 M5	50	0,05€
10781	PIULIȚĂ ZINCATĂ DIN 934 M6	50	0,05€
10782	PIULIȚĂ ZINCATĂ DIN 934 M7	50	0,05€
10783	ȘAIBĂ ZINCATĂ DIN 125 M12	50	0,05€
10784	PIULIȚĂ ZINCATĂ DIN 934 M8	50	0,05€
10785	PIULIȚĂ ZINCATĂ DIN 934 M10	50	0,10€
10786	PIULIȚĂ ZINCATĂ DIN 934 M12	40	0,15€
10787	ȘAIBĂ ZINCATĂ DIN 125 M4	50	0,05€
10788	ȘAIBĂ ZINCATĂ DIN 125 M5	50	0,05€
10789	ȘAIBĂ ZINCATĂ DIN 125 M6	50	0,05€
10790	ȘAIBĂ ZINCATĂ DIN 125 M7	50	0,05€
10791	ȘAIBĂ ZINCATĂ DIN 125 M8	50	0,05€
10792	ȘAIBĂ ZINCATĂ DIN 125 M10	50	0,05€

REF.	DESCRIERE	PCS	€
50959	CUTIE DIN PLASTIC PENTRU SCULE CU 20+1 COMPARTIMENTE	1	14,00€



53464

153,00€



551 PCS

TRUSĂ DE ȘAIBE DE CUPRU PENTRU INJECTOARE 551 PCS

PIESE DISPONIBILE

REF.	DESCRIERE	PCS	€
13945	Ø15.0x8.0x1.5 - UNIVERSAL	30	7,40€
13946	Ø15.0x7.0x1.5 - MERCEDES	12	6,70€
13947	Ø13.0x7.5x2.5 - RENAULT	30	5,85€
13948	Ø15.0x7.5x1.5 - IVECO, FORD, BMW, MAN	30	5,00€
13949	Ø15.0x7.5x2.0 - IVECO, FORD, BMW, MAN	30	6,50€
13950	Ø15.45x8.0x2.0 - UNIVERSAL	30	7,80€
13951	Ø13.5x10x2.0 - MAZDA (REF.. 53464)	12	5,15€
13952	Ø15.5x7.5x2.5 - FORD	30	10,90€
13953	Ø15.5x7.5x1.5 - LAND ROVER	12	8,00€
13954	Ø15.0x7.5x3.0 - RENAULT	30	12,70€
13955	Ø13.0x7.0x1.5 - DEUTZ	12	4,95€
13956	Ø13.5x7.5x1.5 - FORD	30	4,30€
13957	Ø15.0x7.5x1.5 - FIAT	12	9,70€
13958	Ø15.5x7.5x1 - MAN ROVER	12	5,45€
13959	Ø16.5x7.5x2 - MERCEDES	30	10,10€
13960	Ø13.7x7.3x3 - KIA	12	9,65€
13961	Ø13.7x7.3x2 - KIA	12	9,25€
13962	Ø10x6.0x1.0	50	1,76€
13963	Ø15.8x7.5x3.0	30	12,40€
13964	BAG DE 30 CONECTORI DE HOSE ÎN "T"	20	15,00€
13965	Ø8x5.8x1	30	1,50€
13966	BAG DE 30 CONECTORI DE HOSE ÎN "L"	30	12,90€
13967	BAG DE 30 MENȚINEREA SPRINGS	25	4,65€



52031

44,00€



TRUSĂ CU ȘAIBE ALUMINIU 900 PIESE



Ø	PCS
3x7x1.5	50
4x8x1.5	50
5x6x1.5	50
16x22x1.5	50
14x22x1.5	50
14x20x1.5	50
6x10x1.5	50
6x11x1.5	50
7x11x1.5	50
7x12x1.5	50
8x12x1.5	50
8x14x1.5	50
9x12x1.5	50
10x14x1.5	50
11x16x1.5	50
11x17x1.5	50
12x16x1.5	50
12x18x1.5	50



53353

18,00€



TRUSĂ DE ȘAIBE DE CUPRU



Ø	PCS
M6	30
M8	25
M10	20
M12	15
M14	10
M16	10



52163

95,00€

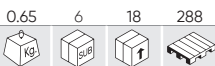

TRUSĂ ȘAIBE DIN CUPRU



PIESE DISPONIBILE

REF.	mm	PCS	€
51538	Ø 10mm	100	0,15€
51539	Ø 12mm	100	0,15€
51540	Ø 14mm	100	0,15€
51541	Ø 16mm	100	0,25€
51542	Ø 18mm	100	0,20€
51543	Ø 20mm	25	0,25€

AȚI PUTEA DORI, DE ASEMENEA...

REF.	mm	PCS	€
51544	Ø 22mm	100	0,25€
51545	Ø 26mm	100	0,30€

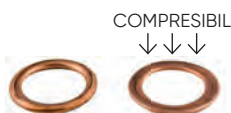

52030

98,00€



TRUSĂ CU ȘAIBE 18 CUPRU 900 PIESE



PIESE DISPONIBILE

REF.	mm	PCS	€
10823	3x7x1,5mm	50	0,20€
10824	4x8x1,5mm	50	0,20€
10825	5x6x1,5mm	50	0,20€
10826	16x22x1,5mm	50	0,40€
10827	14x22x1,5mm	50	0,60€
10828	14x20x1,5mm	50	0,45€
10829	6x10x1,5mm	50	0,20€
10830	6x11x1,5mm	50	0,20€
10831	7x11x1,5mm	50	0,20€

REF.	mm	PCS	€
10832	7x12x1,5mm	50	0,20€
10833	8x12x1,5mm	50	0,20€
10834	8x14x1,5mm	50	0,25€
10835	9x12x1,5mm	50	0,25€
10836	10x14x1,5mm	50	0,30€
10837	11x16x1,5mm	50	0,30€
10838	11x17x1,5mm	50	0,30€
10839	12x16x1,5mm	50	0,40€
10840	12x18x1,5mm	50	0,35€



TRUSĂ DE ȘAIBE DE CUPRU PENTRU INJECTOARE

53229

38,70€



mm	PCS	mm	PCS
13,8 x 7,3 x 1,4mm	10	15,0 x 7,5 x 3,0mm	10
14,6 x 7,5 x 1,3mm	10	15,5 x 7,5 x 2,0mm	10
14,6 x 7,5 x 3,0mm	10	16,0 x 7,5 x 1,5mm	10
15,0 x 7,0 x 2,0mm	10	16,0 x 7,5 x 1,7mm	10
15,0 x 7,5 x 1,0mm	10	16,0 x 7,5 x 2,0mm	10
15,0 x 7,5 x 1,5mm	10	16,4 x 7,5 x 2,0mm	10
15,0 x 7,5 x 2,0mm	10	20,0 x 9,4 x 0,9mm	10
15,0 x 7,5 x 2,5mm	10		



53340

86,00€



mm	PCS	mm	PCS
13,8 x 7,3 x 1,4mm	25	15,0 x 7,5 x 3,0mm	25
14,6 x 7,5 x 1,3mm	25	15,5 x 7,5 x 2,0mm	25
14,6 x 7,5 x 3,0mm	25	16,0 x 7,5 x 1,5mm	25
15,0 x 7,0 x 2,0mm	25	16,0 x 7,5 x 1,7mm	25
15,0 x 7,5 x 1,0mm	25	16,0 x 7,5 x 2,0mm	25
15,0 x 7,5 x 1,5mm	25	16,4 x 7,5 x 2,0mm	25
15,0 x 7,5 x 2,0mm	25	20,0 x 9,4 x 0,9mm	25
15,0 x 7,5 x 2,5mm	25		



53229 - 53340 PIESE DISPONIBILE

REF.	mm	PCS	€
13819	13,8 x 7,3 x 1,4mm	50	6,50€
13820	14,6 x 7,5 x 1,3mm	50	7,00€
13821	14,6 x 7,5 x 3,0mm	50	14,00€
13822	15,0 x 7,0 x 2,0mm	50	11,00€

REF.	mm	PCS	€
13823	15,0 x 7,5 x 1,0mm	50	6,00€
13824	15,0 x 7,5 x 1,5mm	50	8,00€
13825	15,0 x 7,5 x 2,0mm	50	11,50€
13826	15,0 x 7,5 x 2,5mm	50	13,00€

REF.	mm	PCS	€
13827	15,0 x 7,5 x 3,0mm	50	15,00€
13828	15,5 x 7,5 x 2,0mm	50	11,50€
13829	16,0 x 7,5 x 1,5mm	50	10,50€
13830	16,0 x 7,5 x 1,7mm	50	10,50€

REF.	mm	PCS	€
13831	16,0 x 7,5 x 2,0mm	50	12,60€
13832	16,4 x 7,5 x 2,0mm	50	13,00€
13833	20,0 x 9,4 x 0,9mm	50	9,00€

54390

199,00€



N

SET DE CONECTORI ȘI TUBURI DE COMBUSTIBIL (95 BUC.)

PIESE DISPONIBILE

REF.	mm	PCS	€	REF.	mm	PCS	€
16462	6,3x6mm	3	36,50€	16538	7,5x200mm	3	19,50€
16463	7,89x8mm	3	36,50€	16539	12x200mm	1	18,00€
16464	9,49x8 mm	3	36,50€	16540		1	13,00€
16465	9,89x8 mm	3	39,50€	16541	6x340mm	2	13,00€
16466	11,80x10mm	3	50,00€	16542	8x340mm	6	23,50€
16467	6,3x6 mm	3	36,50€	16543	9,5x340mm	2	13,00€
16468	7,89x8 mm	3	36,50€				
16469	9,49x8 mm	3	36,50€				
16470	9,89x8 mm	3	39,50€				
16471	11,8x10mm	3	50,00€				
16472	6,3x6 mm	5	17,50€				
16473	7,89x8mm	5	17,50€				
16474	9,49x8 mm	5	17,50€				
16475	9,89x8mm	5	17,50€				
16476	11,8x10 mm	5	24,00€				
16477	6x7,5mm	3	24,50€				
16478	8x7,5mm	6	24,50€				
16479	15 - 18mm	12	7,50€				
16480	17-20mm	4	7,50€				

95 PCS



ȘAIBĂ DIN CUPRU METALOPLASTICĂ

REF.	DESCRIERE					€
52719	ȘAIBĂ DIN CUPRU METALOPLASTICĂ 10MM DIAMETRU	0.00	100	5000	150000	0,19€
51843	ȘAIBĂ DIN CUPRU METALOPLASTICĂ 12MM DIAMETRU	0.01	100	5000	200000	0,19€
51554	ȘAIBĂ DIN CUPRUPLASTICĂ ELASTICĂ 13MM DIAM.	0.00	100	5000	180000	0,28€
51546	ȘAIBĂ DIN CUPRU METALOPLASTICĂ 14MM DIAMETRU	0.00	100	5000	150000	0,19€
51799	ȘAIBĂ DIN CUPRU METALOPLASTICĂ 16MM DIAMETRU	0.01	100	120000	120000	0,20€



53599

30,30€

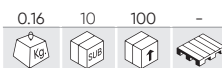

SET DE VULVE CU VENTIL PENTRU CONDIȚIONAREA AERULUI

134 PCS

PIESE DISPONIBILE

REF.	mm	PCS	€	REF.	mm	PCS	€
14594	5x19mm R12	50	2,00€	14599	7x20mm R134A	10	4,50€
14595	5x19mm	30	1,50€	14600	6x22mm	5	9,50€
14596	5x19mm R12	30	2,00€	14601	8x22mm	1	11,00€
14597	6x19mm	3	7,60€	14602	9x22mm	4	11,00€
14598	6x26mm	1	17,80€				



53358

11,50€

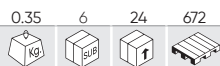

TRUSĂ DE ARCURI



	PCS	mm	PCS
	12	5/16x1-3/4	10
		13/64x13/16	10
		7/32x1	10
		1/4x7/8	10
	10	9/32x1/2	8
	10	5/16x1-1/8	10
	10	5/16x1-1/4	10
	10	3/16x1-3/4	8
	10	9/32x1-1/2	10
	6	11/32x1-7/16	10
	12	3/8x3/4	12
	8	23/64x1-3/8	12
	10	9/32x3/4	12



53352

12,00€

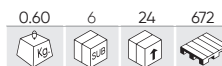

TRUSĂ DE ȘURUBURI DE CÂRLIG



	PCS
	50
2.4x41	12
4x64	5
4.2x85	

	PCS
	60
2.4x25	12
4x45	12
4x50	12



52033

43,00€

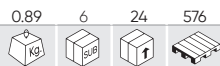

TRUSĂ CAPETE GRESARE 135 PIESE



REF.	90°	PCS	€
10874	6x1	20	0,30€
10875	8x1	15	0,40€
10876	10x1	10	0,45€

REF.	UNGHII DREPT	PCS	€
10868	6x1	20	0,30€
10869	8x1	15	0,30€
10870	10x1	10	0,45€

REF.	45°	PCS	€
10871	6x1	20	0,30€
10872	8x1	15	0,40€
10873	10x1	10	0,45€



53359

16,00€

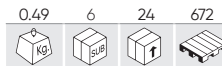

TRUSĂ DE NIPLURI DE GRESARE 110 PIESE



	90°
6x1	60
8x1.25	10
10x1.5	10

	UNGHII DREPT
6x1	5
8x1.25	5
10x1.5	5

	45°
6x1	5
8x1.25	5
10x1.5	5



53378

13,00€

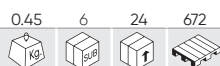

TRUSĂ DE COLIERE DE FURTUN 20 PIESE



	PCS
	4
1"	2
2-1/2"	2
1-1/4"	2
3"	2
1-3/4"	2
3-1/2"	2
2"	4
4"	2



53381

14,50€

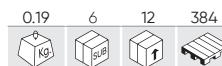

TRUSĂ DE ȘAIBE DE FIBRĂ 600 PIESE



	PCS
	160
10x5.5x1	80
16x10x1	40
19x12x1	30
22x16x1	20
22.5x14x1	20
32x22x1	100
12x6.5x1	60
16x8x1	40
20x12.5x1	20
27x20x1	15
25.4x17.5x1	15
32x24x1	



50651

18,00€

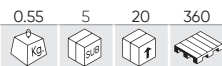

TRUSĂ DE ORINGURI METRICE



POZIȚIA TRUSA	CAPACUL TRUSEI						BAZA TRUSEI					
	006	007	008	009	010	011	211	212	213	214	215	216
LĂȚIME DE CAUCIUC (MM)	2	2	2	2	2	2	3	3	3	3	3	3
Ø INTERIOR (MM)	A 3	4	5	6	7	8	D 20	22	24	25	27	28
CANTITATE	16	16	16	16	16	16	12	12	12	12	12	12
POZIȚIA TRUSA	113	112	111	110	012		221	220	219	218	217	
LĂȚIME DE CAUCIUC (MM)	B 2.5	2.5	2.5	2.5	2		E 3	3	3	3	3	
Ø INTERIOR (MM)	14	12	11	10	10		36	35	33	32	30	
CANTITATE	13	13	13	13	17		12	12	12	12	12	
POZIȚIA TRUSA	114	115	116	210			222	325	326	327		
LĂȚIME DE CAUCIUC (MM)	C 2.5	2.5	2.5	3			F 3	4	4	4		
Ø INTERIOR (MM)	16	17	19	19			38	38	41	44		
CANTITATE	13	13	13	10			12	10	9	9		



50652

16,50€

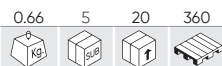

TRUSĂ DE ORINGURI ÎN ȚOLI



POZIȚIA TRUSA	CAPACUL TRUSEI						BAZA TRUSEI					
	006	007	008	009	010	011	211	212	213	214	215	216
LĂȚIME DE CAUCIUC (MM)	1/16	1/16	1/16	1/16	1/16	1/16	D 1/8	1/8	1/8	1/8	1/8	1/8
Ø INTERIOR (MM)	A 1/8	5/32	3/16	7/32	1/4	5/16	13/16	7/8	15/16	1	11/16	11/18
CANTITATE	20	20	20	20	20	20	10	10	10	10	10	10
POZIȚIA TRUSA	113	112	111	110	012		221	220	219	218	217	
LĂȚIME DE CAUCIUC (MM)	B 3/32	3/32	3/32	3/32	1/16		E 1/8	1/8	1/8	1/8	1/8	
Ø INTERIOR (MM)	9/16	1/2	7/16	3/8	3/8		17/16	13/8	15/16	11/4	13/16	
CANTITATE	13	13	13	13	13		10	10	10	10	10	
POZIȚIA TRUSA	114	115	116	210			222	325	326	327		
LĂȚIME DE CAUCIUC (MM)	C 3/32	3/32	3/32	1/8			F 1/8	3/16	3/16	3/16		
Ø INTERIOR (MM)	5/8	11/16	3/4	3/4			11/2	11/2	15/8	13/4		
CANTITATE	13	13	13	10			10	7	7	7		
CANTITATE												



50807

38,00€

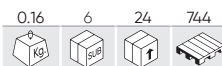

SET ORINGURI / GARNITURI PENTRU AACC



Ø	PCS	Ø	PCS	Ø	PCS
5.29x1.78	20	8.80x1.90	20	13.95x2.62	10
6.07x1.78	20	10.82x1.78	15	14.0x2.0	10
6.8x1.9	20	10.77x2.62	15	15.0x2.0	10
7.65x1.78	20	11.0x2.0	15	17.0x2.0	10
7.80x1.90	20	12.0x2.0	15	17.17x1.78	10
8.0x2.0	20	13.9x1.80	10	17.04x3.53	10



CONSUMABILE

53910

19,00€

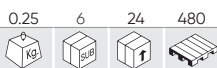

TRUSA CONECTORI DE FURTUNE 113 PIESE



DIRECT

4.8x4.8	10
6.3x6.3	8
7.9x7.9	6
9.5x9.5	6
3.17x3.17	30

RACORD TRIPLU

3.9x3.9x3.9	8
4.8x4.8x4.8	8
6.3x6.3x6.3	6
9.5x9.5x9.5	3
3.17x3.17x3.17	12

REDUCTOR

9.5x6.3	6
6.3x4.8	10



53434

18,00€

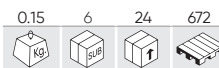

TRUSA CONECTORI DE FURTUNE 65 PIESE



PCS

4x28.7	10
3.9x30.8	5
10.4x4.4	10
5.6x4.71	5
7.9x3.8	10
4.7x3.8.9	5
5.2x3.3.9	10
7x3.0	10



53992

18,00€



MANȘON DE LIPIT TERMOCONTRACTABIL DE LIPIT SET 100PCS



Ø1.7mm / 0.25-0.34mm2 / 26-24 AWG	25
Ø2.7mm / 0.5-1.0mm2 / 22-18 AWG	35
Ø4.7mm / 1.5-2.5mm2 / 16-14 AWG	30
Ø6.0mm / 4.0-6.0mm2 / 12-10 AWG	10



53349

14,00€



TRUSĂ DE CONDUCTORI DE GUMĂ



DESCHIS LA	PCS	ÎNCHIS	PCS
M19,5x23	2	M25	2
M16x24	3	M22	3
M13x15	3	M19	4
M11,5x19	4	M15	5
M10x20	3	M12	10
M10x12	5	M9	20
M9,8x11,5	6	M7	20
M8x14	3		
M7,5x13	7		
M6x7,5	10		
M3,5x6	15		



53374

10,00€

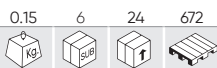

SET DE MANȘOANE TERMORETRACTABILE



PCS	PCS
M2x40	30
M2.5x40	25
M3.5x40	20
M5x40	20
M7x80	16
M10x80	8
M13x85	8



53376

10,50€



TRUSĂ DE MANȘOANE TERMORETRACTABILE ROȘII



PCS	PCS
M2x40	30
M2.5x40	25
M3.5x40	20
M5x40	20
M7x80	16
M10x80	8
M13x85	8



REF. DESCRIERE

51920 TORȚĂ GAZ

0.14 10 100 400 18,00€

53370

26,00€

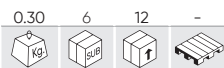

TRUSĂ DE CONECTORI DE GUMĂ - M2,3,4,5,6,8,10



	PCS
M2	25
M3	25
M4	30
M5	30
M6	30
M8	20
M10	20



53355

11,50€



TRUSĂ DE SIGURANȚE AUTO MINI



	PCS
5A	20
10A	20
15A	20
20A	20
25A	20
30A	20



53356

11,50€



TRUSĂ DE SIGURANȚE AUTO



REF.		PCS	€
10915	5A	20	0,25€
10917	10A	20	0,30€
10918	15A	20	0,30€
10919	20A	20	0,30€
10920	25A	20	0,25€
10921	30A	20	0,30€



53367

9,50€



TRUSĂ CU SIGURANȚE AUTO 48 PIESE



	PCS
5A	8
10A	8
15A	8
20A	8
25A	8
30A	8



53368

9,00€



TRUSĂ CU SIGURANȚE AUTO 50 PIESE



	PCS
5A	8
10A	8
15A	8
20A	8
25A	8
30A	10



53380

11,50€



TRUSĂ CU SIGURANȚE AUTO



	PCS
5A	20
10A	20
15A	20
20A	20
25A	20
30A	20



52054

17,00€

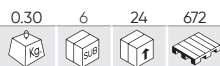

TRUSĂ CU SIGURANȚE AUTO 252 PIESE



REF.	Icon	PCS	€
10905	3A	20	0,25€
10906	4A	20	0,25€
10907	5A	20	0,25€

REF.	Icon	PCS	€
10908	7,5A	20	0,30€
10909	10A	20	0,30€
10910	15A	20	0,30€

REF.	Icon	PCS	€
10911	20A	20	0,30€
10912	25A	20	0,25€
10913	30A	20	0,30€

REF.	Icon	PCS	€
10914	4A	8	0,25€
10915	5A	8	0,25€
12954	3A	8	0,25€

REF.	Icon	PCS	€
10916	7,5A	8	0,30€
10917	10A	8	0,30€
10918	15A	8	0,30€

REF.	Icon	PCS	€
10919	20A	8	0,30€
10920	25A	8	0,25€
10921	30A	8	0,30€



52053

45,00€

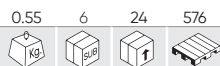

TRUSĂ CU PAPUCI ELECTRICI AUTO 635 PIESE



REF.	Icon	PCS	€
10885	RV1.25-4S	50	0,20€
10886	RV2-4S	50	0,20€
10887	RV2-6S	30	0,25€
10888	RV5.5-6S	20	0,30€
10889	RV5.5-5S	20	0,30€
10893	RV2-5S	40	0,25€

REF.	Icon	PCS	€
10894	SV1-4S	50	0,20€
10895	SV2-4S	40	0,20€

REF.	Icon	PCS	€
10896	FDD1.25-250	45	0,30€
10898	FDD2-250	40	0,30€
10900	FDD5.5-250	25	0,30€

REF.	Icon	PCS	€
10890	BV5.5	15	0,35€
10891	BV2	25	0,25€
10892	BV1.25	30	0,30€

REF.	Icon	PCS	€
10897	MDD1.25-250	50	0,30€
10899	MDD2-250	50	0,30€
10901	MDD5.5-250	30	0,25€

REF.	Icon	PCS	€
10902	FDN1.25-250	25	0,30€



CLEȘTE DE SERTIZAT
PENTRU TERMINALE
CONSULTĂRII PAG. 61



53357

7,00€



SET DE 2 CLEȘTI TIP CROCODIL



53385

19,30€



CLEȘTE PENTRU EXTRAGEREA CLIPSURILOR
DE PLASTIC DE CAROSERIE



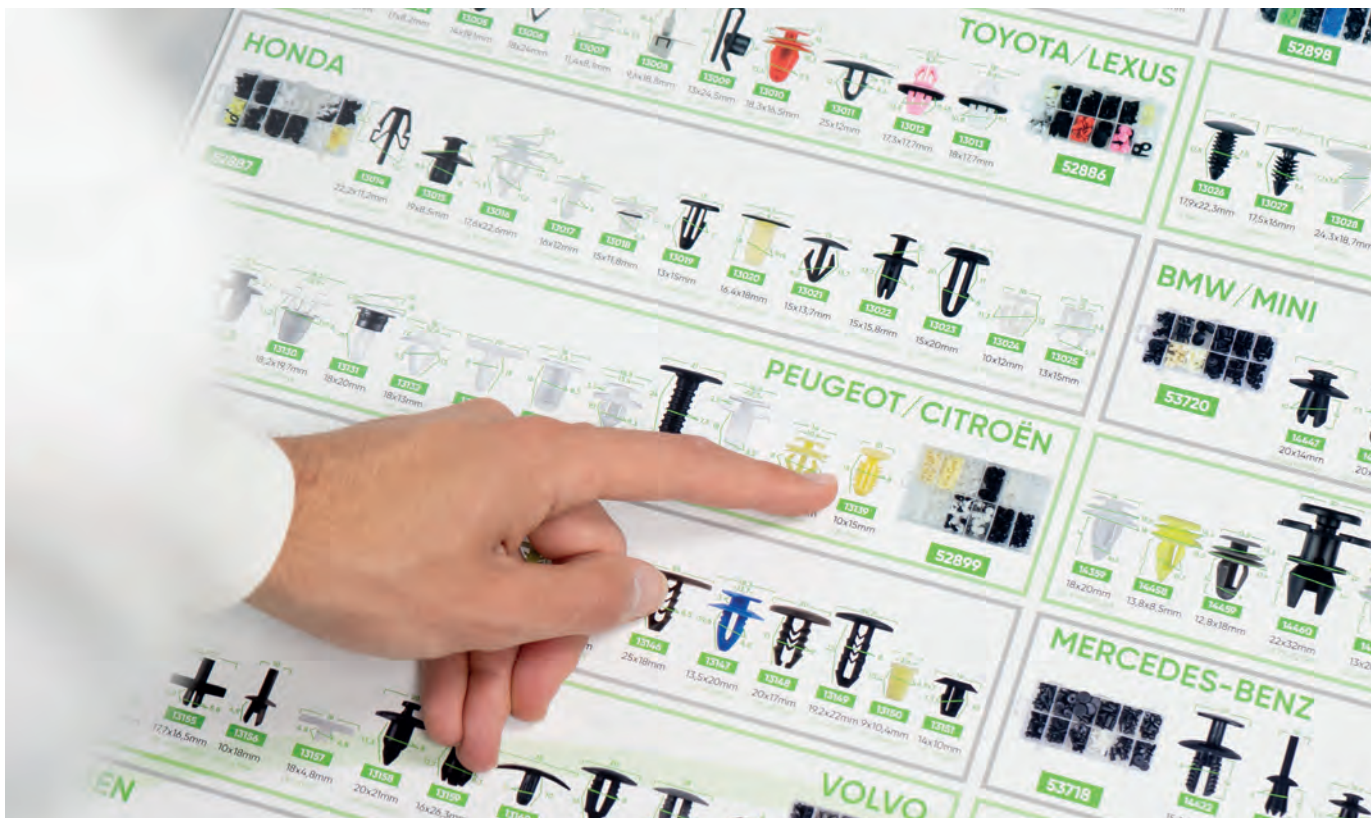

16294 14,00€

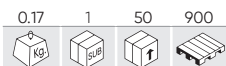

POSTER CLIPS DIMENSIUNE REALA

SPECIFICAȚII TEHNICE:

Dimensiune poster: 1000x640mm
 Material: 250g hârtie plastifiată
 Are găuri să-l atârne.

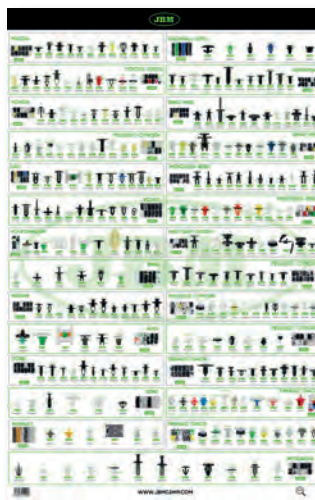

TAMAÑO REAL DE LOS CLIPS
 CLIPS REAL SIZE

52851 9,65€ **53110** 27,30€



SET 2 LEVIERE



SET DE 6 PÂRGHII



- 5"x8.5mm
- 5"x10.3mm
- 5"x4.5mm
- 15"x8.5mm
- 15"x10.3mm
- 15"x4.5mm



CONSUMABILE

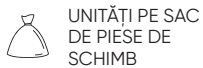

52896

26,00€



TRUSĂ DE CLIPS DE PLASTIC MAZDA

REF.	DESCRIERE	kg	pe sac	pe cutie	pe paletă	€
13104	OE:2042301	8	8	8	8	1,90€
13105	OE:999100402	15	15	15	15	2,50€
13106	OE:B0016830200	8	8	8	8	2,00€
13107	OE:N30413356A	8	8	8	8	2,15€
13108	OE:992640543A	20	20	20	20	1,90€
13109	OE:99249051B	30	30	30	30	2,90€
13110	OE:6508197AA	15	15	15	15	1,85€
13111	OE:B1016825200	10	10	10	10	1,20€
13112	OE:B09251833	6	6	6	6	1,65€
13113	OE:992640543A	20	20	20	20	2,20€
13114	OE:B45556741	20	20	20	20	2,20€
13115	OE:G03158762	30	30	30	30	2,50€

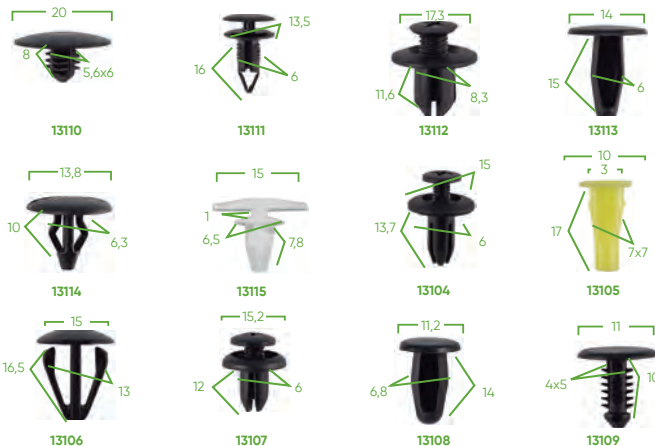

52886

18,00€



TRUSĂ DE CLIPS DE PLASTIC TOYOTA / LEXUS 89 PCS

REF.	DESCRIERE	kg	pe sac	pe cutie	pe paletă	€
13002	OE:9018906001	8	8	8	8	1,45€
13003	OE:9046707138	5	4	4	4	1,70€
13004	OE:9046707117	10	10	10	10	1,85€
13005	OE:9046709138	10	10	10	10	1,25€
13006	OE:9046709101	5	5	5	5	1,40€
13007	OE:75521611000	10	10	10	10	1,30€
13008	OE:7503933060	8	8	8	8	2,25€
13009	OE:9017905060	4	4	4	4	1,65€
13010	OE:677711250	8	8	8	8	1,75€
13011	OE:9046708124	5	5	5	5	1,15€
13012	OE:7539533030	8	8	8	8	1,80€
13013	OE:9046711063	8	8	8	8	1,75€



52887

22,00€



TRUSĂ DE CLIPS DE PLASTIC HONDA 150 PCS

REF.	DESCRIERE	kg	pe sac	pe cutie	pe paletă	€
13014	OE:75103SJ4003	12	12	12	12	1,45€
13015	OE:90675SB003	5	5	5	5	1,20€
13016	OE:91566SP0003	6	6	6	6	1,15€
13017	OE:91513SE003	25	25	25	25	2,60€
13018	OE:91530ST5003	25	25	25	25	1,45€
13019	OE:90687SA50030	15	15	15	15	1,75€
13020	OE:91620SR2003	8	8	8	8	1,70€
13021	OE:38529689A6300	8	8	8	8	1,30€
13022	OE:90683SA5003	10	10	10	10	2,10€
13023	OE:90672671003	10	10	10	10	1,50€
13024	OE:91534SEO000	18	18	18	18	2,45€
13025	OE:34355SD2003	8	8	8	8	1,50€



52899

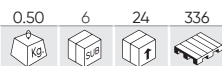

34,00€



TRUSĂ DE CLIPS DE PLASTIC PEUGOT / CITROEN 345 PCS

REF.	DESCRIERE			€
13128	OE:947098	50	50	1,85€
13129	OE:856535	20	20	2,00€
13130	OE:6991W4	20	20	3,75€
13131	-	20	20	3,45€
13132	OE:694143	25	25	2,65€
13133	OE:743707	35	35	3,45€
13134	OE:7703074022	30	30	3,95€
13135	OE:7703077059	35	35	3,45€
13136	OE:698317	15	15	2,60€
13137	OE:699502	25	25	2,25€
13138	OE:6995X3	30	30	2,85€
13139	OE:69945	40	40	3,85€



52900



34,00€



TRUSĂ DE CLIPS DE PLASTIC FIAT 308 PCS

REF.	DESCRIERE			€
13140	OE:14591784	30	30	2,65€
13141	OE:1459487	20	10	1,80€
13142	OE:1300433650	25	25	3,10€
13143	OE:71717421	8	8	1,95€
13144	OE:82456515	25	25	2,20€
13145	OE:5757139	25	25	3,85€
13146	-	20	8	4,50€
13147	OE:46306526	25	25	3,10€
13148	OE:14591687	25	25	3,30€
13149	OE:14592387	25	25	3,10€
13150	OE:83468473	30	30	2,25€
13151	OE:7677865	50	30	5,35€



52901

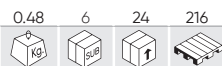

34,00€



TRUSĂ DE CLIPS DE PLASTIC VOLVO 350 PCS

REF.	DESCRIERE			€
13152	OE:8099905N07	25	25	3,05€
13153	OE:4292906	30	30	3,10€
13154	OE:12681763	20	20	3,20€
13155	OE:51131804205	40	40	5,60€
13156	OE:947098	40	40	3,30€
13157	OE:591740	40	40	3,85€
13158	OE:6384801G00	25	25	3,75€
13159	OE:9133417	20	20	3,20€
13160	OE:9133073	40	40	5,00€
13161	OE:3272075327462B	30	30	3,55€
13162	OE:327462A	20	20	2,60€
13163	OE:3923712	20	20	2,80€

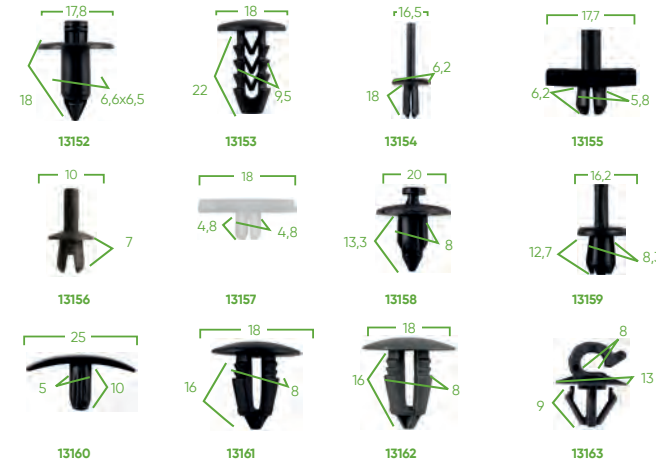

52889

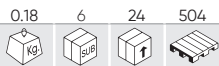

19,00€



TRUSĂ DE CLIPS DE PLASTIC VOLKSWAGEN 85 PCS

REF.	DESCRIERE		€
13038	OE:1H0868243B	2 2	1,40€
13039	OE:N90833801	10 10	1,65€
13040	OE:3A0853575	8 8	1,80€
13041	OE:4A0853825	5 5	1,55€
13042	OE:6U085733	15 15	1,95€
13043	OE:3B0853576	3 3	1,20€
13044	OE:1H0819055B01C	6 6	1,55€
13045	OE:443853909A	5 5	1,20€
13046	OE:171885767	6 6	1,55€
13047	OE:N9020160H	5 5	1,45€
13048	OE:NO385501	10 10	2,20€
13049	OE:191941142	10 10	2,05€

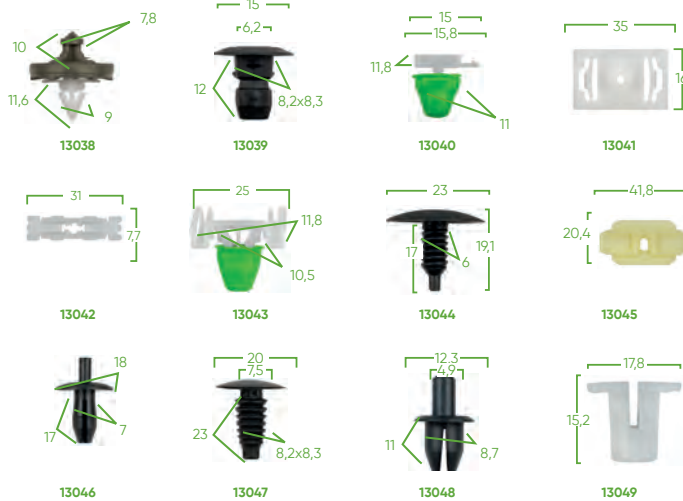

52891

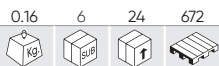

28,00€



TRUSĂ DE CLIPS DE PLASTIC FORD 169 PCS

REF.	DESCRIERE		€
13056	OE:388577S	8 8	1,55€
13057	OE:N801925S	5 5	1,50€
13058	OE:N806289S	20 20	2,20€
13059	OE:N379830S	20 20	2,35€
13060	OE:1007932	5 5	1,60€
13061	OE:16500308	20 20	2,65€
13062	OE:N803170S	20 20	2,35€
13063	OE:W706713S300	6 6	1,15€
13064	OE:N388246S	20 20	2,60€
13065	OE:F22Z16774A	15 15	2,00€
13066	OE:1673046	5 5	2,25€
13067	OE:F1CZ16674A	25 25	2,55€

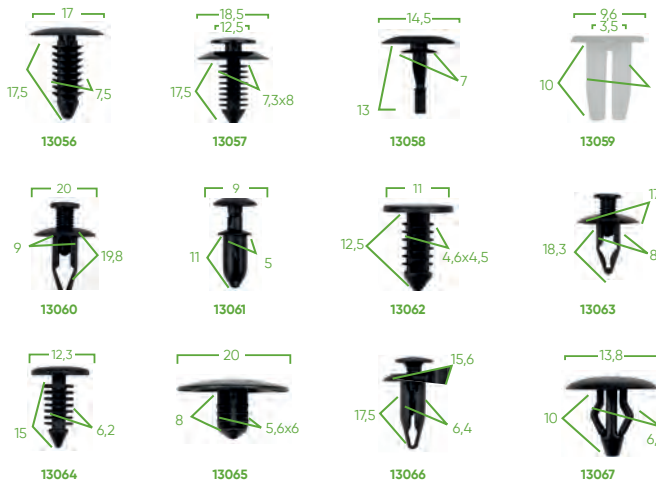

52894

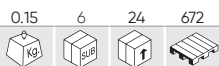

22,00€



TRUSĂ DE CLIPS DE PLASTIC NISSAN 139 PCS

REF.	DESCRIERE		€
13080	OE:76906T300	15 15	1,75€
13081	OE:0155300172	20 20	2,30€
13082	OE:68425H5000	10 10	1,35€
13083	OE:75521611000	6 6	1,50€
13084	OE:62869N4700	20 20	2,10€
13085	OE:6384401A00	5 5	1,60€
13086	OE:7688257A00	5 5	1,25€
13087	OE:6684101G00	25 25	3,30€
13088	OE:1099830880	10 10	2,40€
13089	OE:8942798070	10 10	1,70€
13090	OE:6384801G00	8 8	1,70€
13091	OE:6385401A00	5 5	1,25€



52890

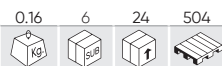

22,00€



TRUSĂ DE CLIPS DE PLASTIC AUDI 31 PCS

REF.	DESCRIERE		€
13050	OE:3B0868243	5 15	1,55€
13051	OE:1H0867199A	5 20	1,50€
13052	OE:1H0868243B	3 3	1,25€
13053	OE:357853575	10 10	2,80€
13054	OE:1H0853585A	5 5	2,35€
13055	OE:3A0853575	3 3	3,00€

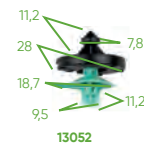

13052



13054

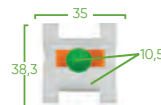

13055

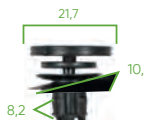

13050



13051



13053



52892

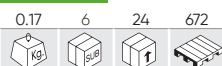

22,00€



TRUSĂ DE CLIPS DE PLASTIC BMW 95 PCS

REF.	DESCRIERE		€
13068	OE:51311802258	25 25	2,85€
13069	OE:5131804205	30 30	4,55€
13070	OE:51118174185	10 10	2,15€
13071	OE:51481938725	10 10	2,05€
13072	OE:703867299	15 15	2,75€
13073	OE:51131960054	5 5	2,10€



13068

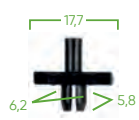

13069



13070



13071



13072

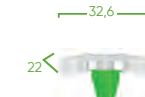

13073



52897

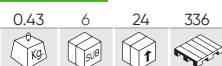

38,00€



TRUSĂ DE CLIPS DE PLASTIC RENAULT 300 PCS

REF.	DESCRIERE		€
13116	OE:7703077421	50 50	5,45€
13117	-	50 50	3,65€
13118	OE:7703081184	60 60	15,90€
13119	-	15 15	5,60€
13120	OE:7703074022	60 60	5,50€
13121	OE:7703077059	65 65	8,75€



13116

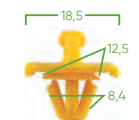

13117



13118

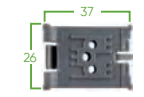

13119



13120

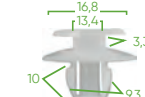

13121



52898



36,00€



TRUSĂ DE CLIPS DE PLASTIC VAUXHALL / OPEL 300 PCS

REF.	DESCRIERE		€
13122	OE:90218614	20 20	1,95€
13123	OE:174864	40 40	5,35€
13124	OE:NO385501	100 100	8,20€
13125	OE:2345959	50 50	5,95€
13126	OE:2240582	50 50	1,55€
13127	OE:180942	40 40	5,60€



13122

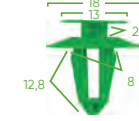

13123



13124

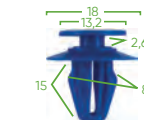

13125

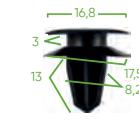

13126

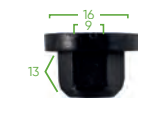

13127



52893

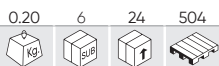

26,00€



TRUSĂ DE CLIPS DE PLASTIC BMW 95 PCS

REF.	DESCRIERE	Tray	Box	€
13074	OE:A0019884481	30	30	4,65€
13075	OE:A0019882981	20	20	5,35€
13076	OE:A1249900492	15	15	3,90€
13077	OE:A0019888081	4	4	2,55€
13078	OE:A1249880492	6	6	2,55€
13079	OE:A0019880325	20	20	3,35€

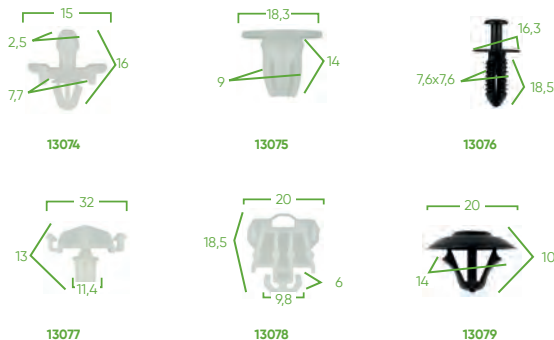

52895



22,00€



TRUSĂ DE CLIPS DE PLASTIC MITSUBISHI 134 PCS

REF.	DESCRIERE	Tray	Box	€
13092	OE:8942180270	15	50	1,65€
13093	OE:9018905013	30	30	2,95€
13094	OE:MU480033	10	10	1,50€
13095	OE:128100231	8	6	1,20€
13096	OE:MU480034	8	8	1,70€
13097	OE:MR138807	3	3	1,20€
13098	OE:MB253964	4	4	1,65€
13099	OE:HB121467	30	30	2,75€
13100	OE:MB271999	3	3	1,20€
13101	OE:MB696120	8	8	1,50€
13102	OE:MR200300	5	5	1,60€
13103	OE:MB846992	10	10	1,80€

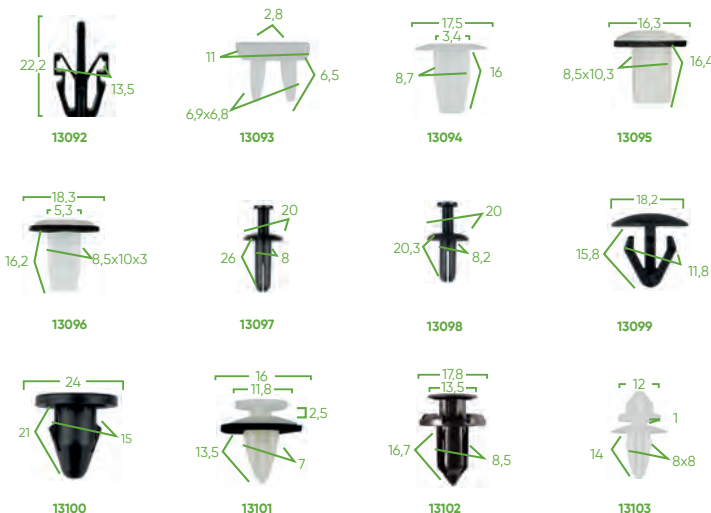

52888



24,00€



TRUSĂ DE CLIPS DE PLASTIC UNIVERSAL 128 PCS

REF.	DESCRIERE	Tray	Box	€
13026	OE:388577S	8	8	1,55€
13027	-	10	10	1,85€
13028	OE:6003423	6	6	1,45€
13029	OE:VW:N989022 CHRYSLER: 6003349 FORD:385661	6	6	1,65€
13030	OE:CHRYSLER: 6502328 GM:20699808	25	25	2,80€
13031	OE:N804379S	4	4	1,85€
13032	OE:FORD:F22Z16774A MAZDA:6508197AA	15	15	2,00€
13033	OE:GM:16674629 FORD:N806113S	10	10	1,60€
13034	OE:0153301781	20	20	2,65€
13035	OE:GM:10124502 BMW:52201964201 LAND ROVER:- DZM10080	6	6	1,65€
13036	OE:VW:N9020160H BMW:S1471904317 OPEL:2207713	6	6	1,40€
13037	-	12	12	2,10€

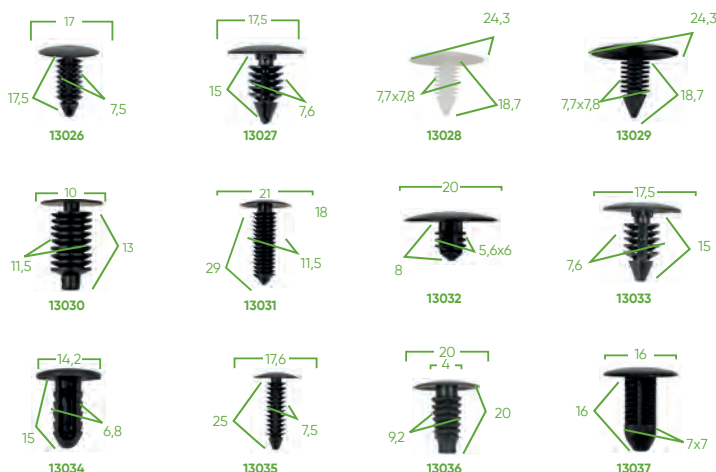

53720

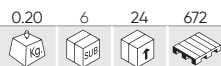

19,00€



TRUSĂ DE 112 BUC. CLIPSURI PENTRU TAPIȚERIE BMW MINI

REF.	DESCRIERE			€
14447	OE: 51471911992	7	6	1,45€
14449	OE: 51717002953	13	10	2,20€
14471	OE: 51489119216	5	5	1,90€
14472	OE: A0009905492	5	5	1,35€
14474	OE: 51118174185	8	8	1,50€
14475	OE: 2019900050	6	6	1,65€
14476	OE: 51481915964	9	9	2,05€
14477	OE: 0009881625	15	15	2,45€
14478	OE: 7146976114	15	15	4,05€
14479	OE: 91503SP0003	6	6	1,65€
14480	-	15	15	2,05€
14481	OE: 51161943122	8	8	1,70€

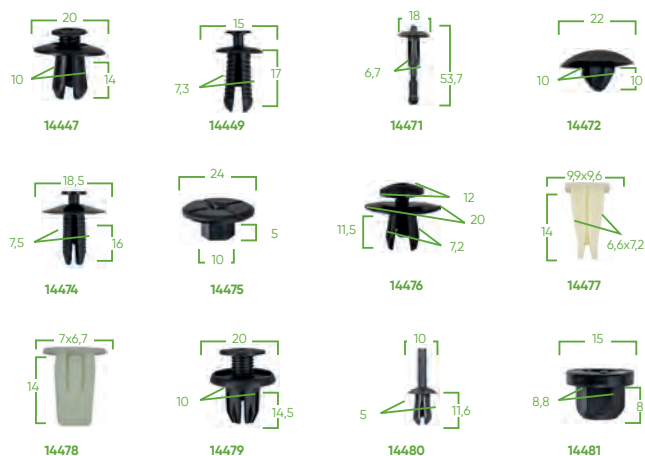

53719



19,00€



TRUSĂ DE 92 BUC. CLIPSURI PENTRU PANOURI DE UȘĂ/PANOU DEFLECTOR BMW MINI

REF.	DESCRIERE			€
14359	-	8	8	1,05€
14458	-	6	6	1,70€
14459	OE: 7147122912	2	2	1,45€
14460	OE: 51411973500	8	8	1,15€
14461	-	8	8	1,35€
14462	-	8	8	1,65€
14463	OE: 611769	10	10	1,65€
14464	OE: 7147145753	10	10	1,50€
14465	-	8	8	2,00€
14466	OE: 51418224768	8	4	1,65€
14468	-	8	8	1,30€
14469	OE: 7147133419	8	8	1,45€

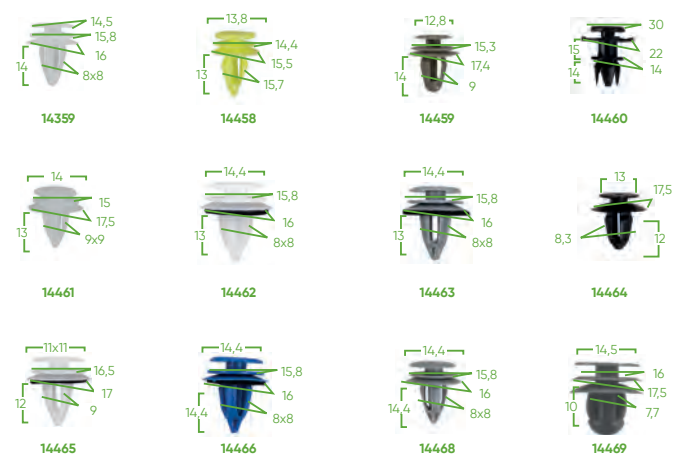

53718

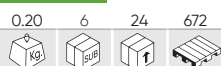

19,00€



TRUSĂ DE 151 BUC. CLIPSURI PENTRU TAPIȚERIE MERCEDES-BENZ

REF.	DESCRIERE			€
14422	OE: A0009913940	20	20	1,50€
14446	OE: 9903492	6	6	2,80€
14447	OE: 51471911992	12	12	1,45€
14448	OE: N105835019B9	10	10	2,05€
14449	OE: A0009905492	12	12	2,20€
14450	OE: N0385012	12	12	2,15€
14451	OE: A1239900092	25	25	2,15€
14452	-	20	20	2,55€
14453	-	6	6	3,05€
14455	-	12	12	2,10€
14456	-	6	6	1,35€
14457	OE: A1249900492	10	10	1,70€

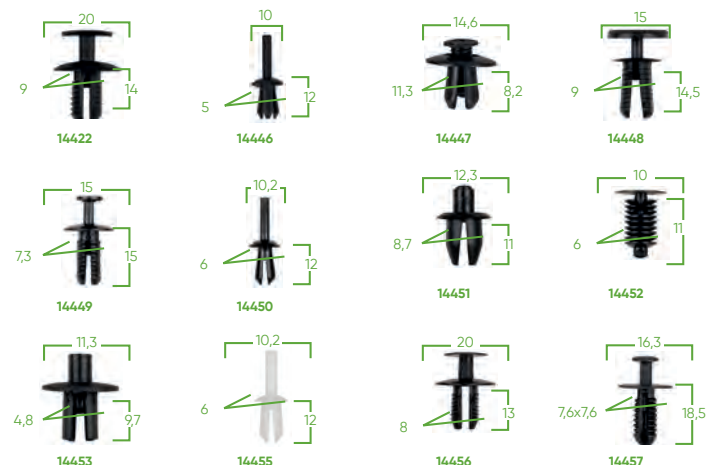

53717

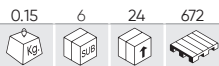

19,00€



TRUSĂ DE 96 BUC. CLIPSURI PENTRU PANOURI DE UȘĂ/PANOU DEFLECTOR MERCEDES-BENZ

REF.	DESCRIERE			€
14434	-	8	8	1,60€
14435	-	6	6	1,45€
14436	OE: A0009910198	8	8	1,70€
14437	OE: A0019912698	6	6	1,45€
14438	OE: A0089880978	8	8	1,35€
14439	OE: 0069884378	8	8	1,75€
14440	-	8	8	1,75€
14441	OE: 0019884981	10	10	1,65€
14442	-	6	6	1,45€
14443	-	8	8	1,45€
14444	OE: 0019886081	10	10	1,90€
14445	-	10	10	1,45€

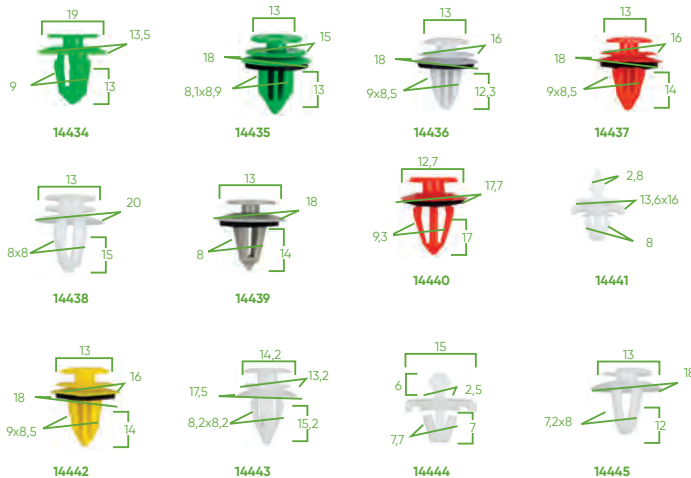

53716



19,00€



TRUSĂ DE 79 BUC. CLIPSURI PENTRU PANOURI DE UȘĂ/PANOU DEFLECTOR/ TAPIȚERIE VAG / SEAT / SKODA

REF.	DESCRIERE			€
14422	OE: A0009913940	6	6	1,50€
14423	OE: 6E0837732	15	15	3,55€
14424	-	7	7	1,85€
14425	OE: 6Q0868243	2	2	2,05€
14426	OE: 171201969	8	8	1,90€
14427	OE: 4D0807300	8	4	1,20€
14428	OE: 251823717	12	12	1,40€
14429	-	6	6	1,80€
14430	OE: 8E0821989A	3	3	2,25€
14431	OE: 3B0868243	2	2	1,45€
14432	OE: 1H0823171	10	10	1,45€

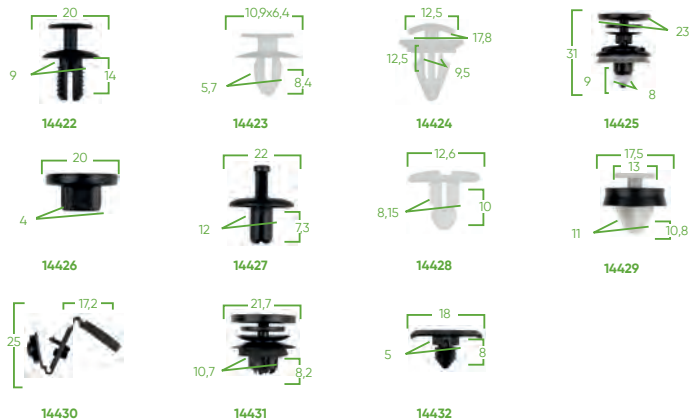

53715

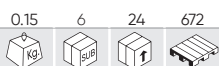

19,00€



TRUSĂ DE 110 BUC. CLIPSURI PENTRU TAPIȚERIE PEUGEOT / CITROËN

REF.	DESCRIERE			€
14410	-	10	10	1,85€
14411	-	10	5	1,70€
14412	-	10	10	1,70€
14413	-	10	10	3,25€
14414	OE: 2346824	10	10	1,70€
14415	OE: A1249900492	10	10	1,70€
14416	OE: 6992C6	10	5	1,25€
14419	-	15	15	1,95€
14420	-	15	15	1,50€
14421	OE: 14093311	10	10	2,45€



53714

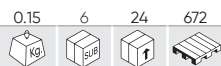

16,00€



TRUSĂ DE 80 BUC. CLIPSURI PENTRU PANOU DEFLECTOR PEUGEOT / CITROËN

REF.	DESCRIERE			€
14398	OE: 6995X3	8	8	1,30€
14399	OE: 129943	12	6	1,90€
14402	OE: 856548	8	8	1,50€
14404	OE: 71728806	8	8	2,10€
14405	OE: 968865987703	16	8	1,45€
14406	OE: 856540	10	10	1,55€
14408	OE: 856534	10	10	1,45€
14409	OE: 357853586	8	8	1,35€

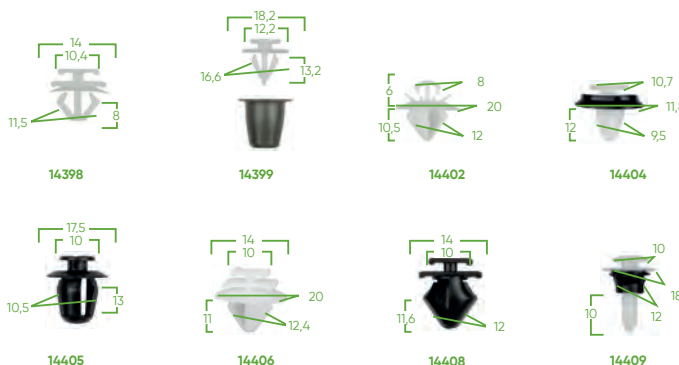

53713

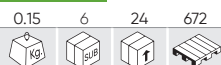

16,00€



TRUSĂ DE 93 BUC. CLIPSURI PENTRU PANOURI DE UȘĂ PEUGEOT/CITROËN

REF.	DESCRIERE			€
14350	OE: 6991Y8	6	6	1,80€
14358	OE: PG 6991Y8 CT 6991Y8 FIAT 9654280780 RENAULT 703077469	10	10	1,70€
14387	-	8	8	1,45€
14388	OE: 7703077250	8	8	2,05€
14389	OE: 6995A3	6	6	1,25€
14390	-	6	6	1,35€
14391	-	15	15	2,15€
14392	-	6	6	1,35€
14393	-	8	8	1,50€
14395	-	8	8	1,65€
14396	-	6	6	1,20€
14397	-	6	6	1,45€

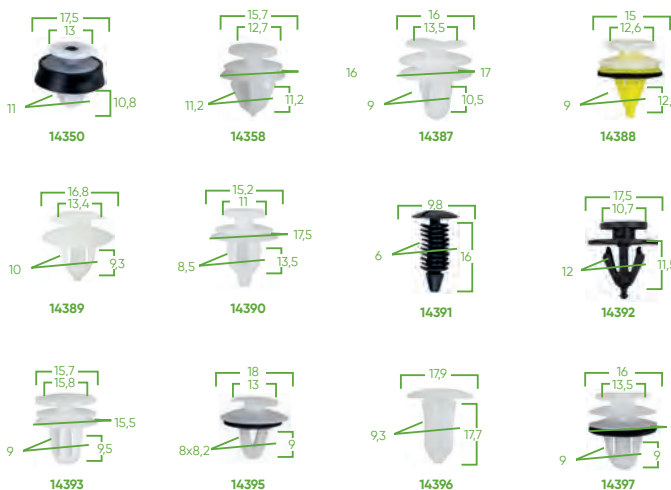

53712

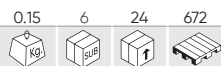

16,00€



TRUSĂ DE 109 BUC. CLIPSURI PENTRU TAPIȚERIE RENAULT DACIA

REF.	DESCRIERE			€
14374	OE: 7703077435	3	3	1,70€
14375	-	15	15	1,85€
14376	OE: 7L6868307	20	20	2,60€
14377	-	10	10	1,90€
14378	OE: 7703077117	12	12	1,90€
14379	-	6	6	1,45€
14381	-	10	10	1,70€
14382	OE: 7703077153	6	6	1,85€
14383	OE: 7703072360	10	10	1,35€
14384	OE: W705956S300	12	12	2,10€
14416	OE: 6992C6	5	5	1,25€



53711

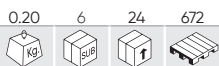

16,00€



TRUSĂ DE 90 BUC. CLIPSURI PENTRU PANOU DEFLECTOR RENAULT DACIA

REF.	DESCRIERE		€
14356	OE: RENAULT 7703077368 OPEL 4430858	10 10	1,90€
14358	OE: PG 6991Y8 CT 6991Y8 FIAT 9654280780 RENAULT 703077469	12 10	1,70€
14364	OE: OP 7701470779 NI 7703077421 RENAULT 7703077421 IV 500326896	10 10	1,90€
14365	OE: OP 7701470779 NI 7703077421 RENAULT 7703077421 IV 500326896	10 10	1,90€
14366	OE: PG 6991Y8 CT 6991Y8 FIAT 9654280780 RENAULT 703077469	8 8	1,45€
14367	-	3 3	1,30€
14368	OE: 7L5853994	8 8	1,45€
14369	OE: 7701061797	15 15	4,95€
14370	-	3 3	3,00€
14371	-	3 3	3,00€
14372	-	4 4	1,20€
14373	-	4 4	1,35€



53710



16,00€



TRUSĂ DE 85 BUC. CLIPSURI PENTRU PANOURI DE UȘĂ RENAULT DACIA

REF.	DESCRIERE		€
14350	OE: 6991Y8	12 6	1,80€
14351	-	8 15	1,65€
14352	OE: 51447780135	7 7	1,30€
14353	OE: 7703077476	8 2	2,10€
14355	OE: 7703077354	8 8	1,70€
14356	OE: RENAULT 703077368 OPEL 4430858	10 4	1,90€
14357	OE: 7703077430	10 12	1,90€
14358	OE: PG 6991Y8 CT 6991Y8 FIAT 9654280780 RENAULT 703077469	10 6	1,70€
14359	OE: 51418224768	4 3	1,05€
14361	-	8 15	1,70€

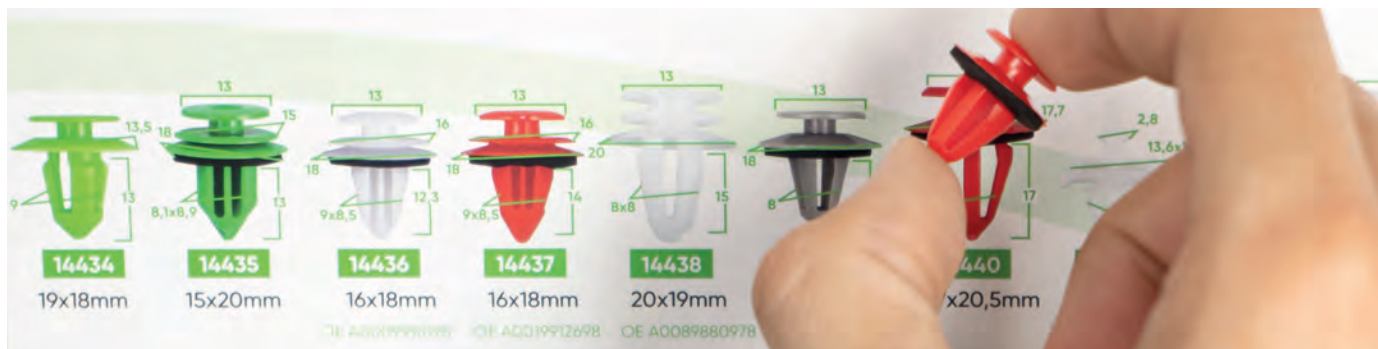
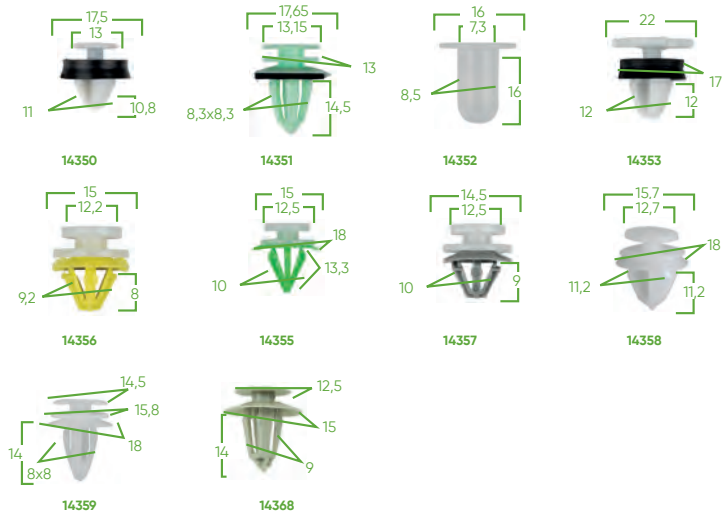

ÎMBRĂCĂMINTE DE LUCRU

406 VESTE

406 GEACHETE

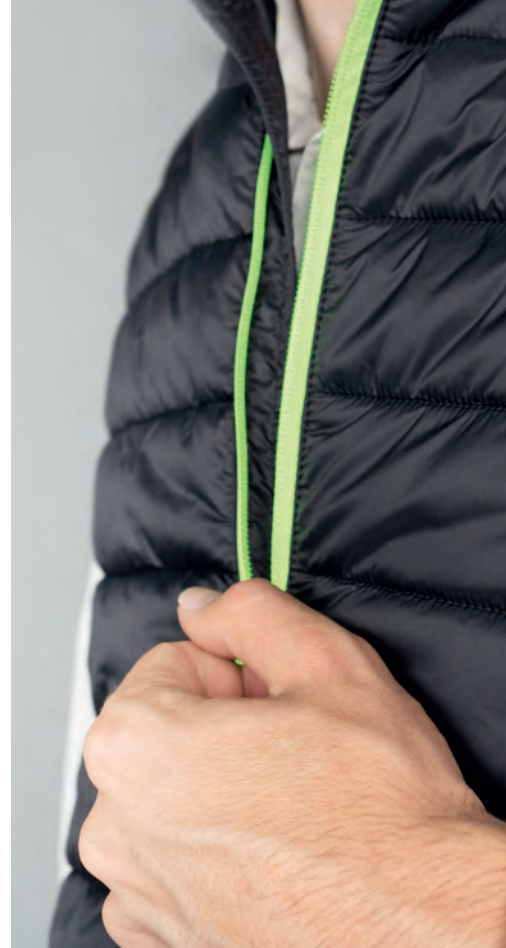



VESTĂ JBM



70001
70002
70003



70013
70014
70015
70016
70017



70009

REF.		■	■	■	📦	📦	📦	🚚	€
70001	M	●			0.30	-	5	200	35,00€
70002	L	●			0.40	-	5	200	35,00€
70003	XL	●			0.40	-	5	200	35,00€
70009	XL		●		0.40	-	5	180	35,00€
70013	S		●		0.30	-	10	240	44,00€
70014	M		●		0.30	-	10	240	44,00€
70015	L		●		0.30	-	10	240	44,00€
70016	XL		●		0.35	-	10	240	44,00€
70017	XXL		●		0.35	-	10	200	44,00€

GEACĂ JBM

70004
70005
70006



70011
70012

REF.		■	■	📦	📦	📦	🚚	€	
70004	M	●			0.60	-	5	140	42,00€
70005	L	●			0.70	-	5	140	42,00€
70006	XL	●			0.70	-	5	140	42,00€
70011	L		●		0.60	-	5	120	42,00€
70012	XL		●		0.70	-	5	120	42,00€

13929

3,45€



CÂRLIG PENTRU ÎMBRĂCĂMINTE 49 CM

490mm



METEXP

62,00€



EXPOZITOR



PROMOȚIONAL

408 PRODUSE PROMOȚIONALE

410 STANDURI / ACCESORII

412 AMBALARE



PRODUSE PROMOȚIONALE

53956

353,00€

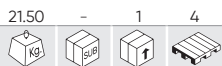

SCAUN ROTATIVE

DIMENSIUNI: 70x55x126-136cm

ÎNĂLȚIME REGLABILĂ

PERNĂ PENTRU REGIUNEA LOMBARĂ

TETIERE-PERNĂ



Material: PU
 Grosimea cadrului de fier: 1,2cm
 Scaun: spumă turnată
 Spătar: Spumă poliuretanică
 Cotieră: 2D
 Gazlift: Clasa 3
 Bază de nailon: 350mm



PIESE DISPONIBILE

54043

48,00€

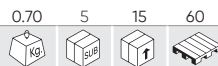

RUCSAC JBM

Spațiu de depozitare și buzunare: cu două compartimente, vă permite să depozitați, printre altele, laptopuri de până la 17,3 inci și calculatoare tablete."

Material:
 PU; rucsac impermeabil, durabil și fiabil.

Ușor și confortabil: Design confortabil la spate în formă de rețea și cu curele de burete.

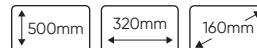

53973

284,00€



CORT PLIABIL 3X3M

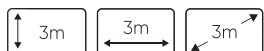

REF. DESCRIERE



14347 HUSĂ DE PROTECȚIE PENTRU STAND JBM 0.60 - 5 - 36,50€

15152

160,00€







LATERAL/P CORT STAND JBM 3X3M REF. 53973

Se compune din două părți:
 - Partea laterală care acoperă 3/4 părți ale cortului.
 - Partea frontală care acoperă 1/4 parte din cort. Cu fermoar vertical ca ușă.



54325 22,50€

2.30 - 10 120





COVORAS 100X65CM

N



54278 4,50€

0.10 5 200 1800





ȘAPCĂ JMB

N



54480 1,00€

0.00 500 2000 40000



BRELOC JMB

N



53949 4,50€

0.10 - 15 540





   

GEANTĂ DE RĂCIT JBM NEGRU



53950 4,50€

0.10 - 15 630





   

GEANTĂ DE RĂCIT JBM VERDE



13968 1,35€

0.01 50 200 2400

RUCSAC JBM



53533 1,50€

0.01 50 1000 12000





   

4 CULORI PEN PROMOȚIONAL JBM



54076 9,00€

0.50 - 50 700

CANA JBM



PRODUSE PROMOȚIONALE

53504

38,00€



SCUTER



14975

64,00€



SUPORT ȘUNCĂ



CÂRLIG

REF. PENTRU					€	
14034	UNELTE PNEUMMATICE	0.20	20	80	1920	9,00€
14623	REF. 60046, 60044, 60048, 60005, 60006	0.10	-	10	800	8,00€
14626	REF. 60023	0.10	-	10	-	7,00€
11318	CÂRLIG CU UN CAPĂT	0.04	20	600	-	2,50€
16364	CÂRLIG CU UN CAPĂT 280MM	0.20	-	200	-	3,50€
51315	CÂRLIG CU VÂRF INCHIS	0.02	20	320	44800	2,50€



14034



14623



14626



11318



16364



51315

JGHEAB

REF. PENTRU					€	
14622	REF. 60001, 60003, 60004, 60020	0.95	-	10	360	17,00€
14624	REF. 60007, 60010, 60011	0.65	-	10	300	17,00€
14625	REF. 60028, 60009	0.50	-	10	700	14,00€



14622



14624

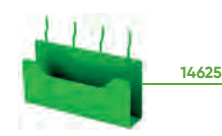

14625

53492

380,00€



EXPOZANT UNEALTĂ PNEUMATICĂ



LIVRAT FĂRĂ DISPOZITIVUL



METEXP

62,00€



EXPOZITOR



REF. DESCRIERE					€	
13929	CÂRLIG PENTRU ÎMBRĂCĂMINTE 49 CM	0.10	-	-	280	3,45€



53877

430,50€

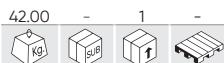

STAND PENTRU SCULE

53878

574,00€

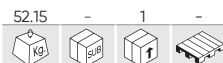

STAND PENTRU SCULE +
SUPPORT UȘOR

53879

838,50€



STAND PENTRU SCULE +
SUPPORT UȘOR ȘI UȘĂ

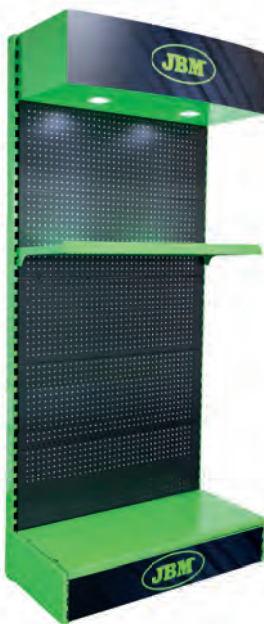

INCLUDE

14945	x1
14346	x1
14380	x1
11318	x20



INCLUDE

14945	x1
14947	x1
14380	x1
11318	x20



INCLUDE

14945	x1
14947	x1
14948	x1
14996	x1
11318	x20



PIESE EXPOZITOR DE UNELTE

REF.	DESCRIERE					€
14945	STAND PENTRU SCULE - BAZA	37.80	-	1	15	303,50€
14946	CAPAT PENTRU DULAP DE UNELTE	3.40	-	1	51	58,00€
14947	SUPPORT UȘOR STAND PENTRU SCULE	8.55	-	1	6	201,50€
14948	SET DE 2 UȘI PENTRU DULAP CU SCULE	31.10	-	1	40	251,50€
14380	TĂVIȚA SUPORT PENTRU SCULE 53877	5.00	-	1	34	51,00€
14996	TĂVIȚA SUPORT PENTRU SCULE CU UȘĂ	5.00	-	1	33	65,00€

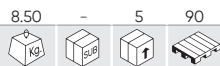

PRODUSE PROMOȚIONALE

53914
75,00€

POST DE SEPARARE CU BANDĂ RETRACTILĂ

- Material: oțel
- Diametrul conductatei: 63 mm
- Diametrul bazei: 320 mm
- Înălțime: 910 mm
- Bandă pe 4 laturi
- Lungime bandă: 3 m
- Lățime bandă: 48 mm

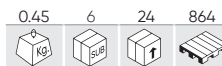
14807
11,00€

SEBILĂ DE GARANȚIE JBM



TOATE LIMBILE DIN ACELAȘI SIGILIU

- 75mm lat. x 125m lung.
- Fabricat din polipropilenă
- Adeziv solvent
- Grosime: 28 micrometri

CUTIE DE CARTON JBM

CUTIE PENTRU SCULE MANUALE DE REZERVĂ

REF. DESCRIERE				€
14922 CUTIE PENTRU PIESE DE SCHIMB 14,5X9X10CM	0.10	100	-	0,84€
14923 CUTIE PENTRU PIESE DE SCHIMB 17,5 X 9 X 7 CM	0.10	100	-	0,84€
14924 CUTIE PENTRU PIESE DE SCHIMB 24X11X7CM	0.10	100	-	0,84€
14925 CUTIE PENTRU PIESE DE SCHIMB 31,5X13X4CM	0.10	100	-	0,84€
14926 CUTIE PENTRU PIESE DE SCHIMB 32X8,5X7CM	0.10	100	-	1,05€



CUTIE PROMOȚIONAL

REF. DESCRIERE				€
13717 JBM HAM BOX 76X14X29CM	0.90	1	200	7,65€
14083 CUTIE CARTON VERDE PROMO 80X28X49CM	1.80	1	100	13,20€
14976 CUTIE DE CARTON, PROMOȚIONALĂ, 80X31X61 CM	2.20	1	80	18,84€
15056 CUTIE DE CARTON, PROMOȚIONALĂ, 40X30X61 CM	1.60	1	70	11,70€



CUTIE JBM

REF. DESCRIERE				€
11330 CUTIE CARTON MIC JBM 19X10X11CM (ȘANȚ)	0.05	50	4200	0,57€
12950 CUTIE CARTON JBM 60X40X30CM	0.80	15	75	3,45€
12952 CUTIE CARTON JBM 40X30X20CM	0.40	20	240	1,92€
13217 CUTIE CARTON JBM 57X30X25CM (TRUSE DE URGENȚĂ)	0.55	15	150	1,31€
14974 CUTIE CARTON JBM 54X24X40CM (20 DE SETURI DE GUSSET)	0.65	20	240	2,28€
15051 CUTIE DE CARTON 40X32X30 CM	0.40	20	160	1,92€
14189 CUTIE PALET AMERICAN CU CANAL TRIPLU	10.00	1	40	52,00€
14507 CUTIE PALET EUROPEAN	8.00	1	40	50,00€



CUPRINS

LOGISTICA



GREUTATE ÎN KILOGRAME



CANTITATE PE BAX



CANTITATE PE CUTIE



CANTITATE PE PALET



CANTITATE PE SAC



CANTITATE PE CUTIE



PREZENTARE DISPLAY

GENERALITĂȚI



NUMĂR DE BUCĂȚI



PREZENTARE ÎN BLISTER



MAGNETIZAT



TACTIL



CAPACITATEA DE ÎNCĂRCARE A BATERIEI



TIMP DE ÎNCĂRCARE



MĂNER ERGONOMIC



NU POT FI SPĂLATE



PROTEJEAZĂ DE PLOAIE ȘI UMIDITATE



PRODUS RECICLABIL



INFORMAȚII



WIRELESS



AUTOTURISM ELECTRIC



SEMNALIZARE DE ÎNALTĂ TENSIUNE



REGULAMENT EUROPEAN



REGLEMENTARE AMERICANĂ

UNIVERSAL

REGLEMENTARE UNIVERSALĂ

UNITĂȚI DE MĂSURĂ



LUNGIME



MASĂ



DIAMETRU



ALTE



CAPACITATE



ÎNCHIDERE



MAXIM - MINIM



DEGRADE



SUPRAFAȚĂ



GRADE CELSIUS



SUNETE

UNITĂȚI DE MĂSURĂ ELEMENTE SPECIFICE



DIAMETRU DISCUL



DIAMETRUL ALEZAJULUI DISCULUI ÎN "



DIAMETRUL TUBULUI



DIAMETRUL INTERIOR ȘI EXTERIOR AL ȚEVII



LUNGIMEA FURTUNULUI



LUNGIMEA FIȘEI

MATERIAL



LEMN



OȚEL



OȚEL S2



ALUMINIU



CUPRUL



CROM



CROM VANADIU



CROM MOLIBDEN



NEODIMUM



ZINC



CLORURĂ DE POLIVINIL



POLIPROPYLENE



POLIETILENĂ



POLIETILENĂ DE ÎNALTĂ DENSITATE



OȚEL LAMINAT



OPRESCU



LATEX



NYLON



CAUCIUC NITRIL BUTADIENIC HIDROGENAT

ȘI POTI GĂSI



MASONERIE



LEMN













OȚEL

SPECIFICAȚII TEHNICE

UNELTE MANUALE

BIȚI

 CAP PLAT	 ȘURUBURI PHILIPS	 CAP PHILLIPS	 TORQ BITS
 VÂRF ALLEN TORX	 CUATRI PUNTA	 TRI PUNTA	 ALLEN POINT
 TORX POINT	 VÂRF CU DOUĂSPREZECE MUCHII	 VÂRF PĂTRAT	 TORX CU CINCI VÂRFURI
 PUNCT CANELURĂ	 BURGHIE DUBLE CU FLUTURE	 BURGHIU ALLEN ANTIPERFORARE	 VÂRF TORX CU REZISTENȚĂ LA DETERIORARE
 VÂRF CU DOUĂSPREZECE MUCHII CU VÂRFURI DE SIGURANȚĂ	 VÂRF PĂTRAT CU VÂRF PĂTRAT INVIOLABIL	 BIT TORX CU CINCI VÂRFURI TORX CU CINCI VÂRFURI TORX INVIOLABIL	 PUNCT CANELURĂ INVIOLABIL
 BURGHIE DE TENSIONARE			

TUBULARE

 TUBULARA HEXAGONAL	 TUBULARA TORX	 TUBULARA CU DOUĂSPREZECE MUCHII	 TUBULARA PĂTRATĂ
 TUBULARA CU CINCI VÂRFURI	 TUBULARA SPLINE	 TUBULARA HEXAGONAL INVIOLABIL	 TUBULARA TORX INVIOLABIL
 TUBULARA DOUĂSPREZECE MUCHII INVIOLABIL	 TUBULAR PĂTRAT INVIOLABIL	 TUBULARA CU CINCI VÂRFURI INVIOLABIL	 TUBULARA SPLINE INVIOLABIL

CHEILE

 CHEIE HEXAGONALĂ	 CHEIE TORX	 CHEIE CU DOUĂSPREZECE MUCHII	 CHEI PĂTRATE
 CHEIE CU CINCI PUNCTE			











CLICHET

 24 DE DINȚI	 72 DE DINȚI	 90 DE DINȚI
---	---	---

UNELTE ELECTRICE

 WAȚI	 VOLTAJ	 HERTZ	 KILOVAT
 AMPERES	 CURENT ALTERNATIV	 CURENT DIRECT	 REZISTENȚĂ ELECTRICĂ
 BATERIE CU IONI DE LITIU	 USB MICROUSB	 PRIZĂ BRICHETĂ	

UNELTE PNEUMATICE

 LIRE PE INCH PĂTRAT (PRESIUNE)	 UNITATE DE PRESIUNE	 PICIOARE CUBICE PE MINUT (DEBIT)	 CAI PUTERE (PUTERE)
 ROTAȚII PE MINUT GENERAL	 ROTAȚII PE MINUT INVERS	 ROTAȚII PE MINUT ÎNAINTE	 NEWTON MAXIM PE METRU
 NEWTON PE METRU	 IMPULSURI PE MINUT	 KILOPASCAL	 MEGAPASCAL
 VOLUM MARE DE AER ȘI PRESIUNE SCĂZUTĂ	 IEȘIRE DIN SPATE	 CONECTABIL LA FURTUN	 INTRAREA DE AER
 CAPACITATE DE VITEZĂ	 SISTEM DE CIOCAN JUMBO	 MECANISM CU CIOCAN DUBLU	

INDEXUL NUMERIC

REF.	PAGINA	PREȚ
10000	305	7,00 €
10054	232	2,90 €
10055	232	3,90 €
10264	53	2,00 €
10485	231	8,10 €
10486	231	8,00 €
10494	231	6,50 €
10495	231	3,00 €
10496	231	3,00 €
10497	231	3,00 €
10498	231	3,00 €
10499	231	3,00 €
10500	231	3,00 €
10501	231	8,10 €
10502	231	3,50 €
10526	57	10,00 €
10531	41	3,00 €
10532	41	2,70 €
10533	41	3,00 €
10534	41	3,25 €
10535	41	3,50 €
10536	41	3,65 €
10537	41	3,90 €
10538	41	4,30 €
10539	41	4,75 €
10540	41	5,25 €
10541	41	5,55 €
10542	41	5,85 €
10543	41	7,00 €
10544	41	8,10 €
10545	41	9,75 €
10546	41	11,60 €
10547	41	13,50 €
10548	41	1,75 €
10549	41	2,00 €
10550	41	2,15 €
10551	41	2,15 €
10552	38	7,10 €
10553	38	7,35 €
10554	38	7,50 €
10555	38	7,80 €
10556	38	8,10 €
10557	38	8,10 €
10558	38	9,35 €
10559	38	9,50 €
10560	38	10,60 €
10561	38	11,00 €
10562	38	12,30 €
10563	38	12,50 €
10564	42	2,50 €
10565	42	3,50 €
10566	42	3,50 €
10567	42	3,50 €

REF.	PAGINA	PREȚ
10568	42	4,00 €
10569	42	4,50 €
10570	42	4,50 €
10571	42	5,00 €
10579	42	3,00 €
10580	42	3,10 €
10581	42	3,40 €
10582	42	4,00 €
10583	42	4,15 €
10584	42	5,05 €
10585	42	6,75 €
10586	42	7,60 €
10587	42	9,80 €
10588	42	10,50 €
10589	42	2,00 €
10590	42	2,40 €
10591	44	2,50 €
10592	44	2,55 €
10593	44	3,15 €
10594	44	3,20 €
10595	44	3,35 €
10596	44	4,25 €
10597	44	4,50 €
10598	44	4,60 €
10599	44	6,00 €
10600	44	6,25 €
10601	44	6,50 €
10602	44	7,05 €
10603	44	2,10 €
10604	44	2,25 €
10617	46	14,10 €
10618	46	15,10 €
10619	46	15,70 €
10620	46	16,20 €
10621	46	9,50 €
10622	46	10,00 €
10623	46	12,60 €
10624	46	13,50 €
10625	46	15,70 €
10626	46	17,80 €
10627	44	2,80 €
10628	44	3,10 €
10629	44	3,65 €
10630	44	3,90 €
10631	44	4,20 €
10632	44	5,30 €
10633	44	6,60 €
10634	44	7,80 €
10635	44	8,15 €
10636	44	8,80 €
10637	44	12,10 €
10638	44	12,70 €
10642	57	10,00 €

REF.	PAGINA	PREȚ
10643	57	10,00 €
10644	57	10,00 €
10672	242	9,50 €
10673	242	9,50 €
10674	242	9,50 €
10675	242	9,50 €
10732	89	18,70 €
10735	89	20,30 €
10750	139	13,00 €
10751	139	15,00 €
10766	139, 357	1,59 €
10772	386	0,05 €
10773	386	0,10 €
10774	386	0,10 €
10775	386	0,15 €
10776	386	0,20 €
10777	386	0,20 €
10778	386	0,35 €
10779	385, 386	0,05 €
10780	385, 386	0,05 €
10781	385, 386	0,05 €
10782	386	0,05 €
10783	386	0,05 €
10784	385, 386	0,05 €
10785	385, 386	0,10 €
10786	385, 386	0,15 €
10787	386	0,05 €
10788	386	0,05 €
10789	386	0,05 €
10790	386	0,05 €
10791	386	0,05 €
10792	386	0,05 €
10793	382	0,25 €
10794	382	0,40 €
10795	382	0,60 €
10796	382	0,07 €
10797	382	0,09 €
10798	382	0,12 €
10799	382	0,13 €
10800	382	0,15 €
10801	382	0,17 €
10802	382	0,19 €
10803	382	0,05 €
10804	382	0,22 €
10805	385	0,10 €
10812	385	0,30 €
10813	385	0,30 €
10823	388	0,20 €
10824	388	0,20 €
10825	388	0,20 €
10826	388	0,40 €
10827	388	0,60 €
10828	388	0,45 €

REF.	PAGINA	PREȚ
10829	388	0,20 €
10830	388	0,20 €
10831	388	0,20 €
10832	388	0,20 €
10833	388	0,20 €
10834	388	0,25 €
10835	388	0,25 €
10836	388	0,30 €
10837	388	0,30 €
10838	388	0,30 €
10839	388	0,40 €
10840	388	0,35 €
10868	390	0,30 €
10869	390	0,30 €
10870	390	0,45 €
10871	390	0,30 €
10872	390	0,40 €
10873	390	0,45 €
10874	390	0,30 €
10875	390	0,40 €
10876	390	0,45 €
10877	384	0,25 €
10878	384	0,30 €
10879	384	0,20 €
10880	384	0,20 €
10881	384	0,25 €
10882	382	0,25 €
10883	382	0,25 €
10884	382	0,25 €
10885	394	0,20 €
10886	394	0,20 €
10887	394	0,25 €
10888	394	0,30 €
10889	394	0,30 €
10890	394	0,35 €
10891	394	0,25 €
10892	394	0,30 €
10893	394	0,25 €
10894	394	0,20 €
10895	394	0,20 €
10896	394	0,30 €
10897	394	0,30 €
10898	394	0,30 €
10899	394	0,30 €
10900	394	0,30 €
10901	394	0,25 €
10902	394	0,30 €
10905	394	0,25 €
10906	394	0,25 €
10907	394	0,25 €
10908	394	0,30 €
10909	394	0,30 €
10910	394	0,30 €

REF.	PAGINA	PREȚ
10911	394	0,30 €
10912	394	0,25 €
10913	394	0,30 €
10914	394	0,25 €
10915	393, 394	0,25 €
10916	394	0,30 €
10917	393, 394	0,30 €
10918	393, 394	0,30 €
10919	393, 394	0,30 €
10920	393, 394	0,25 €
10921	393, 394	0,30 €
10923	134	1,10 €
10953	229	12,50 €
10955	200	11,00 €
10961	144	13,00 €
10964	190, 350	9,00 €
10965	190, 350	6,00 €
10966	190, 350	13,50 €
11103	139	6,00 €
11106	202	3,00 €
11107	144	4,50 €
11121	168, 169, 176	4,10 €
11122	168, 169, 176	5,45 €
11123	168, 176	6,50 €
11124	176	7,65 €
11125	176	8,50 €
11126	176	11,20 €
11127	176	13,80 €
11128	176	14,10 €
11129	176	14,10 €
11130	176	13,10 €
11131	176	14,10 €
11132	176	13,70 €
11133	176	12,00 €
11134	176	15,00 €
11135	176	17,20 €
11136	176	15,30 €
11137	176	18,20 €
11138	176	18,00 €
11139	176	18,80 €
11140	176	20,40 €
11141	176	18,60 €
11142	176	21,30 €
11143	176	26,40 €
11144	176	33,30 €
11145	176	35,30 €
11146	176	37,30 €
11147	176	41,00 €
11148	176	47,00 €
11149	176	45,00 €
11150	176	55,00 €
11151	176	57,00 €
11152	176	57,00 €
11153	172, 176	23,40 €
11154	176	21,70 €
11155	172, 176	24,40 €

REF.	PAGINA	PREȚ
11156	176	28,90 €
11157	176	26,60 €
11158	172, 176	28,50 €
11159	176	30,30 €
11160	176	27,00 €
11161	176	32,30 €
11162	176	29,10 €
11163	176	32,70 €
11164	176	30,70 €
11165	176	34,60 €
11166	176	30,90 €
11167	176	38,00 €
11168	176	41,00 €
11169	176	39,20 €
11170	176	40,00 €
11171	176	51,00 €
11172	176	48,00 €
11173	176	47,00 €
11174	176	47,00 €
11175	176	49,00 €
11176	176	56,00 €
11177	176	55,00 €
11178	176	53,00 €
11179	176	65,00 €
11180	176	59,00 €
11181	176	65,00 €
11182	176	73,00 €
11183	176	70,00 €
11184	176	87,00 €
11185	176	97,00 €
11186	176	91,00 €
11187	176	98,00 €
11188	176	103,00 €
11189	176	121,00 €
11190	176	138,00 €
11191	176	149,00 €
11192	176	152,00 €
11193	176	183,00 €
11194	176	176,00 €
11195	168, 169, 176	3,70 €
11212	63	5,00 €
11213	63	10,60 €
11214	63	12,50 €
11244	45	8,50 €
11245	45	9,15 €
11246	45	12,40 €
11247	45	14,00 €
11248	45	14,60 €
11249	45	26,50 €
11258	43	7,30 €
11259	43	8,30 €
11260	43	9,75 €
11261	43	11,35 €
11262	43	13,50 €
11314	173	8,50 €
11315	173	8,50 €
11316	173	8,50 €

REF.	PAGINA	PREȚ
11318	410	2,50 €
11324	139	17,50 €
11325	139	17,50 €
11328	355	4,00 €
11330	412	0,57 €
11360	32	2,60 €
11361	32	3,20 €
11362	32	5,20 €
11363	32	3,90 €
11364	32	4,50 €
11365	32	9,40 €
11374	200	5,50 €
11375	200	6,50 €
11376	200	5,50 €
11377	200	5,50 €
11378	200	6,50 €
11379	200	6,00 €
11380	200	6,50 €
11381	200	6,50 €
11382	200	6,00 €
11383	200	6,00 €
11384	200	6,00 €
11385	200	5,50 €
11386	200	6,00 €
11387	200	6,00 €
11388	200	6,00 €
11389	200	6,00 €
11390	200	6,00 €
11391	200	6,50 €
11392	200	6,00 €
11393	200	6,00 €
11394	200	6,00 €
11434	226	12,00 €
11435	226	12,00 €
11436	226	12,00 €
11437	226	12,00 €
11438	226	12,00 €
11439	226	12,00 €
11440	226	12,00 €
11441	226	12,00 €
11442	226	12,00 €
11443	227	14,00 €
11444	227	14,00 €
11445	227	15,00 €
11446	227	15,00 €
11447	227	15,50 €
11450	226	12,00 €
11541	180	11,00 €
11542	180	11,00 €
11543	180	11,00 €
11544	180	7,00 €
11545	180	11,00 €
11546	180	12,00 €
11547	180	12,00 €
11613	176	11,00 €
11614	176	13,00 €
11615	176	14,20 €

REF.	PAGINA	PREȚ
11616	176	18,10 €
11617	176	18,70 €
11618	176	18,80 €
11619	176	19,50 €
11621	176	290,00 €
11622	176	399,00 €
11623	176	489,00 €
11624	176	189,00 €
11625	176	282,00 €
11628	173	9,50 €
11639	43	4,00 €
11640	43	4,50 €
11641	43	5,00 €
11642	43	5,00 €
11643	43	6,00 €
11644	43	7,00 €
11645	43	7,00 €
11646	43	9,45 €
11867	308	9,00 €
11878	214	4,10 €
11879	214	5,10 €
11880	214	10,50 €
11890	359	0,55 €
11891	359	0,50 €
11893	211	7,00 €
11894	211	7,00 €
11895	211	8,65 €
11896	211	8,80 €
11897	190, 351	155,00 €
11900	370	3,50 €
11901	370	2,50 €
11902	370	3,50 €
11903	370	5,00 €
11904	370	2,00 €
11905	370	1,50 €
11906	370	8,50 €
11907	370	11,00 €
11936	202	4,00 €
11937	202	5,00 €
11938	174	47,00 €
11945	53	7,00 €
11946	53	4,50 €
11947	53	19,00 €
11956	152	5,50 €
11957	152	5,50 €
11959	189	10,50 €
11960	369, 370	1,50 €
11962	32, 168, 169, 175	7,50 €
11963	175	9,00 €
11964	32, 175	12,50 €
11965	175	16,00 €
11966	175	18,00 €
11967	175	18,00 €
11971	99	3,60 €
11974	339	1,80 €
11975	339	1,80 €
11976	339	1,80 €

REF.	PAGINA	PREȚ
11977	339	1,80 €
11978	339	1,80 €
11979	339	1,80 €
11980	339	1,80 €
11981	339	1,80 €
11982	339	1,80 €
11983	339	1,80 €
11989	144	2,00 €
11990	168, 169, 174	15,30 €
11994	89	33,00 €
11996	88	48,00 €
11997	88	39,00 €
11998	88	49,00 €
12009	162	11,00 €
12022	188	33,70 €
12029	35	5,50 €
12030	35	6,50 €
12044	305	147,00 €
12055	351	20,00 €
12060	64	2,50 €
12061	169, 170, 176	9,50 €
12062	169, 170, 176	9,50 €
12063	169, 170, 176	9,50 €
12064	169, 176	9,00 €
12065	169, 170, 176	9,00 €
12066	169, 170, 172, 176	9,00 €
12067	169, 176	9,50 €
12068	169, 170, 172, 176	9,50 €
12069	169, 170, 172, 176	9,50 €
12070	169, 170, 176	10,50 €
12071	169, 170, 176	11,00 €
12072	169, 176	12,00 €
12074	169, 174	11,50 €
12075	168, 169, 174	15,50 €
12093	226	12,00 €
12200	219	14,50 €
12901	207	5,20 €
12926	241	21,50 €
12927	241	21,50 €
12928	241	22,00 €
12929	241	23,00 €
12930	241	23,50 €
12931	171	7,50 €
12932	171	7,50 €
12933	171	8,00 €
12934	171	7,50 €
12935	171	8,00 €
12936	171	8,50 €
12937	168, 169, 174	9,50 €
12938	171	10,00 €
12939	171	10,00 €
12940	171	10,00 €
12941	171	10,00 €

REF.	PAGINA	PREȚ
12942	171	10,00 €
12943	171	10,00 €
12944	171	10,00 €
12945	171	10,50 €
12950	412	3,45 €
12952	412	1,92 €
12954	394	0,25 €
12955	180	27,80 €
12956	180	27,80 €
12957	180	27,80 €
12958	180	27,80 €
12959	180	27,80 €
12960	180	27,80 €
12961	180	27,80 €
12973	370	1,00 €
12974	196	21,00 €
12975	196	23,00 €
12977	221	36,50 €
12984	176	379,00 €
12987	152	1,50 €
12988	166	12,00 €
12995	53	7,00 €
12996	53	7,00 €
12997	53	7,50 €
12998	53	9,00 €
12999	53	9,50 €
13002	396	1,45 €
13003	396	1,70 €
13004	396	1,85 €
13005	396	1,25 €
13006	396	1,40 €
13007	396	1,30 €
13008	396	2,25 €
13009	396	1,65 €
13010	396	1,75 €
13011	396	1,15 €
13012	396	1,80 €
13013	396	1,75 €
13014	396	1,45 €
13015	396	1,20 €
13016	396	1,15 €
13017	396	2,60 €
13018	396	1,45 €
13019	396	1,75 €
13020	396	1,70 €
13021	396	1,30 €
13022	396	2,10 €
13023	396	1,50 €
13024	396	2,45 €
13025	396	1,50 €
13026	400	1,55 €
13027	400	1,85 €
13028	400	1,45 €
13029	400	1,65 €
13030	400	2,80 €
13031	400	1,85 €
13032	400	2,00 €

REF.	PAGINA	PREȚ
13033	400	1,60 €
13034	400	2,65 €
13035	400	1,65 €
13036	400	1,40 €
13037	400	2,10 €
13038	398	1,40 €
13039	398	1,65 €
13040	398	1,80 €
13041	398	1,55 €
13042	398	1,95 €
13043	398	1,20 €
13044	398	1,55 €
13045	398	1,20 €
13046	398	1,55 €
13047	398	1,45 €
13048	398	2,20 €
13049	398	2,05 €
13050	399	1,55 €
13051	399	1,50 €
13052	399	1,25 €
13053	399	2,80 €
13054	399	2,35 €
13055	399	3,00 €
13056	398	1,55 €
13057	398	1,50 €
13058	398	2,20 €
13059	398	2,35 €
13060	398	1,60 €
13061	398	2,65 €
13062	398	2,35 €
13063	398	1,15 €
13064	398	2,60 €
13065	398	2,00 €
13066	398	2,25 €
13067	398	2,55 €
13068	399	2,85 €
13069	399	4,55 €
13070	399	2,15 €
13071	399	2,05 €
13072	399	2,75 €
13073	399	2,10 €
13074	400	4,65 €
13075	400	5,35 €
13076	400	3,90 €
13077	400	2,55 €
13078	400	2,55 €
13079	400	3,35 €
13080	398	1,75 €
13081	398	2,30 €
13082	398	1,35 €
13083	398	1,50 €
13084	398	2,10 €
13085	398	1,60 €
13086	398	1,25 €
13087	398	3,30 €
13088	398	2,40 €
13089	398	1,70 €

REF.	PAGINA	PREȚ
13090	398	1,70 €
13091	398	1,25 €
13092	400	1,65 €
13093	400	2,95 €
13094	400	1,50 €
13095	400	1,20 €
13096	400	1,70 €
13097	400	1,20 €
13098	400	1,65 €
13099	400	2,75 €
13100	400	1,20 €
13101	400	1,50 €
13102	400	1,60 €
13103	400	1,80 €
13104	396	1,90 €
13105	396	2,50 €
13106	396	2,00 €
13107	396	2,15 €
13108	396	1,90 €
13109	396	2,90 €
13110	396	1,85 €
13111	396	1,20 €
13112	396	1,65 €
13113	396	2,20 €
13114	396	2,20 €
13115	396	2,50 €
13116	399	5,45 €
13117	399	3,65 €
13118	399	15,90 €
13119	399	5,60 €
13120	399	5,50 €
13121	399	8,75 €
13122	399	1,95 €
13123	399	5,35 €
13124	399	8,20 €
13125	399	5,95 €
13126	399	1,55 €
13127	399	5,60 €
13128	397	1,85 €
13129	397	2,00 €
13130	397	3,75 €
13131	397	3,45 €
13132	397	2,65 €
13133	397	3,45 €
13134	397	3,95 €
13135	397	3,45 €
13136	397	2,60 €
13137	397	2,25 €
13138	397	2,85 €
13139	397	3,85 €
13140	397	2,65 €
13141	397	1,80 €
13142	397	3,10 €
13143	397	1,95 €
13144	397	2,20 €
13145	397	3,85 €
13146	397	4,50 €

REF.	PAGINA	PREȚ
13147	397	3,10 €
13148	397	3,30 €
13149	397	3,10 €
13150	397	2,25 €
13151	397	5,35 €
13152	397	3,05 €
13153	397	3,10 €
13154	397	3,20 €
13155	397	5,60 €
13156	397	3,30 €
13157	397	3,85 €
13158	397	3,75 €
13159	397	3,20 €
13160	397	5,00 €
13161	397	3,55 €
13162	397	2,60 €
13163	397	2,80 €
13217	412	1,31 €
13226	67	4,50 €
13227	67	4,50 €
13228	67	4,50 €
13229	67	4,50 €
13230	67	4,50 €
13231	67	4,50 €
13232	67	4,50 €
13234	305	224,50 €
13235	384	0,15 €
13236	384	0,15 €
13237	384	0,15 €
13238	384	0,20 €
13239	384	0,20 €
13240	384	0,40 €
13241	384	0,55 €
13447	40	16,50 €
13448	40	17,50 €
13449	40	20,00 €
13450	40	23,00 €
13451	40	28,00 €
13452	40	29,50 €
13453	39	9,00 €
13454	39	9,50 €
13455	39	10,50 €
13456	39	11,50 €
13457	39	12,00 €
13460	39	15,00 €
13462	39	17,00 €
13463	40	5,30 €
13464	40	5,30 €
13465	38, 39, 40	5,55 €
13466	38, 39, 40	5,55 €
13467	38, 39, 40	6,00 €
13468	38, 39, 40	6,25 €
13469	38, 39, 40	6,25 €
13470	38, 39, 40	6,60 €
13471	38, 39, 40	6,90 €
13472	38, 39, 40	7,25 €
13473	38, 39, 40	8,10 €

REF.	PAGINA	PREȚ
13474	38, 39, 40	8,70 €
13475	38, 39, 40	9,10 €
13476	38, 39, 40	9,60 €
13477	40	9,85 €
13478	40	12,20 €
13479	40	13,10 €
13480	40	15,50 €
13481	40	15,80 €
13482	40	22,10 €
13483	40	25,50 €
13484	40	27,20 €
13491	40	5,30 €
13492	40	5,35 €
13493	40	5,50 €
13494	40	6,00 €
13495	40	6,40 €
13496	40	6,60 €
13497	40	7,50 €
13498	40	8,50 €
13499	162	12,50 €
13500	162	12,90 €
13667	66, 89	17,60 €
13668	88	18,70 €
13674	68, 383	0,50 €
13675	68, 383	0,50 €
13676	68, 383	0,50 €
13677	68, 383	0,50 €
13678	68, 383	0,50 €
13680	174	15,50 €
13681	174	15,50 €
13682	174	15,50 €
13683	174	15,50 €
13684	174	15,50 €
13685	174	15,50 €
13686	174	15,50 €
13687	174	15,50 €
13688	174	15,50 €
13689	174	15,50 €
13704	69	21,00 €
13707	59	14,00 €
13708	59	14,00 €
13709	59	14,00 €
13710	59	14,00 €
13712	59	14,00 €
13717	412	7,65 €
13723	176	18,50 €
13724	176	19,20 €
13725	176	19,20 €
13726	176	19,00 €
13727	176	18,70 €
13728	176	18,50 €
13729	176	22,00 €
13730	176	22,00 €
13731	176	21,60 €
13732	176	23,80 €
13733	176	24,90 €
13734	176	25,70 €

REF.	PAGINA	PREȚ
13735	176	25,80 €
13736	176	25,90 €
13738	360	3,50 €
13739	360	5,50 €
13740	360	5,50 €
13741	372	21,00 €
13745	176	25,20 €
13746	176	25,40 €
13747	176	25,40 €
13748	176	24,90 €
13805	370	10,50 €
13806	370	10,50 €
13809	166	18,50 €
13810	166	20,50 €
13813	185	7,00 €
13814	185	11,00 €
13817	151	17,00 €
13818	151	20,50 €
13819	388	6,50 €
13820	388	7,00 €
13821	388	14,00 €
13822	388	11,00 €
13823	388	6,00 €
13824	388	8,00 €
13825	388	11,50 €
13826	388	13,00 €
13827	388	15,00 €
13828	388	11,50 €
13829	388	10,50 €
13830	388	10,50 €
13831	388	12,60 €
13832	388	13,00 €
13833	388	9,00 €
13839	144	8,50 €
13842	180	8,50 €
13843	180	7,00 €
13844	180	9,00 €
13845	180	8,00 €
13856	202	7,80 €
13859	172	16,00 €
13874	172	17,50 €
13875	172	18,50 €
13876	172	18,50 €
13877	172	18,50 €
13879	360	1,38 €
13880	360	1,50 €
13923	89	7,45 €
13929	406, 410	3,45 €
13930	165	1,50 €
13931	165	2,50 €
13932	165	2,50 €
13933	165	2,00 €
13934	165	2,50 €
13935	165	2,50 €
13936	165	3,50 €
13937	165	4,00 €
13938	165	3,50 €

REF.	PAGINA	PREȚ
13939	165	4,00 €
13945	387	7,40 €
13946	387	6,70 €
13947	387	5,85 €
13948	387	5,00 €
13949	387	6,50 €
13950	387	7,80 €
13951	387	5,15 €
13952	387	10,90 €
13953	387	8,00 €
13954	387	12,70 €
13955	387	4,95 €
13956	387	4,30 €
13957	387	9,70 €
13958	387	5,45 €
13959	387	10,10 €
13960	387	9,65 €
13961	387	9,25 €
13962	387	1,76 €
13963	387	12,40 €
13964	387	15,00 €
13965	387	1,50 €
13966	387	12,90 €
13967	387	4,65 €
13968	409	1,35 €
13969	204	19,00 €
13982	303	4,00 €
14004	171	9,50 €
14005	171	10,50 €
14006	171	9,50 €
14007	171	9,50 €
14008	171	9,50 €
14009	171	9,50 €
14010	171	11,00 €
14011	171	11,00 €
14013	152	3,50 €
14026	53	5,50 €
14027	53	5,60 €
14029	53	8,50 €
14030	53	9,50 €
14031	131, 144	7,90 €
14032	144	12,00 €
14033	144	4,50 €
14034	410	9,00 €
14049	237	8,00 €
14050	237	10,50 €
14051	237	18,00 €
14052	237	19,50 €
14075	165	2,00 €
14076	165	1,50 €
14077	165	4,50 €
14078	165	4,00 €
14083	412	13,20 €
14114	89	19,30 €
14118	365	26,00 €
14120	146	22,00 €
14121	146	26,00 €

REF.	PAGINA	PREȚ
14122	148	34,00 €
14123	148	33,00 €
14124	150	20,50 €
14125	150	19,50 €
14126	153	54,00 €
14127	155	32,50 €
14129	151	12,50 €
14130	151	21,00 €
14131	149	24,00 €
14133	155	16,50 €
14135	155	12,50 €
14136	152	12,00 €
14137	159	131,00 €
14145	328	8,50 €
14146	328	8,00 €
14147	328	25,00 €
14148	328	25,00 €
14153	149	20,50 €
14154	153	42,00 €
14157	161	8,30 €
14158	161	9,95 €
14159	161	12,60 €
14160	161	12,80 €
14161	161	13,70 €
14162	153	25,50 €
14163	153	25,50 €
14164	153	25,50 €
14165	146	26,50 €
14167	70	2,50 €
14168	160	7,00 €
14169	163	3,00 €
14172	173	8,50 €
14173	173	9,50 €
14177	173	9,50 €
14178	173	9,50 €
14179	58	8,50 €
14180	58	7,90 €
14183	68	31,00 €
14187	219	6,00 €
14188	160	0,50 €
14189	412	52,00 €
14190	165	2,00 €
14191	165	2,00 €
14192	165	4,00 €
14193	165	4,00 €
14195	166	4,00 €
14196	166	4,00 €
14197	166	4,50 €
14198	166	4,00 €
14199	166	4,00 €
14200	166	4,50 €
14201	165	4,00 €
14202	165	4,00 €
14203	165	4,50 €
14204	165	1,50 €
14205	165	1,50 €
14206	165	1,50 €

REF.	PAGINA	PREȚ
14207	165	1,50 €
14208	165	1,50 €
14209	165	1,50 €
14211	237	11,00 €
14212	237	12,00 €
14213	237	12,00 €
14214	237	14,00 €
14286	153	2,99 €
14287	153	2,99 €
14288	153	6,00 €
14289	153	6,10 €
14296	74, 75, 76, 77, 83	118,00 €
14297	74, 75, 76, 77, 83	87,00 €
14298	74, 75, 76, 77, 83	51,50 €
14299	74, 75, 76, 77, 83	87,00 €
14300	220	19,00 €
14301	220	19,00 €
14314	166	5,00 €
14315	166	4,50 €
14330	153	3,50 €
14336	149	58,00 €
14340	237	10,50 €
14341	237	10,50 €
14342	237	10,50 €
14343	237	10,50 €
14344	237	11,00 €
14345	237	11,00 €
14346	237	11,00 €
14347	408	36,50 €
14348	212	12,50 €
14349	212	20,50 €
14350	403, 404	1,80 €
14351	404	1,65 €
14352	404	1,30 €
14353	404	2,10 €
14354	90	14,00 €
14355	404	1,70 €
14356	404	1,90 €
14357	404	1,90 €
14358	403, 404	1,70 €
14359	401, 404	1,05 €
14361	404	1,70 €
14364	404	1,90 €
14365	404	1,90 €
14366	404	1,45 €
14367	404	1,30 €
14368	404	1,45 €
14369	404	4,95 €
14370	404	3,00 €
14371	404	3,00 €
14372	404	1,20 €
14373	404	1,35 €
14374	403	1,70 €
14375	403	1,85 €
14376	403	2,60 €
14377	403	1,90 €

REF.	PAGINA	PREȚ
14378	403	1,90 €
14379	403	1,45 €
14380	411	51,00 €
14381	403	1,70 €
14382	403	1,85 €
14383	403	1,35 €
14384	403	2,10 €
14387	403	1,45 €
14388	403	2,05 €
14389	403	1,25 €
14390	403	1,35 €
14391	403	2,15 €
14392	403	1,35 €
14393	403	1,50 €
14395	403	1,65 €
14396	403	1,20 €
14397	403	1,45 €
14398	403	1,30 €
14399	403	1,90 €
14402	403	1,50 €
14404	403	2,10 €
14405	403	1,45 €
14406	403	1,55 €
14408	403	1,45 €
14409	403	1,35 €
14410	402	1,85 €
14411	402	1,70 €
14412	402	1,70 €
14413	402	3,25 €
14414	402	1,70 €
14415	402	1,70 €
14416	402, 403	1,25 €
14419	402	1,95 €
14420	402	1,50 €
14421	402	2,45 €
14422	401, 402	1,50 €
14423	402	3,55 €
14424	402	1,85 €
14425	402	2,05 €
14426	402	1,90 €
14427	402	1,20 €
14428	402	1,40 €
14429	402	1,80 €
14430	402	2,25 €
14431	402	1,45 €
14432	402	1,45 €
14434	402	1,60 €
14435	402	1,45 €
14436	402	1,70 €
14437	402	1,45 €
14438	402	1,35 €
14439	402	1,75 €
14440	402	1,75 €
14441	402	1,65 €
14442	402	1,45 €
14443	402	1,45 €
14444	402	1,90 €

REF.	PAGINA	PREȚ
14445	402	1,45 €
14446	401	2,80 €
14447	401	1,45 €
14448	401	2,05 €
14449	401	2,20 €
14450	401	2,15 €
14451	401	2,15 €
14452	401	2,55 €
14453	401	3,05 €
14455	401	2,10 €
14456	401	1,35 €
14457	401	1,70 €
14458	401	1,70 €
14459	401	1,45 €
14460	401	1,15 €
14461	401	1,35 €
14462	401	1,65 €
14463	401	1,65 €
14464	401	1,50 €
14465	401	2,00 €
14466	401	1,65 €
14468	401	1,30 €
14469	401	1,45 €
14471	401	1,90 €
14472	401	1,35 €
14474	401	1,50 €
14475	401	1,65 €
14476	401	2,05 €
14477	401	2,45 €
14478	401	4,05 €
14479	401	1,65 €
14480	401	2,05 €
14481	401	1,70 €
14507	412	50,00 €
14534	161	16,50 €
14560	161	8,80 €
14561	166	8,80 €
14563	214	18,00 €
14564	183	9,20 €
14565	183	26,70 €
14566	183	16,70 €
14567	183	38,00 €
14568	183	9,20 €
14569	183	9,20 €
14570	183	4,05 €
14571	183	9,20 €
14573	183	4,05 €
14578	92	12,50 €
14580	92	41,00 €
14583	148	6,00 €
14594	221, 389	2,00 €
14595	221, 389	1,50 €
14596	221, 389	2,00 €
14597	221, 389	7,60 €
14598	221, 389	17,80 €
14599	221, 389	4,50 €
14600	221, 389	9,50 €

REF.	PAGINA	PREȚ
14601	221, 389	11,00 €
14602	221, 389	11,00 €
14611	240	12,00 €
14612	240	11,00 €
14613	240	13,50 €
14616	321	96,00 €
14618	147	19,00 €
14622	123, 410	17,00 €
14623	123, 410	8,00 €
14624	123, 410	17,00 €
14625	123, 410	14,00 €
14626	123, 410	7,00 €
14633	147	22,50 €
14710	183	3,50 €
14711	183	3,75 €
14712	183	4,00 €
14713	183	4,25 €
14714	183	4,50 €
14715	183	4,75 €
14723	172	18,00 €
14724	172	18,50 €
14725	172	18,50 €
14726	172	17,50 €
14728	168, 169, 176	3,80 €
14729	168, 169, 176	3,80 €
14730	168, 169, 176	3,80 €
14731	168, 169, 176	3,80 €
14732	168, 169, 176	3,80 €
14733	168, 169, 176	4,30 €
14734	168, 169, 176	5,40 €
14735	169	6,50 €
14736	170, 176	5,00 €
14737	170, 176	5,00 €
14738	170, 176	5,50 €
14739	170, 176	5,50 €
14740	170, 176	5,55 €
14741	170, 176	5,55 €
14742	170, 176	5,55 €
14743	170, 176	5,15 €
14744	170, 176	5,35 €
14745	170, 176	6,25 €
14746	170, 176	6,40 €
14747	170, 176	7,10 €
14748	170, 176	8,30 €
14749	32, 175	2,00 €
14750	32, 175	2,00 €
14751	32, 175	4,00 €
14752	32, 175	4,00 €
14753	143	13,00 €
14771	164, 338	10,50 €
14772	164	8,50 €
14774	338	10,50 €
14775	380	30,50 €
14779	150	33,00 €
14781	377	990 €

REF.	PAGINA	PREȚ
14783	92	5,50 €
14793	378	12,00 €
14803	380	43,00 €
14807	412	11,00 €
14825	123	1,50 €
14826	123	1,50 €
14827	123	2,00 €
14828	123	1,50 €
14829	123	1,50 €
14830	123	1,50 €
14831	123	1,50 €
14832	123	2,00 €
14833	123	2,05 €
14834	123	2,50 €
14835	123	3,00 €
14836	123	3,50 €
14837	123	3,30 €
14838	123	3,40 €
14839	123	4,70 €
14840	123	3,35 €
14841	124	2,58 €
14842	124	9,50 €
14843	125	0,50 €
14844	125	0,50 €
14845	125	0,50 €
14846	125	0,50 €
14847	125	0,50 €
14848	125	0,50 €
14849	125	1,00 €
14850	125	1,00 €
14851	125	1,00 €
14852	125	1,00 €
14853	125	1,00 €
14854	125	1,00 €
14855	125	1,00 €
14856	125	1,00 €
14857	125	1,50 €
14858	125	1,50 €
14859	125	1,50 €
14860	125	2,00 €
14861	125	2,00 €
14862	125	2,00 €
14863	125	2,50 €
14864	125	2,50 €
14865	125	2,50 €
14866	125	3,00 €
14867	125	3,00 €
14868	125	0,55 €
14869	125	0,60 €
14870	125	1,00 €
14871	125	1,00 €
14872	125	1,00 €
14873	125	1,00 €
14874	125	1,00 €
14875	125	1,50 €
14876	125	1,50 €
14877	125	1,50 €

REF.	PAGINA	PREȚ
14878	125	2,00 €
14879	125	2,00 €
14880	125	2,50 €
14881	125	2,50 €
14882	125	3,00 €
14883	125	3,50 €
14884	125	3,65 €
14885	125	4,00 €
14886	125	4,60 €
14887	125	5,00 €
14888	125	6,00 €
14889	125	6,50 €
14890	125	7,00 €
14891	125	7,50 €
14892	125	8,00 €
14893	128	2,00 €
14894	128	1,20 €
14895	128	1,90 €
14896	128	2,10 €
14897	128	0,88 €
14898	128	0,98 €
14899	128	0,88 €
14900	128	0,98 €
14901	124	3,60 €
14902	124	4,65 €
14903	124	5,25 €
14904	124	6,85 €
14905	124	8,50 €
14906	124	10,20 €
14907	124	0,50 €
14908	124	0,60 €
14909	124	0,80 €
14910	124	1,00 €
14911	124	1,30 €
14912	124	1,55 €
14913	124	1,90 €
14914	124	2,10 €
14915	124	2,65 €
14916	124	2,95 €
14917	124	3,45 €
14920	123	2,50 €
14922	412	0,84 €
14923	412	0,84 €
14924	412	0,84 €
14925	412	0,84 €
14926	412	1,05 €
14930	204	9,50 €
14931	204	8,00 €
14932	204	9,50 €
14933	204	9,50 €
14934	124	4,25 €
14935	124	8,45 €
14945	411	303,50 €
14946	411	58,00 €
14947	411	201,50 €
14948	411	251,50 €
14950	116	6,50 €

REF.	PAGINA	PREȚ
14951	116	9,50 €
14952	116	19,00 €
14953	116	8,50 €
14970	168	2,50 €
14971	168	2,50 €
14972	168	3,50 €
14973	168, 169	11,50 €
14974	412	2,28 €
14975	410	64,00 €
14976	412	18,84 €
14978	53	7,50 €
14979	53	9,00 €
14980	53	13,00 €
14981	53	22,50 €
14982	53	27,50 €
14985	128	6,00 €
14986	128	4,00 €
14987	128	8,50 €
14988	128	8,00 €
14989	128	6,00 €
14990	128	10,50 €
14991	128	2,00 €
14992	200	8,50 €
14993	128	5,00 €
14994	128	3,50 €
14995	128	8,00 €
14996	411	65,00 €
15010	97	16,50 €
15011	97	18,00 €
15012	97	31,50 €
15014	127	20,00 €
15023	92	12,50 €
15024	92	15,00 €
15025	92	12,50 €
15026	92	15,00 €
15030	92	8,00 €
15033	92	6,00 €
15034	92	57,00 €
15035	92	8,50 €
15036	92	8,50 €
15037	92	8,00 €
15038	92	34,50 €
15040	92	12,50 €
15041	92	15,00 €
15042	92	7,50 €
15049	117	37,40 €
15050	92	9,50 €
15051	412	1,92 €
15052	219	3,00 €
15053	219	10,50 €
15054	219	34,00 €
15056	412	11,70 €
15058	92	7,50 €
15059	378	10,00 €
15062	378	1,00 €
15065	92	6,50 €
15068	90	15,20 €

REF.	PAGINA	PREȚ
15069	90	32,80 €
15070	82	0,50 €
15071	82	0,60 €
15072	82	0,70 €
15073	82	1,00 €
15074	82	1,00 €
15075	82	1,20 €
15076	82	3,50 €
15083	88	8,50 €
15084	88, 203, 307	68,00 €
15093	317	38,00 €
15094	317	39,50 €
15095	317	13,00 €
15096	317	40,00 €
15122	39, 75, 85	74,00 €
15138	51	10,50 €
15139	51	12,00 €
15140	51	13,50 €
15144	93	30,00 €
15145	94	20,45 €
15146	94	16,20 €
15147	50	5,00 €
15148	50	5,00 €
15149	50	5,00 €
15152	408	160,00 €
15155	75, 85	59,00 €
15156	43, 85	70,00 €
15157	85	42,00 €
15158	85	59,00 €
15159	85	44,00 €
15160	85	42,00 €
15161	75, 85	62,00 €
15162	36, 87, 345	30,20 €
15206	43	15,00 €
15207	43	16,50 €
15208	43	17,00 €
15209	43	18,00 €
15227	36	3,50 €
15228	36	4,00 €
15229	36	5,00 €
15230	36	5,00 €
15231	36	3,50 €
15232	36	4,00 €
15233	36	5,00 €
15234	36	3,00 €
15253	222, 225	62,00 €
15300	369	5,00 €
15313	90	14,00 €
15315	86	28,20 €
15316	39, 86	58,00 €
15317	369	4,50 €
15328	39	6,00 €
15329	39	5,50 €
15330	39	5,50 €
15331	39	5,50 €
15332	39	6,00 €
15333	39	6,50 €

REF.	PAGINA	PREȚ
15334	39	7,00 €
15335	39	7,50 €
15336	39	8,00 €
15337	39	8,50 €
15338	39	9,00 €
15339	39	9,50 €
15375	183	28,00 €
15385	135	18,00 €
15448	343	5,50 €
15454	57, 86	35,40 €
15460	343	5,00 €
15494	200	12,50 €
15495	200	12,50 €
15496	200	11,50 €
15497	200	11,00 €
15498	200	11,50 €
15499	200	11,00 €
15500	200	10,00 €
15501	200	10,00 €
15502	200	10,00 €
15503	200	11,00 €
15504	200	10,00 €
15505	200	4,00 €
15506	200	4,00 €
15507	200	4,50 €
15508	200	4,50 €
15509	200	5,00 €
15510	200	5,00 €
15511	200	8,00 €
15514	75, 86	9,35 €
15515	39	15,50 €
15516	39	19,00 €
15517	39	22,50 €
15541	86	27,60 €
15552	190, 351	181,00 €
15564	148	11,90 €
15619	355	4,00 €
15631	303	98,00 €
15632	38	9,00 €
15633	38	9,50 €
15634	38	11,00 €
15635	38	12,50 €
15636	38	14,00 €
15637	38	15,00 €
15681	85	134,00 €
15706	63, 86	31,00 €
15730	78, 84	289,00 €
15731	78, 84	214,00 €
15732	78, 84	293,50 €
15733	78, 84	113,00 €
15734	78, 84	288,50 €
15735	78, 84	152,00 €
15736	78, 84	488,50 €
15737	66, 86	45,00 €
15783	65	3,50 €
15784	65	3,50 €
15785	65	3,50 €

REF.	PAGINA	PREȚ
15786	65	3,50 €
15787	65	3,50 €
15799	63, 87	28,30 €
15866	350	32,00 €
15874	310	6,50 €
16010	46	4,00 €
16011	46	4,00 €
16012	46	4,00 €
16013	46	4,50 €
16014	46	4,50 €
16015	46	5,00 €
16016	46	5,00 €
16017	46	5,00 €
16018	46	5,50 €
16019	46	6,00 €
16020	41	17,00 €
16021	41	19,50 €
16022	41	23,00 €
16023	41	26,50 €
16024	41	34,50 €
16025	41	37,50 €
16052	137, 144	2,09 €
16053	137, 144	2,85 €
16111	61, 87	19,20 €
16130	343	290,00 €
16161	91	17,50 €
16162	91	35,10 €
16163	91	10,20 €
16188	91	39,60 €
16198	343	5,00 €
16237	237	23,00 €
16238	237	23,00 €
16239	237	23,00 €
16240	237	26,00 €
16241	237	23,00 €
16242	237	26,00 €
16243	237	23,00 €
16273	150	12,50 €
16294	395	14,00 €
16295	206	30,00 €
16300	227	7,60 €
16301	227	7,60 €
16302	227	7,60 €
16304	172	31,00 €
16305	172	31,00 €
16309	220	149,00 €
16316	221	18,50 €
16318	126	0,50 €
16319	126	0,50 €
16320	126	0,50 €
16321	126	1,00 €
16322	126	1,00 €
16323	126	1,00 €
16324	126	1,50 €
16325	126	1,50 €
16326	126	2,00 €
16327	126	2,00 €

REF.	PAGINA	PREȚ
16328	126	2,50 €
16329	126	3,00 €
16330	126	3,50 €
16331	126	3,50 €
16332	126	4,00 €
16333	126	4,50 €
16334	126	5,50 €
16335	126	6,00 €
16336	126	6,50 €
16341	147	32,50 €
16342	65	2,50 €
16343	65	2,50 €
16344	90	43,00 €
16354	90	1,50 €
16355	90	2,00 €
16356	90	2,50 €
16357	90	2,50 €
16358	90	12,00 €
16359	90	10,00 €
16360	90	12,00 €
16361	90	16,50 €
16362	90	20,00 €
16363	90	14,50 €
16364	123, 410	3,50 €
16366	206	11,00 €
16367	206	10,00 €
16368	206	12,00 €
16369	206	12,00 €
16370	206	12,00 €
16371	206	11,00 €
16372	206	11,50 €
16373	206	12,00 €
16374	206	12,00 €
16375	206	15,00 €
16376	206	15,00 €
16377	206	16,00 €
16378	206	15,00 €
16379	206	15,00 €
16380	206	16,00 €
16381	206	10,00 €
16382	206	10,00 €
16383	206	15,00 €
16384	206	15,00 €
16385	242	10,00 €
16386	242	11,50 €
16387	92	10,50 €
16388	242	11,50 €
16389	242	11,50 €
16391	39	4,60 €
16392	39	4,60 €
16393	39	4,60 €
16394	39	5,10 €
16395	39	5,10 €
16396	39	5,10 €
16397	39	5,50 €
16398	39	5,50 €
16399	39	5,50 €

REF.	PAGINA	PREȚ
16400	259	6,50 €
16401	39	6,10 €
16402	39	6,10 €
16403	39	6,10 €
16430	233	20,50 €
16431	233	20,50 €
16432	233	20,50 €
16433	233	20,50 €
16434	233	20,50 €
16435	233	21,50 €
16436	233	21,50 €
16448	222	16,50 €
16462	389	36,50 €
16463	389	36,50 €
16464	389	36,50 €
16465	389	39,50 €
16466	389	50,00 €
16467	389	36,50 €
16468	389	36,50 €
16469	389	36,50 €
16470	389	39,50 €
16471	389	50,00 €
16472	389	17,50 €
16473	389	17,50 €
16474	389	17,50 €
16475	389	17,50 €
16476	389	24,00 €
16477	389	24,50 €
16478	389	24,50 €
16479	389	7,50 €
16480	389	7,50 €
16481	93	14,00 €
16482	93	13,50 €
16490	73	650,00 €
16491	73	307,00 €
16492	73	675,00 €
16493	73	436,00 €
16494	73	139,00 €
16496	73	127,00 €
16497	73	77,00 €
16498	73	84,00 €
16499	73	162,00 €
16500	73	463,00 €
16516	73	121,00 €
16538	389	19,50 €
16539	389	18,00 €
16540	389	13,00 €
16541	389	13,00 €
16542	389	23,50 €
16543	389	13,00 €
16546	43	5,00 €
16547	43	5,50 €
16548	43	9,00 €
16549	43	14,00 €
16561	73	36,50 €
16564	147	17,00 €
16565	233	19,50 €

REF.	PAGINA	PREȚ
16566	233	22,50 €
16571	172	32,00 €
16572	172	33,50 €
16574	172	34,00 €
16575	172	34,50 €
16576	172	35,50 €
16577	172	36,00 €
16583	126	8,50 €
16584	126	10,50 €
16585	126	11,50 €
16586	126	13,00 €
16587	126	14,00 €
16588	126	15,00 €
16600	73	252,00 €
16627	73	225,00 €
16628	73	382,00 €
16629	73	419,00 €
16642	65	1,00 €
16737	226	12,00 €
50400	191	168,00 €
50403	191	98,00 €
50409	192	26,00 €
50410	191	168,00 €
50431	357	3,80 €
50517	350	129,00 €
50518	350	169,00 €
50523	357	4,70 €
50524	357	4,70 €
50525	365	1,00 €
50526	365	4,80 €
50551	357	350,00 €
50562	44	23,50 €
50564	42	30,00 €
50567	57	9,60 €
50577	186	12,60 €
50585	361	14,70 €
50600	368	0,60 €
50601	368	0,29 €
50622	46	64,00 €
50623	21	60,00 €
50630	324	590,00 €
50631	322	68,00 €
50632	335	298,00 €
50644	359	11,60 €
50651	391	18,00 €
50652	391	16,50 €
50654	354	4,00 €
50656	190, 351	290,00 €
50717	359	21,90 €
50724	69	28,00 €
50731	217	68,00 €
50751	156, 312	43,00 €
50760	368	0,10 €
50761	368	0,19 €
50762	368	0,29 €
50763	368	0,38 €
50764	368	0,49 €

REF.	PAGINA	PREȚ
50765	368	0,58 €
50766	368	0,68 €
50767	368	0,78 €
50768	368	0,88 €
50778	368	0,10 €
50779	368	0,19 €
50780	368	0,29 €
50781	368	0,38 €
50782	368	0,49 €
50783	368	0,58 €
50784	368	0,68 €
50785	368	0,78 €
50786	368	0,88 €
50787	98	8,00 €
50788	98	14,50 €
50789	98	29,00 €
50792	236	105,00 €
50793	236	94,00 €
50797	349	490,00 €
50807	221, 391	38,00 €
50808	99	77,00 €
50815	314	88,00 €
50816	315	88,00 €
50818	314	198,00 €
50819	316	28,00 €
50820	316	34,50 €
50821	316	47,00 €
50822	316	59,00 €
50823	316	94,00 €
50824	316	88,00 €
50825	316	154,00 €
50827	223, 321	387,00 €
50830	317	560,00 €
50831	322	460,00 €
50835	319	290,00 €
50836	323	148,00 €
50838	323	299,00 €
50839	320	180,00 €
50840	322	138,00 €
50843	99	79,00 €
50844	99	65,00 €
50852	312	24,50 €
50901	181	16,00 €
50902	54	13,00 €
50903	181	30,80 €
50910	142	45,00 €
50911	324	788,00 €
50913	190, 351	195,00 €
50915	357	4,20 €
50916	192	0,88 €
50917	305	271,00 €
50918	304	341,00 €
50923	188, 320	454,00 €
50924	308, 351	342,00 €
50935	304	595,00 €
50937	69	10,50 €
50942	331, 344	28,00 €

REF.	PAGINA	PREȚ
50957	95	22,00 €
50959	95, 386	14,00 €
50966	354	4,00 €
50966C	354	3,00 €
50980	34	22,00 €
50982	34	22,00 €
50983	30	48,00 €
50985	30	59,00 €
51017	56	6,80 €
51018	56	7,05 €
51020	56	6,65 €
51021	56	7,05 €
51028	172	163,00 €
51033	339	98,00 €
51035	94	799,00 €
51050	95	285,00 €
51051	95	34,80 €
51055	368	0,98 €
51059	195	99,00 €
51119	229	62,00 €
51120	213	41,00 €
51121	222	27,30 €
51123	229	91,00 €
51124	241	88,00 €
51125	238	88,00 €
51126	234	18,00 €
51127	52	56,00 €
51127R	52	14,00 €
51131	180	61,00 €
51140	240	64,00 €
51206	146	228,00 €
51207	146	289,00 €
51210	148	650,00 €
51211	148	560,00 €
51212	148	488,00 €
51213	148	690,00 €
51214	150	148,00 €
51215	150	119,00 €
51216	153	650,00 €
51218	155	288,00 €
51220	151	240,00 €
51221	151	199,00 €
51222	149	128,00 €
51226	155	233,00 €
51235	329	49,00 €
51238	328	138,00 €
51239	328	159,00 €
51245	155	99,00 €
51246	358	6,40 €
51253	305	41,00 €
51258	134	0,15 €
51259	231	58,00 €
51260	29	37,00 €
51262	52	51,00 €
51262R	52	14,00 €
51266	359	28,00 €
51272	62	7,50 €

REF.	PAGINA	PREȚ
51277	157	64,00 €
51283	196	78,00 €
51305	50	28,90 €
51306	50	28,10 €
51307	50	29,70 €
51315	410	2,50 €
51318	38	98,00 €
51326	134	4,40 €
51332	200	98,00 €
51333	32	18,00 €
51336	173	29,30 €
51337	204	50,00 €
51338	52	53,00 €
51338R	52	14,00 €
51340	296	39,30 €
51341	163	35,00 €
51347	230	9,90 €
51349	242	37,30 €
51352	201	9,80 €
51353	201	11,50 €
51354	202	13,20 €
51355	60, 369	19,00 €
51356	308	48,00 €
51358	371	7,50 €
51359	371	9,00 €
51360	181	8,05 €
51361	181	9,80 €
51362	371	3,00 €
51363	328	114,00 €
51364	221	26,00 €
51365	328	118,00 €
51368	224	19,00 €
51369	224	28,00 €
51383	157	11,10 €
51385	162	4,55 €
51386	162	5,95 €
51387	162	3,25 €
51388	153	22,00 €
51389	153	22,00 €
51390	153	22,00 €
51391	153	22,00 €
51392	153	34,00 €
51393	153	34,00 €
51398N	375	1,54 €
51400	204	17,00 €
51401	204	22,00 €
51402	204	20,50 €
51403	204	17,50 €
51405	50	21,10 €
51406	50	29,20 €
51409	33	36,00 €
51410	33	36,00 €
51412	364	2,10 €
51414	224	14,00 €
51416	47	12,00 €
51419	91	2,79 €
51422	91	2,97 €

REF.	PAGINA	PREȚ
51439	153	26,00 €
51440	153	28,00 €
51441	153	26,00 €
51442	153	28,00 €
51443	162	5,50 €
51444	162	5,05 €
51445	162	5,05 €
51447	53, 87	16,00 €
51448	53, 87	52,00 €
51452	322	69,00 €
51479	53	31,80 €
51488	273	16,00 €
51489	284	12,00 €
51490	225	36,00 €
51491	230	154,00 €
51493	207	68,00 €
51494	205	107,00 €
51495	232	59,00 €
51496	236	8,00 €
51500	240	29,00 €
51501	233	38,00 €
51504	63	8,50 €
51525	62	9,80 €
51526	62	9,80 €
51528	44	49,00 €
51538	388	0,15 €
51539	388	0,15 €
51540	388	0,15 €
51541	388	0,25 €
51542	388	0,20 €
51543	388	0,25 €
51544	388	0,25 €
51545	388	0,30 €
51546	389	0,19 €
51554	389	0,28 €
51573	134	2,50 €
51574	95	52,00 €
51575	96	317,00 €
51576	93	125,00 €
51600	96	109,00 €
51604	368	0,98 €
51612	357	5,95 €
51613	357	2,90 €
51614	357	3,60 €
51615	357	5,95 €
51616	23	378,00 €
51622	192	25,30 €
51632N	375	1,54 €
51633	375	1,54 €
51634	375	1,54 €
51636N	375	1,54 €
51638N	375	1,54 €
51640N	375	1,54 €
51642N	375	1,54 €
51653	91	5,10 €
51654	91	4,80 €
51655	91	4,10 €

REF.	PAGINA	PREȚ
51656	91	3,65 €
51657	91	5,85 €
51658	91	4,50 €
51659	46	59,00 €
51661	47	12,00 €
51674	63	7,75 €
51692	355	3,55 €
51693	355	3,55 €
51694	355	3,55 €
51696	355	3,55 €
51697	364	0,80 €
51703	359	10,50 €
51705	359	8,45 €
51706	366	22,80 €
51707	366	9,05 €
51708	366	14,20 €
51709	366	14,70 €
51710	366	17,80 €
51711	366	21,20 €
51712	366	8,65 €
51713	366	13,10 €
51714	366	15,80 €
51715	366	20,30 €
51716	366	23,60 €
51717	366	11,20 €
51718	366	14,80 €
51719	366	22,00 €
51720	366	23,50 €
51721	366	25,00 €
51722	366	13,10 €
51723	366	18,70 €
51724	366	24,40 €
51725	366	28,30 €
51726	366	31,40 €
51727	366	49,00 €
51737	94	699,00 €
51738	93	850,00 €
51741	370	0,50 €
51742	370	0,50 €
51743	370	0,55 €
51745	376	0,70 €
51746	34	12,00 €
51751	320	99,00 €
51785	376	1,00 €
51795	47	9,00 €
51796	47	14,00 €
51797	47	18,00 €
51798	47	39,60 €
51799	389	0,20 €
51801	51	62,00 €
51804	386	58,00 €
51805	53, 87	17,00 €
51812	56	46,00 €
51814	369	8,00 €
51816	329	58,00 €
51817	354	4,50 €
51818	18	109,00 €

REF.	PAGINA	PREȚ
51824	192	36,80 €
51830	52	94,00 €
51831	339	24,00 €
51832	181	18,00 €
51837	336	195,00 €
51838	336	667,00 €
51839	198	24,00 €
51842	330	6,90 €
51843	389	0,19 €
51853	70	18,00 €
51855	23	378,00 €
51858	364	15,00 €
51859	339	3,80 €
51861	159, 359	199,00 €
51863	366	54,00 €
51864	45, 87	64,00 €
51886	142	44,00 €
51889	130	49,00 €
51890	46	92,00 €
51895	315	99,00 €
51896	235	82,00 €
51897	235	122,00 €
51898	235	139,00 €
51899	235	137,00 €
51901	319	999,00 €
51902	229	84,00 €
51905	316	34,50 €
51906	316	39,00 €
51907	316	48,00 €
51908	368	44,00 €
51909	65	2,46 €
51918	63	12,50 €
51919	228	89,00 €
51920	234, 392	18,00 €
51923	201	12,50 €
51925	365	1,00 €
51927	296	25,00 €
51928	308	14,00 €
51929	143	22,00 €
51934	201	11,50 €
51935	354	135,00 €
51936	354	135,00 €
51937	354	135,00 €
51951	70	15,60 €
51958	228	422,00 €
51960	138	34,00 €
51961	138	34,00 €
51962	138	25,00 €
51963	138	29,00 €
51964	138	28,00 €
51965	138	29,50 €
51966	139	18,00 €
51967	144	16,00 €
51968	144	16,00 €
51969	139	14,00 €
51972	60	12,00 €
51973	366	45,00 €

REF.	PAGINA	PREȚ
51975	91	2,27 €
51976	91	1,63 €
51978	191	84,00 €
51980	156	15,00 €
51981	157	21,50 €
51982	349	120,00 €
51983	349	185,00 €
51984	349	190,00 €
51985	191	84,00 €
51986	234	11,90 €
51989	216	49,00 €
51991	230	54,00 €
51995	58, 59	24,50 €
51998	226	38,00 €
52010	239	80,00 €
52012	228	68,00 €
52016	235	2,10 €
52017	235	2,40 €
52018	235	2,60 €
52019	235	3,20 €
52021	235	3,40 €
52022	235	4,50 €
52023	235	6,60 €
52024	235	10,60 €
52025	235	13,00 €
52026	181	31,80 €
52027	382	14,00 €
52028	385	15,20 €
52029	385	14,00 €
52030	388	98,00 €
52031	387	44,00 €
52032	386	28,00 €
52033	390	43,00 €
52043	384	16,50 €
52044	382	19,00 €
52047	357	3,30 €
52048	357	3,95 €
52049	66	14,00 €
52050	59	98,00 €
52052	57	53,00 €
52053	394	45,00 €
52054	394	17,00 €
52055	322	139,00 €
52056	242	66,00 €
52057	191	6,80 €
52058	191	4,50 €
52059	35	29,00 €
52060	35	32,00 €
52065	191	45,00 €
52066	218	12,00 €
52069	328	29,50 €
52070	328	40,00 €
52071	328	47,00 €
52076	211	111,00 €
52077	183	29,50 €
52148	99	65,00 €
52149	349	230,00 €

REF.	PAGINA	PREȚ
52152	60	13,50 €
52153	227	46,00 €
52156	149	140,00 €
52157	155	48,00 €
52158	386	38,50 €
52159	151	64,00 €
52160	151	48,00 €
52162	79, 338, 346	38,00 €
52163	388	95,00 €
52165	149	118,00 €
52167	150	48,00 €
52169	55	25,00 €
52170	55	16,00 €
52171	155	39,00 €
52180	63	19,00 €
52181	63	22,50 €
52182	63	24,00 €
52183	63	26,20 €
52184	63	43,00 €
52185	63	55,00 €
52186	63	72,00 €
52187	364	21,80 €
52188	63	15,50 €
52190	216	8,00 €
52191	197	198,00 €
52195	334	170,00 €
52197	50	36,30 €
52198	32	37,70 €
52200	351	88,00 €
52202	351	88,00 €
52207	50	24,20 €
52227	223	247,00 €
52230	190, 350	398,00 €
52231	330	49,00 €
52233	330	328,00 €
52235	48	11,00 €
52236	48	13,30 €
52237	48	18,10 €
52238	48	24,90 €
52241	319	1.690,00 €
52242	311	12,00 €
52243	311	8,50 €
52244	191	84,00 €
52251	364	21,80 €
52254	135	64,00 €
52259	359	3,75 €
52262	185	7,50 €
52263	185	13,50 €
52264	185	18,60 €
52265	185	30,50 €
52269	202	7,00 €
52270	224	109,00 €
52271	283	18,00 €
52272	57	24,60 €
52273	212	44,00 €
52275	198	38,00 €
52293	231	98,00 €

REF.	PAGINA	PREȚ
52295	185	6,50 €
52296	239	119,00 €
52297	239	172,00 €
52298	239	177,00 €
52302	140	25,40 €
52303	140	26,40 €
52304	316	84,00 €
52305	205	106,00 €
52308	100	440,00 €
52309	100	941,00 €
52310	375	3,65 €
52311	201	19,00 €
52312	201	9,00 €
52313	201	8,00 €
52314	201	26,60 €
52315	198	16,00 €
52316	232	18,90 €
52317	232	19,90 €
52318	69	73,00 €
52319	232	8,80 €
52320	34	22,00 €
52321	186	8,80 €
52327	186	12,00 €
52328	197	99,00 €
52329	303	36,40 €
52330	194	99,00 €
52331	159	201,00 €
52337	168	65,00 €
52338	173	41,00 €
52339	171	61,00 €
52340	171	58,00 €
52341	169	58,00 €
52342	170	63,00 €
52343	173	52,00 €
52344	171	197,00 €
52345	168	109,00 €
52346	169	103,00 €
52347	171	158,00 €
52348	172	179,00 €
52349	48	22,10 €
52350	48	22,60 €
52351	48	25,40 €
52352	48	32,40 €
52353	48	33,40 €
52354	48	34,40 €
52355	48	36,60 €
52357	48	54,00 €
52358	48	63,00 €
52362	357	1,23 €
52363	357	1,23 €
52364	357	2,86 €
52365	357	2,46 €
52368	357	1,14 €
52369	357	1,19 €
52370	357	1,17 €
52373	93	252,00 €
52375	137	38,00 €

REF.	PAGINA	PREȚ
52378	163	10,00 €
52381	157	20,50 €
52382	331, 344	19,50 €
52384	132	29,00 €
52385	186	251,00 €
52386	186	23,60 €
52390	187	35,20 €
52391	311	5,00 €
52412	59	5,00 €
52414	141	19,00 €
52415	141	19,00 €
52416	203	14,00 €
52417	203	28,00 €
52418	21	179,00 €
52419	89	80,00 €
52420	89	108,00 €
52421	89	172,00 €
52422	213	24,70 €
52424	47	64,00 €
52425	63	33,30 €
52426	63	52,00 €
52427	63	64,00 €
52428	305	40,00 €
52430	376	10,90 €
52432	224	35,00 €
52433	69	4,80 €
52434	197	125,00 €
52439	331	227,00 €
52450	338	105,00 €
52451	43	42,00 €
52452	310	8,00 €
52453	310	21,00 €
52454	238	12,90 €
52455	198	16,00 €
52456	137	36,00 €
52460	63	16,60 €
52461	63	25,70 €
52462	68	25,30 €
52463	67	26,10 €
52464	67	42,00 €
52466	98	11,00 €
52468	62	5,90 €
52472	62	4,90 €
52473	62	9,90 €
52474	187	68,00 €
52475	187	62,00 €
52476	187	50,00 €
52477	187	70,00 €
52478	187	49,00 €
52479	187	24,70 €
52480	187	44,00 €
52481	187	52,00 €
52482	187	44,00 €
52483	187	41,00 €
52484	187	66,00 €
52485	187	51,00 €
52486	187	62,00 €

REF.	PAGINA	PREȚ
52487	187	63,00 €
52488	211	28,00 €
52489	210	58,00 €
52490	156	6,65 €
52491	156	10,50 €
52493	378	4,50 €
52494	241	227,00 €
52495	216	14,50 €
52497	192	26,80 €
52498	308	58,00 €
52500	54	19,00 €
52502	187	31,40 €
52503	187	32,50 €
52504	187	27,60 €
52505	187	20,80 €
52506	187	16,00 €
52507	187	30,10 €
52508	59	38,40 €
52509	59	36,20 €
52511	187	42,00 €
52512	187	50,00 €
52514	320	84,00 €
52515	70, 216	9,10 €
52516	98	28,00 €
52517	98	6,00 €
52518	201	115,00 €
52519	36, 345	25,50 €
52524	53	51,00 €
52525	53	13,80 €
52526	53	28,40 €
52527	151	82,00 €
52528	155	49,00 €
52530	361	14,00 €
52533	161, 182	10,00 €
52534	361	15,00 €
52535	361	16,50 €
52536	130	57,00 €
52538	31	62,00 €
52539	31	59,00 €
52540	159, 182	221,00 €
52541	222	45,00 €
52542	99	109,00 €
52543	160	182,00 €
52544	175	93,00 €
52545	175	177,00 €
52546	171	39,60 €
52547	168	96,00 €
52550	30	92,00 €
52551	242	151,00 €
52552	372	128,00 €
52555	134	2,38 €
52558	134	2,38 €
52565	63	11,50 €
52566	140	28,00 €
52567	140	29,00 €
52568	141	28,00 €
52569	141	28,00 €

REF.	PAGINA	PREȚ
52570	375	2,60 €
52571	375	2,60 €
52572	375	2,60 €
52573	375	2,60 €
52574	152	69,00 €
52575	68, 160	119,00 €
52583	69	8,50 €
52587	50	39,90 €
52588	50	45,00 €
52591	214	12,00 €
52592	214	22,00 €
52593	214	34,00 €
52595	68	64,00 €
52596	67	114,00 €
52597	67	146,00 €
52598	121, 340	1.080,00 €
52599	210	230,00 €
52600	342	884,00 €
52601	304	397,00 €
52603	28	74,00 €
52604	28	78,00 €
52605	28	76,00 €
52606	28	88,00 €
52607	203	49,00 €
52608	203	44,00 €
52609	68	29,00 €
52615	201	112,00 €
52616	296	44,00 €
52617	204	7,00 €
52618	365	29,00 €
52619	59	23,10 €
52620	31	8,80 €
52621	232	11,00 €
52624	241	28,00 €
52625	60, 198	9,00 €
52626	238	46,00 €
52627	238	120,00 €
52628	308	26,50 €
52629	208	99,00 €
52633	359	1,00 €
52634	91	5,25 €
52635	91	4,80 €
52636	194	114,00 €
52637	229	48,00 €
52638	69	9,95 €
52639	209	123,00 €
52640	225	52,00 €
52641	225	55,00 €
52642	228	32,00 €
52643	339	596,00 €
52644	360	8,80 €
52645	371	0,55 €
52646	371	0,50 €
52648	158	9,00 €
52649	370	5,00 €
52650	370	5,00 €
52652	369	2,80 €

REF.	PAGINA	PREȚ
52653	369	3,00 €
52655	371	39,70 €
52656	371	39,50 €
52657	371	37,50 €
52658	371	39,70 €
52659	371	39,70 €
52660	372	126,00 €
52662	370	36,50 €
52663	370	30,00 €
52664	372	168,00 €
52665	368	0,37 €
52666	368	0,36 €
52667	368	0,76 €
52668	368	1,49 €
52669	368	2,22 €
52670	368	2,95 €
52671	368	3,70 €
52672	368	4,45 €
52673	370	18,00 €
52675	154	84,00 €
52676	154	98,00 €
52677	202	17,00 €
52678	202	18,00 €
52685	210	88,00 €
52687	218	168,00 €
52690	215	54,00 €
52691	232	54,00 €
52692	324	129,00 €
52693	213	24,50 €
52694	168	49,00 €
52696	213	12,00 €
52697	213	16,00 €
52699	228	22,00 €
52700	70	20,50 €
52703	384	22,00 €
52711	383	27,50 €
52714	33	15,70 €
52715	33	10,00 €
52716	33	15,90 €
52717	33	11,00 €
52718	152	48,00 €
52719	389	0,19 €
52722	22	87,00 €
52724	151	381,00 €
52725	151	349,00 €
52727	239	34,60 €
52728	239	68,00 €
52729	239	128,00 €
52730	239	288,00 €
52731	239	38,00 €
52732	239	58,00 €
52733	239	98,00 €
52734	213	51,00 €
52735	166	4,85 €
52736	166	5,35 €
52737	166	5,50 €
52738	375	5,00 €

REF.	PAGINA	PREȚ
52739	375	5,00 €
52740	184	690,00 €
52749	189	79,00 €
52753	30	107,00 €
52754	204	54,00 €
52757	209	16,00 €
52758	154	88,00 €
52760	70, 216	4,10 €
52761	61	8,00 €
52762	61	9,00 €
52765	185	21,70 €
52768	356	13,80 €
52769	356	14,50 €
52770	356	23,00 €
52771	356	23,40 €
52772	356	13,90 €
52773	356	14,60 €
52774	356	14,80 €
52775	356	15,20 €
52776	356	13,80 €
52777	356	15,50 €
52778	356	14,60 €
52779	356	17,10 €
52780	356	13,90 €
52781	356	14,60 €
52782	356	14,80 €
52783	356	15,20 €
52786	64	14,60 €
52787	157	9,00 €
52788	181	39,00 €
52789	308	15,20 €
52791	58, 59	18,00 €
52794	69	28,00 €
52795	354	5,80 €
52796	228	98,00 €
52797	305	198,00 €
52798	156	18,00 €
52801	212	26,00 €
52802	226	54,00 €
52804	309	343,00 €
52805	309	426,00 €
52806	309	742,00 €
52807	309	1.714,00 €
52809	201	8,50 €
52810	170	9,00 €
52811	170	9,90 €
52812	59	65,00 €
52813	212	79,00 €
52814	149	528,00 €
52815	208	110,00 €
52816	232	28,10 €
52817	232	23,50 €
52819	216	22,00 €
52821	212	28,80 €
52822	230	32,00 €
52823	226	124,00 €
52827	138	46,00 €

REF.	PAGINA	PREȚ
52828	138	43,00 €
52829	222	19,00 €
52830	64	24,00 €
52831	64	18,00 €
52832	215	75,00 €
52833	237	39,30 €
52834	224	195,00 €
52835	224	272,00 €
52836	184	1.100,00 €
52838	142	56,00 €
52839	142	64,00 €
52842	372	11,00 €
52843	139	31,60 €
52845	323	170,00 €
52846	57	37,80 €
52847	57	41,00 €
52849	230	8,50 €
52850	215	7,80 €
52851	181, 395	9,65 €
52852	230	6,80 €
52858	206	298,00 €
52862	357	1,15 €
52864	357	1,20 €
52865	357	0,50 €
52866	357	0,25 €
52869	100	52,00 €
52870	100	100,00 €
52871	100	258,00 €
52873	69	11,00 €
52874	225	82,00 €
52875	225	79,00 €
52876	180	182,00 €
52877	64	15,80 €
52878	64	11,20 €
52879	64	10,10 €
52880	47	42,00 €
52881	47	17,00 €
52882	213	14,00 €
52884	329	73,00 €
52885	64	18,00 €
52886	396	18,00 €
52887	396	22,00 €
52888	400	24,00 €
52889	398	19,00 €
52890	399	22,00 €
52891	398	28,00 €
52892	399	22,00 €
52893	400	26,00 €
52894	398	22,00 €
52895	400	22,00 €
52896	396	26,00 €
52897	399	38,00 €
52898	399	36,00 €
52899	397	34,00 €
52900	397	34,00 €
52901	397	34,00 €
52902	342	970,00 €

REF.	PAGINA	PREȚ
52903	342	1.100,00 €
52904	69	61,00 €
52905	70	28,00 €
52906	196	38,00 €
52908	34	17,00 €
52909	34	12,50 €
52910	138	39,00 €
52912	45, 87	91,00 €
52913	51	292,00 €
52914	177	223,00 €
52915	177	199,00 €
52916	177	218,00 €
52917	177	122,00 €
52918	177	146,00 €
52919	177	181,00 €
52920	177	155,00 €
52921	177	117,00 €
52922	177	180,00 €
52923	177	59,00 €
52924	177	52,00 €
52925	177	176,00 €
52926	177	201,00 €
52927	177	59,00 €
52928	177	172,00 €
52929	177	185,00 €
52930	178	117,00 €
52931	178	45,00 €
52932	178	45,00 €
52933	178	194,00 €
52934	178	102,00 €
52935	178	94,00 €
52936	178	199,00 €
52937	178	265,00 €
52938	178	199,00 €
52939	178	28,00 €
52940	178	235,00 €
52941	178	70,00 €
52942	178	105,00 €
52943	178	75,00 €
52944	178	110,00 €
52945	178	281,00 €
52952	331, 344	74,00 €
52953	152	38,00 €
52955	61	19,80 €
52956	61	19,60 €
52957	61	23,80 €
52958	61	28,20 €
52959	61	42,00 €
52960	61	46,00 €
52962	226	42,00 €
52963	217	49,00 €
52964	56	9,45 €
52965	56	9,20 €
52966	56	9,45 €
52967	56	9,40 €
52969	172	20,70 €
52973	42	59,00 €

REF.	PAGINA	PREȚ
52977	182	137,00 €
52980	335	480,00 €
52982	60, 186	53,00 €
52985	322	598,00 €
52987	132	20,00 €
52991	311	10,50 €
52992	311	18,00 €
52998	185	48,00 €
52999	321	178,00 €
53001	217	242,00 €
53007	357	0,42 €
53008	201	15,50 €
53009	209	42,00 €
53010	54	18,00 €
53017	38	57,00 €
53018	40	119,00 €
53025	69	3,50 €
53026	69	5,80 €
53027	69	9,00 €
53028	331	5,80 €
53029	331	6,80 €
53030	331	12,00 €
53031	100	59,00 €
53032	100	126,00 €
53033	364	21,50 €
53037	371	0,50 €
53038	371	0,50 €
53039	371	0,50 €
53040	371	0,50 €
53041	235	37,60 €
53042	69	9,90 €
53043	175	53,00 €
53044	175	121,00 €
53045	140	35,00 €
53046	140	39,00 €
53047	141	330,00 €
53048	141	89,00 €
53049	140	89,00 €
53051	141	158,00 €
53052	140	158,00 €
53053	215	12,00 €
53054	238	6,00 €
53055	236	33,00 €
53056	241	127,00 €
53057	217	149,00 €
53058	241	193,00 €
53059	242	52,00 €
53060	170	34,90 €
53062	240	99,00 €
53063	162	36,70 €
53064	162	37,40 €
53065	162	36,90 €
53066	162	61,00 €
53067	162	61,00 €
53068	162	63,00 €
53069	208	98,00 €
53070	48	16,20 €

REF.	PAGINA	PREȚ
53071	48	26,10 €
53072	48	31,60 €
53073	48	50,00 €
53074	17	78,00 €
53077	174	62,00 €
53078	310	18,00 €
53079	189	89,00 €
53080	189	99,00 €
53081	52	115,00 €
53082	52	148,00 €
53083	65	64,00 €
53084	34	24,00 €
53085	135	30,00 €
53086	238	9,00 €
53087	356	11,20 €
53088	356	11,50 €
53089	356	11,50 €
53090	356	11,50 €
53091	356	10,20 €
53092	356	10,20 €
53093	356	10,20 €
53094	356	10,20 €
53095	66	20,50 €
53096	209	28,80 €
53108	22	92,00 €
53110	181, 395	27,30 €
53111	332	19,00 €
53112	314	298,00 €
53118	230	231,00 €
53119	213	52,00 €
53120	65	6,00 €
53121	65	7,35 €
53122	65	9,50 €
53124	188	287,00 €
53125	188	477,00 €
53126	189	243,00 €
53127	34	12,00 €
53129	216	84,00 €
53134	189	144,00 €
53137	155	38,00 €
53140	152	98,00 €
53141	155	68,00 €
53144	307	18,00 €
53145	332	39,20 €
53146	239	30,50 €
53147	163	41,00 €
53150	369	24,00 €
53151	143	14,00 €
53154	36, 345	462,00 €
53156	32	26,20 €
53159	25	289,00 €
53162	332	60,00 €
53164	36, 345	16,50 €
53165	36, 345	19,60 €
53166	339	10,50 €
53167	339	12,50 €
53168	339	19,00 €

REF.	PAGINA	PREȚ
53177	356	11,90 €
53178	356	12,20 €
53179	356	12,20 €
53180	356	12,20 €
53181	356	11,90 €
53182	356	12,20 €
53183	356	12,70 €
53184	356	12,20 €
53185	355	13,20 €
53186	355	13,20 €
53187	311	39,00 €
53188	311	7,00 €
53189	337	128,00 €
53190	337	98,00 €
53191	98	14,80 €
53192	98	52,00 €
53196	192	33,00 €
53197	174	46,00 €
53198	311	9,50 €
53200	318	69,00 €
53202	160	15,70 €
53203	357	0,46 €
53204	160	81,00 €
53205	157	19,00 €
53206	202	38,20 €
53207	225	118,00 €
53208	225	126,00 €
53209	329	8,50 €
53210	48	48,00 €
53211	99	75,00 €
53212	16	174,00 €
53214	309	285,00 €
53215	307	19,00 €
53216	130	49,00 €
53217	132	47,00 €
53218	318	26,00 €
53220	334	260,00 €
53221	365	4,75 €
53224	180	142,00 €
53225	56	3,50 €
53226	192	14,90 €
53227	135	28,00 €
53229	388	38,70 €
53230	183	19,70 €
53232	185	39,00 €
53235	203	10,40 €
53236	203	11,50 €
53237	203	12,90 €
53238	203	18,40 €
53240	234	58,00 €
53241	361	9,00 €
53246	324	1.144,00 €
53249	231	192,00 €
53250	208	85,00 €
53251	213	88,00 €
53253	96	98,00 €
53256	368	34,00 €

REF.	PAGINA	PREȚ
53259	249	97,00 €
53260	249	168,00 €
53261	249	214,00 €
53262	250	251,00 €
53263	250	57,00 €
53264	250	143,00 €
53265	251	195,00 €
53266	251	224,00 €
53267	251	277,00 €
53268	258	92,00 €
53269	252	50,00 €
53270	270	70,00 €
53271	270	227,00 €
53272	271	195,00 €
53273	271	75,00 €
53274	284	30,50 €
53275	284	35,50 €
53276	285	160,00 €
53277	285	45,00 €
53278	285	143,00 €
53279	286	97,00 €
53280	286	112,00 €
53281	286	55,00 €
53282	287	48,00 €
53283	287	92,00 €
53284	287	306,00 €
53285	288	56,00 €
53286	288	87,00 €
53287	288	245,00 €
53288	289	72,00 €
53289	274	45,00 €
53290	274	51,00 €
53291	274	68,00 €
53292	275	116,00 €
53293	261	134,00 €
53294	261	119,00 €
53295	262	77,00 €
53296	262	60,00 €
53297	267	45,00 €
53298	267	91,00 €
53299	278	291,00 €
53300	278	41,00 €
53301	278	44,00 €
53302	279	44,00 €
53303	244	89,00 €
53304	244	279,00 €
53305	279	136,00 €
53306	244	53,00 €
53307	279	38,50 €
53308	245	55,00 €
53309	245	285,00 €
53310	245	498,00 €
53311	275	97,00 €
53312	246	127,00 €
53313	258	139,00 €
53314	258	98,00 €
53315	295	285,00 €

REF.	PAGINA	PREȚ
53316	280	34,00 €
53317	280	34,00 €
53318	261	24,00 €
53319	246	18,00 €
53320	289	12,00 €
53321	289	10,50 €
53324	264	12,50 €
53325	289	7,50 €
53326	290	16,00 €
53327	290	11,00 €
53328	226	76,00 €
53330	212	38,00 €
53331	67	31,80 €
53332	67	34,50 €
53339	70	9,50 €
53340	388	86,00 €
53343	149	285,00 €
53346	50	18,00 €
53347	205	100,00 €
53348	382	14,00 €
53349	392	14,00 €
53350	382	14,00 €
53351	384	12,50 €
53352	390	12,00 €
53353	387	18,00 €
53354	384	14,00 €
53355	393	11,50 €
53356	393	11,50 €
53357	394	7,00 €
53358	390	11,50 €
53359	390	16,00 €
53360	384	18,00 €
53361	384	24,00 €
53362	385	14,00 €
53363	382	34,00 €
53364	382	16,00 €
53365	385	14,00 €
53366	385	14,00 €
53367	393	9,50 €
53368	393	9,00 €
53369	385	14,00 €
53370	393	26,00 €
53371	383	29,00 €
53372	383	26,00 €
53373	383	14,50 €
53374	392	10,00 €
53376	392	10,50 €
53377	386	20,00 €
53378	390	13,00 €
53380	393	11,50 €
53381	390	14,50 €
53382	383	11,00 €
53383	383	11,50 €
53384	225	165,00 €
53385	61, 394	19,30 €
53388	233	90,00 €
53389	57	31,50 €

REF.	PAGINA	PREȚ
53390	58	34,50 €
53391	234	86,00 €
53393	234	118,00 €
53394	223	598,00 €
53395	218	16,00 €
53396	58	18,30 €
53399	92	3,50 €
53400	92	5,70 €
53401	92	7,40 €
53402	92	9,60 €
53403	92	6,50 €
53404	92	6,50 €
53405	92	5,30 €
53406	92	8,55 €
53407	92	12,70 €
53408	92	19,30 €
53409	92	9,00 €
53410	217	92,00 €
53411	60	5,00 €
53412	60	4,00 €
53414	333	49,00 €
53415	333	188,00 €
53416	158	14,10 €
53417	158	26,30 €
53418	158	16,90 €
53419	372	9,70 €
53420	44	72,00 €
53421	315	298,00 €
53422	314	368,00 €
53423	323	199,00 €
53426	217	39,80 €
53427	134	5,00 €
53428	139	18,00 €
53429	139	18,00 €
53430	178	286,00 €
53434	392	18,00 €
53441	201	9,80 €
53444	27	195,00 €
53445	60	17,10 €
53449	158	16,40 €
53450	158	28,30 €
53452	280	26,50 €
53453	218	7,00 €
53456	220	98,00 €
53459	221	66,00 €
53463	242	98,00 €
53464	209, 387	153,00 €
53468	52	8,50 €
53470	171	176,00 €
53472	204	12,00 €
53473	204	36,00 €
53474	234	94,00 €
53477	217	36,10 €
53478	52	4,55 €
53479	52	6,40 €
53480	52	19,90 €
53481	52	27,40 €

REF.	PAGINA	PREȚ
53484	332	615,00 €
53485	205	140,00 €
53486	183	29,30 €
53487	59	16,70 €
53488	229	61,00 €
53489	211	68,00 €
53490	209	275,00 €
53492	163, 410	380,00 €
53499	220	29,00 €
53500	220	29,00 €
53501	209	24,00 €
53502	236	38,70 €
53503	338	12,00 €
53504	410	38,00 €
53505	135	77,00 €
53506	135	36,00 €
53507	354	27,00 €
53508	365	14,00 €
53517	64	9,50 €
53518	310	3,50 €
53519	130	42,00 €
53520	146	228,00 €
53522	209	24,00 €
53523	275	91,00 €
53524	237	51,00 €
53525	182	12,00 €
53526	338, 348	119,00 €
53531	169	109,00 €
53532	164, 348	119,00 €
53533	409	1,50 €
53536	143	34,00 €
53537	204	14,50 €
53538	204	14,50 €
53539	219	66,00 €
53541	152	168,00 €
53542	159, 372	980,00 €
53543	337	13,80 €
53545	180	35,70 €
53547	56	14,70 €
53548	56	15,60 €
53549	56	14,30 €
53550	56	14,70 €
53551	374	16,00 €
53552	374	16,00 €
53553	374	16,00 €
53561	365	28,00 €
53565	24	258,00 €
53566	304	32,00 €
53567	161	43,00 €
53568	133	12,00 €
53569	133	18,00 €
53570	136	154,00 €
53572	161	348,00 €
53573	151	36,00 €
53574	31	47,00 €
53575	55	16,00 €
53576	153	189,00 €

REF.	PAGINA	PREȚ
53581	164, 348	119,00 €
53582	164, 348	174,00 €
53583	164, 348	174,00 €
53584	338, 348	119,00 €
53585	338, 348	168,00 €
53586	338, 348	168,00 €
53587	173	44,00 €
53588	146	178,00 €
53589	70	12,00 €
53590	321	1.190,00 €
53591	64	5,50 €
53592	312	25,00 €
53593	160	41,00 €
53594	163	54,00 €
53595	163	61,00 €
53596	376	3,65 €
53597	376	3,70 €
53598	376	3,95 €
53599	221, 389	30,30 €
53602	61	30,50 €
53603	61	45,00 €
53604	61	118,00 €
53605	372	141,00 €
53606	158	55,00 €
53608	148	98,00 €
53609	302	182,50 €
53610	302	294,00 €
53611	156	27,50 €
53612	310	96,00 €
53613	68	19,50 €
53614	68	21,50 €
53615	68	34,60 €
53616	68	10,40 €
53617	68	9,25 €
53618	68	13,90 €
53620	89	88,00 €
53621	355	2,50 €
53622	355	2,50 €
53623	355	2,50 €
53624	355	2,50 €
53625	160	68,00 €
53626	154, 184	18,00 €
53627	305	22,50 €
53629	164	14,30 €
53630	164	18,80 €
53631	164	33,50 €
53632	164	46,00 €
53633	164	46,00 €
53634	164	63,00 €
53635	225	85,00 €
53636	354	22,00 €
53637	215	85,00 €
53638	222	243,00 €
53639	47	28,60 €
53640	47	34,40 €
53641	47	41,00 €
53642	47	54,00 €

REF.	PAGINA	PREȚ
53643	47	92,00 €
53644	303	1.238,00 €
53645	303	268,00 €
53646	153	69,00 €
53648	290	107,00 €
53649	291	89,00 €
53650	212	47,00 €
53651	280	91,00 €
53652	237	53,00 €
53653	264	207,00 €
53654	47	81,00 €
53655	182	12,00 €
53656	334	198,00 €
53657	334	248,00 €
53658	334	99,00 €
53659	334	121,00 €
53660	334	146,00 €
53661	77	790,00 €
53662	214	89,00 €
53663	235	8,00 €
53664	238	38,00 €
53665	238	19,00 €
53666	238	28,00 €
53667	35	32,00 €
53668	35	34,00 €
53669	215	45,00 €
53670	202	29,50 €
53671	51, 89	41,00 €
53672	82	440,00 €
53673	183	80,00 €
53674	94	447,00 €
53675	186	50,00 €
53676	186	44,00 €
53677	186	55,00 €
53678	186	52,00 €
53681	149	743,00 €
53682	322	98,00 €
53683	196	116,00 €
53684	321	1.880,00 €
53685	189	310,00 €
53686	77	790,00 €
53687	328	298,00 €
53688	328	495,00 €
53689	147	238,00 €
53690	137	34,00 €
53691	137	36,00 €
53693	360	521,00 €
53694	54	18,40 €
53695	360	504,00 €
53696	209	22,00 €
53697	302	398,00 €
53698	360	717,00 €
53701	240	188,00 €
53702	97	28,50 €
53703	97	41,00 €
53704	97	42,00 €
53705	191	80,00 €

REF.	PAGINA	PREȚ
53706	291	98,00 €
53707	136	153,00 €
53708	74, 76, 77, 83	325,00 €
53710	404	16,00 €
53711	404	16,00 €
53712	403	16,00 €
53713	403	16,00 €
53714	403	16,00 €
53715	402	19,00 €
53716	402	19,00 €
53717	402	19,00 €
53718	401	19,00 €
53719	401	19,00 €
53720	401	19,00 €
53721	355	18,80 €
53724	332	46,00 €
53725	314	248,00 €
53726	148	128,00 €
53727	23	198,00 €
53728	23	198,00 €
53729	184	19,10 €
53733	147	238,00 €
53734	130	23,70 €
53735	203	44,00 €
53736	189	98,00 €
53737	45	12,50 €
53738	45	10,90 €
53739	45	10,50 €
53740	45	9,10 €
53741	204	14,00 €
53742	223	1.325,00 €
53743	32, 175	39,70 €
53744	170	63,00 €
53745	362	6,40 €
53746	362	6,40 €
53747	362	6,40 €
53748	362	6,60 €
53749	362	6,70 €
53750	362	6,70 €
53751	362	6,80 €
53752	362	6,95 €
53753	362	7,10 €
53754	362	7,40 €
53755	362	7,50 €
53756	362	7,90 €
53757	362	7,90 €
53758	362	8,20 €
53759	362	8,50 €
53760	362	9,60 €
53761	77	490,00 €
53762	77	490,00 €
53767	77	790,00 €
53768	77	490,00 €
53769	80, 297, 300	178,00 €
53770	80, 298, 300	198,00 €
53771	80, 299, 300	158,00 €

REF.	PAGINA	PREȚ
53772	80, 299, 300	229,00 €
53773	80, 297, 300	298,00 €
53774	80, 298, 300	190,00 €
53775	80, 300	1.109,00 €
53776	131	19,10 €
53778	354	4,50 €
53779	318	36,00 €
53780	132	14,50 €
53781	377	18,00 €
53782	96	14,00 €
53784	150	148,00 €
53785	376	4,80 €
53786	380	98,00 €
53791	378	4,80 €
53794	376	28,00 €
53796	380	76,00 €
53797	377	0,10 €
53802	380	120,00 €
53806	380	250,00 €
53808	379	16,50 €
53809	379	8,00 €
53811	379	8,90 €
53826	378	16,00 €
53827	378	32,00 €
53832	378	1,81 €
53838	380	38,00 €
53839	379	0,25 €
53845	318	64,00 €
53849	312	16,10 €
53850	123	14,90 €
53851	125	88,00 €
53852	125	207,00 €
53853	125	14,40 €
53854	125	27,00 €
53855	125	24,80 €
53856	125	62,00 €
53857	126	27,00 €
53858	126	28,80 €
53859	124	67,00 €
53860	124	3,65 €
53861	124	5,45 €
53862	377	6,00 €
53863	377	3,00 €
53864	369	138,00 €
53867	82	1.095,00 €
53868	74	1.090,00 €
53869	75	990,00 €
53870	75	990,00 €
53872	348	118,00 €
53873	307	285,00 €
53874	307	398,00 €
53875	216	134,00 €
53876	259	64,00 €
53877	411	430,50 €
53878	411	574,00 €
53879	411	838,50 €

REF.	PAGINA	PREȚ
53880	320	598,00 €
53881	164, 348	79,00 €
53882	164, 348	79,00 €
53883	50	18,40 €
53884	50	30,20 €
53885	50	35,70 €
53886	50	20,30 €
53887	50	30,30 €
53888	50	37,90 €
53895	317	107,00 €
53896	317	127,00 €
53897	317	140,00 €
53898	317	148,00 €
53902	378	25,00 €
53903	97	59,00 €
53904	77	790,00 €
53905	56	7,30 €
53906	56	8,65 €
53908	56	7,25 €
53909	56	9,70 €
53910	392	19,00 €
53911	57	8,80 €
53912	75	1.280,00 €
53913	75	1.280,00 €
53914	379, 412	75,00 €
53915	22	65,00 €
53917	54	9,00 €
53919	363	81,00 €
53921	190	39,00 €
53922	190	29,00 €
53927	329	66,00 €
53928	26	278,00 €
53929	329	95,00 €
53932	61	8,00 €
53939	74	1.280,00 €
53940	79, 344, 346, 379	13,20 €
53942	79, 344, 346, 379	0,50 €
53943	54, 86	21,50 €
53944	54, 86	19,50 €
53945	54, 86	18,90 €
53946	377	0,83 €
53947	336	145,00 €
53948	336	324,00 €
53949	409	4,50 €
53950	409	4,50 €
53951	80, 300	1.794,00 €
53952	80, 300	1.794,00 €
53953	20	29,00 €
53954	45	8,50 €
53955	45	10,00 €
53956	408	353,00 €
53957	377	0,26 €
53958	98	6,50 €
53964	364	9,65 €
53965	364	25,80 €
53967	57	10,20 €

REF.	PAGINA	PREȚ
53968	314	49,00 €
53969	323	96,00 €
53970	343	3.790,00 €
53972	52	550,00 €
53973	408	284,00 €
53974	134	38,00 €
53976	61	9,00 €
53977	332	17,50 €
53978	195	38,90 €
53979	45, 88	34,60 €
53980	45, 88	34,60 €
53981	333	143,00 €
53982	333	219,00 €
53983	188	215,00 €
53984	374	8,00 €
53985	374	8,00 €
53986	374	8,00 €
53987	344, 379	9,50 €
53988	173	101,00 €
53992	392	18,00 €
53993	66	77,00 €
53997	211	48,00 €
53999	127	2,00 €
54000	127	2,50 €
54001	317	285,00 €
54002	127	3,00 €
54003	238	104,00 €
54004	133	16,00 €
54005	46	14,00 €
54006	77	490,00 €
54008	127	3,50 €
54010	127	4,50 €
54011	127	5,00 €
54013	369	35,00 €
54015	57	10,20 €
54016	211	76,00 €
54017	182	12,00 €
54018	49	9,85 €
54019	49	17,90 €
54021	49	13,50 €
54022	49	9,95 €
54023	49	13,50 €
54024	49	17,90 €
54028	49	28,00 €
54029	49	28,00 €
54030	49	18,80 €
54031	49	19,30 €
54032	39, 88	84,00 €
54033	161	49,00 €
54034	9	178,00 €
54035	12	149,00 €
54036	13	99,00 €
54037	14	88,00 €
54038	15	88,00 €
54039	135	154,00 €
54040	330	240,00 €
54041	40	198,00 €

REF.	PAGINA	PREȚ
54042	358	13,00 €
54043	408	48,00 €
54044	143	99,00 €
54045	9	179,00 €
54046	12	150,00 €
54047	13	100,00 €
54048	14	89,00 €
54049	15	89,00 €
54050	306	895,00 €
54051	308	39,00 €
54053	342	248,00 €
54054	342	268,00 €
54055	342	220,00 €
54056	342	260,00 €
54057	342	248,00 €
54058	342	348,00 €
54059	343	428,00 €
54060	55	6,00 €
54061	55	6,00 €
54066	39, 87	83,00 €
54068	200	120,00 €
54069	221	29,50 €
54070	55	18,00 €
54071	55	26,50 €
54072	358	38,50 €
54073	363	70,00 €
54074	363	18,50 €
54076	409	9,00 €
54078	144	68,00 €
54079	41	83,00 €
54080	96	53,50 €
54081	43	28,00 €
54082	11	189,00 €
54083	49	9,75 €
54084	49	13,10 €
54085	49	17,80 €
54086	49	9,25 €
54087	49	17,30 €
54088	135	132,00 €
54089	65	17,50 €
54090	21	56,00 €
54091	35, 345	441,00 €
54092	291	24,00 €
54093	35, 79, 87, 345, 346	441,00 €
54097	41	38,90 €
54098	47	158,50 €
54099	66	13,80 €
54100	302	265,00 €
54101	38	61,00 €
54105	21	33,00 €
54106	17, 46	89,00 €
54108	18	66,00 €
54109	20	34,00 €
54110	40	46,00 €
54111	333	4,75 €
54112	62	18,00 €
54113	333	7,65 €

REF.	PAGINA	PREȚ
54114	79, 330, 346	248,00 €
54115	43	26,80 €
54116	18	66,00 €
54117	38	74,00 €
54119	44	78,00 €
54120	41	59,00 €
54122	131	38,00 €
54123	131	40,00 €
54124	131	47,00 €
54125	337	152,00 €
54126	54	39,00 €
54129	79, 346	110,00 €
54130	79, 345, 346	58,00 €
54131	345	58,00 €
54132	79, 346	190,00 €
54133	135	547,00 €
54134	78, 84	1.415,00 €
54135	197	82,00 €
54136	372	107,00 €
54137	315	288,00 €
54139	218	147,00 €
54140	17	36,00 €
54141	22	42,00 €
54142	62	15,20 €
54143	318	249,00 €
54144	318	298,00 €
54145	318	377,00 €
54146	318	492,00 €
54147	318	198,00 €
54149	42	60,00 €
54150	42	23,50 €
54151	374	9,00 €
54152	374	9,00 €
54153	374	9,00 €
54154	29	37,50 €
54155	374	8,00 €
54156	374	8,00 €
54157	374	8,00 €
54158	86	38,00 €
54159	43	47,00 €
54160L	143	17,50 €
54160R	143	17,50 €
54161	142	90,00 €
54162	142	81,00 €
54163	142	80,00 €
54164	29	34,00 €
54166	363	32,40 €
54168	20	49,00 €
54169	363	13,80 €
54170	363	16,50 €
54172	137	81,00 €
54173	137	87,00 €
54174	41	139,00 €
54175	326	34,00 €
54176	350	188,00 €
54177	374	16,00 €

REF.	PAGINA	PREȚ
54178	374	16,00 €
54179	374	16,00 €
54181	310	25,10 €
54182	310	34,70 €
54183	310	38,20 €
54184	310	44,00 €
54186	206	250,00 €
54187	46	39,30 €
54188	376	19,00 €
54189	376	19,00 €
54190	376	19,00 €
54191	376	19,00 €
54192	375	8,90 €
54193	375	8,90 €
54194	375	8,90 €
54195	375	8,90 €
54198	372	59,00 €
54199	292	94,00 €
54200	296	56,00 €
54201	264	37,60 €
54202	246	68,00 €
54203	247	91,00 €
54204	265	124,00 €
54205	281	49,00 €
54206	252	113,00 €
54207	270	38,90 €
54208	265	76,00 €
54209	265	29,70 €
54210	276	84,00 €
54211	247	74,00 €
54212	247	39,40 €
54213	260	19,80 €
54214	281	96,00 €
54215	248	57,00 €
54216	248	49,00 €
54217	281	104,00 €
54218	292	142,00 €
54219	253	60,00 €
54220	208	197,00 €
54221	282	111,00 €
54222	253	59,00 €
54223	266	149,00 €
54224	266	64,50 €
54225	276	133,00 €
54226	295	71,00 €
54227	253	122,00 €
54228	254	187,00 €
54229	337	48,00 €
54230	337	68,00 €
54231	337	138,00 €
54232	337	248,00 €
54233	79, 346	1.856,00 €
54234	79, 346	1.856,00 €
54235	79, 346	1.856,00 €
54236	79, 346	1.856,00 €
54237	78	1.887,00 €
54238	78	1.887,00 €

REF.	PAGINA	PREȚ
54239	78	1.887,00 €
54240	78	1.887,00 €
54241	79, 346	120,00 €
54246	182	104,00 €
54247	182	99,00 €
54248	158	58,00 €
54249	158	103,00 €
54250	10	188,00 €
54251	157	43,00 €
54252	340	199,00 €
54253	227	166,00 €
54254	62	43,00 €
54255	156, 312	68,00 €
54256	330	48,00 €
54257	319	318,00 €
54258	19	58,00 €
54260	266	277,00 €
54261	24	321,00 €
54262	323	88,00 €
54263	323	130,00 €
54264	323	240,00 €
54265	343	1.290,00 €
54266	29	39,50 €
54267	133	9,50 €
54269	51	56,00 €
54270	136	42,00 €
54271	136	54,00 €
54273	214	10,10 €
54274	214	11,00 €
54275	214	13,20 €
54277	19	53,50 €
54278	409	4,50 €
54279	58	6,00 €
54280	237	156,50 €
54288	259	72,50 €
54289	277	38,00 €
54290	306	4.307,00 €
54291	220	5.054,00 €
54293	254	17,50 €
54294	374	8,00 €
54295	81	500,00 €
54296	81	520,00 €
54297	81	540,00 €
54298	354	7,50 €
54299	227	227,00 €
54302	53	11,50 €
54304	50	26,00 €
54305	351	232,50 €
54306	352	219,50 €
54308	352	89,00 €
54309	352	71,00 €
54310	352	57,00 €
54311	58	13,00 €
54312	210	191,50 €
54313	126	43,00 €
54314	126	82,00 €
54316	172	182,00 €

REF.	PAGINA	PREȚ
54317	226	124,00 €
54318	271	105,00 €
54321	343	898,00 €
54322	344, 379	19,00 €
54323	259	119,00 €
54324	257	11,00 €
54325	409	22,50 €
54326	79, 344, 346, 379	7,30 €
54327	72	2.788,00 €
54328	94	199,00 €
54329	371	37,50 €
54330	58	12,50 €
54331	65	27,00 €
54336	150	259,00 €
54338	39	60,00 €
54339	51	273,00 €
54340	147	296,00 €
54341	335	643,00 €
54342	335	858,00 €
54343	53	31,00 €
54344	132	10,50 €
54345	206	15,00 €
54346	127	11,50 €
54347	214	46,00 €
54348	126	291,00 €
54349	325	8,00 €
54350	325	12,50 €
54351	325	14,00 €
54352	325	18,00 €
54353	325	23,50 €
54354	325	34,50 €
54355	325	12,00 €
54356	326	19,50 €
54357	325	15,00 €
54358	325	18,50 €
54359	326	14,00 €
54360	325	14,00 €
54361	325	14,00 €
54362	326	14,00 €
54363	325	14,00 €
54364	326	14,00 €
54365	325	12,50 €
54366	326	18,50 €
54367	306	729,00 €
54368	219	2.329,00 €
54369	374	16,00 €
54370	374	16,00 €
54371	374	16,00 €
54372	198	157,00 €
54373	210	395,00 €
54374	96	75,50 €
54376	58	12,00 €
54379	131	28,00 €
54380	233	119,00 €
54381	233	5,00 €
54382	233	5,00 €
54383	233	5,00 €

REF.	PAGINA	PREȚ
54384	222	32,50 €
54386	324, 346	5.839,00 €
54388	93	366,00 €
54389	76	790,00 €
54390	389	199,00 €
54391	207	221,00 €
54392	207	1.855,00 €
54393	95	92,00 €
54394	95	64,00 €
54395	95	53,00 €
54396	320	2.250,00 €
54397	147	249,00 €
54398	254	41,00 €
54399	255	56,50 €
54400	255	141,00 €
54401	255	57,00 €
54402	256	201,00 €
54403	256	225,00 €
54404	256	131,00 €
54405	257	111,00 €
54406	257	73,00 €
54407	292	59,50 €
54408	293	46,00 €
54409	293	32,00 €
54410	293	33,50 €
54411	294	36,00 €
54412	294	57,00 €
54413	294	115,00 €
54414	272	97,50 €
54415	272	60,00 €
54416	272	31,00 €
54417	273	153,00 €
54418	273	37,00 €
54419	262	57,00 €
54420	263	102,00 €
54421	263	52,00 €

REF.	PAGINA	PREȚ
54422	267	140,00 €
54423	268	108,00 €
54424	263	64,50 €
54425	268	124,00 €
54426	268	69,00 €
54427	269	113,00 €
54428	269	31,00 €
54429	269	55,00 €
54430	248	34,00 €
54431	295	184,00 €
54432	260	43,00 €
54433	260	18,00 €
54434	282	48,50 €
54435	282	14,50 €
54436	283	124,00 €
54437	283	110,00 €
54438	277	40,00 €
54439	277	32,50 €
54479	59	36,50 €
54480	409	1,00 €
54482	334	677,00 €
54483	325	14,00 €
54484	325	26,00 €
54485	325	36,00 €
54486	325	9,50 €
54487	326	15,00 €
54488	325	15,00 €
54489	326	19,50 €
54490	326	15,00 €
54491	326	17,50 €
54492	326	19,50 €
54493	325	13,50 €
54494	325	14,00 €
54495	326	18,00 €
54496	326	16,50 €
54497	326	12,50 €

REF.	PAGINA	PREȚ
54498	309	6.090,00 €
54501	80, 300	1.794,00 €
54502	80, 300	1.794,00 €
54503	76	490,00 €
54534	355	24,00 €
60001	116	88,00 €
60003	116	110,00 €
60004	117	79,00 €
60005	105	132,00 €
60006	106	182,00 €
60007	111	170,00 €
60009	108	168,00 €
60010	111	170,00 €
60011	112	175,00 €
60012	122	48,00 €
60013	122	80,00 €
60015	122	138,00 €
60016	122	49,00 €
60017	122	64,00 €
60019	110	178,00 €
60020	110	175,00 €
60022	112	470,00 €
60023	106	212,00 €
60024	105	190,00 €
60025	105, 122	31,60 €
60026	105, 122	379,00 €
60027	118	99,00 €
60028	109	142,00 €
60029	119	240,00 €
60030	119	112,00 €
60031	120	142,00 €
60032	113	123,00 €
60033	108	104,00 €
60035	117	30,00 €
60037	114	222,00 €
60038	113, 312	255,00 €

REF.	PAGINA	PREȚ
60039	118	265,00 €
60040	120	440,00 €
60041	114	77,00 €
60042	115	106,00 €
60043	115	123,00 €
60044	103	330,00 €
60044C	103	485,00 €
60045	121	298,00 €
60046	102	174,00 €
60046C	102	339,00 €
60047C	107	318,00 €
60048	104	366,00 €
60048C	104	560,00 €
60049C	109	329,00 €
70001	406	35,00 €
70002	406	35,00 €
70003	406	35,00 €
70004	406	42,00 €
70005	406	42,00 €
70006	406	42,00 €
70009	406	35,00 €
70011	406	42,00 €
70012	406	42,00 €
70013	406	44,00 €
70014	406	44,00 €
70015	406	44,00 €
70016	406	44,00 €
70017	406	44,00 €
90003	160	35,20 €
90004	160	25,80 €
JBMW-BEXP	362	24,50 €
METEXP	361, 406, 410	62,00 €
SERIE124	360	710,00 €
SERIE262	154, 184	199,00 €





www.jbmcamp.com



JBMprofessionaltools



@jbmtools



jbmtools



JBM Campllong S.L.U.

