



JBM®

IL TUO UTENSILE

PREZZI VALIDI A PARTIRE DAL
01/04/2024



2024



SET DI UTENSILI

7

VALIGETTE CON UTENSILI
VALIGETTE CON BUSSOLE
CASSETTE CON ATTREZZI
SET DI PUNTE
SET DI CRICCHETTI
SET DI ADATTATORI
SET DI BUSSOLE
SET DI PUNTE
UTENSILI ISOLATI



UTENSILI MANUALI

37

CHIAVI
MORSETTI
CRICCHETTI
CHIAVI DINAMOMETRICHE
BARRE DI ESTENSIONE
CACCIAVITI
PINZE
STRUMENTI DI ISPEZIONE
MARTELLI
UTENSILI DA TAGLIO
SCALPELLI
RIVETTATRICI
STRUMENTI DI MISURA
VARI



MOBILI DA OFFICINA

71

CARRELLI CON UTENSILI
MODULI CON UTENSILI
ACCESSORI/ RICAMBI
TAVOLI DA LAVORO
ARCHIVIAZIONE
SGABELLI / CARRELLO SOTTOAUTO
INCUDINI / MORSE DA BANCO



ELETTROUTENSILI A BATTERIA

101

AVVITARE
FORATURA
LEVIGARE / LUCIDARE
TAGLIARE / SEGARE
STRUMENTI SPECIALI
ELETTROUTENSILI PER GIARDINAGGIO
BATTERIE / CARICABATTERIE
ACCESSORI / MATERIALI DI CONSUMO



ILLUMINAZIONE

129

TORCE DA OFFICINA
FRONTALI
TORCE ELETTRICHE
FARI
ILLUMINAZIONE PER COFANO
GIROFARI
FARI DA LAVORO
SEGNALETICA
ACCESSORI E RICAMBI



UTENSILI PNEUMATICI

145

AVVITARE
FORATURA
TAGLIARE/SEGARE
LEVIGARE/LUCIDARE
PISTOLE AD ARIA COMPRESSA
MANUTENZIONE PNEUMATICI
ALTRO
AVVOLGITUBO/TUBI
CONNETTORI
ACCESSORI E MATERIALI DI CONSUMO



BUSSOLE PNEUMATICHE

167

SET DI BUSSOLE DI IMPATTO
UTENSILI PER RUOTE
ADATTATORI
RICAMBI BUSSOLE DI IMPATTO
UTENSILI PER CAMION



CARROZZERIA

179

PER CARROZZIERE
RESTAURO FANALI
SOSTITUZIONE PARABREZZA
RIPARAZIONE DEL TELAIO
MOBILIARIO AUSILIARIO
MANUTENZIONE INTERNA



FRENI

193

RIPOSIZIONATORI
SPURGOFRENI
MANUTENZIONE



UTENSILERIA

199

SISTEMA DI LUBRIFICAZIONE
SISTEMA DI INIEZIONE
BLOCCO / TESTATA
FRIZIONE
SISTEMA DI RAFFREDDAMENTO
SISTEMA IMPIANTO A/C
TRASMISSIONE
SOSPENSIONI
SISTEMA DI SCARICO
IMPIANTO ELETTRICO
RIPARAZIONE FILETTI
MOTO
ESTRATTORI



KIT DI MESSA IN FASE

243

FIAT/ALFA ROMEO
BMW/MINI
PSA
FORD
JAGUAR/LAND ROVER
JEEP/CHRYSLER

MERCEDES-BENZ
RENAULT/DACIA/NISSAN
OPEL/VAUXHALL
VAG
STRUMENTI AUSILIARI
ALTRI



LUBRIFICAZIONE / CARBURANTE

301

POMPE DI RIFORNIMENTO GASOLIO
POMPE DI RIFORNIMENTO UREA
POMPE DI ESTRAZIONE / RIEMPIMENTO
RACCOGLITORI DI OLIO
PISTOLE DI ASPIRAZIONE
VASCHE PER RACCOLTA D'OLIO
ALTRO



UTENSILI IDRAULICI

313

MARTINETTI
SOLLEVATORI A BOTTIGLIA
MARTINETTI A CRICCHETTO
MARTINETTI TELESCOPICI
CAVALLETTI
ALTRO
TRANSPALLET
PRESSE
GRU
TAVOLI ELEVATORI
CUSCINETTI PER PONTI SOLLEVATORI



UTENSILI ELETTRICI

327

AVVIATORI PER VEICOLI
MANUTENZIONE DELLA BATTERIA
MISURAZIONE DELLA CORRENTE
ISPEZIONE VISIVA
SALDATURA
ATTREZZATURA DA OFFICINA
ARIA CONDIZIONATA
TERMOMETRI
ALTRO



ENERGIA RINNOVABILE E MOBILITÀ DEL FUTURO

341

CAVI DI RICARICA PER AUTO ELETTRICHE
CARICABATTERIE PER AUTO ELETTRICHE
GENERATORE DI ENERGIA
STRUMENTI ISOLATI



ACCESSORI PER OFFICINA

347

AVVOLGITUBO
SCALE
CARRELLI E PIATTAFORME



ACCESSORI PER VEICOLI

353

SEGNALETICA
KIT DI EMERGENZA
LAMPADINE
KIT PRONTO SOCCORSO
SICUREZZA
SOFFIETTI E MORSETTI
TAPPETINI
TERGICRISTALLI
BICICLETTA
ALTRO
SENSORI DI PARCHEGGIO
TUBI FLESSIBILI



ACCESSORI PER PNEUMATICI

367

CONTRAPPESI
RIPARAZIONE DELLE FORATURE
VALVOLE PNEUMATICI
ESTRAZIONE E INSTALLAZIONE DI PNEUMATICI

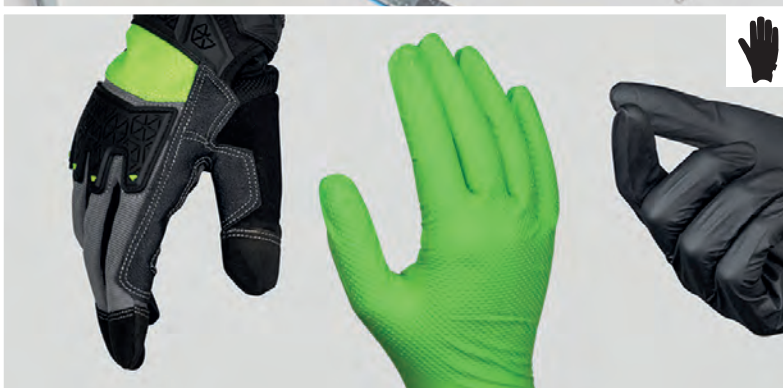

SICUREZZA E DPI

373

GUANTI / DPI
MASCERINE/DISTRIBUTORE GEL
DELIMITAZIONE
TRATTAMENTI DI OZONO



CONSUMABILI

381

PERNI E CIRCLIPS
RIVETTI
VITI, DADI E RONDELLE
RONDELLE CARTER E MOTORE
ALTRO
GUARNIZIONI E O-RING
CONNETTORI PER TUBI
ELETTRICI
RIVETTI DI PLASTICA



ABBIGLIAMENTO DA LAVORO

405

GILET
GIACCHE



PRODOTTI PROMOZIONALI

407

PRODOTTI PROMOZIONALI
ESPOSITORI / ACCESSORI
PACKAGING

JBM IL TUO UTENSILE

JBM È IL TUO MARCHIO DI UTENSILI PROFESSIONALI

Azienda leader specializzata nell'industria e nell'automotive

+7.000

PRODOTTI
DISPONIBILI

+23.000

EUROPALLET IN
MAGAZZINO

+68

ESPORTIAMO IN PIÙ
DI 68 STATI

+550

NUOVI PRODOTTI
ALL'ANNO

OLTRE 30 ANNI DI ESPERIENZA NEL SETTORE

In JBM siamo specialisti nella distribuzione di utensili e attrezzature automobilistiche, offrendo un servizio attento e di qualità ai nostri oltre 11.000 clienti in più di 68 stati.

ESPERTI IN DISTRIBUZIONE E LOGISTICA

JBM dispone di una rete logistica in costante miglioramento che consente una distribuzione rapida ed efficiente non solo nella penisola iberica ma anche a tutti i clienti internazionali.

AMPIA GAMMA DI PRODOTTI

Offriamo una gamma completa di oltre 7.000 articoli tra cui cassette di utensili, valigette degli attrezzi, tutti i tipi di utensili manuali, armadi con utensili, utensili da officina, illuminazione, kit materiali di consumo...



**SERVIZIO
DI QUALITÀ
APPROVATO DA PIÙ
DI 11.000 CLIENTI**

**CONSEGNE
INTERNAZIONALI
ESPORTIAMO IN
OLTRE 68 STATI**

**SEDE IN SPAGNA E
MAGAZZINO DI OLTRE
6.000 M²**

SET DI UTENSILI

- 9 VALIGETTE CON UTENSILI
- 17 VALIGETTE CON BUSSOLE
- 24 CASSETTE CON ATTREZZI
- 28 SET DI PUNTE
- 32 SET DI CRICCHETTI
- 32 SET DI ADATTATORI
- 33 SET DI BUSSOLE
- 34 SET DI PUNTE
- 35 UTENSILI ISOLATI



STRUMENTI DI ALTA QUALITÀ PER IL LAVORO QUOTIDIANO

01

PROGETTATO PER UNA
PRESTAZIONE OTTIMALE
IN TUTTI I TIPI DI LAVORO

02

MATERIALE RESISTENTE CON FINITURA
IN ACCIAIO CROMATO DI OTTIMA
QUALITÀ

03

IMPUGNATURA ERGONOMICA
DI GRANDE DIAMETRO PER UNA
MIGLIORE CAPACITÀ DI TORSIONE



54034

178,00€

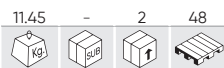

VALIGETTA DI UTENSILI DA 216 PEZZI CON BUSSOLE ESAGONALI SATINATE



FINITURA SATINATA

54045

179,00€

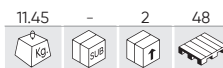

VALIGETTA DI UTENSILI DA 216 PEZZI CON BUSSOLE ESAGONALI CROMATE



FINITURA CROMATA



CONTIENE

	1/2" x14	13, 14, 15, 16, 17, 18, 19, 20, 21, 22, 24, 27, 30, 32mm
	3/8" x10	10, 11, 12, 13, 14, 15, 16, 17, 18, 19mm
	1/4" x13	4, 4.5, 5, 5.5, 6, 7, 8, 9, 10, 11, 12, 13, 14mm
	1/2" x5	16, 17, 18, 19, 22mm
	3/8" x6	10, 11, 12, 13, 14, 15mm
	1/4" x7	4, 5, 6, 7, 8, 9, 10mm
	1/2" x3	E20, E22, E24
	3/8" x6	E10, E11, E12, E14, E16, E18
	1/4" x5	E4, E5, E6, E7, E8
	1/2" x3	1/2" - 3/8" - 1/4"
	1/2" x2	125, 250mm
	3/8" x1	125mm
	1/4" x2	50, 100mm
	x3	1/2" - 3/8" - 1/4"
	1/2" x1	adattatore 3/8" H x 1/2" M
	1/2" x1	8mm
	3/8" x1	8mm
	1/4" x1	6mm

	1/2" x2	16, 21mm
	3/8" x1	18mm
	1/2" x12	8, 9, 10, 11, 12, 13, 14, 15, 16, 17, 18, 19mm
	1/2" x7	1.27, 1.5, 2, 2.5, 3, 4, 5mm
	1/4" x1	
	1/4" x1	
	1/4" x1	
	1/2" x1	T70
	1/2" x1	14mm
	x3	PH0, PH1, PH2
	x3	P20, P21, P22
	x4	3, 4, 5, 6mm
	x4	SL4, SL5.5, SL6.5, SL7
	x8	T8, T9, T10, T15, T20, T25, T27, T30
	x8	T8, T9, T10, T15, T20, T25, T27, T30

	8mm x4	7, 8, 10, 12mm
	6mm x6	2, 2.5, 3, 4, 5, 6mm
	8mm x3	SL8, SL10, SL12
	8mm x3	PH2, PH3, PH4
	8mm x3	P22, P23, P24
	8mm x5	T40, T45, T50, T55, T60
	6mm x3	T5, T6, T7
	8mm x5	T40, T45, T50, T55, T60
	6mm x1	T7
	8mm x4	M10, M11, M12, M13
	6mm x5	M5, M6, M7, M8, M9
	8mm x2	M10, M12
	6mm x3	M5, M6, M8
	8mm x1	TS50
	6mm x8	TS10, TS15, TS20, TS25, TS27, TS30, TS40, TS45
	x4	0, 1, 2, 3mm
	x3	6, 8, 10mm
	6mm x4	4, 6, 8, 10mm
	x3	1, 2, 3mm
	x4	1, 2, 3, 4mm
	6mm x1	1/4"

54250

188,00€

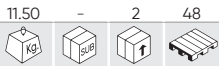

VALIGETTA DI UTENSILI CON 216 PEZZI CON BUSSELE POLIGONALI SATINATE



FINITURA SATINATA



RICAMBI DISPONIBILI



CONTIENE

	1/2" x14	13, 14, 15, 16, 17, 18, 19, 20, 21, 22, 24, 27, 30, 32mm
	3/8" x10	10, 11, 12, 13, 14, 15, 16, 17, 18, 19mm
	1/4" x13	4, 4.5, 5, 5.5, 6, 7, 8, 9, 10, 11, 12, 13, 14mm
	1/2" x5	16, 17, 18, 19, 22mm
	3/8" x6	10, 11, 12, 13, 14, 15mm
	1/4" x7	4, 5, 6, 7, 8, 9, 10mm
	1/2" x3	E20, E22, E24
	3/8" x6	E10, E11, E12, E14, E16, E18
	1/4" x5	E4, E5, E6, E7, E8
	1/2" x3	1/2" - 3/8" - 1/4"
	1/2" x2	125, 250mm
	3/8" x1	125mm
	1/4" x2	50, 100mm
	1/2" x3	1/2" - 3/8" - 1/4"
	1/2" x1	adattatore 3/8" H x 1/2" M

	1/2" x1	8mm
	3/8" x1	8mm
	1/4" x1	6mm
	1/2" x2	16, 21mm
	3/8" x1	18mm
	1/2" x12	8, 9, 10, 11, 12, 13, 14, 15, 16, 17, 18, 19mm
	1/2" x7	1.27, 1.5, 2, 2.5, 3, 4, 5mm
	1/4" x1	
	1/4" x1	
	1/4" x1	
	1/2" x1	T70
	1/2" x1	14mm
	x3	PH0, PH1, PH2
	x3	PZ0, PZ1, PZ2
	x4	3, 4, 5, 6mm
	1/4" x4	SL4, SL5.5, SL6.5, SL7
	x8	T8, T9, T10, T15, T20, T25, T27, T30
	x8	T8, T9, T10, T15, T20, T25, T27, T30

	8mm x4	7, 8, 10, 12mm
	6mm x6	2, 2.5, 3, 4, 5, 6mm
	8mm x3	SL8, SL10, SL12
	8mm x3	PH2, PH3, PH4
	8mm x3	PZ2, PZ3, PZ4
	8mm x5	T40, T45, T50, T55, T60
	6mm x3	T5, T6, T7
	8mm x5	T40, T45, T50, T55, T60
	6mm x1	T7
	8mm x4	M10, M11, M12, M13
	6mm x5	M5, M6, M7, M8, M9
	8mm x2	M10, M12
	6mm x3	M5, M6, M8
	8mm x1	TS50
	6mm x8	TS10, TS15, TS20, TS25, TS27, TS30, TS40, TS45
	x4	0, 1, 2, 3mm
	x3	6, 8, 10mm
	6mm x4	4, 6, 8, 10mm
	x3	1, 2, 3mm
	x4	1, 2, 3, 4mm
	6mm x1	1/4"

54082

189,00€

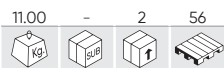

VALIGETTA PORTAUTENSILI DA 132 PEZZI CON BUSSOLE ESAGONALI SATINATE

132 PCS CrV

FINITURA SATINATA



SPECIALE AUTOMOTIVE



CONTIENE

	1/2" x7 19, 21, 22, 24, 27, 30, 32mm
	3/8" x12 8, 9, 10, 11, 12, 13, 14, 15, 16, 17, 18, 19mm
	1/4" x11 4, 5, 5.5, 6, 7, 8, 9, 10, 11, 12, 13mm
	3/8" x4 13, 14, 15, 17mm
	1/4" x4 8, 10, 12, 13mm
	3/8" x6 E8, E10, E11, E14, E16, E20
	1/2" x1
	3/8" x1
	1/4" x1
	1/2" x2 127, 254mm
	3/8" x2 76, 152mm
	1/4" x1 50mm
	x1 Ø14mm
	x1

	x1 3/8"(H) - 1/2"(M)
	x1 3/8"(H) - 1/2"(M)
	x1 3/8"(H) - 1/2"(M)
	1/2" x1
	3/8" x1
	1/4" x1
	1/2" x3 17, 19, 21mm
	1/4" x1 6mm
	x1
	x1 PH2x100
	x1 SL6x100
	x12 8, 9, 10, 11, 12, 13, 14, 15, 16, 17, 18, 19mm
	x1
	1/2" x1 H17
	x1

	1/2" x1 21mm
	3/8" x2 16, 18mm
	1/2" x1 T52
	1/2" x1 M16
	x2 5.5, 6.5mm
	x2 PH1, PH3
	3/8" x2 PZ1, PZ3
	x4 4, 5, 6, 8mm
	x6 T20, T30, T40, T45, T50, T55
	x3 4, 5, 6.5mm
	x3 PH1, PH2, PH3
	6mm x3 PZ1, PZ2, PZ3
	x4 3, 4, 5, 6
	x7 T10, T15, T20, T25, T27, T30, T40
	x9 1.5, 2, 2.5, 3, 4, 5, 6, 8, 10mm

SET DI UTENSILI

54035

149,00€

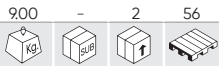

VALIGETTA DI UTENSILI DA 179 PEZZI CON BUSSOLE ESAGONALI SATINATE



FINITURA SATINATA

54046

150,00€

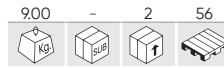

VALIGETTA DI UTENSILI 179 PEZZI CON BUSSOLE ESAGONALI CROMATE



FINITURA CROMATA



CONTIENE

	1/2" x17	10, 11, 12, 13, 14, 15, 16, 17, 18, 19, 20, 21, 22, 24, 27, 30, 32mm
	3/8" x10	10, 11, 12, 13, 14, 15, 16, 17, 18, 19mm
	1/4" x13	4, 4.5, 5, 5.5, 6, 7, 8, 9, 10, 11, 12, 13, 14mm
	1/2" x5	16, 17, 18, 19, 22mm
	3/8" x6	10, 11, 12, 13, 14, 15mm
	1/4" x7	4, 5, 6, 7, 8, 9, 10mm
	1/2" x2	E20, E24
	3/8" x6	E10, E11, E12, E14, E16, E18
	1/4" x5	E4, E5, E6, E7, E8
	1/2" x3	1/2" - 3/8" - 1/4"
	1/2" x2	125, 250mm
	3/8" x1	125mm
	1/4" x2	50, 100mm

	x3	1/2" - 3/8" - 1/4"
	1/2" x2	16, 21mm
	3/8" x1	18mm
	1/2" x1	8mm
	3/8" x1	8mm
	1/4" x1	6mm
	x7	1.27, 1.5, 2, 2.5, 3, 4, 5mm
	x1	1/4"
	x1	1/4"
	x3	PH1, PH2, PH3
	x3	PZ1, PZ2, PZ3
	x5	2, 3, 4, 5, 6mm
	x3	SL4, SL5.5, SL7
	x8	T8, T9, T10, T15, T20, T25, T27, T30
	x8	T8, T9, T10, T15, T20, T25, T27, T30

	x11	T5, T6, T7, T8, T9, T10, T15, T20, T25, T27, T30
	x9	T7, T10, T15, T20, T25, T27, T30, T40, T45
	x5	M5, M6, M7, M8, M9
	x3	M5, M6, M8
	x2	PH3, PH4
	x2	PZ3, PZ4
	x5	7, 8, 10, 12, 14mm
	x3	SL8, SL10, SL12
	x6	T40, T45, T50, T55, T60, T70
	x6	T40, T45, T50, T55, T60, T70

54036

99,00€

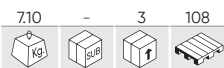

VALIGETTA DI UTENSILI DA 113 PEZZI CON BUSSOLE ESAGONALI SATINATE



FINITURA SATINATA

54047

100,00€



VALIGETTA DI UTENSILI 113 PEZZI CON BUSSOLE POLIGONALI CROMATE



FINITURA CROMATA



CONTIENE

	1/2"	x17	10, 11, 12, 13, 14, 15, 16, 17, 18, 19, 20, 21, 22, 24, 27, 30, 32mm
	1/4"	x13	4, 4.5, 5, 5.5, 6, 7, 8, 9, 10, 11, 12, 13, 14mm
	1/2"	x5	14, 15, 17, 19, 22mm
	1/4"	x8	6, 7, 8, 9, 10, 11, 12, 13mm
	1/2"	x8	E10, E11, E12, E14, E16, E18, E20, E24
	1/4"	x5	E4, E5, E6, E7, E8
		x2	1/2" - 1/4"
	1/2"	x2	125, 250mm
	1/4"	x2	50, 100mm

		x2	1/2" - 1/4"
	1/2"	x1	adattatore 3/8" H x 1/2" M
	1/2"	x1	8mm
		x5	7, 8, 10, 12, 14mm
		x3	SL8, SL10, SL12
		x2	PH3, PH4
	8mm	x2	PZ3, PZ4
		x5	T40, T45, T50, T55, T60
		x5	5, 6, 8, 10, 12mm

	1/2"	x2	16, 21mm
		x3	1.5, 2, 2.5mm
		x1	1/4"
		x1	1/4"
		x2	PH1, PH2
		x2	PZ1, PZ2
	1/4"	x4	3, 4, 5, 6mm
		x3	SL4, SL5.5, SL6.5
		x7	T8, T10, T15, T20, T25, T27, T30



SET DI UTENSILI

54037

88,00€

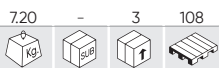

VALIGETTA DI UTENSILI 108 PEZZI CON
BUSSOLE ESAGONALI SATINATE



FINITURA SATINATA

54048

89,00€

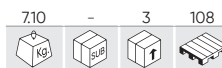

VALIGETTA DI UTENSILI 108 PEZZI CON
BUSSOLE ESAGONALI CROMATE



FINITURA CROMATA



RICAMBI
DISPONIBILI



RICAMBI
DISPONIBILI

CONTIENE

	1/2"	x17	10, 11, 12, 13, 14, 15, 16, 17, 18, 19, 20, 21, 22, 24, 27, 30, 32mm
	1/4"	x13	4, 4.5, 5, 5.5, 6, 7, 8, 9, 10, 11, 12, 13, 14mm
	1/2"	x5	14, 15, 17, 19, 22mm
	1/4"	x8	6, 7, 8, 9, 10, 11, 12, 13mm
	1/2"	x8	E10, E11, E12, E14, E16, E18, E20, E24
	1/4"	x5	E4, E5, E6, E7, E8
	1/2"	x2	1/2" - 1/4"
	1/2"	x2	125, 250mm
	1/4"	x2	50, 100mm
	1/2"	x2	1/2" - 1/4"
	1/2"	x1	adattatore 3/8" H x 1/2" M

	1/2"	x2	16, 21mm
	1/2"	x1	8mm
		x3	1.5, 2, 2.5mm
		x1	1/4"
		x1	1/4"
		x2	PH3, PH4
		x2	PZ3, PZ4
	8mm	x5	7, 8, 10, 12, 14mm
		x3	SL8, SL10, SL12
		x5	T40, T45, T50, T55, T60

		x2	PH1, PH2
		x2	PZ1, PZ2
	1/4"	x4	3, 4, 5, 6mm
		x3	SL4, SL5.5, SL6.5
		x7	T8, T10, T15, T20, T25, T27, T30

54038

88,00€

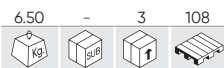

VALIGETTA DI UTENSILI 94 PEZZI CON
BUSSOLE ESAGONALI SATINATE



FINITURA SATINATA



RICAMBI
DISPONIBILI

54049

89,00€



VALIGETTA DI UTENSILI 94 PEZZI CON
BUSSOLE ESAGONALI CROMATE



FINITURA CROMATA



RICAMBI
DISPONIBILI

CONTIENE

	1/2"	x18	10, 11, 12, 13, 14, 15, 16, 17, 18, 19, 20, 21, 22, 23, 24, 27, 30, 32mm
	1/4"	x13	4, 4.5, 5, 5.5, 6, 7, 8, 9, 10, 11, 12, 13, 14mm
	1/2"	x4	14, 15, 17, 19mm
	1/4"	x8	6, 7, 8, 9, 10, 11, 12, 13mm
	1/2"	x2	1/2" - 1/4"
	1/2"	x2	125, 250mm
	1/4"	x2	50, 100mm
		x2	1/2" - 1/4"
	1/2"	x1	adattatore 3/8" H x 1/2" M

	1/2"	x1	8mm
		x3	1.5, 2, 2.5mm
	1/2"	x2	16, 21mm
		x2	PH3, PH4
		x2	PZ3, PZ4
	8mm	x4	8, 10, 12, 14mm
		x3	SL8, SL10, SL12
		x4	T40, T45, T50, T55
	8mm	x1	1/4"

		x1	1/4"
		x1	1/4"
		x1	1/4"
		x2	PH1, PH2
		x2	PZ1, PZ2
	1/4"	x4	3, 4, 5, 6mm
		x3	SL4, SL5.5, SL7
		x6	T8, T10, T15, T20, T25, T30

53212

174,00€

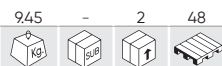

VALIGIA PORTAUTENSILI DA 303 PEZZI CON BUSSOLE ESAGONALI SATINATE

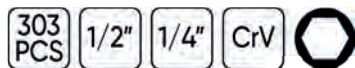

FINITURA SATINATA



CONTIENE

	x18	10, 11, 12, 13, 14, 15, 16, 17, 18, 19, 20, 21, 22, 23, 24, 27, 30, 32mm
	x2	125, 250mm
	x2	16, 21mm
	x1	8mm
	x1	adattatore 3/8" H x 1/2" M
	x1	UNIVERSAL
	x1	72
	x13	4, 4.5, 5, 5.5, 6, 7, 8, 9, 10, 11, 12, 13, 14mm
	x2	50, 100mm
	x1	6,3mm
	x1	1/4"
	x1	UNIVERSAL
	x1	72
	x8	T25, T27, T30, T35, T40 (x2), T45, T50
	x2	PH3, PH4
	x2	PZ3, PZ4
	x4	H5.5, H6.5, H7, H8
	x4	5.5, 6.5, 7, 8mm
	x4	5, 6, 8, 10mm

	x9	3, 4, 4.5, 5, 5.5, 6, 6.5, 7, 8mm
	x9	T8, T10, T15, T20, T25, T27, T30, T35, T40
	x9	H1.5, H2, H2.5, H3, H.4, H5, H5.5, H6, H8
	x3	5, 6, 8mm
	x4	1, 2, 3, 4
	x3	6, 8, 10
	x3	C1, C2, C3
	x6	2, 2.5, 3, 4, 5, 6mm
	x4	S0, S1, S2, S3
	x6	5/64, 3/32, 7/64, 1/8, 9/64, 5/32
	x4	4, 6, 8, 10mm
	x10	PH0 (x2), PH1 (x2), PH2 (x4), PH3 (x2)
	x10	PZ0 (x2), PZ1 (x2), PZ2 (x4), Z3 (x2)
	x10	1/16, 5/64, 3/32, 7/64, 1/8, 9/64, 5/32, 3/16, 7/32, 1/4
	x10	T8, T10, T15, T20, T25, T27, T30, T35, T40, T45
	x6	1.5, 2, 2.5, 3, 3.5, 4mm
	x4	PH000, PH00, PH0, PH1
	x2	PZ0, PZ1
	x8	T5, T6, T7, T8, T9, T10, T15, T20

	x1		x1	300g
	x1		x1	
	x10		x1	
	x1		x23	
	x1	3m		x22
	x1			x10
	x1	8"		x10
	x2	0.4x2.5, 0.5x3.0x50mm		
	x3	PH0x50, PH00x50, PH000x50mm		
	x2	0.8x4x100, 1.2x6.5x125mm		
	x2	PH1x80, PH2x100mm		
	x7	1.27, 1.5, 2, 2.5, 3, 4, 5mm		
	x13	1.5, 2, 2.5, 3, 3.2, 3.5, 4, 4.5, 4.8, 5, 5.5, 6, 6.5mm		



54106

89,00€

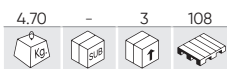

VALIGETTA DI UTENSILI IN POLLICI SATINATI DA 37 PEZZI



FINITURA SATINATA



RICAMBI DISPONIBILI

CONTIENE

	1/2" x17	5/16", 3/8", 7/16", 1/2", 9/16", 19/32", 5/8", 11/16", 3/4", 13/16", 7/8", 15/16", 1", 1-1/16", 1-1/8", 1-3/16", 1-1/4"		1/2" x2	5" - 10"
	1/4" x8	3/16", 7/32", 1/4", 9/32", 5/16", 11/32", 3/8", 7/16"		1/4" x1	3"
	x2	1/2" - 1/4"		x1	1/2" - 1/4"
	x2	16, 21mm		x1	1/4"

53074

78,00€



VALIGETTA DI UTENSILI DA 74 PEZZI CON BUSSOLE POLIGONALI SATINATE

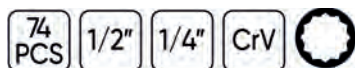

FINITURA SATINATA



RICAMBI DISPONIBILI



CONTIENE

	1/2" x18	10, 11, 12, 13, 14, 15, 16, 17, 18, 19, 20, 21, 22, 23, 24, 27, 30, 32mm
	1/4" x10	4, 5, 5.5, 6, 7, 8, 10, 11, 12, 13mm
	x2	1/2" - 1/4"
	x2	125, 250mm
	1/4" x1	100mm
	x1	1/2"
	x5	PH0, PH1, PH2, PH3, PH4
	x5	PZ0, PZ1, PZ2, PZ3, PZ4
	x6	3, 4, 5, 6, 8, 10mm
	x5	SL3, SL4, SL5.5, SL6, SL7
	x8	T8, T10, T15, T20, T25, T27, T30, T40
	x4	4, 5, 6, 7mm
	1/2" x1	adattatore 3/8" H x 1/2" M
	1/2" x1	21mm
	x3	1.5, 2, 2.5mm
	x1	1/4"
	1/4" x1	6mm

54140

36,00€



VALIGETTA DI UTENSILI DA 56 PEZZI CON BUSSOLE POLIGONALI SATINATE



FINITURA SATINATA



RICAMBI DISPONIBILI



CONTIENE

	x13	4, 4.5, 5, 5.5, 6, 7, 8, 9, 10, 11, 12, 13, 14mm
	x1	T2
	x2	50, 100mm
	x1	1/4"
	x1	
	x1	
	x1	
	x1	
	x4	SL4, SL5, SL6, SL7
	x3	M5, M6, M8
	x8	T8, T10, T15, T20, T25, T27, T30, T40
	x8	T8, T10, T15, T20, T25, T27, T30, T40
	x3	PH0, PH1, PH2
	x3	PZ0, PZ1, PZ2
	x6	3, 4, 5, 6, 7, 8mm



SET DI UTENSILI

54108

66,00€

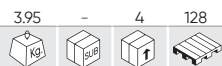

VALIGETTA DI UTENSILI DA 22 PEZZI CON BUSSOLE ESAGONALI DA 1/2" SATINATE

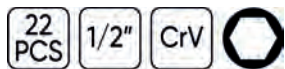

FINITURA SATINATA



RICAMBI DISPONIBILI



CONTIENE

	1/2"	x17	10, 11, 12, 13, 14, 15, 16, 17, 18, 19, 20, 21, 22, 24, 27, 30, 32mm
	1/2"	x1	
	1/2"	x2	75, 125mm
		x1	3/8" (H) - 1/2" (M)
		x1	1/2"

54116

66,00€



VALIGETTA DI UTENSILI DA 22 PEZZI CON BUSSOLE POLIGONALI 1/2" SATINATE

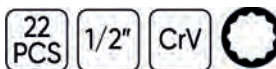

FINITURA SATINATA



RICAMBI DISPONIBILI



CONTIENE

	1/2"	x17	10, 11, 12, 13, 14, 15, 16, 17, 18, 19, 21, 22, 24, 27, 30, 32mm
		x1	1/2"
	1/2"	x2	125, 250mm
		x1	
	1/2"	x1	3/8" (H) - 1/2" (M)

51818

109,00€

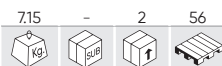

VALIGETTA DI UTENSILI DA 72 PEZZI CON BUSSOLE ESAGONALI SATINATE



FINITURA SATINATA



RICAMBI DISPONIBILI

CONTIENE

	1/2"	x13	10, 11, 12, 13, 14, 15, 17, 19, 22, 24, 27, 30, 32mm
	1/4"	x10	4, 5, 6, 7, 8, 9, 10, 11, 12, 13mm
	1/4"	x5	5, 6, 7, 8, 9mm
		x1	1/2"
		x1	1/4"
	1/2"	x1	125mm
	1/4"	x1	75mm

		x1	
		x1	300gr
		x1	
		x1	
		x4	SL3, SL4, SL5, SL6
	6mm	x3	PH1, PH2, PH3
		x7	T10, T15, T20, T25, T27, T30, T40

		x2	1/2" - 1/4"
	1/2"	x2	16, 21mm
	1/4"	x1	6mm
		x8	10, 11, 12, 13, 14, 15, 17, 19mm
		x3	1.5, 2, 2.5mm
		x1	1/4"
		x2	PH2x100, PH1x40mm
		x3	8x200, 6x100, 6x40mm

54258

58,00€



VALIGETTA DI UTENSILI DA 77 PEZZI SATINATI



FINITURA SATINATA



CONTIENE

	x5 PH0, PH1, PH2, PH2, PH3		x1
	x5 PZ0, PZ1, PZ2, PZ2, PZ3		x10
	x5 SL3, SL4, SL5, SL5.5, SL6mm		x1
	x5 T10, T15, T20, T25, T30		x1
	x4 6x7, 8x9, 10x11, 12x13mm		x1
	x9 1.5, 2, 2.5, 3, 4, 5, 6, 8, 10mm		x1
	x3 PH2x100, PH00x50, PH000x50		x1
	x3 SL6x100, SL2.5x50, SL3.0x50		x10
	x1		x10



54277

53,50€

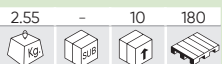

VALIGETTA DI UTENSILI 59 PEZZI CON BUSSOLE 3/8" ESAGONALI SATINATE

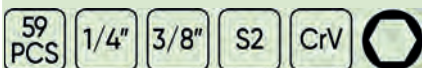

FINITURA SATINATA



RICAMBI DISPONIBILI

CONTIENE

	3/8" x17	6, 7, 8, 9, 10, 11, 12, 13, 14, 15, 16, 17, 18, 19, 20, 21, 22mm		x2	PH3, PH4		x2	PH1, PH2
	x1	3/8"		x2	PZ3, PZ4		x2	PZ1, PZ2
	3/8" x2	75, 150mm		x5	7, 8, 10, 12, 14mm		x4	3, 4, 5, 6mm
	3/8" x1	8mm		x3	SL8, SL10, SL12		x3	SL4, SL5.5, SL6.5
	3/8" x1	8mm		x5	T40, T45, T50, T55, T60		x7	T8, T10, T15, T20, T25, T27, T30
	x1	3/8"						
	x1	1/4"						

53953

29,00€

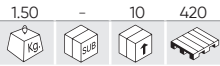

VALIGETTA DA 130 PEZZI CON BUSSOLE E PUNTE SATINATE

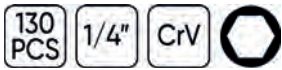

FINITURA SATINATA



IN ESPOSITORE DA 10 UNITÀ



RICAMBI DISPONIBILI

CONTIENE

		1/4"	x13	4, 4.5, 5, 5.5, 6, 7, 8, 9, 10, 11, 12, 13, 14mm
		1/4"	x1	1/4"
		1/4"	x1	50mm
		1/4"	x1	1/4"
		1/4"	x1	6mm
		1/4"	x1	1/4"
		1/4"	x1	1/4"
		1/4"	x7	1.27, 1.5, 2, 2.5, 3, 4, 5mm

	25mm	x10	T8, T10, T15, T20, T25, T27, T30, T35, T40, T45
	25mm	x9	T8, T10, T15, T20, T25, T27, T30, T35, T40
	25mm	x3	M5, M6, M8
	25mm	x3	6, 8, 10mm
	25mm	x3	C1, C2, C3
	25mm	x4	1, 2, 3, 4mm
	25mm	x4	4, 6, 8, 10mm
	25mm	x4	0, 1, 2, 3mm

	25mm	x10	1/16, 5/64, 3/32, 7/64, 1/8, 9/64, 5/32, 3/16, 7/32, 1/4
	25mm	x9	1.5, 2, 2.5, 3, 4, 5, 5.5, 6, 8mm
	25mm	x6	5/64, 3/32, 7/64, 1/8, 9/64, 5/32
	25mm	x6	2, 2.5, 3, 4, 5, 6mm
	25mm	x9	3, 4, 4.5, 5, 5.5, 6, 6.5, 7, 8mm
	50mm	x2	4, 6mm
	25mm	x10	PH0(x2), PH1(x2), PH2(x4), PH3(x2)
	50mm	x2	PH1, PH2
	25mm	x10	P20(x2), PZ1(x2), PZ2(x4), PZ3(x2)

54109

34,00€

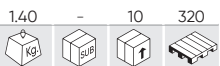

VALIGETTA DA 46 PEZZI CON BUSSOLE ESAGONALI SATINATE



FINITURA SATINATA



RICAMBI DISPONIBILI



CONTIENE

		1/4"	x13	4, 4.5, 5, 5.5, 6, 7, 8, 9, 10, 11, 12, 13, 14mm
		1/4"	x1	
		1/4"	x1	
		1/4"	x1	
		1/4"	x2	50, 100mm
			x4	1.27, 1.5, 2.0, 2.5mm
			x1	
			x1	UNIVERSAL
			x1	1/4"
			x3	SL4, SL5.5, SL7
			x3	PH1, PH2, PH3
			x3	PZ1, PZ2, PZ3
			x6	H3, H4, H5, H6, H7, H8
			x6	T10, T15, T20, T25, T30, T40

54168

49,00€

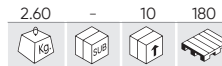

VALIGETTA DA 59 PEZZI DA 3/8" CON BUSSOLE POLIGONALI SATINATE



FINITURA SATINATA



RICAMBI DISPONIBILI



CONTIENE

		x2	PH3, PH4
		x2	PZ3, PZ4
	8mm	x5	7, 8, 10, 12, 14mm
		x3	8, 10, 12mm
		x5	T40, T45, T50, T55, T60
		x2	PH1, PH2
		x2	PZ1, PZ2
	1/4"	x4	3, 4, 5, 6mm
		x3	4, 5.5, 6.5mm
		x7	T8, T10, T15, T20, T25, T27, T30
		x17	6, 7, 8, 9, 10, 11, 12, 13, 14, 15, 16, 17, 18, 19, 20, 21, 22mm
		x1	3/8"
		x2	75, 150mm
		x1	8mm
		x1	8mm
		x1	3/8"
		x1	1/4"

54105

33,00€



VALIGETTA DA 59 PEZZI DA 3/8" CON BUSSELE POLIGONALI SATINATE



FINITURA SATINATA



CONTIENE

	1/4"	x13	4, 4.5, 5, 5.5, 6, 7, 8, 9, 10, 11, 12, 13, 14mm		x4	SL4, SL5, SL6, SL7
	1/4"	x1			x3	M5, M6, M8
	1/4"	x2	50, 100mm		x8	6mm T8, T10, T15, T20, T25, T27, T30, T40
	1/4"	x1			x8	T8, T10, T15, T20, T25, T27, T30, T40
	1/4"	x1			x8	T8, T10, T15, T20, T25, T27, T30, T40
	1/4"	x1			x1	6mm 1/4"
	1/4"	x1	6mm		x3	PH0, PH1, PH2
	6mm	x3	PZ0, PZ1, PZ2		x6	3, 4, 5, 6, 7, 8mm

52418

179,00€



VALIGETTA DI UTENSILI GO-THROUGH DA 39 PEZZI CROMATI



FINITURA CROMATA

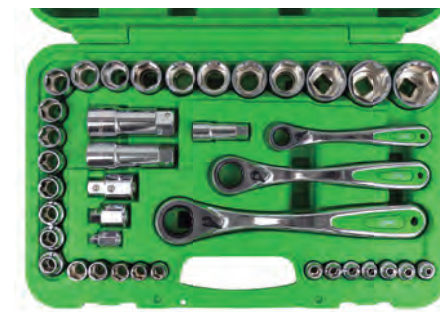

CONTIENE

	13mm	x12	4, 4.5, 5, 5.5, 6, 7, 8, 9, 10, 11, 12, 13mm		1/4"	x1	13mm
	19mm	x10	10, 11, 12, 13, 14, 15, 16, 17, 18, 19mm		3/8"	x1	19mm
	22mm	x5	20, 21, 22, 23, 24mm		1/2"	x1	22mm
	22mm	x3	27, 30, 32mm		1/2"	x3	13, 19, 22mm
	1/2"	x3	13, 19, 22mm		1/2"	x3	13, 19, 22mm

54090

56,00€



VALIGETTA DI UTENSILI GO-THROUGH DA 14 PEZZI SATINATI

FINITURA SATINATA



CONTIENE

	x11	13, 14, 15, 16, 17, 18, 19, 21, 22, 24, 27mm
	x1 (75mmL)	12,5mm
	x1	1/2"
	x1 (go-through)	

50623

60,00€

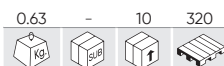

VALIGETTA DA 17 PEZZI GO-THROUGH CROMATI

FINITURA CROMATA

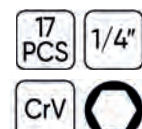

CONTIENE

	x13	4, 4.5, 5, 5.5, 6, 7, 8, 9, 10, 11, 12, 13, 14mm
	x1	75mm
	x1	1/4"
	x1	145mm

SET DI UTENSILI

52722

87,00€

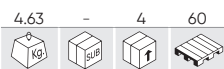

VALIGETTA DI UTENSILI DA 61 PEZZI CON
BUSSOLE SPLINE DA 1/2" E 1/4" SATINATE



FINITURA SATINATA



RICAMBI
DISPONIBILI



CONTIENE

	1/2" x11	14, 15, 16, 17, 18, 19, 22, 24, 27, 30, 32mm
	1/4" x12	4, 4.5, 5, 5.5, 6, 7, 8, 9, 10, 11, 12, 13mm
	x2	1/2" - 1/4"
	1/2" x2	5" - 10"
	1/4" x2	2" - 4"
	x2	1/2" - 1/4"

	x1	adattatore 3/8" H x 1/2" M
	1/2" x2	16, 21mm
	x1	25mm
	x3	1.5, 2, 2.5mm
	x1	1/4"
	x1	1/4"
	x1	AD

	x3	PH1, PH2, PH3
	x3	PZ1, PZ2, PZ3
	x5	25mm 3, 4, 5, 6, 8mm
	x3	SL4, SL5.5, SL7
	x5	T10, T15, T20, T25, T30

53915

65,00€

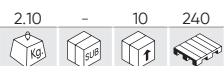

SET DI 6 BUSSOLE 1/2" TORX TIPO E EXTRA
LUNGHE SATINATE

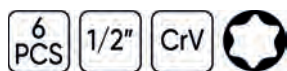

FINITURA SATINATA



CONTIENE

	1/2" x6	E10, E12, E14, E16, E18, E20
--	---------	------------------------------

E12 testa a bussola per testata del blocco del cilindro BMW:
- Motore M42, 1,8 l, 4 cilindri, 16 V, modello 318 (1989)
- Motore M50, 2,0 l, 2,5 l, 6 cilindri, 24 V, modelli 520i, 525i (1991)

53108

92,00€



VALIGETTA DI UTENSILI DA 61 PEZZI CON
BUSSOLE SPLINE DA 1/2" E 1/4" CROMATE



FINITURA CROMATA



RICAMBI
DISPONIBILI



54141

42,00€

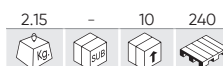

SET DI 28 BUSSOLE TORX CORTE E LUNGHE
SATINATE

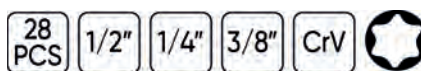

FINITURA SATINATA



CONTIENE

	1/4" x5 (25mm)	E4, E5, E6, E7, E8
	3/8" x5 (28mm)	E10, E11, E12, E14, E16
	1/2" x4 (38mm)	E18, E20, E22, E24
	1/4" x5 (50mm)	E4, E5, E6, E7, E8
	3/8" x5 (63mm)	E10, E11, E12, E14, E16
	1/2" x4 (76mm)	E18, E20, E22, E24



RICAMBI
DISPONIBILI



51616 378,00€

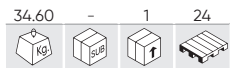

VALIGETTA IN METALLO CON 22 PEZZI AUTOCLAVE ESAGONALI DA 1" SATINATI

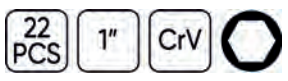

FINITURA SATINATA



SCATOLA METALLICA
CONTIENE

	1"	x17	36, 38, 41, 46, 50, 54, 55, 58, 60, 63, 65, 67, 70, 71, 75, 77, 80mm
	1"	x1	650mm
	1"	x2	205, 410mm
	1"	x1	
	1"	x1	



51855 378,00€



VALIGETTA IN METALLO CON 22 PEZZI AUTOCLAVE DA 1" POLIGONALI SATINATI

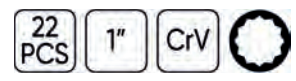

FINITURA SATINATA



SCATOLA METALLICA
CONTIENE

	1"	x17	36, 38, 41, 46, 50, 54, 55, 58, 60, 63, 65, 67, 70, 71, 75, 77, 80mm
	1"	x1	650mm
	1"	x2	205, 410mm
	1"	x1	
	1"	x1	



53727 198,00€

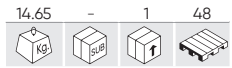

VALIGETTA DI UTENSILI CON 21 PEZZI ESAGONALI DA 3/4" SATINATI

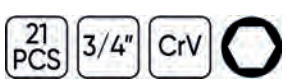

FINITURA SATINATA



CONTIENE

	3/4"	x16	19, 21, 22, 23, 24, 26, 27, 29, 30, 32, 35, 36, 38, 41, 46, 50mm
	3/4"	x1	495mm
	3/4"	x3	100, 200, 400mm
	3/4"	x1	445mm



53728 198,00€

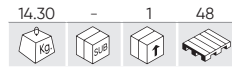

VALIGETTA DI UTENSILI CON 21 PEZZI DA 3/4" POLIGONALI SATINATI

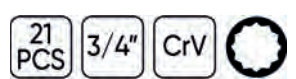

FINITURA SATINATA



CONTIENE

	3/4"	x16	19, 21, 22, 23, 24, 26, 27, 29, 30, 32, 35, 36, 38, 41, 46, 50mm
	3/4"	x1	495mm
	3/4"	x3	100, 200, 400mm
	3/4"	x1	445mm



SET DI UTENSILI

54261



321,00€

N

CASSETTA IN METALLO CON UTENSILI 143 PEZZI SATINATI



FINITURA SATINATA



RICAMBI DISPONIBILI

CONTIENE

	x13	4, 4.5, 5, 5.5, 6, 7, 8, 9, 10, 11, 12, 13, 14mm
	x6	8, 10, 11, 12, 13, 14mm
	x7	E4, E5, E6, E7, E8, E10, E11
	x2	2", 4"
	x1	110mmL
	1/4"	x1
	x1	150L
	x3	PH1, PH2, PH3
	x3	SL4, SL5.5, SL6.5
	x6	TT10, TT15, TT20, TT25, TT30, TT40
	x6	H3, H4, H5, H6, H7, H8
	x1	
	x1	250mm

	x20	8, 9, 10, 11, 12, 13, 14, 15, 16, 17, 18, 19, 20, 21, 22, 23, 24, 27, 30, 32mm
	x2	5" - 10"
	1/2"	x2 16, 21mm
	x1	UNIVERSAL
	x1	3/8"(F) - 1/2"(M)
	1/2"	x2
	1/4"	x2
	x12	6, 7, 8, 9, 10, 11, 12, 13, 14, 17, 19, 22mm
	x8	6*7, 8*9, 10*11, 12*13, 14*15, 16*17, 18*19, 20*22mm
	x1	7"-180mm
	x1	8"-200mm

	x4	SL5*75, SL6*100, SL8*150, SL10*200mmL
	x3	PH1*80, PH2*100, PH3*150mmL
	x4	PH1, PH2*2, PH3
	x4	PZ1, PZ2*2, PZ3
	x4	SL3, SL4, SL5, SL6
	x4	H3, H4, H5, H6
	x7	T10, T15, T20, T25, T27, T30, T40
	x7	TT10, TT15, TT20, TT25, TT27, TT30, TT40
	x1	1/4"
	x1	6.35mm*60mmL
	x1	1/4"-6.35mm
	x1	7"-180mm
	x1	10"-250mm

53565



258,00€

CASSETTA IN FERRO CON UTENSILI 64 PEZZI SATINATI



FINITURA SATINATA

CONTIENE

	1/2"	x18	10, 11, 12, 13, 14, 15, 16, 17, 18, 19, 20, 21, 22, 23, 24, 27, 30, 32mm
	7/8"	x1	1/2"
	x1	1/2"	
	1/2"	x3	76, 127, 254mm
	1/2"	x1	255mm
	1/2"	x1	21mm
	x1	457mm	
	x18	6, 7, 8, 9, 10, 11, 12, 13, 14, 15, 16, 17, 18, 19, 20, 21, 22, 24mm	
	x9	1.5, 2, 2.5, 3, 4, 5, 6, 8, 10mm	
	x3	PH1x100, PH2x150, H3x200mm	
	x3	SL5x100, SL6x150, SL8x200mm	
	x1	250mm	x1 180mm
	x1	200mm	x1 180mm



RICAMBI DISPONIBILI

53159

289,00€

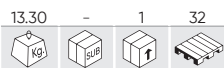

VALIGETTA IN ALLUMINIO CON UTENSILI 159 PEZZI SATINATI



FINITURA SATINATA



CONTIENE



	1/2" x14	14, 15, 16, 17, 18, 19, 20, 21, 22, 23, 24, 27, 30, 32mm
	1/4" x10	4, 5, 6, 7, 8, 9, 10, 11, 12, 13mm
	x2	1/4" - 1/2"
	1/2" x2	50, 100mm
	1/4" x2	125, 250mm
	1/4" x1	150mm
	x2	1/4" - 1/2"
	1/2" x1	adattatore 3/8" H x 1/2" M
	x2	1/4" - 1/2"
	1/4" x1	250mm
	1/4" x1	110mm
	1/2" x2	16, 21mm
	x1	1/4"

	x9	8, 10, 11, 12, 13, 15, 17, 19, 22mm
	x9	1.5, 2, 2.5, 3, 4, 5, 6, 8, 10mm
	x1	100-250V
	x1	
	x2	PH1x80, PH2x10mm
	x4	SL3x75, SL4x100, SL6.5x125, SL8x150mm
	x1	PH00x50mm
	x1	SL2.5x50mm
	x1	250mm
	x1	200mm
	x1	160mm
	x1	7" (180mm)
	x1	180mm
	x1	220mm
	x1	160mm
	x1	160mm

	x1	
	x6	1,5mm
	x1	
	x1	300gr
	x1	3m
	x1	200mm
	x5	
	x1	18mm
	x10	
	x40	6.35mm
	x15	8mm



53928

278,00€

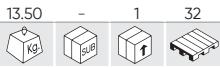

VALIGETTA DI UTENSILI DA 135 PEZZI CON BUSSELE ESAGONALI SATINATE



FINITURA SATINATA



CONTIENE



	x10	10, 11, 12, 13, 14, 15, 17, 19, 22, 24mm
	x2	16, 21mm
	x1	UNIVERSAL
	x2	125, 250mm
	x1	3/8" - 1/2"
	x1	
	x9	4, 5, 6, 7, 8, 9, 10, 11, 12mm
	x1	UNIVERSAL
	x1	
	x2	50, 100mm
	x1	6mm
	x9	8, 10, 11, 12, 13, 14, 17, 19, 22mm
	x1	150mm
	x1	

	x4	PH1, PH2, PH2, PH3
	x4	PZ1, PZ2, PZ2, PZ3
	x4	SL3, SL4, SL5, SL6
	x4	H3, H4, H5, H6
	x7	TT10, TT15, TT20, TT25, TT27, T30, T40
	x7	TT10, TT15, TT20, TT25, TT27, TT30, TT40
	x1	6mm
	x1	6mmL
	x5	
	x1	
	x2	PH1x80mm, PH2x100mm, SL3.0x75mm, SL4.0x100mm, SL6.5x125mm, SL8x150mm
	x4	

	x1	
	x1	
	x3	SL1.5, SL2, SL3, PH000, PH00, PH0, PH1, T4, T5, T6, T7, T8, T10, T15, T20
	x4	
	x8	T8, T10, T15, T20
	x4	TS0.8, TS1.2, TS1.5, TS2.0
	x1	H2.0
	x1	
	x1	
	x1	
	x9	1.5, 2, 2.5, 3, 4, 5, 6, 8, 10mm
	x1	
	x1	5m
	x1	300g

	x1	250mm
	x1	180mm
	x1	180mm
	x1	200mm
	x1	160mm
	x1	200mm
	x1	
	x3	
	x1	18mm

53444

195,00€

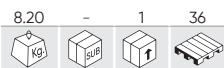

VALIGETTA IN ALLUMINIO CON UTENSILI 108 PEZZI CON BUSSOLE 1/2" SATINATE

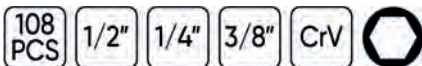

FINITURA SATINATA



CONTIENE



	x9	10, 11, 12, 13, 14, 15, 17, 18, 19mm
	x2	75, 150mm
	x1	16mm
	x1	adattatore 3/8" H x 1/2" M
	x8	4, 4.5, 5, 5.5, 6, 7, 8, 9mm
	x1	150mmL
	x1	6mm
	x2	PH1x80, PH2x100mm
	x4	SL3.5x75, SL4x100, SL6.5x125, SL8x150mm
	x1	PH00x50mm
	x1	SL2.5x50mm
	x1	

	x9	6x7, 8x9, 10x11, 12x13, 14x15, 16x17, 18x19, 20x22mm
	x9	1.5, 2, 2.5, 3, 4, 5, 6, 8, 10mm
	x1	
	x6	
	x1	200mm
	x1	18mm
	x10	
	x1	220mm
	x1	180mm
	x1	160mm
	x1	250mm
	x1	160mm

	x30	
	x1	
	x1	300g
	x1	3m



52603

74,00€

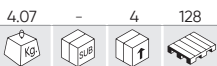

VALIGETTA DI INSERTI PER VITI POLIGONALI 26 PEZZI



RICAMBI DISPONIBILI

CONTIENE

	x8 (55mmL)	M5, M6, M8, M9, M10, M12, M14, M16
	x7 (100mmL)	M5, M6, M8, M9, M10, M12, M14
	x7 (140mmL)	M5, M6, M8, M9, M10, M12, M14
	x4 (200mmL)	M8, M10, M12, M14

52606

88,00€



VALIGETTA DI INSERTI PER VITI RIBE 32 PEZZI

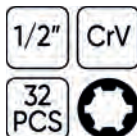

RICAMBI DISPONIBILI

CONTIENE

	x9 (55mmL)	M5, M6, M7, M8, M9, M10, M12, M13, M14
	x9 (100mmL)	M5, M6, M7, M8, M9, M10, M12, M13, M14
	x7 (140mmL)	M7, M8, M9, M10, M12, M13, M14
	x7 (200mmL)	M7, M8, M9, M10, M12, M13, M14

52604

78,00€

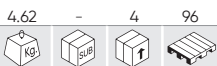

VALIGETTA DI INSERTI ESAGONALI 30 PEZZI

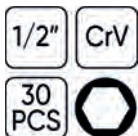

RICAMBI DISPONIBILI

CONTIENE

	x9 (55mmL)	5, 6, 7, 8, 10, 12, 14, 17, 19mm
	x8 (100mmL)	5, 6, 7, 8, 10, 11, 12, 13mm
	x7 (140mmL)	5, 6, 7, 8, 10, 12, 14mm
	x6 (200mmL)	5, 6, 7, 8, 10, 12mm

52605

76,00€



VALIGETTA DI INSERTI PER VITI TORX 32 PEZZI



RICAMBI DISPONIBILI

CONTIENE

	x10 (55mmL)	T20, T25, T27, T30, T40, T45, T50, T55, T60, T70
	x10 (100mmL)	T20, T25, T27, T30, T40, T45, T50, T55, T60, T70
	x6 (140mmL)	T40, T45, T50, T55, T60, T70
	x6 (200mmL)	T40, T45, T50, T55, T60, T70



54266

39,50€

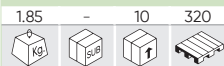

N

VALIGETTA DI BUSSOLE E INSERTI TORX 1/2" 19 PEZZI



CONTIENE

	x9	E10, E11, E12, E14, E16, E18, E20
	x10	T20, T25, T27, T30, T40, T45, T50, T55, T60, T70



RICAMBI DISPONIBILI

54154

37,50€



SET DI 12 PEZZI 1/2" INSERTI TORX

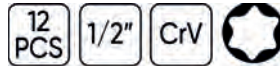

CONTIENE

	x6	T20, T25, T30, T40, T45, T50
	x6	T55, 60, T70, T80, T90, T100



RICAMBI DISPONIBILI

51260

37,00€



SET DI 12 PEZZI 1/2" INSERTI ESAGONALI

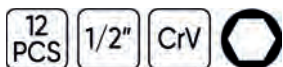

CONTIENE

	x6	H5, H6, H7, H8, H10, H12
	x1	H14
	x5	H16, H17, H18, H19, H20



RICAMBI DISPONIBILI

54164

34,00€



SET DI 12 PEZZI 1/2" INSERTI POLIGONALI

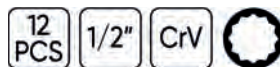

CONTIENE

	x6 (55mmL)	M4, M5, M6, M8, M9
	x6 (70mmL)	M10, M12, M14, M16, M18, M20



RICAMBI DISPONIBILI



SET DI UTENSILI

50983

48,00€



VALIGETTA CON 42 CHIAVI PER VITI TORX, TRIPLE SQUARE E A BRUGOLA STANDARD

42 PCS 1/2"
3/8" S-2



CONTIENE

	3/8"	x1	10mm
	1/2"	x1	10mm
	30mm	x7	4, 5, 6, 7, 8, 10, 12mm
	75mm	x7	4, 5, 6, 7, 8, 10, 12mm
	30mm	x8	T20, T25, T30, T40, T45, T50, T55, T60
	75mm	x8	T20, T25, T30, T40, T45, T50, T55, T60
	30mm	x5	M5, M6, M8, M10, M12
	75mm	x5	M5, M6, M8, M10, M12



RICAMBI DISPONIBILI

50985

59,00€



VALIGETTA CON 42 CHIAVI PER VITI TORX, TRIPLE SQUARE E A BRUGOLA STANDARD ANTIMANOMISSIONE

42 PCS 1/2"
3/8" S-2



CONTIENE

	3/8"	x1	10mm
	1/2"	x1	10mm
	30mm	x7	4, 5, 6, 7, 8, 10, 12mm
	75mm	x7	4, 5, 6, 7, 8, 10, 12mm
	30mm	x8	T20, T25, T30, T40, T45, T50, T55, T60
	75mm	x8	T20, T25, T30, T40, T45, T50, T55, T60
	30mm	x5	M5, M6, M8, M10, M12
	75mm	x5	M5, M6, M8, M10, M12



RICAMBI DISPONIBILI

52550

92,00€



VALIGETTA CON 75 CHIAVI PER VITI RIBE, ESAGONALE, TORX E TORX ANTIMANOMISSIONE

75 PCS 1/2"
3/8" S-2

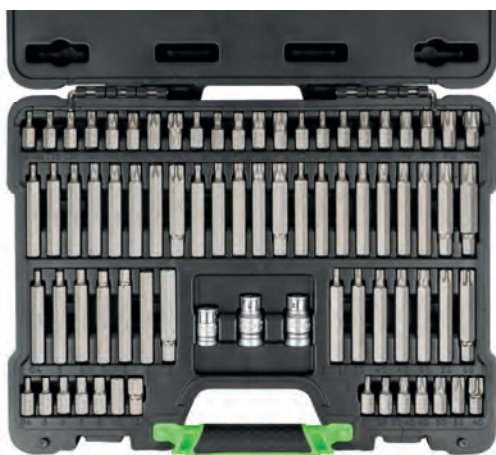

RICAMBI DISPONIBILI

CONTIENE

	3/8"	x1	10mm
	1/2"	x2	10mm
	30mm	x7	4, 5, 6, 7, 8, 10, 12mm
	75mm	x7	4, 5, 6, 7, 8, 10, 12mm
	30mm	x8	T20, T25, T30, T40, T45, T50, T55, T60
	75mm	x8	T20, T25, T30, T40, T45, T50, T55, T60
	30mm	x5	M5, M6, M8, M10, M12
	75mm	x5	M5, M6, M8, M10, M12
	30mm	x8	R5, R6, R7, R8, R9, R10, R12, R14
	75mm	x8	R5, R6, R7, R8, R9, R10, R12, R14
	30mm	x8	TT20, TT25, TT30, TT40, TT45, TT50, TT55, TT60
	75mm	x8	TT20, TT25, TT30, TT40, TT45, TT50, TT55, TT60

52753

107,00€



VALIGETTA CON 55 INSERTI PER VITI

55 PCS 1/2"
3/8" S-2



RICAMBI DISPONIBILI

CONTIENE

	3/8"	x1	10mm
	1/2"	x2	10, 14mm
	30mm	x9	4, 5, 6, 7, 8, 10, 12, 14, 16mm - ISO 2136
	75mm	x9	4, 5, 6, 7, 8, 10, 12, 14, 16mm - ISO 2136
	30mm	x10	T20, T25, T30, T40, T45, T50, T55, T60, T70, T80 - DIN 2325
	75mm	x10	T20, T25, T30, T40, T45, T50, T55, T60, T70, T80 - DIN 2325
	30mm	x7	M5, M6, M8, M10, M12, M14, M16 - DIN 2325
	75mm	x7	M5, M6, M8, M10, M12, M14, M16 - DIN 2325



52539

59,00€

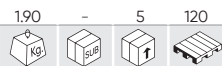

SET DI INSERTI IN ASSORTIMENTO



CONTIENE

	x10	PH3, PH4
	x10	PZ3, PZ4
	x25	7, 8, 10, 12, 14mm
	x15	SL8, SL10, SL12
	x25	T40, T45, T50, T55, T60



52538

62,00€



SET DI INSERTI A BUSSOLA GIRAVITE



CONTIENE

	x10	PH1, PH2
	x10	PZ1, PZ2
	x20	3, 4, 5, 6mm
	x15	SL4, SL5.5, SL6.5
	x35	T8, T10, T15, T20, T25, T27, T30



53574

47,00€

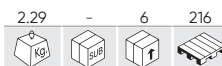

VALIGETTA DI INSERTI CON 208 PEZZI



CONTIENE

	x12	1.5, 2, 2.5, 3, 3.5, 4, 4.5, 5, 5.5, 6, 7, 8mm
	x10	1/16, 5/64, 3/32, 7/64, 1/8, 9/64, 5/32, 3/16, 7/32, 1/4
	x5	2.5, 3, 4, 5, 6mm
	x5	2.5, 3, 4, 5, 6mm
	x18	PH00, PH0, PH1(x5), PH2(x5), PH3(x5), PH4
	x3	PH1, PH2, PH3
	x3	PH1, PH2, PH3
	x17	PZ00, PZ0, PZ1(x5), PZ2(x5), PZ3(x4), PZ4
	x3	PZ1, PZ2, PZ3
	x3	PZ1, PZ2, PZ3
	x14	T5, T6, T7, T8, T9, T10, T15, T20, T25, T27, T30, T35, T40, T45
	x7	T10, T15, T20, T25, T27, T30, T40
	x7	T10, T15, T20, T25, T27, T30, T40

	x3	6, 8, 10mm
	x3	6, 8, 10mm
	x4	4, 6, 8, 10mm
	x4	4, 6, 8, 10mm
	x4	1, 2, 3, 4mm
	x4	1, 2, 3, 4mm
	x6	2, 2.5, 3, 4, 5, 6mm
	x6	5/64, 3/32, 7/64, 1/8, 9/64, 5/32
	x13	T5, 6, 7, 8, 9, 10, 15, 20, 25, 27, 30, 40, 45
	x3	1, 2, 3mm
	x4	0, 1, 2, 3mm
	x3	M5, M6, M8
	x9	TS10, TS15, TS20, TS25, TS27, TS30, TS40, TS45, TS50



	x12	SL2, SL2.5, SL3, SL3.5, SL4, SL4.5, SL5, SL5.5, SL6, SL6.5, SL7, SL8
	x10	4, 5, 6, 7, 8, 9, 10, 11, 12, 13
	x10	5/32, 3/16, 7/32, 1/4, 9/32, 5/16, 11/32, 3/8, 7/16, 1/2
	x1	1/4"
	x1	
	x1	

52620

8,80€

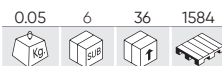

PORTAINSERI ANGOLARE

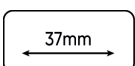

- Per zone difficili da raggiungere.
- Con la funzione presa rapida.
- Estrarre facilmente.
- Trapano 6mm.

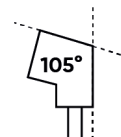

SET DI UTENSILI

53156

26,20€

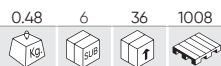

VALIGETTA CON 38 PEZZI E CRICCHETTO MINI DA 1/4"



RICAMBI DISPONIBILI



CONTIENE

		1/4" x11	4, 4.5, 5, 6, 7, 8, 9, 10, 11, 12, 13mm		x5	4, 5, 6, 7, 8mm
		1/4" x1			x3	SL6, SL8, SL10
		x2	PH3, PH4		x8	T8, T9, T10, T15, T20, T25, T30, T40
		x2	PZ3, PZ4		x4	M5, M6, M9, M10
		x1	1/4"		x1	1/4"

52198

37,70€



VALIGETTA CON 37 PEZZI E CRICCHETTO MINI DA 1/4"



RICAMBI DISPONIBILI



CONTIENE

		1/4" x11	4, 4.5, 5, 6, 7, 8, 9, 10, 11, 12, 13mm		x5	4, 5, 6, 7, 8mm
		1/4" x1			x3	SL6, SL8, SL10
		x2	PH3, PH4		x8	T8, T9, T10, T15, T20, T25, T30, T40
		x2	PZ3, PZ4		x4	M5, M6, M9, M10
		x1	1/4"		x1	1/4"

51333

18,00€



SET DI 6 ADATTATORI

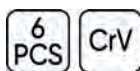

RICAMBI DISPONIBILI

REF.	mm				€
11360	1/4H - 3/8M	0.03	10	100	2,60€
11361	1/4M - 3/8H	0.03	5	300	3,20€
11362	1/2H - 3/4M	0.14	10	100	5,20€
11363	3/8H - 1/2M	0.50	10	100	3,90€
11364	1/2H - 3/8M	0.05	10	100	4,50€
11365	3/4H - 1/2M	0.14	10	100	9,40€

53743

39,70€

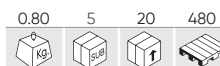

SET DI 6 TESTE AD URTO



RICAMBI DISPONIBILI

REF.	mm				€
14749	1/4"H - 3/8"M	0.03	20	200	2,00€
14750	3/8"H - 1/4"M	0.05	20	100	2,00€
14751	3/8"H - 1/2"M	0.15	20	100	4,00€
14752	1/2"H - 3/8"M	0.16	10	100	4,00€
11962	1/2"H - 3/4"M	0.17	10	100	7,50€
11964	3/4"H - 1/2"M	0.35	10	100	12,50€



52714 15,70€

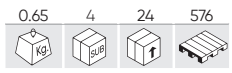

SET DI INSERTI 1/2" ESAGONALI

10 PCS 1/2" CrV

10, 11, 12, 13, 14, 15, 16, 17, 18, 19mm



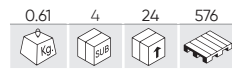

52716 15,90€



SET DI INSERTI 1/2" POLIGONALI

10 PCS 1/2" CrV

10, 11, 12, 13, 14, 15, 16, 17, 18, 19mm



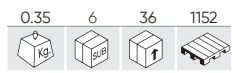

52715 10,00€



SET DI INSERTI 1/4" ESAGONALI

13 PCS 1/4" CrV

4, 4.5, 5, 5.5, 6, 7, 8, 9, 10, 11, 12, 13, 14mm



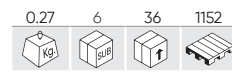

52717 11,00€



SET DI INSERTI 1/4" POLIGONALI

13 PCS 1/4" CrV

4, 4.5, 5, 5.5, 6, 7, 8, 9, 10, 11, 12, 13, 14mm



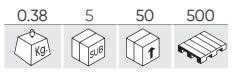

51410 36,00€



SET 6 PEZZI 1/2" INSERTI TORX ANTIMANOMISSIONE

6 PCS 1/2" CrV

T55, T60, T70, T80, T90, T100



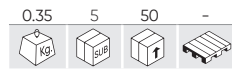

51409 36,00€



SET 6 PEZZI 1/2" INSERTI POLIGONALI ANTIMANOMISSIONE E INSERTI XZN

6 PCS 1/2" CrV

M10, M12, M14, M16, M18, M20



SET DI UTENSILI

52909

12,50€



SET DI INSERTI 1/4" 18 PEZZI



RICAMBI DISPONIBILI

CONTIENE

	x2 PH1, PH2		x3 SL4, SL5.5, SL6.5
	x2 PZ1, PZ2		x7 T8, T10, T15, T20, T25, T27, T30
	x4 3, 4, 5, 6mm		

52908

17,00€



SET DI INSERTI 1/4" 30 PEZZI

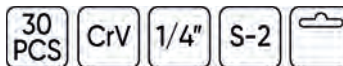

RICAMBI DISPONIBILI

CONTIENE

	x3 PH0, PH1, PH2		x4 SL4, SL5.5, SL6.5, SL7
	x3 PZ0, PZ1, PZ2		x8 T8, T9, T10, T15, T20, T25, T27, T30
	x4 3, 4, 5, 6mm		x8 T8, T9, T10, T15, T20, T25, T27, T30

53084

24,00€

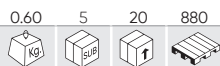

SET DI INSERTI TORX 3/8" - 1/2"

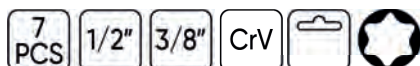

RICAMBI DISPONIBILI

	x2 T55, T60, T70		x5 T30, T40, T45, T50
--	------------------	--	-----------------------

53127

12,00€

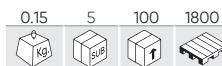

SET DI INSERTI TORX 1/4" ANTIMANOMISSIONE



RICAMBI DISPONIBILI

	x7 T10, T15, T20, T25, T30, T40, T45
--	--------------------------------------

51746

12,00€

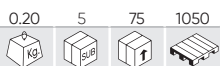

SET DI INSERTI TS A 5 PUNTE ANTIMANOMISSIONE



	x7 TS10, TS15, TS20, TS25, TS30, TS40, TS45
--	---

50980

22,00€

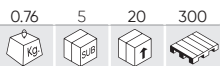

SET DI INSERTI RIBE



	x2 100mm M12, M13, M14		x5 90mm M6, M7, M8, M10
--	------------------------	--	-------------------------

50982

22,00€

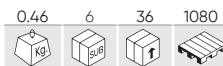

SET DI INSERTI A BRUGOLA CON TESTA A SFERA



	x7 100mm HB3 4, 5, 6, 7, 8, 10mm
--	----------------------------------

52320

22,00€

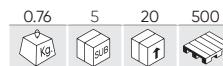

SET DI INSERTI POLIGONALI



	x2 100mm M12, M13, M14		x5 90mm M6, M7, M8, M10
--	------------------------	--	-------------------------

12029

5,50€

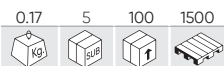

BUSSOLA PUNTA XZN 1/2"
ANTIMANOMISSIONE M16X58MM SP. VAG

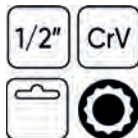

12030

6,50€



BUSSOLA PUNTA XZN 1/2"
ANTIMANOMISSIONE M16X100MM SP. VAG



INSERTI POLIGONALI EXTRALUNGHI 800mm 1/2"

REF.	DESCRIZIONE					€
52059	Ø 8mm - 800mm	0.57	-	25	1750	29,00€
52060	Ø 10mm - 800mm	0.57	-	25	1750	32,00€
53667	Ø 12mm - 800mm	0.80	10	20	-	32,00€
53668	Ø 14mm - 800mm	1.05	10	20	-	34,00€



54091

441,00€



VALIGETTA DI UTENSILI ISOLATI VDE 26 PEZZI

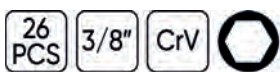

CONTIENE

	3/8" x10	8, 10, 11, 12, 13, 14, 16, 17, 18, 19, 21, 22mm
	3/8" x1	200mm
	1/2" x1	125mm
	3/8" x1	200mm

54093

441,00€



MODULO IN EVA CON UTENSILI ISOLATI VDE 25 PEZZI



	x6	7x8, 8x9, 10x10, 12x12, 14x14, 17x15, 6mm
	x1	185mm

SET DI UTENSILI

15162

30,20€



SET DI 8 CACCIAVITI ISOLATI VDE IN MODULO EVA IN FIBRA DI CARBONIO



RICAMBI DISPONIBILI

REF.	Ø	kg	10	50	€
15227	0.5x3.0x75mm	0,02	10	50	3,50€
15228	0.8x4.0x100mm	0,05	10	50	4,00€
15229	1.0x5.5x125mm	0,08	5	50	5,00€
15230	1.2x6.5x150mm	0,11	5	50	5,00€
15231	PH0x75mm	0,02	10	50	3,50€
15232	PH1x80mm	0,05	10	50	4,00€
15233	PH2x100mm	0,08	5	50	5,00€
15234	Circuit De Tester Auto 140mm	0,02	10	50	3,00€

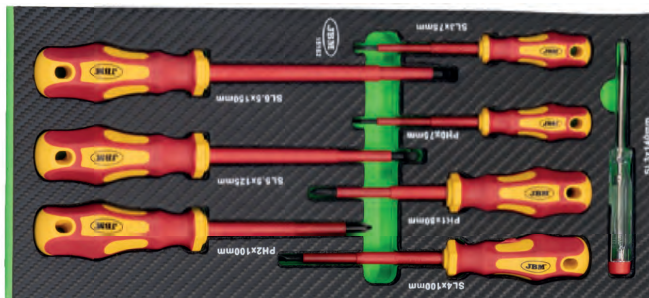

- ⊖ x4 0.5x3.0x75, 0.8x4.0x100, 1.0x5.5x125, 1.2x6.5x150mm
- ⊕ x3 PH0x75, PH1x80, PH2x100mm
- ⚡ x1 SL3x140mm

53154

462,00€



VALIGETTA DI UTENSILI ISOLATI 20 PEZZI DA 3/8"



CONTIENE

⊖	3/8"	x12	8, 10, 11, 12, 13, 14, 16, 17, 18, 19, 21, 22mm
⊕	3/8"	x1	200mm
⊕	3/8"	x2	125, 250mm
⊕	3/8"	x1	200mm
⊕	3/8"	x4	75mm, 4, 5, 6, 8mm



52519

25,50€

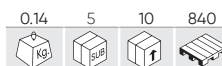

SET DI 7 CACCIAVITI ISOLATI 1.000V



CONTIENE

- ⊕ x2 PH00x50, PH0x50mm
- ⊖ x5 SL1.5x0.23x50, SL1.8x0.30x50, SL2.0x0.40x50, SL2.5x0.40x50, SL3.0x0.50x50mm

COLTELLO ISOLATO

REF.	DESCRIZIONE	kg	6	36	1152	€
53164	DRITTO	0.10	6	36	1152	16,50€
53165	CURVO	0.10	6	36	1152	19,60€



UTENSILI MANUALI

- 38 CHIAVI
- 48 MORSETTI
- 49 CRICCHETTI
- 51 CHIAVI DINAMOMETRICHE
- 53 BARRE DI ESTENSIONE
- 53 CACCIAVITI
- 56 PINZE
- 62 STRUMENTI DI ISPEZIONE
- 63 MARTELLI
- 64 UTENSILI DA TAGLIO
- 65 SCALPELLI
- 66 RIVETTATRICI
- 68 STRUMENTI DI MISURA
- 69 VARI

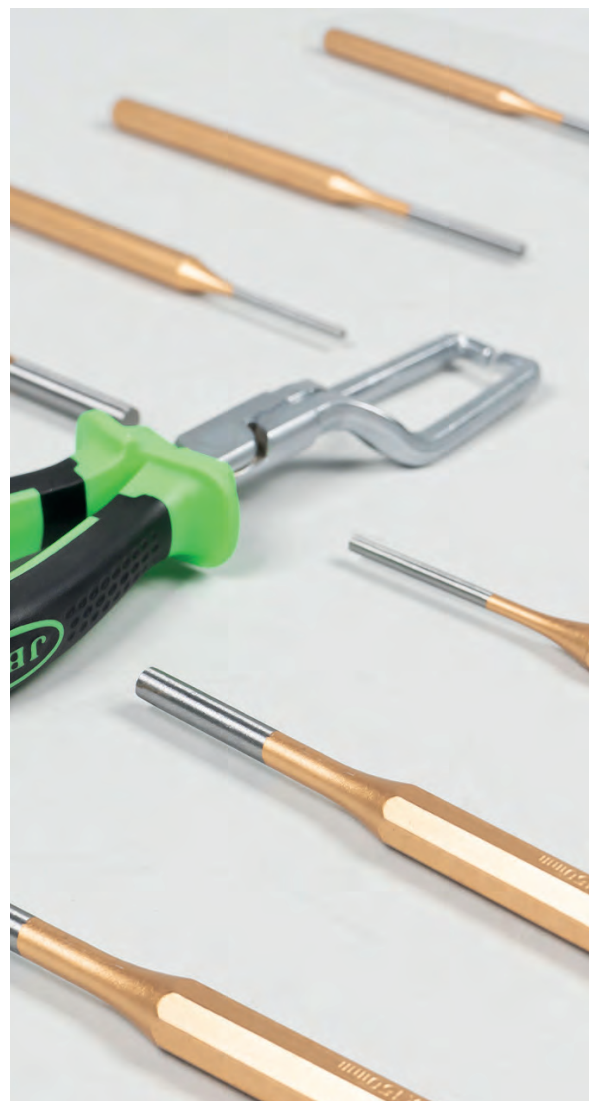

54101

61,00€



SET DI 6 CHIAVI CON CRICCHETTO



8x9, 10x11, 12x13,
14x15, 16x18, 17x19mm



RICAMBI DISPONIBILI

REF.	mm	Kg	Box	Box	€
15632	8x9	0.04	10	100	9,00€
15633	10x11	0.07	10	100	9,50€
15634	12x13	0.11	10	100	11,00€

REF.	mm	Kg	Box	Box	€
15635	14x15	0.13	10	100	12,50€
15636	16x18	0.19	10	100	14,00€
15637	17x19	0.25	10	100	15,00€

53017

57,00€

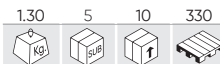

SET DI 7 CHIAVI COMBinate A CRICCHETTO SNODATE



8, 10, 11, 13,
14, 17, 19 mm



RICAMBI DISPONIBILI

REF.	mm	Kg	Box	Box	€
10552	8	0.06	10	100	7,10€
10554	10	0.09	10	100	7,50€
10555	11	0.09	10	100	7,80€
10557	13	0.13	10	100	8,10€

REF.	mm	Kg	Box	Box	€
10558	14	0.14	5	100	9,35€
10561	17	0.22	10	100	11,00€
10563	19	0.28	10	100	12,50€

54117

74,00€

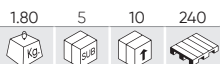

SET DI 12 CHIAVI COMBinate A CRICCHETTO



8, 9, 10, 11, 12, 13, 14, 15,
16, 17, 18, 19 mm



RICAMBI DISPONIBILI

REF.	mm	Kg	Box	Box	€
13465	8	0.05	10	100	5,55€
13466	9	0.06	10	100	5,55€
13467	10	0.10	10	100	6,00€
13468	11	0.08	10	100	6,25€
13469	12	0.09	10	100	6,25€
13470	13	0.10	10	100	6,60€

REF.	mm	Kg	Box	Box	€
13471	14	0.11	10	100	6,90€
13472	15	0.13	10	100	7,25€
13473	16	0.15	10	100	8,10€
13474	17	0.19	10	100	8,70€
13475	18	0.22	10	100	9,10€
13476	19	0.22	10	100	9,60€

51318

98,00€

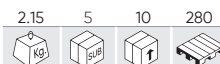

SET DI 12 CHIAVI COMBinate A CRICCHETTO SNODATE



8, 9, 10, 11, 12, 13, 14,
15, 16, 17, 18, 19 mm



RICAMBI DISPONIBILI

REF.	mm	Kg	Box	Box	€
10552	8	0.06	10	100	7,10€
10553	9	0.07	10	100	7,35€
10554	10	0.09	10	100	7,50€
10555	11	0.09	10	100	7,80€
10556	12	0.11	10	100	8,10€
10557	13	0.13	10	100	8,10€

REF.	mm	Kg	Box	Box	€
10558	14	0.14	5	100	9,35€
10559	15	0.16	10	100	9,50€
10560	16	0.19	5	50	10,60€
10561	17	0.22	10	100	11,00€
10562	18	0.26	5	100	12,30€
10563	19	0.28	10	100	12,50€

54338

60,00€



CHIAVE A CRICCHETTO CON TESTA INTERCAMBIABILE 12 PEZZI

RICAMBI DISPONIBILI

REF.	mm				€	REF.	mm				€
16391	8	0.01	30	100	4,60€	16397	14	0.05	30	100	5,50€
16392	9	0.05	30	100	4,60€	16398	15	0.05	30	100	5,50€
16393	10	0.05	30	100	4,60€	16399	16	0.05	30	100	5,50€
16394	11	0.05	30	100	5,10€	16401	17	0.05	30	100	6,10€
16395	12	0.05	30	100	5,10€	16402	18	0.05	30	100	6,10€
16396	13	0.05	30	100	5,10€	16403	19	0.10	30	100	6,10€



N

15316

58,00€



SET DI 3 CHIAVI A 72 DENTI - TIPO 4-IN-1



RICAMBI DISPONIBILI

REF.	mm				€
15515	12-13mm x 8-10mm	0.15	10	50	15,50€
15516	14-15mm x 9-11mm	0.20	10	50	19,00€
15517	18-19mm x 16-17mm	0.40	5	50	22,50€

54066

83,00€



MODULO DI 7 CHIAVI A CRICCHETTO EXTRA LUNGHE



RICAMBI DISPONIBILI

REF.	mm				€	REF.	mm				€
13453	8	0.10	6	36	9,00€	13457	14	0.25	6	36	12,00€
13454	10	0.15	10	100	9,50€	13460	17	0.40	6	24	15,00€
13455	12	0.20	6	36	10,50€	13462	19	0.50	6	24	17,00€
13456	13	0.20	6	36	11,50€						

54032

84,00€



MODULO DI 12 CHIAVI MINI COMBinate ARTICOLATE CON CRICCHETTO



RICAMBI DISPONIBILI

REF.	mm				€	REF.	mm				€
15328	8	0.05	12	96	6,00€	15334	14	0.11	12	96	7,00€
15329	9	0.05	12	96	5,50€	15335	15	0.13	12	96	7,50€
15330	10	0.05	12	96	5,50€	15336	16	0.14	12	96	8,00€
15331	11	0.07	12	96	5,50€	15337	17	0.16	12	96	8,50€
15332	12	0.09	12	96	6,00€	15338	18	0.18	12	96	9,00€
15333	13	0.10	12	96	6,50€	15339	19	0.20	12	96	9,50€

15122

74,00€



MODULO EVA IN CARBONIO CON 12 CHIAVI A CRICCHETTO ARTICOLATE



RICAMBI DISPONIBILI

REF.	mm				€	REF.	mm				€
13465	8	0.05	10	100	5,55€	13471	14	0.11	10	100	6,90€
13466	9	0.06	10	100	5,55€	13472	15	0.13	10	100	7,25€
13467	10	0.10	10	100	6,00€	13473	16	0.15	10	100	8,10€
13468	11	0.08	10	100	6,25€	13474	17	0.19	10	100	8,70€
13469	12	0.09	10	100	6,25€	13475	18	0.22	10	100	9,10€
13470	13	0.10	10	100	6,60€	13476	19	0.22	10	100	9,60€

53018

119,00€



SET DI 6 CHIAVI A CRICCHETTO SNODATE

6 PCS **72**

8x9, 10x11, 12x13, 14x15, 16x18, 17x19mm

ARTICULADA
ARTICULATED

RICAMBI DISPONIBILI

REF.	mm	kg	box	box	€
13447	8x9	0.10	6	36	16,50€
13448	10x11	0.15	6	36	17,50€
13449	12x13	0.25	6	36	20,00€

REF.	mm	kg	box	box	€
13450	14x15	0.30	6	36	23,00€
13451	16x18	0.35	6	24	28,00€
13452	17x19	0.40	6	24	29,50€



54110

46,00€

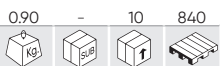

SET DI 8 CHIAVI COMBinate CORTE CON CRICCHETTO

8 PCS **72**

10, 11, 12, 13, 14, 15, 17, 19mm

RICAMBI DISPONIBILI

REF.	mm	kg	box	box	€
13491	10	0.05	10	100	5,30€
13492	11	0.06	10	100	5,35€
13493	12	0.07	10	100	5,50€
13494	13	0.08	5	100	6,00€

REF.	mm	kg	box	box	€
13495	14	0.09	10	100	6,40€
13496	15	0.12	10	100	6,60€
13497	17	0.14	10	100	7,50€
13498	19	0.19	10	100	8,50€



54041

198,00€

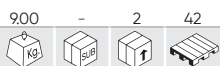

SET DI 22 CHIAVI COMBINATI A CRICCHETTO

22 PCS **90**

6, 7, 8, 9, 10, 11, 12, 13, 14, 15, 16, 17, 18, 19, 20, 21, 22, 23, 24, 27, 30, 32mm

RICAMBI DISPONIBILI

REF.	mm	kg	box	box	€
13463	6	0.03	10	100	5,30€
13464	7	0.04	10	100	5,30€
13465	8	0.05	10	100	5,55€
13466	9	0.06	10	100	5,55€
13467	10	0.10	10	100	6,00€
13468	11	0.08	10	100	6,25€
13469	12	0.09	10	100	6,25€
13470	13	0.10	10	100	6,60€
13471	14	0.11	10	100	6,90€
13472	15	0.13	10	100	7,25€
13473	16	0.15	10	100	8,10€

REF.	mm	kg	box	box	€
13474	17	0.19	10	100	8,70€
13475	18	0.22	10	100	9,10€
13476	19	0.22	10	100	9,60€
13477	20	0.23	6	60	9,85€
13478	21	0.37	6	60	12,20€
13479	22	0.37	6	60	13,10€
13480	23	0.37	6	48	15,50€
13481	24	0.53	6	48	15,80€
13482	27	0.60	6	24	22,10€
13483	30	0.80	6	24	25,50€
13484	32	1.12	6	24	27,20€



54079

83,00€

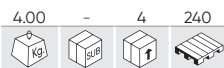

SET DI 21 CHIAVI COMBinate

21 PCS 6, 7, 8, 9, 10, 11, 12, 13, 14, 15, 16, 17, 18, 19, 20, 21, 22, 24, 27, 30, 32mm

RICAMBI DISPONIBILI

REF.	mm	kg	box	unit	€
10531	10	0.05	10	100	3,00€
10532	11	0.06	10	100	2,70€
10533	12	0.07	10	100	3,00€
10534	13	0.08	10	100	3,25€
10535	14	0.10	10	100	3,50€
10536	15	0.10	10	100	3,65€
10537	16	0.11	10	100	3,90€
10538	17	0.14	10	100	4,30€
10539	18	0.16	10	100	4,75€

REF.	mm	kg	box	unit	€
10540	19	0.20	10	100	5,25€
10541	20	0.21	6	60	5,55€
10542	21	0.25	-	50	5,85€
10543	22	0.25	-	50	7,00€
10544	24	0.33	10	100	8,10€
10545	27	0.41	10	50	9,75€
10546	30	0.52	-	25	11,60€
10547	32	0.59	-	25	13,50€
10548	6	0.03	10	100	1,75€

REF.	mm	kg	box	unit	€
10549	7	0.03	10	100	2,00€
10550	8	0.03	10	100	2,15€
10551	9	0.04	10	100	2,15€



54097

38,90€

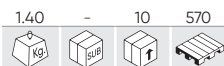

SET DI 14 CHIAVI COMBinate

14 PCS CrV 6, 7, 8, 9, 10, 11, 12, 13, 14, 15, 16, 17, 18, 19 mm

RICAMBI DISPONIBILI

REF.	mm	kg	box	unit	€
10531	10	0.05	10	100	3,00€
10532	11	0.06	10	100	2,70€
10533	12	0.07	10	100	3,00€
10534	13	0.08	10	100	3,25€
10535	14	0.10	10	100	3,50€
10536	15	0.10	10	100	3,65€
10537	16	0.11	10	100	3,90€

REF.	mm	kg	box	unit	€
10538	17	0.14	10	100	4,30€
10539	18	0.16	10	100	4,75€
10540	19	0.20	10	100	5,25€
10548	6	0.03	10	100	1,75€
10549	7	0.03	10	100	2,00€
10550	8	0.03	10	100	2,15€
10551	9	0.04	10	100	2,15€



54120

59,00€



SET DI 7 CHIAVI COMBinate

7 PCS CrV 20, 21, 22, 24, 27, 30, 32mm



RICAMBI DISPONIBILI

REF.	mm	kg	box	unit	€
10541	20	0.21	6	60	5,55€
10542	21	0.25	-	50	5,85€
10543	22	0.25	-	50	7,00€
10544	24	0.33	10	100	8,10€

REF.	mm	kg	box	unit	€
10545	27	0.41	10	50	9,75€
10546	30	0.52	-	25	11,60€
10547	32	0.59	-	25	13,50€

54174

139,00€



SET DI 6 CHIAVI COMBinate

6 PCS CrV XL 34, 36, 38, 41, 46, 50mm



RICAMBI DISPONIBILI

REF.	mm	kg	box	unit	€
16020	34	0.36	10	100	17,00€
16021	36	0.00	10	100	19,50€
16022	38	0.43	10	100	23,00€

REF.	mm	kg	box	unit	€
16023	41	0.47	10	100	26,50€
16024	46	0.51	10	100	34,50€
16025	50	0.58	10	100	37,50€

50564

30,00€

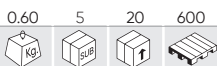

SET DI 8 CHIAVI COMBinate CORTE



RICAMBI DISPONIBILI

REF.	mm	Kg	SUB	mm	€	REF.	mm	Kg	SUB	mm	€	REF.	mm	Kg	SUB	mm	€
10564	10	0.05	10	100	2,50€	10567	13	0.05	10	100	3,50€	10570	17	0.10	10	100	4,50€
10565	11	0.05	10	100	3,50€	10568	14	0.05	10	100	4,00€	10571	19	0.15	10	100	5,00€
10566	12	0.05	10	100	3,50€	10569	15	0.05	10	100	4,50€						



54150

23,50€

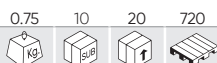

SET DI 7 CHIAVI FISSE

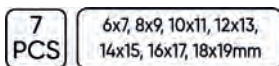

RICAMBI DISPONIBILI

REF.	mm	Kg	SUB	mm	€	REF.	mm	Kg	SUB	mm	€
10579	10x11	0.06	10	100	3,00€	10583	18x19	0.19	10	100	4,15€
10580	12x13	0.07	10	100	3,10€	10589	6x7	0.03	10	100	2,00€
10581	14x15	0.10	10	100	3,40€	10590	8x9	0.04	10	100	2,40€
10582	16x17	0.14	10	100	4,00€						



54149

60,00€



SET DI 12 CHIAVI FISSE

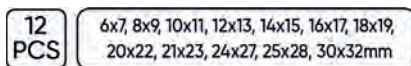

RICAMBI DISPONIBILI

REF.	mm	Kg	SUB	mm	€	REF.	mm	Kg	SUB	mm	€
10579	10x11	0.06	10	100	3,00€	10585	21x23	0.31	-	50	6,75€
10580	12x13	0.07	10	100	3,10€	10586	24x27	0.35	10	100	7,60€
10581	14x15	0.10	10	100	3,40€	10587	25x28	0.36	-	50	9,80€
10582	16x17	0.14	10	100	4,00€	10588	30x32	0.54	-	25	10,50€
10583	18x19	0.19	10	100	4,15€	10589	6x7	0.03	10	100	2,00€
10584	20x22	0.25	6	60	5,05€	10590	8x9	0.04	10	100	2,40€



52973

59,00€



SET DI 12 CHIAVI FISSE CROMATE

RICAMBI DISPONIBILI

REF.	mm	Kg	SUB	mm	€	REF.	mm	Kg	SUB	mm	€
10579	10x11	0.06	10	100	3,00€	10585	21x23	0.31	-	50	6,75€
10580	12x13	0.07	10	100	3,10€	10586	24x27	0.35	10	100	7,60€
10581	14x15	0.10	10	100	3,40€	10587	25x28	0.36	-	50	9,80€
10582	16x17	0.14	10	100	4,00€	10588	30x32	0.54	-	25	10,50€
10583	18x19	0.19	10	100	4,15€	10589	6x7	0.03	10	100	2,00€
10584	20x22	0.25	6	60	5,05€	10590	8x9	0.04	10	100	2,40€



6x7, 8x9, 10x11, 12x13, 14x15, 16x17, 18x19, 20x22, 21x23, 24x27, 25x28, 30x32mm



54115

26,80€

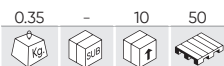

SET DI 4 CHIAVI AD ANELLO TORX PIATTE

4 PCS E6xE8, E10xE12, E14xE18, E20xE24



RICAMBI DISPONIBILI

REF.	mm				€
16546	E6xE8	0.05	10	100	5,00€
16547	E10xE12	0.07	10	100	5,50€
16548	E14xE18	0.08	10	100	9,00€
16549	E20xE24	0.09	10	100	14,00€

54081

28,00€

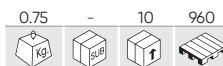

SET DI CHIAVI ESAGONALI APERTE PER RACCORDI

5 PCS 10x11HEX, 12x13HEX, 14x15HEX, 16x17HEX, 18x19HEX



RICAMBI DISPONIBILI

REF.	mm				€
11258	10x11	0.10	5	100	7,30€
11259	12x13	0.10	5	100	8,30€
11260	14x15	0.11	5	100	9,75€
11261	16x17	0.18	5	100	11,35€
11262	18x19	0.21	-	100	13,50€

54159

47,00€



SET DI 8 CHIAVI TIPO "C" POLIGONALI

8 PCS

6x7, 8x9, 10x11, 12x13, 14x15, 16x17, 18x19, 20X22mm



RICAMBI DISPONIBILI

REF.	mm				€
11639	6x7	0.61	5	50	4,00€
11640	8x9	0.04	5	50	4,50€
11641	10x11	0.04	5	50	5,00€
11642	12x13	0.06	5	50	5,00€
11643	14x15	0.09	5	-	6,00€
11644	16x17	0.12	5	50	7,00€
11645	18x19	0.15	5	50	7,00€
11646	20x22	0.22	5	-	9,45€

52451

42,00€



SET DI 8 CHIAVI TIPO "C" POLIGONALI

8 PCS

6x7, 8x9, 10x11, 12x13, 14x15, 16x17, 18x19, 20X22mm



RICAMBI DISPONIBILI

REF.	mm				€
11639	6x7	0.61	5	50	4,00€
11640	8x9	0.04	5	50	4,50€
11641	10x11	0.04	5	50	5,00€
11642	12x13	0.06	5	50	5,00€
11643	14x15	0.09	5	-	6,00€
11644	16x17	0.12	5	50	7,00€
11645	18x19	0.15	5	50	7,00€
11646	20x22	0.22	5	-	9,45€

15156

70,00€



MODULO EVA IN FIBRA DI CARBONIO CON 4 CHIAVI A "L"

RICAMBI DISPONIBILI

REF.	mm				€
15206	21x23	0.45	5	50	15,00€
15207	24x27	0.50	5	50	16,50€
15208	25x28	0.45	5	50	17,00€
15209	30x32	0.67	10	50	18,00€

4 PCS 21x23, 24x27, 25x28, 30x32mm



54119

78,00€

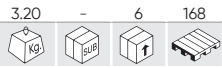

SET DI 12 CHIAVI POLIGONALI A STELLA

12 PCS



6x7, 8x9, 10x11, 12x13, 14x15, 16x17, 18x19, 20x22, 21x23, 24x27, 25x28, 30x32mm



RICAMBI DISPONIBILI

REF.	mm				€	REF.	mm				€
10627	6x7	0.04	10	100	2,80€	10633	18x19	0.22	10	100	6,60€
10628	8x9	0.06	10	100	3,10€	10634	20x22	0.43	-	50	7,80€
10629	10x11	0.08	10	100	3,65€	10635	21x23	0.30	-	50	8,15€
10630	12x13	0.11	10	100	3,90€	10636	24x27	0.35	-	25	8,80€
10631	14x15	0.14	10	100	4,20€	10637	25x28	0.48	6	24	12,10€
10632	16x17	0.18	10	100	5,30€	10638	30x32	0.73	6	24	12,70€

50562

23,50€

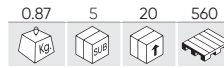

SET DI 7 CHIAVI POLIGONALI DOPPIE CURVE

7 PCS



6x7, 8x9, 10x11, 12x13, 14x15, 16x17, 18x19mm



RICAMBI DISPONIBILI

REF.	mm				€	REF.	mm				€
10627	6x7	0.04	10	100	2,80€	10631	14x15	0.14	10	100	4,20€
10628	8x9	0.06	10	100	3,10€	10632	16x17	0.18	10	100	5,30€
10629	10x11	0.08	10	100	3,65€	10633	18x19	0.22	10	100	6,60€
10630	12x13	0.11	10	100	3,90€						

51528

49,00€

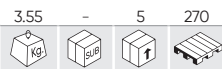

KIT DI 14 CHIAVI A PIPA

14 PCS



8, 9, 10, 11, 12, 13, 14, 15, 16, 17, 18, 19, 20, 21mm



RICAMBI DISPONIBILI

REF.	mm				€	REF.	mm				€
10591	10	0.09	10	200	2,50€	10598	17	0.32	10	60	4,60€
10592	11	0.12	10	200	2,55€	10599	18	0.43	10	40	6,00€
10593	12	0.16	10	120	3,15€	10600	19	0.41	10	40	6,25€
10594	13	0.17	10	100	3,20€	10601	20	0.45	10	30	6,50€
10595	14	0.20	10	100	3,35€	10602	21	0.47	10	30	7,05€
10596	15	0.25	10	70	4,25€	10603	8	0.07	10	300	2,10€
10597	16	0.30	10	70	4,50€	10604	9	0.08	10	200	2,25€

53420

72,00€

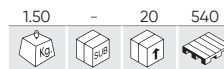

SET DI 8 CHIAVI A PIPA

8 PCS



6x7, 8x9, 10x11, 12x13, 14x15, 16x17, 18x19, 20x22mm



53979

34,60€

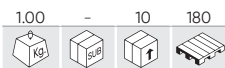

SET DI 8 CHIAVI TORX A "T"



T10x75, T15x75, T20x100, T25x100, T30x150, T40x150, T45x200, T50x200mm

53980

34,60€

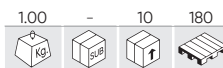

SET DI 8 CHIAVI A BRUGOLA A "T"

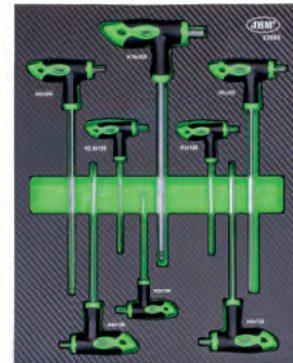

H2x100, H2.5x100, H3x100, H4x150, H5x150, H6x200, H8x200, H10x200

KIT DI 6 CHIAVI SUPERLUNGHE

51864

64,00€

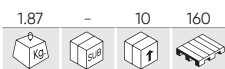

10x11mm (290mmL), 12x14mm (330mmL), 13x15mm (368mmL), 16x18mm (407mmL), 17x19mm (407mmL), 22x24mm (430mmL)



52912

91,00€



E6xE7 (200mmL), E8xE10 (235mmL), E11xE12 (290mmL), E14xE16 (370mmL), E18xE20 (410mmL), E22xE24 (420mmL)



RICAMBI DISPONIBILI

REF.	mm					€
11244	10x11	0.13	5	100		8,50€
11245	12x14	0.18	10	50		9,15€
11246	13x15	0.25	6	36		12,40€
REF.	mm					€
11247	16x18	0.30	6	36		14,00€
11248	17x19	0.31	10	36		14,60€
11249	22x24	0.43	5	-		26,50€

SET DI 9 CHIAVI

TORX

REF.	mm	DESCRIZIONE					€
53737	90-218mm	SET DI 9 UGELLI TORX (EXTRA LUNGHI)	0.42	10	40	1000	12,50€
53739	86-150mm	SET DI 9 UGELLI TORX (LUNGHI)	0.32	10	40	960	10,50€
53955	72-170mm	SET DI 9 UGELLI TORX (CORTI)	0.25	10	40	1480	10,00€



T10, T15, T20, T25, T27, T30, T40, T45, T50

ESAGONALI

REF.	mm	DESCRIZIONE					€
53738	90-220mm	SET DI 9 UGELLI ESAGONALI (EXTRA LUNGHI)	0.45	10	40	1000	10,90€
53740	72-170mm	SET DI 9 UGELLI ESAGONALI (LUNGHI)	0.37	10	40	960	9,10€
53954	43-97mm	SET DI 9 UGELLI ESAGONALI (CORTI)	0.25	10	40	1480	8,50€



1,5, 2, 2,5, 3, 4, 5, 6, 8, 10mm



UTENSILI MANUALI

51659

59,00€

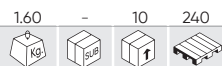

VALIGETTA CON 6 CHIAVI A BUSSOLA POLIGONALI ARTICOLATE

6 PCS



8x9, 10x11, 12x13, 14x15, 16x17, 18x19mm



RICAMBI DISPONIBILI

REF.	mm				€
10621	8-9	0.09	10	100	9,50€
10622	10-11	0.13	10	100	10,00€
10623	12-13	0.16	5	100	12,60€

REF.	mm				€
10624	14-15	0.30	10	100	13,50€
10625	16-17	0.29	-	100	15,70€
10626	18-19	0.37	10	100	17,80€

50622

64,00€

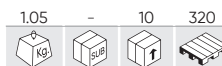

SET DI 4 CHIAVI A BUSSOLA SNODATE IMPRONTA TORX

4 PCS



E6 x E8, E10 x E12, E14 x E18, E20 x E24



RICAMBI DISPONIBILI

REF.	mm				€
10617	E6xE8	0.07	10	100	14,10€
10618	E10xE12	0.11	10	100	15,10€
10619	E14xE18	0.20	10	100	15,70€
10620	E20xE24	0.34	10	100	16,20€

54187

39,30€

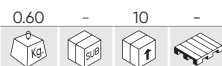

SET DI 10 CHIAVI CON INSERTI CROWFOOT 3/8"

RICAMBI DISPONIBILI

REF.	mm				€
16010	10	0.04	10	100	4,00€
16011	11	0.04	10	100	4,00€
16012	13	0.04	10	100	4,00€
16013	14	0.05	10	100	4,50€
16014	15	0.05	10	100	4,50€

REF.	mm				€
16015	16	0.05	10	100	5,00€
16016	17	0.05	10	100	5,00€
16017	18	0.06	10	100	5,00€
16018	19	0.06	10	100	5,50€
16019	22	0.08	10	100	6,00€



10 PCS



10, 11, 13, 14, 15, 16, 17, 18, 19, 22mm

CrV

3/8"



UTENSILI IN POLLICI

51890

92,00€



SET DI 17 CHIAVI COMBinate IN POLLICI

17 PCS

5/16, 3/8, 7/16, 1/2, 9/16, 19/32, 5/8, 11/16, 3/4, 13/16, 7/8, 15/16, 1", 1" 1/16, 1" 1/8, 1" 3/16, 1" 1/4



54005

14,00€

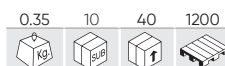

SET DI 9 CHIAVI A BRUGOLA IN POLLICI

9 PCS

CrV



1/16", 5/64", 3/32", 1/8", 5/32", 3/16", 1/4", 5/16", 3/8"

72-170mm



54106

89,00€



VALIGETTA DI UTENSILI IN POLLICI SATINATI DA 37 PEZZI

37 PCS

CrV

1/2"

1/4"



CHIAVE A CROCE FISSATA MECCANICAMENTE

<p>51661 12,00€</p> <p>1.17 5 20 360</p> <p>1/2" 355mm</p> <p>17, 19, 21mm</p>	<p>52880 42,00€</p> <p>3.75 - 5 120</p> <p>3/4" 700mm</p> <p>24, 27, 32mm</p>	<p>52881 17,00€</p> <p>1.40 - 10 480</p> <p>1/2" 400mm</p> <p>17, 19, 21, 22mm</p>
---	--	---

51416 12,00€

1.05 10 20 360

CHIAVE TELESCOPICA PER RUOTA CON BUSSOLE REVERSIBILI 330-490MM

1/2"

17/19mm
21/23mm

CHIAVE INGLESE

MODELLO 1

REF.	DESCRIZIONE		mm					€
51798	CHIAVE INGLESE DA 18"		53mm 450mm	1.90	3	12	480	39,60€
52424	CHIAVE INGLESE 24"		62mm 610mm	3.75	-	5	350	64,00€



MODELLO 2

REF.	DESCRIZIONE		mm					€
51795	CHIAVE INGLESE 8"		22mm 200mm	0.28	6	60	3600	9,00€
51796	CHIAVE INGLESE 10"		28mm 250mm	0.48	6	36	2400	14,00€
51797	CHIAVE INGLESE 12"		37mm 300mm	0.71	6	24	960	18,00€



MODELLO 3

REF.	DESCRIZIONE		mm					€
53639	CHIAVE INGLESE 6"		28mm 150mm	0.15	6	96	576	28,60€
53640	CHIAVE INGLESE 8"		30mm 200mm	0.28	6	72	504	34,40€
53641	CHIAVE INGLESE 10"		33mm 250mm	0.50	6	36	1151	41,00€
53642	CHIAVE INGLESE 12"		40mm 300mm	0.83	6	10	1200	54,00€
53643	CHIAVE INGLESE 16"		52mm 400mm	1.53	-	12	336	92,00€
54098	CHIAVE INGLESE 20"		65mm 640mm	2.70	-	6	-	158,50€



53654 81,00€

1.40 - 5 200

SET DI CHIAVI A GANCIO PER DADI

8 PCS 35-60, 60-90, 90-120mm

160mm 177mm 250mm

CHIAVI STILLSON

REF.	DESCRIZIONE		"					€
52235	CHIAVI STILLSON 300MM	50mm	12"	0.90	6	24	1140	11,00€
52236	CHIAVI STILLSON 350MM	60mm	14"	1.09	6	24	760	13,30€
52237	CHIAVI STILLSON 450MM	70mm	18"	1.75	4	12	720	18,10€
52238	CHIAVI STILLSON 600MM	75mm	24"	2.50	2	8	600	24,90€
53210	CHIAVI STILLSON 915MM	110mm	36"	4.95	-	4	96	48,00€

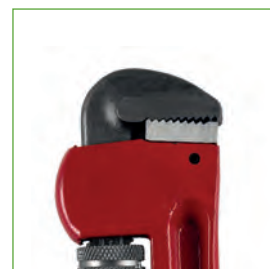

CHIAVI IN LEGA DI ALLUMINIO

REF.	DESCRIZIONE		mm					€
53070	CHIAVE IN LEGA DI ALLUMINIO 12"	45mm	270mm	0.68	6	24	900	16,20€
53071	CHIAVE IN LEGA DI ALLUMINIO 14"	50mm	320mm	0.92	4	12	900	26,10€
53072	CHIAVE IN LEGA DI ALLUMINIO 18"	65mm	410mm	1.35	4	12	900	31,60€
53073	CHIAVE IN LEGA DI ALLUMINIO 24"	75mm	540mm	2.05	2	8	1000	50,00€



MORSETTI TIPO "FALEGNAME"

REF.	DESCRIZIONE					€
52349	MORSETTO TIPO "FALEGNAME" 90X200MM	1.25	-	10	480	22,10€
52350	MORSETTO TIPO "FALEGNAME" 90X300MM	1.41	-	10	540	22,60€
52351	MORSETTO TIPO "FALEGNAME" 90X400MM	1.60	-	10	480	25,40€
52352	MORSETTO TIPO "FALEGNAME" 120X300MM	1.99	-	10	360	32,40€
52353	MORSETTO TIPO "FALEGNAME" 120X400MM	2.10	-	10	350	33,40€
52354	MORSETTO TIPO "FALEGNAME" 120X500MM	2.41	-	6	300	34,40€
52355	MORSETTO TIPO "FALEGNAME" 120X600MM	2.62	-	4	300	36,60€
52357	MORSETTO TIPO "FALEGNAME" 150X800MM	4.60	-	5	125	54,00€
52358	MORSETTO TIPO "FALEGNAME" 150X1000MM	5.35	-	5	120	63,00€



CRICCHETTI 72 DENTI CON SET DI INSERTI

REF.	DESCRIZIONE					€
54028	CRICCHETTO 72 DENTI CON BUSSOLE ESAGONALE 1/2"	1.30	4	24	432	28,00€
54029	CRICCHETTO 72 DENTI CON BUSSOLE POLIGONALI 1/2"	1.25	4	24	432	28,00€
54030	CRICCHETTO 72 DENTI CON BUSSOLE ESAGONALE 1/4"	0.35	6	36	1008	18,80€
54031	CRICCHETTO 72 DENTI CON BUSSOLE POLIGONALI 1/4"	0.35	6	36	864	19,30€



	54028 - 54029	10, 11, 12, 13, 14, 15, 16, 17, 18, 19mm
	54030 - 54031	4, 5, 6, 7, 8, 9, 10, 11, 12, 13mm

CRICCHETTI A 72 DENTI

FINITURA CROMATA

REF.	DESCRIZIONE					€
54022	CRICCHETTO A 72 DENTI DA 1/4" 145MM FINITURA CROMATA	0.15	12	36	1440	9,95€
54023	CRICCHETTO A 72 DENTI DA 3/8" 200MM FINITURA CROMATA	0.30	12	24	1440	13,50€
54024	CRICCHETTO A 72 DENTI DA 1/2" 255MM FINITURA CROMATA	0.60	12	24	960	17,90€



IN ESPOSITORE DA 12 UNITÀ



FINITURA SATINATA

REF.	DESCRIZIONE					€
54018	CRICCHETTO A 72 DENTI DA 1/4" 145MM FINITURA ZINCATA	0.15	12	36	1440	9,85€
54019	CRICCHETTO A 72 DENTI DA 1/2" 255MM FINITURA ZINCATA	0.60	12	24	864	17,90€
54021	CRICCHETTO A 72 DENTI DA 3/8" 200MM FINITURA ZINCATA	0.60	12	24	1440	13,50€



IN ESPOSITORE DA 12 UNITÀ



CRICCHETTI A 72 DENTI

REF.	DESCRIZIONE					€
54083	CRICCHETTO DRITTO CON 72 DENTI - 1/4"	0.14	12	24	2592	9,75€
54084	CRICCHETTO DRITTO CON 72 DENTI - 3/8"	0.30	12	24	1440	13,10€
54085	CRICCHETTO DRITTO CON 72 DENTI - 1/2"	0.60	12	24	960	17,80€



IN ESPOSITORE DA 12 UNITÀ



CRICCHETTI DRITTI COMPATTI CON 72 DENTI

REF.	DESCRIZIONE					€
54086	CRICCHETTO DRITTO COMPATTO CON 72 DENTI 1/4"	0.10	12	24	2592	9,25€
54087	CRICCHETTO DRITTO COMPATTO CON 72 DENTI - 1/2"	0.50	12	24	1008	17,30€



IN ESPOSITORE DA 12 UNITÀ



UTENSILI MANUALI

52197

36,30€

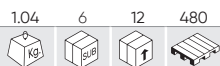

CRICCHETTO ARTICOLATO ESTENSIBILE DA 1/2" A 72 DENTI

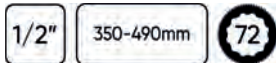

IN ESPOSITORE
DA 6 UNITÀ

52207

24,20€



CRICCHETTO MINI DA 1/4" A 72 DENTI 85MM SATINATO



IN ESPOSITORE
DA 12 UNITÀ

CRICCHETTO 72 DENTI ARTICOLATO CORTO

REF.						€
52587	1/4" 172mm	0.16	12	144	3456	39,90€
52588	1/2" 172mm	0.17	12	144	3456	45,00€



IN ESPOSITORE DA 12 UNITÀ



CRICCHETTO 72 DENTI ARTICOLATO CORTO

REF.						€
51305	1/2" 175mm	0.31	12	48	816	28,90€
51306	1/4" 165mm	0.30	12	48	816	28,10€



IN ESPOSITORE DA 12 UNITÀ



CRICCHETTO 72 DENTI CON TESTA ROTANTE

REF.						€
51405	1/4" 145mm	0.58	12	24	-	21,10€
51406	1/2" 280mm	0.66	12	24	864	29,20€



IN ESPOSITORE DA 12 UNITÀ



CRICCHETTO ARTICOLATO 72 DENTI

REF.						€
51307	1/2" 305-445mm	0.92	6	12	360	29,70€
53346	1/4" 150-200mm	0.25	6	12	-	18,00€
54304	1/2" 450-610mm	1.15	-	6	480	26,00€



IN ESPOSITORE DA 6 UNITÀ



CRICCHETTO ALLUNGATO A 72 DENTI

REF.	DESCRIZIONE					€
53886	1/4" 305mm	0.27	10	40	1680	20,30€
53887	3/8" 457mm	0.68	10	20	700	30,30€
53888	1/2" 609mm	1.27	4	16	480	37,90€



RICAMBI

REF.	"					€
15147	3/8"	0.10	-	100	-	5,00€

REF.	"					€
15148	1/2"	0.20	-	100	-	5,00€

REF.	"					€
15149	1/4"	0.05	-	100	-	5,00€



51801

62,00€

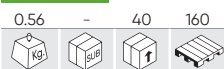

CRICCHETTO FLESSIBILE 72 DENTI DA 3/8" 500MM



PER LUOGHI DI DIFFICILE ACCESSO

COMANDO A MANOPOLA

TESTA ROTANTE



53671

41,00€



SET DI 3 CHIAVI A CRICCHETTO CORTE

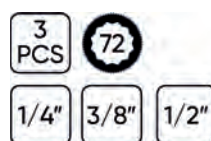

KIT DI RIPARAZIONE PER CHIAVE A CRICCHETTO

REF.	DESCRIZIONE					€
15138	1/4"	0.10	-	50	-	10,50€
15139	3/8"	0.15	-	50	-	12,00€
15140	1/2"	0.20	-	50	-	13,50€

54339

273,00€



CHIAVE DINAMOMETRICA DIGITALE 1/2" 10-200NM



N

52913

292,00€



CHIAVE DINAMOMETRICA CON TESTA INTERCAMBIABILE 200 NM

1/2"

	x1	1/2"
	x9	13, 14, 15, 17, 19, 22, 24, 27, 30mm
	x1	40-200Nm

- Includono il certificato di calibrazione di fabbrica.



54269

56,00€



SET DA 21 PEZZI CON CHIAVE DINAMOMETRICA 1/4"

1/4" N

	x1	5-25Nm		x3	PH1, PH2, PH3
	x1	100mm		x8	H2, H2.5, H3, H4, H5, H6, H8, H10 (37mmL)
	x1	UNIVERSAL		x1	H5 (87mmL)
	x1	1/4" (F) - 3/8" (M)		x5	T10, T15, T20, T25, T30



53972

550,00€



CHIAVE DINAMOMETRICA DA 3/4"



200-800Nm
21.4-86.6M.Kg

1000-1210mm



- Includono il certificato di calibrazione di fabbrica.

CHIAVI DINAMOMETRICHE CON INCAVO

REF.	DESCRIZIONE	Icona 1	Icona 2	Icona 3	Icona 4	€
53081	1/4" 4-20NM (36T) 375mm	1.10	5	25	350	115,00€
53082	1/2" 40-210NM (24T) 560mm	1.90	4	8	168	148,00€

- Includono il certificato di calibrazione di fabbrica.



CHIAVI DINAMOMETRICHE

REF.	DESCRIZIONE	Icona 1	Icona 2	Icona 3	Icona 4	€
51127	1/2" 28-210NM 470mm	1.70	4	8	256	56,00€
51262	1/4" 5-25NM 270mm	0.80	4	16	384	51,00€
51338	3/8" 19-110NM 365mm	1.05	4	16	384	53,00€



KIT DI RIPARAZIONE

REF.	"	Icona 1	Icona 2	Icona 3	Icona 4	€	REF.	"	Icona 1	Icona 2	Icona 3	Icona 4	€
51127R	1/2"	0.15	-	20	-	14,00€	51262R	1/4"	0.05	-	20	-	14,00€
							51338R	3/8"	0.05	-	20	-	14,00€



51830

94,00€

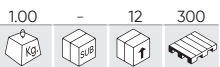

GIRAVITE DINAMOMETRICO MECCANICO

- Esattezza: CW: +/- 4%
- Raggio d'operazione: 2-10 N-m
- Unità di selezione: N-m, in-lb.
- Lunghezza (mm): 242
- Dado: 1/4"
- Vida utile: 2000 cicli

- Includono il certificato di calibrazione di fabbrica.



ADATTATORI A "T" CON MANIGLIA SCORREVOLE

REF.	DESCRIZIONE	Icona 1	Icona 2	Icona 3	Icona 4	€
53468	1/2" 250mm	0.35	6	48	600	8,50€
53478	1/4" 115mm	0.50	5	100	1200	4,55€
53479	3/8" 200mm	0.15	5	50	300	6,40€
53480	3/4" 460mm	1.35	5	10	440	19,90€
53481	1" 550mm	2.85	-	5	300	27,40€



CHIAVI LUNGHE SNODATE

REF.	DESCRIZIONE					€
52524	3/4" 1020mm	3.60	3	6	144	51,00€
52526	1/2" 600mm	1.65	5	10	600	28,40€
52525	1/2" 430mm	0.85	10	20	1500	13,80€



RICAMBI

REF.	"					€
11945	1/2"	0.15	25	100	-	7,00€

PER 52526

REF.	"					€
11946	1/2"	0.06	25	300	-	4,50€

PER 52525

REF.	"					€
11947	3/4"	0.51	10	40	960	19,00€

PER 52524



54343 31,00€

1.15	-	6	594
------	---	---	-----



BARRA INTERRUPTORE ESTENSIBILE DA 1/2" 450-600MM



51479 31,80€

0.65	12	24	1056
------	----	----	------

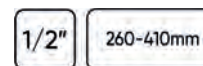

PROLUNGA TELESCOPICA DA 1/2" CON TESTA A SFERA



IN ESPOSITORE DA 12 UNITÀ

51805 17,00€

0.33	4	20	640
------	---	----	-----

SET DI PROLUNGHE DA 1/4" CON TESTA A SFERA

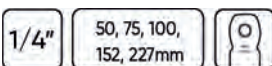

51447 16,00€

0.34	5	20	960
------	---	----	-----

MODULO DI PROLUNGHE DA 1/4" CON TESTA NORMALE

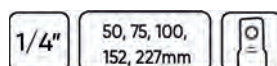

51448 52,00€

2.38	-	5	300
------	---	---	-----

MODULO DI PROLUNGHE DA 1/2" CON TESTA A SFERA

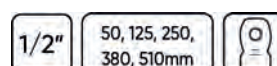

RICAMBI DISPONIBILI

REF.	mm				€
12995	50	0.03	5	100	7,00€
12996	75	0.04	20	100	7,00€
12997	100	0.06	20	100	7,50€
12998	152	0.08	5	100	9,00€
12999	227	0.11	5	100	9,50€

RICAMBI DISPONIBILI

REF.	mm				€
14026	50	0.03	10	100	5,50€
14027	75	0.04	-	50	5,60€
10264	100	0.05	10	100	2,00€
14029	152	0.07	-	50	8,50€
14030	227	0.11	-	50	9,50€

RICAMBI DISPONIBILI

REF.	mm				€
14978	50	0.10	5	100	7,50€
14979	125	0.20	5	50	9,00€
14980	250	0.40	5	25	13,00€
14981	380	0.60	5	20	22,50€
14982	510	0.60	5	10	27,50€

54302 11,50€

0.45	10	40	650
------	----	----	-----

SET DI 6 CACCIAVITI DI PRECISIONE

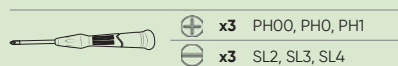

⊕ x3 PH00, PH0, PH1
⊖ x3 SL2, SL3, SL4



UTENSILI MANUALI

52500

19,00€

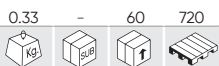

SET DI 8 CACCIAVITI CORTI

8
PCS



CONTIENE

- + x3 PH00x25, PH0x25, PH1x25
- x5 SL0.4x2x25, SL0.4x2.5x25, SL0.5x3x.25, SL0.5x3.5x25, SL0.8x4x25

53917

9,00€

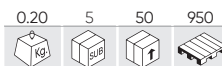

SET DI 7 CACCIAVITI LUNGI

7
PCS



CONTIENE

- + x3 PH00, PH0, PH1
- x4 SL.1.4, SL2.0, SL.2.4, SL3.0

53694

18,40€

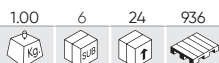

CACCIAVITE AD INSERTI DA 1/2"

8
PCS CrV 1/2"



CONTIENE

- + x1 1/2"
- + x3 PH 2x36mm, 3x36mm, 3x70mm
- x1 1/2" - 8mm
- x3 SL 7x36mm, 8x36mm, 8x70mm

54126

39,00€



KIT DI 12 CACCIAVITI A TAGLIO USO SCALPELLO

12
PCS GO-THROUGH



CONTIENE

- + x6 PH0x75mm, PH1x75mm, PH2x38mm, PH2x100mm, PH3x125mm, PH4x200mm
- x6 SL3.2x75mm, SL5x75mm, SL6x38mm, SL6x100mm, SL8x150mm, SL9.5x200mm

53010

18,00€

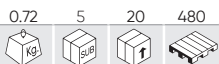

SET DI CACCIAVITI CON IMPUGNATURA INTERCAMBIABILE

11
PCS



CONTIENE

- + x2 PH1, PH2
- x2 4x6, 5x7mm
- + x3 T10x15, T20x25, T30x40
- + x3 H4x4mm, H5x5mm, H6x6mm
- + x1

50902

13,00€



KIT DI 4 CACCIAVITI A TAGLIO USO SCALPELLO

4
PCS 3", 4", 6", 8"



CACCIAVITI CON MODULI EVA - FIBRA DI CARBONIO

53943

21,50€



- + PH4x200, PH3x150, PH2x100, PH2x38, PH1x80, PH0x120, PH1x100

53944

19,50€

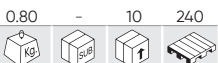

- SL9x200, SL4x125, SL5x100, SL5x80, SL6x38, SL6x100, SL8x150mm

53945

18,90€

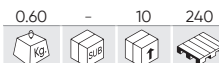

- + T8x75, T9x75, T10x75, T15x75, T20x75, T25x100, T27x100

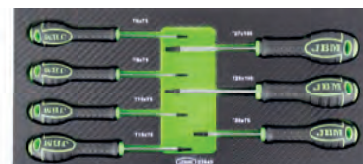
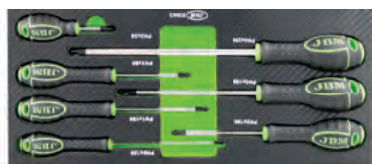

54060 6,00€

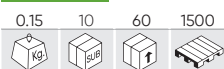

CACCIAVITE REVERSIBILE A TAGLIO E A CROCE 6X150MM



54061 6,00€



CACCIAVITE REVERSIBILE A TAGLIO E A CROCE 6X100MM



54071 26,50€



SET DI 6 CACCIAVITI GO-THROUGH (3 A CROCE + 3 A TAGLIO)



CONTIENE

- ⊕ x3 PH3x150, PH2x100, PH1x75mm
- ⊖ x3 SL8x150, SL6.5x100, SL5.5x75mm

54070 18,00€

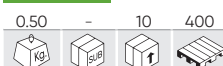

SET DI 6 CACCIAVITI (2 A CROCE + 4 A TAGLIO)



CONTIENE

- ⊕ x2 PH1x80, PH2x100mm
- ⊖ x4 SL6.5x150, SL5.5x125, SL4x100, SL3x80mm

52170 16,00€



CACCIAVITE FLESSIBILE

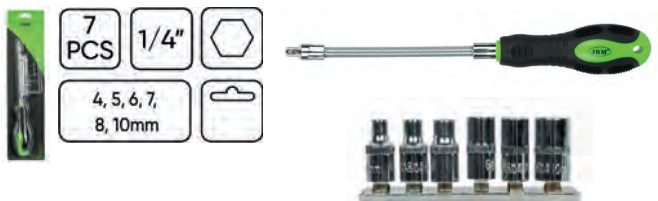

52169 25,00€



KIT DI 3 CACCIAVITI FLESSIBILI



53575 16,00€

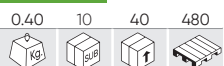

CACCIAVITE FLESSIBILE



- x3 1/4" 4 mm
- 5 mm
- 7 mm

UTENSILI MANUALI

53225

3,50€

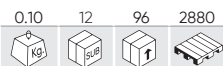

MAGNETIZE/ DEMAGNETIZE



51812

46,00€



SET DI 5 PINZE CON ASTUCCIO



CONTIENE

A	x1	160mm
B	x1	160mm
C	x1	180mm
D	x1	200mm
E	x1	250mm

PINZE SEEGER - BECCHI DRITTI



INTERNI

REF.	DESCRIZIONE					€
51018	7" 180mm	0.14	5	100	1800	7,05€
52964	9" 225mm	0.23	6	60	1440	9,45€
53549	13" 330mm	0.45	5	30	-	14,30€



ESTERNI

REF.	DESCRIZIONE					€
51017	7" 180mm	0.17	5	100	1800	6,80€
52966	9" 225mm	0.28	6	60	1800	9,45€
53547	13" 330mm	0.50	5	30	-	14,70€



PINZE SEEGER BECCHI CURVI



INTERNI

REF.	DESCRIZIONE					€
51021	7" 180mm	0.16	5	100	-	7,05€
52965	9" 225mm	0.24	6	60	1440	9,20€
53550	13" 330mm	0.45	5	30	-	14,70€



ESTERNI

REF.	DESCRIZIONE					€
51020	7" 180mm	0.13	5	100	1600	6,65€
52967	9" 225mm	0.24	6	60	1440	9,40€
53548	13" 330mm	0.50	5	30	-	15,60€



PINZE TAGLIO DIAGONALE

REF.	DESCRIZIONE					€
53905	6" 160mm	0.20	6	60	1440	7,30€
53906	7" 180mm	0.20	6	60	1560	8,65€



PINZE A BECCHI LUNGI

REF.	DESCRIZIONE					€
53908	6" 160mm	0.15	6	60	1440	7,25€
53909	8" 200mm	0.20	6	60	1440	9,70€



PINZE UNIVERSALI

REF.	DESCRIZIONE						€
53911	6" 160mm	0.20	6	60	1440		8,80€
53967	8" 200mm	0.30	6	60	1440		10,20€
54015	7" 180mm	0.20	6	60	1920		10,20€



15454

35,40€

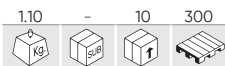

8"

MODULO DI PINZE SEGER 8" EVA

REF.	DESCRIZIONE						€
10526	PINZA SEEGER BECCHI DIRITTI - INTERNI 8"	0.21	5	50	-		10,00€
10642	PINZA SEEGER BECCHI DIRITTI - ESTERNI 8"	0.22	5	50	-		10,00€
10643	PINZA SEEGER BECCHI CURVI - INTERNI 8"	0.21	5	50	-		10,00€
10644	PINZA SEEGER BECCHI CURVI - ESTERNI 8"	0.22	5	50	-		10,00€



53389

31,50€



SET DI PINZE SEGER CON PUNTA INTERCAMBIABILE



PINZE A PAPPAGALLO

REF.								€
52052	515mm	140mm	1.88	5	10	400		53,00€
50567	250mm	40mm	0.34	10	60	1500		9,60€



52846

37,80€

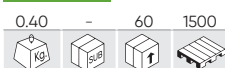

PINZA EXTRA-LUNGA DRITTA



52847

41,00€



PINZA EXTRA-LUNGA CURVA 45°



52272

24,60€



SET PINZE PUNTA DA 0°, 45°, 90°



UTENSILI MANUALI

53390

34,50€

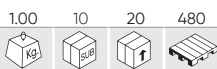

PINZA PER FASCETTE



REF.	DESCRIZIONE	Kg	SUB	Box	Units	€
14180	SET DI RICAMBI PER 53390	0,01	-	100	-	7,90€

51995

24,50€



PINZA PER FASCETTE



REF.	DESCRIZIONE	Kg	SUB	Box	Units	€
14179	SET DI RICAMBI PER 51995	0,01	-	100	-	8,50€

53396

18,30€



PINZA PER FASCETTE PER CONDOTTI DI SCARICO

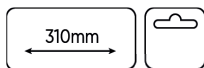

52791

18,00€

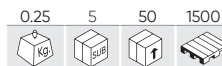

PINZA PER FASCETTE CLIC-R

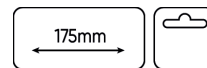

54376

12,00€

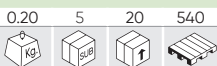

STRUMENTO DI FASCIATURA PER GIUNTO CV CON TAGLIERINA

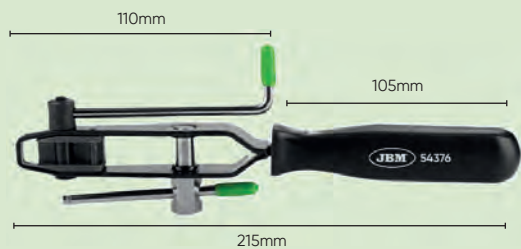

54311

13,00€



PINZA PER FASCETTE



54330

12,50€

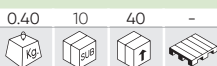

PINZA PER SIGILLI STELO VALVOLE

280 mm

OPEL, VW, FORD



54279

6,00€

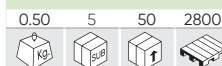

PINZA PER ESTRAZIONE DI LAMPADINE

100°



54479 36,50€



N

PINZE PER FASCE METALLICHE AUTOBLOCCANTI

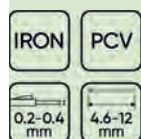

52412 5,00€



PINZA MINI RIPIEGABILE MULTIUSO 105MM

CONTIENE

- x2 Cacciaviti
- x1 Punta stella
- x1 Apribottiglie
- x1 Apriscatole
- x1 Lima 25mm
- x1 Lama di sega 40mm
- x1 Lama da taglio 40mm



52050 98,00€



SET DI PINZE PER FASCETTE

RICAMBI DISPONIBILI

REF.	DESCRIZIONE	Kg	10	40	576	1536	€
A	13707 PINZE PER FASCETTE CON PUNTA ROTATIVA	0.25	10	40	-	-	14,00€
B	13708 PINZE PER FASCETTE ELASTICAS	0.24	6	48	-	-	14,00€
C	13709 PINZE PER FASCETTE ELASTICAS CON PUNTA DIRITTA	0.24	6	48	576	-	14,00€
D	13710 PINZE PER FASCETTE ELASTICAS 45°	0.70	6	48	1536	-	14,00€
E	13712 PINZE PER ESTRAZIONE DI TUBOS	0.21	10	40	-	-	14,00€
F	51995 PINZA PER FASCETTE	0.53	5	40	480	-	24,50€
G	52791 PINZA PER FASCETTE CLIC-R	0.25	5	50	1500	-	18,00€



52619 23,10€

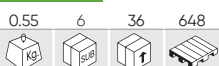

PINZA MORSETTO PER MANICOTTO ALBERO



Fori 1/2" maniglie da utilizzare come chiave
Apertura: 0-20mm



52812 65,00€



PINZA MORSETTO PER MANICOTTO ALBERO



Poiché femmina da 3/8 " a criccheto stringere.
Apertura: 34mm



53487 16,70€



PINZA PER CONDOTTO DEL CARBURANTE



52508 38,40€



PINZA APRIFASCETTE



ANTIBLOCCAGGIO

52509 36,20€



UTENSILI MANUALI

52625

9,00€

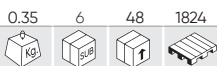

PINZA PER FRENI A TAMBURO



51355

19,00€

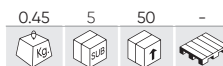

PINZA SPECIALE PER CONTRAPPESI



52982

53,00€



KIT DI 3 PINZE AUTOBLOCCANTE SUPERLUNGHE



53445

17,10€

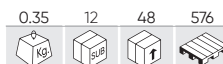

SET DI PINZE PIATTE PER SCOLLEGARE TUBO DEL CARBURANTE



- x1 ■ 5/16" Ø 8mm
- x1 ■ 3/8" Ø 10mm
- x1 ■ APPLICAZIONE SPECIALE



51972

12,00€

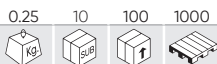

PINZA SPELLAFILI AUTOREGOLABILE



0.25~2.5mm²

08-6mm



52152

13,50€

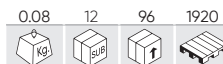

FORBICI TAGLIACAVI

ACERO INOXIDABILE
STAINLESS STEEL

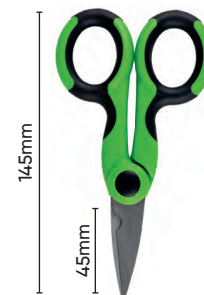

53411

5,00€

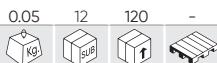

TENAGLIE SPELLAFILI



53412

4,00€

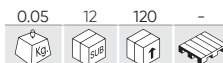

TENAGLIE SPELLAFILI



TENAGLIE SPELLAFILI

REF.	DESCRIZIONE					€
53602	360mm - Ø 125mm ²	0.60	-	5	300	30,50€
53603	550mm - Ø 250mm ²	1.75	-	5	300	45,00€
53604	800mm - Ø 500mm ²	3.70	-	5	120	118,00€



CESOIE

REF.	DESCRIZIONE					€
52955	12" - 300mm	0.77	-	20	200	19,80€
52956	14" - 350mm	0.95	-	20	200	19,60€
52957	18" - 450mm	1.47	-	10	360	23,80€
52958	24" - 600mm	2.40	-	8	210	28,20€
52959	30" - 750mm	3.78	-	5	100	42,00€
52960	36" - 900mm	5.15	-	5	105	46,00€



53385

19,30€

0.15 6 54 1026



PINZA PER L'ESTRAZIONE DI GRAFFETTE DA CARROZZERIA



53976

9,00€

0.20 6 60 1440



PINZA PUNTA SPECIALE TERMINALI 6" 160MM



52761

8,00€

0.25 12 72 1800



PINZA PER CAPICORDA ISOLATI E NON ISOLATI 9"



53932

8,00€

0.25 12 72 1296



PINZA PER CAPICORDA ISOLATI E NON ISOLATI 9"



52762

9,00€

0.25 12 72 1800



PINZA PER CAPICORDA NON ISOLATI 8-3/4"

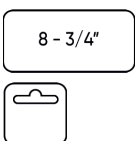

16111

19,20€

0.61 - 10 200



MODULO EVA SBAVELLATORE E TERMINALI



54254

43,00€

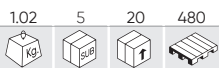

PINZA A CRICCHETTO CON PUNTA INTERCAMBIABILE

7 PCS

CONTIENE

- PINZE DA 9"
- PUNTA DA 0,15-6 MM°
- PUNTA DA 10-35 MM°
- PUNTA DA 0,5-6 MM°
- PUNTA DA 0,5-10 MM°
- PUNTA DA 0,5-4 MM°
- CACCIAVITE PH2X150



54112

18,00€

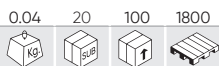

ESTRATTORE DI TERMINALI CON SEI CONNETTORI

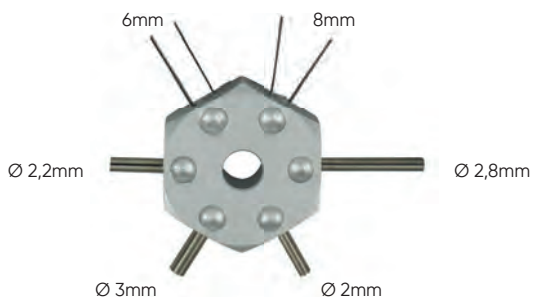

54142

15,20€



SET DI GANCI, SPUNTONI E LEVE ANTI-SEGNI

6 PCS

CONTIENE

- 2 punte a gancio
- 2 punte dritte
- 2 punte ad angolo
- 6 punte con leve



PROLUNGA FLESSIBILE

REF.	DESCRIZIONE	Ø	—					€
51525	PROLUNGA FLESSIBILE CON PUNTA MAGNETICA	A	7mm	500mm	0.14	10	60 960	9,80€
51526	PROLUNGA FLESSIBILE CON PUNTA A 4 ARTIGLI	B	20mm	500mm	0.10	12	144 2016	9,80€
52473	PROLUNGA FLESSIBILE MAGNETICA CON LED	C	15mm	545mm	0.18	10	60 960	9,90€

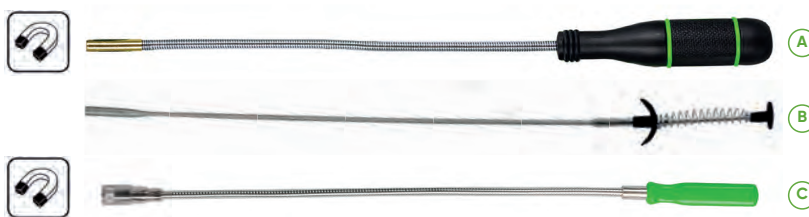

STRUMENTI DI ISPEZIONE

REF.	DESCRIZIONE	Ø	—					€
51272	SPECCHIETTO DI ISPEZIONE TELESCOPICO CON LED	A	18mm	90-810mm	0.05	12	72 1512	7,50€
52472	PROLUNGA TELESCOPICA TIPO "ANTENNA" CON PUNTA MAGNETICA	B	10mm	135-600mm	0.15	12	108 4320	4,90€
52468	SPECCHIETTO DI ISPEZIONE TELESCOPICO	C	50mm	280-445mm	0.09	12	48 1536	5,90€



15706

31,00€



MODULO EVA DI STRUMENTI MAGNETICI DA RACCOLTA - 5 PEZZI



15799

28,30€



MODULO DI MARTELLI: MODULO IN FIBRA DI CARBONIO CON EVA



MARTELLI PROFESSIONALI CON IMPUGNATURA IN GOMMA

REF.	DESCRIZIONE					€
52182	2Kg - 297mm	2.20	6	12	504	24,00€
52184	4Kg - 880mm	4.31	-	4	128	43,00€
52185	6Kg - 895mm	6.97	-	4	72	55,00€
52186	8Kg - 900mm	8.68	-	2	72	72,00€



MARTELLI NYLON ANTI-RIMBALZO

REF.	DESCRIZIONE					€
52425	Ø 40mm	0.70	6	12	768	33,30€
52426	Ø 60mm	1.50	2	12	288	52,00€
52427	Ø 70mm	2.02	2	12	204	64,00€



PUNTA DI RICAMBIO

REF.	mm					€	REF.	mm					€	REF.	mm					€
11212	Ø 40	0.02	5	100	-	5,00€	11213	Ø 60	0.08	5	50	-	10,60€	11214	Ø 70	0.11	5	50	-	12,50€

MARTELLI PUNTA DRITTA

REF.	DESCRIZIONE					€
51674	505g	0.60	6	36	864	7,75€
52565	1000g	1.13	6	24	720	11,50€



MARTELLI PUNTA SFERICA

REF.	DESCRIZIONE					€
51504	454g	0.55	4	40	800	8,50€
51918	1000g	1.25	6	18	648	12,50€



MARTELLI PROFESSIONALI ANTI-RIMBALZO

REF.	DESCRIZIONE					€
52180	1,35Kg - 355mm	1.45	6	12	432	19,00€
52181	1,80Kg - 370mm	1.81	6	12	300	22,50€
52183	2,20Kg - 405mm	2.30	6	12	288	26,20€



ASCIA CON MANICO IN LEGNO

REF.	DESCRIZIONE					€
52188	360mm	0.82	4	24	875	15,50€
52460	410mm	1.17	4	24	864	16,60€
52461	700mm	2.00	4	12	240	25,70€



UTENSILI MANUALI

52830

24,00€

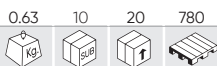

SEGHETTO CON MANICO ERGONOMICO



IN ESPOSITORE DA 10 UNITÀ

REF. DESCRIZIONE

12060 LAMA PER SEGHETTO REF.52830 + 52831 + 51675

0.02 100 800 - 2,50€

52831

18,00€

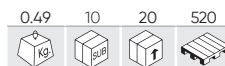

SEGHETTO



IN ESPOSITORE DA 10 UNITÀ

53591

5,50€

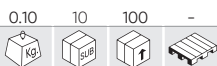

COLTELLO SPELAFILI

- Campo di taglio: 8-28 mm.
- Lunghezza del prodotto: 170 mm.
- Lunghezza della tela: 20 mm.
- Profondità del gancio: 5 mm.



52786

14,60€

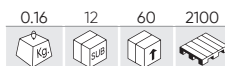

COLTELLINO DI SICUREZZA CON SISTEMA DI TAGLIO CINTURE E ROMPICRISTALLO



IN ESPOSITORE DA 12 UNITÀ

TAGLIATUBI

REF.	DESCRIZIONE	kg	SUB	↑	↳	€
52878	3-32mm	0.22	10	50	1500	11,20€
52879	3-35mm	0.24	10	50	1500	10,10€
52877	Ø MAX: 42mm	0.43	6	48	624	15,80€
53517	Ø MAX: 30mm	0.13	10	60	600	9,50€



52885

18,00€

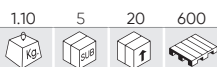

SET 12 FUSTELLE - METRICHE

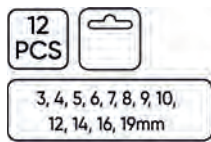

54331

27,00€

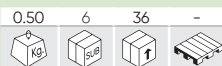

N

SET DI 3 TAGLIERINI PROFESSIONALI



	LAMA	DIMENSIONI LAMA	LUNGHEZZA	PESO
A	x4	60x19mm	175mm	115,5g
B	x1	100x10mm	160mm	129,7g
C	x4	60x19mm	175mm	115,5g

RICAMBI DISPONIBILI

REF.	DESCRIZIONE				€
16342	SET DI 10 LAME DI RICAMBIO PER RIF.54331	0.01	10	100	2,50€
16343	SET DI 10 LAME A TRAPEZIO DI RICAMBIO PER RIF.54331	0.01	10	100	2,50€

51909

2,46€

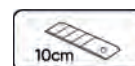
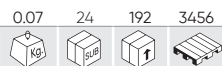

CUTTER PROFESSIONALE



IN ESPOSITORE DA 24 UNITÀ



RICAMBI DISPONIBILI

REF.	DESCRIZIONE				€
16642	SET DI 10 LAME DI RICAMBIO PER RIF.51909	0.01	10	100	1,00€

SCALPELLI

REF.	DESCRIZIONE					€
53120	150mm	0.35	6	24	1200	6,00€
53121	250mm	0.55	6	24	864	7,35€
53122	350mm	0.90	6	12	720	9,50€



ACERO 45C

53083

64,00€

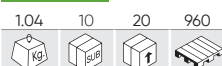

SET DI 4 SCALPELLI

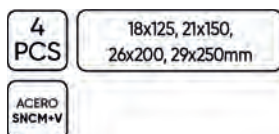

54089

17,50€



SET DI 5 SCALPELLI



RICAMBI DISPONIBILI

REF.	mm				€
15783	155x10	0.09	6	24	3,50€
15784	155x11	0.09	6	24	3,50€
15785	155x12	0.09	6	24	3,50€
15786	155x14	0.09	6	24	3,50€
15787	155x16	0.09	6	24	3,50€



53095

20,50€



SET 6 PUNZONI



54099

13,80€



SET DI 5 PUNZONI

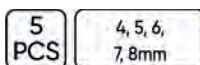

15737

45,00€



MODULO DI CESOIE E PUNZONI

9 PCS



52049

14,00€



SET DI 5 PUNZONI CONICI



13667

17,60€



MODULO EVA PER RIVETTATRICE E RIVETTI



53993

77,00€



RIVETTATRICE ARTICOLATA MULTIFUNZIONALE

- Testa rotante a 360°
- Compatto, rende facile il lavoro in piccoli spazi
- Il design permette di eseguire il lavoro con una sola mano

CONTIENE

- Inserti di rivettatura standard 2,4 mm (3/32") - 3,2 mm (1/8") - 4,0 mm (5/32") - 4,8 mm (3/16")
- Punzoni per dadi a rivetto M3x0,5 - M4x0,7 - M5x0,8 - M6x1
- Punzoni per rivetti M6x1 - M5x0,8 - M4x0,7
- 3 chiavi per dadi 5,5x8,5 mm - 12x17 mm - 15x19 mm
- Portamandrino M6x1 - M5x0,8 - M4x0,7 - M3x0,5"



52596

114,00€

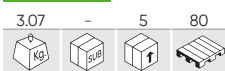

RIVETTATRICE 400MM / 16"



52597

146,00€



RIVETTATRICE AUTOMATICA 440MM / 17"



RICAMBI PER REF. 52595, 52596, 52597

REF.	DESCRIZIONE				€
13226	M3	0.03	-	100	4,50€
13227	M4	0.04	20	100	4,50€
13228	M5	0.04	20	100	4,50€
13229	M6	0.04	20	100	4,50€

REF.	DESCRIZIONE				€
13230	M8	0.04	20	100	4,50€
13231	M10	0.05	-	100	4,50€
13232	M12	0.05	-	100	4,50€



52463

26,10€



RIVETTATRICE 300MM / 12"



52464

42,00€

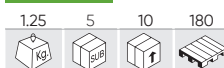

RIVETTATRICE 400MM/16"

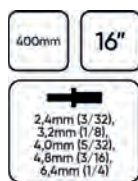

53331

31,80€



RIVETTATRICE 10" 250MM

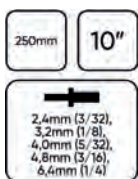

53332

34,50€

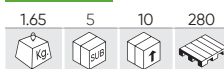

RIVETTATRICE ESTENSIBILE 8" 200MM



UTENSILI MANUALI

52595

64,00€

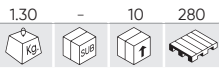

RIVETTATRICE COMPATTA 200MM / 8"

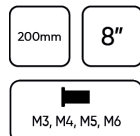

52462

25,30€

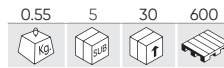

RIVETTATRICE COMPATTA 200MM / 8"



52609

29,00€

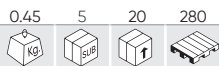

RIVETTATRICE + SET DI RIVETTI IN PLASTICA

Ø 6,6mm x 17,2mm (10u.)
Ø 6,3mm x 25,2mm (10u.)
Ø 5mm x 17,2mm (10u.)
Ø 5mm x 15,8mm (10u.)



RICAMBI DISPONIBILI

REF.	Ø				€
13674	6x19,3mm	0.04	25	2500	0,50€
13675	6x17,8mm	0.01	25	500	0,50€
13676	6x25,5mm	0.01	100	1000	0,50€
13677	6x24,5mm	0.03	25	1000	0,50€
13678	6x24mm	0.01	25	1000	0,50€

52575

119,00€

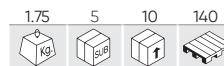

RIVETTATRICE PNEUMATICA



- Trazione: 1586LBS / 720 KGS.
- ROD: 9/16 " - 14MM.
- Coppia max. 60FT IB / 23-69NM.
- Aria: 1/4 ".
- Consumo medio di aria: 0.03CFM/0.86L/MIN.

CONTIENE

- 2 multi-tool
- Veloce
- o-ring



LIVELLA

IN ALLUMINIO

REF.	DESCRIZIONE					€
53613	500mm	0.55	5	30	1260	19,50€
53614	600mm	0.60	5	30	840	21,50€
53615	800mm	0.85	5	20	600	34,60€



TUBOLARE MAGNETICO

REF.	DESCRIZIONE					€
53616	500mm	0.30	5	60	1260	10,40€
53617	600mm	0.30	5	60	840	9,25€
53618	800mm	0.35	5	30	600	13,90€

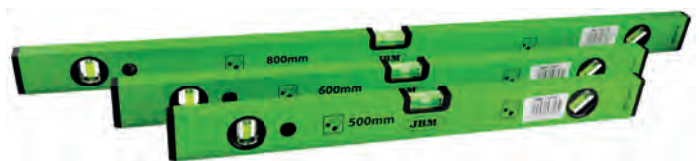

ESPOSITORE PER LIVELLI

REF.					€
14183	0.80	-	10	-	31,00€



METRO FLESSIBILE

REF.	DESCRIZIONE					€
53025	3m x 16mm	0.13	12	48	2016	3,50€
53026	5m x 25mm	0.26	12	48	2016	5,80€
53027	7,5m x25mm	0.40	12	48	1500	9,00€



IN ESPOSITORE DA 12 UNITÀ

52433 4,80€

0.10	10	50	1820

KIT 20 SPESSIMETRI, 0.05-1.0 MM

0,05-1mm



52638 9,95€

0.35	5	50	1800

PINZA FORATRICE ROTATIVA

Ø 2, 2.5, 3, 3.5, 4, 4.5mm



52318 73,00€

0.64	6	24	336

TESTER ANGOLARE DI CADUTA MAGNETIZZATO

-6° / +6°



52904

2.00	-	5	175

CALIBRO A CORSOIO CON SUPPORTO MAGNETICO



61,00€

REF.	DESCRIZIONE					€
13704	CALIBRO A CORSOIO PER REF.52904	0.10	-	50	1500	21,00€

CALIBRO A CORSOIO

REF.				€
50724	0.30	5	50	28,00€
50937	0.24	10	50	10,50€



50724 DIGITALE
50937 MECCANICO

PROFONDIMETRO

REF.				€
52873	0.04	5	300	11,00€
53042	0.05	10	100	9,90€



52873 MECCANICO
53042 DIGITALE

GONIOMETRO

REF.				€
52583	0.20	4	48	8,50€
52794	0.48	6	24	28,00€



52583
52794 MAGNETICO

UTENSILI MANUALI

51951

15,60€



SET DI 3 SPATOLE IN ACCIAIO



53339

9,50€



KIT DI 4 SPATOLE DI ACCIAIO



53589

12,00€



PINZATRICE INDUSTRIALE



ALTEZZA PUNTI: 4-14mm



52700

20,50€



KIT PER SVASATURA TUBI DI SCARICO

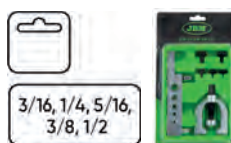

REF.	DESCRIZIONE					€
14167	NR. 100 GRAFFETTE PER RIF. 53589 (11,3 X 0,7 X 8 MM)	0.10	50	100	-	2,50€

51853

18,00€



SET DI 5 LIME IN ACCIAIO



52760

4,10€



SPAZZOLE METALLICHE



52515

9,10€



SPAZZOLE METALLICHE



52905

28,00€



ATTREZZI CURVATUBI 6-8-10MM



GRADI CON ETICHETTA

TUBI IN ALLUMINIO, RAME E ACCIAIO

MOBILI DA OFFICINA

- 72 CARRELLI CON UTENSILI
- 83 MODULI CON UTENSILI
- 90 ACCESSORI/ RICAMBI
- 93 TAVOLI DA LAVORO
- 95 ARCHIVIAZIONE
- 99 SGABELLI / CARRELLO SOTTOAUTO
- 100 INCUDINI / MORSE DA BANCO



54327

2.788,00€



N

SET DI MOBILI COMPONENTI PER OFFICINA (18 PEZZI)



MOBILE A 6 CASSETTI CON SUPERFICIE IN GOMMA

DIMENSIONI TOTALI

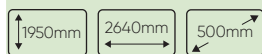

GIUNTO QUADRATO

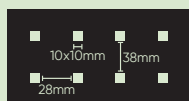

MISURE SPECIFICHE

	A	B	C	D	E	F	G
ALTEZZA	1890mm	340mm	340mm	38mm	900-950mm	750-880mm	900-950mm
LUNGHEZZA	600mm	680mm	680mm	2040mm	680mm	666mm	680mm
LARGHEZZA	500mm	280mm	25mm	500mm	500mm	460mm	500mm

MISURE INTERNE

	A1	B1	E1	E2	E3	F1	F2	G1
ALTEZZA	1890mm	340mm	58mm	136mm	216mm	58mm	137mm	715mm
LUNGHEZZA	600mm	680mm	567mm	567mm	567mm	567mm	567mm	596mm
LARGHEZZA	500mm	280mm	408mm	408mm	408mm	408mm	408mm	475mm

PANNELLI PORTAUTENSILI SONO COMPATIBILI CON I NOSTRI GANCI: REF.16354, 16355, 16356, 16357



CONSEGNA SENZA UTENSILI

RICAMBI E ACCESSORI

REF.	DESCRIZIONE					€
16490	MOBILE ALTO (RIF. 54327)	56.20	-	1	-	650,00€
16491	ARMADIO ANGOLARE 800X800X338 MM (RIF.54327)	22.00	-	1	-	307,00€
16492	ARMADIO ANGOLARE CON PANNELLO IN MDF (RIF.54327)	59.40	-	1	-	675,00€
16493	MOBILE A 3 CASSETTI CON SUPPORTO PER BOBINA DI CARTA (RIF. 54327)	41.20	-	1	-	436,00€
16494	ARMADIO A MURO (RIF. 54327)	10.40	-	1	-	139,00€
16496	PANNELLO MDF 1360X500X38MM (RIF. 16627/16628/16500)	19.40	-	1	-	127,00€
16497	PANNELLO MDF 680X500X38MM (RIF. 16627/16628/16500)	9.80	-	1	-	77,00€
16498	SET DI 3 SCHEDE 680X338X25MM (RIF.54327)	6.00	-	1	-	84,00€
16499	SET DI 6 SCHEDE 775X338X25MM (RIF.54327)	13.00	-	1	-	162,00€
16500	MOBILE A 2 ANTE (RIF.54327)	33.60	-	1	-	463,00€
16516	SET DI 4 SCHEDE PER ARMADIO AD ANGOLO (RIF. 16492)	9.20	-	1	-	121,00€
16561	BARRA DI SUPPORTO (RIF.54327)	7.80	-	4	-	36,50€
16627	ARMADIO CON 4 CASSETTI (RIF.54327)	43.50	-	1	-	225,00€
16628	ARMADIO A 6 CASSETTI (RIF.54327)	49.00	-	1	-	382,00€
16629	TAVOLO DA LAVORO MDF 2040X500X38MM (RIF.54327)	27.80	-	1	-	419,00€
16600	TAVOLA IN ACCIAIO INOX 2040X500MM (RIF.54327)	33.00	-	1	-	252,00€



CARRELLO 12 CASSETTI

53939 1.280,00€

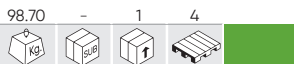

CON UTENSILI

172 PCS

MISURE INTERNE 1A COLONNA

A CASSETTI PICCOLI (X4)



B CASSETTI MEDI (X1)



C CASSETTO GRANDE (X1)



DIMENSIONI TOTALI



53868 1.090,00€



VUOTO

172 PCS

MISURE INTERNE 2A COLONNA

D CASSETTI PICCOLI (X4)

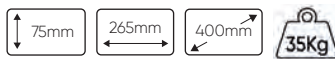

E CASSETTI MEDI (X1)



F CASSETTO GRANDE (X1)



GIUNTO QUADRATO

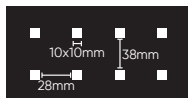

CON ATTREZZATURE EVA:

53708

325,00€



SET DI 4 MODULI DI UTENSILI IN CARBONIO EVA

CONTIENE

REF.	Box	Box	Box	€
14296	6.05	4	80	118,00€
14297	3.30	4	96	87,00€
14298	2.10	4	96	51,50€
14299	3.25	4	96	87,00€

14296



RICAMBI DISPONIBILI



14297



RICAMBI DISPONIBILI



14298



RICAMBI DISPONIBILI



14299



RICAMBI DISPONIBILI



PER MAGGIORI INFORMAZIONI

PAGINA 83

CARRELLO XL 7 CASSETTI

53912 1.280,00€

74.50 - - 4

CON UTENSILI

199 PCS XL

53869 990,00€

74.50 - 1 4

VUOTO

199 PCS XL

53913 1.280,00€

74.50 - - 4

CON UTENSILI

199 PCS XL

53870 990,00€

74.50 - 1 4

VUOTO

199 PCS XL



MISURE INTERNE

CASSETTI PICCOLI (X5)

74mm 705mm 400mm 25Kg

CASSETTI GRANDI (X2)

151,5mm 705mm 400mm 35Kg

GIUNTO QUADRATO

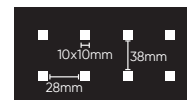

DIMENSIONI TOTALI

984mm 980mm 510mm



CON ATTREZZATURE EVA:

CONTIENE

REF.				€
14296	6.05	4	80	118,00€
14297	3.30	4	96	87,00€

REF.				€
14298	2.10	4	96	51,50€
14299	3.25	4	96	87,00€

REF.				€
15122	1.70	10	200	74,00€
15155	2.45	10	180	59,00€

REF.				€
15161	2.10	10	180	62,00€
15514	0.05	10	360	9,35€

14296

RICAMBI DISPONIBILI

15122

RICAMBI DISPONIBILI

14297

RICAMBI DISPONIBILI

15161

RICAMBI DISPONIBILI

14298

RICAMBI DISPONIBILI

15155

RICAMBI DISPONIBILI

14299

RICAMBI DISPONIBILI

15514

CARRELLO A 7 CASSETTI - VERDE

172 PCS 300Kg

N

54389 790,00€

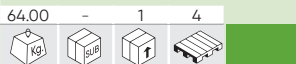

54503 490,00€



CON UTENSILI

VUOTO

MISURE INTERNE

CASSETTI PICCOLI (X5)



CASSETTI GRANDI (X2)



CAPACITÀ DI CARICO DEL CASSETTO: 35KG.
CAPACITÀ DI CARICO TOTALE: 300KG.

DIMENSIONI TOTALI



GIUNTO QUADRATO

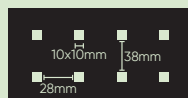

CON ATTREZZATURE EVA:

53708

325,00€

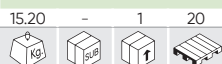

SET DI 4 MODULI DI UTENSILI IN CARBONIO EVA

CONTIENE

REF.	kg	box	unit	€
14296	6.05	4	80	118,00€
14297	3.30	4	96	87,00€
14298	2.10	4	96	51,50€
14299	3.25	4	96	87,00€

14296



RICAMBI DISPONIBILI



14297



RICAMBI DISPONIBILI



14298



RICAMBI DISPONIBILI



14299



RICAMBI DISPONIBILI



PER MAGGIORI INFORMAZIONI

PAGINA 83

CARRELLO 7 CASSETTI

53661 790,00€

65.50 - 1 4

CON UTENSILI

53761 490,00€

52.50 - 1 4

VUOTO

53767 790,00€

56.00 - 1 4

CON UTENSILI

53768 490,00€

56.00 - 1 4

VUOTO

53686 790,00€

65.00 - 1 4

CON UTENSILI

53762 490,00€

55.50 - 1 4

VUOTO

53904 790,00€

65.00 - 1 4

CON UTENSILI

54006 490,00€

55.00 - 1 4

VUOTO

MISURE INTERNE

CASSETTI PICCOLI (X5)

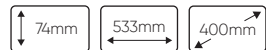

CASSETTI GRANDI (X2)



CAPACITÀ DI CARICO DEL CASSETTO: 30KG.
CAPACITÀ DI CARICO TOTALE: 70KG.

DIMENSIONI TOTALI



GIUNTO QUADRATO

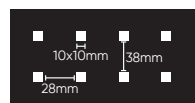

172 PCS 280Kg



CON ATTREZZATURE EVA:

53708 325,00€

15.20 - 1 20

SET DI 4 MODULI DI UTENSILI IN CARBONIO EVA

CONTIENE

REF.	Kg	1	20	€
14296	6.05	4	80	118,00€
14297	3.30	4	96	87,00€
14298	2.10	4	96	51,50€
14299	3.25	4	96	87,00€

14296



RICAMBI DISPONIBILI



14297



RICAMBI DISPONIBILI

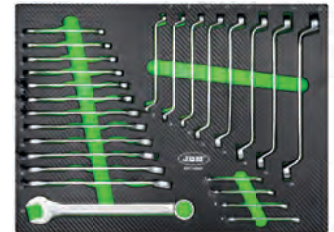

14298



RICAMBI DISPONIBILI



14299



RICAMBI DISPONIBILI



PER MAGGIORI INFORMAZIONI

PAGINA 83



CARRELLO 7 CASSETTI SPECIALE PER AUTOCARRI

54240 1.887,00€

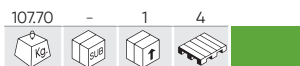

CON UTENSILI

54237 1.887,00€



CON UTENSILI

54238 1.887,00€

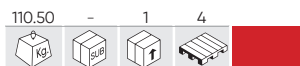

CON UTENSILI

54239 1.887,00€



CON UTENSILI

MISURE INTERNE

CASSETTI PICCOLI (X5)



CASSETTI GRANDI (X2)



CAPACITÀ DI CARICO DEL CASSETTO: 30KG.
CAPACITÀ DI CARICO TOTALE: 70KG.

DIMENSIONI TOTALI



GIUNTO QUADRATO

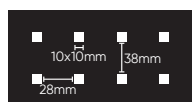

CON ATTREZZATURE EVA:

54134

1.415,00€

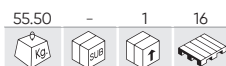

MODULO DI ATTREZZI DI RIPARAZIONE PER AUTOCARRI

CONTIENE

REF.	Box	Box	Pallet	€
15730	10.22	2	48	289,00€
15731	5.20	2	48	214,00€

REF.	Box	Box	Pallet	€
15732	6.40	2	48	293,50€
15733	3.55	2	48	113,00€

REF.	Box	Box	Pallet	€
15734	9.40	2	48	288,50€
15735	10.00	2	48	152,00€

REF.	Box	Box	Pallet	€
15736	14.80	2	40	488,50€

15730

RICAMBI DISPONIBILI

15731

RICAMBI DISPONIBILI

15732

RICAMBI DISPONIBILI

15733

RICAMBI DISPONIBILI

15734

RICAMBI DISPONIBILI

15735

RICAMBI DISPONIBILI

15736

RICAMBI DISPONIBILI

PER MAGGIORI INFORMAZIONI

PAGINA 84



CARRELLO 7 CASSETTI VDE SPECIALE

54236 1.856,00€

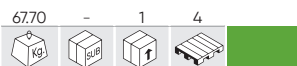

CON UTENSILI

54233 1.856,00€

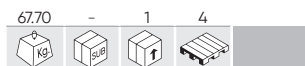

CON UTENSILI

54234 1.856,00€

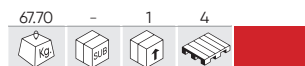

CON UTENSILI

54235 1.856,00€

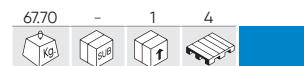

CON UTENSILI

MISURE INTERNE

CASSETTI PICCOLI (X5)



CASSETTI GRANDI (X2)



CAPACITÀ DI CARICO DEL CASSETTO: 30KG.
CAPACITÀ DI CARICO TOTALE: 70KG.

DIMENSIONI TOTALI



GIUNTO QUADRATO

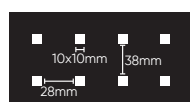

Carrello appositamente configurato per coprire tutte le esigenze di base derivate dalla manutenzione e riparazione di veicoli ibridi ed elettrici, oltre che per lavori in alta tensione.



CONTIENE

REF.	DESCRIZIONE	UNI.					€
52162	TERMOMETRO LASER -50°C A 550°C	1	0.17	6	72	576	38,00€
53940	PALO IN PLASTICA PER CATENA - GIALLO / NERO	4	0.55	-	6	90	13,20€
54326	CATENA IN PLASTICA - 7M - GIALLO/NERO	4	0.30	-	20	720	7,30€
53942	ANELLO DELLA CATENA IN PLASTICA NERO	8	0.01	50	5000	75000	0,50€
54093	MODULO IN EVA CON UTENSILI ISOLATI VDE 25 PEZZI	1	3.25	-	4	80	441,00€
54114	MISURATORE DI ISOLAMENTO	1	1.48	-	10	100	248,00€
54129	TAPPETINO ISOLANTE CLASSE 0	1	0.03	10	50	-	110,00€
54130	GUANTI ISOLANTI PER LAVORI IN TENSIONE T9	1	0.35	-	1	100	58,00€
54132	VISIERA ISOLANTE PER LAVORI IN TENSIONE	1	0.70	-	1	72	190,00€
54241	PALO DI SOCCORSO ISOLATO - 45KV	1	1.10	-	1	50	120,00€

PER MAGGIORI INFORMAZIONI

PAGINA 345

CARRELLO 7 CASSETTI CON MODULI DI UTENSILI SPECIALI PER KIT DI MESSA IN FASE

53951 1.794,00€

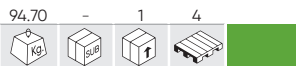

CON UTENSILI

53952 1.794,00€

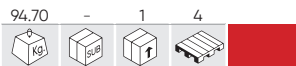

CON UTENSILI

54501 1.794,00€

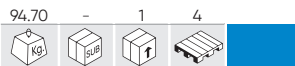

CON UTENSILI

54502 1.794,00€

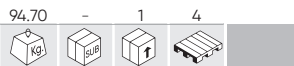

CON UTENSILI

MISURE INTERNE

CASSETTI PICCOLI (X5)

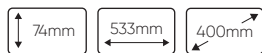

CASSETTI GRANDI (X2)



CAPACITÀ DI CARICO DEL CASSETTO: 30KG.
CAPACITÀ DI CARICO TOTALE: 70KG.

DIMENSIONI TOTALI



GIUNTO QUADRATO

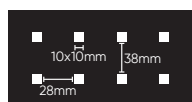

CON ATTREZZATURE EVA:

53775

1.109,00€

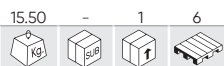

SET DI 6 MODULI KIT DI MESSA IN FASE

CONTIENE

REF.	Kg	Box	Tray	€
53769	5.90	3	36	178,00€
53770	6.15	3	36	198,00€

REF.	Kg	Box	Tray	€
53771	4.05	3	36	158,00€
53772	6.40	3	36	229,00€

REF.	Kg	Box	Tray	€
53773	6.60	3	36	298,00€
53774	6.95	3	36	190,00€

PER MAGGIORI INFORMAZIONI

PAGINA 297

53769



RENAULT / NISSAN / OPEL / VOLVO

53770



FORD / SEAT / VOLKSWAGEN / MAZDA / VOLVO

53771



FIAT / FORD / CITROËN / PEUGEOT

53772



FORD / VAG / MAZDA / VOLVO

53773



FIAT / ALFA / LANCIA / OPEL / SUZUKI / FORD

53774



OPEL / CHEVROLET / SAAB / FIAT / LANCIA / SUZUKI / FORD

54295

500,00€



N

CARRELLO UTENSILI 7 CASSETTI UGUALI VERDE - VUOTO

DIMENSIONI TOTALI



GIUNTO QUADRATO

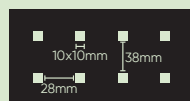

MISURE INTERNE



54296

520,00€



N

CARRELLO UTENSILI 8 CASSETTI UGUALI VERDE - VUOTO

DIMENSIONI TOTALI



GIUNTO QUADRATO

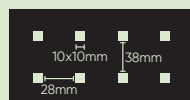

MISURE INTERNE



54297

540,00€

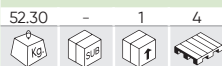

N

CARRELLO UTENSILI 9 CASSETTI UGUALI VERDE - VUOTO

DIMENSIONI TOTALI

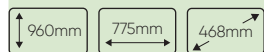

GIUNTO QUADRATO

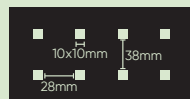

MISURE INTERNE



53672

440,00€

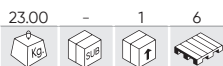

97 PCS

CARRELLO MODULARE



3 MODULI INDIPENDENTI DOTATI DI:



	1/2"	x11	8,10,11,12,13,14,16,17,19,21,22mm
	1/4"	x13	4,4.5,5,5.5,6,7,8,9,10,11,12,13,14mm
	1/2"	x1	
	1/4"	x1	
	1/2"	x2	125,300mm
	1/4"	x2	50,100mm
		x1	180mm
		x1	160mm
		x2	160mm, 180mm
		x2	PH2x125, PH1x100mm
		x2	6x150mm, 5x100mm
		x9	8,9,10,11,12,13,14,17,19mm
		x1	250mm
		x1	300g
		x1	250mm
		x1	200mm
		x8	1,5x8mm
		x1	3mm
	1/4"	x32	
	1/4"	x1	
	1/4"	x1	
	1/4"	x1	
	1/2"	x1	
	1/4"	x1	

A CASSETTA DEGLI ATTREZZI IN MODULI EVA + VASSOIO SUPERIORE RIMOVIBILE



B 2 CASSETTI CON UTENSILI IN MODULI EVA



C VANO AD APERTURA FRONTALE



53867

1.095,00€

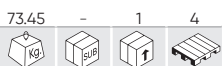

CARRELLO A 9 CASSETTI CON DIVISORI - VERDE

DIMENSIONI TOTALI

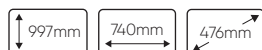

MISURE INTERNE



REF.	mm	UNI.			€
15073	174x53mm	21	0.05	200	1,00€
15076	396x53mm	18	0.30	50	3,50€

POTREBBE INTERESSARTI ANCHE...

REF.	mm			€
15070	67x53mm	0.05	200	0,50€
15071	103x53mm	0.05	200	0,60€
15072	138x53mm	0.05	200	0,70€
15074	210x53mm	0.10	200	1,00€
15075	280x53mm	0.10	200	1,20€



CON SEPARATORI ORGANIZZAZIONE LIBERA

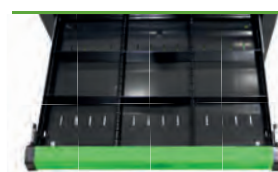

GIUNTO QUADRATO

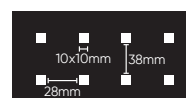



MODULI CON FINITURA IN FIBRA DI CARBONIO EVA

53708 325,00€

15.20 - 1 20

SET DI 4 MODULI DI UTENSILI IN CARBONIO EVA

CONTIENE

14296 118,00€

6.05 - 4 80

	1/2"	x17	x10, 11, 12, 13, 14, 15, 16, 17, 18, 19, 20, 21, 22, 24, 27, 30, 32mm
	1/4"	x13	4, 4.5, 5, 5.5, 6, 7, 8, 9, 10, 11, 12, 13, 14mm
	1/2"	x5	14, 15, 17, 19, 22mm
	1/4"	x8	6, 7, 8, 9, 10, 11, 12, 13mm
	1/2"	x8	E10, E11, E12, E14, E16, E18, E20, E24
	1/4"	x5	E4, E5, E6, E7, E8
	7/16"	x2	1/2" - 1/4"
	1/2"	x2	125, 250mm
	1/4"	x2	50, 100mm
		x2	
	1/2"	x1	
	1/2"	x2	16, 21mm

		x2	PH1, PH2
		x2	PZ1, PZ2
	1/4"	x4	3, 4, 5, 6mm
		x3	SL4, SL5.5, SL6.5
		x8	T8, T10, T15, T20, T25, T27, T30
		x2	PH3, PH4
		x2	PZ3, PZ4
	8mm	x5	7, 8, 10, 12, 14mm
		x3	SL8, SL10, SL12
		x5	T40, T45, T50, T55, T60
		x1	1/4"
		x1	1/4"
	1/2"	x1	8mm
		x3	1.5, 2, 2.5mm

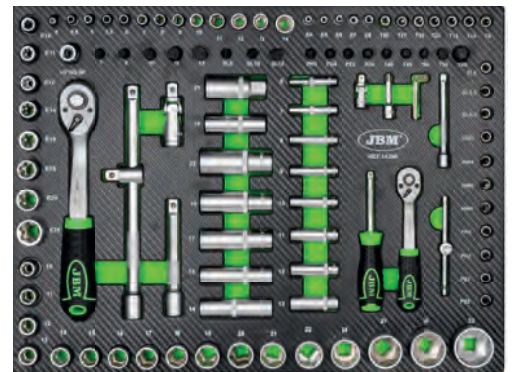

14297 87,00€

3.30 - 4 96

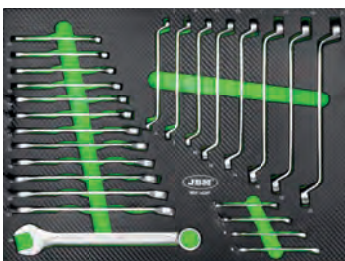

	6x7, 8x9, 10x11, 12x13, 14x15, 16x17, 18x19, 20x22mm
	6, 7, 8, 10, 11, 12, 13, 14, 15, 17, 19, 22mm

14298 51,50€

2.10 - 4 96



		PH0x75, PH1x100, PH2x100, PH3x150, PH4x200
		6, 7, 8, 10, 11, 12, 13, 14, 15, 17, 19, 22mm
		2x38mm
		6x38mm
		1.5, 2, 2.5, 3, 4, 5, 6, 8, 10mm
		10, 15, 20, 25, 27, 30, 40, 45, 50mm

14299 87,00€

3.25 - 4 96



	35mm		8"
	450g		10"
	10"		7.5"
	8"		3m
	8"		

54134

1.415,00€

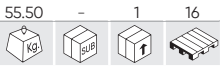

MODULO DI ATTREZZI DI RIPARAZIONE PER AUTOCARRI

CONTIENE

15730

289,00€

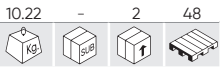

	55mm	H5, H6, H7, H8, H10, H12
	65mm	H14
	70mm	H16, H17, H18, H18, H20
	30mm	H4, H5, H6, H7, H8, H10, H12 T20, T25, T30, T40, T45, T50, T55
	75mm	H4, H5, H6, H7, H8, H10, H12 M5, M6, M8, M10, M12 T20, T25, T30, T40, T45, T50, T55
	1/2" x9	E10, E11, E12, E14, E16, E18, E20, E22, E24
	1/2" x10	10, 11, 12, 13, 14, 15, 16, 17, 18, 19mm

	1/2"	x3	50, 125, 250mm
	1/2"	x1	430mm
	1/2"	x1	10mm
	3/4"	x5	21, 24, 27, 34, 36mm
	3/4"	x4	24, 30, 32, 36 mm
			1/2x10, 3/8x10mm
			1/2x10, 3/8x10mm
	3/8"		10mm
	1/4"		300, 380, 450mm
	1/4"		
	1/2"		12

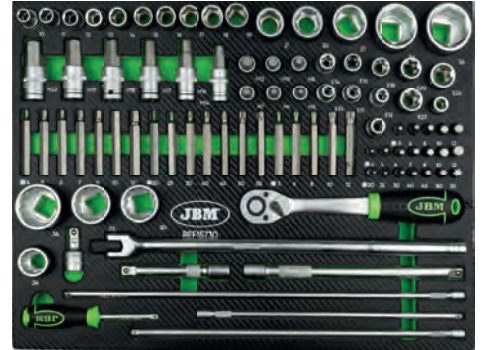

15731

214,00€

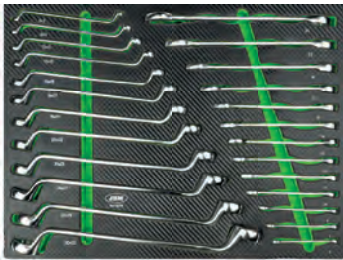
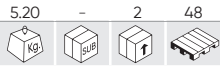

	6x7, 8x9, 10x11, 12x13, 14x15, 16x17, 18x19, 20x22, 21x23, 24x27, 25x28, 30x32mm
	6, 7, 8, 10, 11, 12, 13, 14, 15, 17, 19, 22, 24mm

15732

293,50€

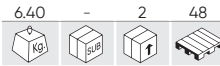

	10, 13, 17mm
	10x11, 12x13, 14x17mm
	E10xE12, E14xE18, E20xE24
	8x10, 11x13, 14x15, 16x17, 18x19mm
	27, 30, 32, 36mm
	10, 13, 17, 19mm

15733

113,00€

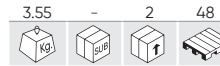

	PH0x75mmL, PH1x75mmL, PH2x100mmL, PH2x38mmL, PH3x150mmL, PH4x200mmL
	SL3.5x75mmL, SL5x75mmL, SL6x100mmL, SL6x38mmL, SL8x150mmL, SL9.5x200mmL
	10x11, 12x13, 14x15mm
	10x11, 12x13, 14x15, 16x17, 18x19mm

15734

288,50€

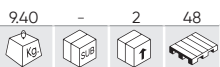

	1kg
	24, 27, 30, 32, 36, 41mm
	3/4" 500mm
	3/4" 500mm
	1.5, 2, 2.5, 3, 4, 5, 6, 8, 10mm

15735

152,00€

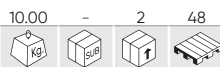

	220mm		250mm
	330mm		6" - 160mm
	330mm		7" - 180mm
	330mm		0°/45°/90°
	330mm		300mm

15736

488,50€



	1/2"	13, 14, 15, 16, 17, 18, 19, 21, 22, 24mm
	3/4"	78mmL 22, 24, 27, 30, 32, 33, 36, 38, 46mm
	1/2"	90mmL 51, 60mm
	1/2"	T40, T45, T50, T60, T70
	1/2"	78mmL H6, H8, H14, H17
	3/4"	100mmL T80, T90, T100
	1/2"	40mmL M18
	1/2"(M)x3/4"(H) - 3/4"(M)x1/2"(H)	
	1/2" - 3/4"	125mm

15681

134,00€

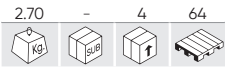

	H3, H4, H5, H6, H7, H8		7, 8, 10, 12, 14mm
	M8, M10, M12		PH3, PH4
	PH0, PH1, PH2, PH3		PZ3, PZ4
	PZ0, PZ1, PZ2, PZ3		8mm
	1/2" SL4, SL5.5, SL6.5, SL7		SL8, SL10, SL12
	T8, T9, T10, T15, T20, T25, T27, T30, T40		T40, T45, T50, T55, T60, T70
	T8, T9, T10, T15, T20, T25, T27, T30, T40		T40, T45, T50, T55, T60, T70
	TS10, TS15, TS20, TS25, TS27, TS30, TS40, TS45, TS50		H7 (230mmL), H10, H11, H13 (140mmL), H14, H17, H19, H22, H24 (55mmL)
	1/2" 8mm		M9 (100mmL), M10, M12, M14 (140mmL), M16 (53mmL), M16 (100mmL)
	3/8" 8mm		1/2" R7, R8 (240mmL), R9 (100mmL), R10 (140mmL)
	1/4" 6mm		T30 (300mmL), T40, T45, T50, T55, T60, T70 (140mmL), T80 (100mmL)
	1/2" M18		HT5 (160mmL)

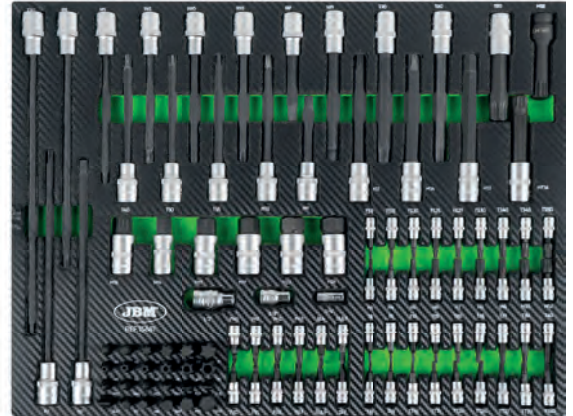

15122 74,00€

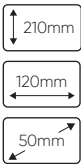
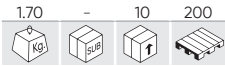

x12 8, 9, 10, 11, 12, 13, 14, 15, 16, 17, 18, 19mm

15155 59,00€

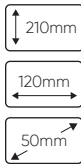
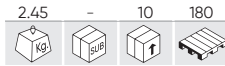

x11 8, 10, 11, 12, 13, 14, 15, 16, 17, 18, 19mm

15156 70,00€

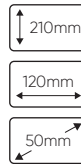
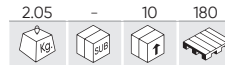

x4 21x23, 24x27, 25x28, 30x32mm

15157 42,00€

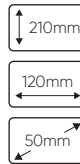

x7 6x8, 10x12, 13x14, 15x17, 19x21, 22x24mm

15158 59,00€

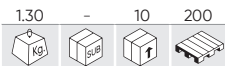

x7 8, 10, 11, 13, 14, 17, 19mm

15159 44,00€

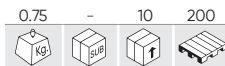

x5 8x10, 11x13, 14x15, 17x19, 20x22mm

15160 42,00€

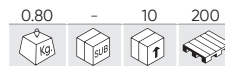

x6 8x9, 10x11, 12x13, 14x15, 16x17, 18x19mm

15161 62,00€

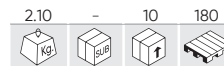

x4 27, 29, 30, 32mm

15316 58,00€

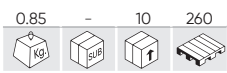

x3 8, 9, 10, 11, 12, 13, 14, 15, 16, 17, 18, 19mm

53943 21,50€

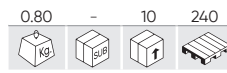

x7 PH4x200, PH3x150, PH2x100, PH2x38 PH1x80, PH0x120, PH1x100

53944 19,50€

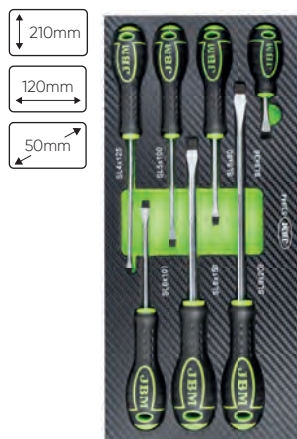
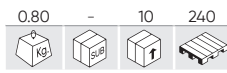

x7 SL9x200, SL4x125, SL5x100, SL5x80, SL6x38, SL6x100, SL8x150mm

53945 18,90€

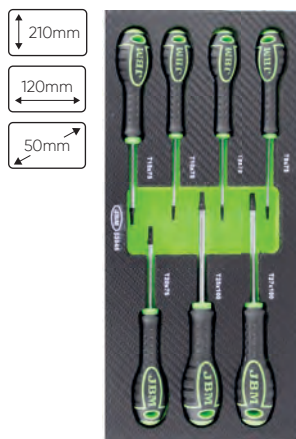
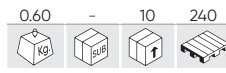

x7 T8x75, T9x75, T10x75, T15x75, T20x75, T25x100, T27x100

15454 35,40€

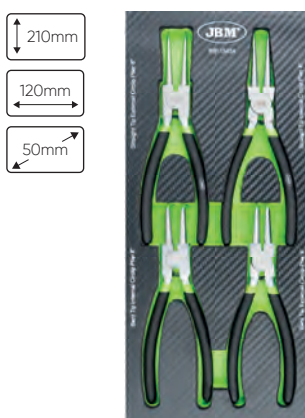
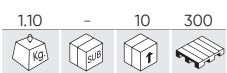

x1 8" x1 8"
x1 8" x1 8"

15541 27,60€

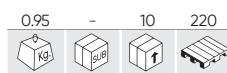

x1 7" - 180mm
x1 8" - 200mm
x1 8" - 200mm

15706 31,00€

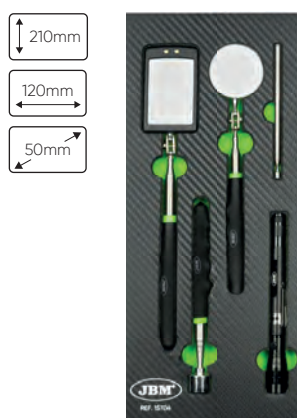
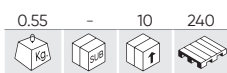

x1 180 - 770mm
x1 130 - 640mm
x1 280 - 870mm
x1 170 - 580mm
x1 495mm

15737 45,00€

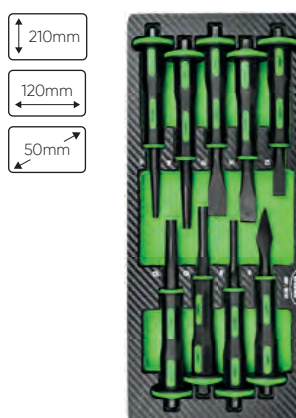
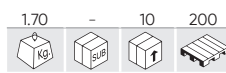

x1 6x180mm
x2 8x180, 10x180mm
x3 6x180, 8x180, 10x180mm
x3 2x160, 16x175, 19x180mm

15315 28,20€

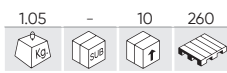

x1 8" x1 8"
x1 8" x1 8"
x1 8"

15514 9,35€

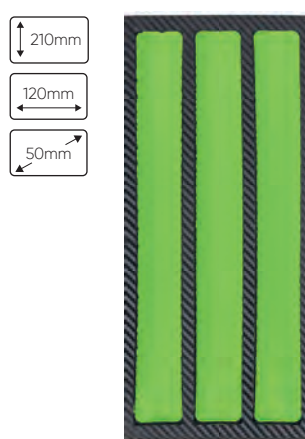

VUOTO

54158 38,00€

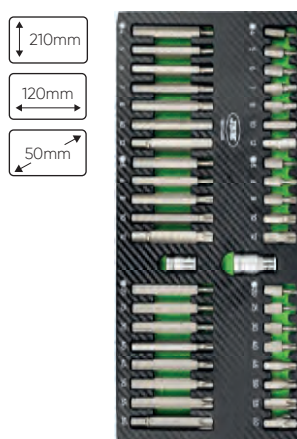
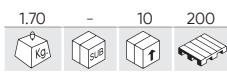

3/8" x1 10mm
1/2" x1 10mm
30mm x7 4, 5, 6, 7, 8, 10, 12mm
75mm x7 4, 5, 6, 7, 8, 10, 12mm
30mm x8 T20, T25, T30, T40, T45, T50, T55, T60
75mm x8 T20, T25, T30, T40, T45, T50, T55, T60
30mm x5 M5, M6, M8, M10, M12
15mm x5 M5, M6, M8, M10, M12

15162 30,20€

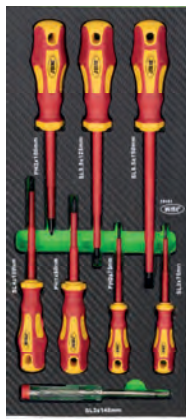
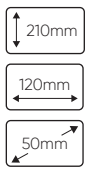
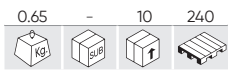

- ⊖ **x4** SL3x75, SL4x100, SL5.5x125, SL6.5x150mm
- ⊕ **x3** PH0x75, PH1x80, PH2x100mm
- **x1** 140mm

54093

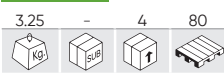

- ⊖ **3/8"** x10 45mm 8, 10, 11, 12, 13, 14, 16, 17, 18, 19, 21, 22mm
- ⊖ **x2** 4x100, 5,5x125mmL
- ⊕ **x2** PH1x80, PH2x100mm
- **x1** 185mm
- **x1** 52mm
- **x1** 185mm
- **x6** 7x86, 8x99, 10x109, 12x127, 14x141, 17x156mm
- **1/2"** x1 125mm
- **3/8"** x1 200mm
- **3/8"** x1 200mm

15799 28,30€

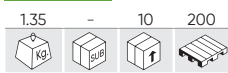

- **x1** 450g
- **x1** 35mm

16111 19,20€

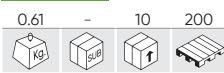

- **x1** 220mm
- ⊖ **BV1.25** ⊖ **BV2**
- ⊖ **RV2-4** ⊖ **RV2-4L**
- ⊖ **SV2-4** ⊖ **SV5.5-6**
- ⊖ **MDD2-250** ⊖ **FDD2-250**

51805 17,00€

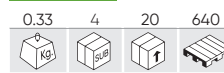

- **x5** 50, 75, 100, 152, 227mm

51447 16,00€

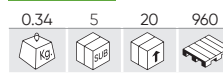

- **x5** 50, 75, 100, 152, 227mm

51448 52,00€

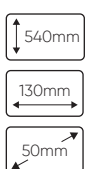

- **x5** 50, 125, 250, 380, 510mm

52912 91,00€

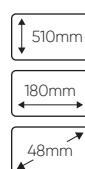

- **x6** E6xE7 (200mmL), E8xE10 (235mmL), E11xE12 (290mmL), E14xE16 (370mmL), E18xE20 (410mmL), E22xE24 (420mmL)

54066 83,00€

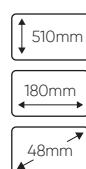

- **x7** 8mm (23,5mmL), 10mm (29,3mmL), 12mm (32,8mmL), 13mm (34,9mmL), 14mm (36,7mmL), 17mm (41mmL), 19mm (42mmL)

51864 64,00€

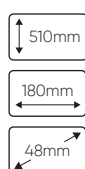
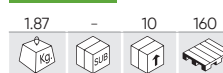

- **x6** 10x11mm (290mmL), 12x14mm (330mmL), 13x15mm (368mmL), 16x18mm (407mmL), 17x19mm (407mmL), 22x24mm (430mmL)

MOBILI DA OFFICINA

54032 84,00€

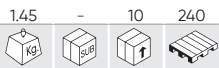

400mm
180mm
50mm



x12 8mm (89mmL), 9mm (94mmL), 10mm (95mmL), 11mm (99mmL), 12mm (102mmL), 13mm (107mmL), 14mm (114mmL), 15mm (117mmL), 16mm (123mmL), 17mm (125mmL), 18mm (130mmL), 19mm (135mmL)

15083 8,50€

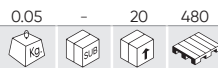

380mm
175mm
50mm



VUOTO

15084 68,00€

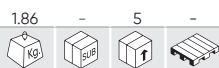

380mm
175mm
50mm

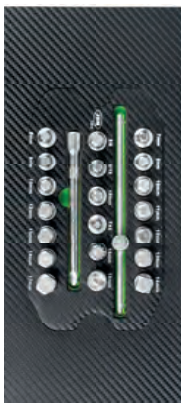

x2 5/16", 3/8"
x7 7, 8, 10, 11, 12, 13, 14mm
x1 10mm
x1 10mm
x7 8, 9, 10, 12, 13, 14, 17mm
x1 T45
x1 M16
x1 200mm
x1 150mm

53979 34,60€

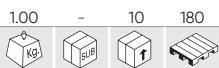

390mm
340mm
50mm

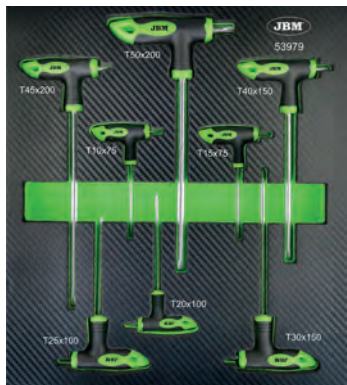

x8 T10x75, T15x75, T20x100, T25x100, T30x150, T40x150, T45x200, T50x200mm

53980 34,60€

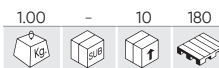

390mm
340mm
50mm



x8 H2x100, H2.5x100, H3x100, H4x150, H5x150, H6x200, H8x200, H10x200

MODULI EVA

11996 48,00€

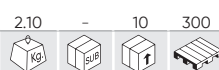

390mm
175mm
50mm



x10 6x7, 8x9, 10x11, 12x13, 14x15, 16x17, 18x19, 20x22, 24x27, 30x32mm

11997 39,00€

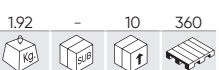

390mm
175mm
50mm



x8 6x7, 8x9, 10x11, 12x13, 14x15, 16x17, 18x19, 20x22mm

11998 49,00€



390mm
175mm
50mm



x17 6, 7, 8, 9, 10, 11, 12, 13, 14, 15, 16, 17, 18, 19, 20, 21, 22mm

13668 18,70€

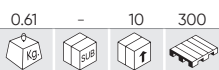

390mm
175mm
50mm



x1 3m
x1 230mm
x1 50mm
x1 250mm

11994 33,00€

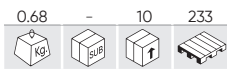

- x1 1/4" x1 250mm
- x1 1/4" x1 125mm
- x1 1/4"
- x13 4, 4.5, 5, 5.5, 6, 7, 8, 9, 10, 11, 12, 13, 14mm

14114 19,30€

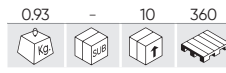

- x1 10"
- x1 10"

13667 17,60€

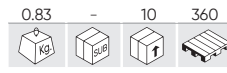

- x1 253mm
- 2x6, 3x7, 3x9, 6x10mm

13923 7,45€

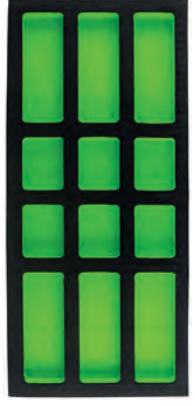
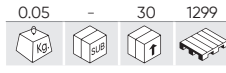

VUOTO

53671 41,00€

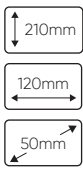
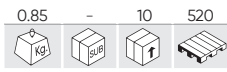

- x3 1/4" - 85 mm
- 1/2" - 135 mm
- 3/8" - 102 mm

53620 88,00€

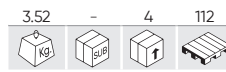

- x17 6, 7, 8, 9, 10, 11, 12, 13, 14, 15, 16, 17, 18, 19, 20, 21, 22mm
- x8 6x7, 8x9, 10x11, 12x13, 14x15, 16x17, 18x19, 20x22mm

MODULI IN PLASTICA

10732 18,70€

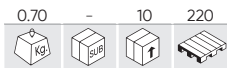

- x1 3m
- x1 230mm
- x1 50mm
- x1 250mm

10735 20,30€

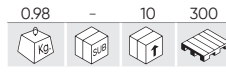

- x1 8"
- x1 8"
- x1 8"
- x1 8"

PANNELLO APPENDI ATTREZZI

REF.	mm					€
52419	A 1000x600mm	7.07	-	1	30	80,00€
52420	B 1500x600mm	10.80	-	2	35	108,00€
52421	C 2000x600mm	14.00	-	1	38	172,00€

GIUNTO QUADRATO

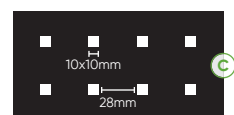
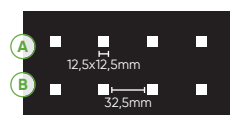
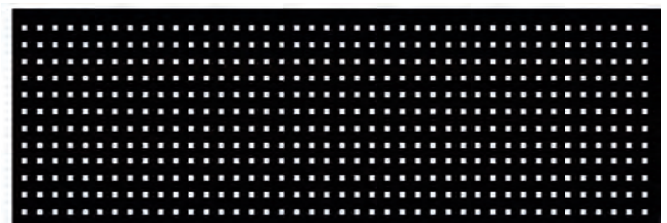

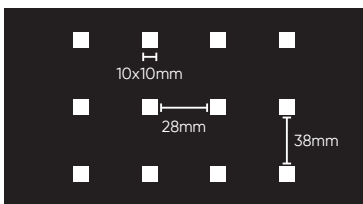

15068 15,20€

0.65 - 25 500



15069 32,80€

1.65 - 1 80



15313 14,00€

0.60 - 1 340

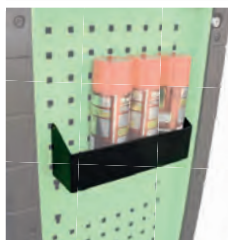

14354 14,00€

0.60 - 1 184



16359 10,00€

0.20 1 30 - **N**



16361 16,50€

0.60 1 30 280 **N**



16362 20,00€

2.00 1 30 - **N**



16363 14,50€

0.40 1 30 - **N**



16344 43,00€

2.00 - 4 72 **N**



16358 12,00€

0.45 1 30 - **N**

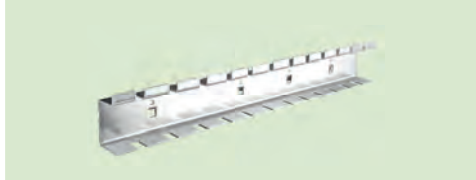

16360 12,00€

0.38 1 30 15 **N**

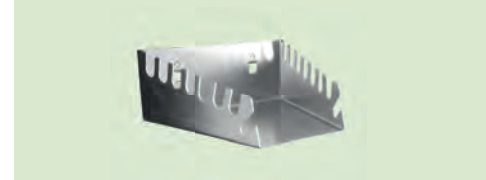

16354 1,50€

0.50 10 100 - **N**



16355 2,00€

0.10 10 100 - **N**

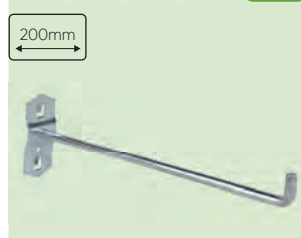

16356 2,50€

0.01 10 100 - **N**



16357 2,50€

0.10 10 100 - **N**

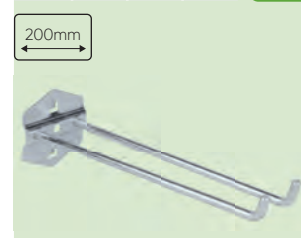

ACCESSORI

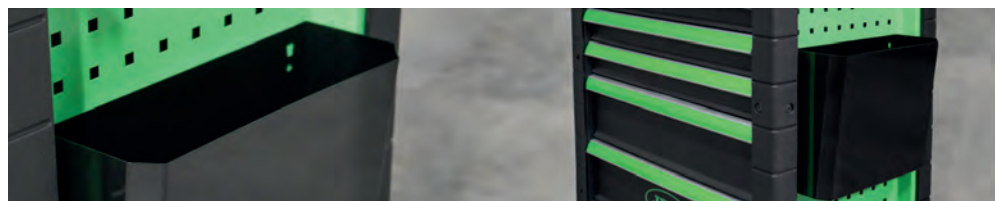
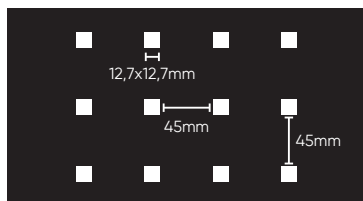

16161 17,50€

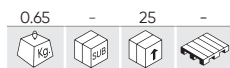

16162 35,10€

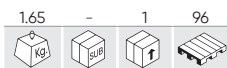

16163 10,20€

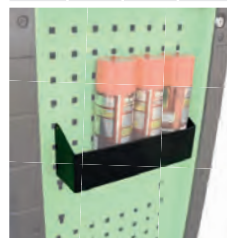

16188 39,60€

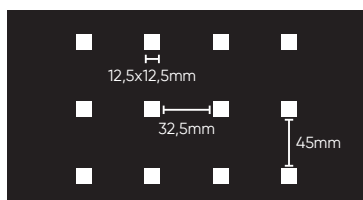

51655 4,10€



51976 1,63€



51658 4,50€



51422 2,97€



52634 5,25€

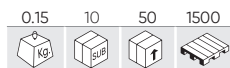

51975 2,27€

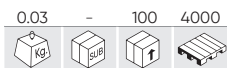

51419 2,79€

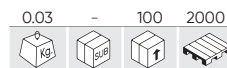

51656 3,65€

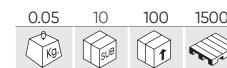

51654 4,80€

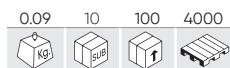

52635 4,80€

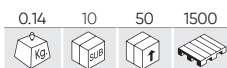

51657 5,85€

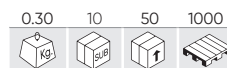

51653 5,10€



RICAMBI

REF.	DESCRIZIONE					€
14578	SET DI 2 INSERTI GRANDI PER CUSCINETTI A SFERE PER 53661, 53686, 53904, 54006	1.05	-	25	-	12,50€
14580	COPERCHIO SUPERIORE PER RIF. 53661 - 53686 - 53904 - 54006 - 54389	2.60	-	3	39	41,00€
14783	BATTISTRADA DESTRO PER RIF. 53686, 53661, 53904, 54006, 54389	0.25	-	50	-	5,50€
15023	RUOTA FISSA PER N. 53765, 53766, 53870	0.65	-	10	-	12,50€
15024	RUOTA GIREVOLE PER N. 53765, 53766, 53870	0.95	-	8	-	15,00€
15025	RUOTA FISSA PER N. 53900, 53901	0.65	-	10	-	12,50€
15026	RUOTA GIREVOLE PER N. 53900, 53901	0.95	-	8	-	15,00€
15030	MANIGLIA PER N. 53765, 53766	0.30	-	50	-	8,00€
15033	MANIGLIA STRETTA PER N. 53868	0.14	-	50	-	6,00€
15034	COPERCHIO SUPERIORE PER N. 53868	2.00	-	2	-	57,00€
15035	MANIGLIA PER N. 53869	0.36	-	20	-	8,50€
15036	MANIGLIA PER N. 53870	0.36	-	20	-	8,50€
15037	MANIGLIA PER N. 53900, 53901	0.10	-	-	-	8,00€
15038	COPERCHIO SUPERIORE PER N. 53869, 53870	2.00	-	2	-	34,50€
15040	RUOTA FISSA PER N. 53904, 54006, 54389	0.66	-	10	-	12,50€
15041	RUOTA GIREVOLE PER N. 53904, 54006, 54389	0.98	-	8	-	15,00€
15042	MANIGLIA PER N. 53904, 54006	0.10	-	1	-	7,50€
15050	MANIGLIA PER N. 53661, 53686	0.10	-	50	-	9,50€
15058	DISPOSITIVO DI PROTEZIONE LATERALE PER N. 53868	0.36	-	-	-	7,50€
15065	DISPOSITIVO DI PROTEZIONE LATERALE PER N. 53869, 53870	0.28	-	12	-	6,50€
16387	MANIGLIA PER N. 54389	0.40	-	-	-	10,50€



LUCCHETTI

CORTI

REF.	DESCRIZIONE					€
53403	38mm	0.15	8	96	3168	6,50€
53405	32mm	0.10	8	96	3168	5,30€
53406	50mm	0.30	8	48	1728	8,55€
53407	63mm	0.35	8	48	3168	12,70€
53408	75mm	0.48	3	24	840	19,30€



LUNGI

REF.	DESCRIZIONE					€
53404	38mm	0.15	8	96	3168	6,50€
53409	50mm	0.30	8	48	3168	9,00€

LUCCHETTI RESISTENTI ALL'ACQUA

REF.	DESCRIZIONE					€
53399	30mm	0.90	8	48	3168	3,50€
53400	40mm	0.20	8	48	499	5,70€
53401	50mm	0.35	8	48	499	7,40€
53402	65mm	0.05	10	40	499	9,60€



54388

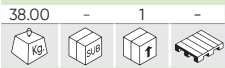

366,00€

N

CARRELLO DIAGNOSTICO

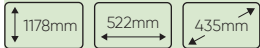

Carrello multifunzione per officina con quattro vassoi e uno scomparto chiuso a chiave. È adatto per collocare computer portatili, tester e caricabatterie.

È dotato di due maniglie e ruote girevoli che ne facilitano il trasporto in modo molto confortevole. Include anche un pannello forato, un porta rotolo di carta e due vassoi laterali per riporre gli attrezzi.

MISURE DEL RIPIANO SUPERIORE	433x398mm
MISURE DEL PANNELLO FORATO	430x475mm
TOTALE RIPIANI	4
CAPACITÀ DEL RIPIANO SUPERIORE	20Kg
DIAMETRO RUOTE	101mm
RUOTE CON FRENI	2



REF. DESCRIZIONE

REF. DESCRIZIONE	Kg	Box	Box	Wheels	€
16481 RUOTE CON FRENO PER REF. 54388	11.60	-	20	-	14,00€
16482 RUOTA PER REF. 50818	2.80	-	20	-	13,50€

51576

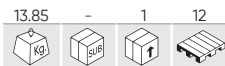

125,00€



CARRELLO CON 3 RIPIANI



52373



252,00€



CARRELLO CON 3 RIPIANI MAXI



51738

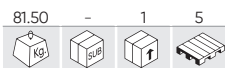

850,00€



TAVOLO DI LAVORO A 3 CASSETTI

DIMENSIONI TOTALI



MISURE INTERNE CASSETTO

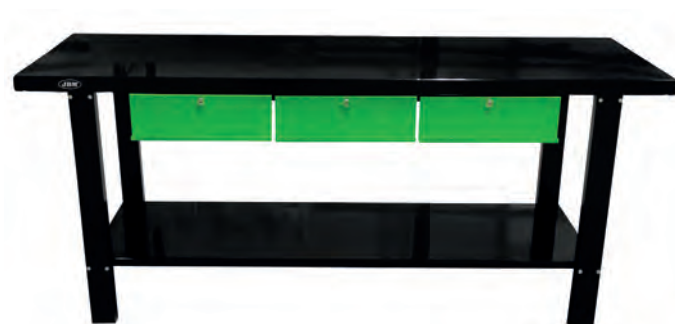

REF. DESCRIZIONE

REF. DESCRIZIONE	Kg	Box	Box	Wheels	€
15144 TAPPETO IN GOMMA PER TAVOLO DA LAVORO, N. 51738	2.50	-	100	100	30,00€

51737

699,00€

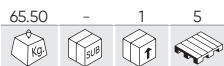

TAVOLO DI LAVORO A 2 CASSETTI



DIMENSIONI TOTALI



MISURE INTERNE CASSETTO



REF. DESCRIZIONE

REF.	DESCRIZIONE	Icona 1	Icona 2	Icona 3	Icona 4	€
15145	SET DI 2 TAPPETINI IN GOMMA PER TAVOLI DA LAVORO, N. 51737	1.90	-	100	100	20,45€

53674

447,00€



TAVOLO DI LAVORO A 1 CASSETTO



DIMENSIONI TOTALI

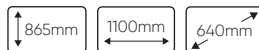

MISURE INTERNE CASSETTO



REF. DESCRIZIONE

REF.	DESCRIZIONE	Icona 1	Icona 2	Icona 3	Icona 4	€
15146	TAPPETO DA SCRIVANIA IN GOMMA, N. 53674	1.35	-	100	100	16,20€

51035

799,00€



TAVOLO DI LAVORO CON PANNELLO FRONTALE



DIMENSIONI TOTALI



GIUNTO QUADRATO

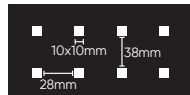

MISURE INTERNE CASSETTO



54328

199,00€



BANCO DI LAVORO PIEGHEVOLE CON PANNELLO



N

DIMENSIONI TOTALI

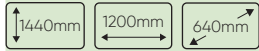

GIUNTO QUADRATO

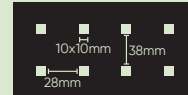

DIMENSIONI PIEGATO

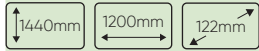

SUPERFICIE DI LAVORO



CONSEGNA SENZA UTENSILI

50957

22,00€

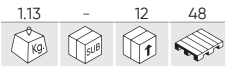

CASSETTA 24+2 SCOMPARTIMENTI



- 24 scompartimenti da 8 x 5,5 cm.
- 2 scompartimenti da 15 x 7,5 cm.
- Selezionabile da 26 a 5 separazioni.

50959

14,00€

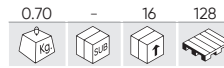

CASSETTA 20+1 SCOMPARTIMENTI



- 20 scompartimenti da 6 x 7 cm.
- 1 scompartimento da 35 x 7 cm.
- Selezionabile da 19 a 4 separazioni.

51051

34,80€

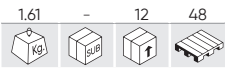

ORGANIZER A 5 SCOMPARTIMENTI



CASSETTI NON SEPARABILI

51050

285,00€

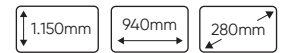
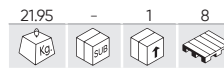

ORGANIZER VERTICALE A 47 SCOMPARTIMENTI

SCOMPARTIMENTI GRANDI

Totale: 15
Misure: 24x14,5x13 cm
Dimensioni dello scaffale: 84x14x24 cm
Totale scaffali: 3

SCOMPARTIMENTI PICCOLI

Totale: 32
Misure: 16x10x7,5 cm
Dimensioni dello scaffale: 84x16x8 cm
Totale scaffali: 4



51574

52,00€

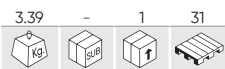

CASSETTA PER UTENSILI PIEGHEVOLE CON 5 SCOMPARTIMENTI



DIMENSIONI TOTALI



APERTO



CASSETTA PER UTENSILI PIEGHEVOLE

REF.						€
54393	750x200x220mm - 9Kg	7.70	-	1	15	92,00€
54394	530x200x220mm - 5,2Kg	5.70	-	1	22	64,00€
54395	450x200x220mm - 4,5Kg	6.20	-	1	24	53,00€



51575

317,00€

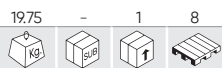

CASSETTA PER UTENSILI CON 6 CASSETTI + SCOMPARTIMENTO SUPERIORE

DIMENSIONI TOTALI

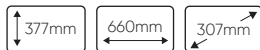

CASSETTI PICCOLI (X3)



CASSETTI MEDI (X2)



CASSETTO GRANDE (X1)



51600

109,00€

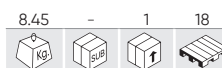

CASSETTA PER UTENSILI CON TRE CASSETTI FRONTALI + SCOMPARTIMENTO SUPERIORE

DIMENSIONI TOTALI

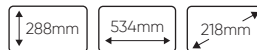

MISURE INTERNE CASSETTO



53782

14,00€



BORSA PER ATTREZZI - GRANDE

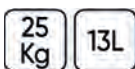

53253

98,00€



VALIGETTA PER ATTREZZI



54080

53,50€

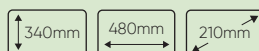

N

BORSA PER ATTREZZI

20L



54374

75,50€



N

ZAINO PER ATTREZZI

15 Kg





ZAINO PER UTENSILI

REF.	DESCRIZIONE					€
53702	BORSA PER ATTREZZI - PICCOLA	1.00	-	5	180	28,50€
53703	BORSA PER ATTREZZI - MEDIA	1.40	-	5	120	41,00€
53704	BORSA PER ATTREZZI - GRANDE	1.65	-	5	120	42,00€

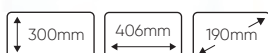

53903

59,00€



SET DI 3 VASSOI PORTAUTENSILI FLESSIBILI ANTISCIVOLO

3
PCS



REF.	DESCRIZIONE					€
15010	285x137x27mm	0.40	-	20	360	16,50€
15011	285x202x27mm	0.45	-	20	320	18,00€
15012	543x300x27mm	1.05	-	10	120	31,50€

VASSOIO MAGNETICO FLESSIBILE

REF.	Ø SUPERIORE	Ø DI BASE	MISURE DISTRIBUITI	MISURE PIEGHEVOLI					€
52516	225mm	88mm	135mm	43mm	0.42	6	24	1152	28,00€
52517	135mm	53mm	90mm	31mm	0.10	12	72	1152	6,00€



50787 8,00€

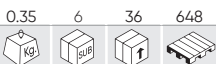

BACINELLA ROTONDA MAGNETICA Ø150MM



50788 14,50€



BACINELLA RETTANGOLARE MAGNETICA



52466 11,00€

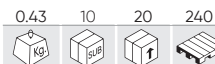

RECIPIENTE MAGNETICO

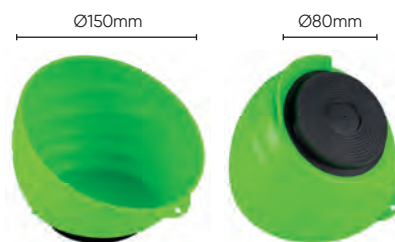

53958 6,50€

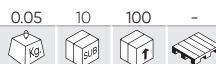

SET DI 5 MAGNETI



50789 29,00€

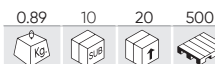

BARRA MAGNETICA PER UTENSILI



53192 52,00€

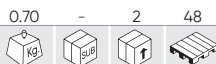

TAPPETO ESTENDIBILE

DIMENSIONI TOTALI



DIMENSIONI PIEGATO



- DI SCHIUMA EVA.



53191 14,80€



TAPPETO INDIVIDUALE IN MATERIALE ESPANSO

DIMENSIONI TOTALI

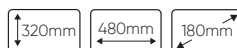

- DI SCHIUMA EVA.



50843

79,00€

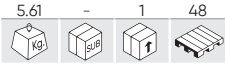

SGABELLO REGOLABILE



Ø 295mm

Ø 380mm



50844

65,00€

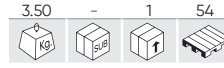

SGABELLO IN ACCIAIO



DIMENSIONI TOTALI



52148

65,00€

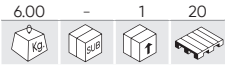

CARRELLO DI PLASTICA

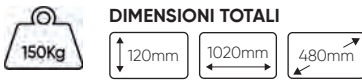

REF. DESCRIZIONE

REF.	DESCRIZIONE	Box	Unit	Pallet	€
11971	RUOTE PER REF. 52148	0.20	5	50	3,60€

50808

77,00€

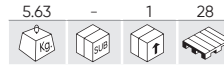

CARRELLO PIEGHEVOLE METALLICO

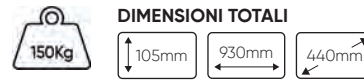

53211

75,00€

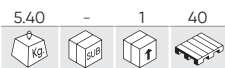

CARRELLO PIEGHEVOLE CONVERTIBILE



DIMENSIONI TOTALI



DIMENSIONI PIEGATO

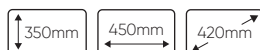

52542

109,00€

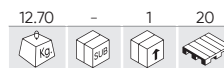

CARRELLO METALLICO PIEGHEVOLE



DIMENSIONI TOTALI



DIMENSIONI PIEGATO

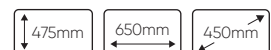

MOBILI DA OFFICINA

52869

52,00€



MORSA DA OFFICINA 100MM



52870

100,00€



MORSA DA OFFICINA 150MM



53031

59,00€

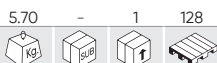

MORSA DA BANCO CON BASE GIREVOLE 4"

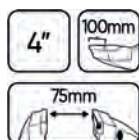

53032

126,00€



MORSA DA BANCO CON BASE GIREVOLE 6"



52871

258,00€

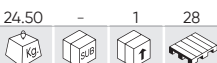

MORSA DA OFFICINA 150MM CON APERTURA RAPIDA



APERTURA IMMEDIATA
CON LEVA +
BANCO GIREVOLE

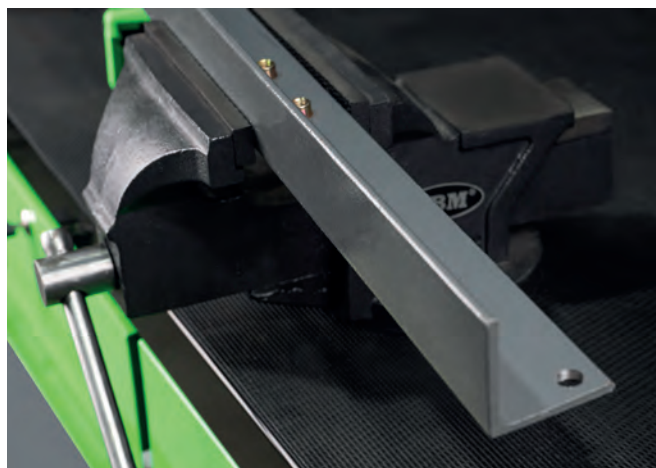

INCUDINE PROFESSIONALE

REF.	Kg.	mm					€
52308	50Kg	190x625x140mm	47.00	-	1	24	440,00€
52309	100Kg	245x790x180mm	100.00	-	1	8	941,00€

ACCIAIO



ELETTROUTENSILI A BATTERIA

- 102 AVVITARE
- 106 FORATURA
- 108 LEVIGARE / LUCIDARE
- 110 TAGLIARE / SEGARE
- 113 STRUMENTI SPECIALI
- 118 ELETTROUTENSILI PER GIARDINAGGIO
- 122 BATTERIE / CARICABATTERIE
- 123 ACCESSORI / MATERIALI DI CONSUMO



**USALI CON LE BATTERIE JBM:
UN'UNICA BATTERIA ADATTA A TUTTI GLI UTENSILI**

TRE TIPI DI BATTERIE E DUE TIPI DI CARICABATTERIE.
SCEGLI QUELLO CHE PREFERISCI!



60046C

339,00€



N

CHIAVE A IMPATTO BRUSHLESS SENZA FILI 1/2" 550NM CON CUSTODIA

CONTIENE

REF.	DESCRIZIONE					€
60013	BATTERIA AGLI IONI DI LITIO DA 4.0 AH	0.75	-	5	700	80,00€
60016	CARICABATTERIE 20V - 4A	0.80	-	5	210	49,00€
60046	PISTOLA AD IMPATTO BRUSHLESS A BATTERIA 1/2" 550NM	1.50	-	4	200	174,00€

Questo strumento è progettato per serrare e allentare dadi e bulloni che richiedono una coppia elevata. È dotato di una luce di lavoro a LED e di un selettore del senso di rotazione che consente anche di bloccare il grilletto ed evitare l'avviamento accidentale dell'utensile.

Dispone di 5 marce diverse, 3 per serrare e 2 per allentare, che consentono di regolare la velocità in base all'operazione da eseguire. Inoltre, grazie alla sua impugnatura ergonomica, si ottiene una migliore presa e precisione.

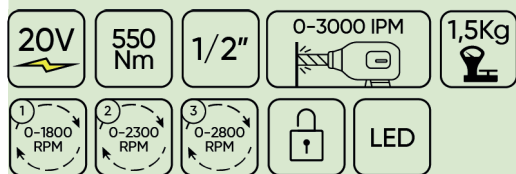

- MOTOR BRUSHLESS
- RETROILLUMINAZIONE A LED
- INTERRUTTORE DI DIREZIONE DI ROTAZIONE AVANTI/INDIETRO.
- MANIGLIA
- 5 DIVERSE MARCE
- GANCIO PER CINTURA

I COMPARTIMENTI NEI NOSTRI CASI SONO COMPATIBILI CON BATTERIE DA 4.0AH E 6.0AH.



60046

174,00€

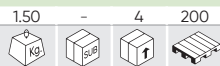

N

PISTOLA AD IMPATTO BRUSHLESS A BATTERIA 1/2" 550NM

BATTERIA NON INCLUSA.



RICAMBI DISPONIBILI

USALI CON LE BATTERIE JBM: UN'UNICA BATTERIA ADATTA A TUTTI GLI UTENSILI

TRE TIPI DI BATTERIE E DUE TIPI DI CARICABATTERIE.
SCEGLI QUELLO CHE PREFERISCI!

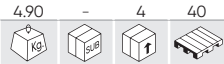
60044C
485,00€

CHIAVE A IMPATTO BRUSHLESS SENZA FILI 1/2" 1300NM CON CUSTODIA

CONTIENE

REF.	DESCRIZIONE					€
60013	BATTERIA AGLI IONI DI LITIO DA 4.0 AH	0.75	-	5	700	80,00€
60016	CARICABATTERIE 20V - 4A	0.80	-	5	210	49,00€
60044	AVVITATORE DA 1/2" 1300NM CON MOTORE BRUSHLESS	3.25	-	5	90	330,00€

Questo strumento è stato progettato per serrare e allentare viti e dadi che richiedono l'applicazione di una coppia elevata. È dotato di un motore brushless X-TorQ di ultima generazione che consente di svitare viti e dadi bloccati o fortemente serrati fino a 2 volte più velocemente. Robusto e resistente. Con un involucro in alluminio protetto con elastomero nella parte anteriore.

È dotato di una luce LED per il lavoro e di un selettore del senso di rotazione che consente anche di bloccare il grilletto per evitare l'avvio accidentale dell'utensile. Dispone di 5 marce diverse, 3 per serrare e 2 per allentare, consentendo di regolare la velocità in base all'operazione che si sta per eseguire. Il suo doppio martello dal nuovo design fornisce più colpi al minuto e meno vibrazioni.

Nuovo anello di fissaggio della presa: cambio più rapido delle prese e presa più sicura. Bilanciamento perfetto dell'utensile e peso per lavori che richiedono prese di grandi dimensioni e elevati livelli di coppia. Gancio di grandi dimensioni utile per appendere la macchina a strutture metalliche o alla cintura da lavoro. Inoltre, grazie alla impugnatura ergonomica, si ottiene una migliore presa e precisione.

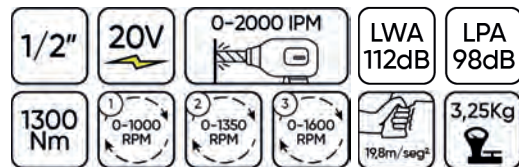
MOTOR BRUSHLESS
RETROILLUMINAZIONE A LED
INTERRUTTORE DI DIREZIONE DI ROTAZIONE AVANTI/INDIETRO.
MANIGLIA
5 DIVERSE MARCE
GANCIO PER CINTURA
I COMPARTIMENTI NEI NOSTRI CASI SONO COMPATIBILI CON BATTERIE DA 4.0AH E 6.0AH.

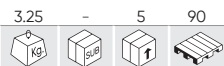
60044
330,00€

AVVITATORE DA 1/2" 1300NM CON MOTORE BRUSHLESS

BATTERIA NON INCLUSA.

60048C

560,00€

715	-	4	32

N

CHIAVE A IMPATTO 3/4" 1300NM BRUSHLESS A BATTERIA CON CUSTODIA

CONTIENE

REF.	DESCRIZIONE					€
60015	BATTERIA AGLI IONI DI LITIO DA 6.0 AH	1.00	-	20	630	138,00€
60016	CARICABATTERIE 20V - 4A	0.80	-	5	210	49,00€
60048	AVVITATORE DA 3/4" 1300NM CON MOTORE BRUSHLESS	3.26	-	4	64	366,00€

Questo strumento è stato progettato per stringere e allentare viti e dadi che richiedono una coppia di serraggio elevata. È dotato di un faro da lavoro a LED e di un selettore del senso di rotazione che permette anche di bloccare il grilletto per evitare avviamenti accidentali dell'utensile.

Dispone di 5 marce diverse, 3 per stringere e 2 per allentare, consentendo di regolare la velocità in base all'operazione da effettuare. Inoltre, grazie alla sua impugnatura ergonomica, si ottengono maggiore presa e precisione.

- MOTOR BRUSHLESS
- RETROILLUMINAZIONE A LED
- INTERRUTTORE DI DIREZIONE DI ROTAZIONE AVANTI/INDIETRO.
- MANIGLIA
- 5 DIVERSE MARCE
- GANCIO PER CINTURA

I COMPARTIMENTI NEI NOSTRI CASI SONO COMPATIBILI CON BATTERIE DA 4.0AH E 6.0AH.



60048

366,00€

3.26	-	4	64

N

AVVITATORE DA 3/4" 1300NM CON MOTORE BRUSHLESS

BATTERIA NON INCLUSA.



RICAMBI DISPONIBILI

60005

132,00€

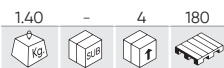

AVVITATORE BRUSHLESS

BATTERIA NON INCLUSA.

Questo attrezzo è progettato per il serraggio rapido di viti e dadi ed è particolarmente utile quando si lavora con elementi di fissaggio lunghi e materiali duri. Avvitatore è dotata di illuminazione a LED dell'area di lavoro per un funzionamento più confortevole e preciso, mandrino esagonale a cambio rapido da 1/4" di pollice per una rapida installazione e rimozione dell'ugello, nonché del grilletto con una funzione di blocco per impedire l'avvio accidentale dell'utensile.

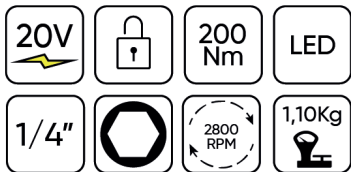

- A MOTOR BRUSHLESS
- B RETROILLUMINAZIONE A LED
- C INTERRUTTORE DI DIREZIONE DI ROTAZIONE AVANTI/INDIETRO.
- D MANIGLIA
- E 5 DIVERSE MARCE
- F GANCIO PER CINTURA
- G BATTERIA NON INCLUSA



ACCESSORI E RICAMBI

PAGINA 126

60024

190,00€



CRICCHETTO ELETTRICO BRUSHLESS 1/2" - 12V

BATTERIA NON INCLUSA.

Questo utensile è progettato per serrare/svitare il materiale di fissaggio in punti difficili da raggiungere.

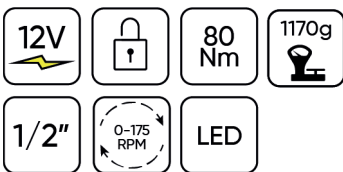

- A CHIAVE QUADRATA DA 1/2 "
- B CAMBIO DI DIREZIONE: AVANTI / INDIETRO
- C FARO DA LAVORO A LED INTEGRATO
- D INDICATORE DEL LIVELLO DELLA BATTERIA
- E INTERRUTTORE DI BLOCCO
- F VELOCITÀ VARIABILE
- G PROTEZIONE DA SOVRACCARICO

CONTIENE

REF.	DESCRIZIONE					€
60025	CARICABATTERIE 12 V - PER RIF. 60026	0.30	5	4	700	31,60€
60026	BATTERIA LITIO-IONE 2.0 A*H SAMSUNG - PER RIF. 60024	0.20	5	40	1400	37,90€



60023

212,00€



MARTELLINO PERFORATORE CON MOTORE BRUSHLESS

BATTERIA NON INCLUSA.

Questo utensile è progettato per la foratura a percussione e lo scasso di calcestruzzo e mattoni, così come per la foratura convenzionale di altri materiali come acciaio, legno, metallo, ceramica e plastica.



- A MOTOR BRUSHLESS
- B MISURATORE DI PROFONDITÀ
- C COPERCHIO ANTIPOLVERE
- D MANDRINO A SERRAGGIO RAPIDO PER L'UTENSILE CON GAMBO SDS
- E INTERRUOTTORE DELLA MODALITÀ OPERATIVA
- F INTERRUOTTORE DEL SENSO DI ROTAZIONE
- G MANIGLIA
- H RETROILLUMINAZIONE A LED
- I BATTERIA NON INCLUSA



- CONTIENE**
- 1 PZ. COPERCHIO ANTIPOLVERE
 - 1 PZ. MISURATORE DI PROFONDITÀ
 - 1 PZ. MANIGLIA AGGIUNTIVA
 - 1 PZ. SCALPELLO A PUNTA
 - 1 PZ. SCALPELLO PIATTO
 - TRAPANI SDS: Ø8/10/12X150MM



ACCESSORI E RICAMBI

PAGINA 123

60006

182,00€



TRAPANO A IMPULSI A DUE VELOCITÀ CON MOTORE BRUSHLESS

BATTERIA NON INCLUSA.

Questo strumento è progettato per forare legno e metallo, operazioni a percussione principalmente in muratura, calcestruzzo, pietra e mattoni rossi, nonché per serrare/allentare e svitare viti e dadi.



- A MOTOR BRUSHLESS
- B RETROILLUMINAZIONE A LED
- C INTERRUOTTORE DI DIREZIONE DI ROTAZIONE AVANTI/INDIETRO.
- D MANIGLIA
- E GANCIO PER CINTURA
- F BATTERIA NON INCLUSA



Maniglia aggiuntiva



ACCESSORI E RICAMBI

PAGINA 124

60047C

318,00€



N

TRAPANO A BATTERIA A 2 VELOCITÀ CON CUSTODIA

CONTIENE

REF.	DESCRIZIONE					€
60013	BATTERIA AGLI IONI DI LITIO DA 4.0 AH	0.75	-	5	700	80,00€
60016	CARICABATTERIE 20V - 4A	0.80	-	5	210	49,00€

Questo strumento è stato progettato per praticare fori su diversi tipi di materiali. Può eseguire operazioni di foratura su legno e metallo e operazioni di foratura a percussione, più comuni nella muratura, su cemento, pietra e mattoni rossi. Inoltre, può stringere, allentare o rimuovere dadi e viti. A tal fine, dispone di un anello di regolazione che consente di scegliere tra 20 diverse impostazioni di coppia.

È dotato di un selettore di velocità e di un selettore avanti/indietro per impostare il senso di rotazione a sinistra o a destra. Questo selettore, se posizionato al centro, blocca l'interruttore del grilletto per evitare un avvio accidentale dell'utensile.

È dotato di una luce a LED per una migliore visualizzazione dell'area di lavoro. Come accessori ha un gancio per la cintura e un'impugnatura ausiliaria per una migliore presa.

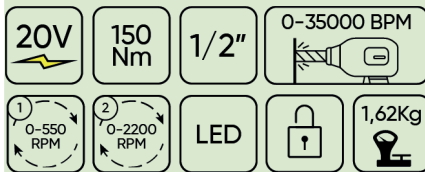

MOTOR BRUSHLESS

RETROILLUMINAZIONE A LED

INTERRUTTORE DI DIREZIONE DI ROTAZIONE AVANTI/INDIETRO.

MANIGLIA

5 DIVERSE MARCE

GANCIO PER CINTURA

MANIGLIA AGGIUNTIVA

I COMPARTIMENTI NEI NOSTRI CASI SONO COMPATIBILI CON BATTERIE DA 4.0AH E 6.0AH.

RICAMBI
DISPONIBILIACCESSORI
E RICAMBI

PAGINA 124



60009

168,00€



LUCIDATRICE CON MOTORE BRUSHLESS

BATTERIA NON INCLUSA.

L'utensile è destinato a processi di lavorazione di finitura, come la lucidatura e l'arrotondamento degli angoli e spigoli, nonché all'ottenimento di superfici lisce con il disco e tampone di lucidatura.



- A MOTOR BRUSHLESS
- B L'INTERRUTTORE DI VELOCITÀ A 9 GRADINI:
800, 1000, 1200, 1400, 1600, 1800, 2000, 2200, 2400 GIRI/MIN
- C INTERRUTTORE DI SICUREZZA
- D MANIGLIA MORBIDA
- E MANIGLIA A FORMA DI D AGGIUNTIVA
- F PULSANTE BLOCCO MANDRINO
- G TAMPONE DI LUCIDATURA
- H BATTERIA NON INCLUSA



CHIAVE ESAGONALE



RICAMBI DISPONIBILI



60033

104,00€



LEVIGATRICE BRUSHLESS

BATTERIA NON INCLUSA.

Questo strumento è progettato per levigare prodotti di legno, di ferro, di plastica e materiali simili con carta vetrata adatta.

Questa levigatrice è progettata con tre velocità, una comoda impugnatura e un sacchetto raccogli-polvere incorporato.



- A MOTOR BRUSHLESS
- B INTERRUTTORE ON PULSANTE DI REGOLAZIONE DELLA VELOCITÀ
- C INTERRUTTORE OFF
- D COLLETTORE DI POLVERE
- E BASE
- F BATTERIA NON INCLUSA



RICAMBI DISPONIBILI

60049C

329,00€



N

SMERIGLIATRICE ANGOLARE CON MOTORE BRUSHLESS 125MM CON CUSTODIA

CONTIENE

REF.	DESCRIZIONE					€
60013	BATTERIA AGLI IONI DI LITIO DA 4.0 AH	0.75	-	5	700	80,00€
60016	CARICABATTERIE 20V - 4A	0.80	-	5	210	49,00€

BATTERIA NON INCLUSA.

La smerigliatrice angolare a batteria è progettata per eseguire tutti i tipi di taglio, lucidatura e levigatura. Comprende un'impugnatura frontale e un coperchio di protezione.



GUAINA DELLA MOLA

MANIGLIA AGGIUNTIVA

BATTERIA NON INCLUSA

I COMPARTIMENTI NEI NOSTRI CASI SONO COMPATIBILI CON BATTERIE DA 4.0AH E 6.0AH.

RICAMBI
DISPONIBILIACCESSORI
E RICAMBI

PAGINA 127



60028

142,00€

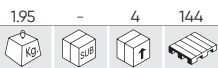

SMERIGLIATRICE ANGOLARE CON MOTORE BRUSHLESS - 125MM

BATTERIA NON INCLUSA.

La smerigliatrice angolare a batteria è progettata per eseguire tutti i tipi di taglio, lucidatura e levigatura. Comprende un'impugnatura frontale e un coperchio di protezione.

RICAMBI
DISPONIBILIACCESSORI
E RICAMBI

PAGINA 127



CHIAVE

60019

178,00€

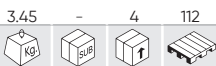

SEGA A SCIABOLA CON MOTORE BRUSHLESS

BATTERIA NON INCLUSA.

Questo strumento è progettato per il taglio di una varietà di materiali e ha una vasta gamma di applicazioni. Il design prevede una sostituzione rapida e comoda della lama della sega grazie al supporto a serraggio rapido dispone di una velocità di taglio regolabile a seconda dell'operazione da eseguire.



- A MOTOR BRUSHLESS
- B LAMA DA SEGA
- C PUNTAZZA
- D SUPPORTO A SERRAGGIO RAPIDO
- E PULSANTE DI BLOCCO DEL PULSANTE DI AVVIO (START)
- F MANIGLIA MORBIDA
- G BATTERIA NON INCLUSA



**ACCESSORI
E RICAMBI**

PAGINA 128

CONTIENE
1 PZ. TELA PER LEGNO
1 PZ. TELA PER METALLO

60020

175,00€



PIALLATRICE BRUSHLESS

BATTERIA NON INCLUSA.

Questo utensile è progettato per lavorare il legno. Consente di ottenere una superficie di legno liscia e, se necessario, fare la forma di cono

La pialla è dotata di una base in lega d'alluminio per un posizionamento preciso, del sistema di raccolta della polvere per catturare la polvere dalla lavorazione del legno e del pulsante di blocco del grilletto per impedire l'avvio accidentale dell'utensile.

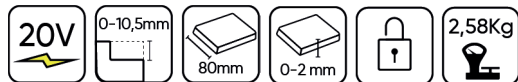

- A MOTOR BRUSHLESS
- B PULSANTE DI BLOCCAGGIO
- C MANOPOLA DI REGOLAZIONE PER LA PROFONDITÀ DI TAGLIO
- D GUIDA AL TAGLIO PARALLELO
- E GUIDA DELLA PROFONDITÀ D'INCASTRO
- F MANOPOLA DI REGOLAZIONE DELLA GUIDA D'INCASTRO
- G PORTA PER LA RIMOZIONE DELLA POLVERE
- H SCANALATURA A V
- I BATTERIA NON INCLUSA



CONTIENE
1 PZ. MANOPOLA DI REGOLAZIONE DELLA PROFONDITÀ DELLA SCANALATURA.
1 PZ. GUIDA PARALLELA.
3 PZ. MANOPOLE DI REGOLAZIONE.
1 PZ. CHIAVE.
1 PZ. VITE.

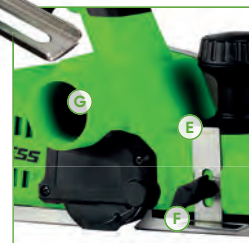

60010

170,00€

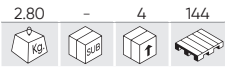

SEGA A SCIABOLA CON MOTORE BRUSHLESS

BATTERIA NON INCLUSA.

Questo utensile è progettato per il taglio di materiali come legno, acciaio, plastica e metallo. Il seghetto è dotato di un meccanismo a pendolo a 4 posizioni: 3 posizioni per il taglio orbitale e 1 posizione per il taglio diretto, che permette di selezionare la velocità di taglio ottimale per la durezza del materiale.

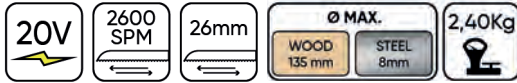

- A MOTOR BRUSHLESS
- B COPERCHIO DI PROTEZIONE DELLA LAMA DA SEGA
- C PORTAUTENSILE A FISSAGGIO RAPIDO
- D LAMA DA SEGA
- E REGOLATORE DI CORSA A PENDOLO
- F LEVA DI REGOLAZIONE DELLA PUNTAZZA
- G PULSANTE DI BLOCCO DEL PULSANTE START
- H BATTERIA NON INCLUSA



RICAMBI DISPONIBILI

ACCESSORI E RICAMBI

PAGINA 128



CONTIENE

- 1 PZ. DISCO DI LEGNO
- 1 PZ. GUIDA DEL BORDO
- 1 PZ. TUBO PER LA POLVERE

60007

170,00€

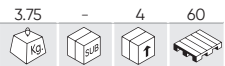

SEGA CIRCOLARE CON MOTORE BRUSHLESS

BATTERIA NON INCLUSA.

Questo utensile è progettato per segare il legno. La sega circolare di 165 mm di diametro con 24 denti è ideale per tagli diritti longitudinali e trasversali e per segare con un angolo fino a 45° su tavole e pannelli di legno.



- A MOTOR BRUSHLESS
- B LEVA DELLA GUAINA DI PROTEZIONE INFERIORE
- C PUNTAZZA
- D GUAINA DI PROTEZIONE INFERIORE
- E MANIGLIA DI BLOCCO DELL'ANGOLO DI TAGLIO
- F MANIGLIA ANTERIORE
- G PULSANTE DI BLOCCO GRILLETTO
- H BATTERIA NON INCLUSA



RICAMBI DISPONIBILI

ACCESSORI E RICAMBI

PAGINA 128



CONTIENE

- 1 PZ. DISCO TCT 24T DA 165 MM
- 1 PZ. GUIDA DEL BORDO
- 1 PZ. CHIAVE ESAGONALE

60011

175,00€

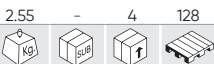

MINI SEGA CIRCOLARE CON MOTORE BRUSHLESS LATO POSTERIORE

BATTERIA NON INCLUSA.

Questo utensile è progettato per segare il legno. La sega circolare di 115 mm di diametro con 24 denti è ideale per tagli dritti longitudinali e trasversali e per segare con un angolo fino a 45° su tavole e pannelli di legno. La sega ha anche un pulsante di blocco del grilletto per impedire l'avvio accidentale dell'utensile e un involucro in alluminio.



- A MOTOR BRUSHLESS
- B GUAINA DI PROTEZIONE INFERIORE DEL DISCO DA TAGLIO
- C LEVA DELLA GUAINA DI PROTEZIONE INFERIORE
- D PIASTRA D'APPOGGIO
- E GUAINA DI PROTEZIONE SUPERIORE DEL DISCO DA TAGLIO
- F GUIDA PER I TAGLI
- G PULSANTE DI BLOCCO
- H BATTERIA NON INCLUSA



- CONTIENE**
- 1 PZ. DISCO TCT 24T DA 115MM
 - 1 PZ. GUIDA DEL BORDO.
 - 1 PZ. TUBO PER LA POLVERE
 - 1 PZ. CHIAVE ESAGONALE



ACCESSORI E RICAMBI

PAGINA 128

RICAMBI DISPONIBILI

60022

470,00€

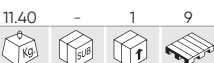

TRONCATRICE CON MOTORE BRUSHLESS

BATTERIA NON INCLUSA.

Questo utensile è progettato per segare legno e materiali simili. L'utensile consente di eseguire tagli obliqui quando è richiesto un taglio inclinato lungo la superficie del pezzo, tagli ad angolo, generalmente utilizzati per giunti che formano un angolo di 90°, nonché tagli combinati quando è necessario un taglio angolare contemporaneamente sia lungo il bordo che sulla superficie anteriore del pezzo.

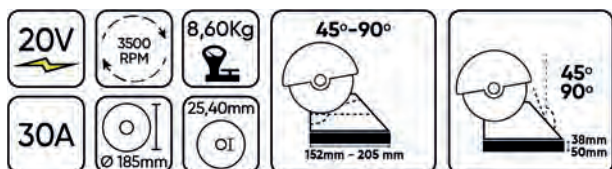

- CONTIENE**
- 1 PZ. SEGA CIRCOLARE A 40 DENTI
 - 1 PZ. MORSETTO
 - 1 PZ. CHIAVE PER IL DISCO DA TAGLIO
 - 1 PZ. SACCHETTO PER LA POLVERE



ACCESSORI E RICAMBI

PAGINA 128

RICAMBI DISPONIBILI



60032

123,00€

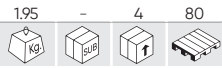

SIRINGA A BATTERIA PER SIGILLARE

BATTERIA NON INCLUSA.

Questo strumento è progettato per riempire eventuali fessure o crepe in un'ampia varietà dei materiali come metallo, vetro, legno e ceramica.



- A PORTACARTUCCIA
- B PISTONE
- C ASTA DEL PISTONE
- D IMPUGNATURA DELL'ASTA DEL PISTONE
- E GRILLETTO MOVIMENTO DELL'ASTA DEL PISTONE
- F REGOLATORE DI VELOCITÀ
- G FARO A LED
- H BATTERIA NON INCLUSA

RICAMBI
DISPONIBILI

60038

255,00€

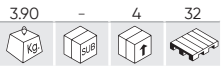

PISTOLA ELETTRICA A SIRINGA

BATTERIA NON INCLUSA.

Questo strumento è un ingrassatore per l'erogazione di grasso. Grazie all'alimentazione a batteria, l'utensile è facile da usare e da trasportare.



- A RUOTA DI REGOLAZIONE DELLA PORTATA DEL GRASSO
- B PULSANTE DI BLOCCO
- C LED DI ILLUMINAZIONE
- D TUBO FLESSIBILE
- E TUBO DI LUBRIFICAZIONE
- F VALVOLA DI SFIATO DI SICUREZZA
- G BATTERIA NON INCLUSA

RICAMBI
DISPONIBILI

60041

77,00€



STRUMENTO MULTIFUNZIONE DI OSCILLAZIONE A BATTERIA

BATTERIA NON INCLUSA.

Insieme all'utensile oscillante multifunzionale è possibile utilizzare vari attacchi per eseguire una varietà dei compiti. L'utensile è particolarmente utile per la ripulitura, la rettificazione e segatura in profondità in aree difficili da raggiungere.

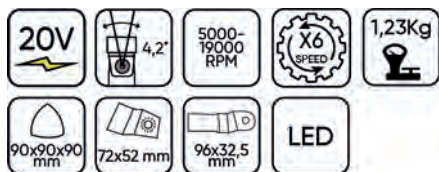

- A MOTOR BRUSHLESS
- B BRACCIO DI PRESA
- C STAFFA DI FISSAGGIO
- D VOLANTINO DI SELEZIONE DELLA VELOCITÀ
- E LAMPADA DA LAVORO
- F PORTAUTENSILI
- G BATTERIA NON INCLUSA



CONTIENE

- 1 PZ. LAMA PER SEGA
- 1 PZ. FOGLIO ABRASIVO
- 1 PZ. PIASTRA DI LEVIGATURA
- 1 PZ. RASCHIETTO
- 1 PZ. RONDELLA
- 1 PZ. MANIGLIA

60037

222,00€

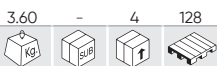

CHIODATRICE/PINZATRICE BATTERIA

BATTERIA NON INCLUSA.

Lo strumento è progettato per fissare cartone, materiali isolanti, tessuto, foglie, pelle e materiali simili al legno o ad altre superfici simili martellandoli ad alta potenza utilizzando aria compressa.



- A RETROILLUMINAZIONE A LED
- B PERNO DI SICUREZZA
- C CARICATORE
- D LED
- E POMELLO DEL CAMBIO
- F INTERRUTTORE LUCE LED
- G BATTERIA NON INCLUSA



ACCESSORI E RICAMBI

PAGINA 127

GRAFFETTE DI TIPO LEGGERO CON PARTE SUPERIORE STRETTA MISURA 18

LUNGHEZZA GRAFFETTE MASSIMA	40 mm
LARGHEZZA MASSIMA DELLA SEZIONE TRASVERSALE DEL PUNTO METALLICO	1.2 mm
SPESSORE MASSIMO DELLA SEZIONE TRASVERSALE DEL PUNTO METALLICO	1 mm
DIMENSIONE SUPERIORE DELLA GRAFFETTA MASSIMA	6 mm

CHIODI SENZA CAPPuccio MISURA 18

LUNGHEZZA DEI CHIODI MASSIMA	50 mm
LARGHEZZA DELLA SEZIONE TRASVERSALE DEL CHIODO MASSIMA	1.25 mm
SPESSORE MASSIMO DELLA SEZIONE DEL CHIODO	1.05 mm

60042

106,00€



PISTOLA A BATTERIA DA ARIA CALDA PER COSTRUZIONE

BATTERIA NON INCLUSA.

Questo strumento è progettato per riempire eventuali fessure o crepe in un'ampia varietà dei materiali come metallo, vetro, legno e ceramica.

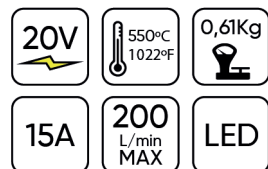

- A COPERCHIO ANTERIORE
- B UGELLO
- C RETROILLUMINAZIONE A LED
- D INTERBLOCCO DELL'INTERRUTTORE DI ALIMENTAZIONE
- E GANCIO DI METALLO
- F BATTERIA NON INCLUSA



RICAMBI DISPONIBILI

60043

123,00€



SPRUZZATORE DELLA VERNICE A BATTERIA

BATTERIA NON INCLUSA.

Questo strumento è progettato per spruzzare vernice su superfici all'interno e all'esterno.



- A REGOLATORE DELLA PORTATA
- B SERBATOIO
- C BLOCCO DEL SERBATOIO
- D FILTRO DELL'ARIA
- E BATTERIA NON INCLUSA



RICAMBI DISPONIBILI

USALI CON LE BATTERIE JBM: UN'UNICA BATTERIA ADATTA A TUTTI GLI UTENSILI

TRE TIPI DI BATTERIE E DUE TIPI DI CARICABATTERIE.
SCEGLI QUELLO CHE PREFERISCI!

**Batterie e caricabatterie NON INCLUSI negli utensili.*



60001

88,00€

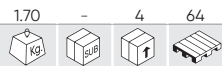

ASPIRAPOLVERE PORTATILE

BATTERIA NON INCLUSA.

Questo è un aspirapolvere elettrico a batteria, è stato progettato per la pulizia dei materiali sicuri per la salute.



- A COLLETTORE DI POLVERE
- B PULSANTE D'ESTRAZIONE DEL COLLETTORE DI POLVERE
- C INTERRUTTORE PRINCIPALE
- D CORPO DEL MOTORE
- E BOCCHETTA PER FESSURE
- F BOCCHETTA-SPAZZOLA
- G BOCCHETTA PER PAVIMENTO
- H TUBO DI PROLUNGA
- I BATTERIA NON INCLUSA



CONTIENE

REF.	DESCRIZIONE	1.70 Kg	4	64	€
14950	TUBO DI PROLUNGA PER RIF. 60001	0.08	5	10	6,50€
14951	UGELLO A FESSURA PER RIF. 60001	0.01	-	10	9,50€
14952	UGELLO DA PAVIMENTO PER RIF. 60001	0.15	-	5	19,00€
14953	SPAZZOLA PER RIF. 60001	0.05	-	10	8,50€

60003

110,00€



POMPA GONFIAGOMME ELETTRICA

BATTERIA NON INCLUSA.

Questa pompa consente di gonfiare ruote, palloni, gommoni, materassi gonfiabili per auto e moto, ecc.

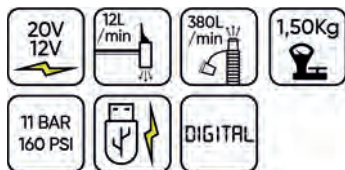

- A LUCE A LED
- B PULSANTE DI ACCENSIONE LUCE A LED
- C INTERRUTTORE DELLA MODALITÀ DI LAVORO
- D PULSANTI DI SELEZIONE DELLA PRESSIONE
- E CONNETTORE USB
- F TUBO FLESSIBILE AD ALTA PRESSIONE
- G TUBO FLESSIBILE AD ALTA CAPACITÀ
- H ACCESSORI PER TUBO FLESSIBILE AD ALTA PRESSIONE
- I BATTERIA NON INCLUSA



CONTIENE



60004

79,00€

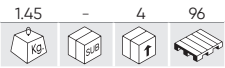

LAMPADA DA LAVORO A LED

BATTERIA NON INCLUSA.

Questa luce da lavoro a LED è stata progettata per fornire l'illuminazione necessaria nell'area di lavoro e in altri luoghi. Quando la batteria è scarica, la luce può essere collegata a una rete con una tensione di 230 V utilizzando un cavo di rete situato sul retro del dispositivo.

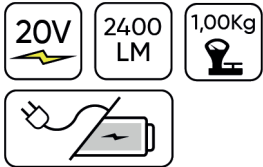

- A INTERRUTTORE (ON/OFF)
- B LA TESTA ROTANTE DELLA LAMPADA DA LAVORO
- C MATRICE LED
- D BLOCCO POSIZIONE LATERALE
- E CAVO DI RETE
- F BATTERIA NON INCLUSA



RICAMBI DISPONIBILI

REF.	DESCRIZIONE					€
15049	TREPPIEDE PER LAMPADA DA LAVORO A LED (RIF. 60004)	2,10	-	4	120	37,40€

60035

30,00€



TORCIA DA LAVORO PORTATILE A LED

BATTERIA NON INCLUSA.

Questa lampada da lavoro a LED è stata progettata per fornire l'illuminazione necessaria nell'area di lavoro e in altri luoghi. È alimentato da una batteria portatile agli ioni di litio, che lo rende portatile e ideale per qualsiasi posto di lavoro o situazione in cui l'accesso alla rete di alimentazione è limitato.

Il diffusore della lampada a LED fornisce un flusso luminoso di 500 e 1000 lumen, e il meccanismo girevole della lampada (90°) permette di regolare l'angolo desiderato. Nel kit sono inclusi: la maniglia morbida per la gestione più confortevole e il gancio di sospensione per agganciare ad un altro oggetto.

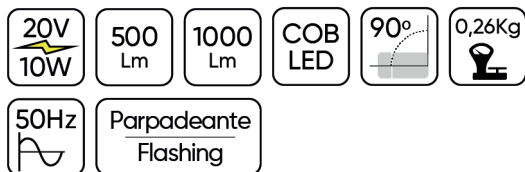

- A DIFFUSORE
- B MECCANISMO GIREVOLE
- C GANCIO DI SOSPENSIONE
- D INTERRUTTORE ON/OFF
- E BATTERIA NON INCLUSA



RICAMBI DISPONIBILI



60039

265,00€

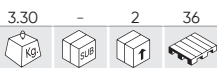

IDROPULITRICE A BATTERIA

BATTERIA NON INCLUSA.

L'idropulitrice ad alta pressione con motore senza spazzole progettata per la pulizia di veicoli, attrezzature, utensili, mobili da giardino, ecc.



- A MOTOR BRUSHLESS
- B UGELLO GIREVOLE A 5 POSIZIONI
- C INNESTO RAPIDO DELL'UGELLO
- D TUBO
- E INDICATORE DI PRESSIONE
- F SELETTORE DI PRESSIONE
- G INTERRUTTORE DI BLOCCO
- H INNESTO RAPIDO DEL TUBO FLESSIBILE
- I BATTERIA NON INCLUSA



RICAMBI DISPONIBILI



60027

99,00€

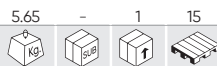

SPRUZZATORE ELETTRICO INDUSTRIALE DORSALE CON SERBATOIO 15 L

BATTERIA NON INCLUSA.

Lo strumento è adatto per la disinfezione di case private, luoghi pubblici, allevamenti, giardini, ecc. e permette di distruggere tutte le particelle pericolose, impedire la loro diffusione e allo stesso tempo impedisce la riproduzione degli insetti e lo sviluppo di malattie.

Maniglia intelligente che prevede il blocco per il funzionamento continuo. In dotazione ci sono 4 ugelli con un flusso e prestazioni specifici a seconda delle esigenze: 1 ugello conico cavo, 1 ugello conico doppio cavo, 1 ugello regolabile con 4 fori, 1 ugello a ventaglio.



- A MANIGLIA PER UN FACILE TRASPORTO
- B CUSCINO PER LA SCHIENA TRASPIRANTE ED ERGONOMICO
- C COPERCHIO CON BLOCCAGGIO A PROVA DI FUGA
- D MONTANTE TELESCOPICO PER SPRUZZARE
- E BATTERIA NON INCLUSA

NON ACCETTA BATTERIE DA 6.0AH

CONTIENE



60029

240,00€

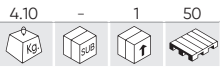

MOTOSEGA ELETTRICA

BATTERIA NON INCLUSA.

Questo strumento per l'ammasso del legname è progettato per attività come abbattimento, roncatura, segatura e taglio degli alberi.

L'attrezzo è dotato di una maniglia per regolare la tensione della barra di guida e della catena, un freno a catena per fermare la catena durante il contraccolpo e un cattura catena per prenderla se si rompe o si stacca. Inoltre, il dispositivo è dotato di un sistema automatico di lubrificazione della catena e di un pulsante di blocco del grilletto per evitare l'avvio accidentale. L'utensile consiste di una barra di guida, una catena e una custodia per proteggere sia la barra che la catena durante il trasporto e lo stoccaggio.



- A MOTOR BRUSHLESS
- B CATENA DELLA SEGA
- C BARRA DI GUIDA
- D FRENO A CATENA/COPERTURA PROTETTIVA ANTERIORE
- E MANIGLIA ANTERIORE
- F PULSANTE DI BLOCCO
- G COPERCHIO DEL SERBATOIO DELL'OLIO
- H BATTERIA NON INCLUSA



CONTIENE



RICAMBI DISPONIBILI

60030

112,00€

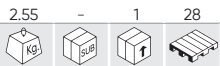

SOFFIATORE A BATTERIA

BATTERIA NON INCLUSA.

Questo strumento è progettato per la pulizia di foglie, erba, carta e materiali simili. Alimentazione dalla batteria e la struttura leggera facilitano il trasporto dell'utensile da un luogo all'altro. Il design prevede l'interruttore del flusso d'aria alto/basso e del volume, nonché la maniglia morbida per un comodo lavoro.



- A MOTOR BRUSHLESS
- B TUBO
- C UGELLO DEL TUBO DELLA SOFFIATRICE
- D CUSTODIA
- E BATTERIA NON INCLUSA

NON ACCETTA BATTERIE DA 6.0AH



RICAMBI DISPONIBILI

60031

142,00€



TAGLIASIEPI A BATTERIA

BATTERIA NON INCLUSA.

Questo strumento è destinato per lavori di giardinaggio veloci e comodi come la potatura, il taglio o la potagione di siepi o cespugli. Alimentazione dalla batteria e la struttura leggera facilitano il trasporto dell'utensile da un luogo all'altro. Il dispositivo contiene un cappuccino di protezione della lama che mantiene la tagliasiepi in condizioni adeguate, una copertura protettiva che aiuta a rimuovere le roncature o altri residui fuori dalle mani e dagli occhi dell'operatore, e un'impugnatura aggiuntiva per un miglior controllo e condizioni di lavoro più confortevoli. Inoltre, il design prevede due interruttori e un pulsante di blocco per evitare l'avvio accidentale dell'utensile.



- A MOTOR BRUSHLESS
- B LAMA DI TAGLIO
- C PORTALAMA
- D COPERTURA
- E IMPUGNATURA AGGIUNTIVA
- F INTERRUTTORE SUPPLEMENTARE
- G PULSANTE DI BLOCCO
- H IMPUGNATURA POSTERIORE
- I BATTERIA NON INCLUSA

CONTIENE
CAPPUCCINO DI PROTEZIONE



60040

440,00€



MACCHINA DA GIARDINO BATTERIA MULTIFUNZIONALE (4 IN 1)

BATTERIA NON INCLUSA.

L'attrezzo da giardino elettrico multiuso (4 in 1) è progettato per una varietà di compiti all'aperto come la pulizia degli spazi verdi, la potatura delle siepi, la roncatura dei rami, ecc. L'attrezzo è ideale per l'assistenza completa del giardino.

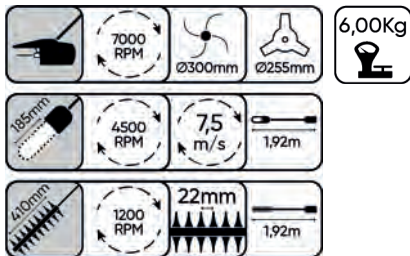

- A MOTOR BRUSHLESS
- B GUAINA DI PROTEZIONE
- C LAMA A TRE DENTI
- D LAMA
- E SEGA
- F MANIGLIE
- G SFOLTIRAMI
- H TESTINA FOLCIANTE
- I TAGLIASIEPI
- J SEGA AD ASTA
- K BATTERIA NON INCLUSA



52598

1.080,00€

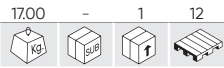

ROBOT TOSAERBA

Robot tosaerba moderno e funzionale, perfetto per la cura e la manutenzione del tuo prato e degli spazi verdi. È dotato di un motore brushless, alimentato da una potente batteria da 5200 Ah, per un'autonomia di circa 150 minuti. Il piatto di taglio dispone di tre lame in acciaio che eseguiranno un taglio mulching. Questo sistema di taglio, tritura il prato in modo molto fine, per poi rilasciarlo direttamente sul terreno, dando al prato un aspetto impeccabile senza procedere alla rimozione dei detriti. Inoltre, con questo tipo di tosatura, l'erba depositata sul prato si decomporrà e diventerà nutriente per il terreno, creando un ciclo biologico completamente naturale. Il cavo perimetrale e i pali in dotazione consentono un'installazione semplice e senza attrezzi.

5200 mAh Capacità della batteria battery capacity	1400m ² Superficie di corte mowing area	IP X4	DC 15-25.5V tensione di alimentazione battery voltage	2,5h	22m/min
115,44W consumo di energia power consumption	AC 100-240V 50/60Hz tensione di rete mains voltage	7,5Kg	2h	70 dB(A)	50-35,5-24 cm



CONNESSIONE
ALL'APP



RICAMBI
DISPONIBILI

- A MOTOR BRUSHLESS
- B PULSANTE STOP
- C STAZIONE DI RICARICA
- D RUOTA POSTERIORE
- E COPERCHIO DELLA MANIGLIA

60045

298,00€

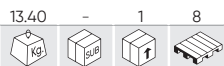

TOSAERBA A BATTERIA

BATTERIA NON INCLUSA.

Questo tosaerba senza fili vi aiuta a mantenere il vostro giardino in perfette condizioni. È dotato di un motore con avviatore incorporato che aumenta l'efficacia e riduce il livello di rumore. È anche molto leggero e facile da usare.

40V	800W	35L	11,6 Kg.
3.300 RPM	6x 25-75mm	152 - 203mm Ø	370mm Ø
96 dB(A)	IP X1	4.0A	11,40Kg



- A MOTOR BRUSHLESS
- B TOSAERBA
- C MANIGLIA
- D SACCO RACCOGLIERBA

FUNZIONA CON 2 BATTERIE 4AH (NON INCLUSE)



RICAMBI
DISPONIBILI

**USALI CON LE BATTERIE JBM:
UN'UNICA BATTERIA ADATTA
A TUTTI GLI UTENSILI**

TRE TIPI DI BATTERIE E DUE TIPI DI CARICABATTERIE.
SCEGLI QUELLO CHE PREFERISCI!

**Batterie e caricabatterie NON INCLUSI negli utensili.*



BATTERIA AGLI IONI DI LITIO

INDICATORE DI ALIMENTAZIONE

PROTEZIONE DA CORTO CIRCUITO

PROTEZIONE CONTRO IL SURRISCALDAMENTO

PROTEZIONE DA SOVRACCARICO

60012	60013	60015	60026
0.45 - 5 920	0.75 - 5 700	1.00 - 20 630	0.20 5 40 1400
48,00€	80,00€	138,00€	379,0€
20V 2.0Ah 0,41Kg	20V 4.0Ah 0,69Kg	20V 6.0Ah 0,95Kg	12V 2.0Ah 0,18Kg

CARICABATTERIE

100V / 240V

50-60 Hz

INDICATORE DI ALIMENTAZIONE

PROTEZIONE DA CORTO CIRCUITO

PROTEZIONE CONTRO IL SURRISCALDAMENTO

PROTEZIONE DA SOVRACCARICO

60016	60017	60025
0.80 - 5 210	0.80 - 5 290	0.30 5 4 700
49,00€	64,00€	31,60€
20V 4A 0,57Kg	20V 6A 0,69Kg	12V 0,27Kg
2.0AH 30min +/-10min 4.0AH 60min +/-15min 6.0AH 90min +/-15min	2.0AH 30min +/-10min 4.0AH 45min +/-10min 6.0AH 60min +/-15min	2.0AH 60min +/-10min

ACCESSORI



REF.	DESCRIZIONE	mm						€
14622	MENSOLA SUPPORTO PER REF. 60001, 60003, 60004, 60020	320x180	A	0.95	-	10	360	17,00€
14623	GANCIO PER REF. 60005, 60006, 60018	70x84	B	0.10	-	10	800	8,00€
14624	MENSOLA SUPPORTO PER REF. 60007, 60010, 60011	290x160	C	0.65	-	10	300	17,00€
14625	MENSOLA SUPPORTO REF. 60008, 60009	40x200x100	D	0.50	-	10	700	14,00€
14626	GANCIO PER REF. 60023	115x70	E	0.10	-	10	-	7,00€
16364	GANCIO DRITTO PER ESPOSITORE ATTREZZATURA 280MM	280		0.20	-	200	-	3,50€

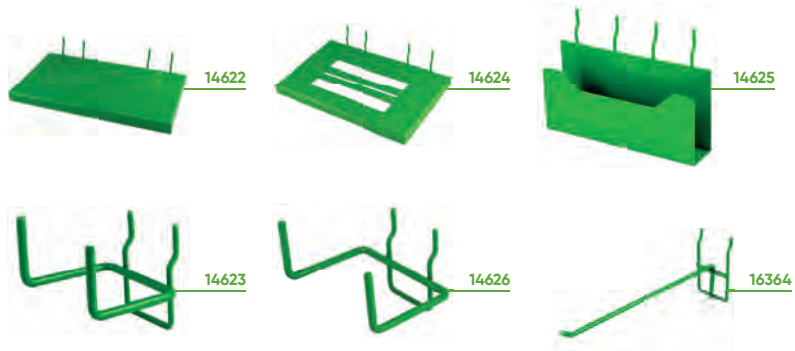

RICAMBI



SCALPELLO SDS-PLUS

REF.	DESCRIZIONE				€
14837	SCALPELLO CON PUNTA AFFILATA SDS-PLUS 14X250MM	0.25	10	100	3,30€
14838	SCALPELLO CON PUNTA PIATTA SDS-PLUS 20X250MM	0.25	10	100	3,40€
14839	SCALPELLO CON PUNTA PIATTA SDS-PLUS 40X250MM	0.29	10	50	4,70€
14840	SCALPELLO DI SCANALATURA SDS-PLUS 250MM	0.27	10	50	3,35€



53850

14,90€

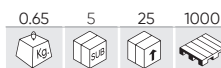

SET DI PUNTE SDS-PLUS PER TRAPANO A PERCUSSIONE



RICAMBI DISPONIBILI

REF.	mm				€
14826	Ø 5x110mm	0.05	125	500	1,50€
14828	Ø 6x110mm	0.05	25	500	1,50€
14829	Ø 6x160mm	0.04	25	500	1,50€
14830	Ø 8x110mm	0.04	25	500	1,50€
14831	Ø 8x160mm	0.05	25	500	1,50€
14832	Ø 10x160mm	0.05	25	200	2,00€
14920	Ø 12x160mm	0.10	100	200	2,50€

POTREBBE PIACERTI ANCHE...

REF.	mm				€
14825	Ø 4x110mm	0.05	100	200	1,50€
14827	Ø 5x160mm	0.04	25	500	2,00€
14833	Ø 10x210mm	0.10	20	200	2,05€
14834	Ø 12x210mm	0.10	100	200	2,50€
14835	Ø 14x210mm	0.10	20	125	3,00€
14836	Ø 16x210mm	0.14	20	120	3,50€



14841

2,58€

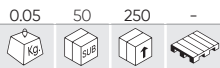

ADATTATORE SDS-PLUS PER MANDRINO PORTAPUNTA DA 1/2"



14842

9,50€

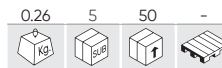

MANDRINO PORTAPUNTA A CAMBIO RAPIDO DA 2-13 MM 1/2" - 20 UNF (FILETTATURA FINE UNIFORME)



60006
60047C

53860

3,65€

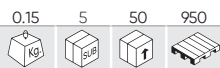

SET DI TRAPANI PER CALCESTRUZZO 4-10 MM



RICAMBI DISPONIBILI

REF.	mm				€
14908	Ø 4x75mm	0.01	50	100	0,60€
14909	Ø 5x80mm	0.01	50	100	0,80€
14910	Ø 6x100mm	0.01	50	100	1,00€
14912	Ø 8x120mm	0.05	50	100	1,55€
14914	Ø 10x120mm	0.04	20	100	2,10€

POTREBBE PIACERTI ANCHE...

REF.	mm				€
14915	Ø 11x150mm	0.05	20	100	2,65€
14916	Ø 12x150mm	0.06	20	100	2,95€
14917	Ø 13x150mm	0.10	20	100	3,45€



53861

5,45€

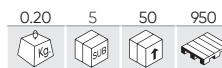

SET DI PUNTE PER CALCESTRUZZO 3-10 MM

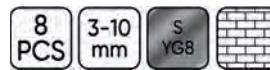

RICAMBI DISPONIBILI

REF.	mm				€
14907	Ø 3x60mm	0.01	50	100	0,50€
14908	Ø 4x75mm	0.01	50	100	0,60€
14909	Ø 5x80mm	0.01	50	100	0,80€
14910	Ø 6x100mm	0.01	50	100	1,00€
14911	Ø 7x100mm	0.01	50	100	1,30€
14912	Ø 8x120mm	0.05	50	100	1,55€
14913	Ø 9x120mm	0.05	50	100	1,90€
14914	Ø 10x120mm	0.04	20	100	2,10€



53859

67,00€

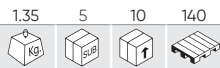

SET DI SEGHE AD ANELLO BIMETALLICHE CON ADATTATORI



	x6	22, 29, 35, 44, 51, 68mm
	x2	14-30mm, 32-152mm



RICAMBI DISPONIBILI

REF.	mm				€
14901	22mm	0.04	10	50	3,60€
14902	29mm	0.08	10	50	4,65€
14903	35mm	0.10	10	50	5,25€
14904	44mm	0.12	10	50	6,85€
14905	51mm	0.12	10	50	8,50€
14906	68mm	0.19	10	50	10,20€
14934	14-30mm	0.07	10	50	4,25€
14935	32-152mm	0.20	10	50	8,45€

SET DI PUNTE AD ELICA HSS 4341

53852 207,00€

4.20 - 4 192

170 PCS HSS-G 4341

METAL 1-10 mm

53856 62,00€

1.32 5 10 550

25 PCS HSS-G 4341

METAL 1-13 mm

53854 27,00€

0.63 5 20 192

19 PCS HSS-G 4341

METAL 1-10 mm

RICAMBI DISPONIBILI

REF.	mm				€
14868	Ø 1x34mm	0.01	50	400	0,55€
14869	Ø 1.5x40mm	0.01	50	400	0,60€
14870	Ø 2x49mm	0.01	50	400	1,00€
14871	Ø 2.5x57mm	0.01	50	400	1,00€
14872	Ø 3x61mm	0.01	50	400	1,00€
14873	Ø 3.5x70mm	0.01	50	400	1,00€
14874	Ø 4x75mm	0.01	50	400	1,00€
14875	Ø 4.5x80mm	0.01	50	400	1,50€
14876	Ø 5x86mm	0.01	50	300	1,50€
14877	Ø 5.5x93mm	0.02	50	300	1,50€
14878	Ø 6x93mm	0.02	25	400	2,00€
14879	Ø 6.5x101mm	0.02	25	400	2,00€
14880	Ø 7x109mm	0.03	25	400	2,50€
14881	Ø 7.5x109mm	0.03	25	400	2,50€
14882	Ø 8x117mm	0.04	25	400	3,00€
14883	Ø 8.5x117mm	0.04	25	400	3,50€
14884	Ø 9x125mm	0.05	25	400	3,65€
14885	Ø 9.5x125mm	0.05	25	400	4,00€
14886	Ø 10x133mm	0.06	25	400	4,60€
14887	Ø 10.5x133mm	0.07	25	400	5,00€
14888	Ø 11x142mm	0.08	25	400	6,00€
14889	Ø 11.5x142mm	0.09	25	400	6,50€
14890	Ø 12x151mm	0.10	25	300	7,00€
14891	Ø 12.5x151mm	0.09	25	200	7,50€
14892	Ø 13x151mm	0.09	25	200	8,00€



1x34, 1.5x40, 2x49, 2.5x57, 3x61, 3.5x70, 4x75, 4.5x80, 5x86, 5.5x93, 6x93, 6.5x101, 7x109, 7.5x109, 8x117, 8.5x117, 9x125, 9.5x125, 10x133mm

1x34, 1.5x40, 2x49, 2.5x57, 3x61, 3.5x70, 4x75, 4.5x80, 5x86, 5.5x93, 6x93, 6.5x101, 7x109, 7.5x109, 8x117, 8.5x117, 9x125, 9.5x125, 10x133, 10.5x133, 11x142, 11.5x142, 12x151, 12.5x151, 13x151mm

1x34, 1.5x40, 2x49, 2.5x57, 3x61, 3.5x70, 4x75, 4.5x80, 5x86, 5.5x93, 6x93, 6.5x101, 7x109, 7.5x109, 8x117, 8.5x117, 9x125, 9.5x125, 10x133mm

SET DI PUNTE AD ELICA HSS 4241 NERE

53851 88,00€

3.80 - 4 192

170 PCS HSS-G 4241

METAL 1-10 mm

53855 24,80€

1.19 5 10 192

25 PCS HSS-G 4241

METAL 1-13 mm

53853 14,40€

0.58 5 20 192

19 PCS HSS-G 4241

METAL 1-10 mm

RICAMBI DISPONIBILI

REF.	mm				€
14843	Ø 1x34mm	0.01	50	400	0,50€
14844	Ø 1.5x40mm	0.01	50	400	0,50€
14845	Ø 2x49mm	0.01	50	400	0,50€
14846	Ø 2.5x57mm	0.01	50	400	0,50€
14847	Ø 3x61mm	0.01	50	400	0,50€
14848	Ø 3.5x70mm	0.01	50	400	0,50€
14849	Ø 4x75mm	0.01	50	400	1,00€
14850	Ø 4.5x80mm	0.01	50	400	1,00€
14851	Ø 5x86mm	0.01	50	300	1,00€
14852	Ø 5.5x93mm	0.01	50	300	1,00€
14853	Ø 6x93mm	0.02	25	400	1,00€
14854	Ø 6.5x101mm	0.02	25	400	1,00€
14855	Ø 7x109mm	0.02	25	400	1,00€
14856	Ø 7.5x109mm	0.03	25	400	1,00€
14857	Ø 8x117mm	0.03	25	400	1,50€
14858	Ø 8.5x117mm	0.04	25	400	1,50€
14859	Ø 9x125mm	0.04	25	400	1,50€
14860	Ø 9.5x125mm	0.05	25	400	2,00€
14861	Ø 10x133mm	0.05	25	400	2,00€
14862	Ø 10.5x133mm	0.06	25	400	2,00€
14863	Ø 11x142mm	0.07	25	400	2,50€
14864	Ø 11.5x142mm	0.07	25	400	2,50€
14865	Ø 12x151mm	0.08	25	300	2,50€
14866	Ø 12.5x151mm	0.09	25	200	3,00€
14867	Ø 13x151mm	0.09	25	200	3,00€



1x34, 1.5x40, 2x49, 2.5x57, 3x61, 3.5x70, 4x75, 4.5x80, 5x86, 5.5x93, 6x93, 6.5x101, 7x109, 7.5x109, 8x117, 8.5x117, 9x125, 9.5x125, 10x133mm

1x34, 1.5x40, 2x49, 2.5x57, 3x61, 3.5x70, 4x75, 4.5x80, 5x86, 5.5x93, 6x93, 6.5x101, 7x109, 7.5x109, 8x117, 8.5x117, 9x125, 9.5x125, 10x133, 10.5x133, 11x142, 11.5x142, 12x151, 12.5x151, 13x151mm

1x34, 1.5x40, 2x49, 2.5x57, 3x61, 3.5x70, 4x75, 4.5x80, 5x86, 5.5x93, 6x93, 6.5x101, 7x109, 7.5x109, 8x117, 8.5x117, 9x125, 9.5x125, 10x133mm

SET DI PUNTE ELICOIDALI HSS-CO5 COBALTO

N

54348 291,00€



170 PCS HSS CO5
METAL 1-10 mm

54314 82,00€



25 PCS HSS CO5
METAL 1-13 mm

54313 43,00€

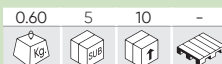

19 PCS HSS CO5
METAL 1-10 mm

RICAMBI DISPONIBILI

REF.	mm				€
16318	Ø 1x34mm	0.50	25	400	0,50€
16319	Ø 1.5x40mm	0.50	25	400	0,50€
16320	Ø 2x49mm	0.50	25	400	0,50€
16321	Ø 2.5x57mm	0.50	25	400	1,00€
16322	Ø 3x61mm	0.50	25	400	1,00€
16323	Ø 3.5x70mm	0.50	25	400	1,00€
16324	Ø 4x75mm	0.05	25	400	1,50€
16325	Ø 4.5x80mm	0.50	25	400	1,50€
16326	Ø 5x86mm	0.50	25	400	2,00€
16327	Ø 5.5x93mm	0.50	25	400	2,00€
16328	Ø 6x93mm	0.50	25	400	2,50€
16329	Ø 6.5x101mm	0.50	25	400	3,00€
16330	Ø 7x109mm	0.50	25	400	3,50€
16331	Ø 7.5x109mm	0.50	25	400	3,50€
16332	Ø 8x117mm	0.50	25	400	4,00€
16333	Ø 8.5x117mm	0.05	5	200	4,50€
16334	Ø 9x125mm	0.50	25	200	5,50€
16335	Ø 9.5x125mm	0.50	25	200	6,00€
16336	Ø 10x133mm	0.50	25	200	6,50€
16583	Ø 10.5x133mm	0.07	25	200	8,50€
16584	Ø 11x142mm	0.07	25	200	10,50€
16585	Ø 11.5x142mm	0.08	25	200	11,50€
16586	Ø 12x151mm	0.10	25	200	13,00€
16587	Ø 12.5x151mm	0.10	25	200	14,00€
16588	Ø 13x151mm	0.11	25	200	15,00€



1x34, 1.5x40, 2x49, 2.5x57, 3x61, 3.5x70, 4x75, 4.5x80, 5x86, 5.5x93, 6x93, 6.5x101, 7x109, 7.5x109, 8x117, 8.5x117, 9x125, 9.5x125, 10x133mm

1x34, 1.5x40, 2x49, 2.5x57, 3x61, 3.5x70, 4x75, 4.5x80, 5x86, 5.5x93, 6x93, 6.5x101, 7x109, 7.5x109, 8x117, 8.5x117, 9x125, 9.5x125, 10x133, 10.5x133, 11x142, 11.5x142, 12x151, 12.5x151, 13x151mm

1x34, 1.5x40, 2x49, 2.5x57, 3x61, 3.5x70, 4x75, 4.5x80, 5x86, 5.5x93, 6x93, 6.5x101, 7x109, 7.5x109, 8x117, 8.5x117, 9x125, 9.5x125, 10x133mm

53857

27,00€

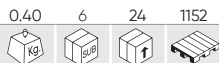

SET S2 INSERTI AD IMPATTO A CAMBIO RAPIDO - FINITURA NERA

57 PCS S2



IN ESPOSITORE DA 6 UNITÀ



CONTIENE

	x9	PH	25mm	1x3, 2x3, 3x3
	x9	PZ	25mm	1x3, 2x3, 3x3
	x4	H	25mm	3, 4, 5, 6
	x6	SL	25mm	4x2, 5x2, 6x2
	x14	TX	25mm	10x2, 15x2, 20x2, 25x2, 27x2, 30x2, 40x2
	x7	T	25mm	10, 15, 20, 25, 27, 30, 40
	x7		65mm	PH2, PH3, PZ1, PZ2, T20, T25, SL6
	x1		60mm	

* COMPATIBILE ANCHE CON REF. 60005

53858

28,80€

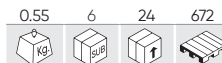

SET S2 INSERTI AD IMPATTO CON ADATTATORI - FINITURA NERA

33 PCS S2



IN ESPOSITORE DA 6 UNITÀ



CONTIENE

	x4	PH	25mm	1, 2x2, 3
	x3	PZ	25mm	1, 2, 3
	x4	H	25mm	3, 4, 5, 6
	x4	SL	25mm	3, 4, 5, 6
	x6	TX	25mm	10, 15, 20, 25, 30, 40
	x6		75mm	T15, T20, T25, PH2, PZ2, SL5
	x4		48mm	6, 7, 8, 10mm
	x1		60mm	
	x1		80mm	

* COMPATIBILE ANCHE CON REF. 60005

54346

11,50€

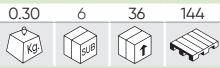

N

SET DI 3 SPAZZOLE PER LA PULIZIA DEL TRAPANO

3 PCS PP 1/4"

- A Ø 88mm
- B Ø 100mm
- C Ø 50mm



60037

SET DI CHIODI BRAD SALIBRO 38

REF.	mm				€
53999	25x1,25mm	0.20	-	50	2,00€
54000	30x1,25mm	0.25	-	50	2,50€
54002	38x1,25mm	0.30	-	50	3,00€

1000 PCS



SET DI GRAFFE CALIBRO 18

REF.	mm				€
54008	25x6mm	0.45	-	40	3,50€
54010	32x6mm	0.55	-	40	4,50€
54011	38x6mm	0.65	-	40	5,00€

1000 PCS



60028
60049C

15014

20,00€

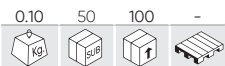

M14 115-230 mm

DADO DI BLOCCAGGIO AD ESTRAZIONE RAPIDA M14 PER SMERIGLIATRICI ANGOLARI



ELETTROUTENSILI A BATTERIA

PER METALLO

REF.	PER	DESCRIZIONE					€
14893	60008	T42 - 115x2,5mm	0.05	50	100	-	2,00€
14894	60028	T42 - 125x2,5mm	0.05	50	200	-	1,20€
14895	60008	T27 - 115x6mm	0.15	25	100	-	1,90€
14896	60028	T27 - 125x6mm	0.78	25	100	-	2,10€

PER ACCIAIO INOSSIDABILE

REF.	PER	DESCRIZIONE					€
14897	60008	T41 - 115x1mm	0.01	50	400	-	0,88€
14898	60028	T41 - 125x1mm	0.03	50	400	-	0,98€
14899	60008	T41 - 115x1,6mm	0.03	50	400	-	0,88€
14900	60028	T41 - 125x1,6mm	0.04	50	400	-	0,98€



14893

T27	80 m/s	13300 RPM
Ø115mm	Ø22,23mm	



14894

T42	80 m/s	12200 RPM
Ø125mm	Ø22,23mm	



14897

T41	80 m/s	13300 RPM
Ø115mm	Ø22,23mm	



14898

T41	80 m/s	12200 RPM
Ø125mm	Ø22,23mm	



14895

T42	80 m/s	13300 RPM
Ø115mm	Ø22,23mm	



14896

T27	80 m/s	12200 RPM
Ø125mm	Ø22,23mm	



14899

T41	80 m/s	13300 RPM
Ø115mm	Ø22,23mm	



14900

T41	80 m/s	12200 RPM
Ø125mm	Ø22,23mm	









PER METALLO (ACCIAIO INOSSIDABILE, ALLUMINIO, RAME)

REF.	PER	DESCRIZIONE					€
14988	60007	24T 165mm	0.25	20	40	2400	8,00€
14989	60011	24T 115mm	0.10	20	100	3600	6,00€
14990	60022	40T 185mm	0.30	20	40	2200	10,50€
14993	60010	T118A	0.05	20	200	7200	5,00€
14995	60019	150mm 24TPI	0.05	20	200	8400	8,00€

PER LEGNO

REF.	PER	DESCRIZIONE					€
14985	60007	24T 165mm	0.25	20	40	2400	6,00€
14986	60011	24T 115mm	0.10	20	100	3600	4,00€
14987	60022	40T 185mm	0.30	20	40	2200	8,50€
14991	60010	T244D	0.05	20	200	7200	2,00€
14994	60019	150mm 6TPI	0.05	20	200	8400	3,50€

14989

x24	7000 RPM
Ø115mm	Ø10mm

14988

x24	7000 RPM
Ø165mm	Ø20mm

14990

x40	7000 RPM
Ø185mm	Ø25,4mm

14955

24TPI	10mm CORN. HMA CUT
150mm	

14994

6TPI	150mm CORN. HMA CUT
150mm	

14991

T244D	100mm CORN. HMA CUT
100mm	

14993

T118A	8mm CORN. HMA CUT
76mm	

14986

x24	7000 RPM
Ø115mm	Ø10mm

14985

x24	7000 RPM
Ø165mm	Ø20mm

14987

x40	7000 RPM
Ø185mm	Ø25,4mm

ILLUMINAZIONE

- 130 TORCE DA OFFICINA
- 132 FRONTALI
- 134 TORCE ELETTRICHE
- 135 FARI
- 136 ILLUMINAZIONE PER COFANO
- 137 GIROFARI
- 139 FARI DA LAVORO
- 142 SEGNALETICA
- 144 ACCESSORI E RICAMBI

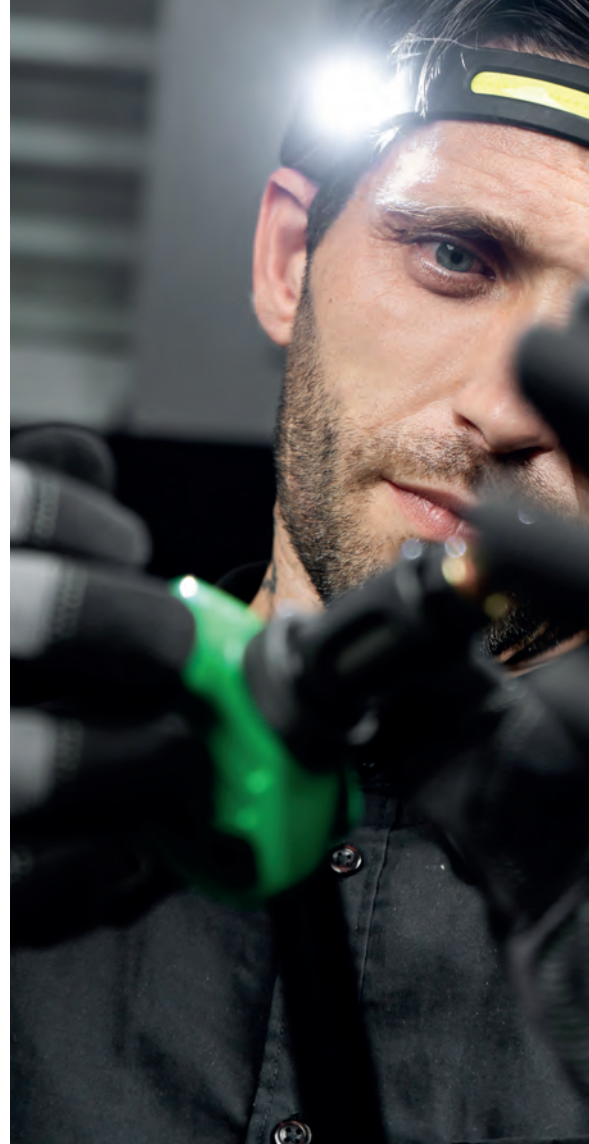

53734

23,70€

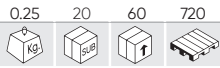

LAMPADA DA LAVORO - 400LM

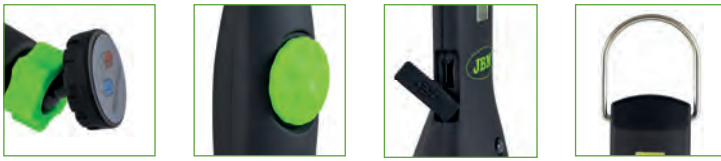

BASE GIREVOLE
MAGNETIZZATA
360°

PULSANTE DI
INTENSITÀ DELLA
LUCE

CARICATORE USB

CON GANCIO



LED COB
400Lm - 2,5H

LED COB
30Lm - 10H

LI-ION
3.7V 2.600mah



IN ESPOSITORE
DA 20 UNITÀ



53519

42,00€

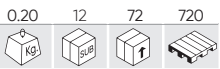

LAMPADA DA LAVORO PORTATILE COB
ULTRA SOTTILE



150Lm - 4H

300Lm - 2H

LI-POLI
3.7V 800mA

LED
3W COB

100V
240V

50-60
Hz

6500± 400
KELVIN

IP
44

68-71
ICR

5V
0.6A



IN ESPOSITORE
DA 12 UNITÀ

52536

57,00€

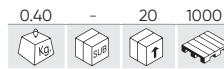

LAMPADA DA LAVORO PORTATILE SLIMLINE
CON TECNOLOGIA COB

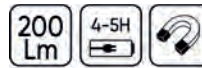

INTENSITY 1
3H

INTENSITY 2
4H

LITHIUM
3.7V 1.900mA

LED
2W COB



DISEÑO REGISTRADO
REGISTERED DESIGN



51889

49,00€

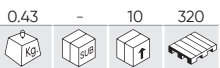

LAMPADA DA LAVORO DA OFFICINA A 24+6
LED CON DOPPIO MAGNETE POSTERIORE,
SUPPORTO E BASE MAGNETICA

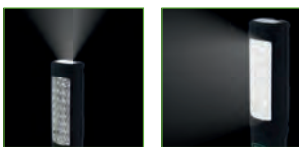

80
Lm

3-4H

80Lm - 5H

LED
24+6

LITHIUM
3.7V 2200mah



53216

49,00€

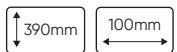
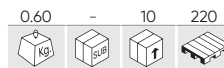

LAMPADA DA LAVORO LED COB CON BASE
ARTICOLATA



170Lm - 4H

LED
2W COB

LITHIUM
3.7V 2.000mA

LITHIUM
5V 1000mA



TORCIA PORTATILE A LED CON BASE MAGNETICA REGOLABILE

54122 38,00€

0.39 12 24 384

300 Lm 3-4H

LED 3W - 7H COB 3W - 2,5H

LITHIUM 3.7V 2.000mA 6500± 400 KELVIN

IP 44 68-71 ICR 100V 240V 5V 1A

54123 40,00€

0.39 12 24 384

500 Lm 6-7H

LED 3W - 14H COB 5W - 3H

LITHIUM 3.7V 4.000mA 6500± 400 KELVIN

IP 44 68-71 ICR 100V 240V 5V 1A

54124 47,00€

0.39 12 24 384

1000 Lm 6-8H

LED 3W - 14H COB 10W - 3H

LM 1000 900 700
5min 30min 145min

LITHIUM 3.7V 4.000mA 6500± 400 KELVIN

IP 44 68-71 ICR 100V 240V 5V 1A

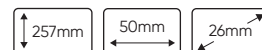

IN ESPOSITORE DA 12 UNITÀ

REF. DESCRIZIONE

14031 ADATTATORE USB PER SPINA A MURO

0.10 10 100 1152 € 7,90€

54379 28,00€

0.23 12 48 1440

80-800 Lm 5,2V 0,5W

3,5H 4-12H BANCO DE ENERGIA POWER BANK

80Lm 3W COB 800Lm 10W COB

x1 LI-POLI 3.7V - 4000mAh

LOW MEDIUM HIGH RED/RED STROBE

IN ESPOSITORE DA 12 UNITÀ

140mm 73mm 20mm

53776 19,10€

0.15 12 48 1872

90 Lm 300 Lm 2,5H

300Lm 5W COB - 3H LI-ION 3.7V 1500mah

250Lm 3W COB - 3,5H ABS TPR

90Lm 3W LED - 6H

IN ESPOSITORE DA 12 UNITÀ

150mm 40mm 23mm

250LM 3W COB 300LM 5W COB 90LM 3W LED

54344

10,50€

0,10	10	100	1200

CAPPELLO CON LAMPADA A LED

120 Lm	60 Lm	25 Lm
--------	-------	-------

LM 120	60	25
40min	6-8h	8-10h

3.7V 250mAh	2H
-------------	----

LUZ DISPERSA SCATTERED LIGHT	1W
---------------------------------	----



UNITÀ LUMINOSA RIMOVIBILE

POLIESTERE (65%)
ACRILICO (35%)



N

52987

20,00€

0,17	10	40	720

LAMPADA DA LAVORO TASCABILE CON BATTERIA

120 Lm	2,5H
--------	------

120Lm - 2,5H	
--------------	--

LITHIUM 3.7V 1.000mA	LED 3W COB
-------------------------	---------------



IN ESPOSITORE DA 10 UNITÀ



53780

14,50€

0,45	5	20	300

LAMPADA DA LAVORO A LED 400LM

400 Lm	6W	220V 240V
--------	----	--------------

IP 20	50 Hz
-------	-------

6000± 7000 KELVIN

H05RN-F 2x0.75mm ² - 5m

CAVO DI ALIMENTAZIONE DA 2,5M



52384

29,00€

0,33	-	20	600

LAMPADA DA LAVORO PORTATILE ULTRA SOTTILE ALTA LUMINOSITÀ

- Lunghezza del cavo : 5m
- Lunghezza del cavo DC: 0.1M
- Lunghezza del cavo DC fino pinze : 0.3M

200 Lm	12V 24V
--------	------------

LED 3W COB

75mm	325mm	90mm
------	-------	------



53217

47,00€

0,30	-	20	620

LAMPADA DA LAVORO LED COB

200 Lm	4H	LED 2W COB		LITHIUM 3.7V 2.200mah	LITHIUM 5V 1.000mah
--------	----	---------------	--	--------------------------	------------------------



54004

16,00€

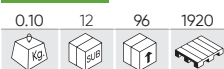

LAMPADA FRONTALE COB

COB 350Lm -5W COB	LED 90Lm -3W XPE
COB 350Lm - 2,5H 150Lm - 5 H Flash - 8 H	LED XPE 150Lm - 4H 60Lm - 8 H
LI-ION 3.7V 1.200mA	Gel de silice Silica gel
2m	IP X4



PULSANTE SENSORE DI MOVIMENTO

Premere per attivare.
Premere per disattivare.
Passa la mano davanti al pulsante per accendere e spegnere la luce.

- Materiale: silicagel
- Indicatore di accensione
- Indicatore di induzione
- Modalità di attivazione del sensore di movimento
- Cavo di carica USB incluso



IN ESPOSITORE DA 12 UNITÀ

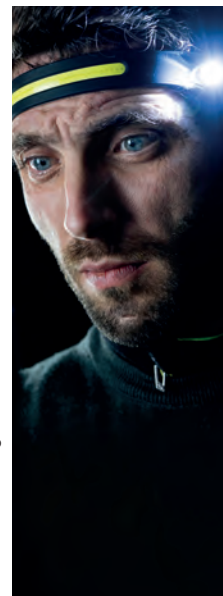

53569

18,00€

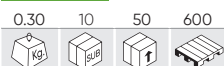

LAMPADA FRONTALE DA 800 LM (COB + CREE)

REGOLATORE DI MESSA A FUOCO
3 MODALITÀ DI LUCE
BATTERIE RICARICABILI
INDICATORE LUMINOSO ACCESO



MAX 800 Lm	2,5H	150m
LED COB + CREE	x2 18650	
High Low Flash COB		



53568

12,00€



LAMPADA FRONTALE DA 350 LM

REGOLATORE DI MESSA A FUOCO
3 MODALITÀ DI LUCE

MAX 350 Lm	2,5H	150m
High Low Flash SOS		
LI-ION 2000mAh		



54267

9,50€

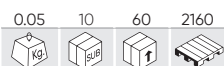

GUANTO CON LUCE LED

70 Lm	120 mAh	+20H
LED	DERECHA RIGHT	
x2 CR2016 INCLUIDAS / INCLUDED		
x2 LED 3.0V		



53974

38,00€

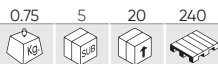

LAMPADA DA LAVORO RICARICABILE



4 MODALITÀ DI ILLUMINAZIONE
100% 50% SOS FLASH



MULTIPOSIZIONE

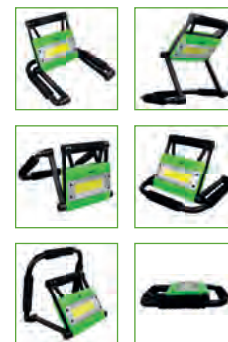

52555

2,38€

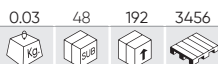

LAMPADA PORTATILE 9 LED



52558

2,38€

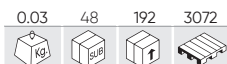

51326

4,40€

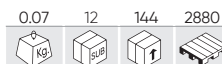

LAMPADA PORTATILE A 21 LED



PILE DI RICAMBIO

REF.	DESCRIZIONE	0.01	60	2400	134400	€
51258	"AAA" R03 1,5V					0,15€

PER REF. 51326, 52233, 52555, 52558

REF.	DESCRIZIONE	0.05	10	500	€
10923	9V				1,10€

PER REF. 52162, 52450, 51929, 50942



53427

5,00€

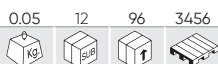

LAMPADA PORTATILE A 6 LED MAGNETIZZATA



IN ESPOSITORE DA 12 UNITÀ



51573

2,50€



LAMPADA PORTATILE A DINAMO A 2 LED

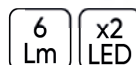

PRESENTAZIONE SCATOLA INDIVIDUALE



53227 28,00€

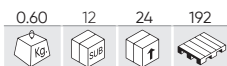

LENTE LED DA TAVOLO MAGNETICA

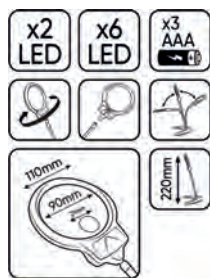

53085 30,00€

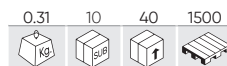

LENTE DI INGRANDIMENTO LED

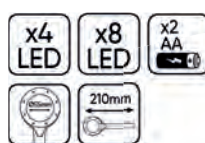

TREPIEDE PER LAMPADA A LED

REF.	Max.	Min.				€
53506	1830mm	840mm	2.40	-	8	36,00€
52254	2770mm	1290mm	3.51	-	4	64,00€



53505 77,00€



LAMPADA A LED DA 50W



54039 154,00€

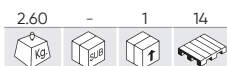

LAMPADA LED INDUSTRIALE

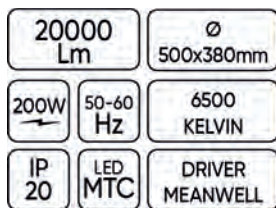

54133 547,00€



SET DI 6 LAMPADE LED INDUSTRIALI 54039

6 PCS



REF.	DESCRIZIONE					€
15385	CAPPUCCIO DI RICAMBIO PER 54039	0.15	6	60	600	18,00€

54088 132,00€



LAMPADA LED INDUSTRIALE

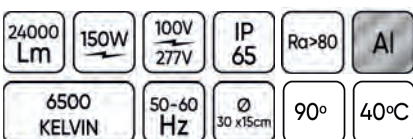

54270

42,00€

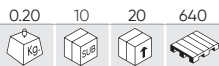

LAMPADA A LED CON SUPPORTO MAGNETICO

1000 Lm 3-4H

LED 1000Lm- 2H LED 400Lm- 5H

x2 LI-ION 3.7V - 1200mAh USB TYPE-C



54271

54,00€

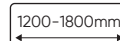
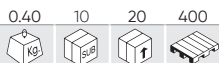

LAMPADA A LED MAGNETICA CON CINGHIA PER COFANO

1000 Lm 3-4H

LED 1000Lm- 2H LED 400Lm- 5H

x2 LI-ION 3.7V - 1200mAh USB TYPE-C



ARTICOLATO

53707

153,00€



LAMPADA A LED CON SUPPORTO MAGNETICO

1000 Lm 7-8H 6H ABS

LED 3x5W COB 350Lm 700Lm 1000Lm

x4 LI-ION 3.7V - 2600mAh

3 MODALITÀ DI LUCE
BATTERIA RICARICABILE
INDICATORI LUMINOSI DELLO STATO DELLA BATTERIA

AUMENTARE SIGNIFICATIVAMENTE LA VISIBILITÀ NELL'AREA DI LAVORO
PERMETTE DI DIRIGERE LA LAMPADINA INDIVIDUALMENTE DOVE NECESSARIO
CON SUPPORTO MAGNETICO PER ADATTARSI A QUALSIASI SITUAZIONE



53570

154,00€

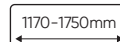

LAMPADA PER LAVORI PER COFANO

1000 Lm 7-8H 6H

LED 3x5W COB 400Lm 800Lm 1200Lm

x4 LI-ION 3.7V - 2600mAh

3 MODALITÀ DI LUCE
BATTERIA RICARICABILE
INDICATORI LUMINOSI DELLO STATO DELLA BATTERIA

AUMENTARE SIGNIFICATIVAMENTE LA VISIBILITÀ NELL'AREA DI LAVORO
PERMETTE DI DIRIGERE LA LAMPADINA INDIVIDUALMENTE DOVE NECESSARIO



54173 87,00€

0.75 5 20 240

LUCE ROTANTE A LED RICARICABILE CON MAGNETE

- FUNZIONI:
FUNZIONE 1: FLASH
FUNZIONE 2: LAMPEGGIO DOPPIO
FUNZIONE 3: ROTAZIONE

20W 5V x45 LED
PC ABS 2-3H 2-3H
LI-ION 7.4V - 2200mA -30°C 50°C IP 65



REF. DESCRIZIONE €

16053 CAVO USB TIPO A / SPINA ROTONDA 5.5MM 0.05 10 100 2,85€

54172 81,00€

0.80 5 20 240

LUCE ROTANTE LED LAMPEGGIANTE CON BASE FLESSIBILE

- FUNZIONI:
FUNZIONE 1: FLASH
FUNZIONE 2: LAMPEGGIO DOPPIO
FUNZIONE 3: ROTAZIONE

20W 5V x45 LED
PC ABS 2-3H 2-3H
LI-ION 7.4V - 2200mA -30°C 50°C IP 65



REF. DESCRIZIONE €

16052 CAVO USB TIPO A / SPINA ROTONDA 3.5MM 0.05 10 100 2,09€

53691 36,00€

0.70 - 20 320

LUCE ROTANTE LED MAGNETICO

- FUNZIONI:
FUNZIONE 1: FLASH
FUNZIONE 2: LAMPEGGIO DOPPIO
FUNZIONE 3: ROTAZIONE



x8 LED 18W 12V 24V IP 66
112mm Ø 125cm -30°C 50°C
4m PC ECE R10 ECE R65



53690 34,00€

0.55 - 20 200

LUCE ROTANTE LED 12-24V BASE FLESSIBILE

- FUNZIONI:
FUNZIONE 1: FLASH
FUNZIONE 2: LAMPEGGIO DOPPIO
FUNZIONE 3: ROTAZIONE



x8 LED 18W 12V 24V IP 66
182mm Ø 125cm -30°C 50°C
PC ECE R10 ECE R65



52375 38,00€

0.70 - 20 240

LUCE ROTANTE A LED 12-24V

- LENTE ABS-BAES.
- CALOTTA RESISTENTE.
- CAVO: SPIRALE DI 2,5M + ALIMENTAZIONE DALL'ACCENDISIGARI.
- CONSUMO: 9W.

- FUNZIONI:
FUNZIONE 1: ROTAZIONE
FUNZIONE 2: DOPPIO FLASH
FUNZIONE 3: 6 LAMPEGGI

12V 24V 9W
170mm Ø 140cm IP 56
2,5m PC/ABS ECE R10

170mm Ø140mm



BASE MAGNETICA

52456 36,00€

0.60 - 20 160

LUCE ROTANTE LED 12-24V A BASE FLESSIBILE

- LENTE PC.
- CALOTTA RESISTENTE.
- CONSUMO: 8W.

- FUNZIONI:
FUNZIONE 1: ROTAZIONE
FUNZIONE 2: DOPPIO FLASH
FUNZIONE 3: 6 LAMPEGGI

12V 24V 8W PC/ABS
240mm Ø 128cm IP 56
ECE R10

240mm Ø128mm



ABS - BAES
BASE FLESSIBILE

ILLUMINAZIONE

51964

28,00€



LUCE ROTANTE A BASE FLESSIBILE H1 12V 55W

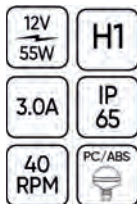

Calotta resistente
Lente: PC
Filo della lente con sigillatura duratura.
Giri/min. 40
Sistema di pignone / vite senza fine
Lampada H1, 12V - 55W
Con base a vite
Consumo di corrente: 3,0 Amp



ABS - BAES
BASE FLESSIBILE

51965

29,50€



LUCE ROTANTE BASE FLESSIBILE H1 24V 70W



Calotta resistente
Lente: PC
Filo della lente con sigillatura duratura.
Giri/min. 40
Sistema di pignone / vite senza fine
Lampada H1, 24V - 70W
Con base a vite
Consumo di corrente: 3,0 Amp



ABS - BAES
BASE FLESSIBILE

51962

25,00€



LUCE ROTANTE SENZA CAVO H1 12V 55W



Calotta resistente
Lente ABS - BAES
Filo della lente con sigillatura duratura.
Giri/min. 40
Sistema di pignone / vite senza fine
Lampada H1, 12V - 55W
Consumo di corrente: 3,0 Amp



51963

29,00€



LUCE ROTANTE SENZA CAVO H1 24V 70W



Calotta resistente
Lente ABS - BAES
Filo della lente con sigillatura duratura.
Giri/min. 40
Sistema di pignone / vite senza fine
Lampada H1, 24V - 70W
Consumo di corrente: 3,0 Amp



51960

34,00€

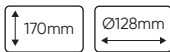

LUCE ROTANTE CON CAVO MAGNETIZZATO H1 12V-55W



Calotta resistente
Lente ABS - BAES
Filo della lente con sigillatura duratura.
Giri/min. 40
Sistema di pignone / vite senza fine
Lampada H1, 12V 55W
Cavo:
Spirale di 4 metri con alimentazione dall'accendisigari.
Consumo di corrente: 3,0 Amp



51961

34,00€

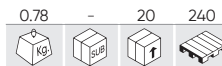

LUCE ROTANTE CON CAVO MAGNETIZZATO H1 24V 70W



Calotta resistente
Lente ABS - BAES
Filo della lente con sigillatura duratura.
Giri/min. 40
Sistema di pignone / vite senza fine
Lampada H1, 24V 70W
Cavo:
Spirale di 4 metri con alimentazione dall'accendisigari.
Consumo di corrente: 3,0 Amp



LUCE ROTANTE

REF.						€
52827		0.50	-	20	400	46,00€
52828		0.54	-	20	320	43,00€
52910		0.50	-	20	320	39,00€

- 3 INTERRUTTORI DI FUNZIONE.
- 3 MODALITÀ LAMPEGGIANTE:
ROTAZIONE
6 LAMPEGGI
DOPPIO FLASH



51966

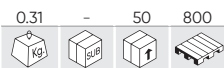

LUCE ROTANTE 12 V - 110 V



- Lente ABS - BAES.
- XENON.
- Consumo di corrente: 3.0 A.



BASE CALOTTA

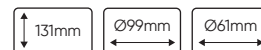

18,00€

ACCESSORI

REF.	DESCRIZIONE					€
11103	LAMPADA DI RICAMBIO PER 51966	0.01	-	100	-	6,00€
10766	LAMPADA DI RICAMBIO PER 51960, 51962	0.01	-	200	-	1,59€
10750	CONNETTORI AD ASTA PER LAMPEGGIANTE REF. 51964, 51965, 52456	0.25	-	50	-	13,00€
10751	CONNETTORI AD ASTA PER LAMPEGGIANTE REF. 51964, 51965, 52300 E 52456	0.30	-	50	-	15,00€
52843	BARRA TELESCOPICA	0.90	-	20	1500	31,60€
51969	COPERCHIO ARANCIO PER LAMPEGGIANTI PER REF. 51960, 51961, 51964	0.12	-	50	1000	14,00€
11324	COPERCHIO AZZURRO PER LAMPEGGIANTI PER REF. 51960, 51961, 51964	0.13	-	100	-	17,50€
11325	COPERCHIO ROSSO PER LAMPEGGIANTI REF. 51960, 51961, 51964	0.12	-	50	451	17,50€



LAMPADA DA LAVORO LED LUCE DIFFUSA

53428

18,00€

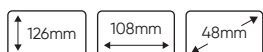
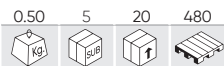

53429

18,00€

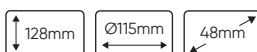
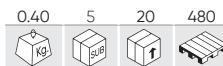

ILLUMINAZIONE

52566

28,00€

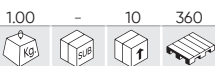

1450 Lm x9 LED 27W 10V/40V
 +30.000H IP 68
 LUZ DISPERSA SCATTERED LIGHT AI

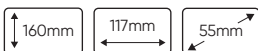

52567

29,00€

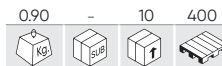

1450 Lm x9 LED 27W 10V/40V
 +30.000H IP 68
 LUZ DISPERSA SCATTERED LIGHT AI

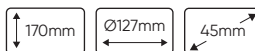

52302

25,40€

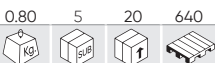

1450 Lm x9 LED 27W 10V/40V
 +30.000H IP 68
 LUZ DISPERSA SCATTERED LIGHT AI

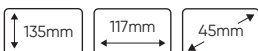

52303

26,40€

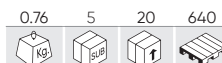

1450 Lm x9 LED 27W 10V/40V
 +30.000H IP 68
 LUZ DISPERSA SCATTERED LIGHT AI



53049

89,00€



3600 Lm x4 LED 40W 9V/36V
 +30.000H IP 68
 LUZ DISPERSA SCATTERED LIGHT AI



53052

158,00€



7200 Lm x8 LED 80W 9V/36V
 +30.000H IP 68
 LUZ DISPERSA SCATTERED LIGHT AI

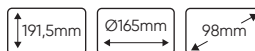

53045

35,00€

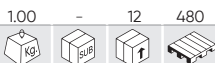

2800 Lm x16 LED 48W 10V/40V
 +20.000H IP 67
 LUZ DISPERSA SCATTERED LIGHT AI

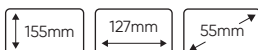

53046

39,00€



2272 Lm x16 LED 24W 9V/36V
 +20.000H IP 68
 LUZ DISPERSA SCATTERED LIGHT AI



LAMPADA DA LAVORO LED LUCE CONCENTRATA

52568 28,00€

0.75 - 10 400



1450 Lm x9 LED 27W 10V/30V

+30.000H IP 68

LUZ CONCENTRADA SPOTLIGHT AI



165mm 117mm 45mm

52569 28,00€

0.70 5 20 320



1450 Lm x9 LED 27W 10V/30V

+30.000H IP 68

LUZ CONCENTRADA SPOTLIGHT AI



170mm Ø127mm 45mm

53048 89,00€

1.50 - 10 1000



3600 Lm x4 LED 40W 9V/36V

+30.000H IP 68

LUZ CONCENTRADA SPOTLIGHT AI



118mm 123mm 87mm

53051 158,00€

2.75 - 6 468



7200 Lm x8 LED 80W 9V/36V

+30.000H IP 68

LUZ CONCENTRADA SPOTLIGHT AI



191,5mm Ø165mm 98mm

52415 19,00€

0.60 5 20 640



1450 Lm x9 LED 27W 10V/40V

+30.000H IP 68

LUZ CONCENTRADA SPOTLIGHT AI



127mm 110mm 50mm

52414 19,00€

0.55 5 20 600



1450 Lm x9 LED 27W 10V/40V

+30.000H IP 68

LUZ CONCENTRADA SPOTLIGHT AI



127mm Ø110mm 55mm

53047 330,00€

3.51 - 4 40



3200 Lm x10 LED 50W 12V/24V

6500 KELVIN 280cm IP 67

LUZ CONCENTRADA SPOTLIGHT

ROTAnte

VELOCITÀ DI MOVIMENTO REGOLABILE

TELECOMANDO 100M





230mm 185mm 150mm

ILLUMINAZIONE

54161

90,00€



BARRA PORTALUCI PER RIMORCHIO ESTENSIBILE RIFLETTENTE 1,4 A 2,1M



REGOLAMENTO	OMOLOGAZIONE
3	E9*3R02/17*23444*00
4	E9*4R00/19*23444*00
6	E9*6R01/29*23444*00
7	E9*7R02/27*23444*00
10	E9*10R06/00*22232*02

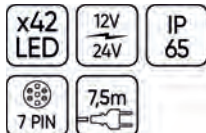

54163

80,00€



BARRA PER RIMORCHIO DI 1100 MM X 140 MM, 2 LUCI LED E 2 CATARIFRANGENTI TRIANGOLARI



REGOLAMENTO	OMOLOGAZIONE
3	E9*3R02/17*23444*00
4	E9*4R00/19*23444*00
6	E9*6R01/29*23444*00
7	E9*7R02/27*23444*00
10	E9*10R06/00*22232*02

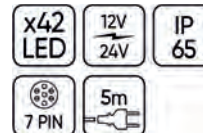

50910

45,00€



BARRA PER RIMORCHIO DI 1100X140MM, 2 LUCI E 2 CATARIFRANGENTI TRIANGOLARI



REGOLAMENTO	OMOLOGAZIONE
4	E4*4R-0024080
6	E4*6R-0124080
7	E4*7R-0224080
10	E9*10R06/02*23498*00

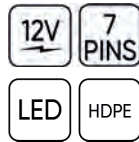

52838

56,00€

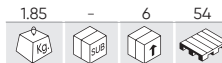

BARRA PER RIMORCHIO DI 1100 MM X 140 MM, 2 LUCI LED E 2 CATARIFRANGENTI TRIANGOLARI



OMOLOGAZIONE
E4*7R-0218756

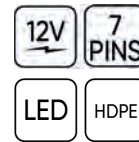

KIT MAGNETICO CON 2 LUCI E 2 CATARIFRANGENTI LED

CAVO PIATTO: 7,5M
SPIRALE: 2,5M

54162

81,00€



OMOLOGAZIONE
E9*7R02/27*23444*00



51886

44,00€



REGOLAMENTO	OMOLOGAZIONE
3	E4*3R-023749
4	E4*4R-0024080
6	E4*6R-0124080
7	E4*7R-0224080
10	E9*10R06/02*23498*00

52839

64,00€

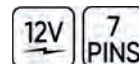

REGOLAMENTO	OMOLOGAZIONE
3	E4*3R-0218756
4	E4*4R-0018756
6	E4*6R-0118756
7	E4*7R-0218756
10	E9*10R06/02*23199*01

54044 99,00€

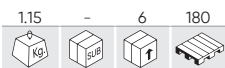

SET DI DUE FARI POSTERIORI MAGNETICI SENZA FILI



OMOLOGAZIONE

E9*10R05/01*16210*02

53151 14,00€

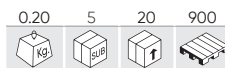

LAMPADA LED PER BARRA DI RIMORCHIO



- 4 funzioni:
- Blu: Posizione e targa.
- Rosso: Luce del freno.
- Giallo: Lampeggiante.
- Bianco: Massa.

LAMPADA LED PER BARRA DI RIMORCHIO

REF.					€
54160L	SINISTRO	0.20	5	20	17,50€
54160R	DESTRO	0.20	5	20	17,50€

- 4 funzioni:
- Nero: Posizione e targa.
- Rosso: Luce del freno.
- Verde: Lampeggiante.
- Bianco: Massa.

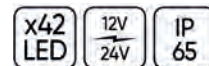

OMOLOGAZIONE

E9*7R02/27*23444*00
E9*10R06/01*23199*00



53536 34,00€

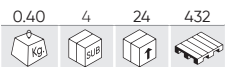

TESTER DELLE LUCI DEL RIMORCHIO 7/13 POLI



REF.	DESCRIZIONE				€
14753	ESTENSIONE A 7 PIN PER IL RIF. 53536	0.20	-	50	13,00€

51929 22,00€

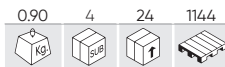

TESTER DELLE LUCI DEL RIMORCHIO 7 POLI



PRESA RIMORCHI PRESA VEICOLO

ILLUMINAZIONE

AVVISATORE ACUSTICO 12V-80V

REF.	DB	IP	V	°C				€
51967	97DB	IP65	12V-80V	-30/70°C	0.20	50	1200	16,00€
51968	107DB	IP65	12V-80V	-30/70°C	0.23	50	1000	16,00€



- Resistente a diverse condizioni climatologiche.
- Possibilità di lavaggio con acqua a pressione.
- Protetto dall'inversione di polarità.
- Sigillato con resina epossidica.



51967



51968

54078



68,00€

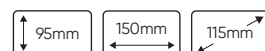

LUCE DI SICUREZZA PER CARRELLI ELEVATORI



Fanale di sicurezza ovale a 2 LED blu. Il fanale proietta sul suolo la luce blu diretta come segnale di avvertimento ai passanti.

Tale luce di avvertimento permette di evitare collisioni e incidenti in cui possano essere coinvolti carrelli elevatori e persone ed aumenta il livello di sicurezza in condizioni di lavoro, specie nelle cosiddette zone morte. Ideale per ambienti rumorosi.



PRESA ACCENDISIGARI E TRASFORMATORE

REF.	DESCRIZIONE					€
10961	TRASFORMATORI PER REF. 51889 E 52257	0.08	-	50	-	13,00€
11107	PRESA 12V PER REF 51889	0.06	-	250	-	4,50€
11989	ACCENDISIGARI PER LAMPADA REF. 52536	0.04	-	200	-	2,00€
13839	ADATTATORE PER PLUG USB 110V/60HZ	0.04	-	200	-	8,50€
14031	ADATTATORE USB PER SPINA A MURO	0.10	10	100	1152	7,90€
14032	ADATTATORE USB PER PRESA ACCENDISIGARI	0.10	10	100	1200	12,00€
14033	CAVO USB TIPO A / MICRO-B	0.10	10	100	500	4,50€
16052	CAVO USB TIPO A / SPINA ROTONDA 3.5MM	0.05	10	100	-	2,09€
16053	CAVO USB TIPO A / SPINA ROTONDA 5.5MM	0.05	10	100	-	2,85€



10961



11107



11989



13839



14031



14032



14033



16052

16053

UTENSILI PNEUMATICI

- 147 AVVITARE
- 151 FORATURA
- 152 TAGLIARE/SEGARE
- 153 LEVIGARE/LUCIDARE
- 156 PISTOLE AD ARIA COMPRESSA
- 158 MANUTENZIONE PNEUMATICI
- 160 ALTRO
- 163 AVVOLGITUBO/TUBI
- 165 CONNETTORI
- 166 ACCESSORI E MATERIALI DI CONSUMO





JBM RACCOMANDA L'UTILIZZO DEI PROPRI OLI LUBRIFICANTI PER OTTIMIZZARE LE PRESTAZIONI ED ALLUNGARE LA DURATA DELL'UTENSILE

REF.14534 REF.14560

PAGINA 161

53520

228,00€



AVVITATORE PNEUMATICO DA 1/2" (1756NM) - COMPOSITE



COMPOSITE
1756Nm



REF.	DESCRIZIONE	kg	SUB	QTY	€
14121	KIT DI RIPARAZIONE PER UTENSILI PNEUMATICI - 51207 / 53520	0.75	-	20	26,00€

51207

289,00€



SET CHIAVE D'URTO 1/2" IN COMPOSITO + BUSSOLE



COMPOSITE
1756Nm

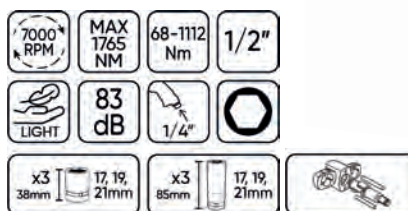

REF.	DESCRIZIONE	kg	SUB	QTY	€
14121	KIT DI RIPARAZIONE PER UTENSILI PNEUMATICI - 51207 / 53520	0.75	-	20	26,00€

51206

228,00€

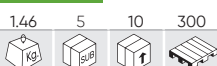

AVVITATORE PNEUMATICO MINI DA 1/2" COMPOSITE



COMPOSITE
1302Nm

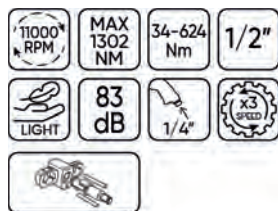

REF.	DESCRIZIONE	kg	SUB	QTY	€
14120	KIT DI RIPARAZIONE PER UTENSILI PNEUMATICI - 51206	0.15	-	5	22,00€

53588

178,00€



AVVITATORE PNEUMATICO NANO DA 1/2" (1302NM)



1302Nm

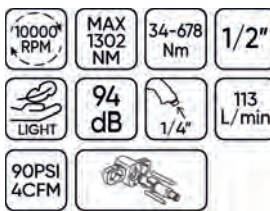

REF.	DESCRIZIONE	kg	SUB	QTY	€
14165	KIT DI RIPARAZIONE PER UTENSILI PNEUMATICI - 53588	0.05	-	20	26,50€

JBM RACCOMANDA L'UTILIZZO DEI PROPRI OLI LUBRIFICANTI PER OTTIMIZZARE LE PRESTAZIONI ED ALLUNGARE LA DURATA DELL'UTENSILE

REF.14534 REF.14560

PAGINA 161



53733 238,00€

1.30 5 10 280

CHIAVE ESAGONALE PNEUMATICA ANGOLARE AD URTO DA 1/2"



650Nm

8500 RPM
8500 RPM 350Nm
8500 RPM 650Nm
X4 SPEED

MAX 650 NM
27-231 Nm
1/2"
1/4"

113 L/min
90PSI 4CFM
LIGHT
88mm

REF.	DESCRIZIONE					€
14633	KIT DI RIPARAZIONE PER UTENSILI PNEUMATICI - 53733	0.03	-	20		22,50€

54340 296,00€

1.30 - 5 -

N

AVVITATORE AD IMPULSI ARTICOLATO 1/2"



813 Nm

8000 RPM
MAX 813 NM
1/2"

1/4"
210 L/min
4m/seg

X6 SPEED

90 PSI
8 CFM
6,2 BAR
92 dB

REF.	DESCRIZIONE					€
16341	KIT DI RIPARAZIONE PER UTENSILI PNEUMATICI - 54340	0.07	-	15		32,50€

54397 249,00€

1.30 5 10 -

N

AVVITATORE AD IMPULSI AD ARIA DA 1/2"



1004Nm

7500 RPM
MAX 1004 NM
1/2"
1/4"

6.3 BAR
90 PSI
8.4 CFM
764(m/s²)

92,9 dB(Lp)
103,9 dB(Lw)
96 L/min

141mm
85mm
64mm

REF.	DESCRIZIONE					€
16564	KIT DI RIPARAZIONE PER UTENSILI PNEUMATICI - 54397	0.10	-	20		17,00€

53689 238,00€

2.10 5 10 160

AVVITATORE PNEUMATICO DA 1/2" (1950NM) - COMPOSITE



COMPOSITE 1950Nm

8600 RPM
MAX 1950 NM
95-936 Nm
1/2"

169mm
1/4"
X4 SPEED

90PSI 4CFM

REF.	DESCRIZIONE					€
14618	KIT DI RIPARAZIONE PER UTENSILI PNEUMATICI - 53689	0.01	-	20		19,00€

UTENSILI PNEUMATICI

53608

98,00€

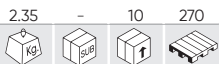

AVVITATORE PNEUMATICO DA 1/2" 1200NM

1200Nm

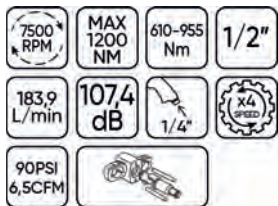

REF.	DESCRIZIONE	kg	box	€
14583	KIT DI RIPARAZIONE PER UTENSILI PNEUMATICI - 53608	0.01	20	6,00€

53726

128,00€



AVVITATORE PNEUMATICO DA 1/2" 1650NM

1650Nm

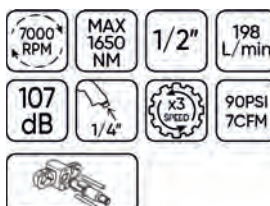

REF.	DESCRIZIONE	kg	box	€
15564	KIT DI RIPARAZIONE PER UTENSILI PNEUMATICI - 53726	0.05	-	11,90€

51212

488,00€



AVVITATORE PNEUMATICO DA 3/4" COMPOSITE

2034Nm

COMPOSITE



REF.	DESCRIZIONE	kg	box	€
14122	KIT DI RIPARAZIONE PER UTENSILI PNEUMATICI - 51210 / 51212	1.12	50	34,00€

51211

560,00€



AVVITATORE PNEUMATICO DA 1" COMPOSITE

2034Nm

COMPOSITE

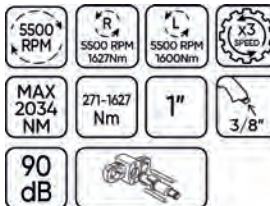

REF.	DESCRIZIONE	kg	box	€
14123	KIT DI RIPARAZIONE PER UTENSILI PNEUMATICI - 51211/51213	1.16	20	33,00€

51210

650,00€



AVVITATORE PNEUMATICO DA 3/4" CON PROLUNGA DI 15CM COMPOSITE

2034Nm

COMPOSITE

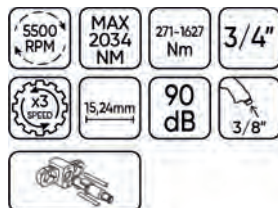

REF.	DESCRIZIONE	kg	box	€
14122	KIT DI RIPARAZIONE PER UTENSILI PNEUMATICI - 51210 / 51212	1.12	50	34,00€

51213

690,00€



AVVITATORE PNEUMATICO DA 1" CON PROLUNGA DI 19CM COMPOSITE

2034Nm

COMPOSITE

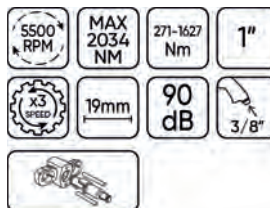

REF.	DESCRIZIONE	kg	box	€
14123	KIT DI RIPARAZIONE PER UTENSILI PNEUMATICI - 51211/51213	1.16	20	33,00€

53681 743,00€

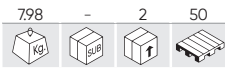

AVVITATORE PNEUMATICO AD ARIA PER VEICOLI PESANTI 1" ULTRA LEGGERO



2441Nm



REF.	DESCRIZIONE				€
14336	KIT DI RIPARAZIONE PER UTENSILI PNEUMATICI - 53681	1.17	10	10	58,00€

52814 528,00€

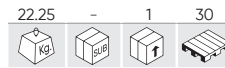

AVVITATORE PNEUMATICO PER CAMION 1" 3260NM



3260Nm



REF.	DESCRIZIONE				€
14153	KIT DI RIPARAZIONE PER UTENSILI PNEUMATICI - 52814	0.05	-	15	20,50€

53343 285,00€

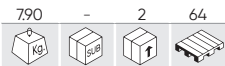

AVVITATORE PNEUMATICO DA 3/4"

1600Nm



51222 128,00€



AVVITATORE PNEUMATICO DA 1/2" DOPPIO BLISTER

101Nm



REF.	DESCRIZIONE				€
14131	KIT DI RIPARAZIONE PER UTENSILI PNEUMATICI - 51222	0.01	-	10	24,00€

52156 140,00€



VALIGETTA DA 16 PEZZI PNEUMATICI CON CRICCHETTO E AVVITATORE

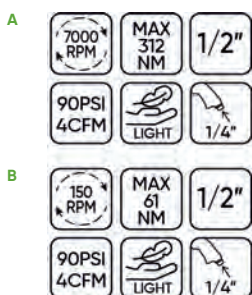

x10 9, 10, 11, 13, 14, 17, 19, 22, 24, 27mm

52165 118,00€



AVVITATORE PNEUMATICO DA 1/2 "

680Nm



54336

259,00€



N

CRICCHETTO PNEUMATICO ARTICOLATO 1/2".

95Nm



REF. DESCRIZIONE

16273 KIT DI RIPARAZIONE PER UTENSILI PNEUMATICI - 54336

0.15 - 15 12,50€

51214

148,00€

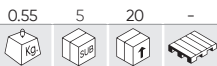

CRICCHETTO MINI DA 1/4" COMPOSITE

40,7Nm

COMPOSITE



REF. DESCRIZIONE

14124 KIT DI RIPARAZIONE PER UTENSILI PNEUMATICI - 51214 0.25 - 10 20,50€

51215

119,00€

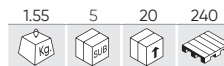

CRICCHETTO DA 1/2"

14-68Nm



REF. DESCRIZIONE

14125 KIT DI RIPARAZIONE PER UTENSILI PNEUMATICI - 51215 0.03 - 10 19,50€

52167

48,00€

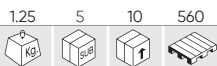

CRICCHETTO PNEUMATICO DA 1/2 "

61Nm



REF. DESCRIZIONE

14779 KIT DI RIPARAZIONE PER UTENSILI PNEUMATICI - 52167 0.05 - 10 33,00€

53784

148,00€

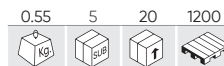

CRICCHETTO MINI DA 1/2" COMPOSITE

40,8Nm

COMPOSITE



REF. DESCRIZIONE

14779 KIT DI RIPARAZIONE PER UTENSILI PNEUMATICI - 53784 0.05 - 10 33,00€

51221 199,00€

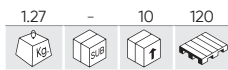

TRAPANO AD ANGOLO DI 90°



REF.	DESCRIZIONE	kg	SUB	€
14130	KIT DI RIPARAZIONE PER UTENSILI PNEUMATICI - 51221	0.40	- 10	21,00€

51220 240,00€

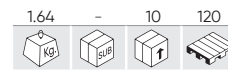

TRAPANO REVERSIBILE COMPOSITE

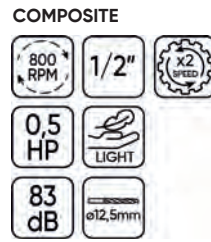

REF.	DESCRIZIONE	kg	SUB	€
14129	KIT DI RIPARAZIONE PER UTENSILI PNEUMATICI - 51220	0.01	- 10	12,50€

53573 36,00€

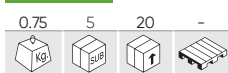

TRAPANO PNEUMATICO DRITTO DA 3/8"



52159 64,00€

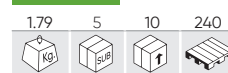

TRAPANO REVERSIBILE PNEUMATICO DA 1/2"



52527 82,00€



TRAPANO PNEUMATICO 3/8" AD ANGOLO DI 90°



52160 48,00€

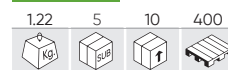

TRAPANO REVERSIBILE PNEUMATICO DA 3/8"



STACCAPUNTI PER PUNTI DI SALDATURA CON SCORRIMENTO DELLA PUNTA CENTRALE

52724 381,00€



REF.	DESCRIZIONE	kg	SUB	€
13817	TRAPANO PER 52725- 6,5MM	0.10	- 500	17,00€

52725 349,00€



REF.	DESCRIZIONE	kg	SUB	€
13818	TRAPANO PER 52725- 8MM	0.10	- 500	20,50€

52718

48,00€



MARTELLI PNEUMATICI 9 PEZZI



- A 21mm
- B 1,8mm
- C 21mm
- D 21mm



52953

38,00€

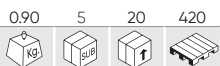

SMERIGLIATRICE PNEUMATICA 3"



REF.	DESCRIZIONE	kg	Sub	Unit	€
12987	DISCO DA TAGLIO 3" PER (52953)	0.02	50	500	1,50€

53140

98,00€

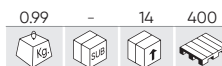

SMERIGLIATRICE PNEUMATICA



REF.	DESCRIZIONE	kg	Sub	Unit	€
14013	DISCO DI RICAMBIO PER RIF. 53140	0.01	-	1000	3,50€

53541

168,00€

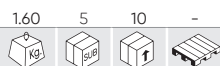

CESOIA PNEUMATICA PER METALLO



REF.	DESCRIZIONE	kg	Sub	Unit	€
14136	KIT DI RIPARAZIONE PER UTENSILI PNEUMATICI - 53541	0.01	-	5	12,00€

52574

69,00€



SEGA PNEUMATICI



REF.	DESCRIZIONE	kg	Sub	Unit	€
11956	SET DI 5 LAME A 24 DENTI PER LEGNO	0.03	10	300	5,50€
11957	SET DI 5 LAME A 32 DENTI PER FERRO	0.01	10	250	5,50€

51216

650,00€

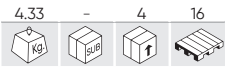

KIT LUCIDATRICE



ACCESSORI

REF.	DESCRIZIONE				€
51388	SPAZZOLA DI 23M PER REF. 51216	0.10	100	800	22,00€
51389	SPAZZOLA DA 11 MM ANGULO PER 51216	0.05	1	800	22,00€
51390	SPAZZOLA FINE DA 23 MM PER 51216	0.05	100	800	22,00€
51391	SPAZZOLA FINE DI 11 MM PER 51216	0.04	1	800	22,00€
51392	SPAZZOLA TOGLIVERNICE PER 51216	0.20	100	800	34,00€
51393	SPAZZOLA TOGLIVERNICE ALL'ACQUA PER 51216	0.10	50	800	34,00€
51439	ADATTATORE RUOTA 23MM	0.10	100	800	26,00€
51440	ADATTATORE RUOTA 11MM	0.10	1	800	28,00€
51441	ADATTATORE RUOTA NERA DOPPIA	0.10	1	800	26,00€
51442	ADATTATORE RUOTA NERA SIMPLE	0.10	50	800	28,00€
REF.	DESCRIZIONE				€
14126	KIT DI RIPARAZIONE PER UTENSILI PNEUMATICI - 51216	0.01	-	10	54,00€

CONTIENE

Diversi tipi di teste (per la preparazione di superfici metalliche)
 11 mm Spazzola metallica (fine)
 23 mm Spazzola metallica (fine)
 11 mm Spazzola metallica (grossa)
 23 mm Spazzola metallica (grossa)
 Eliminatore di gomma
 Eliminatore di vernici a base acquosa
 Adattatore da 23 mm per eliminatore di gomma e spazzola metallica
 Adattatore da 11 mm per spazzola metallica
 Lucidatore nero di caucciù (sino a 6 pezzi)
 Adattatore unico di lucidatore di caucciù
 Adattatore a doppia striscia di caucciù

53576

189,00€

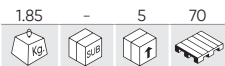

3" KIT PER MINI LUCIDATRICE PNEUMATICA



REF.	DESCRIZIONE				€
A	14162 TAMPONE IN LANA PER LUCIDARE PER RIF. 53576	0.05	-	50	25,50€
B	14163 TAMPONE IN SPUGNA MORBIDA PER RIF. 53576 - BIANCO	0.50	5	50	25,50€
C	14164 TAMPONE IN SPUGNA DURA PER RIF. 53576 - GIALLO	0.50	5	50	25,50€
D	14330 DISCO VELCRO PER ARTICOLO 53576	0.01	5	50	3,50€
14154	KIT DI RIPARAZIONE PER UTENSILI PNEUMATICI - 53576	0.05	-	10	42,00€

53646

69,00€

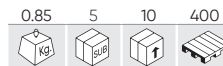

3" KIT PER LUCIDATRICE PNEUMATICA



REF.	DESCRIZIONE				€
A	14286 TAMPONE IN SPUGNA MORBIDA PER RIF. 53646	0.01	10	200	2,99€
B	14287 TAMPONE IN SPUGNA DURA PER RIF. 53646	0.00	10	200	2,99€
C	14288 TAMPONE IN LANA PER LUCIDARE PER RIF. 53646	0.01	10	200	6,00€
D	14289 DISCO VELCRO PER ARTICOLO 53646	0.04	-	200	6,10€

53626

18,00€

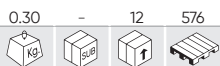

KIT DI RIPRISTINO FANALI

14 PCS



IN ESPOSITORE DA 12 UNITÀ

CONTIENE

	x2 P800 dischi abrasivi		x1 85gm pasta lucidante
	x2 P1200 dischi abrasivi		x1 Nastro adesivo
	x2 P2000 dischi abrasivi		x1 Disco per lucidare la lana
	x2 3.0ml liquido protezione uv		x1 Disco di spugna bianco
	x2 Adattatore (3/8" & 1/4")		



SERIE262

199,00€



KIT SPECIALE LUCIDATRICE: 3" LUCIDATRICE NEUMATICA + 12X KIT RIPRISTINO

53626

53646



x12u.



x1u.



52676

98,00€

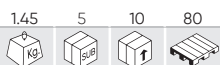

LEVIGATRICE ORBITALE AUTO-ASPIRANTE



- Corpo in alluminio con finitura di gomma.
- Eccellente rendimento di pulizia con borsa e tubo.



52675

84,00€



LEVIGATRICE ORBITALE CON ASPIRAZIONE



52758

88,00€



LEVIGATRICE ORBITALE CON ASPIRAZIONE



51226

233,00€

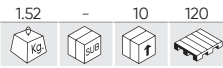

KIT LEVIGATRICE ORBITALE

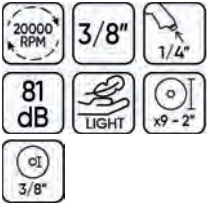

REF. DESCRIZIONE

REF.	DESCRIZIONE	kg	sub	unit	€
14133	KIT DI RIPARAZIONE PER UTENSILI PNEUMATICI - 51226	0.01	-	10	16,50€

52157

48,00€

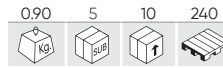

KIT DA 16 PEZZI CON SMERIGLIATRICE PNEUMATICA



51245

99,00€

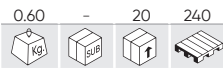

MINI SMERIGLIATRICE DA 3/8" 6MM



REF. DESCRIZIONE

REF.	DESCRIZIONE	kg	sub	unit	€
14135	KIT DI RIPARAZIONE PER UTENSILI PNEUMATICI - 51245	0.01	-	10	12,50€

52171

39,00€

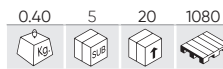

MINI SMERIGLIATRICE PNEUMATICA 1/4"

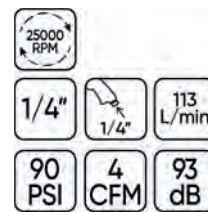

53141

68,00€

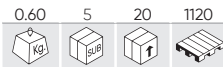

SMERIGLIATRICE PNEUMATICA ANGOLARE DI 1/4"



52528

49,00€

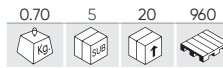

LEVIGATRICE ANGOLARE PNEUMATICA



53137

38,00€

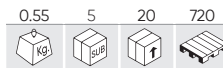

MINI SMERIGLIATRICE



51218

288,00€

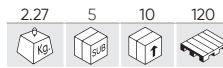

SMERIGLIATRICE ORBITALE COMPOSITE

COMPOSITE



REF. DESCRIZIONE

REF.	DESCRIZIONE	kg	sub	unit	€
14127	KIT DI RIPARAZIONE PER UTENSILI PNEUMATICI - 51218	0.01	-	10	32,50€

UTENSILI PNEUMATICI

54255

68,00€



SET DI ACCESSORI PER PISTOLA INGRASSATRICE

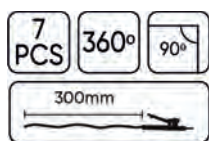

50751

43,00€



INGRASSATORE PNEUMATICO

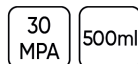

52490

6,65€



PISTOLA AD ARIA COMPRESSA 100MM

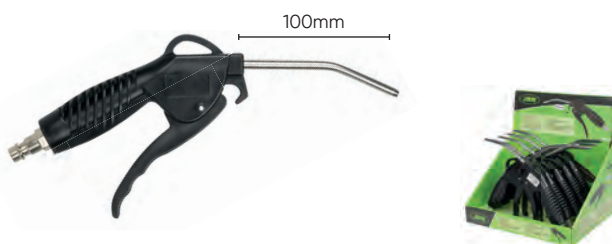

IN ESPOSITORE DA 10 UNITÀ

52491

10,50€



PISTOLA AD ARIA COMPRESSA 300MM

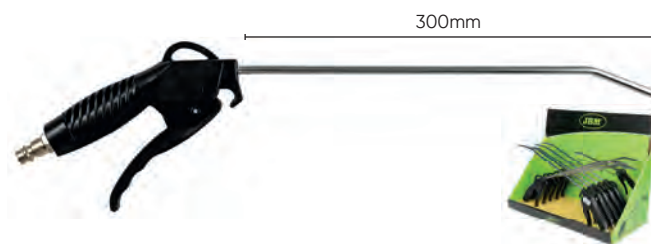

IN ESPOSITORE DA 10 UNITÀ

53611

27,50€



PISTOLA AD ARIA EXTRALUNGA



GROSSO FLUSSO

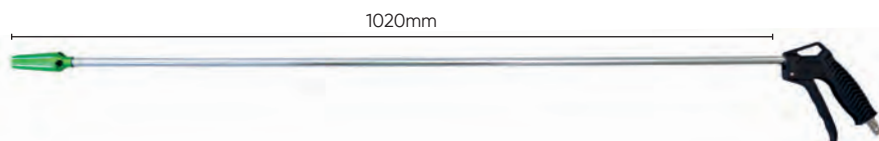

52798

18,00€

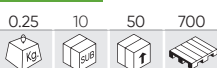

PISTOLA AD ARIA COMPRESSA

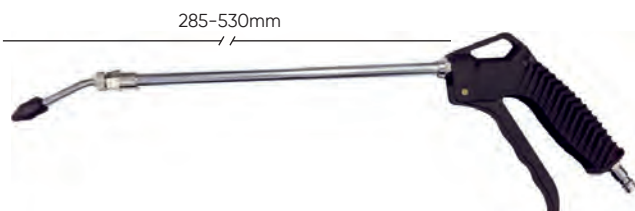

PUNTA GOMMATA PER EVITARE DI GRAFFIARE

51980

15,00€



PISTOLA GONFIAPNEUMATICI



51981 21,50€

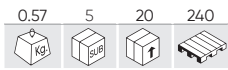

PISTOLA SOFFIAGGIO ARIA + PISTOLA GONFIAPNEUMATICI



51277 64,00€

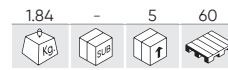

SET DI STRUMENTI PNEUMATICI



52787 9,00€

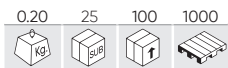

PISTOLA DI SOFFIAGGIO



51383 11,10€

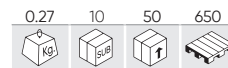

PISTOLA SOFFIAGGIO ARIA IN BLISTER

- Pistola soffiaggio aria.
- Attacco rapido europeo.
- Attacco per tubo.
- Prolunga del tubo di 10cm.
- Prolunga del tubo di 20cm.



IN ESPOSITORE DA 10 UNITÀ



54251 43,00€

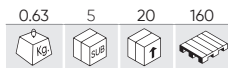

PISTOLA AD ASPIRAZIONE E SOFFIO

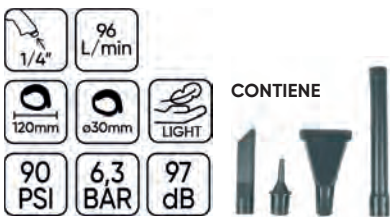

53205 19,00€

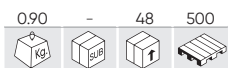

PISTOLA DI SOFFIAGGIO



52381 20,50€

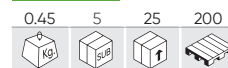

PISTOLA AD ARIA COMPRESSA + TUBO SPIRALATO DA 3/8" LUNGHEZZA 5M

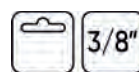

GROSSO FLUSSO

- Pistola di soffiaggio.
- Materiale: lega di alluminio.
- Superficie: nichelato.

54248

58,00€

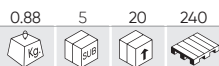

PISTOLA AD ARIA

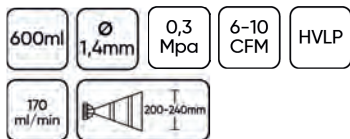

RICAMBI DISPONIBILI

54249

103,00€

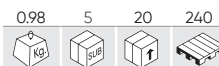

PISTOLA AD ARIA PROFESSIONALE

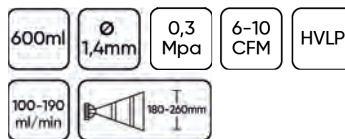

RICAMBI DISPONIBILI

53606

55,00€

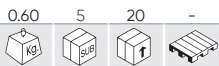

PISTOLA ASCIUGATRICE PNEUMATICA



VALVOLA DI REGOLAZIONE DELL'ARIA



53449

16,40€

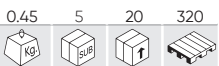

POMPA PNEUMATICA CON MANOMETRO ANALOGICO

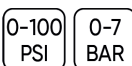

53450

28,30€

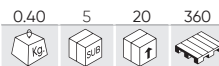

POMPA PNEUMATICA CON MANOMETRO DIGITALE

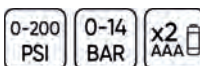

52648

9,00€



TESTER DI PRESSIONE PNEUMATICI



4,3 BAR

53416

14,10€



MANOMETRO CON TUBO FLESSIBILE PER GOMME (0-10BAR)



0-10 BAR

53417

26,30€



MANOMETRO DIGITALE CON TUBO FLESSIBILE PER GOMME (0-15BAR)

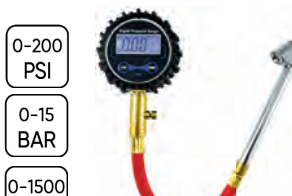

0-200 PSI
0-15 BAR
0-1500 KPA

53418

16,90€



MANOMETRO DIGITALE PER GOMME (0-15 BAR)

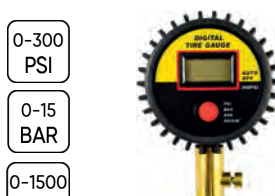

0-300 PSI
0-15 BAR
0-1500 KPA

51861

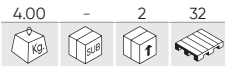

199,00€



UTENSILE PNEUMATICO PER IL MONTAGGIO DI SOFFIETTI SEMIASSE

- Materiale: Alluminio.
- Apertura da 20 a 100mm.

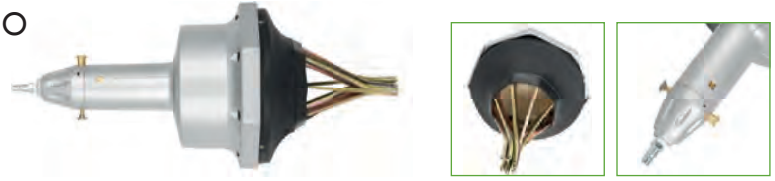

53542

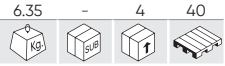

980,00€

STALLONATORE PNEUMATICO



REF. DESCRIZIONE

14137 KIT DI RIPARAZIONE PER UTENSILI PNEUMATICI - 53542

Icona	Q	€
	0,65	
	5	
	5	131,00€

52540

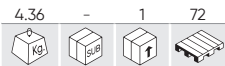

221,00€

TIRABOLLI A VUOTO D'ASPIRAZIONE

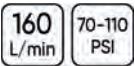

52331

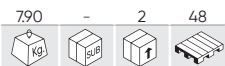

201,00€

KIT PISTOLA + CRIC PNEUMATICO + ACC 68 PEZZI

PISTOLA PNEUMATICA + MARTELLO PNEUMATICO + CRICHELLO PNEUMATICO + MINI LUCIDATRICE + PISTOLA ARIA + PISTOLA ARIA DRIITA + ACCESSORI



UTENSILI PNEUMATICI

52543

182,00€



PISTOLA DI PULIZIA FILTRO ANTIPARTICOLATO

- Universale.
- Capacità massima: 650cc.
- Tubo flessibile in nylon 4x6x2.7m.
- Portata: 3 bar - 7 bar.
- Corpo inossidabile, alta resistenza + base in alluminio.



REF.	DESCRIZIONE	Kg	SUB	Q	€	
90003	LIQUIDO DECARBONIZZANTE	1.08	-	12	400	35,20€
90004	LIQUIDO NEUTRALIZZANTE	0.50	-	12	320	25,80€

53625

68,00€



SCROSTATORE AD AGHI PNEUMATICO



REF.	DESCRIZIONE	Kg	SUB	Q	€
14188	AGO PER RIF. 53625	0.01	50	500	0,50€

53593

41,00€



PISTOLA SABBIAATRICE PNEUMATICA

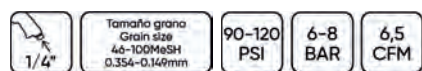

CONTIENE

- 1x pistola levigatrice.
- 1x raccogliore di sabbia.
- 2 contenitore da sabbia da 850 g.
- 4x tappi: per sabbatura, per sabbatura superficiale, per sabbatura angolare esterna, per sabbatura di angoli interni.

REF.	DESCRIZIONE	Kg	SUB	Q	€
14168	BOTTIGLIA CON SABBIA (PER RIF. 53593)	0.95	-	20	7,00€

53202

15,70€



PISTOLA PER LAVAGGIO MOTORI



- Pistola per lavaggio motori.
- Materiale: Acciaio.
- Materiale corpo: lega di alluminio.
- Superficie: verniciatura a polvere.

53204

81,00€



PISTOLA DI PULIZIA AD ARIA, COLOR NERO



- Pistola di pulizia ad aria, nera.
- Materiale: PE.
- Materiale corpo: lega di alluminio.
- Superficie corporea: Lucido.

52575

119,00€

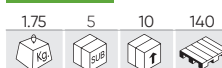

RIVETTATRICE PNEUMATICA

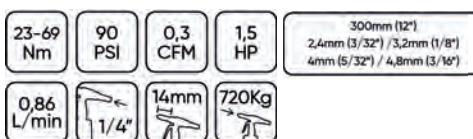

53567

43,00€

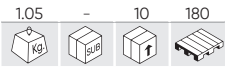

PISTOLA PER SIGILLANTE PNEUMATICA



- Pressione di esercizio: 2,5-5 BAR.
- Presa d'aria: 1/4".
- Capacità della cartuccia: 310ml.

52533

10,00€

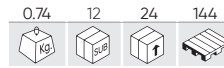

PISTOLA PER SILICONE 300ML



53572

348,00€

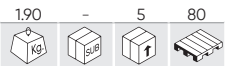

SMERIGLIATRICE PNEUMATICA PER VALVOLE - PERCUSSIONE E ROTAZIONE

CONTIENE

- 1x lappatrice per valvole del motore pneumatico.
- 5 ventose (16, 20, 30, 35 e 40 mm).
- 5 adattatori per stelo valvola.
- 1x chiave a brugola da 3mm.



REF.	mm	Kg	SUB	€
14157	16	0.01	- 50	8,30€
14158	20	0.01	- 50	9,95€
14159	30	0.01	- 50	12,60€
14160	35	0.01	- 50	12,80€
14161	40	0.10	- 50	13,70€



54033

49,00€

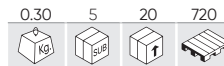

STRUMENTO PER CHIUDERE LE VALVOLE PER LA PERFORAZIONE

- Diametro della ventosa: 16, 20, 30, 35, 40 mm
- Diametro dell'asse: 8 mm
- Lunghezza: 128 mm
- Frequenza massima d'esercizio di rotazione: 1250 giri/min



REF.	mm	Kg	SUB	€
14157	16	0.01	- 50	8,30€
14158	20	0.01	- 50	9,95€
14159	30	0.01	- 50	12,60€
14160	35	0.01	- 50	12,80€
14161	40	0.10	- 50	13,70€



14534

16,50€

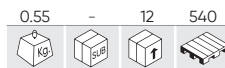

OLIO PER UTENSILE PNEUMATICO - 600ML

- Densità relativa a 15 °C: 0,845.
- Viscosità: 12,1 cSt a 40°C.
- Colore: incolore.



14560

8,80€

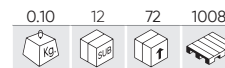

OLIO PER UTENSILE PNEUMATICO - 100ML

- Densità relativa a 15 °C: 0,845.
- Viscosità: 12,1 cSt a 40°C.
- Colore: incolore.





PLATORELLI DI TAGLIO

REF.	DESCRIZIONE					€
51385	PLATORELLI DI TAGLIO PER REF. 51219 DA 4"X1/32"	0.01	10	300	800	4,55€
51387	PLATORELLI DI TAGLIO DA 3"	0.03	10	300	800	3,25€



PLATORELLI ABRASIVI

REF.	DESCRIZIONE					€
51386	PLATORELLI ABRASIVO DA 5" DA REF. 51218	0.10	-	25	800	5,95€
51443	PLATORELLI ABRASIVO #60 PER REF. 51226	0.50	25	150	800	5,50€
51444	PLATORELLI ABRASIVO DA #80 PER REF. 51226	0.02	-	25	800	5,05€
51445	PLATORELLI ABRASIVO DA #120 PER REF. 51226	0.02	-	25	800	5,05€



PLATORELLI PER LEVIGATRICI

REF.	DESCRIZIONE					€
13499	PLATORELLI DI 15 FORI PER LEVIGATRICI	0.10	-	50	1500	12,50€
13500	PLATORELLI PER LEVIGATRICI CON 66 FORI	0.65	5	50	-	12,90€
12009	PLATORELLI DI 6 FORI PER LEVIGATRICI	0.14	-	50	-	11,00€



FILTRO DELL'OLIO CON REGOLATORE

REF.	"					€
53063	1/4"	0.60	5	50	300	36,70€
53064	3/8"	0.63	5	50	300	37,40€
53065	1/2"	0.60	5	50	300	36,90€

FILTRO D'ARIA, REGOLATORE E LUBRIFICATORE

REF.	"					€
53066	1/4"	1.08	5	25	250	61,00€
53067	3/8"	0.50	5	25	250	61,00€
53068	1/2"	1.00	5	25	250	63,00€



53492

380,00€

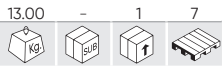

ESPOSITORE DI UTENSILI PNEUMATICI

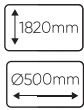

NON INCLUDE UTENSILI



52378

10,00€

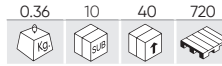

GANCIO MAGNETICO



51341

35,00€

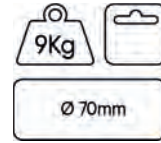

53147

41,00€

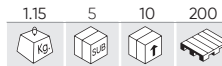

ESPOSITORE DI UTENSILI PNEUMATICI



NON INCLUDE UTENSILI

53594

54,00€

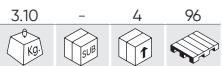

TUBO FLESSIBILE PER ARIA, 8MM - 25 M



HYBRID POLYMER
POLÍMERO HÍBRIDO

- Pressione di lavoro: 300PSI / 20bar
- Pressione di rottura: 950PSI / 65bar
- Temperatura di lavoro: -40°C / 65°C

- Grande flessibilità.
- Ritorna alla sua forma originale.
- Superficie liscia, non danneggia la vernice.
- Molto resistente.

Diametro interno: 8mm
Diametro esterno: 13mm

Da usare con:
REF. 52736 (M8)



53595

61,00€



TUBO FLESSIBILE PER ARIA, 10MM - 25 M



HYBRID POLYMER
POLÍMERO HÍBRIDO

- Pressione di lavoro: 300PSI / 20bar
- Pressione di rottura: 950PSI / 65bar
- Temperatura di lavoro: -40°C / 65°C

- Grande flessibilità.
- Ritorna alla sua forma originale.
- Superficie liscia, non danneggia la vernice.
- Molto resistente.

Diametro interno: 10mm
Diametro esterno: 15mm

Da usare con:
REF. 52737 (M10)







REF. DESCRIZIONE

14169 KIT DI 10 COLLARI DI SERRAGGIO DA 8-16 MM

0.10 - 125 - 3,00€

UTENSILI PNEUMATICI

TUBO FLESSIBILE A SPIRALE PER ARIA

REF.	m			"					€
53629	10m	8mm	5mm	1/4"	0.55	-	6	360	14,30€
53630	15m	8mm	5mm	1/4"	0.65	-	6	240	18,80€
53631	15m	12mm	8mm	1/4"	1.25	-	6	120	33,50€
53632	15m	15mm	10mm	1/4"	2.20	-	6	78	46,00€
53633	15m	15mm	10mm	3/8"	2.10	-	6	78	46,00€
53634	15m	18mm	13mm	1/2"	2.60	-	6	66	63,00€



CON ESTREMITÀ GIREVOLI A 360 GRADI PER UN FACILE SPOSTAMENTO E FACILITÀ D'USO

- MATERIALE DEL TUBO FLESSIBILE: PU.
- SUPERFICIE FILETTATA: OTTONE.

AVVOLGITUBO DELL'ARIA



CON RIPARTITORE



STAFFA A MURO INCLUSA

14772 8,50€

0.35	-	20	-
			

REF. 53582 / REF. 53583







STAFFA A MURO INCLUSA

14771 10,50€

0.35	-	30	-
			

REF. 53532 / REF. 53581

20+2m

REF.	m	"					€
53582	22m	3/8"	10.85	-	1	14	174,00€
53583	22m	3/8"	10.75	-	1	14	174,00€







12+1m

REF.	m	"					€
53532	13m	3/8"	6.60	-	2	30	119,00€
53581	13m	3/8"	6.70	-	2	30	119,00€



10+1,5m

REF.	m	"					€
53881	11,5m	1/4"	4.50	-	4	48	79,00€
53882	11,5m	1/4"	4.50	-	4	48	79,00€



RACCORDO PER TUBI FLESSIBILI

REF.	DESCRIZIONE					€
14204	EUR - M6 M 1/4"	0.06	50	200	-	1,50€
14205	EUR - M8 M 3/8"	0.06	50	200	-	1,50€
14206	EUR - M10 M 1/2"	0.05	50	200	-	1,50€
14207	US - M6 M 1/4"	0.05	50	200	-	1,50€
14208	US - M8 M 3/8"	0.06	50	200	-	1,50€
14209	US - M10 M 1/2"	0.05	50	200	-	1,50€



RACCORDO RAPIDO DI SICUREZZA PER TUBI FLESSIBILI

REF.	DESCRIZIONE					€
14201	M6	0.10	25	100	-	4,00€
14202	M8	0.10	25	100	-	4,00€
14203	M10	0.10	25	100	-	4,50€



RACCORDO RAPIDO / FILETTO

REF.	DESCRIZIONE				€
13930	RACCORDO RAPIDO MASCHIO USA - FILETTO MASCHIO DA 1/4"	0.01	50	100	1,50€
13932	RACCORDO RAPIDO MASCHIO USA - FILETTO MASCHIO DA 3/8"	0.10	50	100	2,50€
14076	RACCORDO RAPIDO MASCHIO USA - FILETTO FEMMINA DA 3/8"	0.10	50	100	1,50€
13933	RACCORDO RAPIDO MASCHIO USA - FILETTO MASCHIO DA 1/2"	0.10	50	100	2,00€
13935	RACCORDO RAPIDO MASCHIO USA - FILETTO FEMMINA DA 1/4" (2 PZ.)	0.05	50	100	2,50€
13936	RACCORDO RAPIDO FEMMINA USA - FILETTO FEMMINA DA 1/4"	0.05	50	100	3,50€
13937	RACCORDO RAPIDO FEMMINA USA - FILETTO MASCHIO DA 1/4"	0.05	50	100	4,00€
14078	RACCORDO RAPIDO FEMMINA USA - FILETTO FEMMINA DA 3/8"	0.10	50	100	4,00€
14191	RACCORDO RAPIDO MASCHIO USA - FILETTO FEMMINA DA 1/2"	0.05	50	100	2,00€
14193	RACCORDO RAPIDO FEMMINA USA - FILETTO FEMMINA DA 1/2"	0.10	50	100	4,00€

REF.	DESCRIZIONE				€
13931	RACCORDO RAPIDO MASCHIO EURO - FILETTO MASCHIO DA 1/4" (2 PZ.)	0.05	50	100	2,50€
14075	RACCORDO RAPIDO MASCHIO EURO - FILETTO FEMMINA DA 3/8"	0.10	50	100	2,00€
13934	RACCORDO RAPIDO MASCHIO EURO - FILETTO FEMMINA DA 1/4" (2 PZ.)	0.05	50	100	2,50€
13938	RACCORDO RAPIDO FEMMINA EURO - FILETTO FEMMINA DA 1/4"	0.10	50	200	3,50€
13939	RACCORDO RAPIDO FEMMINA EURO - FILETTO MASCHIO DA 1/4"	0.10	50	100	4,00€
14077	RACCORDO RAPIDO FEMMINA EURO - FILETTO FEMMINA DA 3/8"	0.10	50	100	4,50€
14190	RACCORDO RAPIDO MASCHIO EURO - FILETTO FEMMINA DA 1/2"	0.05	50	100	2,00€
14192	RACCORDO RAPIDO FEMMINA EURO - FILETTO FEMMINA DA 1/2"	0.10	50	100	4,00€



UTENSILI PNEUMATICI

RACCORDO RAPIDO DI SICUREZZA CON FISSATORE E FILETTATURA INTERNA

REF.	DESCRIZIONE					€
14195	F. INTERNA - F. MASCHIO DA 1/4"	0.50	25	100	-	4,00€
14196	F. INTERNA - F. MASCHIO DA 3/8"	0.10	25	100	-	4,00€
14197	F. INTERNA - F. MASCHIO DA 1/2"	0.10	25	100	-	4,50€
14198	F. INTERNA - F. FEMMINA DA 1/4"	0.10	25	100	-	4,00€
14199	F. INTERNA - F. FEMMINA DA 3/8"	0.10	25	100	-	4,00€
14200	F. INTERNA - F. FEMMINA DA 1/2"	0.10	25	100	-	4,50€



RACCORDO ARTICOLATO PER ARIA COMPRESSA - MASCHIO

REF.	DESCRIZIONE					€
14314	EUR 1/4"	0.06	25	100	-	5,00€
14315	US 1/4"	0.06	25	100	-	4,50€



14561

0.05	25	50	-
------	----	----	---



CONNETTORE LUBRIFICANTE 1/4"



8,80€



ATTACCO RAPIDO PNEUMATICO

REF.	DESCRIZIONE					€
52735	ATTACCO RAPIDO PNEUMATICO M6	0.05	25	200	4000	4,85€
52736	ATTACCO RAPIDO PNEUMATICO M8	0.10	25	200	4000	5,35€
52737	ATTACCO RAPIDO PNEUMATICO M10	0.10	25	200	4000	5,50€



ADATTATORE A SNODO

REF.	DESCRIZIONE					€
12988	ADATTATORE ARTICOLATO NEUMATICO DE 1/2"	0.15	62	125	-	12,00€
13809	ADATTATORE A SNODO 1/4"	0.10	62	250	-	18,50€
13810	ADATTATORE A SNODO 3/8"	0.10	62	250	-	20,50€



BUSSOLE PNEUMATICHE

- 168 SET DI BUSSOLE DI IMPATTO
- 173 UTENSILI PER RUOTE
- 174 ADATTATORI
- 176 RICAMBI BUSSOLE DI IMPATTO
- 177 UTENSILI PER CAMION



52694

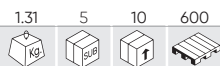

SET DI 3 BUSSOLE XZN PNEUMATICI 1/2"



CONTIENE

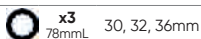

49,00€

52337



SET DI 3 BUSSOLE PNEUMATICHE 1/2" ESAGONALI

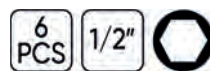

CONTIENE

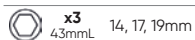
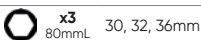

52547



SET DI 8 BUSSOLE E PUNTE XZN PNEUMATICHE DA 1/2"

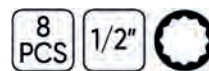

CONTIENE

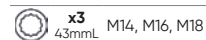
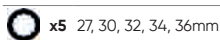

96,00€

52345



SET DI 14 BUSSOLE PNEUMATICHE DA 1/2" ESAGONALI CON ADATTATORE



10, 11, 12, 13, 14, 15, 16, 17, 18, 19, 21, 22, 24, 27mm



RICAMBI DISPONIBILI

REF.	mm				€
14728	10	0.10	5	20	3,80€
14729	11	0.05	10	100	3,80€
14730	12	0.05	10	100	3,80€
14731	13	0.10	5	20	3,80€
14732	14	0.10	5	20	3,80€
14970	15	0.08	5	20	2,50€
14971	16	0.07	5	20	2,50€

REF.	mm				€
11195	17	0.10	10	100	3,70€
14972	18	0.12	5	20	3,50€
11121	19	0.10	10	60	4,10€
14733	21	0.10	5	20	4,30€
14734	22	0.15	5	20	5,40€
11122	24	0.14	10	20	5,45€
11123	27	0.20	10	50	6,50€

REF.	DESCRIZIONE				€
12937	PROLUNGHE PNEUMATICHE 50MM 1/2"	0.11	10	100	9,50€
14973	PROLUNGHE PNEUMATICHE 150MM 1/2"	0.27	5	20	11,50€
12075	PROLUNGHE PNEUMATICHE 250MM 1/2"	0.45	10	50	15,50€
11962	ADATTATORE DE PNEUMATICHE 1/2" F 3/4" M	0.17	10	100	7,50€
11990	ARTICOLAZIONE UNIVERSALE PNEUMATICHE 1/2"	0.15	10	100	15,30€

109,00€

53531

109,00€



SET DI 14 BUSSOLE PNEUMATICHE DA 1/2" POLIGONALI CON ADATTATORE

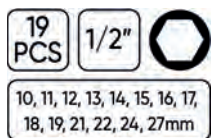

RICAMBI DISPONIBILI

REF.	DESCRIZIONE				€
12937	PROLUNGHE PNEUMATICHE 50MM 1/2"	0.11	10	100	9,50€
14973	PROLUNGHE PNEUMATICHE 150MM 1/2"	0.27	5	20	11,50€
12075	PROLUNGHE PNEUMATICHE 250MM 1/2"	0.45	10	50	15,50€

REF.	DESCRIZIONE				€
11962	ADATTATORE DE PNEUMATICHE 1/2" F 3/4" M	0.17	10	100	7,50€
11990	ARTICOLAZIONE UNIVERSALE PNEUMATICHE 1/2"	0.15	10	100	15,30€

52341

58,00€

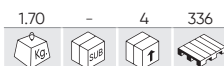

SET DI 13 BUSSOLE PNEUMATICHE DA 1/2" ESAGONALI + ADATTATORI



RICAMBI DISPONIBILI

REF.	mm				€
14728	10	0.10	5	20	3,80€
14729	11	0.05	10	100	3,80€
14730	12	0.05	10	100	3,80€
14731	13	0.10	5	20	3,80€
14732	14	0.10	5	20	3,80€

REF.	mm				€
11195	17	0.10	10	100	3,70€
11121	19	0.10	10	60	4,10€
14733	21	0.10	5	20	4,30€
14734	22	0.15	5	20	5,40€
11122	24	0.14	10	20	5,45€

REF.	DESCRIZIONE				€
14735	PORTAINSERI AD IMPATTO DA 1/2"	0.05	5	20	6,50€
12074	PROLUNGHE PNEUMATICHE 125MM 1/2"	0.23	10	60	11,50€
11990	ARTICOLAZIONE UNIVERSALE PNEUMATICHE 1/2"	0.15	10	100	15,30€

52346

103,00€



SET DI 12 BUSSOLE PNEUMATICHE LUNGHE DA 1/2" ESAGONALI



RICAMBI DISPONIBILI

REF.	mm				€
12061	10	0.14	10	100	9,50€
12062	12	0.15	10	100	9,50€
12063	13	0.15	10	50	9,50€
12064	15	0.17	10	100	9,00€
12065	16	0.30	10	20	9,00€
12066	17	0.20	10	100	9,00€

REF.	mm				€
12067	18	0.22	10	20	9,50€
12068	19	0.21	10	50	9,50€
12069	21	0.25	10	50	9,50€
12070	22	0.27	10	100	10,50€
12071	24	0.30	10	50	11,00€
12072	27	0.36	10	20	12,00€

REF.	DESCRIZIONE				€
12074	PROLUNGHE PNEUMATICHE 125MM 1/2"	0.23	10	60	11,50€
12075	PROLUNGHE PNEUMATICHE 250MM 1/2"	0.45	10	50	15,50€
11990	ARTICOLAZIONE UNIVERSALE PNEUMATICHE 1/2"	0.15	10	100	15,30€

53060

34,90€

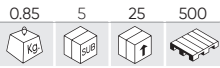

SET DI 12 BUSSOLE PNEUMATICHE DI 1/2" ESAGONALE PROFILO BASSO

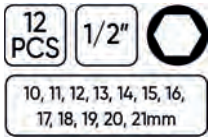

52342

63,00€

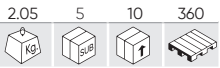

SET DI 11 BUSSOLE PNEUMATICHE 1/2" ESAGONALI

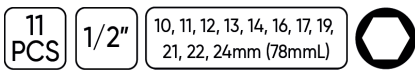

RICAMBI DISPONIBILI

REF.	mm				€
12061	10	0.14	10	100	9,50€
14736	11	0.15	5	20	5,00€
12062	12	0.15	10	100	9,50€
12063	13	0.15	10	50	9,50€
14737	14	0.15	5	20	5,00€
12065	16	0.30	10	20	9,00€

REF.	mm				€
12066	17	0.20	10	100	9,00€
12068	19	0.21	10	50	9,50€
12069	21	0.25	10	50	9,50€
12070	22	0.27	10	100	10,50€
12071	24	0.30	10	50	11,00€

53744

63,00€

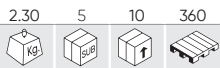

SET DI 11 PEZZI DI TESTE ALTE AD URTO POLIGONALI

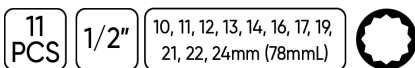

RICAMBI DISPONIBILI

REF.	mm				€
14738	10	0.15	10	100	5,50€
14739	11	0.15	10	100	5,50€
14740	12	0.16	10	100	5,55€
14741	13	0.15	10	100	5,55€
14742	14	0.15	10	100	5,55€
14743	16	0.14	10	100	5,15€

REF.	mm				€
14744	17	0.18	10	50	5,35€
14745	19	0.22	10	50	6,25€
14746	21	0.24	10	50	6,40€
14747	22	0.27	10	50	7,10€
14748	24	0.30	10	50	8,30€

52810

9,00€

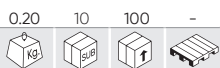

BUSSOLE PNEUMATICHE XZN ANTIMANOMISSIONE M16

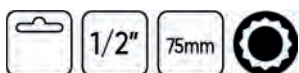

- Bussole 75 mm lunghe e quadrate di 1/2" per l'estrazione dell'avviatore per trasmissioni di veicoli VAG, Porsche, Ford...

52811

9,90€

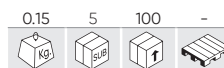

BUSSOLE PNEUMATICHE XZN ANTIMANOMISSIONE M18

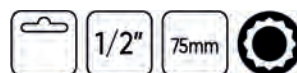

- Per estrarre il braccio di sterzo del veicolo di gruppo VAG.

52546

39,60€

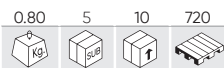

SET DI 6 BUSSOLE E PUNTE XZN PNEUMATICHE 1/2"

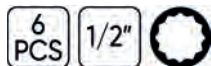

RICAMBI DISPONIBILI

REF.	43mmL	kg	SUB	QTY	€	REF.	78mmL	kg	SUB	QTY	€
12931	M14	0.08	10	200	7,50€	12934	M14	0.13	10	200	7,50€
12932	M16	0.08	10	200	7,50€	12935	M16	0.14	10	200	8,00€
12933	M18	0.09	10	200	8,00€	12936	M18	0.16	10	200	8,50€

52344

197,00€

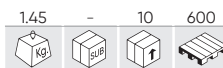

SET DI 13 INSERTI PNEUMATICI 1/2" ESAGONALI E TORX

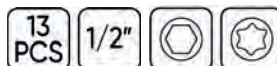

CONTIENE

- x5 45mmL 5, 6, 8, 10, 12mm
- x8 45mmL T30, T40, T45, T50, T55, T60, T70, T80

52339

61,00€



SET DI 8 PUNTE LUNGHE PNEUMATICHE ESAGONALI DA 1/2"



RICAMBI DISPONIBILI

REF.	mm	kg	SUB	QTY	€	REF.	mm	kg	SUB	QTY	€
14004	5	0.30	10	240	9,50€	14008	10	0.11	10	240	9,50€
14005	6	0.09	10	120	10,50€	14009	12	0.12	10	240	9,50€
14006	7	0.09	10	240	9,50€	14010	14	0.14	10	120	11,00€
14007	8	0.10	10	240	9,50€	14011	17	0.18	10	60	11,00€

52340

58,00€



SET DI 8 PUNTE LUNGHE PNEUMATICHE DA 1/2" TORX



RICAMBI DISPONIBILI

REF.	mm	kg	SUB	QTY	€	REF.	mm	kg	SUB	QTY	€
12938	T25	0.08	10	50	10,00€	12942	T50	0.10	10	60	10,00€
12939	T30	0.10	10	50	10,00€	12943	T55	0.10	10	50	10,00€
12940	T40	0.10	10	50	10,00€	12944	T60	0.12	10	50	10,00€
12941	T45	0.09	10	50	10,00€	12945	T70	0.15	10	50	10,50€

53470

176,00€

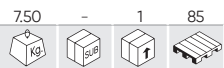

SET DI 8 BUSSOLE ESAGONALI LUNGHE 3/4"

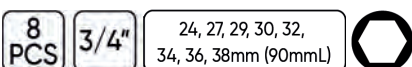

52347

158,00€

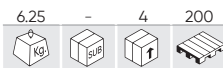

SET DI 8 BUSSOLE PNEUMATICHE ESAGONALI 3/4"

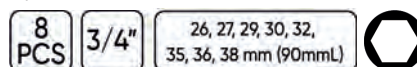

51028

163,00€



SET DI 16 BUSSOLE PNEUMATICHE

16 PCS 3/4"

RICAMBI DISPONIBILI

REF.	mm				€
14723	H17	0.35	-	10	18,00€
14724	T60	0.30	-	10	18,50€
14725	T70	0.30	-	10	18,50€
14726	T80	10.80	-	10	17,50€

	3/4"	x4	E18, E20, E22, E24
	3/4"	x5	T60, T70, T80, T90, T100
	3/4"	x4	H17, H19, H22, H24
		x2	1 - 3/4"
		x1	4mm



54316

182,00€



N

SET DI 8 BUSSOLE D'IMPATTO 1" LUNGHE

8 PCS 1"



x6	90mmL	24, 27, 30, 32, 33, 36mm
x2	95mmL	38, 41mm



RICAMBI DISPONIBILI

REF.	mm				€
16304	24	0.60	6	24	31,00€
16305	27	0.70	6	24	31,00€
16571	30	0.77	6	24	32,00€
16572	32	0.95	6	24	33,50€
16574	33	0.94	-	-	34,00€
16575	36	1.00	6	24	34,50€
16576	38	1.25	6	24	35,50€
16577	41	1.32	6	24	36,00€

52348

179,00€



SET DI 8 BUSSOLE PNEUMATICHE ESAGONALI 1"

8 PCS 1"



x2	58mmL	24, 27mm
x3	62mmL	30, 32, 33mm
x2	65mmL	36, 38mm
x1	68mmL	41mm



RICAMBI DISPONIBILI

REF.	mm				€
13859	24	0.50	6	24	16,00€
13874	27	0.60	6	72	17,50€
13875	30	0.50	6	18	18,50€
13876	32	0.60	6	24	18,50€
13877	33	0.60	6	96	18,50€
11153	36	0.70	6	18	23,40€
11155	38	0.90	6	12	24,40€
11158	41	0.95	6	18	28,50€

52969

20,70€



SET DI 3 BUSSOLE PNEUMATICHE LUNGHE ESAGONALI

3 PCS 1/2"

17, 19, 21mm (78mmL)

RICAMBI DISPONIBILI

REF.	mm				€
12066	17	0.20	10	100	9,00€
12068	19	0.21	10	50	9,50€
12069	21	0.25	10	50	9,50€



53587

44,00€

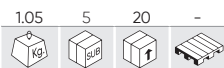

SET DI 4 BUSSOLE PER CERCHI IN LEGA LEGGERA, DA 1/2"



RICAMBI DISPONIBILI

REF.	mm	mm	mm	mm	Kg	SUB	mm	€
14172	15mm	85mmL	SMART	0.20	10	50	8,50€	
14173	17mm	85mmL	MERCEDES-BENZ	0.20	10	50	9,50€	
14177	22mm	85mmL	OPEL	0.25	10	50	9,50€	
14178	21mm	85mmL	HYUNDAI / KIA	0.25	10	50	9,50€	

52338

41,00€

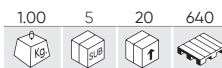

SET DI 4 BUSSOLE PNEUMATICHE DA 1/2" LUNGHE RIVESTITE



RICAMBI DISPONIBILI

REF.	mm	Kg	SUB	mm	€
11314	17	0.22	10	100	8,50€
11315	19	0.25	10	100	8,50€
11316	21	0.26	10	100	8,50€
11628	22	0.27	10	50	9,50€



51336

29,30€



SET DI 3 BUSSOLE PNEUMATICHE 1/2"



RICAMBI DISPONIBILI

REF.	mm	Kg	SUB	mm	€
11314	17	0.22	10	100	8,50€
11315	19	0.25	10	100	8,50€
11316	21	0.26	10	100	8,50€

52343

52,00€



SET DI 12 BUSSOLE PNEUMATICHE ESAGONALI 1/2"

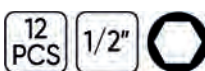

CONTIENE

x3	85mmL	17, 19, 21mm
	x1	42mmL 27mm
x8	38mmL	10, 11, 13, 14, 17, 19, 22, 24mm

53988

101,00€



SET DI 10 BUSSOLE PNEUMATICHE 1/2"



CONTIENE

A	1/2"	15mm	F	1/2"	23mm
B	1/2"	17mm	G	1/2"	24mm
C	1/2"	19mm	H	7/8"	TESLA
D	1/2"	21mm	I	17mm	MERCEDES
E	1/2"	22mm	J	21mm	HYUNDAI / KIA



53197

46,00€



SET DI 4 BUSSOLE DI IMPATTO PER VITI DI SICUREZZA



CONTIENE

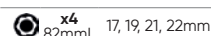

53077

62,00€



SET PROLUNGHE LIMITATRICI DI COPPIA



RICAMBI DISPONIBILI

	REF.	Nm					€
A	13688	100	0.22	-	-	1500	15,50€
B	13687	110	0.22	5	50	-	15,50€
C	13686	120	0.23	5	50	1000	15,50€
D	13685	135	0.25	5	50	1500	15,50€
E	13684	150	0.28	-	50	-	15,50€



POTREBBE INTERESSARTI ANCHE...

	REF.	Nm					€
F	13680	200	0.36	50	50	-	15,50€
G	13681	190	0.35	-	50	-	15,50€
H	13682	175	0.32	-	50	-	15,50€
I	13683	160	0.30	-	50	-	15,50€
J	13689	90	0.20	5	50	1500	15,50€



PROLUNGHE PNEUMATICHE

REF.	mm	"					€
12937	50	1/2"	0.11	10	100	1500	9,50€
12074	125	1/2"	0.23	10	60	-	11,50€
12075	250	1/2"	0.45	10	50	-	15,50€

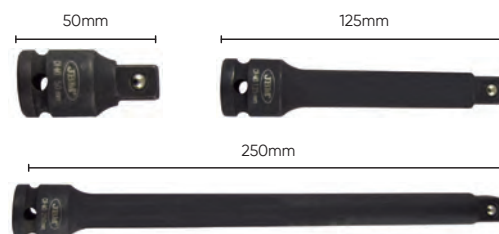

ARTICOLAZIONI UNIVERSALI PNEUMATICHE

REF.	"					€
11938	3/4"	0.62	10	50	-	47,00€
11990	1/2"	0.15	10	100	-	15,30€



53043

53,00€

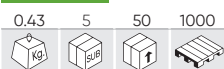

SET DI 3 BUSSOLE PNEUMATICHE CON DOPPIA POSIZIONE (FISSO/ARTICOLATO)



53044

121,00€



SET DI 8 BUSSOLE PNEUMATICHE ESAGONALI CON DOPPIA POSIZIONE (FISSO/ARTICOLATO)

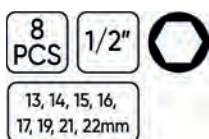

52545

177,00€



SET DI 2 ADATTATORI PNEUMATICI

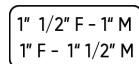

53743

39,70€



SET DI 6 TESTE AD URTO



RICAMBI DISPONIBILI

REF.	mm				€
14749	1/4"H - 3/8"M	0.03	20	200	2,00€
14750	3/8"H - 1/4"M	0.05	20	100	2,00€
14751	3/8"H - 1/2"M	0.15	20	100	4,00€
14752	1/2"H - 3/8"M	0.16	10	100	4,00€
11962	1/2"H - 3/4"M	0.17	10	100	7,50€
11964	3/4"H - 1/2"M	0.35	10	100	12,50€



52544

93,00€



SET DI 6 ADATTATORI PNEUMATICI



RICAMBI DISPONIBILI

REF.	mm				€
11962	1/2"H - 3/4"M	0.17	10	100	7,50€
11963	1/2"H - 1"M	0.25	6	54	9,00€
11964	3/4"H - 1/2"M	0.35	10	100	12,50€
11965	3/4"H - 1"M	0.45	6	48	16,00€
11966	1"H - 1/2"M	0.54	6	36	18,00€
11967	1"H - 3/4"M	0.56	4	36	18,00€



52914 223,00€

2.90 - 4 500

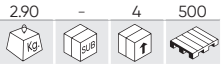

BUSSOLA PER COPRIMOZZI DI RIMORCHI BPW 120MM DR.41MM



52915 199,00€

2.90 - 8 1500

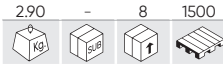

BUSSOLA DADI RUOTA RIMORCHI BPW 111MM DR41MM



52916 218,00€

2.57 - 6 1000

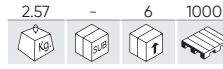

BUSSOLA DADI RUOTA RIMORCHI BPW 109MM DR.41MM



52917 122,00€

1.05 - 10 1000

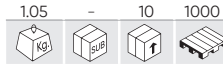

BUSSOLA ASSI POSTERIORI RIMORCHI BPW 65MM



52918 146,00€

2.05 - 8 1500

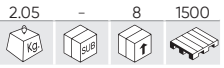

BUSSOLA PER COPRIMOZZI POSTERIORI ASSI RIMORCHI BPW 95MM



52919 181,00€

2.65 - 8 1500



BUSSOLA DADI RUOTA RIMORCHI BPW 110MM 3/4"



52920 155,00€

1.35 - 10 1000



BUSSOLA ESTRAZIONE CUSCINETTI ASSE RIMORCHIO BPW 80MM 3/4"



52921 117,00€

0.73 - 10 500



BUSSOLA ESTRAZIONE DADO ASSE POSTERIORE BPW 65MM 3/4"



52922 180,00€

2.10 - 10 1000

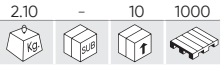

BUSSOLA PER DADI CUSCINETTI ASSE BPW 85MM 3/4"



52923 59,00€

0.55 - 12 1500

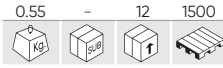

BUSSOLA PER DADI SOSPENSIONI SCANIA 28X37MM 3/4"



52924 52,00€

0.75 - 24 1500



BUSSOLA PER ASSE SOSPENSIONE SCANIA 34X46MM 3/4"



52925 176,00€

1.80 - 10 1500

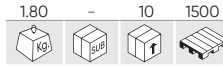

BUSSOLA ROUTA ANTERIORE SCANIA 80MM H41



52926 201,00€

2.75 - 8 1500

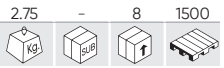

BUSSOLA PER DADO RUOTA SCANIA 100MM 3/4" 8 FACCE



52927 59,00€

0.78 - 20 1000



BUSSOLA PER DADO SULLA BALESTRA MEZZI SCANIA 34X56MM 3/4"



52928 172,00€

1.90 - 10 1500

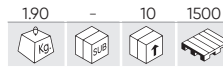

BUSSOLA MOZZO SCANIA 80MM 3/4" 8 FACCE



52929 185,00€

2.68 - 6 1500

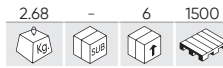

BUSSOLA DADO RUOTA SCANIA 95MM 3/4" 8 FACCE



BUSSOLE PNEUMATICHE

52930 117,00€



UTENSILE PER FACILITARE L'INSTALLAZIONE DEL PARAOLIO POSTERIORE ALBERO MOTORE SCANIA



SCANIA 310/320
PARAOLIO 0366303-R

52931 45,00€

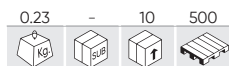

BUSSOLA MEZZI SCANIA PER FAR RUOTARE L'ALBERO DI DISTRIBUZIONE 1/2"



QUADRATO 1/2"

52932 45,00€

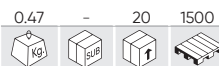

BUSSOLA PER VOLVOLA DI INNEZIONE ELETTROMAGNETICA SCANIA 38MM 1/2 "



Ø38mm
QUADRATO 1/2"

52933 194,00€



BUSSOLA PER MOZZI SCANIA 420



Ø11,6mm - Ø10mm
8 SETTORI
QUADRATO 3/4"
SCANIA 420

53430 286,00€



BUSSOLE BOCCOLA PER IVECO



Ø134mm - Ø110,5mm
118x134mm
IVECO
12 FACCE

52935 94,00€



BUSSOLA PER MOZZI PRIGIONIERI MEZZI MERCEDES / MAN 60MM



60mm
QUADRATO 3/4"

52936 199,00€



BUSSOLA PER MOZZI PRIGIONIERI MEZZI MERCEDES / MAN 80-95MM



80-95mm
QUADRATO 3/4"
6 SETTORI

52937 265,00€



BUSSOLA PER MOZZI MEZZI MERCEDES / MAN 95-115MM



95-115mm
QUADRATO 3/4"
6 SETTORI

52938 199,00€



BUSSOLA PER DADO BRACCIO DELLO SPERZO MEZZI MERCEDES / MAN H60 3/4"



100mm
QUADRATO 3/4"
6 SETTORI

52939 28,00€

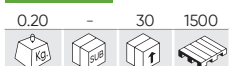

BUSSOLA RIMOZIONE VALVOLA INIEZIONE MEZZI MAN / MERCEDES / SCANIA



22-28mm
QUADRATO 1/2"
4 SETTORI

52940 235,00€



BUSSOLA MEZZI MERCEDES / MAN PER DADO DEL DIFFERENZIALE POSTERIORE



101mm
QUADRATO 3/4"
6 SETTORI

52941 70,00€



UTENSILE PER FAR GIRALE IL MOTORE TRAMITE L'INGRANAGGIO DI AVVIAMENTO



QUADRATO 1/2"

52942 105,00€



UTENSILE PER FAR GIRALE IL MOTORE TRAMITE L'INGRANAGGIO DI AVVIAMENTO PER MOTORI MERCEDES / MAN 3 IN



QUADRATO 1/2"

52943 75,00€



UTENSILE PER FAR GIRARE IL MOTORE TRAMITE L'INGRANAGGIO DI AVVIAMENTO SU MOTORI MAN



QUADRATO 1/2"

52934 102,00€

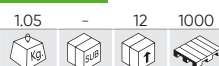

BUSSOLA PER MOZZI PRIGIONIERI MEZZI MERCEDES / MAN 56MM 3/4"



56mm
QUADRATO 3/4"

REF.	mm			€
52944	30	1.00	20	110,00€
52945	39	2.74	24	281,00€

ESTRATTORE PER NODI SFERICI MEZZI PESANTI E VEICOLI COMMERCIALI



52944
QUADRATO ESAGONALE
19mm

52945
QUADRATO ESAGONALE
26mm

CARROZZERIA

- 180 PER CARROZZIERE
- 183 RESTAURO FANALI
- 185 SOSTITUZIONE PARABREZZA
- 186 RIPARAZIONE DEL TELAIO
- 188 MOBILIARIO AUSILIARIO
- 191 MANUTENZIONE INTERNA

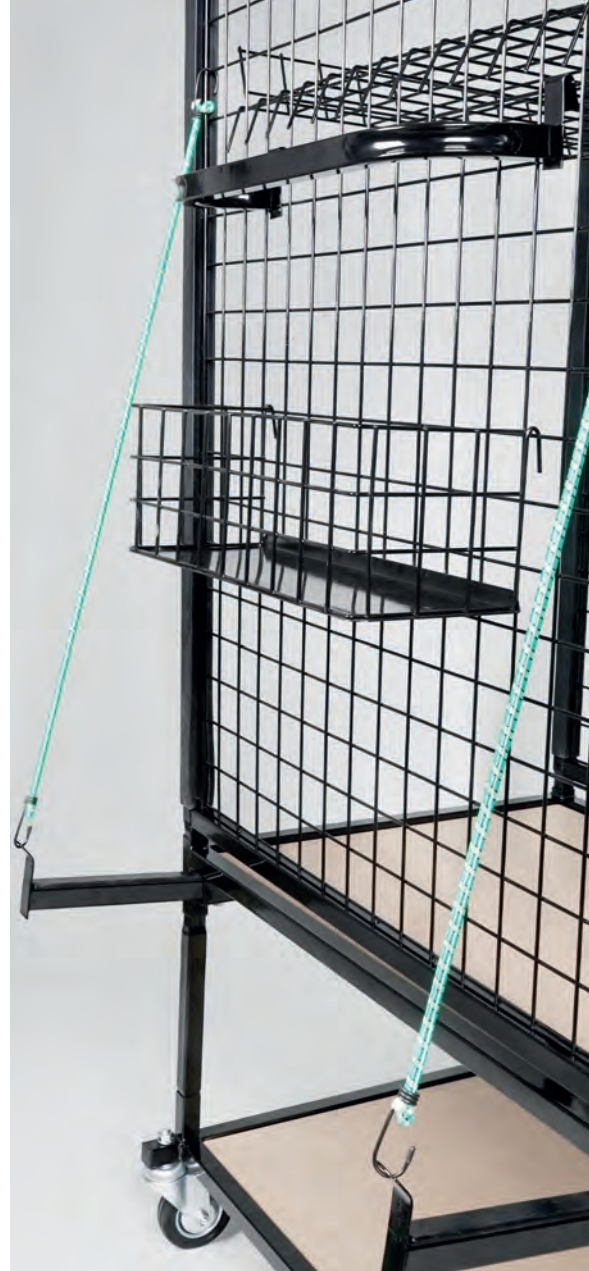

CARROZZERIA

53224

142,00€

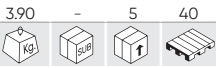

SET DI ATTREZZI RIPARA AMMACCATURE

32 PCS AUDI

RICAMBI DISPONIBILI

REF. DESCRIZIONE					€
13842 SET DI 5 DISCHI BLU (RIF. 53224)	0.15	10	100	-	8,50€
13843 SET DI 5 DISCHI GIALLI (RIF. 53224)	0.01	10	100	-	7,00€
13844 SET DI 10 DISCHI ROSSI (RIF. 53224)	0.05	10	50	-	9,00€
13845 SET DI 5 STICK DI COLLA (RIF. 53224)	0.02	10	100	-	8,00€



52876

182,00€

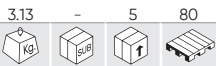

SET DI TASSI RIVESTITI IN PLASTICA 7 PEZZI

RICAMBI DISPONIBILI

REF. DESCRIZIONE					€
A 12955 TASSO A INCUDINE	0.28	-	25	99	27,80€
B 12956 TASSO A ROTAIA	0.31	-	25	99	27,80€
C 12957 TASSO CURVO	0.37	5	25	99	27,80€
D 12958 TASSO CUNEO	0.41	-	25	-	27,80€
E 12959 TASSO A VIRGOLA	0.30	5	25	99	27,80€
F 12960 TASSO A TACCO BOMBATO	0.18	-	25	1500	27,80€
G 12961 TASSO A VIRGOLA CON MANICO	0.34	-	25	-	27,80€



51131

61,00€

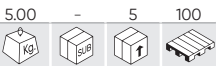

SET DI MARTELLI SPECIALI DA CARROZZIERE

RICAMBI DISPONIBILI

REF. DESCRIZIONE					€
A 11541 MARTELLO A TESTA PIATTA	0.43	5	25	-	11,00€
B 11542 MARTELLO PIATTO PICCOLO	0.38	5	25	-	11,00€
C 11543 MARTELLO PIATTO CONICO	0.42	5	25	-	11,00€
D 11544 TASSELLO	0.69	5	25	-	7,00€
E 11545 TASSELLO AD ALETTA	0.79	5	25	-	11,00€
F 11546 TASSELLO A DUE LATI SMUSSI	0.81	5	25	-	12,00€
G 11547 TASSELLO CUNEO A 8 O A SLITTA	0.81	5	25	-	12,00€



53545

35,70€

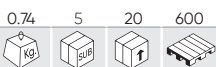

5 BUSSOLE ESAGONALI DA 3/8" - EXTRA LUNGHE



8, 10, 12, 13, 14mm (120mmL)

51832

18,00€

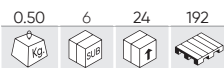

SET DI 4 LEVE DI NYLON A LAMA



19mm x 273mm
22mm x 273mm
25mm x 273mm
38mm x 273mm



50903

30,80€



SET DI 5 LEVE DI METALLO



60, 43, 38,
28, 18cm



52026

31,80€

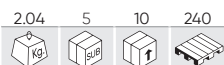

SET DI DUE LEVE DI METALLO

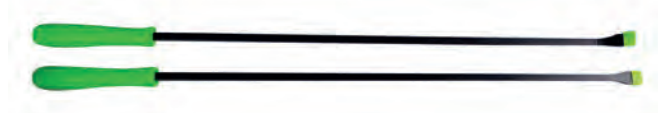

51360

8,05€



LEVA EUROPEA CON GANCIO 18"X5/8

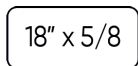

51361

9,80€



LEVA EUROPEA CON GANCIO 24" X 3/4

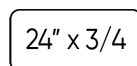

52851

9,65€



SET DI 2 LEVE

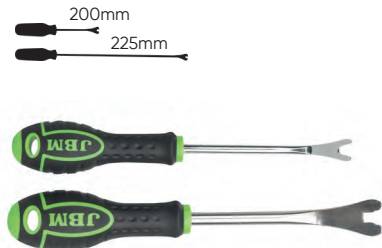

53110

27,30€



SET DI 6 LEVE



5"x8.5mm
5"x10.3mm
5"x4.5mm
15"x8.5mm
15"x10.3mm
15"x4.5mm

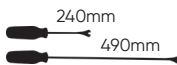

50901

16,00€

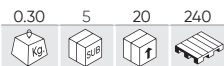

SET DI 5 LEVE DI NYLON



UNIVERSAL
60x160mm
63x175mm
30x200mm
20x180mm
20x215mm



52788

39,00€

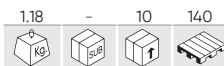

SET DI 27 LEVE DI NYLON



CARROZZERIA

52977

137,00€

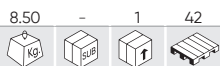

SET DI 4 LEVE EXTRALUNGHE



52540

221,00€



TIRABOLLI A VUOTO D'ASPIRAZIONE

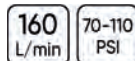

54017

12,00€



STRUMENTO PER CALAFATAGGIO IN SILICONE



CINQUE COPRIGIUNTI IN SILICONE INTERCAMBIABILI:
3R, 6R, 10R, 13R, 17R



52533

10,00€



PISTOLA PER SILICONE 300ML

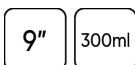

53525

12,00€



MORSETTO DI BLOCCAGGIO PER PISTONCINI COFANO E BAGAGLIAIO



- Diametro massimo di apertura: 10mm.

53655

12,00€



CHIAVE VAG PER RIMOZIONE MANIGLIE PER PORTE



54246

104,00€



BILANCIA DI PRECISIONE 5KG

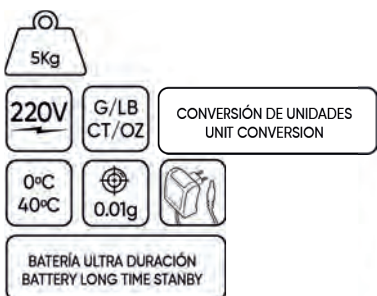

54247

99,00€



BILANCIA DI PRECISIONE 2KG

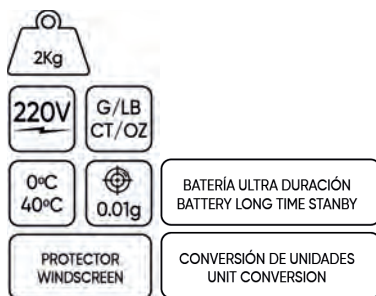

53230

19,70€

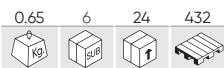

SET DI UTENSILI PER APRIRE L'AUTO



52077

29,50€



SET DI 4 CUSCINETTI GONFIABILI

40-50mm

CONTIENE
Cuscinetto da 16x16cm
Cuscinetto da 32x12cm
Cuscinetto da 19x6cm
Cuscinetto da 18x4,5cm
Pompa manuale

- Pressione massima supportata: 100 Kg.



53486

29,30€



SPECCHIO PER L'ISPEZIONE DELLE AMMACCATURE

Ø 800mm

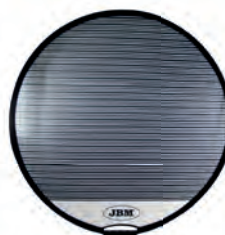

53673

80,00€

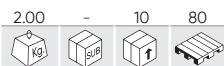

KIT DI RIPRISTINO FANALI

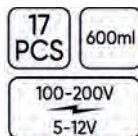

RICAMBI DISPONIBILI

REF.	DESCRIZIONE	kg	Sub	Unit	€
A	14564 SET DI 6 TELE SMERIGLIATE PER RIF. 53673	0.10	10	100	9,20€
B	14565 ADATTATORE PER CONVERSIONE DELLA CORRENTE ALTERNATA IN CORRENTE CONTINUA (RIF. 53673)	0.20	10	50	26,70€
C	14566 ADATTATORE 12V PER RIF. 53673	0.05	10	100	16,70€
D	14567 TAZZA PER EVAPORAZIONE PER RIF. 53673	0.15	10	20	38,00€
E	14568 COPERCHIO CURVO CON ANELLO DI TENUTA IN GOMMA PER RIF. 53673	0.01	10	200	9,20€
F	14569 COPERCHIO PIATTO CON ANELLO DI TENUTA IN GOMMA PER RIF. 53673	0.00	10	200	9,20€
G	14570 IMBUTO PER RIF. 53673	0.01	10	200	4,05€
H	14571 PIASTRA DI LAPPATURA PER RIF. 53673	0.05	-	10	9,20€
I	14573 CARTA STRUTTURATA PER RIF. 53673	0.01	10	100	4,05€
J	15375 RECIPIENTE CON LIQUIDO PER RIF. 53673	0.80	4	24	28,00€

15375

28,00€

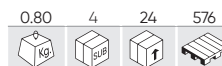

RECIPIENTE CON LIQUIDO PER RIF. 53673

Il kit del polimero liquido per la riparazione dei fari è un sistema innovativo per ripristinare i fari schiariti alle loro condizioni primari con una brillantezza originale e un aspetto perfetto.



UFI: 9600-WOPH-M003-4PRX

BRILLANTEZZA ORIGINALE E UN ASPETTO PERFETTO

SET DI 10 CARTE VETRATE

REF.	DESCRIZIONE	kg	Sub	Unit	€	REF.	DESCRIZIONE	kg	Sub	Unit	€
14710	GRANA 180	0.25	10	100	3,50€	14713	GRANA 600	0.15	10	100	4,25€
14711	GRANA 280	0.20	10	100	3,75€	14714	GRANA 800	0.15	10	100	4,50€
14712	GRANA 360	0.20	10	100	4,00€	14715	GRANA 1200	0.10	10	100	4,75€



VIDEO TUTORIAL

52740

690,00€

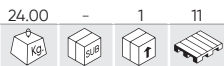

ALLINEATORE PER FARI CON MISURATORE DI LUCE DA 152CM



ALOGENO / XENON / LED

- Distanza di misurazione: 50 cm.
- Facile misurazione della deviazione dall'asse ottico dei fari di marcia diurna e dei fari anabbaglianti.
- Guide di spostamento laterale opzionali.
- Anche per camion.

52836

1.100,00€

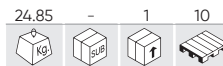

ALLINEATORE DI FARI DOPPIO LASER



ALOGENO / XENON / LED

- Anche per camion.

DOPPIO LASER
LUX METER DIGITALE
REGOLAMENTO SCHERMATA DI VERIFICA

53626

18,00€



KIT DI RIPRISTINO FANALI



CONTIENE

- | | | | |
|--|--------------------------------|--|-------------------------------|
| | x2 P800 Dischi abrasivi | | x1 85gm Pasta lucidante |
| | x2 P1200 Dischi abrasivi | | x1 Nastro adesivo |
| | x2 P2000 Dischi abrasivi | | x1 Disco per lucidare la lana |
| | x2 3.0ml Liquido protezione UV | | x1 Disco di spugna bianco |
| | x2 Adattatore (3/8" & 1/4") | | |

IN ESPOSITORE DA 12 UNITÀ



SERIE262

199,00€

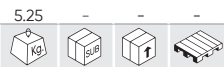

KIT SPECIALE LUCIDATRICE: 3" LUCIDATRICE NEUMATICA + 12X KIT RIPRISTINO

53626

x12u.



53646

x1u.



53729

19,10€

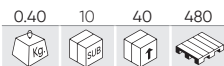

KIT STRUMENTI PER REGOLARE I FARI

H6, H7, T25



300mm



52262

7,50€

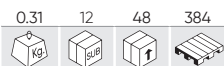

VENTOSA SINGOLA Ø 115MM

40Kg
ø 115mm



52263

13,50€

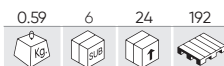

VENTOSA DOPPIA Ø 115MM

70Kg
ø 115mm



52264

18,60€

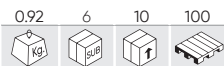

VENTOSA TRIPLA Ø 115MM

100Kg
ø 115mm



52265

30,50€

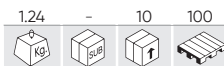

VENTOSA QUADRUPLA Ø 115MM

120Kg
ø 115mm



52295

6,50€

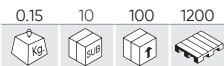

KIT DA 2 MINI VENTOSE Ø 60MM

5Kg
ø 60mm



52765

21,70€

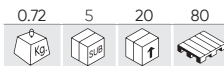

VENTOSA DOPPIA SNODATA Ø 120MM

80Kg
ø 120mm



52998

48,00€

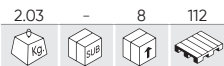

KIT DA 2 VENTOSE E CRICCHETTO 5M X 25MM

80Kg
ø 120mm
5x25mm



53232

39,00€

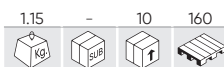

STRUMENTI PER SOSTITUZIONE DI CRISTALLI

7
PCS

CONTIENE
1x utile estrattore di stampi.
1x leva per rimuovere la gomma.
1x gancio di estrazione.
1x filo da taglio 1.8m.
2x manici per tagliare il filo.
1x percorso del cavo.



13813

7,00€



CAVO PER LA RIMOZIONE DEI TERGICRISTALLI

PER REF. 53232



13814

11,00€

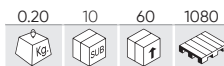

MANIGLIE PER LA RIMOZIONE DEI TERGICRISTALLI

PER REF. 53232



CARROZZERIA

52321 8,80€

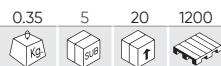

CINGHIA CON TENDITORE 5M X 25MM

5mx25mm



52327 12,00€



CINGHIA DI SOSTEGNO CON TENDITORE 8M X 25MM

8mx25mm



50577 12,60€

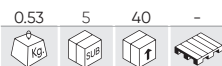

PINZA A SCATTO

CrV
280mm



52386 23,60€

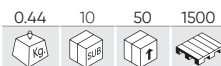

PINZA A SCATTO BECCO A PAPPAGALLO - BECCO LISO

CrMo
215mm



52385



SET DI 6 PINZE AUTOBLOCCANTE

251,00€



PINZA AUTOBLOCCANTE CON GANASCE

REF.	DESCRIZIONE							€	
53675	PINZA AUTOBLOCCANTE CON GANASCE DRITTE	10"	250mm	70mm	0.75	10	20	300	50,00€
53676	PINZA AUTOBLOCCANTE CON GANASCE CURVE	10"	250mm	90mm	0.85	10	20	300	44,00€
53677	PINZA AUTOBLOCCANTE CON GANASCE A COLLO DI CIGNO OSCILLANTI	10"	250mm	80mm	0.90	10	20	300	55,00€
53678	PINZA AUTOBLOCCANTE CON GANASCE CURVE LUNGHE	10"	300mm	105mm	0.90	10	20	300	52,00€



IN ESPOSITORE DA 10 UNITÀ

52982







KIT DI 3 PINZE AUTOBLOCCANTE SUPERLUNGHE

53,00€

3 PCS
37cm 36cm 34cm



PINZE AUTOBLOCCANTE CON GANASCE

REF.	DESCRIZIONE	mm	MATERIALE		T					€
52390	PINZA AUTOBLOCCANTE	250mm	CrMo	-	-	0.50	5	40	640	35,20€
52474	MORSETTO AD ANELLO 5T	190mm	Acciaio	0-20mm	5T	3.49	-	5	1500	68,00€
52475	MORSETTO AD ANELLO ALLUNGATO 3T	170mm	Acciaio	0-25mm	3T	3.60	-	10	1500	62,00€
52476	MORSETTO AD ANELLO 5T	220mm	Acciaio	0-25mm	5T	3.10	-	10	1500	50,00€
52477	MORSETTO AGGANCIATO A PINZA 2T	200mm	Acciaio	0-60mm	2T	2.65	-	6	1500	70,00€
52478	MORSETTO AGGANCIATO A 90° 5T	170mm	Acciaio	0-20mm	5T	2.90	-	10	1500	49,00€
52479	MORSETTO AGGANCIATO A 90° 3T	155mm	Acciaio	0-20mm	3T	1.18	-	30	1500	24,70€
52480	MINI MORSETTO AGGANCIATO A 2 VIE 3T	210mm	Acciaio	0-25mm	3T	2.00	-	10	1500	44,00€
52481	MORSETTO AGGANCIATO QUADRATO 3T	220mm	Acciaio	0-20mm	3T	2.05	-	10	1500	52,00€
52482	MORSETTO AGGANCIATO PIANO ANGOLO 45° 5T	210mm	Acciaio	0-10mm	5T	2.13	-	8	1500	44,00€
52483	MORSETTO AGGANCIATO PIANO MINI 5T	210mm	Acciaio	0-10mm	5T	2.02	-	12	1500	41,00€
52484	GANCI TIPO GAP 3T	275mm	Acciaio	0-110mm	3T	1.19	-	11	1500	66,00€
52485	GANCI AD UNCINO 4T	270mm	Acciaio	0-90mm	4T	1.17	-	30	1000	51,00€
52486	GANCI UNCINO + GAP 3T	280mm	Acciaio	0-110mm	3T	1.21	-	11	1500	62,00€
52487	MORSETTO A PINZA 5T	220mm	Acciaio	0-20mm	5T	2.27	-	7	1000	63,00€
52502	PINZA A SCATTO PER SALDATURA	280mm	CrMo	0-110mm	-	0.84	10	30	540	31,40€
52503	PINZA A SCATTO PER SALDATURA PRESA PIANA	280mm	CrMo	0-105mm	-	0.85	10	30	540	32,50€
52504	PINZA A SCATTO DOPPIA PRESA 9"	225mm	CrMo	0-50mm	-	1.14	-	30	480	27,60€
52505	PINZA A SCATTO PRESA PIANA	170mm	CrMo	0-40mm	-	0.27	36	72	2160	20,80€
52506	PINZA A SCATTO CON PRESA PIANA	170mm	CrMo	0-50mm	-	0.28	36	72	2160	16,00€
52507	PINZA A SCATTO PRESA PIANA	250mm	CrMo	0-80mm	-	0.77	5	30	420	30,10€
52511	PINZA A SCATTO PER SALDATURA 18"	440mm	CrMo	0-225mm	-	1.31	-	20	280	42,00€
52512	PINZA A SCATTO PER SALDATURA CON PRESA PIANA	440mm	CrMo	0-210mm	-	1.31	-	20	280	50,00€



53983

215,00€

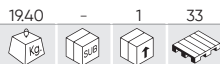

PORTA PARTI - PARABREZZA E GUSCIO



12 ASTE DA 630 MM RIVESTITE DI POLIETILENE ESPANSO (EPE)

FINO A 5 GRANDI PANNELLI O VETRI

RULLI POLIURETANICI (PU) DA 4 X 4 POLLICI (DUE GIREVOLI CON FRENO)

53125

477,00€

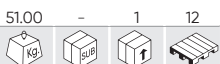

CARRELLO PER CONSERVAZIONE DEI COMPONENTI



x4 INCLUSO

53124

287,00€



DIMENSIONI ALTEZZA

MAX: 1320mm
MIN: 840mm

DIMENSIONI LUNGHEZZA

MAX: 1380mm
MIN: 225mm



50923

454,00€



CARRELLO TRASPORTATORE SPECIALE LAMIERA



- Separazione da 0 a 110cm.

REF.	DESCRIZIONE	KG	UNITA'	CM	€
12022	RUOTA DI RICAMBIO PER 50923	194	-	10 1500	33,70€



53080 99,00€



CAVALLETTO PER VETRI AUTO



52749 79,00€

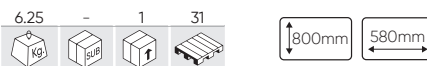

CAVALLETTO PROFESSIONALE



REF.	DESCRIZIONE	Kg	Box	Unit	€
11959	COPERTURA DI RICAMBIO PER REF. 52749	0.08	100		10,50€

53079 89,00€

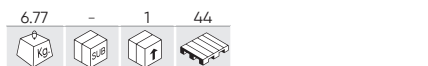

CAVALLETTO "X"

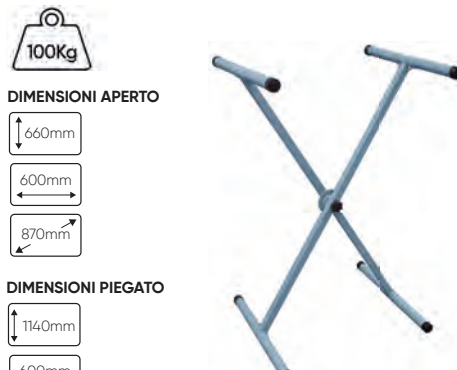

DIMENSIONI APERTO



DIMENSIONI PIEGATO



53736 98,00€



SUPPORTO PIEGHEVOLE PER PARAURTI



LA LARGHEZZA REGOLABILE CONSENTE AL SUPPORTO DI ADATTARSI A DIVERSI TIPI E STILI DI PARAURTI

LARGHEZZA REGOLABILE: 75 CM -160CM

ALTEZZA MASSIMA: 148CM

ACCIAIO

53685 310,00€



STAFFA PARAURTI



REGOLAZIONE DEI BRACCI DI SUPPORTO DA 134 A 198 CM

4 RUOTE DA 4 POLLICI (DUE GIREVOLI CON FRENO)

ACCIAIO VERNICIATO A POLVERE

53134 144,00€



SUPPORTO PER VERNICE REGOLABILE



- Telaio regolabile da 127 cm a 203 cm.
- Completo con 6 ganci per parti da verniciare.

53126 243,00€



SUPPORTO BASCULANTE PER VERNICIATURA

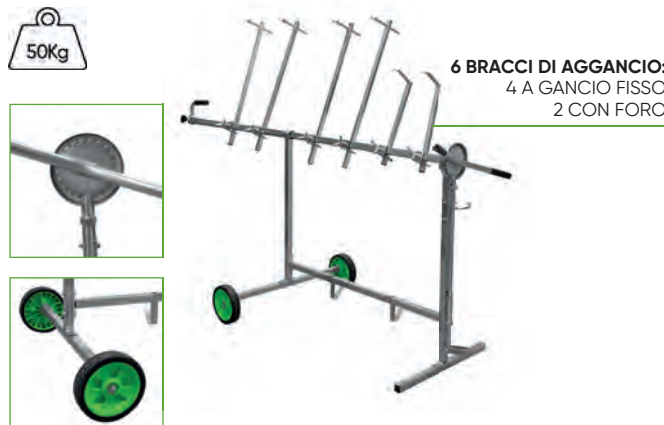

6 BRACCI DI AGGANCIAMENTO:
4 A GANCIO FISSO
2 CON FORO

52230

398,00€

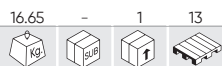

PIATTAFORMA D'ALLUMINIO TELESCOPICA

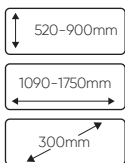

REF. DESCRIZIONE

REF.	DESCRIZIONE	10	100	1	13	€
10964	COPRIANGOLO PER PIATTAFORMA CON REF. 52230	0.01	-	1	-	9,00€
10965	BLOCCAPIOLO PER PIATTAFORMA CON REF. 52230	0.01	-	1	-	6,00€
10966	PIEDE RICAMBI PER PIATTAFORMA CON REF. 52230	0.06	-	1	-	13,50€

CONFORME A: EN 131

50913

195,00€

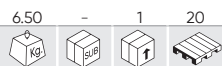

PIATTAFORMA D'ALLUMINIO GRANDE



CONFORME A: EN 131

50656

290,00€



KIT DI 2 PIATTAFORME D'ALLUMINIO



CONFORME A: EN 131

REF. DESCRIZIONE

REF.	DESCRIZIONE	10	100	1	10	€
11897	100x30x30cm	4.66	-	1	16	155,00€
15552	130x30x55cm	6.80	-	1	18	181,00€

53922

29,00€

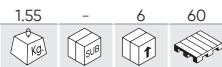

PORTA ROTOLO DI CARTA PER PARETE

- Acciaio inossidabile
- Rotolo: larghezza max. 38 cm
- Pressore è in plastica ABS, grigio
- Viti e dadi di fissaggio in acciaio inox.

CARTA NON INCLUSA

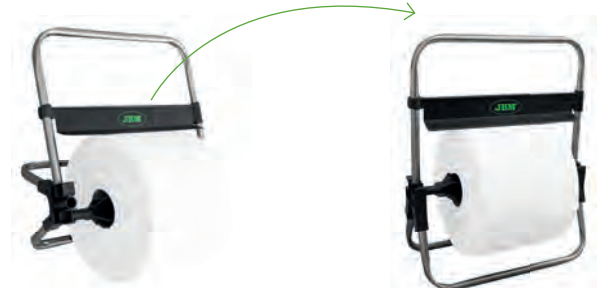

53921

39,00€

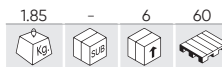

PORTA ROTOLO DI CARTA

- Materiale: acciaio inossidabile
- Rotolo: Larghezza massima 38 cm
- Pressore - plastica ABS

CARTA NON INCLUSA

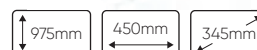

SET ESPOSITORE + COPRISEDILE

50400 168,00€

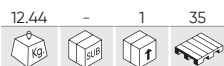

CONTIENE

- 53705 ESPOSITORE DA PARETE
- 51978 BOBINA DI COPRISEDILE
- 52057 ROTOLO DI PELLICOLA COPRIVOLANTE
- 52058 MANICO PER ROTOLO DI PELLICOLA
- 50409 PROTEZIONE POGGIPIEDI ANONIMA

50403 98,00€



CONTIENE

- 52065 ESPOSITORE DA PARETE
- 51978 BOBINA DI COPRISEDILE
- 52057 ROTOLO DI PELLICOLA COPRIVOLANTE
- 52058 MANICO PER ROTOLO DI PELLICOLA

50410 168,00€



CONTIENE

- 53705 ESPOSITORE DA PARETE
- 52244 BOBINA DI COPRISEDILE
- 52057 ROTOLO DI PELLICOLA COPRIVOLANTE
- 52058 MANICO PER ROTOLO DI PELLICOLA
- 50409 PROTEZIONE POGGIPIEDI ANONIMA

ESPOSITORE DA PARETE DI BOBINA COPRISEDILE, ROTOLO COPRIVOLANTE, POGGIPIEDI

53705 80,00€

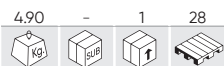

51985 84,00€



52065 45,00€



51978 84,00€



BOBINA DI COPRISEDILE
25MC 250U



250 PCS
25 mc

52244 84,00€



BOBINA DI COPRISEDILE
DISEGNO ANONIMO 25MC
250 U.



250 PCS
25 mc

52057 6,80€



ROTOLO DI PELLICOLA
COPRIVOLANTE

23 mc - Lunghezza: 200m
- Larghezza: 12,5cm
- Spessore: 23mc

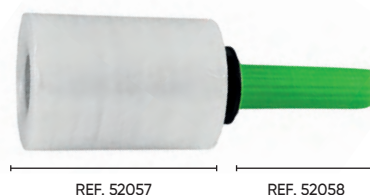

REF. 52057

REF. 52058

52058 4,50€



MANICO PER ROTOLO DI
PELLICOLA PER REF. 52057

23 mc

CARROZZERIA

50409

26,00€

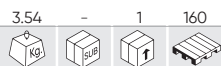

PROTEZIONE POGGIPIEDI ANONIMA

250
PCS



51824

36,80€



PACK DI 250 COPRIVOLANTE

250
PCS



50916

0.05 100 400 3200



KIT DI MANUTENZIONE IN SACCHETTO SINGOLO

5
PCS

20
mc



0,88€

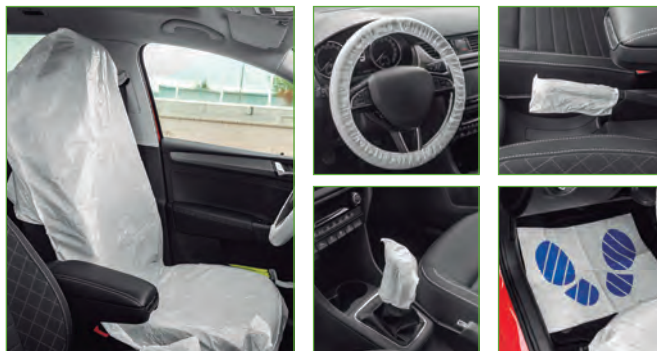

53226

14,90€

0.20 5 50 600



PROTEZIONE PER SEDILE AUTO



- NYLON.
- UNIVERSALE.

51622

25,30€



PROTETTORE MAGNETICO COPRI ALETTE E FRONTALI



4 PUNTI MAGNETICI

DUE LATI:
UNO VELLUTATO E UNO DI PLASTICA



BASTONE ESTENSIBILE MULTIFUNZIONE

REF.	Max.	Min.					€
52497	1200mm	530mm	0.29	6	48	480	26,80€
53196	1600mm	710mm	0.37	6	48	384	33,00€



FRENI

194 RIPOSIZIONATORI

197 SPURGOFRENI

197 MANUTENZIONE



52636

114,00€

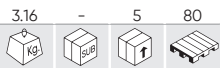

16 PCS

RIPOSIZIONATORE DEI PISTONI DEL FRENO

- 0 General Motors (Ø dei pistoni 2-1/2 pollici)
- 2 Citroën XM/Xantia (F/R), HONDA
Audi (F), Fiat, Alfa romeo (F), Ford Fiesta (F), Isuzu (F), Honda Concesto (F), Jaguar XJ6/ XJ40 (F/R), BMW 318is / 320i / 325T / 518i / 525i-1x / 740i / 850ci / M5 (F), Mercedes BENZ 190/200/300/420/560 serie (F), Mitsubishi Colt (F), Nissan Miera/Stanza/Sunny (F), Rover Austin/Metro200-400 series/Maestra/Montego (F), Toyota Camry (F), Volvo (F), VW Passat/Golf GTI (F)
- 4 Ford Australia/NZ Telstar, Mazda (R), Saab 9000 (R)/Lumina, Toyota, Fiat 164 2.0 (R), Alfa Romeo Prelude/CRS 16i, Honda Saturn (R)/Grand Prix, GM
- 5 Adattatore 3/8"
- 6 Nissan Primera, VW Golf IV
Audi 80/90/V8+100/Coupe E (R), Rover 800 ABS, Subaru L+Z (R), Ford Sierra ABS/Granada/Scorpio ABS (R), Nissan Bluebird 1.8 Turbo/Silvia Turbo/Primera2.0i LS-GS-GSX (R), Peugeot 405 1.9Gi/Gri/Sri/Gtxi/Mi 16/605 2.0 Sri (R), Toyota Cecilia/Corolla GT/MR2 (R), VW Golf Gti/Jeta Synchron/Jetta Gti 16v, Passat CL, GL, GT, GT 16v, Corrado 16V scirocca GTX 16V(R), Citroën, Alfa romeo, Fiat, Honda, Jaguar, Renault, Saab, Seat, Lancia.
- 7
- 8 General Motors (Ø dei pistoni 1-7/8 pollici)
- 9 General Motors (Ø dei pistoni 2-1/8 pollici)
- A(Z) Renault (R21-Laguna (R))
- E Nissan Maximas/Cefiro
- F(G) Opel (Rear disk)/ Fiat Stilo
- K Citroën C5
- K1 Renault, Citroën C5

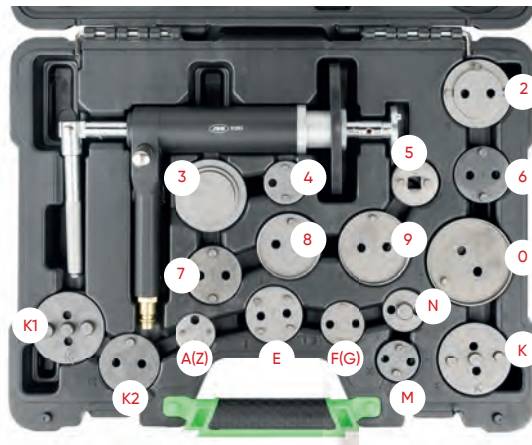

- K2 Renault, Citroën, Audi A8, S8
- M Ford, Mini Cooper, Nissan Primera 03
Saab, Honda, Alfa Romeo 164 2.0 Twin Spark/2.0 Turbo (88-)/3.0 V6, Audi 200 (80-)/Coupe GT SE (82-)/80/90/1QO/200/Quattro (87-)/90/20V (88-), Ford Mondeo 2.0/Ghia, Lancia Themaalte (85-), Volkswagen Golf II GTI (83-87)/Sirocco 16V (84)
- N

52330

99,00€



50 PCS OPEL PEUGEOT CITRÖEN RENAULT

VALIGETTA 50 PEZZI RIPOSIZIONATORE PER PISTONI FRENI

- 0 General Motors (Ø dei pistoni 2-1/2 pollici)
- 1 Disco
- 2 Citroën XM, Xantia u.a.
- 3 Alfa Romeo,Audi, Austin, BMW, Ford, Honda, Jaguar, Mercedes-Benz. Mitsubishi, Nissan Rover, Toyota, VW
- 4 Alfa Romeo 164 2.0.Ford, Mazda, Saab 9000, Subaru
- 5 Adattatore 3/8"
- 6 Nissan Primera, VW-Golf IV
- 7 Audi 8,0,90,V8 +100, Ford Sierra ABS+ Scorpio ab 85, Honda Prelude, Nissan Silvia 1.8 turbo, Rover 8000, Saab 9000, Subaru L+Z, VW-Golf+ Passat
- 8 General Motors (Ø dei pistoni 1-7/8 pollici)
- 9 General Motors (Ø dei pistoni 2-1/8 pollici)
- 11 Disco per Jaguar tipo S
- 12 Disco per BMW mini
- A Nissan Premira 2.0, Bluebird
- A1 Ford Transit 06,Transit Connect 02,Tourneo Connect 02,Mondeo 00-07,C-Max 03, Focus 04
- B Ford, Lincoln, Subaru
- B1 Ford S-max 06,Scorpio 94-06,Mondeo 07,Kuga 08,Galaxy 00-06,Focus RS 03,Fiesta 01-02,Cougar 98-01
- C Nissan Primera (02), Opel Vectra 02-,Toyota Avensis
- D Citroën, Renault
- E Cefiro, Maxima
- F Peugeot 206 CC / Hdi / GTI. Richiede una posteriore 16 millimetri pistone chiave
- F1 Fiat Ducato
- G Opel
- G1 Volkswagen Golf V / VI
Alfa Romeo 155 1.8-2.0 164 TD(93) 164 3.0 V6(91), Audi 80,90,A3,A4,A6,A8, Citroen ZX 2 Ql 16V, Fiat Tipo TD 16V, Uno Turbo (85) Crama TD, Ford Sierra (ABS bak). Granada (85) Crama TD, Ford Sierra (ABS bak). (Australia& NZ) Thunderbird Turbo, Honda CRX, 1.6i-16V (8-90), Accord 1800 (84-85) 2.0i, Prelude 16V (88), Legend V6, Jaguar XJ 4, Oseries, Lancia Dadra 2.0, Ei Tur (93), Delta 1.6 Gti, Nissan, Peugeot, Renault, Seat, Subaru, Volvo V40 6S40.
- J
- K Citroën C5
- K1 Citroën
- K2 Citroën, Renault.
- M Ford
- N Saab, Honda
- O Disco

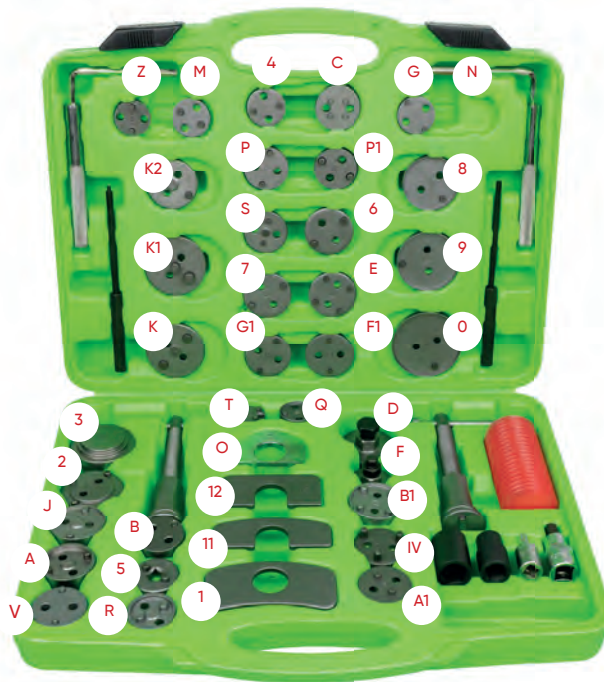

- P Audi, BMW, Ford, Lancia, Piston, Renault, Rover.
- P1 Peugeot 307,308.
- Q Alfa Romeo 164 2.0 1., Fiat Uno, Turbo ie-Barchetta, Ford Escort MK III, IV, Orion, XR31, Focus(98-) push-back pistons, Honda-most models (push-back pistons), Rover-most models(push-back pistons), Subaru Lserie & Serie 2
Ford(Australia& NZ) Teslar, Laser, Mazda 323 Gti, GTXX (86), 929 (82.), RX7(81-), 626
R 16V(87-) 626 GT (86-), 929 V6 (88-), Mitsubishi Galant GL Si, Toyota Celica, Corolla GT, MR2
Audi 100 TQ(91), BMW 740i 8cyl (91), Lancia Delta 1.9 TD (95), Proton 416, Renault-most models, Renault Laguna 2.0 (94), Laguna 2.2 D (95) Safrane 2.0-2.2 TD V6, Rover 623 Si, Volkswagen Golf Gtu Mk I&IV, Passat VR6, Vento GT (92)
- S
- T Rover 220 C Turbo (95)
- V Rover 216 Gti 16V,820 Si 2.0(93),825 SD 2.5 (93)
- Z Renault
- IV Iveco Daily, Volkswagen Passat 2.0 TDI 09-

53978

38,90€

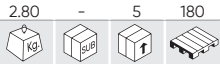

23 PCS

VALIGETTA 23 PEZZI RIPOSIZIONATORE PER PISTONI FRENI

- 0 General Motors (Ø dei pistoni 2-1/2 pollici)
- 1 Disco
- 2 Citroën XM, Xantia
- 3 Alfa Romeo, Audi, Austin, BMW, Ford, Honda, Jaguar, Mercedes-Benz, Mitsubishi, Nissan, Rover, Toyota, VW
- 4 Alfa Romeo 164 2.0, Ford, Mazda, Saab 9000, Subaru
- 5 Adattatore 3/8"
- 6 Nissan Primera, VW.Golf IV
- 7 Audi 80;90;V8+100, Ford Sierra ABS+Scorpio de 1985, Honda Prelude, Nissan Silvia 1.8 turbo, Rover 8000, Saab 9000, Subaru L+Z, VW Golf + Passat
- 8 General Motors (Ø dei pistoni 1-7/8 pollici)
- 9 General Motors (Ø dei pistoni 2-1/8 pollici)
- 10 VW K1 Citroën
- A Renault R21, Laguna K2 Citroën
- E Nissan Maxima, Cefiro M Ford
- F Opel N Saab, Honda
- K Citroën C5 O Disco

J Fiat Tipo TD 16V, Uno Turbo(85) Crama TD, Honda CRX, Alfa Romeo 155 1.8-2.0i, 164 TD (93), 164 3.0 V6 (91); Audi 80, 90, & V8's, A3, A4, A6, A8 (pinza traserà); Citroën ZX 2. Ql 16v; Fiat Tipo TD 16V, Uno Turbo (85-), Crama TD; Ford Sierra (ABS bak), Granada (85-); Ford (Australia & NZ) Thunderbird Turbo; Honda CRX, 1.6i-16V (88-90), Accord 1800 (84-85), 2.0i (86-), Preludi 16V (88-), LegendV6; Jaguar XJ serie 40; Lancia Dedra. 2.0 Ei Tur(93), Delta 1.6 Gti. (92), The. majE 16v(92), Thema. 2000 Turbo. Kappa 2.Q-2.4LS, 2.4TD;

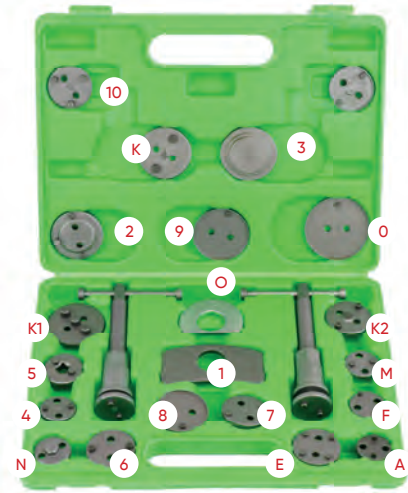

J Nissan 280 ZX (82-84), 300 ZX Turbo (84-89), Bluebird 16V (89-), Silvia 1.8 Turbo (85-88) 100 NZ 2.0 (93), Primera 2.0 GT (94), 200 SX turbo 16V, Maxima 2. O GX-3.0 GX (95); Peugeot 306; Peugeot 309 Gtj 16S (91), 405. Srif Q. rj, Gil (87-), 405 M.1 16v; Renault Master Van; Rover 216 Gti 16V, 820 Si 2. 0(93), 825 SD 2.5 (93); Saab 9000 CS 2.0(93), 9000 CSE Turbo(93); Seat Toledo GT. 16V-GT 2.0(93), Lbiza 1.8 Gti 16V(95); Subaru Lserie & Serie 2; Volkswagen Passat 2.0 & 2.2 Litre(84), Golf Rallye (-89), Golf II Gti 16V(89-), Vento GT (92), Transporter T4; Volvo S40 & V40

51059

99,00€

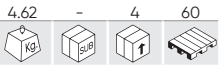

37 PCS

RIPOSIZIONATORE DEI PISTONI DEL FRENO

- 0 Disco
- 1 Disco
- 2 Citroën XM, Xantia (F/R)
- 3 Alfa Romeo, Audi, Austin, BMW, Ford, Honda, Jaguar, Mercedes-Benz, Mitsubishi, Nissan, Rover, Toyota, VW.
- 4 Alfa Romeo 164 2,0,Ford,Mazada,Saab 9000,Subaru.
- 5 Adattatore 3/8"
- 6 Nissan Primera,VW-Golf IV.
Audi 80,90,V8 +100,Ford Sierra ABS+Scorpio ab 85,Honda Prelude Nissan Silvia 1.8 turbo,Rover 8000, Saab 9000, Subaru L+Z, VW-Golf +Passat.
- 7 General Motors (Ø dei pistoni 1-7/8 pollici)
- 9 General Motors (Ø dei pistoni 2-1/8 pollici)
- 11 Disco per Jaguar tipo S
- 12 Disco per BMW mini
- A Disco a 2 denti da 1-3/16" per una Renault R21, Laguna
- B Ford, Lincoln, Subaru.
- C Mini Austin
- D Citroën, Renault.
- E Cefiro, Maxima
- F Opel Corsa, Astra, Zafiraand Vectra
- G Opel (disco posteriore)
Alfa Romeo 155 1.8-2.0 164 TD(93) 164 3.0 V6(91) Audi,80,90,A3,A4,A6,A8 Citreon ZX 2 Ql 16V,Fiat Tipo TD 16V,Uno Turbo(85) Crama TD, Ford Sierra(ABS bak),Granada (85),(Australia & NZ) Thunderbird Turbo,Honda CRX,1.6i-16V (8-90),Accord 1800(84-85)2.0i,Prelude 16V(88),Legend V6,Jaguar XJ40series,Lancia Dedra 2.0 Ei Tur(93),Delta 1.6Gti,Nissan,Peugeot, Renault,Seat,Subaru,Volvo V40& S40.
- K Citroën C5
- K1 Citroën, Renault.
- K2 Citroën, Renault.
- M Ford
- N Saab,Honda. Z: Renault
- O GM Motors.
- P Audi, BMW, Ford, Lancia, Proton, Renault, Rover, VW
- R Ford (Australia & NZ) Telstar,Laser, Mazda 323 Gti,GTX(86-),929(82-),RX7(81-),626 16V (87-), 626 GT (86-),929 V6(88-),Mitsubishi Galant GL Si, Toyota Celica,Corolla GT,MR2. Audi 100TQi(91), BMW 740i 8cyl.(91), Lancia Delta 1.9 TD(95), Proton 416, Renault-most models, Renault Laguna 2.0 (94), Laguna 2.2 D(95), Safrane 2.0-2.2 TD V6, Rover 623 Si, Volkswagen Golf Gti Mk 3&4,Passat VR6,Vento GT(92).

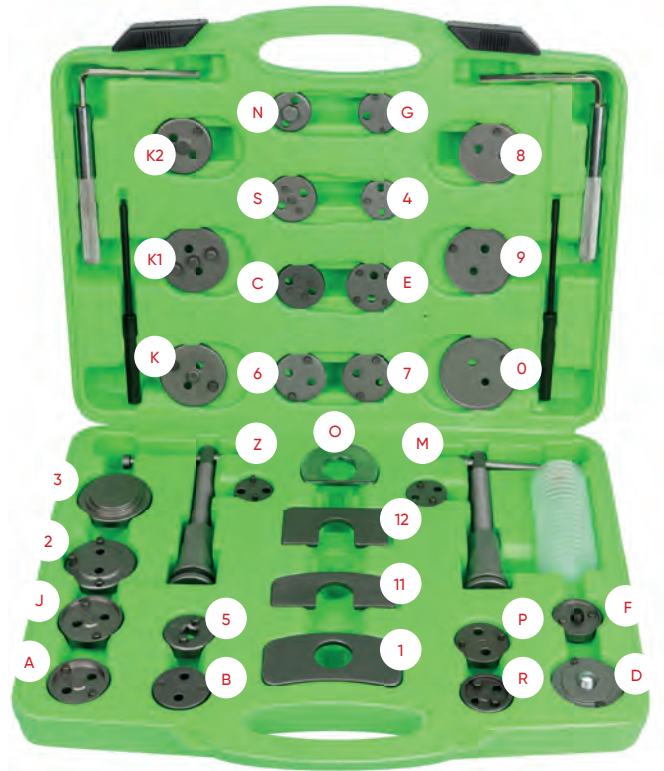

- Z BMW, Mini
- Pinza rotazione destra (con filettatura destrorsa)
- Rotazione rampino a sinistra (con filettatura sinistra)
- Pin Ø 3.0 / Pin Ø5.5 (100g Grasa)

52906

38,00€



RIPOSIZIONATORE DEI PISTONI DEL FRENO UNIVERSALE



REF. DESCRIZIONE

REF.	DESCRIZIONE	kg	dm³	Q	€
12974	RICAMBIO 2 PINS PER REF.52906	0.50	-	50 1500	21,00€
12975	RICAMBIO 2 PINS PER REF.52906	0.17	-	50 -	23,00€



ALFA ROMEO 164 2.0, FORD, MAZDA, SAAB 9000, SUBARU, NISSAN PRIMERA, VW, AUDI, FORD SIERRA ABS + SCORPIO AB 85, HONDA PRELUDE, NISSAN SILVIA 1.8 TURBO, ROVER 8000, SAAB 9000, FORD, OPEL, BMW, LANCIA, PROTON, RENAULT, ROVER, PEUGEOT 307, 308 A3- IVECO DAILY, VOLKSWAGON PASSAT 2.0 TDI 09, RENAULT LAGUNA.

53683

116,00€

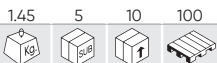

PISTOLA PER IL RIPOSIZIONAMENTO DEI FRENI - PROFILO BASSO

- Pressione normale di funzionamento: 5-8 bar.
- Pressione massima di funzionamento: 14 bar.



51283

78,00€

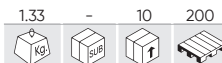

PISTOLA PER IL RIPOSIZIONAMENTO DEI FRENI

- Pressione normale di funzionamento: 5-8 bar.
- Pressione massima di funzionamento: 14 bar.



52191

198,00€

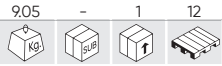

SPURGOFRENI

5L

- Pressione (regolabile) di lavoro: da 0 fino a 4 kg/cm².
- Prese d'entrata ed uscita de 1/2".
- Peso: 5Kg.
- N° d'adattatori: 11+2 adattatori universali.
- Gamma d'applicazioni: GM, Chrysler, Nissan.



REF. DESCRIZIONE

52328 ADATTATORI PER SPURGO FRENI PER REF.52191

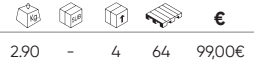

52434

125,00€

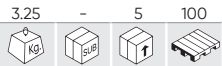

15 PCS

VALIGETTA PORTAUTENSILI SPECIFICA PER IMPIANTI FRENO

- x2 Chiavi freno
- x1 Pinza a molla freno
- x1 Driver impact
- x3 Occhiali cacciavite
- x1 Strumento di montaggio
- x1 Cacciavite con giunto cardanico
- x1 Freno attrezzo speciale
- x1 Spazzola di pulizia
- x1 Spazzola ottone
- x1 Strumento di montaggio
- x1 Pinza per cavo freno
- x1 Lime per pinza freno



54135

82,00€

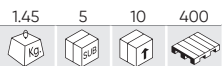

17 PCS

SET DI BUSSOLE PER PINZE FRENI

CONTIENE

	x2	14x38, 22x38mm
	x3	11,50x38, 15x38, 20x38mm
	x4	10, 12.50, 14, 19mm
	x1	10mm
	x4	H11x100, H7x70, H7x92, H9x50mm
	x2	7x24, 8x24mm
	x1	9x20mm



AUDI (A4, A5, S5, S8, Q5, Q7), PORSCHE (CAYENNE, MACAN, CAYMAN), MERCEDES BENZ, FORD, BMW, ALFA ROMEO

54372

157,00€



N

SET DI TESTER PER FRENI CON E SENZA ABS

Progettate per disassemblare le pinze dei freni durante la sostituzione delle pastiglie.

APPLICAZIONI

Audi (TT (2007-), A4 (2001-), A6 (2005-), A8 (2003-), Q7, S5, S6, S8), Porsche (Cayenne, Macan, Cayman), Mercedes-Benz (ML320, Classe C), Ford (Mondeo, Fiesta, Focus, Edge), BMW (Series 3 -generación E36 / 5), Alfa Romeo, Jaguar (XF), Vauxhall, Volkswagen, Chrysler, Mini, SAAB

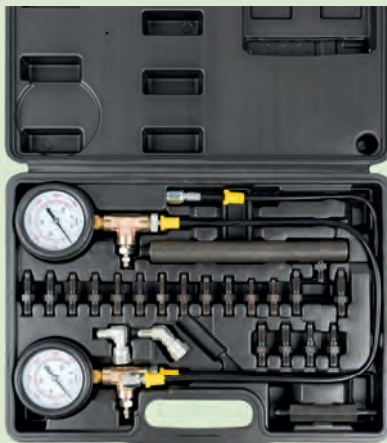

CONTIENE

- x1 Adattatore Teves
- x1 Raccordo girevole a 45°
- x1 Raccordo girevole a 90°
- x2 Raccordo dritto 7/16-24
- x2 Raccordo dritto 1/4-28
- x2 Raccordo dritto 3/8-24
- x2 Raccordo dritto 5/16-24
- x2 Raccordo dritto M10-1.5
- x2 Raccordo dritto M8-1.25
- x2 Adattatore di spurgo M10-1.0
- x2 Raccordo dritto 7/16-20
- x2 Raccordo dritto M7-1.0

52625

9,00€

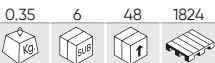

PINZA PER FRENI A TAMBURO



- Per estrarre e installare stazioni di ritorno en frenos tamburo.

52315

16,00€

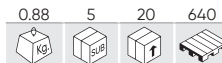

SEPARATORE DEI PISTONI DEI FRENI



- Apertura massima: 80mm.

51839

24,00€

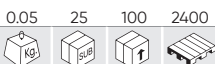

TESTER DEL LIQUIDO DEI FRENI

- Funziona a pile 1 x AAA LR03.
- Con 4 livelli di qualità misurabili dallo 0% al 4%.



52455

16,00€

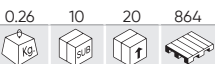

SPESSIMETRI PER PASTIGLIE FRENO

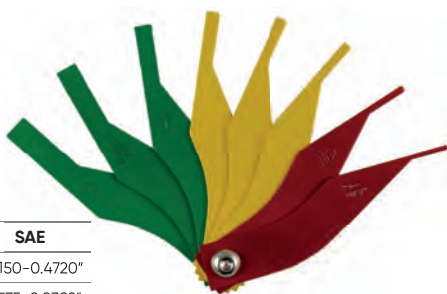

COLORE	METRIC	SAE
Green	8-10-12mm	0.3150-0.4720"
Yellow	4-5-6mm	0.1575-0.2382"
Red	2-3mm	0.0787-0.1181"

52275

38,00€



SPURGOFRENI



- Temperatura: 10°C a 50°C.
- Manichetta in silicone: 2m.
- Pistola di soffio d'aria d'entrata 1/4".

UTENSILERIA

- 200 SISTEMA DI LUBRIFICAZIONE
- 206 SISTEMA DI INIEZIONE
- 213 BLOCCO / TESTATA
- 216 FRIZIONE
- 217 SISTEMA DI RAFFREDDAMENTO
- 219 SISTEMA IMPIANTO A/C
- 221 TRASMISSIONE
- 223 SOSPENSIONI
- 229 SISTEMA DI SCARICO
- 231 IMPIANTO ELETTRICO
- 235 RIPARAZIONE FILETTI
- 238 MOTO
- 238 ESTRATTORI



54068

120,00€



SET DI ESTRATTORI PER FILTRI DELL'OLIO IN ALLUMINIO, 19 PZ.

REF.	N° DI PARTE	DESCRIZIONE	FACCE x Ø				€
15494	05101	Mazda, Mitsubishi	15 x 100,5mm	0.18	-	50	12,50€
15495	0595	Nissan, Toyota	15 x 94,5mm	0.18	-	50	12,50€
15496	0592	Nissan, Subaru	15 x 92mm	0.18	-	50	11,50€
15497	0579	Toyota, Honda, Mitsubishi, Subaru, Mazda, Lsuzu	15 x 79mm	0.14	-	50	11,00€
15498	915	Volvo	16 x 87mm	0.24	-	50	11,50€
15499	901L	Lexus	14 x 79,5mm	0.15	-	50	11,00€
15500	901T	Toyota	14 x 70mm	0.13	-	50	10,00€
15501	901-1	Toyota	14 x 63-64mm	0.10	-	50	10,00€
15502	902	Ford, Mazda	14 x 66,5mm	0.89	-	50	10,00€
15503	1284	Dodge Sprinter (2007-), Mercedes Benz E320 (2007-), Jeep Cherokee 3.0L V6 Common Rail (2007-)	14 x 84mm	0.13	-	50	11,00€
15504	903B	Mercedes Benz	14 x 74mm	0.13	-	50	10,00€
15505	24mm	BMW 5, BMW 7, BMW X5 V8 (N62) (2004-), Saturn (2008), Astra 1.8L ECOTEC, Chrysler 3.6L V6 (2011-), 200, 300, T/C Dodge Jeep	6 x 24mm	0.47	-	50	4,00€
15506	27mm	Mercedes Benz Classe A	6 x 27mm	0.45	-	50	4,00€
15507	30mm	Audi A2, Vw Polo, Lupo 1.4L/1.6L	6 x 30mm	0.44	-	10	4,50€
15508	32,5mm	Opel Astra G, Corsa B, Zafira, Audi, VW 1-36 mm, Opel Omega, Vectra B, Zafira (98-), BMW M43/60)	6 x 32,5mm	0.45	-	50	4,50€
15509	36mm	Opel Omega, Vectra B, Zafira (98-), BMW M43/60, Mercedes Benz Vito CDI, C, E, VW Lupo 1.2 TDI, MAN	6 x 36mm	0.48	-	50	5,00€
15510	38mm	Opel Vectra 2.0D	6 x 38mm	0.50	-	50	5,00€
15511	917	Universal	55-90mm	0.22	-	50	8,00€



51332

98,00€



ESTRATTORI PER IL FILTRO DELL'OLIO

REF.	N° DI PARTE	DESCRIZIONE	FACCE x Ø				€
11374	901	Toyota, Nissan, Fiat Daihatsu	14 x 65mm	0.05	5	20	5,50€
11375	902	Toyota, Daihatsu	14 x 67mm	0.45	5	20	6,50€
11376	903	VW, Mercedes, BMW, Opel, Audi	14 x 74mm	0.20	5	20	5,50€
11377	903-1	GM/AC, Wix, Ford, Isuzu	15 x 75mm	0.09	5	20	5,50€
11378	903-2	VW, Audi, Seat, BMW, Renault	8 x 74mm	0.09	5	20	6,50€
11379	903-3	Audi, Rover, Chrysler	15 x 74mm	0.11	5	20	6,00€
11380	903-4	Toyota, Lexus	14 x 73mm	0.11	5	20	6,50€
11381	903-6	Schlepper, Baumashinen	12 x 75mm	0.10	-	20	6,50€
11382	918	Rover, Chrysler, Audi	15 x 74mm	0.11	5	20	6,00€
11383	904	Nissan, Ford	15 x 79mm	0.50	5	20	6,00€
11384	905	GM, Chrysler	15 x 73mm	0.12	5	20	6,00€
11385	905-1	BMW, Mercedes, Opel, Audi, VW	14 x 74mm	0.10	5	20	5,50€
11386	906	Baummaschinen, Schlepper	18 x 84mm	0.10	5	20	6,00€
11387	907	Mitsubishi, Toyota	15 x 89mm	0.13	5	20	6,00€
11388	908	Nissan, Toyota	15 x 91mm	0.14	5	20	6,00€
11389	915	Honda Accord, Mitsubishi, Isuzu	15 x 90mm	0.16	5	20	6,00€
11390	910	Toyota, Alfa Romeo, Ford	15 x 95mm	0.12	5	20	6,00€
11391	911	Fiat, Renault, Citroën	12 x 76mm	0.09	5	20	6,50€
11392	911-1	Subaru, Toyota, Honda, Nissan	15 x 80mm	0.09	5	20	6,00€
11393	914	Mazda, Toyota	15 x 101mm	0.18	5	20	6,00€
11394	909	Isuzu, Nissan	15 x 92mm	0.14	5	20	6,00€



REF.	DESCRIZIONE				€
14992	CHIAVE A 12 PUNTE PER N. 51332/ N. 14141	0.14	-	100	8,50€
10955	CRICCHETTO 1/2" PER ESTRATTORE DEL FILTRO 51332	0.14	-	50	11,00€

BUSSOLE D'ESTRAZIONE PER IL FILTRO DELL'OLIO

REF.	FACCE x Ø	DESCRIZIONE					€
52311	42mm	GRUPO VAG	0.13	6	72	1728	19,00€
52312	14 x 74mm	VW, OPEL, MERCEDES, BMW, AUDI	0.10	10	100	1000	9,00€
52313	16 x 86mm	VOLVO 540, 560, 570, 580	0.20	6	68	1008	8,00€
52314	16 x 87mm	BMW, VOLVO	0.20	5	50	600	26,60€
52809	14 x 64,5mm	TOYOTA	0.15	10	100	1000	8,50€
53441	14 x 76mm	-	0.20	5	20	800	9,80€



53008

15,50€

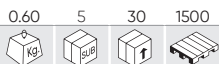

ESTRATTORE DEL FILTRO DELL'OLIO FORD, CITROËN, PEUGEOT 2.0, 2.2 HDI, TDCI



52518

115,00€

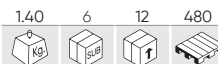

ESTRATTORE PER FILTRI CAMION 95-165MM



52615

112,00€



ESTRATTORI PER IL FILTRO DELL'OLIO

- Chiave regolabile a doppio senso.
- Applicazione: 60-80mm.

1/2"	x1	Universal	63 - 83mm
		Mercedes Benz, Smart	27mm
	x3	GM, Opel, Vauxhall, Mercedes Benz	32mm
		Mercedes Diesel, BMW, Mini, Ford	36mm
		Toyota (Allion, Auris, Corolla, Prius, Voxy, etc.)	64,5mm
3/8"	x3	Toyota, Lexus (6 Zyl.).	64,5mm
		Audi, BMW, Ford, Toyota, Volkswagen, Porsche, Mercedes-Benz	74,2mm
	x1	Hunday, Kia.	88,8mm
	x1	BMW 3+5+X, Volvo	86,6mm



ESTRATTORE DEL FILTRO DELL'OLIO A ZAMPE PIATTE / A ZAMPE ROTONDE

51352

9,80€



1/2" - 3/8"
57-118mm
Ø2-1/4" ~ 5"

51353

11,50€



1/2" - 3/8"
72-136mm
Ø2-1/2" ~ 4"

51923

12,50€



1/2" - 3/8"
72-136mm
Ø2-1/2" ~ 4"

51934

11,50€



1/2" - 3/8"
57-118mm
Ø2-1/2" ~ 4"

53206

38,20€

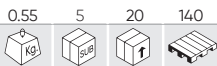

5
PCS

SET 5 ASTE PER IL CONTROLLO DELL'OLIO - BENZ/AUDI

- Per controllare il liquido di trasmissione dell'olio nei motori Audi 100:
- La punta (prima 11mm) è la lettura del fluido freddi a 20°C.
- La seconda lettura è al minimo di 80°C.
- La terza lettura è al massimo di 80°C.
- Mantenere il livello del veicolo durante il controllo dell'ATF.
- Asta dal motore per controllare il livello dell'olio, compatibile con un'ampia gamma di motori dal 1988 al 2005 nella gamma Mercedes.

	Mercedes-Benz	920mm	- Codice di trasmissione: 716.5,722.7,722.8.
	Mercedes-Benz	930mm	- Anno di produzione: 1988-1997. - Codici motore: 103,104,111,119,120,137,604,605,606,611,612,613,628,642,647,648.
	Mercedes-Benz	930mm	- Anno di produzione: 1996-2005. - Codici motore: 103,104,111,112,113,119,120,137,271,272,604,605,606,611,612,613,628,642,646,647,648..
	Mercedes-Benz	1200mm	- Codice di trasmissione: 722.6.
	Audi	1160mm	- AUDI 100 motori.



REF.	DESCRIZIONE					€
13856	ASTA PER CONTROLLO DI OLIO AUDI	0.04	5	100	-	7,80€

51354

13,20€



PINZA PER L'ESTRAZIONE DEI FILTRI DELL'OLIO

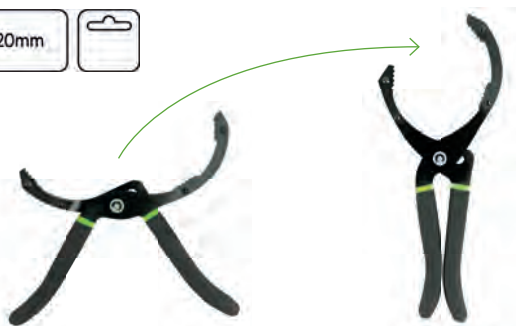

53670

29,50€



CHIAVE PER FILTRO OLIO PER VAG DSG DA 1/2" 24 MM

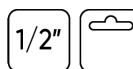

- Set di strumenti per la riparazione e il ricondizionamento dei bulloni delle ruote, nonché per l'ancoraggio alla filettatura femmina del veicolo; utile in fili parzialmente danneggiati.



52269

7,00€

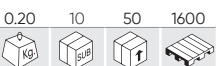

ESTRATTORE PER FILTRI A NASTRO

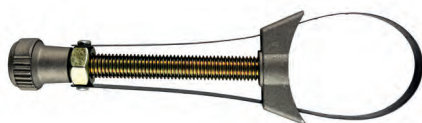

RICAMBIO REF.	mm				€
11106	360mm	0.02	10	50	3,00€

52677

17,00€



ESTRATTORE FILTRO REGOLABILE Ø65-105MM



RICAMBIO REF.	mm				€
11936	383mm	0.15	5	300	4,00€

52678

18,00€

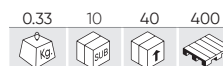

ESTRATTORE FILTRO REGOLABILE Ø110-155MM



RICAMBIO REF.	mm				€
11937	540mm	0.04	10	100	5,00€

ESTRATTORE PER FILTRI

52417 28,00€

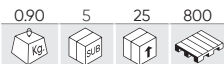

Ø160-300mm



CATENA A ELEVATA RESISTENZA

52416 14,00€

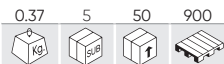

Ø150-540mm



CINGHIA SISTETICA AI POLIMERI (ALTA RESISTENZA)

52607 49,00€

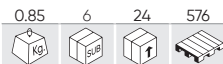

Ø60-140mm



DOPPIA CATENA

52608 44,00€

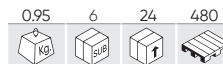

Ø60-195mm



DOPPIA CATENA

53735



KIT DI BUSSOLE PER TAPPI CARTER 23 PEZZI

44,00€

23 PCS 3/8"

CONTIENE

- x2 5/16", 3/8"
- x7 7, 8, 10, 11, 12, 13, 14mm
- x1 10mm
- x1 10mm
- x7 8, 9, 10, 12, 13, 14, 17mm
- x1 T45
- x1 M16

- x1 200mm
- x2 75, 150mm

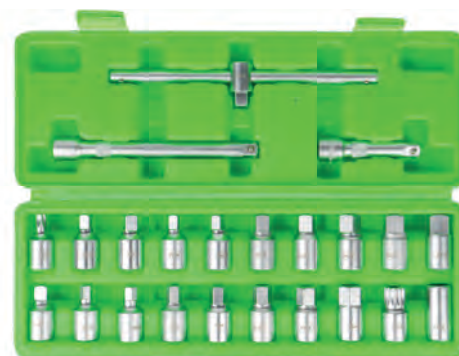

15084



MODULO DI RIMOZIONE DEI TAPPI DEL CARTER

68,00€

240mm 135mm 32mm

CONTIENE

- x2 5/16", 3/8"
- x7 7, 8, 10, 11, 12, 13, 14mm
- x1 10mm
- x1 10mm
- x7 8, 9, 10, 12, 13, 14, 17mm
- x1 T45
- x1 M16
- x1 200mm
- x1 150mm



ADATTO ANCHE PER IL RACCOGLITORE DI OLIO RIF. 53873 E 53874.

KIT DI REPARAZIONE DEL FILETTO DEI TAPPI DELLE COPPE D'OLIO

53235 10,40€



M13



53236 11,50€



M15



53237 12,90€



M17



53238 18,40€



M20



SET DI 3 TAPPI IN PLASTICA CARTER

5
PCS

REF.	DESCRIZIONE					€
13969	VAG	0.02	10	100	-	19,00€
53537	BMW	0.05	10	100	4000	14,50€
53538	Ford	0.10	10	100	4000	14,50€
53741	Ford / PSA	0.05	10	100	4000	14,00€



53472 12,00€

0.10	10	100	1200

CHIAVE PER TESTA CILINDRICA IN PLASTICA (VAG)



52617 7,00€

0.23	6	36	1620

CHIAVI PER TAPPI DI CARICO

- Per Citroën, Renault, Peugeot.



53473 36,00€

0.40	10	50	800

SET DI ESTRATTORE TAPPI DI CARTER PLASTICHE

5
PCS



A	x1	3/8"	80x100mm	Ford	OEM 1830727
B	x1	1/4"	1,5mm	VAG	OEM 06L 103 801
C	x1	1/4"	10mm	BMW	OEM 11137605018
D	x1	3/8"	3mm	Peugeot/Citroën	OEM 9801444780/OEM18711598
E	x1	1/4"	- 3/8"		

52754 54,00€

1.25	-	5	160

TESTER DI PRESSIONE PER CIRCUITI OLIO

0-10 BAR 0-140 PSI

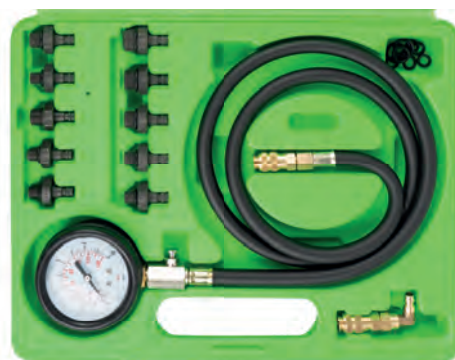

x1	M10x1.0mm
x1	M12x1.5mm
x1	M14x1.5mm
x1	M16x1.5mm
x1	M18x1.5mm
x1	1/8" DIN 2999
x1	1/8" x 27 NPT
x1	1/4" x 18 NPT
x1	3/8" x 20 UNF
x1	1/2" x 20 UNF

51337 50,00€

1.55	-	10	180

KIT DI RIPARAZIONE PER TAPPI OLIO MOTORE

24
PCS

- Tappi SKS3.
- Inserti 1015.
- Rondelle di rame.

CONTIENE

- M13x1,5P
- M15x1,5P
- M17x1,5P
- M20x1,5P
- Inserti: 1 unità x misura
- Tappi: 5 unità x misura
- Rondelle: 10 unità x misura

RICAMBI DISPONIBILI

	REF.	DESCRIZIONE				€
	A 51400	M15 x 1.5P	0.15	50	100	17,00€
	B 51401	M17 x 1.5P	0.14	50	100	22,00€
	C 51402	M20 x 1.5P	0.10	25	50	20,50€
	D 51403	M13 x 1.5P	0.15	50	100	17,50€
	E 14930	M13 x 1.5P	0.05	10	100	9,50€
	F 14931	M15 x 1.5P	0.05	50	100	8,00€
	G 14932	M17 x 1.5P	0.07	5	100	9,50€
	H 14933	M20 x 1.5P	0.10	5	100	9,50€

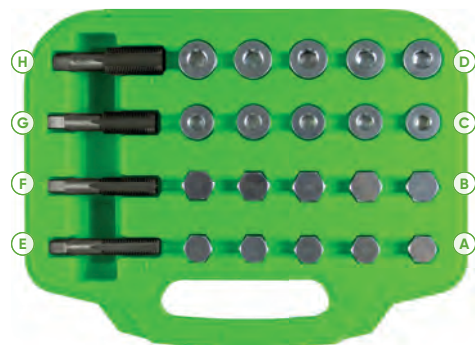

53485

140,00€



SET DI RIEMPIMENTO DI OLIO, IMBUTO E ADATTATORI



- A Adattatore filettato M42 x 4,5 per SubaruSubaru
- B Adattatore filettato M37 x 3,0 (tipo corto) per Lotus, Pontiac, Scion, Toyota
- C Adattatore filettato M35 x 4,0 per Ford, Jaguar, Land Rover, Mazda
- D Adattatore filettato M32 x 3,5 per Acura, Dodge, Ford, Honda, Jaguar, Jeep, Land Rover, Mazda, Nissan
- E Adattatore a baionetta per Toyota e Lexus 3,0 e 3.3L V6
- F Adattatore a baionetta per Audi, BMW, Mercedes-Benz, Porsche, Volvo, VW
- G Adattatore filettato M30 x 3,0 per Dodge Cummins
- H Adattatore filettato (1/2 giro) per Mazda 3 / 6 / CX-5
- I Adattatore filettato (1/2 giro) per Cadillac, Chevy, Ford, GMC, Hyundai, Jaguar, Land Rover, Mazda, Saab, Mercury
- J Adattatore filettato (1/4 di giro) per nuovi coperchi di riempimento olio dal 2008 su Audi, Seat, Skoda, VW con Motore EA888
- K Adattatore filettato (1/2 giro) per Dodge Hemi 6.4L (2011-) e >3.6L (>2014)
- L Adattatore filettato M37 x 3,0 (tipo lungo) per Lotus, Pontiac, Scion, Toyota

53347

100,00€



SET DI RIEMPIMENTO DI OLIO,IMBUTO E ADATTATORI



- A Adattatore filettato M42 x 4,5 per Subaru
- B Adattatore filettato M37 x 3,0 (tipo corto) per Lotus, Pontiac, Scion, Toyota
- C Adattatore filettato M35 x 4,0 per Ford, Jaguar, Land Rover, Mazda
- D Adattatore filettato M32 x 3,5 per Acura, Dodge, Ford, Honda, Jaguar, Jeep, Land Rover, Mazda, Nissan
- E Adattatore a baionetta per Toyota e Lexus 3,0 e 3.3L V6
- F Adattatore a baionetta per Audi, BMW, Dodge, Mercedes-Benz, Porsche, Volvo, VW

52305

106,00€



ESTRATTORE/RIPARATORE CANDELA

16 PCS



- Estrattore di candele periscaldamento di 16 pezzi.
- Questo set è utile per l'estrazione delle candele a incandescenza rotte o bloccate.
- Universale e ottimo per motori Mercedes-Benz CDI.
- Estrae le candele a incandescenza rotte o danneggiate M8 e M10.
- Include maschi di filettatura 1/4" M8 e punta progressiva ad alta resistenza di doppia misura M8 e M10.

51494

107,00€



SET PER L'ESTRAZIONE DI INIETTORI

9 PCS S



- | | | | | | |
|--|------------|------------|--|----------------------|----------|
| | M12 x 1.75 | M8 x 1.5 | | M14 x 1.5 | M8 x 1.5 |
| | M14 x 1.5 | M17 x 1.5 | | M14 x 1.5 | |
| | M14 x 1.5 | M27 x 1.0 | | HRC: Hardness 30 -35 | |
| | M14 x 1.5 | M12 x 1.75 | | 1.75Kg. | |
| | M14 x 1.5 | M8 x 1.5 | | | |

54220

197,00€



STRUMENTO PER INSTALLAZIONE E RIMOZIONE DELL'INIETTORE DI COMBUSTIBILE PER BMW MERCEDES BENZ

MODELLO	<p>BMW: 135iS (2008-), 335 (2007-), 335Xi (2007-), 535i (2008-), 535Xi (2008-), 550i GT (2010-), 750Li (2009-), 750i (2009-), X3 3.0i (2007-), X5 (2011-), X5 3.0i (2008-), X6 (2008-)</p> <p>MERCEDES-BENZ: C-CLASS (2007-), CLK / SLK (2007-), E-CLASS (2007-), A / CLA / GLA 45 AMG (2013-), CL / CLS 63 AMG (2010-), E / G / GL 63 AMG (2011-), GLE 63 AMG (2015-), S / SL 63 AMG (2010-), SLK 55 AMG (2012-)</p>
UTENSILI OEM	<p>BMW: 130180(1), 130195(2), 130270(3), 130320(4), 2249115(5)</p> <p>MERCEDES-BENZ: 271589023300(6), 278589003300(7)</p>
CODICE MOTORE	<p>BMW: N14 / N18 / N20 / N47 / N54 / N57 / N55 / N63</p> <p>MERCEDES-BENZ: M133 / M152 / M157 / M270 / M271 / M274 / M276 / M278</p>

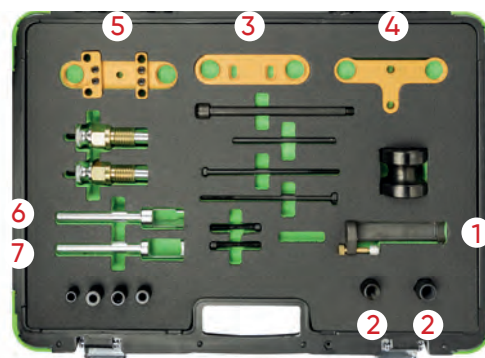

52815

110,00€



SET DI UTENSILI DI RIMOZIONE PER CANDELETTE ROTTE

22 PCS



53250

85,00€



SET DI ESTRATTORI PER CUSCINETTI INTERNI ED ESTERNI

5 PCS



53069

98,00€



ESTRATTORE DI INIETTORI DIESEL PER CITROËN, PEUGEOT

9 PCS

CITROËN, PEUGEOT



- x1
- x3
- x2 Ø 17mm
- x2 Ø 25mm
- x2 25mm
- x2 29mm
- x1 21mm

52629

99,00€



SET PER L'ESTRAZIONE INIETTORI MERCEDES

3 PCS

MERCEDES



M16x1.5

51493

68,00€

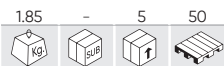

MISURATORE E TESTER DI SISTEMI D'INIEZIONE

31 PCS BOSCH, SIEMENS, DENSO, DELPHI

Strumento ideale per misurare con rapidità ed efficacia la quantità di carburante che ogni iniettore rinvia al serbatoio di carburante, che permette di sapere se qualche iniettore è danneggiato. Per iniettori Bosch, Siemens, Denso e Delphi.

- CONTIENE**
- Supporto da appendere con 6 bottiglie di misurazione graduate
 - Tubi di misurazione
 - Tubi bianchi
 - Valigetta per contenere tutto il kit.



REF.	DESCRIZIONE					€
12901	BOTTIGLIA + COPERCHIO + TUBO PER REF.51493.0.03	10	60	-	5,20€	

54391

221,00€

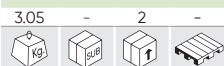

TESTER UGELLI PER INIETTORI DIESEL

0-60 MPA 5-8 BAR 0-600 BAR 0-8700 PSI M12 M14

Questo strumento ti aiuta a controllare lo stato degli iniettori esercitando pressione su di essi. È particolarmente indicato per controllare il modello di atomizzazione e la pressione di apertura degli iniettori.

x1	M12
x2	M14



54392

1.855,00€

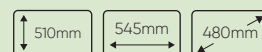
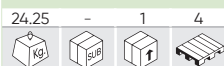

PULITORE E TESTER PER INIETTORI GDI / EFI

220V 60W 50-60 Hz
 0,1-10 BAR 5-8 BAR
 <85% -10°C 40°C

Questo prodotto consente di pulire e controllare il corretto funzionamento degli iniettori GDI ed EFI. Grazie al suo microcontroller, la macchina può simulare le reali condizioni di funzionamento del motore. In questo modo è possibile osservare il comportamento di ciascun iniettore e rilevare eventuali guasti.

Per la pulizia degli iniettori, utilizza la pulizia ad ultrasuoni, garantendo così la completa eliminazione dei residui che possono essere presenti negli iniettori sia benzina che diesel. Per i sistemi EFI include anche la modalità di pulizia nel veicolo.

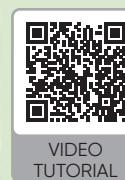

VIDEO TUTORIAL

54220

197,00€

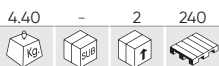

STRUMENTO PER INSTALLAZIONE E RIMOZIONE DELL'INIETTORE DI COMBUSTIBILE PER BMW MERCEDES BENZ

MODELLO	<p>BMW: 135iS (2008-), 335 (2007-), 335Xi (2007-), 535i (2008-), 535Xi (2008-), 550i GT (2010-), 750Li (2009-), 750i (2009-), X3 3.0i (2007-), X5 (2011-), X5 3.0i (2008-), X6 (2008-)</p> <p>MERCEDES-BENZ: C-CLASS (2007-), CLK / SLK (2007-), E-CLASS (2007-), A / CLA / GLA 45 AMG (2013-), CL / CLS 63 AMG (2010-), E / G / GL 63 AMG (2011-), GLE 63 AMG (2015-), S / SL 63 AMG (2010-), SLK 55 AMG (2012-)</p>
UTENSILI OEM	<p>BMW: 130180(1), 130195(2), 130270(3), 130320(4), 2249115(5)</p> <p>MERCEDES-BENZ: 271589023300(6), 278589003300(7)</p>
CODICE MOTORE	<p>BMW: N14 / N18 / N20 / N47 / N54 / N57 / N55 / N63</p> <p>MERCEDES-BENZ: M133 / M152 / M157 / M270 / M271 / M274 / M276 / M278</p>

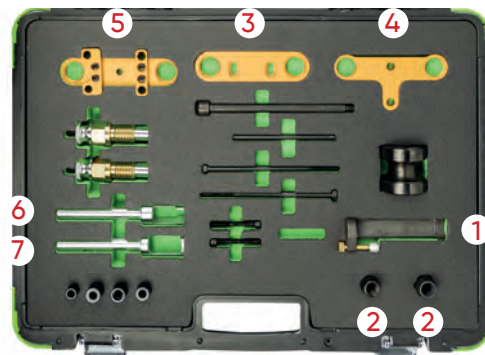

52815

110,00€



SET DI UTENSILI DI RIMOZIONE PER CANDELETTE ROTTE

22 PCS



53250

85,00€



SET DI ESTRATTORI PER CUSCINETTI INTERNI ED ESTERNI

5 PCS



53069

98,00€









ESTRATTORE DI INIETTORI DIESEL PER CITROËN, PEUGEOT

9 PCS

CITROËN, PEUGEOT



-  x1
-  x3
-  x2 Ø 17mm
-  x2 Ø 25mm
-  x2 25mm
-  x1 29mm
-  x1 21mm

52629

99,00€



SET PER L'ESTRAZIONE INIETTORI MERCEDES

3 PCS

MERCEDES



M16x1.5

52639

123,00€

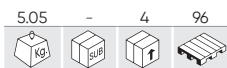

SET DEL BRACCIO DELLA DIREZIONE

- Ø 30-35mm
- Ø 35-40mm
- Ø 40-45mm



53464

153,00€



ASTUCCIO DI RONDELLE DI RAMA PER INIETTORI 551 PZ.

551 PCS

PER MAGGIORI INFORMAZIONI

PAGINA 387



53501

24,00€

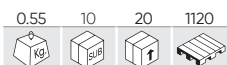

ESTRATTORE DELLA POMPA DI INIEZIONE DIESEL (BMW)



OEM 1 13 5 191 | 13 5 192 | 13 5 190 BMW.
BWM: M47 / M47T2 / M47TU / M57 / M57TU.
SERIES: E46 (318D-320D) (1988 - 2005) and E60, E61 (318TD-320TD-525D-530D-530-535) (2000 - 2006).

53009

42,00€

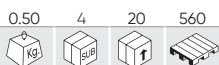

ESTRATTORI DI TUBO D'INIEZIONE DIESEL



- 3 PCS
- 1/2"
- 14, 17, 19mm

53522

24,00€



ESTRATTORE RONDELLE DI INIETTORI



- 350mm
- Ø 4,5-15mm

53696

22,00€



ESTRATTORE A MORSETTO HENN



VOLKSWAGEN, AUDI, SEAT, ŠKODA, BMW, PEUGEOT, CITROËN, DACIA, FIAT, FORD, KIA, LEXUS, MAZDA, MERCEDES, NISSAN, OPEL/VAUXHALL, PORSCHE, RENAULT, TOYOTA, VOLVO.

52757

16,00€



ESTRATTORE UNIVERSALE CALIBRI



53490

275,00€

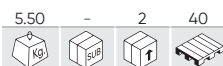

SET PER PROVE DI COMPRESIONE DEI MOTORI DIESEL E BENZINA

- M24
- M20
- M24
- M20
- Ø 10, 12, 14, 18mm



53096

28,80€



CHIAVE SERBATOIO CALIBRI

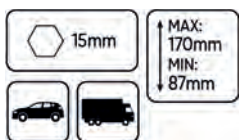

ALFA ROMEO, BMW, CHRYSLER, CITROËN, DAEWOO, FIAT, FORD, HONDA, HYUNDAI, ISUZU, JEEP, KIA, LADA, LANCIA, LAND ROVER, LDV, MAZDA, MERCEDES, MG, MITSUBISHI, NISSAN, PEUGEOT, RENAULT, ROVER, SAAB, SSANGYONG, SUZUKI, TOYOTA, VAG, VAUXHALL/OPEL, VOLVO

54373

395,00€



MANOMETRO COMUNE AD ALTA PRESSIONE



x2 M12x1,25	x6 M12x1,50
x2 M14x1,25	x6 M14x1,50

Uno strumento essenziale per misurare l'alta pressione generata dalla corsa di compressione nel cilindro dell'aria di un motore diesel. È dotato di una serie di adattatori per diverse specifiche e connessioni in grado di misurare diversi tipi di motori diesel.



N

54312

191,50€



TESTER COMPRESIONE DIESEL



DIAMETRO INTERNO

10, 12, 14, 18mm

DIAMETRO INTERNO

M20, M22, M24

ALFA, BMW, FIAT, FORD, LDV, PSA, RENAULT, SUZUKI, SAAB, CHRYSLER, DAEWOO, HYUNDAI, MERCEDES, MITSUBISHI, NISSAN, LANDROVER, MAZDA, ISUZU, OPEL.



N

52599

230,00€



TESTER PRESSIONE CARBURANTE

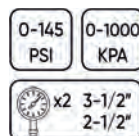

52489

58,00€



TESTER COMPRESIONE DIESEL

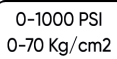

M18x1.5mm

M24x1.5mm

M24x2.0mm

M10x1.0x68mm

M10x1.25x45mm

M10x1.25x54mm

M10x1.25x68mm

FORD, BMW, MERCEDES BENZ, VW, CITROËN, MITSUBISHI, TOYOTA, PEUGEOT, RENAULT, VOLVO, MAZDA.

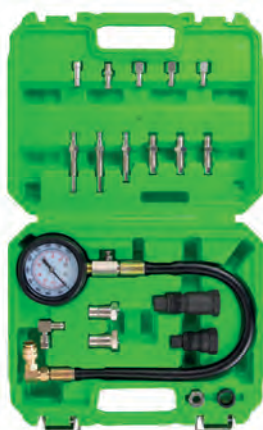

52685

88,00€



TESTER COMPRESIONE MOTORI DIESEL PER CAMION



M18

M24



53997

48,00€

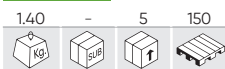

VERIFICATORE DI PRESSIONE PER CIRCUITI BENZINA

0-10 BAR 0-140 BAR

LUNGHEZZA	25,5cm (1), 29,5cm (2), 110cm (3)
DIAMETRO ESTERNO	1,2cm (1), 1,2cm (2)
DIAMETRO INTERNO	0,6cm (1), 0,6cm (2)



54016

76,00€



POMPA DI CONTROLLO, PRESSIONE E VUOTO PER CIRCUITI

PRESSIONE MASSIMA

40 PSI (3 BAR)

PRESSIONE MINIMA

-20 PSI (-0,75 BAR)



52488

28,00€



SET VERIFICA COMPRESSIONE - BENZINA

0-300 BAR
0-21 Kg/cm2



53489

68,00€

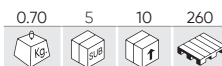

MANOMETRO DELLA PRESSIONE DEL TURBOSOFFIANTE

-1~3 BAR 2m



52076

111,00€



RIPARATORE DEI FILETTI DELLE CANDELETTE

- 1 Utensile d'inserzione - 2u.
- 2 Maniglia per pezzo 8 - 1u.
- 3 Filetti M8 x 1.0 - 5u.
- 4 Filetti M10 x 1.0 - 5u.
- 5 Filetti M10 x 1.25 - 5u.
- 6 Filetti M12 x 1.25 - 5u.
- 7 Teste d'inserzioni - 3u.
- 8 Bacchetta d'inserzione di filetto - 1u.
- A Inserzione di taglio M14 x 1.25 (per filetti da M12 x 1.25) - 1u.
- B Inserzione di taglio M12 x 1.25 - 1ud.
- C Inserzione di taglio M12 x 1.0 (per filetti da M10 x 1.25) - 1u.
- D Inserzione di taglio M10 x 1.25 - 1ud.
- E Inserzione di taglio M10 x 1.0 (per filetti da M8 x 1.0) - 1u.
- F Inserzione di taglio M8 x 1.0 - 1u.



REF.			€
11893	M8x1.0	0.01 5	7,00€
11894	M10x1.0	0.01 5	7,00€
11895	M10x1.25	0.02 5	8,65€
11896	M12x1.25	0.02 5	8,80€

UTENSILERIA

52813

79,00€

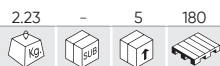

SET DI SMERIGLIATORE PER SEDI INIETTORI 17 PZ

17 PCS



	x8	14x14, 15x19, 15.5x15.5, 17x17x, 17x17.5, 17x19, 17x19.5, 17x20mm
	x4	15.5x15.5, 17x17, 17.5x20.5, 17x21mm
	x1	19x21.5mm

	x1	19x225mm
	x1	19x170mm
	x1	19mm
	x1	2.5mm

52273

44,00€



SET SMERIGLIATORE PER SEDI INIETTORI

8 PCS

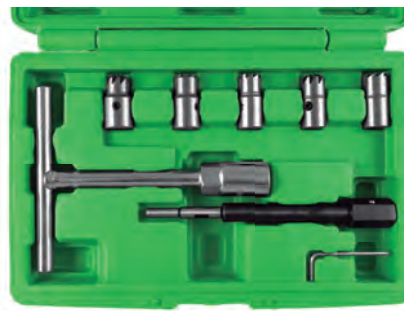

	x3	15x19mm 17x17mm BMW, PSA, Renault, Ford 17x19mm Mercedes CRD
	x2	17x17mm Mercedes 17x21mm Fiat/Iveco

	x1	12mm
	x1	19mm
	x1	

53650

47,00€

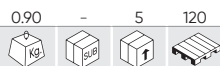

SET DI PULIZIA DEI SEDILI DI INIETTORI

19 PCS



REF.	DESCRIZIONE				€
14348	SET DI 3 SPAZZOLE PULITRICI IN OTTONE (RIF. 53650)	0.05	-	50	12,50€
14349	SET DI 2 SPAZZOLE PULITRICI IN SILICONE (RIF. 53650)	0.07	-	100	20,50€

53330

38,00€



KIT DI BUSSOLE PER POMPA DI INIEZIONE

5 PCS 1/2" 1/4" Cr-V



52801

26,00€



POMPA INIETTORE DIESEL



52821

28,80€



CHIAVE DOPPIA APERTA PER INIETTORE

17mm



PUNZONI

Consentono di applicare la marcatura alfanumerica su tutte le superfici metalliche mediante il metodo d'impressione o d'impatto. L'area di lavoro arrotondata previene la creazione delle crepe o delle fratture sulla superficie trattata.

52422 24,70€

0.82 3 6 540

A-Z & 0-9

36 PCS 3/16"

5mm

53119 52,00€

1.94 3 6 504

A-Z & 0-9

36 PCS 5/16"

8mm

52882 14,00€

0.30 10 60 1500

9 PCS 1/4"

6mm 0-8

51120 41,00€

2.10 - 5 120

KIT PREMIMOLLE PER VALVOLE

- Valido per auto e per moto.
- 15 adattatori permettono il celere e facile inserimento del premimolle per valvole.

CONTIENE
- Premimolle.
- Adattatori: 30, 25, 23, 19, 16mm.

52734 51,00€

2.61 - 5 175

KIT PREMIMOLLE PER VALVOLE 45-145MM

52693 24,50€

0.65 5 20 450

KIT PREMIMOLLE PER VALVOLE

53251 88,00€

2.80 - 4 60

KIT PER COMPRIMERE ANELLI DEL PISTONE

H:3" Ø 53-125mm

H:4" Ø 60-175mm

H:6" Ø 60-175mm

52697 16,00€

0.50 5 40 720

COMPRESSORE PER ANELLO PISTONE 6"

6" Ø 60-175mm

150mm

52696 12,00€

0.28 5 40 1200

COMPRESSORE PER ANELLO PISTONE 3"

3" Ø 53-175mm

77mm

PINZA PER FASCE PISTONE

REF.	DESCRIZIONE					€
54273	40-100mm	0.30	6	30	-	10,10€
54274	80-120mm	0.35	6	30	-	11,00€
54275	100-160mm	0.40	6	30	-	13,20€



52591 12,00€

0.10	12	72	1728

LEVIGATORE PER CILINDRI - 2 BRACCI 1 - 1/8"

1-18"
28,60mm
MAX: Ø 55mm
MIN: Ø 19mm



52592 22,00€

0.20	-	20	480

LEVIGATORE PER CILINDRI - 3 BRACCI 2"

2"
50,80mm
MAX: Ø 85mm
MIN: Ø 35mm



52593 34,00€

0.47	6	36	648

LEVIGATORE PER CILINDRI - 3 BRACCI 4"

4"
101,60mm
MAX: Ø 170mm
MIN: Ø 55mm



REF.	DESCRIZIONE					€
11878	SET DI 2 PASTIGLIE LUCIDANTI 1-1/8" PER RIF. 52591	0.10	25	100	-	4,10€
11879	SET DI 3 PASTIGLIE LUCIDANTI 2" PER RIF. 52592	0.04	25	100	-	5,10€
11880	SET DI 3 PASTIGLIE LUCIDANTI 4" PER RIF. 52593	0.09	25	100	-	10,50€

53662 89,00€

1.78	5	10	80

RILEVATORE PERDITE PER GUARNIZIONE TESTATA CILINDRI

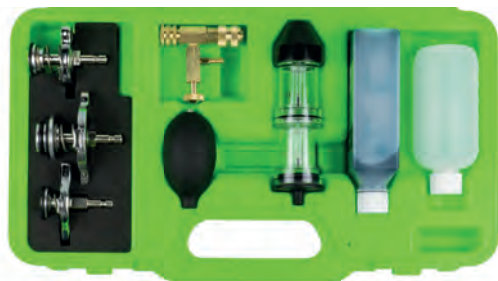

CONTIENE

- Bottiglia rotonda da 200 ml.
- Flacone quadrato da 250 ml.

ADATTATORI

- Piccoli: Suzuki, Toyota, Mitsubishi.
- Mezzi: Suzuki, Toyota, Mitsubishi, Subaru, Peugeot, Nissan, Lexus, Mazda.
- Grandi: Ford, GM, Benz, JEEP.

REF.	DESCRIZIONE					€
14563	TESTER DI COMBUSTIONE RILEVATORE DI PERDITE	0.23	5	50	-	18,00€

54347 46,00€

2.00	-	5	100

TESTER DI PERDITA DEL CILINDRO

7 BAR 100 PSI

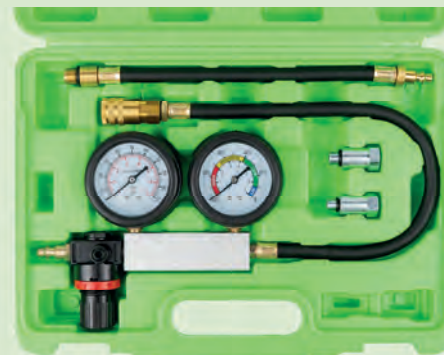

Si utilizza per controllare le perdite di un cilindro.

M12x1.25
M14x1.2

52832

75,00€

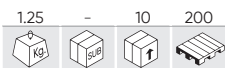

KIT DI CHIAVI CURVE PER ESTRAZIONE DELLA CINGHIA TESTA INTERCAMBIABILE



TESTA INTERCAMBIABILE

x8		12, 13, 14, 15, 16, 17, 18, 19mm	x1	
x1				

52690

54,00€

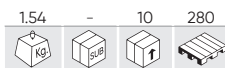

CHIAVE PER SBLOCCARE PULEGGIA

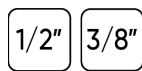

x4		3/8" - 13, 15, 16, 18mm	x1		1/2" - 230mm
x3		3/8" - 13, 14, 15mm	x1		3/8" - 585mm

53669

45,00€

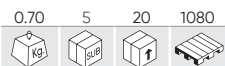

SET DI 10 BUSSOLE SPECIALI PER AUTO



- 10S** per l'ingranaggio intermedio Toyota
- 6S** per giunti, testata del blocco e albero di bilanciamento Nissan e Renault
- 8S** per giunti, testata del blocco e albero di bilanciamento Nissan e Renault
- 12S** per giunti, testata del blocco e albero di bilanciamento Nissan e Renault
- 8TS** per l'albero di bilanciamento Nissan
- 14mm** per pinze freno di Opel Astra G, Opel Zafira e Smart
- 10mm** per freno e pompa combustibile Nissan
- 12,5mm** per freno e pompa combustibile Nissan
- 19mm** per pinze freno Peugeot, Renault e Citroen
- 20mm** per leva inferiore di sospensione libera di Honda Civic

53053

12,00€

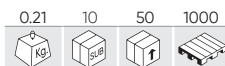

GANCI PER ESTRAZIONE DI GIUNTURA

1x15,5cm/1x16,5cm/1x12cm



53637

85,00€

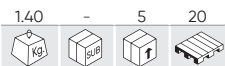

ORGANIZZATORE SPECIALE PER LE PARTI DELLA TESTATA

- Speciale per le parti della testata.
- Mantiene tutti i componenti puliti e in ordine mentre vengono rimossi dalla testata.
- Risparmia tempo. Semplifica il tuo lavoro.



52850

7,80€

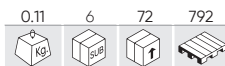

SET DI 2 PEZZI VALVOLE LAPPATURA



UTENSILERIA

51989

49,00€



VALIGETTA CON 38 SPAZZOLE METALLICHE / PLASTICHE

38 PCS

Ø 8, 9, 10, 11, 12, 13, 14, 15, 16, 17, 18, 19mm



- 1 Manico da 1/4".
- 1 prolunga.
- 36 spazzole.

52760

4,10€

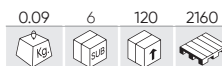

SPAZZOLE METALLICHE



52515

9,10€

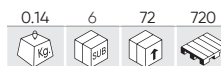

SET DI 3 SPAZZOLE METALLICHE

- 1 x Ottone.
- 1 x Nylon.
- 1 x Acciaio.



52819

22,00€

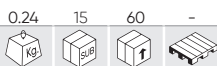

BUSSOLE 1/2" (MERCEDES)

58 DENTI



53129

84,00€

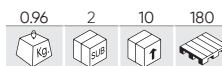

INSTALLATORE REGOLABILE DI SIGLLI 18-90MM



53875

134,00€



DISPOSITIVO DI RIMOZIONE/INSTALLAZIONE DI FLANGE SIGILLATE DELL'ALBERO A GOMITO (GRUPPO VAG)

MODELLO	VW: GOLF, TOURAN AUDI: A3, A4
UTENSILI OEM	T10134
CODICE MOTORE	1.4I TURBO 1.4 E 1.6 INIEZIONE DIRETTA DI CARBURANTE 1.9 / 2.0 SDI 2.0 MOTORI DIESEL COMMON RAIL



52190

8,00€

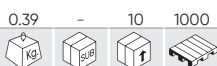

ESTRATTORE FRIZIONE SPECIALE FIAT

220x110mm



52495

14,50€

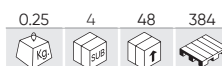

CENTRAFRIZIONE IN PLASTICA - UNIVERSALE

- Per la maggior parte dei modelli in commercio.
- Include 3 adattatori di diverso diametro.



53001

242,00€

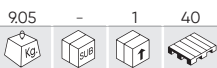

KIT PER CENTRAGGIO FRIZIONE SAC

VW, AUDI, BMV, MERCEDES, VOLVO, RENAULT, OPEL

- Si evitano deformazioni della frizione utilizzando il pretensionatore.
 - Utilizzando l'utensile di azzeramento si porterà alla nuova posizione l'anello di regolazione della piastra reggispinta quando si monta una nuova valvola della frizione.
 - Adatto a quasi tutte le frizioni SAC (frizioni a recupero automatico del gioco).

VANTAGGI
 Messa in tensione della piastra reggispinta della frizione nel montaggio e smontaggio.
 Riposizionamento della molla di regolazione con l'utensile di azzeramento.
 Centraggio della valvola rispetto al cuscinetto guida.

CONTIENE
 Pretensionatore della frizione.
 Centratore a 3 fori.
 Utensile di azzeramento.
 Kit di perni di centraggio.
 Centratore a 4 fori.



53410

92,00€

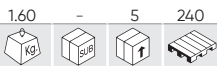

CENTRAGGIO DELLA FRIZIONE SAC

DIAMETRO DI CENTRAGGIO

x3	15-19, 20-26,6, 23-36mm
----	-------------------------

DIAMETRO DI ACCESSORI

x8	12, 14, 15, 16, 17, 18, 19, 20mm
----	----------------------------------

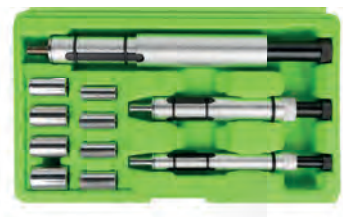

53057

149,00€

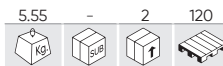

KIT DI RIPARAZIONE DI FRIZIONE DI DOPPIA FACCIA PER LA TRASMISSIONE DSG DE VAG

- Per il servizio di DSG in Golf (2004-), Golf Plus (2005-), AUDI A3 (2004-) con 7 trasmissioni a velocità di codice OAM, e Touareg (2003-) con 6 velocità codice di trasmissione 08D.
 - Riferimenti: OEM T10323, T10373, T10374.



50731

68,00€



RIFRATTOMETRO PER ALCOL



52963

49,00€

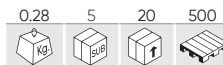

RIFRATTOMETRO UNIVERSALE

- Glicole etilenico: -50°C ~ -0°C.
 - Glicole propilenico: -50°C ~ -0°C.
 - Fluido di pulizia: -40°C ~ -0°C.
 - UREA AUS32: - 30% ~ 35%.
 - Fluido di batteria: - 1.100 - 1.400 sg/l.



UREA AUS32

53477

36,10€

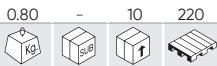

SET DI 8 MORSETTI PER LA DESCONNESSIONE DEI TUBI

8 PCS
 NYLON

H	8mm
	10mm
	13mm



53426

39,80€

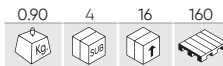

TESTER DI PRESSIONE E VUOTO

PRESSIONE PRESSURE	0-0,7Kg/cm ² (0-10 PSIG)
VACUO VACUUM	0-28 inHg (0-70 cmHg)



UTENSILERIA

52066

12,00€

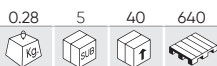

SET DI 3 PINZE PER MANICHETTA FLESSIBILE



0-20mm
0-35mm
0-70mm



53395

16,00€

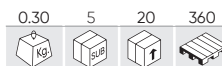

SET DI 3 PINZE PER MANICHETTA FLESSIBILE



Ø13mm
Ø20mm
Ø35mm



52687

168,00€



RILEVATORE DI PERDITE DI PRESSIONE PER SISTEMA DI RAFFREDDAMENTO



- 1 Pompe a pressione con valvola di scarico
- 2A Connettore 1: accoppiamento per i testine No.3(R123) e No.4 (R124)
- 2B Connettore 2: accoppiamento per i testa No. 3(R123) e No. 5(R125)
- 3 Mercedes (W123, W126, W124, W201), GM(Buick), Jeep
- 4 Peugeot, Subaru, Chrysler, Acura, GM (Nova, Spectrum, Sprint), Mitsubishi, Nissan, Mazda, Toyota, Infiniti, GEO, Suzuki, Isuzu, Mercedes
- 5 Honda, Toyota, Suzuki, Mitsubishi, Chrysler, Acura
- 6 Mercedes Benz (ML, W163, W164), GM (Achiva, Skylark, Grand Am 1992~2002)
- 7 Volvo, Saab, Sterling, Citroën, Renault, Fiat, Alfa, Jeep
- 8 VW(Vento, T4, Passat-1996, Golf, Beetle, Sharan)
- 9 Audi(A4, A5, A6), BMW 345, VW (Passat - 1997-2002), Porsche(Cayenne)
- 10 BMW (E46, E36, E34, E39, E38, E32, E90)
- 11 Audi, VW
- 12 Internacional, Land Rover, Jaguar
- 13 Mercedes (C, E, S, W140, W220, W124, W210, W211, W215, W216, W221, R230)
- 14 Ford Focus
- 15 Mazda(M3)
- 16 Mercedes classe A (W168)
- 17 BMW E60, E63, E64, E65
- 18 VW SHARAN 1.8T 2.8
- 19 TOYOTA-RAV4, PREVIA adattatore di gomma universale per lo spurgo e riempimento radiatori



- 20 SAAB
- 21 LAND ROVER
- 22 Kia
- 23 Hunday

54139

147,00€



TESTER UNIVERSALE PER PERDITE DI PRESSIONE PER SISTEMA DI RAFFREDDAMENTO (5 PZ)



x1 17-24mm
x1 28-31.5mm
x1 37-39.5mm
x1 47-48.5mm



53453

7,00€

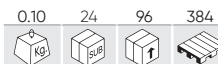

TESTER PER LIQUIDO ANTIGELO

-43°C
131°C



54368

2.329,00€

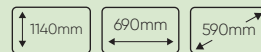
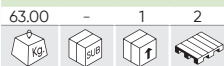

MACCHINA PER LA PULIZIA DEL SISTEMA DI RAFFREDDAMENTO

Cette machine vous permet de nettoyer et de remplir l'ensemble du système de refroidissement du véhicule de manière rapide et efficace. Grâce à la génération de pression, il fait circuler le liquide de refroidissement dans tout le système et le nettoie de différentes impuretés. Il est compatible avec différents types de réfrigérants.

La machine se connecte en 12V à la batterie du véhicule et dispose d'une interface intuitive qui, avec son écran tactile, ses deux manomètres et ses deux écrans pour observer l'état du fluide, la rendent très simple à utiliser. Il dispose de connecteurs rapides, de tuyaux et d'adaptateurs pour effectuer la tâche confortablement dans la grande majorité des véhicules. Il contient deux réservoirs de 20 litres, un pour le liquide de refroidissement neuf et l'autre pour le liquide de refroidissement usagé, tous deux vidés par la machine elle-même. Dans les circuits présentant de la rouille ou de l'huile, l'utilisation d'additifs est recommandée pour un plus grand pouvoir nettoyant.

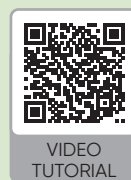

53539

66,00€



KIT LOCALIZZAZIONE FUGA AA/CC

CONTIENE

- 1 x lampada UV 100Lm.
- 1 x occhiali per la visione UV.
- 1 x siringa per inserti liquidi.
- 1 x adattatore rapido.
- 1 x prolunga adattatore.
- 1 x caricatore.
- 1 x batteria ricaricabile.



REF. DESCRIZIONE

REF.	DESCRIZIONE	Q1	Q2	Q3	€
15052	BATTERIA RICARICABILE PER N. 53539	0.05	5	10	3,00€
15053	CARICABATTERIE PER N. 53539	0.08	-	10	10,50€
15054	LAMPADA PER N. 53539	0.12	-	50	34,00€
14187	OCCHIALI ANTI UV (RIF. 53539)	0.05	10	120	6,00€
12200	SIRINGA DI RILEVAMENTO PERDITE NELL'IMPIANTO DI CONDIZIONAMENTO DELL'ARIA (RIF. 52844)	1.10	-	50	14,50€

54291

5.054,00€

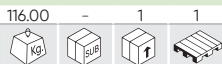

MACCHINA PER RICARICA DELL'ARIA CONDIZIONATA

200V ±10% **R134A R1234YF**

3/8 HP **>2 Kg/min** **100 L/min**

450g/min **800g/min** **12,12 cm³**

LCD 360x128mm **50-60 Hz** **-10° 50°**

99% **<-85%** **180W**

Questa macchina è stata progettata per eseguire lavori di pulizia, recupero del refrigerante, aspirazione, iniezione d'olio e ricarica del refrigerante nel sistema di climatizzazione del veicolo. È completamente automatico. La macchina eseguirà tutte le lavorazioni senza che l'operatore debba controllarlo in ogni momento.

PRINCIPALI CARATTERISTICHE

- COMPLETAMENTE AUTOMATICO
- FACILE DA USARE
- CON AMPIA FINESTRA DI ISPEZIONE E RETROILLUMINAZIONE A LED
- I MANOMETRI FACILITANO L'OSSERVAZIONE DEI VALORI DI PRESSIONE
- ALTO TASSO DI RECUPERO DI GAS E OLIO
- CON AMPIO SCHERMO LCD
- CON DATABASE E STAMPANTE
- IL SOFTWARE E IL DATABASE POSSONO ESSERE AGGIORNATI



RICAMBI DISPONIBILI



VIDEO TUTORIAL

16309

149,00€

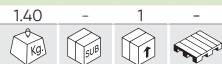

SET DI 2 TUBI FLESSIBILI PER ALTA E BASSA PRESSIONE DI 5 METRI DI LUNGHEZZA (RIF. 54291)



ADATTATORE PER LA CARICA DAL GAS 1234YF

R1234YF Raccordo rapido per refrigerante nel sistema di condizionamento d'aria. La costruzione per connessione rapida è dotata della protezione interna. Boccola che protegge contro danni e perdite del refrigerante in caso di stacco del giunto sotto pressione. Applicazioni: condizionamento d'aria e raffreddamento.



53499

29,00€

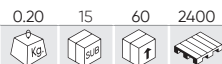

ADATTATORE PER LA CARICA DAL GAS 1234YF (ALTO)

- Rosso (alta pressione).
- Materiale: ottone e metallo.
- Peso: 194g.



53500

29,00€

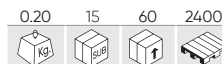

ADATTATORE PER LA CARICA DAL GAS 1234YF (BASSO)

- Blu (bassa pressione)
- Materiale: ottone e metallo.
- Peso: 175g.



53456

98,00€

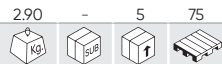

SET DI CONTROLLO, RIEMPIIMENTO E SVUOTAMENTO AACC (BAR)

BAR LOW: 0-24BAR HIGH: 0-34BAR

PSI LOW: 0-350PSI HIGH: 0-500PSI



REF.	DESCRIZIONE	Kg	Sub	Unit	€
14300	GIUNTO RAPIDO PER ALTA PRESSIONE (RIF. 53456)	0.15	-	100	19,00€
14301	GIUNTO RAPIDO PER BASSA PRESSIONE (RIF. 53456)	0.15	-	100	19,00€

16316 18,50€

0.30 - 12 -

N

OLIO UNIVERSALE PAG PER ARIA CONDIZIONATA 250ML

12977 36,50€

0.33 3 12 480

LIQUIDO RILEVAMENTO PERDITE SISTEMA AACC 250ML

- Un'applicazione di 7,5 ml per ogni 1.4L refrigerante.

50807 38,00€

0.16 6 24 744

ORGANIZER DI O-RING PER ARIA CONDIZIONATA

Ø	PCS	Ø	PCS
5.29x1.78	20	8.80x1.90	20
6.07x1.78	20	10.82x1.78	15
6.8x1.9	20	10.77x2.62	15
7.65x1.78	20	11.0x2.0	15
7.80x1.90	20	12.0x2.0	15
8.0x2.0	20	13.9x1.80	10

Ø	PCS
13.95x2.62	10
14.0x2.0	10
15.0x2.0	10
17.0x2.0	10
17.17x1.78	10
17.04x3.53	10

53599 30,30€

0.16 10 100 -

SET DI ANIME DELLA VALVOLA PER SISTEMA DI ARIA CONDIZIONATA

RICAMBI DISPONIBILI

REF	mm	PCS	€
14594	5x19mm R12	50	2,00€
14595	5x19mm	30	1,50€
14596	5x19mm R12	30	2,00€
14597	6x19mm	3	7,60€
14598	6x26mm	1	17,80€
14599	7x20mm R134A	10	4,50€
14600	6x22mm	5	9,50€
14601	8x22mm	1	11,00€
14602	9x22mm	4	11,00€

53459 66,00€

1.05 - 10 150

ATTREZZO PER STACCO DI SISTEMA DELL'ARIA CONDIZIONATA

DIAMETRO MORSETTI

x6 8mm (5/16"), 9.5mm (3/8"), 13mm (1/2"), 16mm (5/8"), 19mm (3/4"), 22mm (7/8")

DIAMETRO BLOCCATORE

x4 9.5 mm (3/8"), 16mm (5/8"), 13mm (1/2"), 19mm (3/4")

51364 26,00€

2.00 - 5 315

ESTRATTORE DI GIUNTI OMOCINETICI

Ø 31mm 140-240mm

54069 29,50€

0.20 10 40 360

SET DI STRUMENTI PER LA PULIZIA DEI MOZZI, 14 PZ.

x1 Ugello da 8 mm con adattatore da 1/2"

x1 Mola con asse tonda e testa esagonale da 8 mm

x2 Piastre sostituibili con sottobase adesivo

x5 Dischi pulitori a grana grossa, diametro esterno 40 mm

x5 Dischi pulitori a grana fine, diametro esterno 40 mm, diametro interno 14 mm

51364 26,00€

2.00 - 5 315

ESTRATTORE DI GIUNTI OMOCINETICI

Ø 31mm 140-240mm

53638

243,00€

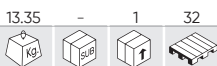

ESTRATTORE MOZZO RUOTA IDRAULICO

- Questo kit comprende 3 estrattori / martelli appositamente progettati per semplificare la rimozione del mozzo della ruota e rilasciare l'albero del mozzo senza danneggiarlo:

- Mandrino idraulico
- Vite
- Martello a percussione
- Per estrazione manuale o idraulica.
- Con una capacità massima di 10 TON.
- Martello da 4 kg.
- Lunghezza della barra: 57 cm.
- Per 3, 4, 5 e 6 fori.



REF. DESCRIZIONE



15253 MANDRINO IDRAULICO PER N. 53384/53638

1.35 1 10 62,00€

54384

32,50€



DETERGENTE PER MOZZI RUOTA

Ti aiuta a pulire l'ossidazione e la corrosione presenti sul mozzo della ruota. Dispone di una striscia in velcro per installare facilmente il disco abrasivo.

Diametro esterno: 150 mm
Diametro interno: 90 mm
Velocità massima: 500 giri/min



REF. DESCRIZIONE



16448 DISCO PER LA PULIZIA DEI MOZZI RUOTA (RIF. 54384) 0.11 16 64 16,50€

52829

19,00€



UTENSILE PER IL MONTAGGIO DEL SOFFIETTO SEMIASSE

ESTERNO

Ø 10cm

INTERNO

Ø 9,5cm

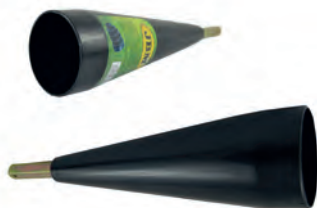

52541

45,00€



TESTER MECCANICO PER GIUNTI SFERICI



- Ideale per verificare: cuscinetto sterzo, cuscinetto ruota, silentblocks, stabilizzatore ruota, ecc.



51121

27,30€



KIT PREMIMOLLA AMMORTIZZATORE

- Artigli e vite forgiati in lega ferro-carbonio, temperati per garantirne una qualità professionale.
- Utensile specialmente creato per l'uso in spazi limitati e sotto il passaruota, che offre la massima protezione.
- Apertura massima: 250 mm.

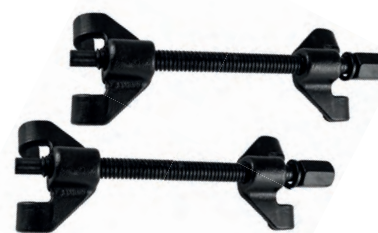

270mm

50827

387,00€

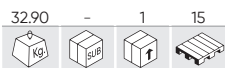

PREMIMOLLA AMMORTIZZATORE



- Capacità: 1T (2200 lbs)
- Diametro della molla compressa: 200mm
- Lunghezza di compressione: 200-500mm

200-500mm

53742

1.325,00€

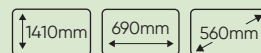
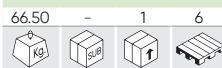

PREMIMOLLA AMMORTIZZATORE 1T



- Capacità di carico: 1000 kg
- Max. lunghezza di lavoro: 450 mm
- Corsa del cilindro: 420 mm
- Diametro molla: Ø102-165mm
- Direzione di avvolgimento: in senso orario
- Principio di funzionamento: pneumatico
- Pressione dell'aria: 6,5-9 bar (94,27-130,53 psi / 0,65-0,9 MPa)
- Modalità operativa: pedale

53394

598,00€

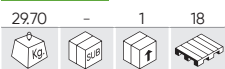

COMPRESSORE DELLA MOLLA

- Braccio telescopico e superfici antiscivolo che consentono una presa solida delle molle.
- Artigli dotati di una protezione in plastica intercambiabile per evitare di danneggiare la vernice della molla.
- Impedisce che le molle si pieghino in compressione.
- Universale, copre il 90% della flotta di veicoli.
- Può essere utilizzato sia per molle dritte che coniche.

CONTIENE

- Dispositivo / Pistone.
- Tre paia di mascelle con coperture in plastica.



ADATTO PER L'USO CON UTENSILI PNEUMATICI

52227

247,00€



COMPRESSORE DI MOLLA PROFESSIONALE MC PHERSON

- Specifiche tecniche:
Carico massimo: 2500N.
Un corpo principale.
Un sostegno esteso.
3 paia di mascelle.
- Paio 1: Gamma di uso: 80-115mm. Peso: 1.45kg.
- Paio 2: Gamma di uso: 110-195mm. Peso: 2.2kg.
- Paio 3: Gamma di uso: 140-195mm. Peso: 2.3kg.

BMW, TOYOTA, FORD, MITSUBISHI, VW, AUDI, SAAB, NISSAN, HONDA ACCORD, SUBARU, VOLVO, OPEL, PORSCHE.



NON UTILIZZARE CON LA PISTOLA PNEUMATICA

UTENSILERIA

52270

109,00€



ESTRATTORE DI SILENT BLOCK PER VAG

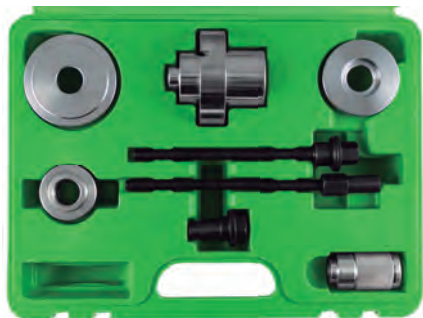

Albero, prolunga albero, barra filettata con dado M10x1.25 spinta

Testa in acciaio al carbonio

Separatore

Pezzo di pressione

Mandrino centraggio lega di alluminio

52432

35,00€



ESTRATTORE SILENT BLOCK POSTERIORE VAG



- Per modello utile VW POLO 2002.

- Facile cambiare le boccole in gomma sull'asse anteriore.

ESTRATTORE

REF.	DESCRIZIONE	MAX	MIN					€
51368	CHIAVE UNIVERSALE PER TIRANTE INTERNO	42mm	33mm	0.41	5	50	2700	19,00€
51369	ESTRATTORE DI DADI ASSIALI	42mm	35mm	0.55	6	36	756	28,00€
51414	ESTRATTORE PER VITI PRIGIONIERE	20mm	15mm	0.59	5	40	1440	14,00€



51368



51369



51414

52834

195,00€

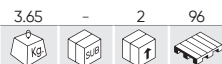

VALIGETTA DI BUSSOLE CON RISALTI ESTERNI

11 PCS 1/2" Cr-Mo

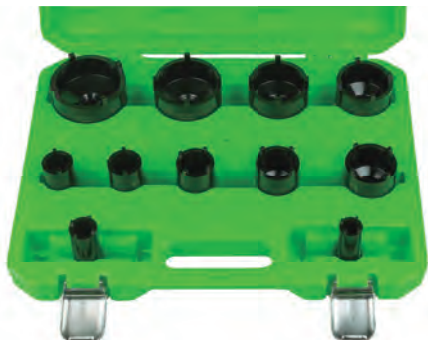

x11 22x3.3mm, 26x3.8mm, 30x4.3mm, 33x4.0mm, 37x4.8mm, 44x5.3mm, 50x5.8mm, 56x5.8mm, 63x6.3mm, 69x6.8mm, 75x6.8mm

52835

272,00€

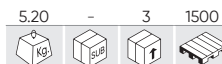

KIT BUSSOLE DENTI INTERIORE

10 PCS 1/2"



x10 26x5.3mm, 1.2x6.25mm, 34.2x6.3mm, 38.2x6.65mm, 42.2x7.3mm, 50.1x8.25mm, 58.2x9.8mm, 74.6x11.9mm, 82.2x13.25mm, 87.7x13mm

ESTRATTORE DEL BRACCIO DELLA DIREZIONE

REF.	DESCRIZIONE					€
52640	Ø 28-35mm	1.80	-	4	256	52,00€
52641	Ø 35-45mm	2.20	-	4	140	55,00€



ESTRATTORE BRACCIO DIREZIONE

REF.	DESCRIZIONE					€
52874	Ø 9-20mm	1.20	4	20	1500	82,00€
52875	Ø 14-23mm	1.25	5	20	1500	79,00€



53635



ESTRATTORE CUSCINETTI CON MAZZA BATTENTE

- Mazza battente: 4 kg.
- Diametro: 100-115mm.
- Per viti M12.



85,00€

440-630mm

51490

36,00€



KIT ESTRATTORE-SEPARATORE DI SNODO SFERICO



MANICO DA UTILIZZARE CON UN MARTELLINO
FORCELLE: 11/16", 15/16" E 1" 1/8

53384

165,00€



ESTRATTORE IDRAULICO PER SNODI SFERICI

- Apertura: 100mm.
- Larghezza: 35mm.



REF.	DESCRIZIONE				€
15253	MANDRINO IDRAULICO PER N. 53384/53638	1.35	1	10	62,00€

53208

126,00€



SET VITE DI SICUREZZA PER BMW



APPLICAZIONI

BMW Serie 1 F20/F21
BMW Serie 3 F30/F31
BMW Serie 4 F32/F34/F36

BMW Serie 5 F10/F11
BMW Serie 6 F12/F13
BMW Serie 7 F01/F02/F04

x20 41, 42, 43, 44, 45, 46, 47, 48, 49, 50, 51, 52, 53, 54, 55, 56, 57, 58, 59, 60

53207

118,00€



SET DI BUSSOLE PER RIMUOVERE LE VITI DI SICUREZZA VW



x1 B51 / 6PT			
x1 B52 / 7PT			
x1 B53 / 8PT			
x1 B54 / 9PT			
x1 B55 / 10PT			
x1 B56 / 11PT			
x1 B57 / 12PT			
x1 B58 / 13PT			
x1 B59 / 14PT			
x1 B60 / 15PT			
x1 B61 / 16PT			
x1 B62 / 17PT	x1 ABC3 / 14PT		
	x1 ABC4 / 15PT		
	x1 ABC5 / 16PT		
	x1 ABC6 / 17PT	x1 ABC7 / 19PT	
		x1 ABC8 / 20PT	
		x1 ABC9 / 21PT	

52802

54,00€

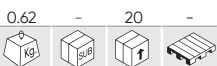

SET DI BUSSOLE PER RIMUOVERE LE VITI DI SICUREZZA PER BMW

10 PCS BMW



x1	30/13 PT
x1	31/15 PT
x1	32/16 PT
x1	33/17 PT
x1	34/18 PT

x1	35/19 PT
x1	36/20 PT
x1	37/21 PT
x1	38/22 PT
x1	40/23 PT

53328

76,00€

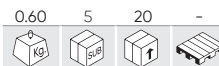

SET DI BUSSOLE PER RIMUOVERE LE VITI DI SICUREZZA PER MERCEDES

12 PCS

MERCEDES



APPLICAZIONI

A, B, C, GLK, CLC, CLS, CLK, E, SL, SLK, M, C300, C250, C350, E320, 204, 211, 212, R

51998

38,00€

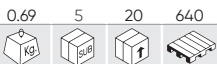

KIT DI BUSSOLE TWIST DI 3/8" PER L'ESTRAZIONE DI DADI/BULLONI DI SICUREZZA

10 PCS 3/8" Cr-Mo

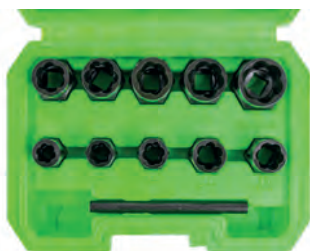

RICAMBI DISPONIBILI

REF.	mm	Kg	Q	€
16737	9mm	0.07	100	12,00€
11434	10mm	0.04	100	12,00€
11435	11mm	0.04	100	12,00€
11436	12mm	0.04	100	12,00€
11437	13mm	0.04	100	12,00€

REF.	mm	Kg	Q	€
11438	14mm	0.06	100	12,00€
11439	15mm	0.06	100	12,00€
11440	16mm	0.06	100	12,00€
11441	17mm	0.08	100	12,00€
11442	19mm	0.09	100	12,00€

52962

42,00€

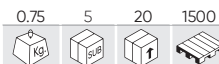

KIT DE BUSSOLE TWIST 3/8" PER L'ESTRAZIONE DI DADI/BULLONI DI SICUREZZA 6-19MM

11 PCS 3/8" Cr-Mo



RICAMBI DISPONIBILI

REF.	mm	Kg	Q	€
11450	6mm	0.07	100	12,00€
12093	8mm	0.07	100	12,00€
11434	10mm	0.04	100	12,00€
11435	11mm	0.04	100	12,00€
11436	12mm	0.04	100	12,00€
11437	13mm	0.04	100	12,00€

REF.	mm	Kg	Q	€
11438	14mm	0.06	100	12,00€
11439	15mm	0.06	100	12,00€
11440	16mm	0.06	100	12,00€
11441	17mm	0.08	100	12,00€
11442	19mm	0.09	100	12,00€

52823

124,00€

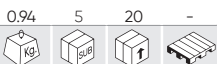

SET VITI DI SICUREZZA PER AUDI

22 PCS VAG

A, B, C, E, F, G, H, I, J, L, M, N, P, Q, R, S, T, V, W, X



x20 A, B, C, E, F, G, H, I, J, L, M, N, P, Q, R, S, T, V, W, X

54317

124,00€

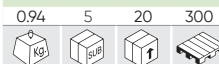

SET VITI DI SICUREZZA PER VAG

22 PCS VAG CR-MO

521,522,523,524, 525,526,527,528, 529,530,531,532, 533,534,535,536, 537,538,539,540



x20 521,522,523,524,525,526,527,528,529,530,531,532,533,534,535,536,537,538,539,540

52153

46,00€

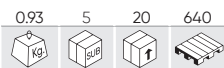

KIT DI BUSSOLE TWIST 1/2" PER L'ESTRAZIONE DI DADI / BULLONI DI SICUREZZA



RICAMBI DISPONIBILI

REF.	mm				€	REF.	mm				€
11443	17mm	0.02	25	100	14,00€	11446	23mm	0.03	25	100	15,00€
11444	19mm	0.02	25	100	14,00€	11447	27mm	0.03	25	100	15,50€
11445	21mm	0.02	25	100	15,00€						



54253

166,00€



KIT DI RIMOZIONE VITI DI SICUREZZA DELLE RUOTE

Master Kit semplice da usare in grado di rimuovere praticamente tutti i dadi di bloccaggio delle ruote. Il kit include protezioni, che proteggono la ruota da eventuali danni. Strumento molto efficace e indispensabile per l'officina Il kit contiene due dimensioni di lame da taglio a percussione per adattarsi ai più comuni dadi di bloccaggio delle ruote tagliando il bordo esterno Sono incluse anche tre lame a doppia faccia da modellare direttamente nella forma della presa.

UNIVERSALE: Rimuove un'ampia gamma di dimensioni, tipi e profili, compresi quelli con collari rotanti Include driver a impatto e punzone.

RICAMBI DISPONIBILI

REF.	DESCRIZIONE				€
16300	CUTTER A E MANDRINO (REF. 54253)	0.15	-	100	7,60€
16301	CUTTER B E MANDRINO (REF. 54253)	0.15	-	100	7,60€
16302	CUTTER C (RIF. 54253)	0.05	-	100	7,60€



54299

227,00€

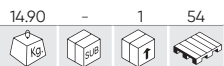

KIT DI INSTALLAZIONE E RIMOZIONE DI MOZZI E CUSCINETTI



	5,3cm		8,6x10,9cm
	5,8cm	B	8,2x10cm
	6,5cm		7,1x9,45cm
	6,6cm		8,9x17,6cm
A	Ø 2,3mm	C	9,9x17,6cm
	7,1cm		12x17,8cm
	7,3cm	D	Ø 2,3mm 9,5cm
	7,8cm	E	Ø 8,6mm 9,55cm
	8,3cm	F	2,4x28cm

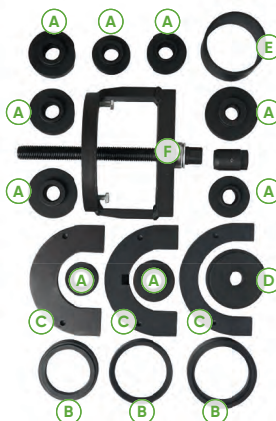

UTENSILERIA

51919

89,00€

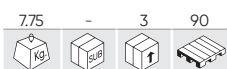

MOLTIPLICATORE DI FORZA CON PROLUNGA

4
PCS



- Materiale: 40 CR.
- Potenza massima: 5800Nm.
- Potenza di lavoro: 3800Nm.
- Multiplo in range 1:56.
- Include bussole di 32mm e 33mm da 1".

52796

98,00€



MOLTIPLICATORE DI FORZA SNODATO

5
PCS 6000
Nm



- Ideale per camion con copri bulloni e carter di protezione.
- Atto a prevenire danni al cerchio.
- Unico nel mercato.
- Si adatta a qualsiasi tipo di veicolo.
- Utile per svitare i dadi bloccati che impediscono la rimozione di ruote o altre strutture.

CONTIENE

- 1 bussola da 1" 32mm.
- 1 bussola da 1" 33 mm.

51958

422,00€



MOLTIPLICATORE A CRICCHETTO DA 3/4"+ RIDUTTORE DA 1/2"

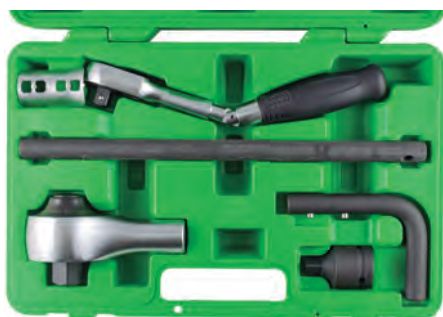

CONTIENE

- 1 moltiplicatore di coppia.
- 1 cricchetto manuale.
- 1 adattatore 1/2" M x 3/4" F.
- 1 kit liberamento.
- 1 prolunga a 90°.
- 1 prolunga da 350 mm.

CARATTERISTICHE

- Rapporto di trasmissione 1:4.
- Rapporto di coppia: 1:3.3.
- Coppia massima d'entrata: 303Nm.
- Coppia massima d'uscita: 1000 Nm.

52012

68,00€



MOLTIPLICATORE DI FORZA JUNIOR

1/2"

PER AUTOMOBILE



CONTIENE

- 1 moltiplicatore di coppia.
- 1 prolunga a 90°.
- Bussole di 17 mm, 19 mm e 21 mm.

- Multiplo in range 1:18.
- Coppia massima d'uscita: 360 Nm.
- Coppia massima di torsione: 800Nm.

ESTRATTORE

REF.	DESCRIZIONE	mm	Max.	Min.					€
52642	ESTRATTORE PER SNODI SFERICI	17-22mm	60mm	20mm	1.32	5	10	660	32,00€
52699	ESTRATTORI PER SNODI SFERICI	18-22mm	50mm	15mm	0.80	5	30	1140	22,00€



52642



52699

51123 91,00€

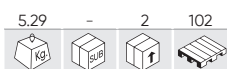

KIT DI 5 ESTRATTORI PER SNODI SFERICI



- Versatile kit di estrattori.
 - Questo sistema permette la facile estrazione dei più popolari tipi di snodi sferici.
 - Il tipo di separazione dell'estrattore dal giunro permette di togliere lo snodo sferico senza i danni alla sede o agli altri elementi che possono causare altri tipi di estrattori.

53488 61,00€



ATTREZZO PER REGOLAZIONE DELLA CAMPANATURA (VAG)



x1	75mm	Seat - Toledo VW - Jeta / Golf
x1	85mm	Seat - Cordoba VW - Polo / 95>
x1	115mm	Chrysler - Voyager
x1	22mm	

51902 84,00€



LEVA PER ESTRAZIONE DI ROTULE DA BRACCIO DI SOSPENSIONE

- Misure:
 Lunghezza: 118cm.
 Diam. tubo: 3,5cm.
 Distanza dei fissaggi: 50, 45, 40, 35, 30cm.
 Fissaggio di 15x13cm.



REF.	DESCRIZIONE	Kg	Volume	Quantità	€
10953	ANCORAGGIO DI RICAMBIO DI FISSAGGIO PER RIF.51902	0.83	-	25	12,50€

51119 62,00€



SET DI 7 PEZZI PER IL SISTEMA D'INIEZIONE LAMBDA

7 PCS 1/2" 3/8"

x1	1/2"	29x9 ~ 90mm
x1	1/2" ~ 7/8"	50mm
x1	1/2"	27x12 ~ 78mm
x1	3/8" ~ 7/8"	6 ~ 90mm
x1	3/8" ~ 7/8"	6 ~ 80mm
x1	3/8" ~ 7/8"	30mm
x1	3/8" ~ 1"	74mm
x1	1" ~ 1/16"	74mm



52637 48,00€



SET DI ESPANSIONE PER SISTEMI DI SCARICO

x1	1-1/8" - 1-3/4"
x1	1-1/2" - 2-1/2"
x1	2-1/8" - 3-1/2"



51491

154,00€



SET DI 14 PEZZI PER IL SISTEMA D'INIEZIONE LAMBDA

14 PCS

17x78mm	12PT	Renault
19x78mm	12PT	VW, Polo, Audi, Seat, Mazda
20x78mm	6PT	Deschis, Japon
27x78mm	6PT	Deschis, Japon
21x90mm	12PT	Seat, Audi, VW, Skoda, Alfa Romeo, Mitsubishi
22x78mm	12PT	Seat, Audi, VW, Skoda, Opel
22x110mm	12PT	Mercedes, Citroën, Peugeot, Ford, Nissan, Mazda, Mitsubishi, Seat, Audi, VW...



51991

54,00€



ALLINEAMENTO DELLE RUOTE

- Lunghezza totale aperta: 1950mm.
- Lunghezza totale chiusa: 1100mm.
- Misura della vite: M6x15mm.
- Tubo esterno: 20x20 in alluminio.
- Tubo interno: 16x16 in ferro zincato.



53118

231,00€



KIT PER SMONTARE AMMORTIZZATORI

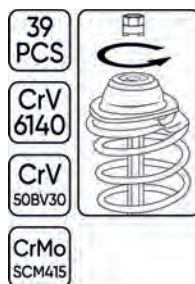

52822

32,00€

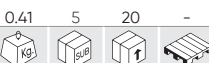

CHIAVE SNODATA PER ESTRAZIONE SONDA LAMBDA 22MM



TESTA ARTICOLATA

52849

8,50€



SET DI 2 GANCI PER ESTRARRE LE GOMME DEL TUBO DI SCARICO



52852

6,80€

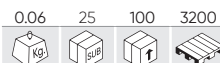

SET DI 2 GANCI PER ESTRARRE LE GOMME DEL TUBO DI SCARICO



51347

9,90€

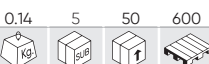

STETOSCOPIO PER MECCANICA

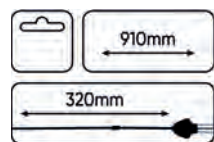

- Amplifica e localizza rumori meccanici interni e di passaggio di fluidi.
- Localizza rapidamente la sorgente di rumore del motore.
- Permette di localizzare razionalmente i problemi nel flusso di acqua, benzina, gas o vapore.
- Manico antiurto.



53249

192,00€

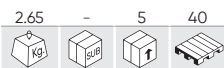

SET DI STETOSCOPIO DI CONTROLLO

Kit idoneo alla rilevazione guasti nei collettori di aspirazione / scarico, iniettori, radiatori ecc.

Consente il monitoraggio simultaneo di più punti del veicolo facilitando il compito dell'operatore nel trovare e diagnosticare i guasti. Sonde a colori che rendono l'operazione facile per l'operatore.

CARATTERISTICHE

- Lunghezza del cavo sensore: 4,8 m
- Lunghezza della sonda audio: 14 cm
- Batterie 9V (incluse)
- Numero di sensori: 6
- Adatto per connettore da 3,5 mm
- Lunghezza del microfono regolabile: 21cm

x1	Tester audio	x6	Canali del microfono
x1	Caschi	x1	Velcro di fissaggio per i sensori
x6	Clip per microfono	x1	Pila quadrata



52293

98,00€

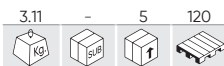

SET DI ESTRAZIONE DI PULLEGE DI 30 PEZZI

A	x1	H38x3 Pins - 20mmL
B	x1	H17x4 Pins - 30mmL
C	x1	3/8" Dr. x H10
D	x1	1/2" Dr. x H10
E	x9	M10xH12 (64mmL), T50xH12 (64mmL), H10xFH10 (68mmL), H8xH10 (75mmL), M8xH10 (75mmL), M10xH10 (75mmL), H10xH10 (75mmL), T40xH10 (75mmL), T50xH19 (75mmL)
F	x3	1/2" Dr. T50 - 17mm x T33 - 100mmL, 1/2" Dr. M10 - 17mm x T33 - 100mmL, 3/8" Dr. M10 - 12mm x T31 - 85mmL,
G	x4	1/2" Dr. T50 - 140mmL, 1/2" Dr. M10 - 140mmL, 1/2" Dr. T50 - 200mmL, 1/2" Dr. M10 - 200mmL
H	x5	H17xH21 (30mmL), H15xH28 (30mmL), H19xH28 (30mmL), H21xH28 (30mmL), H22xH28 (30mmL)
I	x2	H22 (30mmL), H17 (35mmL)
J	x3	H22x22mm x T33 (300mmL), H15x15mm x T33 (30mmL), 15mm x T33 (30mmL)

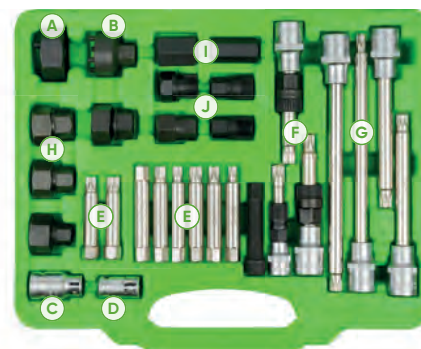

51259

58,00€

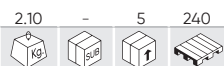

SET DI 18 PEZZI ESTRATTORE PULEGGE ALTERNATORE

RICAMBI DISPONIBILI

REF.	DESCRIZIONE	Icona	Icona	Icona	€
10485	PROLUNGA INSERTO XZN M10 110MM PER 51259	0.10	5	100	8,10€
10486	BUSSOLA PER PUNTA T50 PER 51259	0.15	5	50	8,00€
10494	PUNTA DI PROLUNGA DA 14CM PER 51259	0.16	-	-	6,50€
10495	PUNTA H10 PER 51259	0.06	-	-	3,00€
10496	PUNTA H8 PER 51259	0.06	5	50	3,00€
10497	PUNTA H10 PER 51259	0.06	5	100	3,00€
10498	PUNTA M8 PER 51259	0.06	5	50	3,00€
10499	PUNTA T40 PER 51259	0.05	5	60	3,00€
10500	INSERTI T50 PER 51259	0.06	5	100	3,00€
10501	BUSSOLA PER PUNTA 3/8" M10 PER 51259	0.08	5	100	8,10€
10502	PUNTA M10 75MML PER 51259	0.06	-	20	3,50€

CONTIENE

A	x3	T50x110mm (1/2"), M10x110 (1/2"), M10x90mm (3/8")	E	x1	1/2"x10mm
B	x1	M10x140mm	F	x1	M10x65mm
C	x2	19, 22mm	G	x6	T40, T50, M8, M10, H8, H10 (10x75mm)
D	x3	22x28, 19x28, 21x28mm	H	x1	H22

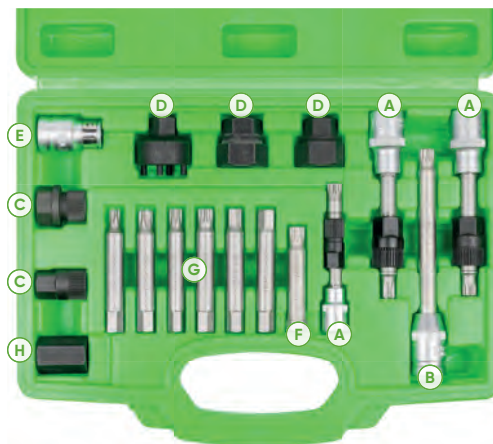

51495

59,00€

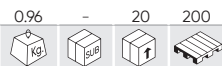

ESTRATTORE DI BOBINA D'ACCENSIONE PER VW



- Per il distacco e la collocazione delle bobine d'accensione con coperchio di motori ad iniezione VW ad 8 e 12 cilindri / 5 e 6 cilindri VW GOLF, BORA, e a 4 e 5 cilindri VW Passat, e a 6 cilindri, Sharan VW, Touareg, Phaeton.
 - Per il distacco e la collocazione delle bobine d'accensione con stadio di potenza di VW Polo, Golf 1.4, 1.6i, 1.4i CADDY, BORA 1.4, 1.6i Phaeton, Passat, Touran 1.6i, Transporter T4.



ESTRATTORE DEI CONNETTORI DELLE CANDELETTE

REF.	DESCRIZIONE				€
52816	ESTRATTORE DEI CONNETTORI DELLE CANDELETTE BOCA ANGOLO 235MM	0.27	6	36	28,10€
52817	ESTRATTORE DEI CONNETTORI DELLE CANDELETTE BOCA DRITTO 250MM	0.28	6	36	23,50€



52621

11,00€

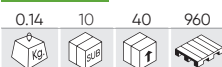

PULITORE TERMINALE DELLA BATTERIA



52319

8,80€



KIT PER LA PULIZIA DEI TERMINALI DI BATTERIA



CHIAVE PER CANDELE MAGNETIZZATA

REF.	"	mm					€
52316	3/8"	250mm - Ø14mm	0.20	12	48	2880	18,90€
52317	3/8"	250mm - Ø16mm	0.30	12	48	2880	19,90€



BUSSOLE PER CANDELE

REF.	"	mm					€
10054	1/2"	16mm	0.08	10	100	-	2,90€
10055	1/2"	21mm	0.14	10	100	-	3,90€



52691

54,00€



CHIAVE PER CANDELA ARTICOLATA

SISTEMA MECCANICO DI FISSAGGIO

3/8"	8mm (82mm)	3/8"	12mm (82mm)
3/8"	9mm (82mm)	3/8"	14mm (82mm)
3/8"	10mm (82mm)	3/8"	16mm (82mm)



CHIAVE A BUSSOLA SNODATA PER CANDELE

REF.	DESCRIZIONE					€
54381	CHIAVE A BUSSOLA SNODATA PER CANDELE 14 MM	0.35	10	40	-	5,00€
54382	CHIAVE A BUSSOLA ARTICOLATA PER CANDELE 16 MM	0.35	10	40	-	5,00€
54383	CHIAVE A BUSSOLA SNODATA PER CANDELE 21 MM	0.39	10	40	-	5,00€



N

54380

0.00	10	50	-

119,00€

SET DI 9 CHIAVI A BUSSOLA CON IMPUGNATURA A T (7-19MM)



N

RICAMBI DISPONIBILI

REF.	mm				€	REF.	mm				€
16430	7	0.17	10	50	20,50€	16565	14	0.17	10	50	19,50€
16431	8	0.17	10	50	20,50€	16566	19	0.17	10	50	22,50€
16432	10	0.17	10	50	20,50€						
16433	11	0.17	10	50	20,50€						
16434	13	0.17	10	50	20,50€						
16435	15	0.17	10	50	21,50€						
16436	17	0.17	10	50	21,50€						

9 PCS CrV 7, 8, 10, 11, 13, 14, 15, 17, 19mm



51501

0.88	5	20	240

38,00€

SET DI 12 PEZZI PER L'ESTRAZIONE DI AIRBAGS

12 PCS

- Inserti 0,5 PC 1/4" x 87mm (L):
 2x Torx: T25 (per BMW), T30 (per Audi, Opel, Renault, VW).
 2x Torx anti-intrusione: T25H (per BMW), T30H (per AUDI, BMW, Mercedes, Opel).
 1x esagonale: 5 mm (per AUDI).

- Estrattore 0,7 PC:
 1x per Airbag lato guida. 1999-04 nuovo stile di carrozzeria di VW Passat, JETTA, GOLF.
 2x per VW Passat B5, POLO, LUPO; AUDI A4, A6, Skoda Superb.
 2x per VW GOLF 4, New Beetle, SEAT, SKODA FABIA, AB Oktavia BJ.99.
 1x per VW GOLF 4 (BJ, 1998-2004), VW PASSAT BJ.1997 AB, AB BORA BJ.1999.
 1x per U.A VW modello: AB PASSAT BJ.2000.

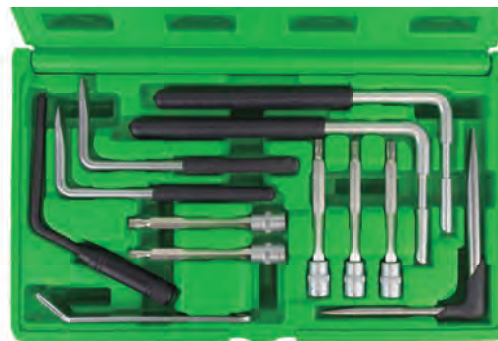

53388

1.50	-	5	120

90,00€

SET DI 52 PEZZI PER L'ESTRAZIONE DI APPARECCHIATURE AUDIO

52 PCS

BLAUPUNKT, CLARION, SKODA, BMW, AUDI, GFUNDIG, JVC, PIONEER, VOLKSWAGEN, MERCEDES, OPEL DOPPEL-KUGEL-INBUS, PORSCHE, BECKER, KENWOOD, SONY, PANASONIC, FIAT BRAVA, FORD.



18,00€

51126

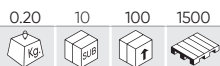

SET DI ACCESSORI PER L'ESTRAZIONE DI IMPIANTI AUDIO

10 PCS

BLAUPUNKT, PEUGEOT, CLARION, SKODA, ALPINE, BMW, OPEL, AUDI, GFUNDIG VDO, JVC, PIONEER, VOLKSWAGEN, MERCEDES, PORSCHE, RENAULT, BECKER.



53393

118,00€



SET DI 23 ESTRATTORI DI TERMINALI

23 PCS



BMW, AUDI, VOLKSWAGEN, MERCEDES, OPEL, PORSCHE, JAGUAR, SAAB, SEAT, FORD, SKODA, RENAULT, CITROËN, CHRYSLER, FIAT, HONDA, MAZDA, MITSUBISHI, TOYOTA.

53391

86,00€



SET DI 19 ESTRATTORI DI TERMINALI

19 PCS



x19 A, B, C, D, E, F, G, H, I, J, K, L, A1, B2, C3, D4, E5, F6, G7

51986

11,90€



RICAMBIO DI GAS DA 200 ML

200ml



51920

18,00€

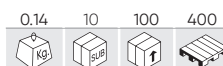

CANNELLO A GAS



53474

94,00€

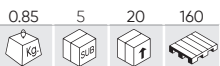

PISTOLA STROBOSCOPICA DIGITALE

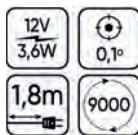

53240

58,00€

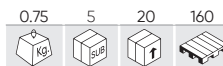

PISTOLA STROBOSCOPICA



53663

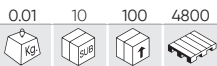

8,00€

ATTREZZO SMONTAGGIO CONNETTORI PER VAG



- Strumento per smontare i connettori nei veicoli del gruppo VAG senza danneggiarli.



KIT DI RIPARAZIONE FILETTI CON INSERTI HELICOIL

53041

37,60€



M14 x 1,25

IDEALE PER CANDELE



51898

139,00€

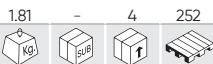

M18 x 2,5



51899

137,00€



M20 x 2,5



51896

82,00€



115 PCS

SET DI RIPARAZIONE FILETTI CON INSERTI HELICOIL



CONTIENE PER MISURA
Punta di trapano.
Maschio per filettare.
Inseritore di Helicoil.
Punteruolo di rottura.
Set spirali in acciaio inox.

CONTIENE
25 x M5x0.8
25 x M6x1
25 x M8x1.25
25 x M10x1.5
10 x M12x1.75

51897

122,00€



39 PCS

SET DI RIPARAZIONE FILETTI CON INSERTI HELICOIL



CONTIENE PER MISURA
Punta di trapano.
Maschio per filettare.
Inseritore di Helicoil.
Punteruolo di rottura.
Set spirali in acciaio inox.

CONTIENE
9 x M12x1.75
9 x M14x2
9 x M16x 2.0

ELICOIDI DI SOSTITUZIONE

REF.	DESCRIZIONE	0.01	10	300	72000	€
52016	ELICOIDI DI SOSTITUZIONE M5X0,8	0.01	10	300	72000	2,10€
52017	ELICOIDI DE SOSTITUZIONE M6X1.0	0.01	500	1000	21000	2,40€
52018	ELICOIDI DE SOSTITUZIONE M8X1.25	0.01	10	500	21000	2,60€
52019	ELICOIDI DE SOSTITUZIONE M10X1.5	0.01	10	500	21000	3,20€
52021	ELICOIDI DE SOSTITUZIONE M12X1.75	0.05	100	500	21000	3,40€
52022	ELICOIDI DE SOSTITUZIONE M14X2.0	0.03	100	300	12600	4,50€
52023	ELICOIDI DE SOSTITUZIONE M16X2.0	0.05	60	300	12600	6,60€
52024	ELICOIDI DE SOSTITUZIONE M18X2.5	0.08	-	10	21000	10,60€
52025	ELICOIDI DE SOSTITUZIONE M20X2.5	0.10	-	60	21000	13,00€

50793

94,00€

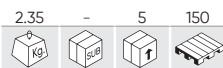

60 PCS

SET DI 58 PEZZI DI MASCHI E FILIERE RIVESTITI IN TITANIO METRICO E POLLICI

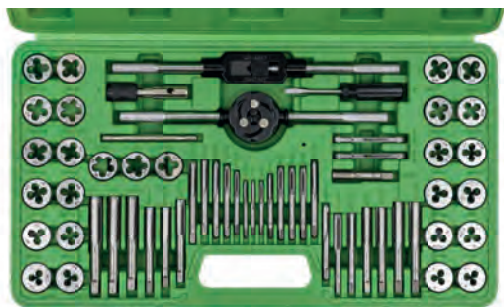

- x1 Maschio NPT (pollici): 1/8-27.
- x1 Filiera NPT (pollici): 1/8-27.
- x1 Portamaschi misto: M3~M12 e 3/16"-1/2".
- x1 Portamaschi misto tipo T: M3~M6 e 4-40 ~ 6-32.
- x1 Portafiliera misto: Ø25mm
- x1 Cacciavite.
- x1 Set di utensili per filettare e maschiare.
- x1 Set di utensili per filettare e maschiare in pollici.
- x10 Maschi (metrici): M3x0.5, M4x0.7, M5x0.8, M6x1.0, M7x1.0, M8x1.25, M9x1.25, M10x1.0, M10x1.5, M12x1.75.
- x10 Maschi UNC (pollici): 4-40, 6-32, 8-32, 10-24, 12-24, 1/4-20, 5/16-18, 3/8-16, 7/16-14, 1/2-13.
- x6 Filiere UNF (pollici): 10-32, 1/4 -28, 5/16-24, 3/8-24, 7/16-20, 1/2-20.
- x10 Filiere (metrici): M3x0.5, M4x0.7, M5x0.8, M6x1.0, M7x1.0, M8x1.25, M9x1.25, M10x1.0, M10x1.5, M12x1.75.
- x10 Filiere UNC (pollici): 4-40, 6-32, 8-32, 10-24, 12-24, 1/4-20, 5/16-18, 3/8-16, 7/16-14, 1/2-13.
- x6 Filiere UNF (pollici): 10-32, 1/4-28, 5/16-24, 3/8-24, 7/16-20, 1/2-20.

50792

105,00€

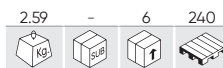

58 PCS

SET DI 58 PEZZI DI MASCHI E FILIERE RIVESTITI IN TITANIO PASSO METRICO



- x1 Maschio tipo NPT: 1/8 - 27.
- x1 Filiera tipo NPT: 1/8 - 27.
- x1 Portamaschi: M4 ~ M12.
- x1 Portamaschi tipo T: M3 ~ M6.
- x1 Portafiliera: 25 mm Ø est.
- x1 Cacciavite.
- x1 Set di utensili per filettare e maschiare.
- Maschi: M2x0.4 (x2), M3x0.6 (x2), M3x0.5 (x2), M3.5x0.6 (x2), M4x0.75 (x2), M4x0.7 (x2), M5x0.8 (x2), M6x0.75 (x2), M6x1.0 (x2), M7x0.75 (x2), M7x1.0 (x2), M8x1.0 (x2), M8x1.25 (x2), M10x1.25 (x2), M10x1.5 (x2), M12x1.25 (x2), M12x1.75 (x2)
- x17 Filiere: M2x0.4, M3x0.6, M3x0.5, M3.5x0.6, M4x0.75, M4x0.7, M5x0.8, M6x0.75, M6x1.0, M7x0.75, M7x1.0, M8x1.0, M8x1.25, M10x1.25, M10x1.5, M12x1.25, M12x1.75

51496

8,00€



ESTRATTORE DI VITI DI REGOLAZIONE

- N°1 1/8" - 1/4" (M 3-6)
- N°2 1/4" - 5/16" (M 6-8)
- N°3 5/16" - 7/16" (M 8-11)
- N°4 7/16" - 9/16" (M 11-14)
- N°5 9/16" - 3/4" (M 14-18)



53502

38,70€



SET DI ESTRATTORI MASCHI A VITE ROTTA

- #2 M5
- #3 M6
- #4 M8
- #5 M10
- #6 M12
- #7 M14
- #8 M16
- #9 M20
- #10 M22



53055

33,00€

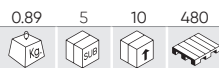

KIT DI SMONTAGGIO E RIVETTAZIONE DI CATENA DI MOTOCICLETTA

PUNTE DI ROTTURA 2.2mm, 2.9mm, 3.8mm



54280



156,50€

7 PCS N

SET DI RIPARAZIONE FILETTATURA CANDELE

RICAMBI DISPONIBILI

REF.	DESCRIZIONE				€
16237	M8X1,0 115MM	0.10	10	40	23,00€
16238	M10X1,0 115MM	0.10	10	40	23,00€
16239	M12X1,25 140MM	0.15	10	40	23,00€
16240	M12X1,25 270MM	0.30	10	40	26,00€
16241	M14X1,25 140MM	0.15	10	40	23,00€
16242	M14X1,25 270MM	0.35	10	40	26,00€
16243	M18X1,5 90MM	0.10	10	40	23,00€

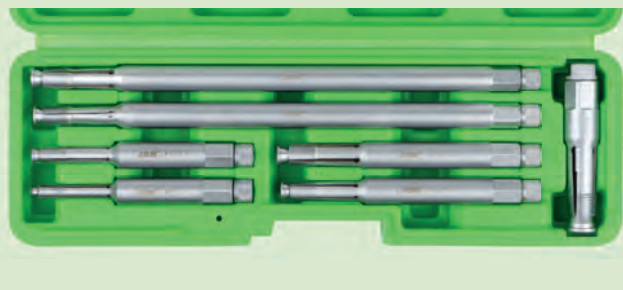

52833

39,30€

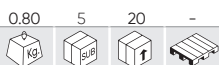

SET DI BUSSOLE ESTRATTORE PER VITI PRIGIONIERE

1/2"



RICAMBI DISPONIBILI

REF.	mm				€
14211	6mm	0.10	20	100	11,00€
14212	8mm	0.10	20	100	12,00€
14213	10mm	0.20	20	100	12,00€
14214	12mm	0.20	20	100	14,00€

53524

51,00€

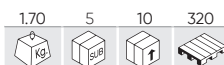

SET DI 4 SPACCADADI



RICAMBI DISPONIBILI

REF.	mm					€
14049	9-12 mm (1/8" - 1/2")	0.10	-	50	-	8,00€
14050	12-16 mm (1/2" - 5/8")	0.20	-	50	-	10,50€
14051	16-22 mm (5/8" - 7/8")	0.44	25	50	-	18,00€
14052	22-36 mm (7/8" - 1- 1/16")	0.65	-	20	-	19,50€

53652

53,00€



SET DI RIPARAZIONE FILETTATURE PER BULLONI DELLE RUOTE

RICAMBI DISPONIBILI

REF.	DESCRIZIONE				€
14340	BULLONE RIPARATORE M12X1.25 - PSA (RIF. 53652)	0.05	-	20	10,50€
14341	BULLONE RIPARATORE M12X1.5 - MERCEDES BENZ / BMW (RIF. 53652)	1.14	-	20	10,50€
14342	BULLONE RIPARATORE M12X1.75 - VOLVO (RIF. 53652)	1.12	-	20	10,50€
14343	BULLONE RIPARATORE M14X1.5 - VAG (RIF. 53652)	1.29	-	20	10,50€
14344	DISCO RIPARATORE M12X1.25 (RIF. 53652)	0.49	-	20	11,00€
14345	DISCO RIPARATORE M12X1.5 (RIF. 53652)	0.50	-	20	11,00€
14346	DISCO RIPARATORE M14X1.5 (RIF. 53652)	0.46	-	20	11,00€



54003

104,00€

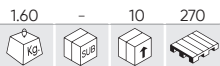

SET DI RIPARAZIONE DELLA FILETTATURA INTERNA ED ESTERNA



- x1 M14x1.5
- x1 M16x1.5
- x1 M18x1.5
- x1 M20x1.5
- x1 M22x1.5
- x1 M24x1.5
- x1 M27x2.0
- x1 M28x1.5



53665

19,00€

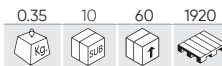

SMAGLIACATENA PER MOTO (25-60)



53666

28,00€

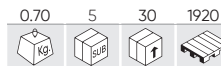

SMAGLIACATENA PER MOTO (60-100)



53054

6,00€



CHIAVI A BUSSOLA SPECIALE PER MOTOCICLETTE

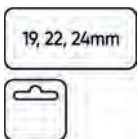

53086

9,00€



CHIAVE PER MOTOCICLETTE



YAMAHA, KAWASAKI,
BMW, SUZUKI, HONDA

52454

12,90€



ESTRATTORE BRACCIO TERGICRISTALLO



53664

38,00€



ESTRATTORE PULEGGE UNIVERSALE



Albero da 16 mm di diametro con sfera di centraggio e testa della vite esagonale da 24 mm.

51125

88,00€



SET DI ESTRATTORI A GHIGLIOTTINA

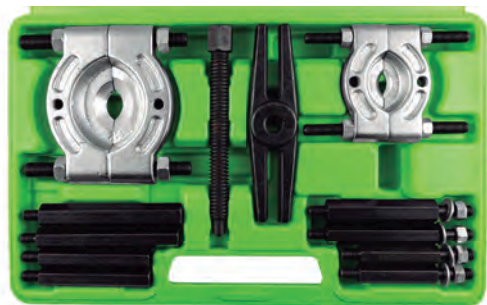

KIT DA UN POLLICE

- x2 1/4", con 30 mm e 50 mm.
- x1 Vite da 3/8" di 9,5x125 - 24 UNF.
- x1 Testa da 3/8" x 16 UNC.

KIT DA 2 POLLICI

- x1 1/4" - 3" 1/2, con 50 x 75 mm.
- x1 Vite da 1/2" di 12,7x135 - 20 UNF.
- x1 Testa da 3/8" x 16 UNC.

ESTRATTORI DI GHIGLIOTTINA

REF.	DESCRIZIONE	Kg	SUB	€
52626	75-105mm	3.65	- 5	800 46,00€
52627	105-150mm	6.50	- 2	231 120,00€



ESTRATTORE A 2 ARTIGLI

REF.	DESCRIZIONE	—	I					€
52727	ESTRATTORE A 2 ARTIGLI 25-70MM	25-70mm	50mm	0.20	10	60	1200	34,60€
52728	ESTRATTORE A 2 ARTIGLI 25-130MM	25-130mm	110mm	1.20	5	10	500	68,00€
52729	ESTRATTORE A 2 ARTIGLI 60-200MM	60-200mm	160mm	3.26	-	3	240	128,00€
52730	ESTRATTORE A 2 ARTIGLI 80-350MM	80-350mm	225mm	8.55	-	2	108	288,00€



REF.	DESCRIZIONE					€
53146	ESPOSITORE DI ESTRATTORE	0.70	5	10	140	30,50€

ESTRATTORE A 3 ARTIGLI

REF.	DESCRIZIONE	—					€
52731	ESTRATTORE A 3 ARTIGLI 50-100MM	50-100mm	0.90	4	24	504	38,00€
52732	ESTRATTORE A 3 ARTIGLI 70-150MM	70-150mm	2.54	5	20	200	58,00€
52733	ESTRATTORE A 3 ARTIGLI 95-200MM	95-200mm	5.20	-	4	112	98,00€



ESTRATTORE A 3 ARTIGLI CONVERTIBILI IN 2 REVERSIBILI

REF.	DESCRIZIONE	T					€
52010	ESTRATTORE A 3 ARTIGLI CONVERTIBILI IN 2 REVERSIBILI 2T	2T	0.50	4	40	360	80,00€
52296	ESTRATTORE A 3 ARTIGLI CONVERTIBILI IN 2 REVERSIBILI 5T	5T	1.57	4	8	120	119,00€
52297	ESTRATTORE A 3 ARTIGLI CONVERTIBILI IN 2 REVERSIBILI 7T	7T	3.33	-	6	36	172,00€
52298	ESTRATTORE A 3 ARTIGLI CONVERTIBILI IN 2 REVERSIBILI, CORTA E LARGA	2T	2.65	3	6	396	177,00€



53701

188,00€

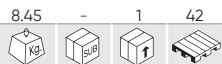

SET UNIVERSALE DEGLI ESTRATTORI CON LE PRESE A 2/3

- Intervallo 2 artigli: 45-120mm.
- Intervallo 3 artigli: 50-130mm.
- Profondità dell'artiglio: 100, 200, 250mm.

CONTIENE

- Guida centrale con 3 artigli.
- Guida centrale con 2 artigli.
- Perno 275mm.
- Perno 165mm.
- Artigli a presa lunga: 250mm.
- Artigli a presa media: 200mm.
- Artigli a presa corta: 100mm.

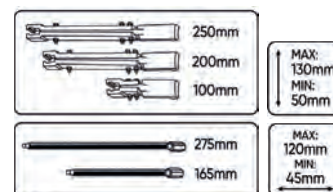

REF. DESCRIZIONE

REF.	DESCRIZIONE	Kg	Sub	Q	€
14611	PUNTA DELLA PRESA PER RIF. 53701	0.10	-	50	12,00€
14612	VITE 165 MM PER RIF. 53701	0.15	-	20	11,00€
14613	VITE 27 MM PER RIF. 53701	0.30	-	20	13,50€

53062

99,00€



ESTRATTORE DI CUSCINETTI CON SFERE FALSE

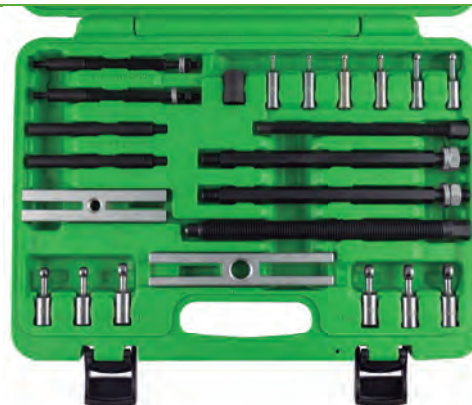

51140

64,00€



ESTRATTORE FILETTATO PER PULEGGIA DELL'ALBERO MOTORE

- Creato per mantenere immobile la puleggia dell'albero a camme mentre lo si allenta.
- Permette la regolazione dell'asse centrale quando si uniscono.
- Impiegare il perno filettato centrale per estrarre la puleggia.
- Viti di fissaggio: M6, M8.



51500

29,00€



ESTRATTORE DI PULEGGE SCANALATE

- Per albero motore, alternatore, climatizzatore e pompa dell'acqua.
- I bracci di ridotto profilo permettono un facile accesso alle zone difficili del motore.
- Specifico per l'estrazione dell'albero motore scanalato, grippato e delle pulegge ausiliari.
- Rang: 40-160mm.



40-168mm

52494

227,00€

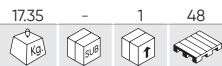

KIT ESTRATTORE SILENTBLOCK

- Utile per installare e disinstallare bocche e sospensioni.
- Contiene manicotti di diverse dimensioni e aste filettate di diverse misure.
- Misure: M10, M12, M14, M16, M18.

ADATTATORI (DIAMETRO ESTERNO/INTERNO):

90/80, 85/75, 82/72, 80/70, 78/68, 76/66, 74/64, 72/62, 70/60, 68/58, 66/56, 64/54, 62/52, 60/50, 58/48, 56/46, 54/44, 52/42, 50/40, 48/38, 46/36, 44/34

REF.	DESCRIZIONE	Kg	m³	U	€
12926	VITE M10 DI RICAMBIO PER 52495	0.46	-	20 1500	21,50€
12927	VITE M12 DI RICAMBIO PER 52494	0.52	-	20 -	21,50€
12928	VITE M14 DI RICAMBIO PER 52494	0.60	-	30 1500	22,00€
12929	ESPARRAGO M16 P/52494	0.66	-	20 -	23,00€
12930	ESPARRAGO M18 P/52494	0.89	-	30 -	23,50€



51124

88,00€

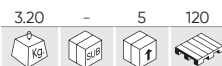

SET PER L'ESTRAZIONE DI CUSCINETTI

5
PCS

UNIVERSAL



CONTIENE

- Estrattore universale (38,5mm).
- Adattatore da 3/8" a 1/2" (10-14 mm).
- Adattatore da 9/16" a 11/16" (15-19 mm).
- Adattatore da 5/8" a 1" (18-25 mm).
- Adattatore da 1" a 1" 1/4 (25-32 mm).

52624

28,00€



SET D'ESTRAZIONE DI PULLEGE

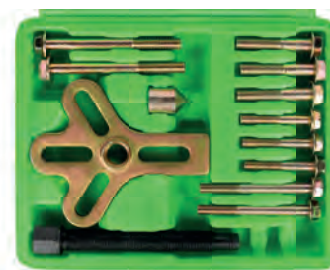

- x2 Inserti 5/16" de 4"
- x2 Inserti 1/4" de 3"
- x3 Inserti 1/4" de 2"
- x3 Inserti 5/16" de 2"
- x1 5" Inserti alu
- x1 Ponta di giro 3/4"

53058

193,00€

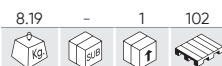

SET DI MONTAGGIO PER CUSCINETTI



- x49 Ø 18, 19, 20, 21, 22, 23, 24, 25, 26, 27, 28, 29, 30, 31, 32, 33, 34, 35, 36, 37, 38, 39, 40, 41, 42, 43, 44, 45, 46, 47, 48, 49, 50, 51, 52, 53, 54, 55, 56, 57, 58, 59, 60, 61, 62, 63, 64, 65, 74mm
- x1 Manico in metallo (da utilizzare con un martello) con un diametro di Ø 12 mm

53056

127,00€



SET PER L'ESTRAZIONE E INSTALLAZIONE DI CUSCINETTI



- x9 Ø 55.5, 59, 62, 65, 66, 71.5, 73, 78, 84mm
- x2 Ø 75.5, 83mm
- x1 Ø 69mm
- x1 295mm

UTENSILERIA

52551

151,00€

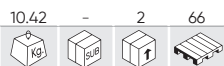

SET PER L'INSTALLAZIONE DI CUSCINETTI

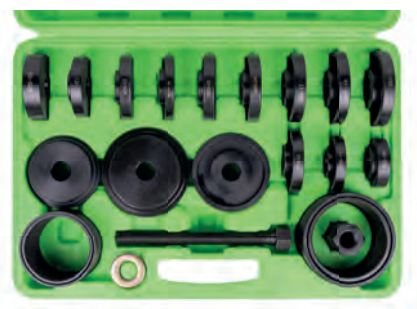

- x13** Dimensioni del disco: 50, 55, 60, 64, 67, 70, 72, 74, 75, 78, 82, 84, 88 mm
- x4** Cilindri: 76, 82, 92, 101 mm
- x1** Bullone: 32 mm
- x1** Capotasto: 38 mm
- x1** Vite rinforzata per utilizzo con attrezzo a percussione.
- x1** Albero in acciaio fosfatato per prevenire la corrosione.

53463

98,00€

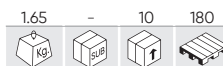

SET DI ESTRATTORI PER TERGICRISTALLI



VW: Polo, Lupo, Touareg, Porsche Cayenne.
 Opel: Astra G, Zaphira B, Corsa C, Vectra C.
 Honda: Jazz, CRV, FRV, Accord, Turnier.
 BMW: 5° Modello da EU 39 al 2005.
 7° Modello da E 38 al 2005
 Audi: A3, A4, A5, A6. Audi Q7.
 Ford: Galaxy, Alhambra.
 Mercedes: A-Class, B-Class.

51349

37,30€



SET PER L'INSTALLAZIONE DI CUSCINETTI



- x13** 42 - 38mm, 40 - 35mm, 36 - 32mm, 30 - 28mm, 24 - 22mm, 27 - 25mm, 18 - 16mm, 20 - 18mm, 22 - 20mm, 12 - 10mm, 14 - 12mm, 16 - 14mm, 17 - 15mm

53059

52,00€



SET PER L'INSTALLAZIONE DI CUSCINETTI E ANELLI ELASTICI DI SICUREZZA



- x9** Ø 39,5, 44,5, 50, 59, 63, 65, 72, 76, 81mm

52056

66,00€



SET DI 8 BUSSOLE PER MOLTIPLICATORE DI FORZA

RICAMBI DISPONIBILI

REF.	DESCRIZIONE	Icona	Icona	Icona	Icona	€
16385	BUSSOLE 22MM 1" PER MOLTIPLICATORE DI FORZA	0.50	-	50	-	10,00€
16386	BUSSOLE 24MM 1" PER MOLTIPLICATORE DI FORZA	0.45	-	50	-	11,50€
10674	BUSSOLE 27MM 1" PER MOLTIPLICATORE DI FORZA	0.59	-	50	-	9,50€
10675	BUSSOLE 30MM 1" PER MOLTIPLICATORE DI FORZA	0.55	-	50	-	9,50€
10672	BUSSOLE 32MM 1" PER MOLTIPLICATORE DI FORZA	0.66	-	50	-	9,50€
10673	BUSSOLE 33MM 1" PER MOLTIPLICATORE DI FORZA	0.67	-	50	-	9,50€
16388	BUSSOLE 38MM 1" PER MOLTIPLICATORE DI FORZA	0.70	-	50	-	11,50€
16389	BUSSOLE 41MM 1" PER MOLTIPLICATORE DI FORZA	0.75	-	-	-	11,50€



KIT DI MESSA IN FASE

- 244 FIAT/ALFA ROMEO
- 249 BMW/MINI
- 258 PSA
- 261 FORD
- 267 JAGUAR/LAND ROVER
- 269 JEEP/CHRYSLER
- 270 MERCEDES-BENZ
- 273 RENAULT/DACIA/NISSAN
- 278 OPEL/VAUXHALL
- 283 VAG
- 295 ALTRI
- 297 STRUMENTI AUSILIARI



53303

89,00€



KIT DI ATTREZZI DI REGOLAZIONE CINGHIA DENTATA PER FIAT / OPEL

MODELLO	FIAT: 1.9D/JTD (MOTOR PEUGEOT), 2.4D. ALFA ROMEO: 145, 146, 156 JTD. GM: GM 1.3, 1.6, 1.9, 2.0, 2.4 CDTI (2004 -).
UTENSILI OEM	EN-46789 (1), EN-46789-100 (2), EN-46785 (3), EN-46788 (4), EN-46781 (5), EN-46789 (6)
CODICE MOTORE	GM: K1.3 CDTI Z13DT COMMON RAIL ENGINE. 1.9 CDTI / 04-12 - Z19DT Z19DTH Z19DTJ Z19DTL 2.0 CDTI / 08-12 - A20DT LBS / LBX / LBY / LCD.V SAAB: 1.9 TID.

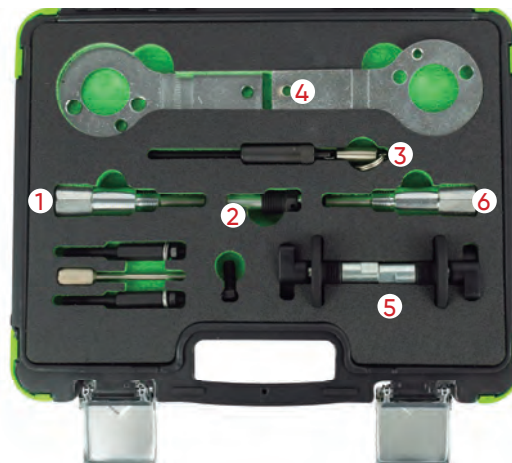

53304

279,00€



KIT DI ATTREZZI DI REGOLAZIONE CINGHIA DENTATA PER FIAT

MODELLO	FIAT
UTENSILI OEM	1 860 874 000 (1), 1 860 895 000 (2), 1 860 898 000 (3), 1 860 905 000 (4), 1 860 845 000 (5)
CODICE MOTORE	PETROL: FIAT BRAVA , BRAVO, BARCHETTA, CARGO, COUPE, MAREA, PALIO, WEEKEND, PUNTO, MULTILA, STILO, IDEA, DO- BLO TWIN CAM ENGINES - 1.2, 1.4, 1.6, 1.8, 16V GASOIL: FIAT BRAVA, BRAVO, MAREA, WEEKEND, PALIO, PUNTO, MULTIPLA, DOBLO, ULYSSE, DUCATO, STILO JTD DIESEL ENGI- NES - 1.9D/TD . 1.9JTD . 2.4TD/JTD.

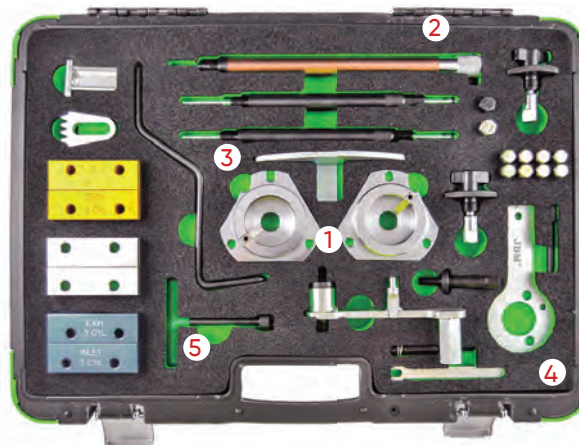

53306

53,00€



KIT DI ATTREZZI DI REGOLAZIONE CINGHIA DENTATA PER FIAT 1.2 16V

MODELLO	FIAT: FIAT 1.2L 16V, FIAT PUNTO / BRAVA / BRAVO / STILO
UTENSILI OEM	1860992000 (1) (2), 1871000900 (3), 1860987000 (4), 186985000 (5)
CODICE MOTORE	176 B9.000, 182 B2.000, 188 A5.000



53308

55,00€

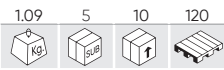

KIT DI ATTREZZI DI REGOLAZIONE CINGHIA DENTATA PER ALFA ROMEO

MODELLO	ALFA ROMEO: 145,146,147,155,156, 1.4 1.6 1.8 2.0 TS, 1.4/1.6 16V; 145/146/147/155/156 (96-10), 1.8 16V; 145/146, (96-01), 155/156 (96-06), SPIDER/GTV (98-05), 2.0 16V; 145/146 (96-01), 147 (01-10), 155/156 (95-02), 166 (98-07), SPIDER/GTV (96-05), PÚRPURA / PURPLE: 1.4, 1.6 // AZUL / BLUE: 1.8, 2.0
UTENSILI OEM	1822149000 (1), 1822154000 (2), 1825041000 (3), 1825042000 (4)
CODICE MOTORE	Z1.4/1.6-321.02, 321.03, 321.04, 335.03, 676.01 1.8/2.0-323.01, 672.04, 162.01, 323.10, 671.06, 322.01, 671.02, 322.05, 341.03, 363.01.

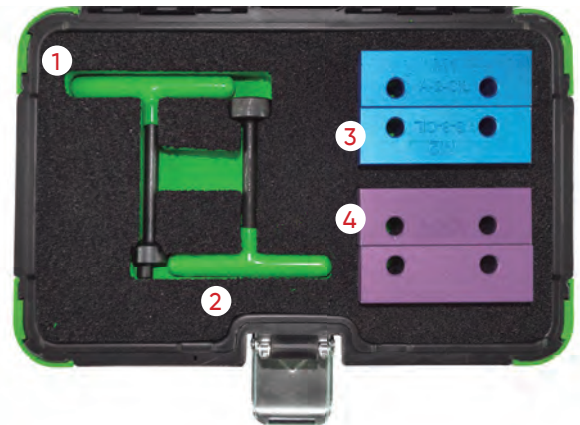

53309

285,00€

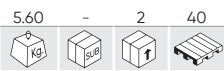

KIT DI ATTREZZI DI REGOLAZIONE CINGHIA DENTATA PER ALFA/FIAT/LANCIA 1.4, 1.6, 1.8, 2.0 16V

MODELLO	ALFA ROMEO: 145,146,147,155,156, 1.4 1.6 1.8 2.0 TS, 1.4/1.6 16V; 145/146/147/155/156 (96-10), 1.8 16V; 145/146, (96-01), 155/156 (96-06), SPIDER/GTV (98-05), 2.0 16V; 145/146 (96-01), 147 (01-10), 155/156 (95-02), 166 (98-07), SPIDER/GTV (96-05), PURPUR: 1.4, 1.6 // BLAU: 1.8, 2.0 FIAT: BARCHETTA (96-00), BRAVA (95-00), BRAVO (95-0 0), COUPE (96-01), MAREA (96-00), MAREA WEEKEND (96-00), PUNTO/PUNTO CLASSIC (99-06), STILO (01-08) LANCIA: DEDRA (95-99), DELTA (96-99), KAPPA (98-02), LYBRA (99-06).
UTENSILI OEM	1.4 16V: 335.03 1.6 16V: 321.02, 321.03, 321.04, 372.03, 676.01 1.8 16V: 322.01, 322.05, 671.06, 182A2.000, 183A1.000, 183A6.000, 188A6.000, 192A4.000 2.0 16V: 162.01, 323.01, 323.1, 341.03, 363.01, 672.04 2.0 20V: 175A3.000, 182A1.000, 182B7.000, 185A8.000.

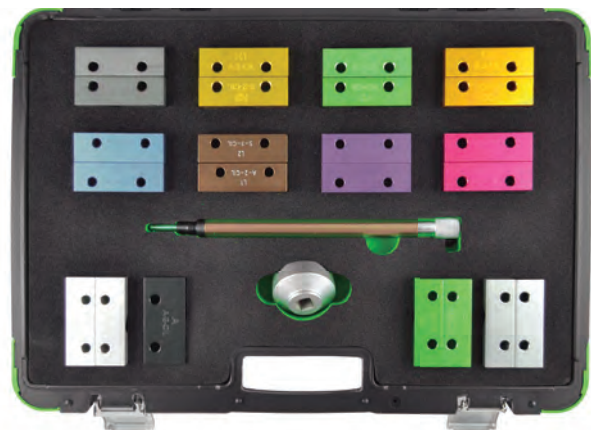

53310

498,00€

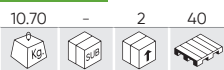

KIT DI ATTREZZI DI REGOLAZIONE CINGHIA DENTATA PER FIAT/ALFA/LANCIA

MODELLO	ALFA FIAT LANCIA	ALLA, BARCHETTA, BRAVO, BRAVA, COUPE, DELTA, DEDRA, PUNTO, SPIDER, GT
UTENSILI OEM	1860845000 (1), 1822154000 (2), 1860905000 (3), 1860992000 (4), 1860895000 (5), 1860874000 (6), 1860985000 (7), KM571A (8), 1860896000 (9), 0153A (10)	
CODICE MOTORE	1.2 / 16V, 1.4 / 12V, 1.6 / 16V, 1.6 ECO. 1.8, 2.0 / 16V, 2.0 / 20V, 2.4 / 20V, 3.0 / V6.	



53312

127,00€



KIT DI ATTREZZI DI REGOLAZIONE CINGHIA DENTATA PER FIAT/ALFA/FORD

MODELLO	FIAT: NEW 500 (07-09), IDEA (04-09), LINEA (07-09), GRANDE PUNTO (07-09), DOBLO 1 CARGO (05-09), PANDA EV02 (05) FORD: KA 1.2 DURATEC (09) ALFA ROMEO
UTENSILI OEM	1 860 987 000 (1), 2 000 004 400 (2), 2 000 015 800 (3), 2 000 004 300 (4), 2 000 004 500 (5)
CODICE MOTORE	1.2: 169A4.000 / 199A4.000 . 1.4: 350A 1.000 / 188A4.000-EV02.

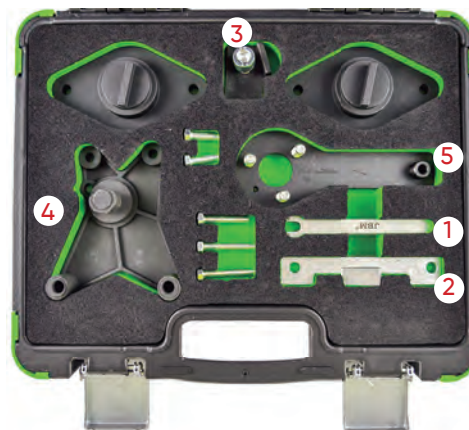

53319

18,00€

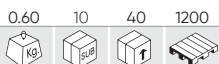

ATTREZZO DI REGOLAZIONE CINGHIA DENTATA PER FIAT IVECO 2.3, 3.0 JTD

MODELLO	FIAT: 2.3 / 3.0 JTD. IVECO: DAILY.
UTENSILI OEM	99360614, 1860 617 000, 99360615, 2 000 018 200.
CODICE MOTORE	F1AE0481C, F1AE0481D, F1AE0481N, F1CE0481A/D.

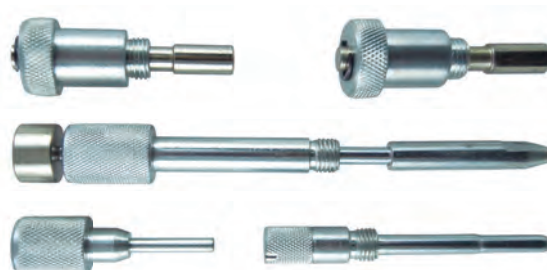

54202

68,00€



KIT DI ATTREZZI I DI CRONOMETRAGGIO DEL MOTORE PER FIAT/ALFA ROMEO/LANCIA

MODELLO	ALFA ROMEO: GIULIETTA (10-14), MITO (08-17). FIAT: 500 (07-19), 500L (12-19), 500C (07-19), 500 ABARTH (08-17), BRAVO (07-14), BRAVA/BRAVO (98-02), DOBLO/DOBLO CARGO (10-19), EGEA (15-20), GRANDE PUNTO (07-10), GRANDE PUNTO ABARTH (07-10), IDEA (04-12), LINEA (07-10), MAREA/WEEKEND (98-00), PALIO WEEKEND (01-06), PANDA (07-11), PUNTO (97-08), STILO (01-08), TIPO (15-20). LANCIA: DELTA (08-12), MUSA (04-13), YPSILON (96-11).
UTENSILI OEM	2.000.004.500 (1), 1.860.985.000 (2), 1.860.992.000 (3), 1.860.987.000 (4), 2.000.015.800 (5)
CODICE MOTORE	1.2 16V:176B9.000, 182B2.000, 188A5.000. 1.4 16V / T-JET: 169A3.000, 192B2.000, 198A1.000, 198A4.000, 199A6.000, 198A8.000, , 312A1.000, 312A3.000, 843A1.000, 955A1.000.

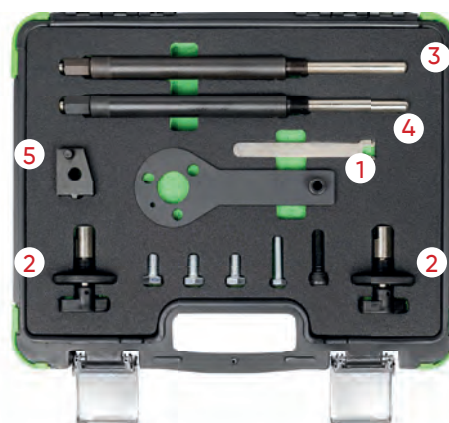

54203

91,00€



KIT DI ATTREZZI DI CRONOMETRAGGIO DEL MOTORE PER ALFA ROMEO/LANCIA 1.8 TBI

MODELLO	ALFA ROMEO: 159(09-12), BRERA(09-11), GIULIETTA(10-19), SPIDER(09-11), 4C(13-19). LANCIA: DELTA(09-14).
UTENSILI OEM	2 000033500 (1), 2000 003000 (2), 1860898 000 (3).
CODICE MOTORE	ALFA ROMEO 1,75 TBI: 939B1.000, 940A1.000, 940B2.000, 960A1.000 LANCIA 1,75 DI TURBO JET: 939B1.000

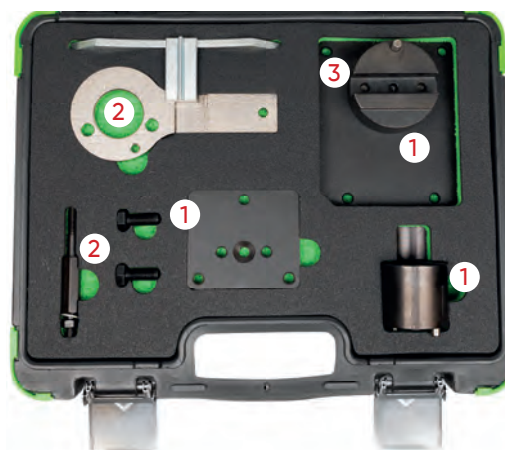

54211

74,00€



KIT DI ATTREZZI DI CRONOMETRAGGIO DEL MOTORE PER FIAT/FORD/OPEL/SUZUKI 1.3L

MODELLO	FIAT: PUNTO (2003-2007) / PANDA (2003-2009) / IDEA (2004-2006) / DOBLO (2004-2006). FORD: KA. VAUXHALL / OPEL: AGILA (2003-2008) / CORSA C (2003-2007) / CORSA D (2006-2009) / COMBO C (2003-2009) / ASTRA H (2004-2009) TIGRA B (2004-2009) / MERIVA (2004-2009). SUZUKI: IGNIS (2003-2009) / WAGON R (2003-2009) / SWIFT (2003-2010).
UTENSILI OEM	1871000200/303-1469/KM-662-C (1), EN 46785/KM 955/09912-38300 (2), 1871000900/1860985000/303-1472/EN 46781/09917-68610(3), 1870900400 (4), 1870900300 / 303-1468 (5)
CODICE MOTORE	FIAT: 1.3 JTD 188A9.000 / 169A.000 / 188A8.000 / 199A3.000. FORD: 1.3 TDCI. VAUXHALL / OPEL: 1.3 CDTI Z13DT / Z13DTH / Z13DTJ. SUZUKI: 1.3 CDTI Z13DT.



54212

39,40€



KIT DI ATTREZZI DI CRONOMETRAGGIO DEL MOTORE PER FIAT/LANCIA 1,4 12V

MODELLO	MAREA/MAREA_WEEKEND(96-20), BRAVA(95-98), BRAVO(95-98). LANCIA: YPSILON(96-20)
UTENSILI OEM	1860899000 (1), 1860901000 (2)
CODICE MOTORE	1.4 12V : 182A3.000, 182A5.000.



54215

57,00€

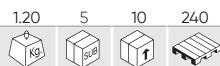

KIT DI ATTREZZI DI CRONOMETRAGGIO DEL MOTORE PER ALFA ROMEO/FIAT 1.4 MULTI AIR

MODELLO	ALFA ROMEO GIULIETTA, MITO / FIAT PUNTO, PUNTO EVO 1.4 (TURBO) MULTI AIR (105/135/163/170PS)
UTENSILI OEM	ALFA ROMEO / FIAT: 1860987000 (1), 2000034400 (2), 2000004500 (3)
CODICE MOTORE	940A2.000 / 940A2.000 / 955A8.000 / 955A8.000 / 940A2.000 / 955A8.000 / 955A2.000 / 955A7.000 / 955A6.000 / 955A8.000



54216

49,00€

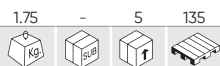

KIT DI ATTREZZI DI CRONOMETRAGGIO DEL MOTORE PER FIAT/OPEL/ALFA 1.9, 2.4L 16V

MODELLO	OPEL 1.9, ALFA-ROMEO 1.9-2.4 L DIESEL, FIAT 1.9- 2.4 L DIESEL
UTENSILI OEM	OPEL EN-46788 / FIAT 1.860.905.000 / 1.860.905.010 (1) FIAT 1.860.898.000 (2) OPEL EN-46789 / FIAT 1.870.896.900 (3) OPEL KM 6130 / KM 6349 (4)
CODICE MOTORE	OPEL 1.9 CDTI Z19DT, Z19DTH, Z19DTJ ALFA-ROMEO 1.9 Y 2.4 L : 323.02, 371.01, 342.02, 325.01, 362.02, 182B9.000, 937A2.000, 937A3.000, 192A5.000, 192B1.000, 937A4.000, 937A5.000, 939A2.000, 939A1.000, 939A7.000, 939A8.000, 839A6.000, 841C.000 FIAT 1.9 Y 2.4 L : 182B4.000, 182B9.000, 185A6.000, 186A6.000, 186A8.000, 186A9.000, 188A2.000, 188A7.000, 188B2.000, 192A1.000, 192A3.000, 192A5.000, 192A8.000, 192A9.000, 192B4.000, 192B5.000, 198A2.000, 198A3.000, 198A6.000, 199A5.000, 223A7.000, 937A5.000, 939A1.000, 939A2.000, 939A3.000, 939A7.000



54430

34,00€

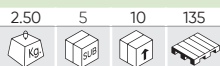

KIT DI MESSA IN FASE PER ALFA ROMEO/FIAT/LANCIA 0.9 TWIN AIR

MODELLO	ALFA ROMEO: MITO (2001-2018) CHRYSLER: YPSILON (2011-2015) FIAT: 500/500C (2010-2020), 500L/500L LIVING/500L MPW (2012-2018), PUNTO (2012-2018), PANDA (2012-) LANCIA: YPSILON (2011-2018)
UTENSILI OEM	2 000 035 100 (1) 2 000 035 200 (2) 2 000 035 300 (3)
CODICE MOTORE	Q.9: 199B6.000, 199B7.000, 312A2.000, 312A4.000, 312A5.000, 312A6.000, 312A7.000



53259

97,00€

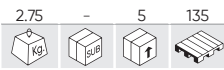

KIT DI ATTREZZI PER MONTAGGIO/FISSAGGIO MOTORI BMW N42, N46 1.8, 2.0 CON TRASMISSIONE A CATENA

MODELLO	BMW 1 SERIES: 118i E81/82/87/88 (04-14), 120i E81/82/87/88 (04-14). BMW 3 SERIES: 316i/TI COMPACT E46 (01-07), 318i/TI COMPACT E46 (01-07), 318i, E90/91/92/93 (05-12), 320i E90/91/92/93 (05-12). BMW 5 SERIES: 520i E60/61 (07-10), Z4 2.0 E85/86 (04-09). BMW X SERIES: X1 SDRIVE 18i E84 (10-12), X1 XDRIVE 18i E84 (10-12), X3 2.0 E83 (05-10).
UTENSILI OEM	119350 (1), 119340 (2), 119291 (3), 119292 (4), 119270 (5), 115120 (6), 119190 (7), 119293 (8)
CODICE MOTORE	1.8: N42; B18A, N46; B18. / 2.0: N42; B20A, N46; B20, B20B, N46T; B20, B20B, B20BD, B20BZ, B20O2, B2O2.



53260

168,00€

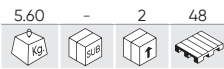

KIT DI ATTREZZI PER MONTAGGIO/FISSAGGIO MOTORI A BENZINA BMW N43 1,6/2,0 CON TRASMISSIONE A CAT

MODELLO	BMW 1 SERIES: 116i E81/82/87/88 (07-12), 118i E81/82/87/88 (06-14), 120i E81/82/87/88 (06-14). BMW 3 SERIES: 316i E90/91/92/93 (07-11), 318i E90/91/92/93 (07-13), 320i E90/91/92/93 (07-14). BMW 5 SERIES: 520i E60/61 (07-10).
UTENSILI OEM	118690 (118691/118692/118693) (1), 118710 (118711/118712) (2), 113340 (3) (4), 118700 (5), 119340 (119341/119342) (6), 115120 (7).
CODICE MOTORE	1.6: N43 B16A/AA, B16AA, B16AA/OO. 2.0: N43 B20A, B20A/AA, B20AA, B20AY, B20KO, B20UO.

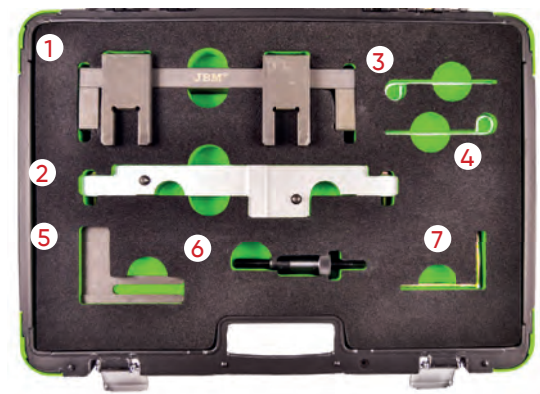

53261

214,00€

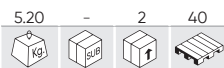

KIT DI ATTREZZI PER FISSAGGIO BMW N42, N46 1.8, 2.0

MODELLO	BMW 1 SERIES: 118i E81/82/87/88 (04-14), 120i E81/82/87/88 (04-14). BMW 3 SERIES: 316i/TI COMPACT E46 (01-07), 318i/TI COMPACT E46 (01-07), 318i, E90/91/92/93 (05-12), 320i (E90/91/92/93 (05-14). BMW 5 SERIES: 520i E60/61 (07-10). BMW X SERIES: X1 E84 SDRIVE 18i (10-12), X1 E84 XDRIVE 18i (10-12), X3 E83 2.0 (05-10). BMW Z SERIES: Z4 2.0 E85/86 (04-09).
UTENSILI OEM	119190 (1), 119310 (2), 119302 (3)
CODICE MOTORE	2.0: N42 B18A, N42 B20A, N46 B18, N46 B20, N46 B20B, N46T B20, N46T B20B, N46T B20BD, N46T B20BZ, N46T B20O2, N46T B2O2

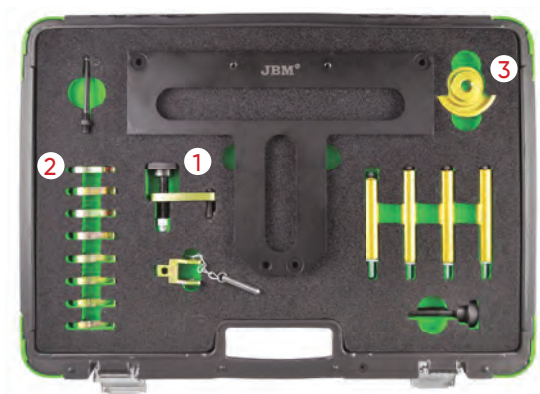

53262

251,00€



KIT DI ATTREZZI DI REGOLAZIONE ALBERO A CAMME PER BMW M52TU, M54, M56 CON SISTEMA DOUBLE VANOS

MODELLO	M52TUB25: 1997-2001 E46 323i/323Ci/323Ti (M52T); 1998-2001 E39 523i (M52TU); 1998-2001 E36/7 Z3 (M52TU). M52TUB28: 1997-2001 E46 328i/328Ci (M52TU); 1997-2001 E36/7 Z3 2.8 (M52B28/Z3); 1998-2001 E39 528i (M52TU); 1998-2001 E38 728i (M52TU). M54B22: 2001-2003 E46 320i/320Ci; 2001-2003 E39 520i; 2001-2002 E36 Z3 2.2i; 2003-2005 E85 Z4 2.2i; 2003-2005 E60/E61 520i. M54B25: 2001-2002 E36/7 Z3 2.5i; 2001-2005 E46 325i/325Xi; 2001-2006 E46 325Ci; 2001-2004 E46 325Ti; 2001-2004 E39 525i; 2003-2004 E60/E61 525i/525Xi; 2004-2006 E83 X3 2.5i; 2004-2006 E85 Z4 2.5i. M54B30: 2001-2005 E46 330i/330Xi; 2001-2006 E46 330Ci; 2001-2003 E39 530i/2001-2002 E36 Z3 3.0i; 2003-2005 BMW E60 530i; 2003-2006 E85 Z4 3.0i; 2001-2006 E53 X5 3.0i.
UTENSILI OEM	116150 (1), 113450 (2), 113292 (3), 116180 (4), 114220(5)

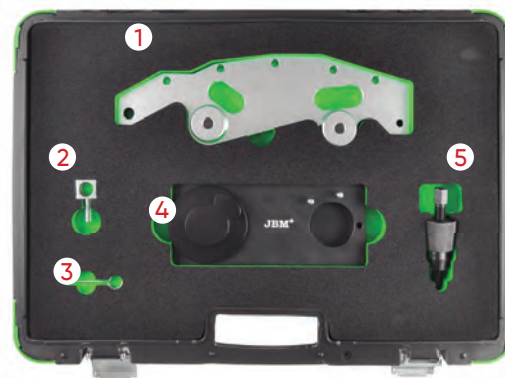

53263

57,00€



KIT DI ATTREZZI DI REGOLAZIONE ALBERO A CAMME PER BMW M47 LAND ROVER TD4,TD6

MODELLO	BMW 1 SERIES: 118D E87 (04-07), 120D E87 (04-07). BMW 3 SERIES: 318D/TD COMPACT E46 (01-05), 318D/TD E90/91 (05-08), 320D/TD COMPACT E46 (98-05), 320D/CD E90/91 (05-08), 325D E90/91/92/93 (02-10), 330D/CD E46/90/91/92/93 (99-07), 335D E90/91/92 (06-11). BMW 5 SERIES: 520D E39/60/61 (00-09), 525D/XD E39/60/61 (00-10), 530D/XD E46/60/61 (98-10), 535D E60/61 (04-10). BMW 6 SERIES: 635D E63/64 (07-11). BMW 7 SERIES: 730D/LD E38/65/66 (98-08). BMW X SERIES: X3 2.0D E83 (04-07), X3 3.0D/SD E83 (03-10), X5 3.0D E53/E70 (00-10), X6 3.0D E71/72 (08-10), X6 3.5D E71/72 (08-10). LAND ROVER: FREELANDER TD4 (00-06), RANGE ROVER TD6 (02-06). MG/ROVER: MG-ZT/T (01-05), ROVER 75 CDT/CDTI (99-05). VAUXHALL/OPEL: OMEGA-B (01-03).
UTENSILI OEM	112300/12-108, 12-171/KM-813 (1), 113340/12-172/KM-823 (2) (3), 116322/12-174/KM-6267 (4) 116320 (5)
CODICE MOTORE	BM - 2.0D: M47, M47T2, M47TU / 2.5D: M57, M57T2, M57TU / 3.0D: M57, M57T2, M57TU LAND ROVER - 2.0D: 204D3 (TD4) / 3.0D: 306D1 (TD6) MG/ROVER- 2.0D: M47R / 2.0D CDT: M47R VAUXHALL/OPEL- 2.5D: Y25DT



53264

143,00€

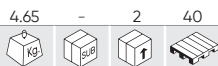

KIT DI ATTREZZI PER FISSAGGIO E REGOLAZIONE ALBERO A CAMME PER BMW N62, N73

MODELLO	BMW 5 SERIES: 540i E60/61 (05-10), 545i E60/61 (03-06), 550i E60/61 (05-10). BMW 6 SERIES: 645i E63/64 (03-06), 650i E63/64 (05-11). BMW 7 SERIES: 735i E65/66 (02-05), 740i E65/66 (05-10), 745i E65/66 (02-05), 750i E65/66 (05-08), 760i E65/66 (02-08). BMW X SERIES: X5 4.4 E53 (03-07), X5 4.8 E53/E70 (04-10).
UTENSILI OEM	119463 (1), 119462 (2), 119340 (3), 119461 (4), 119190 (5)
CODICE MOTORE	3.6 V8: N62 B36A 4.4 V8: N62 B44A 4.0 V8: N62 B40A 4.8 V8: N62 B48B 6.0 V12: N73 B60A

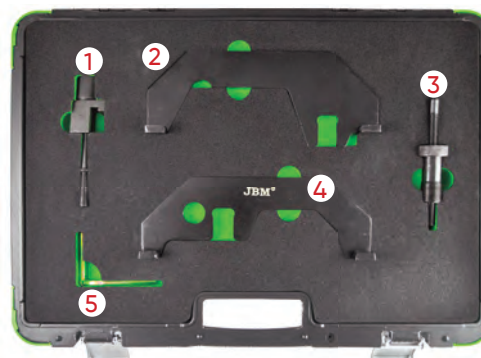

53265

195,00€

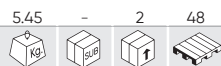

KIT DI ATTREZZI PER FISSAGGIO E REGOLAZIONE ALBERO A CAMME PER BMW DIESEL M47, M57, M41, M51

MODELLO	BMW
UTENSILI OEM	113360 (1), 116321 (2), 135190 (3), 135191 (4), 135192 (5), 116322 (6), 112300 (7), 113340 (8)
CODICE MOTORE	M41 / M51 / M47TU / M47TU T2. M57TU T2 3.01 1998 - 2008.

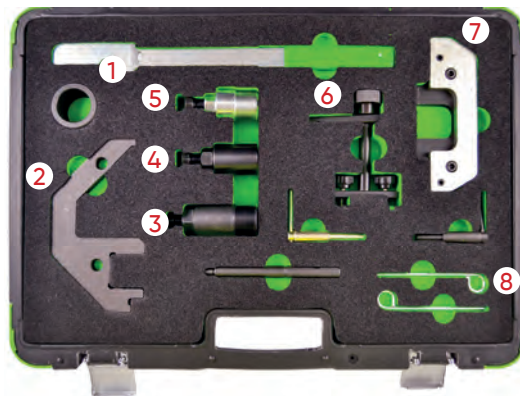

53266

224,00€



KIT DI ATTREZZI DI REGOLAZIONE CINGHIA DENTATA PER BMW M42, M43, M50, M51, M52

MODELLO	BMW
UTENSILI OEM	113240 (1), 115490 (2), 113190 (3), 112300 (4) (5), 113292 (6), 113320 (7)
CODICE MOTORE	PETROL: M42, M43, M50, M52, M60. DIESEL: M51

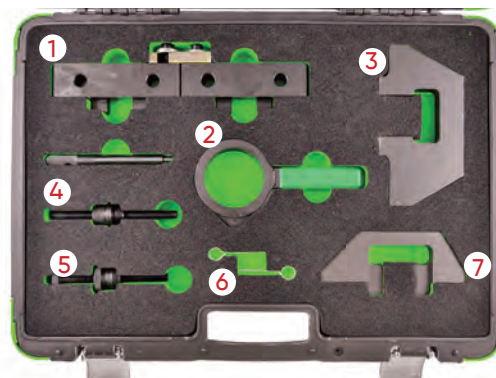

53267

277,00€



KIT DI ATTREZZI DI REGOLAZIONE CINGHIA DENTATA PER BMW M40, M43, M42, M44, M52, M54, M56

MODELLO	BMW SERIES: 3, 5, 7, X, Z
UTENSILI OEM	114220 (1), 112300 (2), 113240 (3), 115490 (4), 113292 (5), 113450 (6)
CODICE MOTORE	M40. M44. M50. M52. M54. M56.

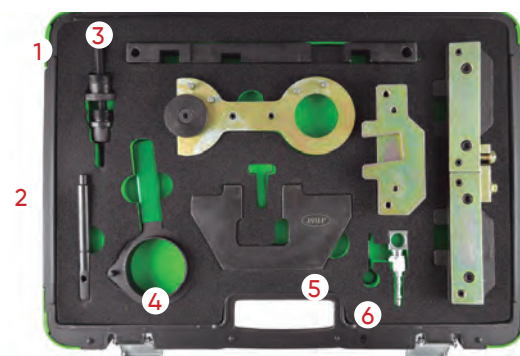

53269

50,00€

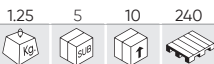

KIT DI ATTREZZI DI REGOLAZIONE CINGHIA DENTATA PER BMW N47, N47S, N57

MODELLO	<p>BMW 1 SERIES: 116D E81/82/87/88 (08-12), 118D E81/82/87/88 (07-14), 120D E81/82/87/88 (07-14), 123D E81/82/87/88 (07-14).</p> <p>BMW 2 SERIES: 218D (11-14), 220D (11-14), 225D (11-14).</p> <p>BMW 3 SERIES: 316D E90/91/92/93 (09-12), 318D E90/91/92/93 (07-12), 320D E90/91/92/93 (07-12), 325D E90/91/92/93 (10-14), 330D/XD E90/91/92/93 (08-14).</p> <p>BMW 5 SERIES: 520D E60/61 (07-10), 525D F10/11 (10-12), 530D F10/11 (10-13), 530DGT F07 (09-12), 535D F10/11 (10-17), 535DGT F07 (10-12).</p> <p>BMW 7 SERIES: 730D/LD F01/02/04 (08-12), 740D F01/02/04 (09-12), 740D XDRIVE F01/02/04 (09-12), 750D XDRIVE F01/02/04 (12-15).</p> <p>BMW X SERIES: X1 SDRIVE 18D E84 (09-15), X1 SDRIVE 20D E84 (09-12), X1 XDRIVE 18D E84 (09-15), X1 XDRIVE 20D E84 (09-15), X1 XDRIVE 23D E84 (09-12), X3 2.0D E83 (07-10), X3 XDRIVE 18D E83 (08-10), X3 XDRIVE 30D E83 (11-12), X3 XDRIVE35D F25 (11-17), X5 3.0D E70 (10-13), X5 XDRIVE 40D X5 F15 M50D (13-17), E70 (10-13), X6 XDRIVE 30D E71/72 (10-14), X6 XDRIVE 40D E71/72 (10-14), X6 F16 M50D (14-17).</p> <p>BMW MINI: PACEMAN (13-17), COUNTRYMAN (10-17), MINI (10-15), ROADSTER (12-14), CLUBMAN (10-14), CLUBVAN (12-14).</p>
UTENSILI OEM	118760 (1), 118740 (2), 116480 (3), 115320 (4)
CODICE MOTORE	<p>1.6 D: N47; C16K1, C16U1.</p> <p>2.0 D: N47; C20K1, C20U1N47; D20, D20A, D20B, D20D, D20K1, D20O0, D20O1, D20T1, D20U0, D20U1, N47S D20T0, N47T; D20, D20O1, D20U1.</p> <p>3.0 D: N57; B30B, B30B/T0, B30C, D30BT0, D30O0, D30O1, D30T0, D30T1, D30U0.</p>



54206

113,00€



KIT DI ATTREZZI DI CRONOMETRAGGIO DEL MOTORE PER BMW/MINI 1.5 , 2.0L

MODELLO	<p>BMW</p> <ul style="list-style-type: none"> - 1 SERIES - 114D, 116D, 214D - (F20/ 21) - (2015- 2017) - 2 SERIES - 216D, 118D, 125D - (F22/ 23/ 45/ 46) - (2014-2017) - 3 SERIES - 218D, 220D, 225D - (F30/31/34) - (2015-2017) - 4 SERIES - 316D/320D/325D - (F32, 33, 36) - (2015-2017) - 5 SERIES - 420D, 425D, 418D - (F10, 11) - (2014-2017) - X1 SERIES - 518D - (F48) - (2015-2017) - X3 SERIES - (F25) - (2014-2017) - EFFICIENT DYNAMICS - X4 SERIES - (F26) - (2014-2017) - XDRIVE - X5 SERIES - (F15) - (2015-2017) - SDRIVE <p>MINI</p> <ul style="list-style-type: none"> - CLUBMAN - (F54) - (2015-2017) - ONE D CONVERTIBLE - (F57) - (2016-2017) - COOPER D/ SD MINI HATCH (F55, 56) - (2014-2017)
UTENSILI OEM	114120 (1), 2347904 (2), 2365488 (3), 2288380 (4), 118760 (5), 118740, 118030 (6)
CODICE MOTORE	<p>1.5: B37 D15A, B37 C15A</p> <p>2.0: B47 D20A, B47 D20B, B47 C20A, B47, B47 C20B</p>

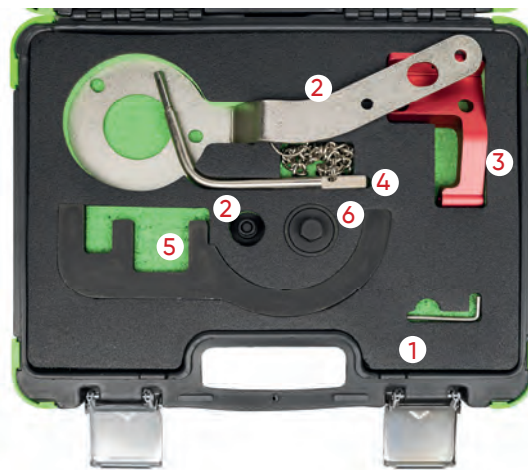

IL TUO KIT DI MESSA IN FASE ANCORA PIÙ VICINO

INSERISCI NELLA PAGINA WEB IL CODICE DEGLI ATTREZZI OEM O IL CODICE DEL MOTORE DELLA TUA AUTO E TROVA IL KIT COMPATIBILE

54219

60,00€

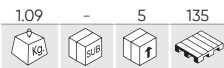

KIT DI STRUMENTI DI CRONOMETRAGGIO DEL MOTORE PER BMW/MINI/CITROËN/PEUGEOT

MODELLO	BMW MINI PSA
UTENSILI OEM	115140 (1), 119280 (2), 119330 (3), 113340 (4), 114360 (5)
CODICE MOTORE	BMW 1.6 (N40 / N45 / N45T, B16, B16A, B16AC) 1.8 / 2.0 (N42 / N46 / N46T) 2.0 / 3.0 (N51 / N52 / N52-COMPONENTE / N53 / N54) PSA 1.4 / 1.6 16V (EP3 / EP6 / EP6DT / EP6DTS) MINI 1.4 / 1.6 (N12 / N14)



54222

59,00€

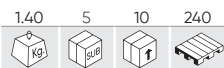

KIT DI ATTREZZI DI CRONOMETRAGGIO DEL MOTORE MINI 1.6

MODELLO	BMW: MINI COOPER S(07-10) PEUGEOT: 207(06-10), 307(06-10), GT(06-10), THP(06-10), GTI(06-10) CITROËN: DS3(06-10), C4(06-10), GRANDE PICASSO TPH(06-10)
UTENSILI OEM	119550(1), 119551(2), 119552(3), 119590(4)
CODICE MOTORE	N14 B16A , N14 B16CD , N14 B16TO

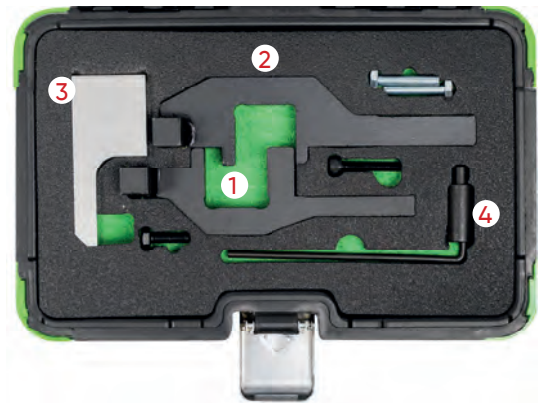

54227

122,00€



KIT DI ATTREZZI DI CRONOMETRAGGIO DEL MOTORE BMW/MINI N13, N18, PSA

UTENSILI OEM	EN-52127-2, EN-52588, E1 100, G 1376A, T10550/2, T10550/3, 0 496 709, 0109 2B, 0197 A11, 0197 A3, 0197 A31, 0197-A1, 0197-A1Z, 0197-A11, 0197A2, 0197-A31, 0197-A32, 0197-A33, 0197-BZ, 0197-M, 0197-N, 11 7 440 (1), 11 9 340 (2), 11 9 540, 11 9 551, 11 9 590, 1376-A, 2 299 362 (3)
CODICE MOTORE	N12 B14A, N13 B16A, N14 B16A, N14 B16C, N16 B16A, N18 B16A, N18 B16C, 5FA (EP6CDT), 5FD (EP6DTS), 5FE (EP6CDT), 5FE (EP6CDTM), 5FF (EP6DTS), 5FG (EP6CDTR), 5FH (EP6C), 5FK (EP6C), 5FK (EP6CB), 5FL (EP6C), 5FM (EP6CDTM), 5FN (EP6CDT), 5FP (EP6), 5FR (EP6DTE), 5FS (EP6C), 5FT (EP6DT), 5FU (EP6CDTX), 5FV (EP6CDT), 5FW (EP6), 5FX (EP6DT), 5FY (EP6DTS), 5GF (EP6FADTX), 5GF (EP6FADTXD), 5GG (EP6FADTX), 5GM (EP6FDTX), 5GN (EP6FDTR), 5GP (EP6FDTR), 5GR (EP6FDTX), 5GT (EP6FDTX), 5GW (EP6FDT), 5GY (EP6FADTXD), 5GY (EP6FDT), 5GY (EP6FDTM), 5GZ (EP6FDT), 8FN (EP3C), 8FP (EP3C), 8FR (EP3C), 8FS (EP3)



54228

187,00€



KIT DI ATTREZZI DI CRONOMETRAGGIO DEL MOTORE PER BMW/MINI 1.2, 1.5, 2.0, 3.0

MODELLO	BMW: 1 SERIES (2015 - 2019), 2 SERIES (DESDE 2014), 3 SERIES (DESDE 2015), 4 SERIES (DESDE 2015), 5 SERIES (DESDE 2017), 6 SERIES (DESDE 2017), 7 SERIES (DESDE 2015), i8 (DESDE 2014), X1 (DESDE 2015), X2 (DESDE 2018), X3 (DESDE 2017), X4 (DESDE 2018) AND Z4 (DESDE 2019); MINI: CLUBMAN (DESDE 2015), HATCH (DESDE 2014), CONVERTIBLE (DESDE 2016) AND COUNTRYMAN (DESDE 2017)
UTENSILI OEM	2 358 122 (1), 2 357 904 (2), 2 365 488 (3), 2 288 380 (4), 11 4 120 (5).
CODICE MOTORE	BMW: 1,5 B38 A15A, B38 B15A, B38 K15A ,1,6 B48 B16A, 2,0 B48 A20A, B48 A20B, B48 A20E, B48 B20A, B48 B20B , 3,0 B58 B30A, B58 B30B, B58 B30C MINI: 1,2 B38 A12A , 1,5 B36 A15A, B38 A15A , 2,0 B46 B20A, B48 A20A, B48 A20B

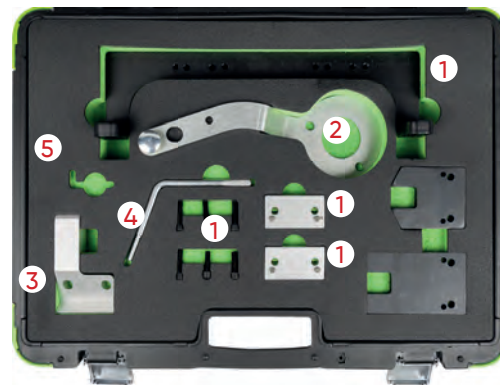

54293

17,50€



SUPPORTO CONTROLBERO MOTORE PER BMW

MODELLO	BMW 1 SERIES E81/82/87/88: 116D (2008-2012),118D (2007-2012),120D (2007-2014), 123D (2007-2014) BMW 1 SERIES E22: 218D (2011-2014), 220D (2011-2014), 225D (2011-2014) BMW 3 SERIES E90/91/92/93: 316D (2007-2012), 318D (2007-2014),320D (2007-2012), 325D (2010-2012), 330D (2008-2014) BMW 5 SERIES E60/61: 520D (2007-2010) BMW 5 SERIES F10/11: 525D (2010-2013), 530D (2010-2013),530D XDRIVE (2011-2015), 535D (2010-2013), 535D XDRIVE (2011-2015),M550D XDRIVE (2012-2015) BMW 5 SERIES E07: 535D GT (2009-2015) BMW 7 SERIES F01/02/04: 730D (2008-2012), 740D (2009-2012),750D XDRIVE (2012-2015) BMW X1 E84: 18D SDRIVE (2009-2015), 20D SDRIVE (2009-2015), 18D XDRIVE (2009-2015), 20D XDRIVE (2009-2015), 23D XDRIVE (2009-2012) BMW X3 E83: 2.0D (2007-2008), 18D XDRIVE (2008-2010) BMW X5 E70: 3.0D XDRIVE (2010-2013), 40D (2010-2013) BMW X6 E71/71: 30D XDRIVE (2010-2014), 40D XDRIVE (2010-2014)
UTENSILI OEM	T10016
CODICE MOTORE	2,0: N47D20C, N47D20D 2,0D: N47, D20A, D20A/KO, D20B, D20B/TO, D20C,D20O0, D20O1, D20U0, D20U1 D20K1 3,0D: N57, D30U0, D30O0, D30O1, D30T0, D20T0,D30A, D30A/O0, D30B , D30B/T1, D30C, D30C/ S1,D30A0/O0, D30A0/O1



54398

41,00€



SET DI BLOCCAGGIO DELLA PULEGGIA DELL'ALBERO MOTORE/DEL VOLANO PER BMW/MINI

MODELLO	MINI HATCH (14-21), CABRIOLET (16-19), CLUBMAN (15-19), COUNTRYMAN (17-19)
UTENSILI OEM	11 6 480 (1) 11 9265 (2) 11 4 180 (3) 11 9 810 (4) 11 9 811 (4)
CODICE MOTORE	BMW: 116i (15-19), 116d (15-19), 118d (15-19), 120d (15-19), 125d (15-19), M140i (16-19), 214d (15-19), 216i (18-19), 216d (14-20), 218d (17-19), 218i (15-21), 220d, (14-20), 225d (15-20), M240i (16-19), 316d (15-19), 318i (15-19), 320d (15-19), X1 (15-20),X2 (18-19), X3 (14-18), X4 (17-20), X5 (15-18), i8 (14-18) 325d (16-20),330i (15-20), 340i (15-19), 418i (15-20), 420d (15-20), 425d (16-18), 430i (16-20),440i (16-19), 518d (14-17), 525d (17-20), 530i (17-18), 540i (17-19), 620d (18-20), 630i (17-19), 640i (17-19), 725d (16-19), 730i, (15-19), 740i (15-19)



54399

56,50€

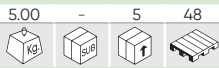

N

KIT DI MESSA IN FASE PER BMW/ROVER/OPEL 2.5D

MODELLO	BMW: 318TDS (94-00) , 325TD (91-99) , 325TDS (91-99) , 525TD (90-03) , 525TDS (90-03) , 725TDS (95-02) RANGE ROVER: P38 (94-02) VAUXHALL/OPEL: OMEGA-B (94-01)
UTENSILI OEM	KM811 (1), 113320 (1), 12112 (1) KM822 (2), 113360 (2), 12115 (2) KM813 (3), 115120 (3), 112300 (3), 12108 (3) KM823 (4), 113340 (4), 12172 (4)
CODICE MOTORE	256T, 25DT, M41/174T1, M51/256T1, M51/256T1L, X25DT

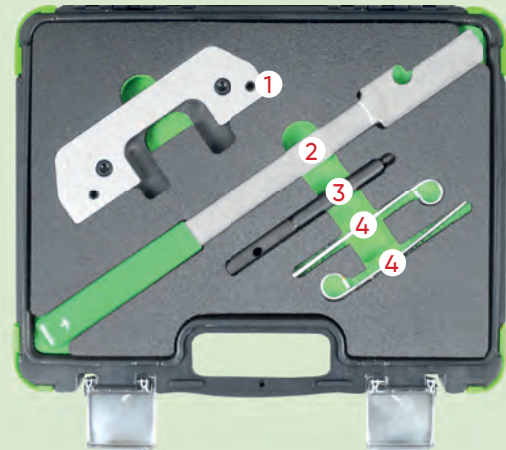

54400

141,00€

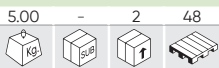

N

KIT DI MESSA IN FASE PER BMW N20, N26

MODELLO	BMW: 1 SERIES 125I - F20/21 (2012-2016) 2 SERIES COUPE 220I, 228I - F22 (2014-2016) 2 SERIES CABRIOLET 220I 228I - F23 (2015-2016) 3 SERIES 320I 328I XDRIVE - F30/31 (2012-2015) 3 SERIES GRAN TURISMO 320I, 328I/XDRIVE - F34 (2013-2016) X4 XDRIVE 20I, 28I (F26) 2014 - 2018, X5 XDRIVE40E (F15) 2015 - 2018, Z4 SDRIVE18I, 20I, 28I (E89) 2011 - 2017 4 SERIES COUPE 420I, 428I/XDRIVE - F32(2013-2016), 4 SERIES CABRIOLET 420I, 428I/XDRIVE-F33 (2014-2016) 4 SERIES GRAN COUPE 420I, 428I/XDRIVE F36 (2014-2016) 5 SERIES 520I, 528I/XDRIVE(F10/11) 2010 - 2017, 5 SERIES GRAN TURISMO 528I-(F07) 2013 - 2016, X1 SDRIVE16I, 18I, 20I, XDRIVE20I, 28I-(E84) 2011 - 2015, X3 SDRIVE18I, 20I, XDRIVE20I, 28I (F25) 2011 - 2017
UTENSILI OEM	11 9 340/341 (1), 11 9 340A (1), 11 9 341 (1), 119340 (1) 2 212 830 (2) 2 212 831 (3) 2 219 548 (4)
CODICE MOTORE	1,6 N20 B16A 2,0 N20 B20 N20 B20A N20 B20A N20 B20B N20 N20B/UO N20 B2000 N20 B2000 N26 B20 B26 B20A

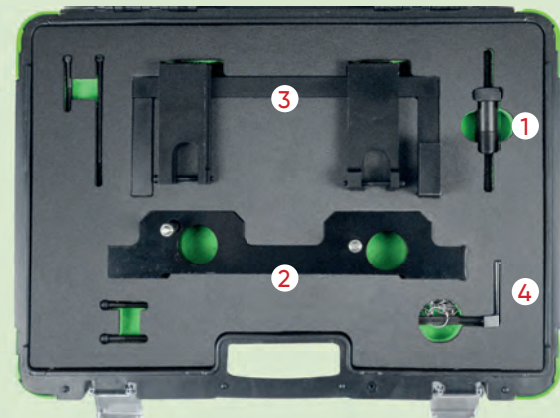

54401

57,00€



N

KIT DI MESSA IN FASE PER BMW/MINI N13, N18

MODELLO	BMW 114i (2012-2015) BMW 116i (2012-2015) BMW 118i (2011-2015) BMW 316i (2012-2015) MINI CLUBMAN (R55) (2011-2014) MINI COOPER S (R56/57) (2010-2015) MINI COUNTRYMAN (R60) (2012-2016) MINI COUPE COOPER S (R58) (2012-2015) MINI PACEMAN (R61) (2013-2017) MINI ROADSTER (R59) (2012-2015)
UTENSILI OEM	11 7 440 (1), 117440 (2), 11 9 340 (3), 11 9 590 (4), 49 6 709 (5)
CODICE MOTORE	N13 B16A N18 B16A N18 B16/MO N18B16A/MO N18B16C N18B16C/TO N18B16MO

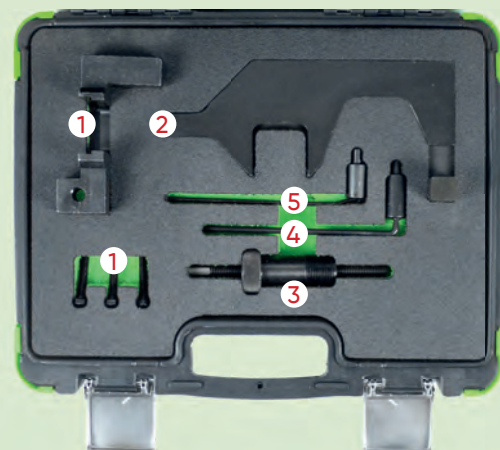

54402

201,00€



N

KIT DI MESSA IN FASE PER BMW N51, N52, N53, N54, N55

MODELLO	E60: 523i, 523Li, 525i, 525Li, 525Xi, 528i, 528Xi, 530i, 530Li, 530Xi, 535i, 535Xi E61/E63: 523i, 525i, 525Xi, 530i, 530Xi, 535Xi, 630i E64/E65: 630i, 730i E66/E70: 730Li, X5 3.0Si E81/E82: 130i, 135is E83: X3 2.5i, 2.5Si, 3.0i, 3.0Si E85/E86: Z4 2.5i, 2.5Si, 3.0i, 3.0Si, Z4 3.0Si E87/E90: 130i, 323i, 325i, 325Xi, 328i, 328Xi, 330i, 330Xi, 335i, 335Xi E91: 323i, 325i, 325Xi, 328i, 328Xi, 330i, 330Xi, 335i, 335Xi E92: 323i, 325i, 325Xi, 328i, 328Xi, 330i, 330Xi, 335i E93: 325i, 328i, 330i, 335i
UTENSILI OEM	110300 (1) 114280 (2) 114285 (3) 114290 (4) 114390 (5) 118520 (6) 119190 (7) 119340 (8)
CODICE MOTORE	N51/N52/N53/N54/N55

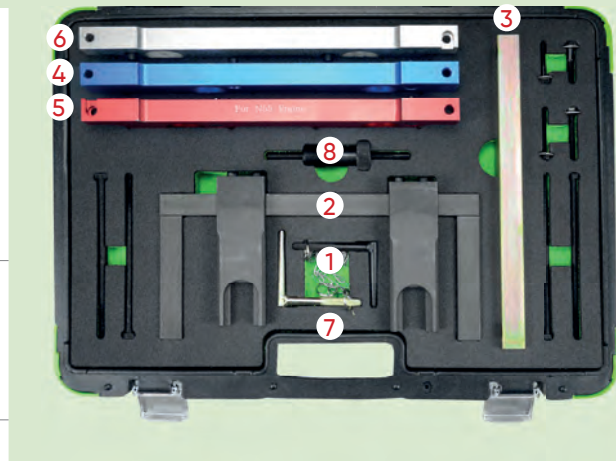

54403

225,00€



N

KIT DI MESSA IN FASE PER BMW M60

MODELLO	BMW 5 SERIES: 530i, 540i (E34) (1992 – 1996), 535i, 540i (E39) (1996 – 2003) BMW 7 SERIES: 730i, 735i, 740i (E38) (1994 – 2002), 730i, 740i (E32) (1992 – 1994) BMW 8 SERIES: 840i (E31) (1993 – 1999) LAND ROVER/RANGE ROVER: (L322) (2002 – 2005) X5: 4.4, 4.6 (E53) (1999 – 2004)
UTENSILI OEM	11 2 445 (1), 11 2 441/445 (1), LRT -12 223/2 (1) 11 2 441 (2), 12 223/1 (2), LRT 12-223/1 (2) 11 2 442 (3), 11 2 442/446 (3), 12 223/3 (3), LRT 12 223/3 (3) 11 2 446 (4), 12 223/4 (4), LRT 12 223/4 (4), LRT 12 224 (4) 11 3 390 (5), 113390/117380 (5), 12 222 (5), LRT 12 222 (5) 11 5 180 (6), 12 227 (6), LRT 12 227 (6) 11 2 300 (7), 11 5 120 (7), 12 108 (7), 12 171 (7), KM 813 (7), LRT 12 108 (7), LRT 12 171 (7) 11 6 420 (8), 12 226 (8), LRT 12 226 (8) 11 6 452 (9), 12 228/1 (9), LRT 12 228/1 (9) 11 6 451 (10), 12 228/2 (10), LRT 12 228/2 (10) 11 3 310 (11), 12 220 (11), LRT 12 220 (11) 11 6 440 (12), 12 224 (12), LRT 12 2214 (12) 11 7 380 (13), 12 221 (13), LRT 12 221 (13)
CODICE MOTORE	BMW 3.0: 30 8S 1 BMW 3.5: 35 8S 1, 35 8S 2 BMW 4.0: 40 8S 1 BMW 4.4: 44 8S 1, 44 8S 2 BMW 4.6: 46 8S 1 RANGE ROVER: V8/44 8S 2



54404

131,00€



N

KIT DI MESSA IN FASE PER BMW N62, N73

MODELLO	SERIES 5, SERIES 6, SERIES 7, X5
UTENSILI OEM	119461 (1), 119462 (2), 119463 (3), 119190 (4), 119340 (5), 119451 (6), 119452 (7), 119453 (8), 119454 (9), 113460 (10), B117207 (11)
CODICE MOTORE	N62 B36A, N62 B40A, N62 B44A, N62 B48A, N62 B48B, N73 B60A

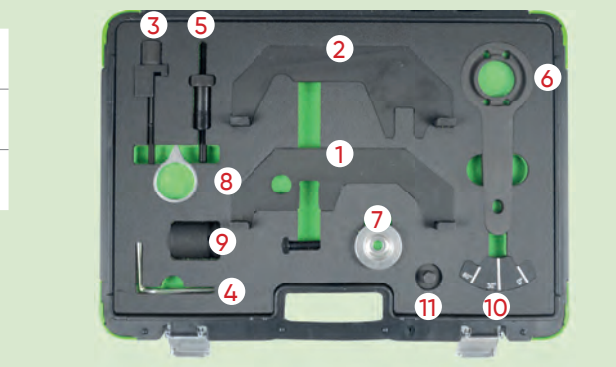

54405

111,00€

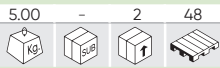

N

KIT DI MESSA IN FASE PER BMW N63, N74

MODELLO	SERIES 5, SERIES 6, SERIES 7, X5, X6
UTENSILI OEM	11 9 891 (1) 11 9 892 (1) 11 9 893 (2) 11 9 190 (3) 11 8 090 (4)
CODICE MOTORE	N63, N74

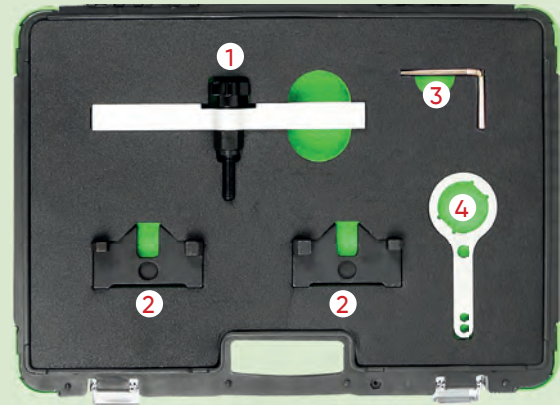

54406

73,00€



N

BLOCCO VOLANTE MOTORE BMW/MINI

MODELLO	<p>BMW 1 SERIES: F20/21 (12-15), 116i (04-12), 118i (04-14), 120i (04-14), 130i (05-07), 135i (07-11), 116D (08-12), 118D (04-14), 120D (04-14), 123D (07-14), M COUPE (11-12)</p> <p>BMW 3 SERIES: F30/31 (12-15), 316Ti (04-14), 316i (04-11), 316D (09-12), 318i (04-07), 318Ti/COMPACT (04-04)</p> <p>BMW 3 SERIES: 318D (03-12), 318TD (03-07), 320D (01-07), 320D COMPACT (01-05), 318i (05-13), 320D (07-14), 320i (05-14), (05-14), 320Si (05-06)</p> <p>BMW 3 SERIES: 323i (05-11), 325i (05-14), 325D (06-10), 330D (05-08), 330i (06-13), 335D (05-13), 335i (05-11)</p> <p>BMW 4 SERIES: 420i F32 (13-15), 428i F32 (13-15), 420i F33 CABRIOLET (14-15), 428i F33 CABRIOLET (14-15), 420i F36 (14-15), 428i F36 GRAN COUPE (14-15)</p> <p>BMW 5 SERIES: F10/11 (10-15), 520D (05-10), 520i (07-10) 523i (03-10), 525D (05-10), 525i (05-10), 525i (07-10), 530D (03-10), 530i (05-10), 535D (04-10)</p> <p>BMW 6 SERIES: 630i (04-11), 635D (07-11)</p> <p>BMW 7 SERIES: 730D (05-08), 730i (02-08) BMW X SERIES: X1 E84 (09-15), X3 E83 (03-14), X5 E53 (03-14), X3 F25 (11-15), X6 E71/72 (08-10)</p> <p>BMW Z SERIES: Z4 E85/86 (04-09), Z4 (E89) (11-15)</p> <p>MINI: MINI (03-06)</p>
UTENSILI OEM	11 8 180 (1), 11 8 181 (2), 11 8 182 (3), 11 8 183 (4), 11 8 184 (5), 11 8 185 (6)
CODICE MOTORE	<p>BMW: M47T2, M57T2, M67, N43, N45, N45T, N46, N46T, N47, N51, N52, N53, N54</p> <p>MINI: W17 DIESEL</p>



54324

11,00€

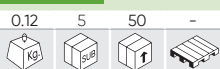

N

INDICATORE DI USURA DELLA CATENA DI DISTRIBUZIONE MINI

MODELLO	MINI: CLUBMAN (2007-2014), CLUBVAN (2012-2014), COUNTRYMAN (2010-2017), COUPÉ (2011-2015), MINI (2006-2015), PACEMAN (2013-2017), ROADSTAR (2012-2015)
UTENSILI OEM	2353281 (1)
CODICE MOTORE	<p>1.4: N12 B14AB, N12 B14</p> <p>1.6: N12 B16A, N16 B16A, N16 B16M0, N16 B16U0, N16 B16A/MO, N16 B16KO, N16 B16A/MO, N18 B16A, N18 B16A/MO, N18 B16C, N18 B16A/MO, N18, N18 B16M0, N18 B16C/T0</p>



53268

92,00€



KIT DI ATTREZZI DI REGOLAZIONE CINGHIA DENTATA PER BMW/MINI/PSA 1.4, 1.6

MODELLO	BMW/MINI: MINI CLUBVAN R55 (12-14), MINI CLUBMAN R55 (08-14), MINI COUNTRYMAN R55 (07-10), MINI CLUBMAN R56/R57 (07-15), MINI R56/R57 (08-15), MINI COUPE R58 (11-15), MINI ROADSTER R59 (08-15), MINI CLUBMAN R60 (10-14), MINI CLUBVAN R60 (12-14), MINI ROADSTER R61 (13-15), MINI PACEMAN R61 (14-15), MINI COUNTRYMAN R60 (10-17). CITROËN: C4 (08-11), C4 PICASSO (08-13) C4 GRAND PICASSO (13-15). PEUGEOT: 207 (06-14), 207CC (07-15), 308 (07-15), 3008 (09-15), 5008 (09-15).
UTENSILI OEM	BMW/MINI: 115590 (1), 119340 (2), 119551 (3) CITROËN: 0197-A1, 0197-A3, 0197-B. PEUGEOT: 0197-A1, 0197-A3, 0197-BZ.
CODICE MOTORE	1.4: N12B14, N14B14AB. 1.6: EP3(8FS), EP3C(8FR), EP6(5FW), EP6C(5FS), EP6CDT(5FV), EP6DT(5FT), EP6DT(5FX), EP6DTS(5FY), N14B16A, N14B16CD, N14B16TO, N14B16CD/TO, N16B16A, N16B16KO, N16B16A/MO, N16B16A/MO, N16B16MO, N16B16UO.



53313

139,00€



KIT DI ATTREZZI DI REGOLAZIONE CINGHIA DENTATA PER CITROEN/PEUGEOT

MODELLO	CITROËN: AX, BX, BOXER, BERLINGO, C25, DISPATCH, EVASION, J5, JUMPY, JUMPER, RELAY, SAXO, SYNERGIE, VISA, XM, XSARA, XANTIA, XZ, ZX. PEUGEOT: 106, 205, 206, 305, 306, 307, 309, 405, 406, 605, 607, 806, EXPERT, PARTNER, SOLARA, TALBOT.
UTENSILI OEM	7099TM (1), 0188X (2), 0188P (3), 0189AZ (4), 0188H (5), 0132AJ1 (6), 0189A (7), 0188PM (8), 21-260 (9), 4527-TS1 (10), M8X70 (11), 0188K (12), 0188J (13), 0132Q (14), 4507-TL (15), 4507-TJ (16), 9044-T (17), 4507-TJ (18), 5711-TA (19), 7014-TJ (20), 7017-TR (21), 0188X (22), 7017-TW (23), 7014-TM (24), 0189L (25)

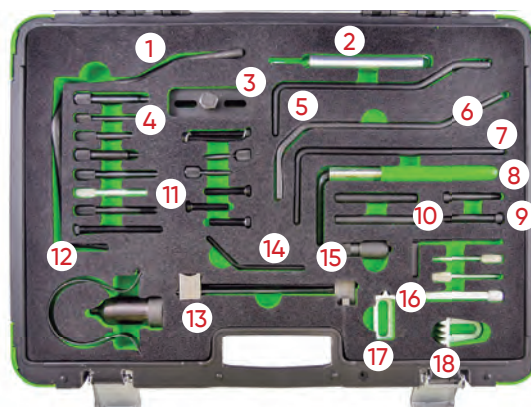

53314

98,00€



KIT DI ATTREZZI DI REGOLAZIONE CINGHIA DENTATA PER CITROEN/PEUGEOT 1.8, 2.0

MODELLO	CITROËN: C4 PICASSO/GRAND PICASSO (06-10), C5 II (04-08), C8 (05-10), DISPATCH/JUMPY (07-11), XSARA 2.0 16V, C5 1.8/2.0/HPI, XSARA PICASSO 1.8/2.0 16V (02-05). PEUGEOT: 406 1.8 16V (00-04), 407 (06-10), 807 2.0 16V (02-05).
UTENSILI OEM	0189S2 (1), 0188J (2), 0188J2 (2), 0189S1 (3), 21-260 (4), 0189B (5), 0188M (6), 0188AH (7), 0189R (8)
CODICE MOTORE	1.8 16V: EW7A(6FY). 2.0 16V: EW10A(RFJ), EW10ABE4(RFH), EW10J4S (RFK).

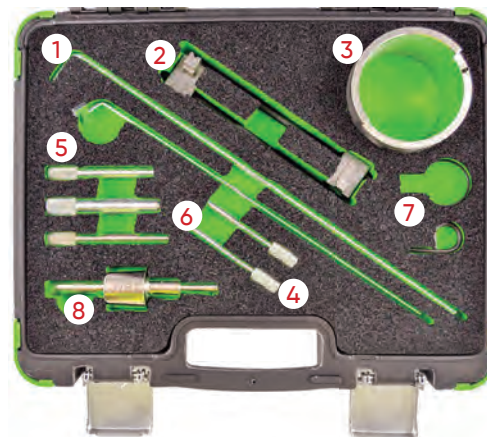

53876

64,00€

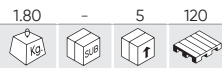

KIT DI ATTREZZI DI REGOLAZIONE CINGHIA DENTATA PER CITROËN/PEUGEOT 1.0, 1.2 VTI

MODELLO	CITROËN: C3 (III) PEUGEOT: 208, 308, 2008 SUV (2012-2014)
UTENSILI OEM	0109-2A (1) 0109-2B (2)
CODICE MOTORE	1.0/1.2 VTI. EBO, (ZMZ), EB2, (HMZ)



54288

72,50€



N

KIT DI MESSA IN FASE PSA 1.2 GDI PURETECH

MODELLO	CITROËN: BERLINGO IV (18-20), C1 II (14-18), C3 III (12-17), C3 IV (16-18), C4 CACTUS (14-20), C4 AIRCROSS (18-20), C-ELYSEE (12-18), DS3 (12-18) PEUGEOT: 108 (14-18), 208 (12-21), 2008 (13-21), 301 (12-20), 308 (13-21), 3008 (16-21), 508 (19-21), 5008 (14-21), PARTNER III (15-18) PARTNER IV (18-21) RIFTER (19-21) TOYOTA: AYGO (14-18) GM: CROSSLAND X (17-20), COMBO E (18-20), GRANDLAND X (17-20)
UTENSILI OEM	CITROËN: G-0109-6 (2), 0109-2B (1), 0109-2C (3), 0109-2D (4), 0197-N (1) PEUGEOT: G-0109-6 (2), 0109-2B (1), 0109-2C (1), 0109-2D (4), 0197-N (1) VAUXHALL: EN-52127-2 (1), EN-52809 (2)
CODICE MOTORE	1.2 VTI: 1PP(HM01), EB2 (HMZ), EB2DTS(HNY), EB2 (HMW), EB2M (HMY), EB2 (HMZ), EB-2DTS(HNY), HMP (EB2FB), HMT(EB2D), HMU(EB2D),HMV (EB2M), HMY (EB2M), HMZ (EB2), HMZ (EB2D), HMZ (EB2F),HMZ (EB2FB) 1.2 E-VTI: HMZ (EB2F), EB2F (HMZ) 1.2 PURETECH THP: HNZ (EB2DT) 1.2 PURETECH VTI: EB2ADS (HNS), EB2D(HMT), EB2ADJ (HNP),EB2ADT (HNK), EB2ADTX (HNN), EB2DTS (HNW), EB2DTM (HNW),EB2DTSM (HNW), EB2FA (HMR), EB2FAD (HMH), EB-2FAD (HMM),EB2DT (HNZ), EB2F (HMX), EB2F (HMT), EB2F(HMZ), EB2DTS(HNY),EB2M(HMY)



REF. DESCRIZIONE

16400 CALIBRO CONTROLLO CINGHIA DENTATA PSA (RIF.54288)

0.03 10 500 6,50€

54323

119,00€



N

KIT DI ATTREZZI DI REGOLAZIONE CINGHIA DENTATA PER PSA 1.0, 1.2 VTI, 1.2 GDI PURETECH

MODELLO	CITROËN: C1 II (2014-2018), C3 III (2012-2017), C3 IV (2016-2018), C4 CACTUS (2014-2020), C4 AIRCROSS (2018-2020), C-ELYSEE (2012-2018), DS3 (2012-2018), BERLINGO IV (2018-2020), GM: CROSSLAND X (2017-2020), COMBO E (2018-2020), GRANDLAND X (2017-2020) PEUGEOT: 108 (2014-2018), 208 (2012-2021), 2008 (2013-2021), 301 (2012-2020), 308 (2013-2021), 3008 (2016-2021), 508 (2019-2021), 5008 (2014-2021), PARTNER III (2015-2018), PARTNER IV (2018-2021), RIFTER (2019-2021) TOYOTA: AYGO (2014-2018).
UTENSILI OEM	EN-52127-2 (1), 0109-2B (1) J-0109-2C (2) J-0109-2D (3) EN-52127-1 (4), 0109-2A21 (4) G-0109-6 (5)
CODICE MOTORE	B12XHL (EB2DT), B12XHT (EB2DTS), D12XHL (EB2ADT), D12XHL (HNP/EB2ADT), D12XHT (EB2ADTS), EBO (ZMZ), EBOF (ZMZ), EB2ADT (HNK), EB2ADT (HNP), EB2ADTD (HNK), EB2ADTS (HNS), EB2ADTX (HNN), EB2DT (HNZ), EB2DTM (HNW), EB2DTS (HNW), EB2DTS (HNY), EB2DTSM (HNW), EB2FA, EB2FAD, F12XHT (EB2ADTS), F12XHT (HNS/EB2ADTS), HMM (EB2FAD), HMM (EB2FAD), HMP (EB2FB), HMR (EB2FA), HMT (EB2), HMT (EB2F), HMU (EB2D), HMU (EB2FD), HMV (EB2M), HMW (EB2), HMX (EB2F), HMY (EB2M), HMZ (EB2), HMZ (EB2F), HNJ (EB2ADTXM), HNK (EB2ADT), HNK (EB2ADTD), HNK/EB2ADTD, HNL (EB2ADTSM), HNN (EB2ADTX), HNP (EB2ADT), HNS (EB2ADTS), HNS/EB2ADTS, HNT (EB2ADTS), HNV (EB2DT), HNV (EB2DTM), HNW (EB2DTS), HNW (EB2DTSM), HNX (EB2DT), HNX (EB2DTS), HNY (EB2DTS), HNZ (EB2DT), HN02, ZMZ (EBO), ZMZ (EBOF), 1PP (HM01)

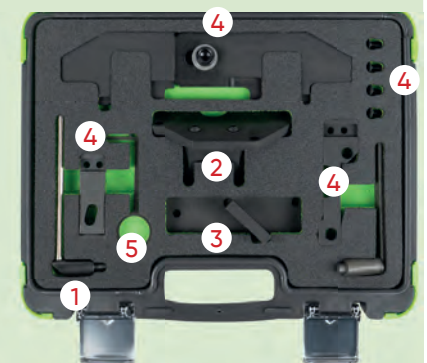

54213

19,80€

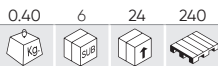

KIT DI ATTREZZI DI CRONOMETRAGGIO DEL MOTORE PER ROVER/PEUGEOT/FORD/VOLVO 2.0, 2.2L D

MODELLO	PEUGEOT: 807 (05-11), 407 (05-11), 607 (05-09).CITROËN: C4 (04-10), C5 II (04-10). LAND ROVER: FREELANDER (06-10). VOLVO: S40 (03-10), V50 (06-10), C70 (06-10), S80 (07-10), C30 906-10), V70 (07-10).FORD: S MAX 2.2 (08-10), GALAXY 2.2 (08-10), MONDEO 2.2, 2.0 (07-10).
UTENSILI OEM	PSA 0188.M, FORD 303-735, 303-1277, VOLVO 999-7122 (1) PSA 0188.X, FORD 303-1059, 303-1270, VOLVO 999-7121 (2) PSA 0188.F, FORD 303-393A, 303-393-01, 303-1272, VOLVO 999-7119/7120 (3)
CODICE MOTORE	PEUGEOT: DW10UTED4 (RHK), DW10BTED4 (RHR)DW12B-TED4 (4HS), (4HP), (4HT), (4HR). CITROËN: DW10BTED4 (RHR). LAND ROVER:DW12BTED4, 224DT. VOLVO:D420T 2.0D. FORD: QXBA(2.2), QXWA(2.0), QXBB(2.0),Q4BA(2.2), QXWA(2.0), QXWB(2.0), AZBA(2.0), AZBC(2.0), AZWA(2.0)

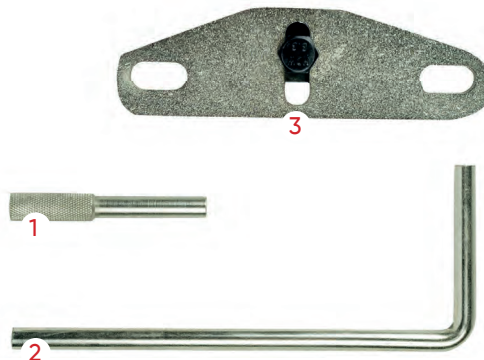

54432

43,00€



KIT DI MESSA IN FASE PER PSA 2.7, 3.0 HDI

MODELLO	CITROËN C6 JAGUAR S-TYPE (X200) 2004 - 2008, XF S (X250) 2008 - 2015, XF S (X260) 2015 - 2020, XJ6 TDV1 (X350/358) 2005 - 2010, XJ (X351) 2010 - 2020, F-PACE S 30D (X761) 2016 - 2020 LAND ROVER: DISCOVERY 3 TDV6 (L319) 2004 - 2009, DISCOVERY 4/DISCOVERY SDV6, TDV6 (L319) 2009 - 2017, DISCOVERY SD6, TD6 (L462) 2017 - 2021, RANGE ROVER SDV6, SDV6 HYBRID, TDV6 (L405) 2012 - 2021, RANGE ROVER SPORT SDV6, TDV6 (L320) 2005 - 2013 PEUGEOT 407, 607 COUPE RANGE ROVER VELAR D275, D300 (L560) 2017 - 2021, RANGE ROVER SPORT SDV6, SDV6 HYBRID, TDV6 (L494) 2013 - 2021
UTENSILI OEM	303 11117 (1), 303 11116 (2), 303 1132 (3), 303 1126 (4), 0195H (4), 0195C (5), 0195K (6), 0188-K (7)
CODICE MOTORE	2.7: DT17 TED4 (UHZ), DT17BTED4 (UHZ) 3.0: DT20C (X8C/X8Z), DT20CTED4 (X8Z)

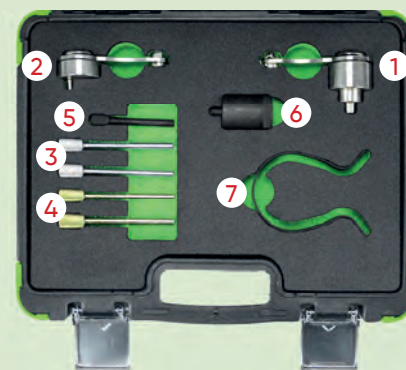

54433

18,00€



KIT DI MESSA IN FASE PER PSA 1.0, 1.1, 1.2, 1.4, 1.6, 2.0

MODELLO	CITROËN BERLINGO 2008 - 2011, C2 2003 - 2010, C-ELYSEE 2012 - 2016, C3 PLURIEL 2003 - 2010, C4 2004 - 2011, NEMO 2008 - 2015, XSARA 2000 - 2005 PEUGEOT 106 1998 - 2003, 206 1998 - 2009, 207 2006 - 2013, 306 1998 - 2003, 307 2000 - 2008, 1007 2005 - 2010, PARTNER 1998 - 2011, BIPPER 2008 - 2015
UTENSILI OEM	0132QY (1), 4507 TA (1), 0132AK (2), 0153AK (2), 0188K (2), 0189K (2), 1870 900 100 (2), 4533 TAD (2), MOT 1436 (2) 3MM PIN (3), 0132AB (4), 0178D (4), 0194A (4), 77440010400 (4), 1860.617000 (4), 11 9 790 (4), 21-260 (4), 303-732 (4), 4527 TS2 (4), 49 JEO2 018 (4), 5711 TD (4), 99360608 (4), 999 7169 (4), KM-6349 (4), 0132AJ1 (5), 0187B (5), 0189B (5), 0194B (5), 09919 58120 (5), 21 263 (5), 303 735 (5), 3031277 (5), 49 JEO2 021 (5), 607589011500 (5), 8MM DRILL BIT (5), 8MM PIN (5), 999 7122 (5), EN-52137 (5), MOT. 1430 (5), MOT 1430 (5), 0123-RZ (6), 0132R (6), 0153AA (6), 0153AB (6), 0153G (6), 0153ZY (6), 10MM PIN (6), 4507 TB (6), 7014 TN, 9767 27 (6), M10 X 70MM (6), 0132Q (7), 0132QZ (7), 132Z (7), 4507 TA (7)
CODICE MOTORE	1.0: TU9 (C1A), TU9/K (C1A), TU9M (CDY/CDZ), TU9MZ (CDY/CDZ), TU9M/L (CDZ), TU9M/L3 (CDY) 1.1: TU1A (HFV/HFX), TU1JP (HFV/HFY/HFZ), TU1JP/L4 (HFV), TU1/K (H1A), TU1M (HDZ), TU1M/L (HDZ), TU1M/L3 (HDY/HDZ), TU1M/Z (HDZ), TU1M+ (HDY/HDZ) 1.4: ET3J4 (KFU), ET3JP4 (KFU), TU3A (KFT/KFV/KFW), TU3FJ2 (K6B/KFZ), TU3FM (KDY), TU3JP (KFV/KFW/KFX), TU3JP/IFL4 (KFX)TU3JP/L3 (KFX), TU3JP/L4 (KFX), TU3JP/IFL4 (KFX), ET3J4 (KFU), TU3M (KDX), TU3M/Z (KDY) 1.6: EC5 (NFP), EC5F (NFP), TU5J2 (NFY/NFW), TU5J4 (NFU), TU5JP (NFT/NFZ), TU5JP/L3 (NFZ), TU5JP/L4 (NFT/NFV), TU5JP4 (NFU), TU5JP4B (NFR), TU5JP4S (NFS), TU5JP4/L3 (NFX), TU5JP4/L4 (NFU/NFX), XU5JP (BFZ) 1.8: XU7JB (LFX), XU7JP (LFW), XU7JP/L3 (LFZ), XU7JP4 (LFY), XU7JP4/L3 (LFY) 2.0: XU10J/C/Z (RFU), (RGX), XU10J2E/V (RGX), XU10J2U (RFL), XU10J4R (RFR/RFV), XU10J4R/L3 (RFV), XU10J4RS/L3 (RFS)

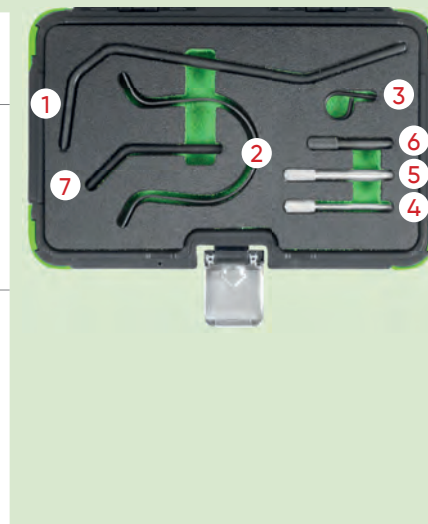

53293

134,00€

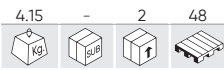

KIT DI ATTREZZI DI REGOLAZIONE CINGHIA DENTATA PER- FORD

MODELLO	B-MAX (12-17), C-MAX (07-17), COUGAR (98-01), COURIER (00-02), ESCORT (94-98), FIESTA (95-17), FOCUS (98-17), FOCUS C-MAX (03-07), FUSION (02-12), GALAXY (06-15), GRAND C-MAX (10-17), KUGA (08-15), MAVERICK (01-07), MONDEO (93-15), ORION (94-94), PUMA (97-02), S-MAX (06-15), TOURNEO CONNECT (02-15), TRANSIT (06-11), TRANSIT CONNECT (02-16), ECOSPORT (13-15), TOURNEO COURIER (14-15), GRAND TOURNEO COURIER (13-15).
UTENSILI OEM	303-376 (21-162B) (1), 303-1059 (2), 303-193 (21-104) (3), 303-393-01 (4), 303-1054 (5), 303-1097 (6), 303-748 (7), 303-734 (21-262) (8), 303-651 (21-229) (9), 303-393A (21-168) / 303-393-02 / 303-507 (21-210) / 303-620 (21-163)/ 303-732 (21-260) / 303-735 (21-263).
CODICE MOTORE	PETROL: AODA/B, ASDA, ASDB, CFBA, CGBA/B, CHBA/B, CJBA/B, CSDA/B, DHA, DHB, DHC, DHD, DHE, DHF, DHG, EDBB, EDBD, EDDB, EDDC, EDDD, EDDF, EYDB, EYDC, EYDD, EYDE, EYDF, EYDG, EYDI, EYDJ, EYPA, EYPC, F8JA, F8JB, FHA, FHD, FHE, FHF, FUJA, FUJB, FXDA/C, FXDB/D, FXJA, FXJB, FYDA/C, FYDB/D, FYJA, FYJB, HWDA, HWDB, L1F, L1J, L1L, L1N, L1Q, L1T, L1V, L1W, M7JA, M7JB, MHA, MHB, NGA, NGB, NGC, NGD, QQDA/B/C, QQDB, RKA, RKB, RKF, RKH, RKJ, RKK, HXDA. GASOIL: F6JA, F6JB, F6JC, HHJA, HHJB, G8DA, HHDA, HHDB, RTN, RTQ, RTP, C9DC, BHDA/B, BHPA, C9DA/B, F9DA/B, FFBA, FFDA, HCPA, HCPB, KKDA, P7PA, P9PA, QYWA, R2PA, R3PA, RWPA, G6DA, G6DB, G6DC, AZWA, QXWA.

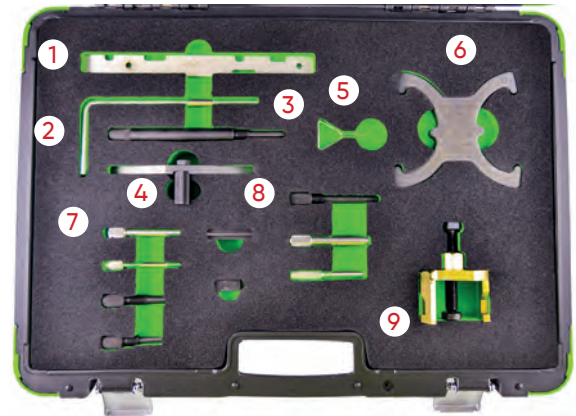

53294

119,00€

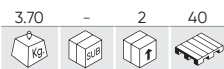

KIT DI ATTREZZI DI REGOLAZIONE CINGHIA DENTATA PER FORD MAZDA

MODELLO	FORD: COURIER (00-02), C-MAX (03-10), FIESTA (02-11), FOCUS (98-11), FUSION (02-11), GALAXY (06-10), KUGA (06-10), MONDEO (07-10), S-MAX (06-10), TOURNEO CONNECT (02-13), TRANSIT CONNECT (02-13) PEUGEOT: BIPPER (08-10) DISPATCH/JUMPY III (07-12) EXPERT III (07-12) NEMO (08-10) PARTNER I/II (05-11) PARTNER III (08-16) 107 (05-10) 1007 (05-10) 206 (01-12) 206+ (09-13) 206 CC (05-07) 207 (06-13) 207 CC (07-15) 208 (11-15) 307 (01-08) 308 (07-15) 308 CC (09-15) 407 (05-11) 508 (04-15) 2008 (13-15) 3008 (09-15) 4008 (12-15) 5008 (09-15). MAZDA: 2 (02-15), 3 (09-14) CITROËN: C1 (05-10), C2 (03-10), C3 I/II (02-10), C3 III (10-15), C3 PLURIEL (04-10), C3 PICASSO (09-12), C4 (04-11), C4 II (11-15), C4 PICASSO (06-12), C4 GRAND PICASSO (10-12), DS3 (09-12), DS4 (11-12), DS5 (12-15), C5 II (04-08), C5 III (04-12), XSARA II (02-04), XSARA PICASSO (04-10)
UTENSILI OEM	FORD: 303-376B (1), 303-193 (2), 303-393 (3), 303-732 (4), 303-651 (5), 303-393/01, 303-1059, 303-734, 303-735. MAZDA: 303-732, 303-734, 303-735. PSA: 0194-A, 0194-C, 0194B.
CODICE MOTORE	1.4D TDCi/Hdi: DV4TD(8HT), DV4TD(8HX), DV4TD(8HZ), DV4TD(8HW), DV4TED4(8HX), DV4TED4(8HV), DV4TED4(8HY), DV4C(8HP), DV4C(8HR), DV4TED(8HS), F6JA, F6JB, F6JC. 1.6D TDCi/HDi: DV6TED4(9HZ), DV6ATED4(9HX), DV6TED4(9HY), DV6DTE4(9HP), DV6C(9HR), DV6CATED(9HX), DV6C(9HL), DV6TED(9HP), DV6ATED(9HY), DV6TED4(9HV), DV6TED4(9HX), DV6C(9HD), DV6C(BHX), DV6C(BHZ), DV6(9HR), DV6BTED4(9HW), DV6DTED(9HJ), DV6ETED(9HN), DV6ATED4BU(9HS), DV6BTED4(9HT), DV6BUTED4(9HT), DV6TED4B(9HV), DV6UTED4(9HX), DV6TED(9HD), DV6UTED4(9HU), DV6D(9HP), DV6TED4(9HV), DV6C(9HD), DV6TED4(9HW), DV6AT(9HX), DV6ATED(9HX), DV6CTED(9HC), DV6AUTED4(9HX), DV6TED4B, DV6DTE4(9HF), HHJA, HHJB, G8DA, G8DB, HHDA, HHDB, MZ-CD, Y6. 1.8D TDCi/HDi: BHPA, C9DA/B, FFBA, G6DA, G6DB, G6DC, HCPA, HCPB, KKDA, P7PA, P9PA, R2PA, R3PA, RWPA. 1.8c: C9DC, RTN, RTQ. 1.8D Td: C9DA/B, C9DC. 2.0D TDCi/HDi: AZWA, G6DA, G6DB, G6DC, RHE(DW10CTED4), QXWA, QXWB.

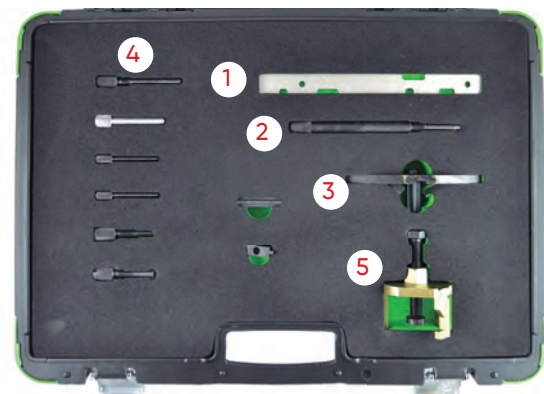

53318

24,00€



ESTRATTORE RUOTA DENTATA DI ALBERO A CAMME PER FORD

MODELLO	FORD
UTENSILI OEM	F8M, F8Q, S8U, S9U.



53295

77,00€

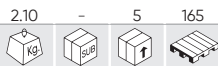

KIT DI ATTREZZI DI REGOLAZIONE CINGHIA DENTATA PER FORD 1,8TDDI, TDCI

MODELLO	C-MAX (07-10), COURIER (00-02), FIESTA (00-02), FOCUS (98-11), FOCUS C-MAX (03-07), GALAXY (06-10), MONDEO (07-10), S-MAX (06-14), TOURNEO CONNECT (02-13), TRANSIT CONNECT (02-13).
UTENSILI OEM	303-193 (21-104) (1), 303-393 (21-168) (2), 303-376 (21-162B) (3), 303-652 (21-230) (4), 310-095 (23-067) (5)
CODICE MOTORE	1.8D TDCI: BHPA, F9DA, F9DB, FFBA, FFDA, FFWA, HCPA, HCPB, KHBA, KKDA, KKDB, P7PA, P9PA, P9PB, QYBA, QYWA, R2PA, R3PA, RWPA, RWPC. 1.8D TDCI ECONETIC: KHBA. 1.8D TDI: BHDA, BHDB, BHPA, C9DA, C9DB, C9DC. 1.8D TURBO: C9DC, RTN, RTP, RTQ.



53296

60,00€



KIT DI ATTREZZI PER MONTAGGIO E REGOLAZIONE POMPA CARBURANTE PER FORD/JAGUAR DURATORQ

MODELLO	FORD: MONDEO (00-07), TRANSIT (00-14). CITROËN: RELAY, JUMPER III (06-13). FIAT: DUCATO (06-11).	JAGUAR: X-TYPE (03-10). PEUGEOT: BOXER III (06-12). LAND ROVER: DEFENDER TD4 (06-11). LDV: CONVOY (02-06).
UTENSILI OEM	303-1151 (1), 303-679A/21-238 (2), 303-732 (3), 303-675/21-234 (4), 303-698/21-251 (5)	
CODICE MOTORE	1.2D DI/TDDI/TDCI: ABFA, D3FA, F3FA, D5BA, D6BA, F1FA, FMBA, FMBB, HJBA, HJBB, HJBC, HJBE, N7BA, N7BB. 2.2D TDCI/ECONETIC: BG, CYFA, CYFB, CYFC, DRFA, DRFB, DRFC, P8FA, P8FB, PGFA, PGFB, QJBA, QJBA (BG), QJBB, QJBC, QJBD, QVFA, QWFA, SRFA, SRFB, SRFC, SRFD, SRFE, UHFA. 2.2D HDI/JTD: P22DTE (4HM), P22DTE (4HU), P22DTE (4HV). 2.4D DI/TDCI: DOFA, D2FA, D2FB, D4FA, F4FA, FXFA, H9FA, H9FB, H9FD, JXFA, JXFC, PHFA, PHFC. 2.4D TD/TDI: ZSD 424. 2.4D TD4: 244DT.	

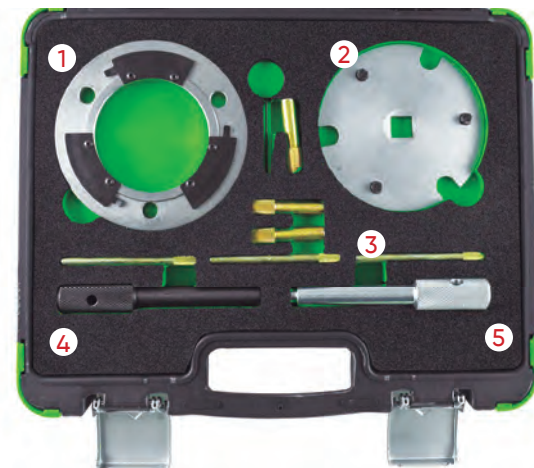

54419

57,00€

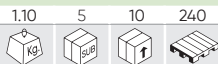

ESTRATTORE/INSTALLATORE PER GUARNIZIONI ALBERO MOTORE ANTERIORE FORD DURATORQ 2.0, 2.2, 2.4, 3.2

MODELLO	FORD MONDEO 2000 - 2007 RANGER 2011 - ON TRANSIT 2000 - 2006 TRANSIT 2006 - 2014 TRANSIT 2014 - 2019 TRANSIT/TOURNEO CUSTOM 2012 - 2016
UTENSILI OEM	21 238 (1), 303-679A (1), 303-682 (2)
CODICE MOTORE	2.0 Di ABFA D3FA F3FA 2.0 TDCI FMBA FMBB HJBA HJBB HJBC N7BA N7BB SDBA F1FA 2.0 TDDi D5BA D6BA 2.2 TDCI QJBA QJBB QJBC QJBD GBVAJQF GBVAJQJ GBVAJQW CVRA CVRB CYFA CYFB CYFC CYRA CYRB DRFA DRFB DRFC DRFE DRRB DRRB P8FA P8FB PGFA PGFB QVFA QWFA SRFA SRFB SRFC SRFD SRFE UHFA UHFB 2.4 Di D2FA D2FB D4FA DOFA F4FA FXFA 2.4 TDCI H9FA H9FB H9FD JXFA JXFC 3.2 TDCI SAFA SA2R SA2S SA2W SAFA SAFB



54420

102,00€



N

SET REGOLAZIONE CARBURANTE - FORD / VOLVO 2.5 (EURO 4)

MODELLO	FORD: FOCUS 2.5 RS / ST, MONDEO 2.5, S-MAX 2.5, GALAXY 2.5 ST (2005-) VOLVO: C30 (06-10), C70 (98-10), S40 (96-10), S60 (00-09), S70 (97-07), S80 (98-06), V40 (96-10), V50 (04-10), V70 (97-07), XC70 (02-07), XC90 (02-10)
UTENSILI OEM	303-1178 (1), 999 5452 (1), MOT 1337 (1) 303-1182 (2), 999 5451 (2), MOT 1340 (2) 303-1179 (3), 999 5433 (3) 303-1183 (4)
CODICE MOTORE	FORD: 2.5 Turbo (Euro 4), HUBA / HUWA / HYDA / JZDA VOLVO: 1.6 (B4164S), 1.8 (B4184S), 1.9T (B4194T), 2.0 (B4204S / B4204T), 2.0T (B5204T3 / B5204T4 / B5204T5), 2.3 (B5234FS), 2.3T (B5234T3 / B5234T7 / B5234T9) VOLVO: 2.4 (B5244S / B5244S2 / B5244S4 / B5244S5 / B5244S7), 2.4T (B5244T / B5244T3 / B5244T4 / B5244T5 / B5244T7), 2.5R (B5254FS), 2.4D (D5244T9 / D5244T8 / D5244T13)

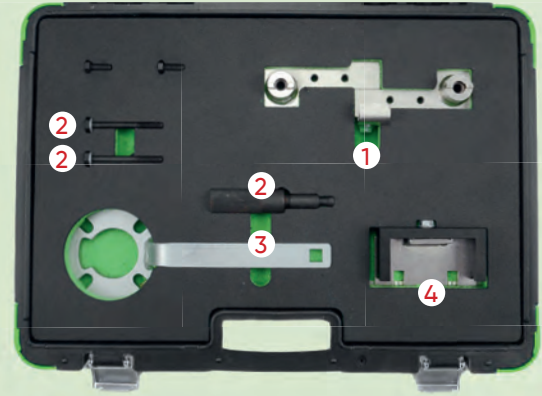

54421

52,00€



N

INSTALLATORE CINGHIA AUSILIARIA FORD/VOLVO 1.4 1.6

MODELLO	FORD 1.4, 1.6 (FOCUS, C-MAX, MONDEO) VOLVO 1.6 (S40, C30, V50)
UTENSILI OEM	303-1179
CODICE MOTORE	B4164S3, FUJA, FXJA, FYJA C12HM7AD, C12LM7AA, ZH12FUJA, ZH12FUJB, ZH12M7JB C14HDEZ, C14HHADB, ZH14ASDA, ZH14FXDA, ZH14FXDB, ZH-14FXDC, ZH14FXDD, ZH14FXJA, ZH14FXJB 16HDEZ, CH16HDEZ, C16HHDEY, ZH16FYDA, ZH16FYDB, ZH16FY-DC, ZH16FYDD, ZH16FYDH, ZH16FYJA, ZH16FYJB, ZH16HWDA, ZH16HXDA



54424

64,50€



N

KIT DI MESSA IN FASE PER FORD 2.0 ECOBOOST

MODELLO	FOCUS, GALAXY, MONDEO, S-MAX
UTENSILI OEM	303-1504 (1) 303-1600 (2), 300-1565 (2) 303-1521 (3) 303-748 (4) 303-1595 (5) 2MM TENSIONER (6)
CODICE MOTORE	MGDA, R9CB, R9CD, R9CF, R9CH, R9DA, R9DB, R9DC, R9DD, TNBA, TNBB, TNCC, TNCD, TNCF, TNWA, TNWB, TPBA, TPWA, TVDA, XQDA

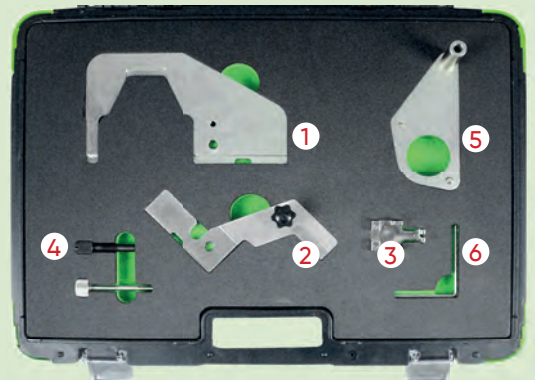

53324

12,50€

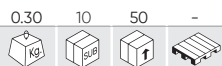

ATTREZZO DI REGOLAZIONE CINGHIA DENTATA PER FORD

MODELLO	FORD: B-MAX (15-17), C-MAX (07-10), COUGAR (98-01), FIESTA (95-17), FOCUS (98-11), FOCUS C-MAX (03-07), FUSION (02-12), GALAXY (06-15), MAVERICK (01-07), MONDEO (93-15), PUMA (97-02), S-MAX (06-15), TOURNEO CONNECT (02-06), TRANSIT (06-12), TRANSIT CONNECT (02-06). MAZDA: 121 ZG (95-00), 2 DY (02-07), 3 BK (03-09), 3 BL (09-15), 5 CR (05-10), 5 CW (10-12), 6 GG/GY (02-07), 6 GH (07-15), MPV LW (02-05), MX-5 NC (05-16), TRIBUTE EP (04-06). VOLVO: C30 (06-13), S40 (06-12), S80 (07-11), V50 (04-12).
UTENSILI OEM	FORD: 303-1054, 303-507 (21-210), 303-620 (21-163), 303-574, 303-748, 303-376 (21-162B), 303-376B MAZDA: 49 JE01 061, 303-574, 49 JE02 061, 303-465, 49 JE01 054 VOLVO: 999 7152, 999 7151.
CODICE MOTORE	1.4 / 1.6

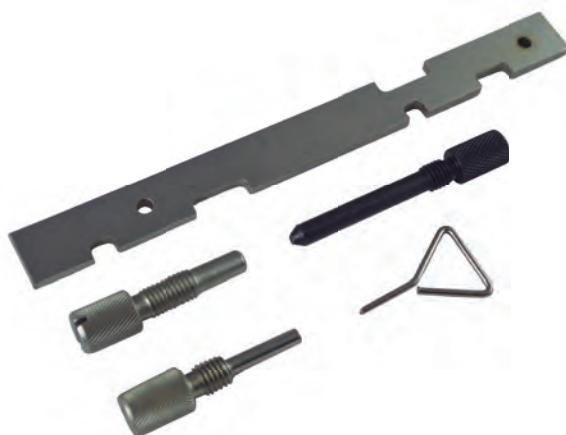

53653

207,00€

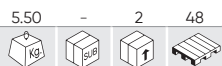

ATTREZZO DI REGOLAZIONE CINGHIA DENTATA PER FORD

MODELLO	FORD: FIESTA, FOCUS, B-MAX, ECOSPORT.
UTENSILI OEM	303-1605 (1), 303-1606 (2), 303-1604 (3), 303-1602 / 503-393A / (21-168) (4), 303-1054 (5), 303-732 (6)
CODICE MOTORE	M1DD, M1JA, M1JC, M1JE, M1JHM1JJ, M1DA, M2DA, M2DB, M2DC, SFDBSFJA, SFJB, SFJC, SFJD

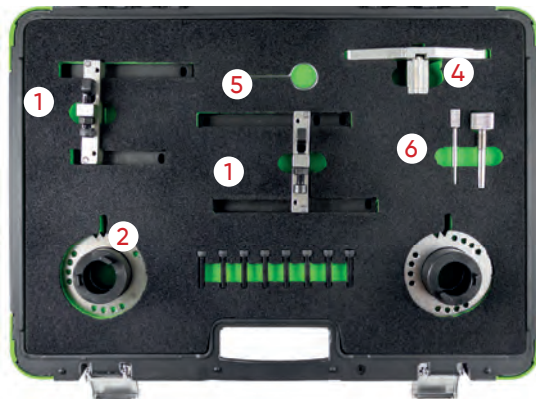

54201

37,60€

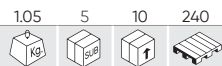

SET DI STRUMENTI PER LA FASATURA DEL MOTORE FORD

MODELLO	FORD: C-MAX(07 - 10), C-MAX/GRAND C-MAX(10-18), FIESTA(08-18), FOCUS/FOCUS C-MAX(04-11), FOCUS(11-18), MONDEO(07-15)
UTENSILI OEM	303-1097 (1), OEM 303-1054 (2), OEM 303-1059, 303-1270, 0188X, 999-7121 (3), OEM 303-748, 999-7152, 21-259 (4), OEM 303-735, 999 7122, 0187B, 0189B, 0132AJ1, 21-263, 0188M, MOT 1430, 303-1277, 0194B (5)
CODICE MOTORE	11.6 TI-VCT HXDA (2003-2007) ,2.0 TDCI , G6DA, G6DB, G6DC 2003-2007



54204

124,00€



KIT DI ATTREZZI DI CRONOMETRAGGIO DEL MOTORE PER FORD 2.0 ECOBLUE

MODELLO	FORD EDGE, FOCUS, GALAXY, S-MAX (FROM 2018); KUGA, MONDEO, RANGER (DESDE 2019); TRANSIT, TRANSIT CUSTOM AND TOURNEO CUSTOM (DESDE 2016); TODOS CON MOTOR ECOBLUE TDCI ; AWD, FWD Y RWD.
UTENSILI OEM	303-1637 (1), 303-1650 (2), 303-1643 (3).
CODICE MOTORE	BCCC,YLCB,YLDA,YLF6,YLFA,YLFB,YLFS,YLR6,YLRA,YMCB,YM-F6,YMFA,YMFB,YMFS,YMHA,YMRA,YNCA,YNF6,YNFA,YNFB,YNFS,Y-NR6,YNRA

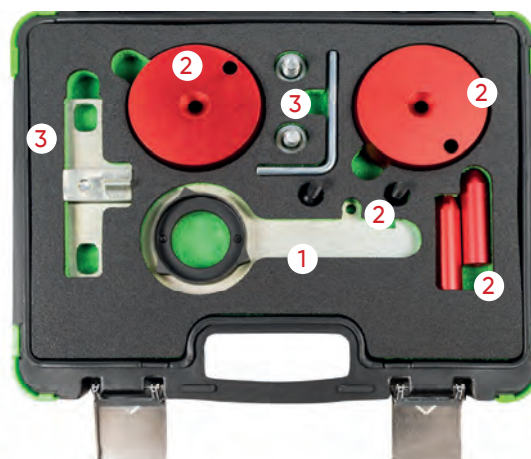

54208

76,00€



KIT DI ATTREZZI DI CRONOMETRAGGIO DEL MOTORE PER FORD 2.0 ECO BOOST SCTI, TI-VCT

MODELLO	FORD: GALAXY(2010)MONDEO (2010) S MAX (2010) FOCUS(2011)
UTENSILI OEM	303-748 (1), 303-1504 (2), 303-1565 (3), 303-1521 (4)
CODICE MOTORE	TNWA, TNWB, TPWA, TNBA, TPBA, MGDA, XQDA

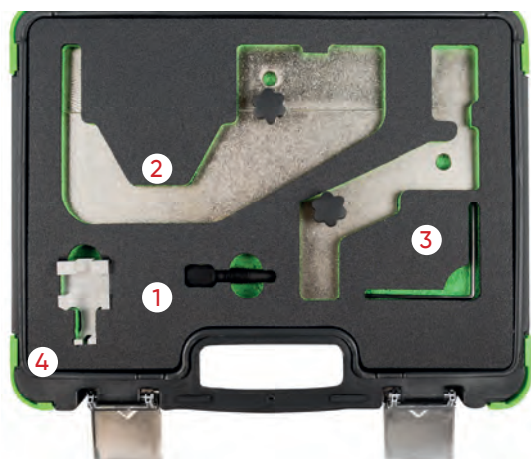

54209

29,70€



KIT DI ATTREZZI DI CRONOMETRAGGIO DEL MOTORE PER FORD/MAZDA 2.2, 3.2 TDCI

MODELLO	FORD_RANGER 3.2L (2011-2016) FORD_RANGER 2.2L (2011-2015) FORD_TRANSIT 2.2L (2006-2016) FORD_EVEREST 3.2L (2015) FORD_RANGER 3.2L (2011) MAZDA BT-50 (2011) MAZDA BT-50 3.2L (2011-2016)
UTENSILI OEM	303-675/21-234,303-698/21-251 (1), 303-1587 (2)
CODICE MOTORE	CYFA,CYFB,DRFA,DRFB,P8FA,P8FB,PGFA,PGFB,QVFA,QWFA,SR-FA,SRFB,SRFC,SRFD,SEFE,UHFA,CYFC,DRFC,USRA

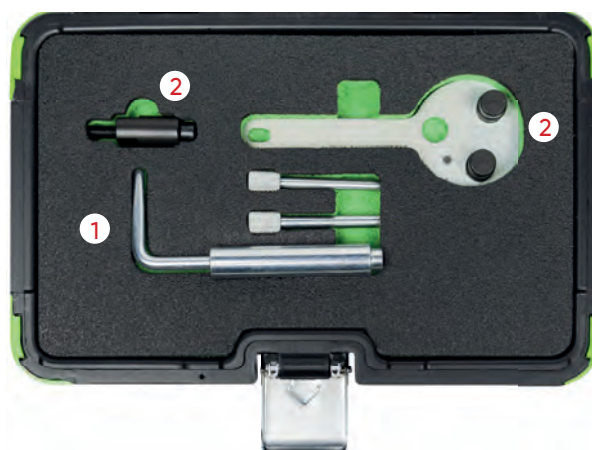

54223

149,00€



KIT DI ATTREZZI DI BLOCCAGGIO DELLA RUOTA DENTATA DELL'ALBERO A CAMME PER FORD 1.5T

MODELLO	FORD_1,5L DURATEC, ECOSPORT, FIESTA, FOCUS
UTENSILI OEM	303-1639 (1), 303-1643 (2), 303-1647 (3), 303-1648 (4)
CODICE MOTORE	2.2 / 2.5

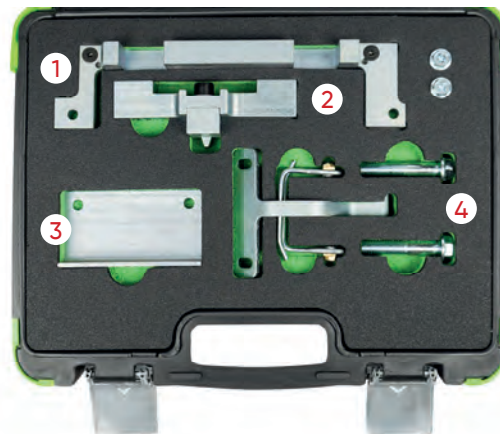

54224

64,50€

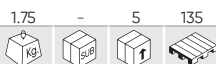

KIT DI ATTREZZI PER INSTALLAZIONE E RIMOZIONE DELLA POMPA DI INIEZIONE PER FORD 2.0

MODELLO	FORD: TRANSIT (17-18), TOURNEO CUSTOM (16-18), TRANSIT CUSTOM (16-18)
UTENSILI OEM	303-1635 (1)/3, 3.3--1635 (2)/1, 303-1635 (3)/2, 303-1635/6 (4)
CODICE MOTORE	YLFS, YMFS, YNFS, YLF6, YMF6, YNF6, YLR6, YMR6 AND YNRS.

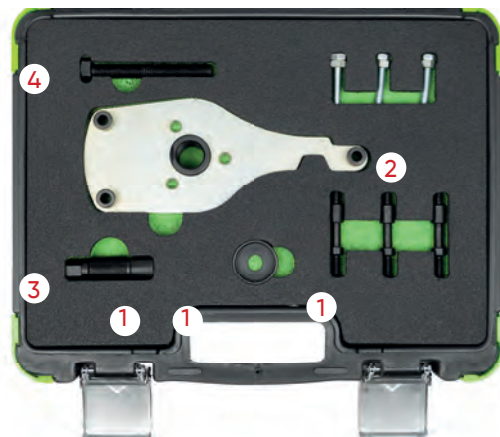

54260

277,00€

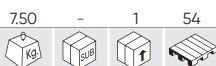

KIT DI MOLTIPLICATORE DI FORZA 5:1 PER MOTORI FORD ECOBOOST



1.0 Ecoboost
1.0 Duratec
2.0 Duratec

2.0 Durator-TDCi
2.0 EcoBlue Diesel



53297

45,00€

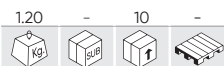

KIT DI ATTREZZI DI REGOLAZIONE CINGHIA DENTATA PER JAGUAR/LAND ROVER

MODELLO	JAGUAR: MS TYPETDVI. LAND ROVER: DISCOVERY 2.7 TDV6. RANGE ROVER: SPORT 2.7 TDV6.
UTENSILI OEM	303-1117 (1), 303-1116 (2), 303-1132 (3), 303-1126 (4) (5)
CODICE MOTORE	276DT, 306DT.

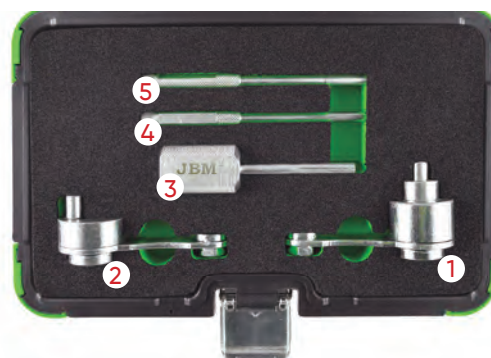

53298

91,00€



KIT DI ATTREZZI DI REGOLAZIONE CINGHIA DENTATA PER LAND ROVER

MODELLO	MOTORI DIESEL: 200 TDI. 300 TDI. 2.5
	<ul style="list-style-type: none"> - Perno di sincronizzazione trasmissione manuale EDC 200 TDI. - 2.5 Motori diesel. - Estrattore dell'ammortizzatore dell'albero motore. - Instrumenti di bloccaggio della pompa di iniezione. - Bullone di sincronizzazione dalla pompa d'iniezione 200/300 TDI. - Strumento di sincronizzazione del volante motore 200/300 TDI. - Strumento di sincronizzazione della pompa DPS 2.5. - Strumento di sincronizzazione del volante del motore 2.5.



54422

140,00€



KIT REGOLAZIONE EQUILIBRIO ASSE JAGUAR/LAND ROVER 2.0D

MODELLO	JAGUAR: E-PACE D150, D180, D240 (X540) (2017-), F-PACE 20D, 25D, E-PERFORMANCE (X761) (2016-), XE 20D, 25D, E-PERFORMANCE (X760) (2015-), XF 20D, 25D, E-PERFORMANCE (X260) (2015-) LAND ROVER: DEFENDER SD4 D200, SD4 D240 (L663) (2019-2021), DISCOVERY SPORT ED4, SD4, TD4, D150, D180, D240 MHEV (L550) (2015-), DISCOVERY SD4, TD4 (L462) (2017-2021) RANGE ROVER: EVOQUE ED4, SD4, TD4 (L538) (2015-2019), EVOQUE D150, D180, D240 MHEV (L551) (2019-), SPORT SD4 (L494) (2016-2018), VELAR D180, D240 (L560) (2017-)
UTENSILI OEM	JLR-303-1662 (1) JLR303-1663-1 (2) JLR303-1663-2 (3) JLR303-1663-3 (4) JLR-303-1664 (5) JLR-303-1665 (6)
CODICE MOTORE	2.0: AJ200D,AJ200/204DTA,AJ200/2004DTD 2.0: AJ-200D/204DT, AJ-200D/204DTA



54423

108,00€



N

KIT DI MESSA IN FASE PER LAND ROVER 3.6D

MODELLO	RANGE ROVER SPORT; 3.6 (TDV8) DIESEL (2006-2011) RANGE ROVER; 3.6 (TDV8) DIESEL (2006-2011)
UTENSILI OEM	303-1236 (1) 303-1243 (2) 303-1239 (3) 303-1238 (4)
CODICE MOTORE	368DT

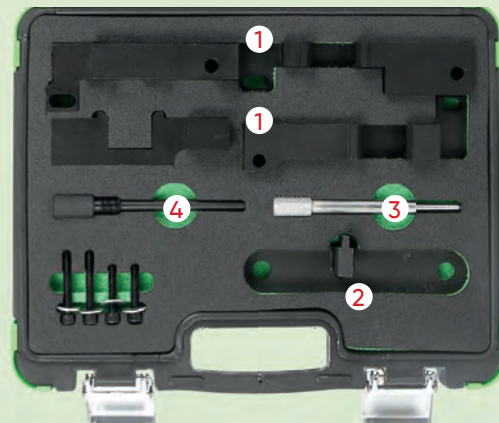

54425

124,00€



N

KIT DI MESSA IN FASE PER LAND ROVER FREELANDER V6/ROVER KV6 2.0L, 2.5L

MODELLO	LAND ROVER: FREELANDER (2000-2006) MG: ZR (2004-2005), ZS (2001-2005), ZT (2001-2005) ROVER: 45 (1999-2005), 75 (1999-2005), 825 (1996-1999)
UTENSILI OEM	LRT 12-175 (1) LRT 12-187 (2) LRT 12-195 (3) LRT 12-196 (4) LRT 12-198 (5) LRT 12-232 (6)
CODICE MOTORE	LAND ROVER: 2,5 KV6 MG: 2,0 KV6, 2,5 KV6 ROVER: 2,0 KV6 2,5 KV6

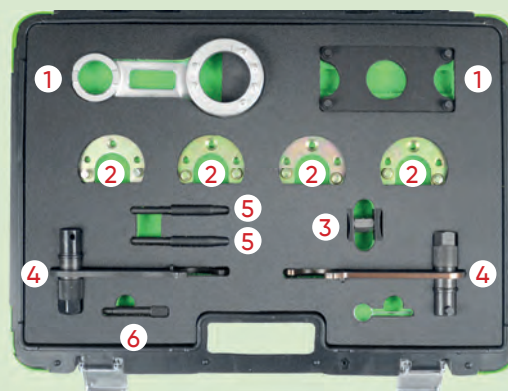

54426

69,00€



N

KIT DI MESSA IN FASE PER JAGUAR/LAND ROVER 3.2, 3.5, 4.0, 4.2, 4.4

MODELLO	DAIMLER: V8 (97-03), SUPER V8 (97-03), SUPER EIGHT (05-10). JAGUAR: S-TYPE (99-08), XF (08-09), XJR (97-10), XJ8 (97-10), XKR (98-09), XK8 (96-09) LAND ROVER: DISCOVERY III (04-09) RANGE ROVER (05-09), RANGE ROVER SPORT (05-09)
UTENSILI OEM	303530 (1) 303531 (2) 303532 (3) 303533 (4) 303645 (5) 303654 (6) T40011 (7)
CODICE MOTORE	3.2: AC,KB,KC 3.5: RB 4.0: BC, CC,CE,DC,EC,GB,GC,LB,LC,MA,MB,NB,NC,PA,PB 4.2: 1B,2B,3B,1G,5G,9G,HB,HG,SB,TB,PC,428PS 4.4: 448PN

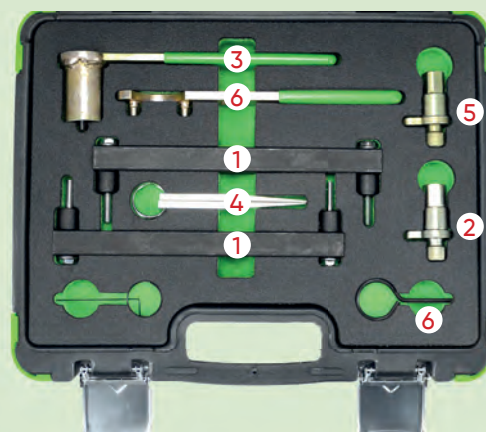

54427

113,00€

5.00 - 2 48



N

ATTREZZO PER IL BLOCCAGGIO DELLA PULEGGIA DELL'ALBERO MOTORE JAGUAR/LAND ROVER 4.0, 4.2, 4.4

MODELLO	DAIMLER: V8; 4.0 (97-98) JAGUAR: S-TYPE; 3.2, 3.5, 4.2 V8 (99-08), XF; 3.2, 3.5, 4.2 V8 (08-09), XJ; 3.2, 3.5, 4.2 V8 (97-08), XJ8; 4.0 (97-98), XK; 3.2, 3.5, 4.2 V8 (97-08), XK8; 4.0 (97-98) LAND ROVER: DISCOVERY3; 4.2, 4.4 LA V8 (05-09) RANGE ROVER; 4.2, 4.4 SPORT LS V8 (05-09), RANGE ROVER; 4.2, 4.4 LM V8 (06-08)
UTENSILI OEM	LRT 12 080 18G 1437 18G 1437 2 303 191 303 191 03 303 191 04 303 588 303 893
CODICE MOTORE	AJ26, AJ27, AJ28, AJ34 30G,36D,42D,56D,58D,94D,428PS,448PN



54428

31,00€

1.10 5 10 240



N

KIT DI MESSA IN FASE PER CHRYSLER/JEEP 2.8 CRD

MODELLO	CHRYSLER GRAND VOYAGER 2008 - 2015 DODGE NITRO 2007 - 2011 JEEP CHEROKEE 2008 - 2013, WRANGLER 2007 - 2018
UTENSILI OEM	VM 9991 (1) VM 9992 (2)
CODICE MOTORE	VM64C, ENS, ENS (51C), 49C, 50C, ENS VM10D, ENS VM11D



54429

55,00€

2.50 - 5 135



N

KIT DI MESSA IN FASE PER CHRYSLER/JEEP 3.0D

MODELLO	CHRYSLER 300 C 2012 - 2015 JEEP GRAND CHEROKEE 2011 - ON
UTENSILI OEM	VM 10338 1 (1) VM 10338 2 (2) VM 10359A (3), VM 10359 (3) VM 10339 (4), VM 10359 (4)
CODICE MOTORE	3.0 CRD: EXF 3.0 CRD/MULTIJET: EXF VM23D, EXF VM44D, EXF VM44D, EXF VM63D

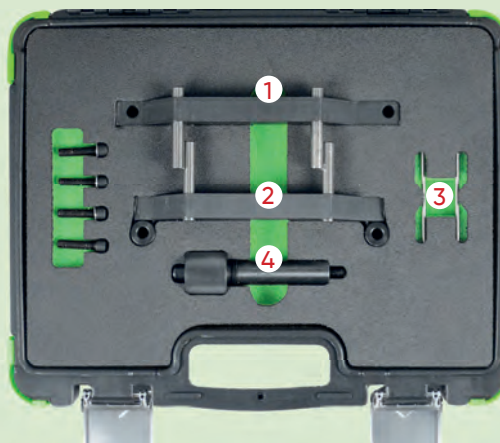

54207

38,90€

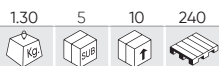

KIT DI ATTREZZI DI CRONOMETRAGGIO DEL MOTORE PER CHRYSLER/JEEP LDV 2.5 CRD

MODELLO	CHRYSLER: VOYAGER (01-08), GRAND VOYAGER (01-08) JEEP: CHEROKEE (01-08) LDV: MAXUS (05-09)	
UTENSILI OEM	VM 9660 (1), VM1052 (2), VM1053 (3), VM1068 / VM1089 (4), VM1080 (5), VM8873 (6)	
CODICE MOTORE	2.5D CRD: R2516C, R2516K, R2516LVM39/40B.	2.8D CRD: R2816C5.05A, R2816K4.

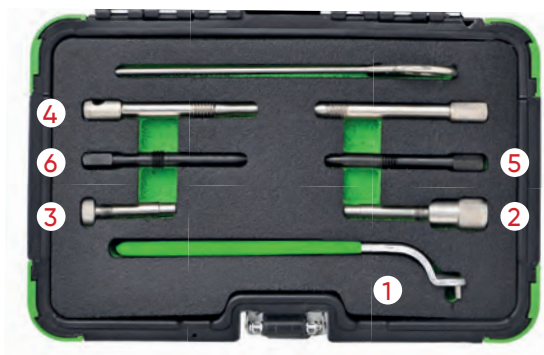

53270

70,00€

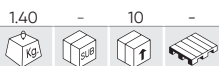

KIT DI ATTREZZI DI REGOLAZIONE CINGHIA DENTATA PER MERCEDES/CHRYSLER/JEEP

MODELLO	MERCEDES CHRYSLER JEEP
UTENSILI OEM	112589034000 (1), 601589024000 (2), 111589031500 (3)
CODICE MOTORE	HERR.: 112 589 03 40 00; 112, 113, 137, 155, 156, 272/979, 273, 629, 642/992. HERR.: 601 589 02 40 00: 102, 103, 104, 111, 601, 602.91/93/94/96/983, 603.91/93/96/97, 604, 605, 606, 611, 612/965/966, 613. HERR.: 111 589 03 15 00: 111, 119, 604, 605, 606, 611/980, 612, 613, 628, 629, 640, 642/922, 612.965/966, 646, 647, 648.

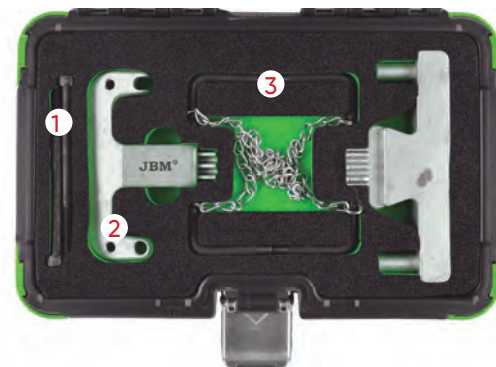

53271

227,00€



KIT DI ATTREZZI DI REGOLAZIONE CINGHIA DENTATA PER MERCEDES BENZ M271

MODELLO	MERCEDES
UTENSILI OEM	271 589 003100 (1), 271589014000 (2), 271589001500 (3), 156589006100 (4)
CODICE MOTORE	M271. E18ML 2002. DE18ML 2003 - 2005. E16ML 2008. DE18LA 2009.

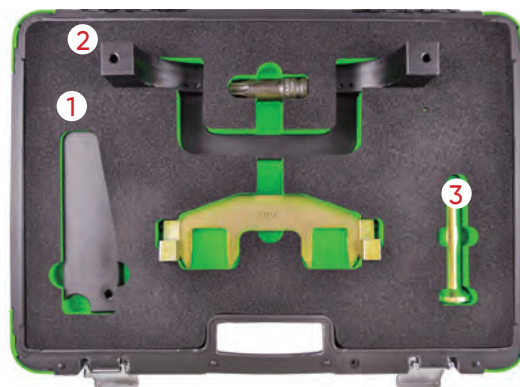

53272

195,00€

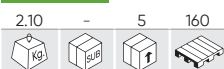

KIT DI ATTREZZI DI ALLINEAMENTO PER MERCEDES BENZ AMG 156

MODELLO	MERCEDES
UTENSILI OEM	156589006100 (1), 156589003200 (2), 156589016300 (3), 156589006900 (4)
CODICE MOTORE	BENZ AMG 156.ML 63 AMG.S 63L AMG.S 63. AMG. R 63 AMG L 4MATIC. R63 AMG 4MATIC. E 63 AMG. CLS 63 AMG. CLK 63 AMG BLACK SERIES. CLK 63 AMG CABRIO. CL 63 AMG.

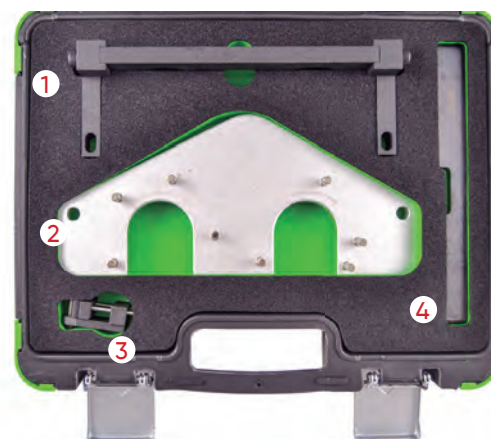

53273

75,00€



KIT DI ATTREZZI DI REGOLAZIONE CINGHIA DENTATA PER MERCEDES M276, M157, M278

MODELLO	MERCEDES		
UTENSILI OEM	27658901400		
CODICE MOTORE	<table border="0"> <tr> <td>CL 500 / 63 AMG (C 216) 2010-2013. S 500 / 63 AMG (C 217) 2014. CLS 300 (C 218) 2012. E 300 / 350 / 400 (C/A 207) 2011. CLS 350 / 400 / 500 / 63 AMG (C/X 218) 2011-2014. SLK 350 (R 172) 2011. SL 350 / 400 / 500 / 63 AMG (R 231) 2012. S 500 PLUG-IN HYBRID (V 222) 2014. ML 300 / 350 / 500 / 63 AMG (W 166) 2011.</td> <td>C 400 (W 205) 2014. E 400 HYBRID (W 212) 2012. G 63 AMG (W 463) 2012. E 300 / 350 / 400 / 500 / 63 AMG (W/S 212) 2011. C 350 (W/S/C 204) 2011. S 350 / 500 / 63 AMG (W/V 221) 2010. S 400 / 63 AMG (W/V 222) 2013. R 350 BlueEFFICIENCY (W/V 251) 2012. GL 450 / 500 (X 166) 2012. GLK 350 (X 204) 2011.</td> </tr> </table>	CL 500 / 63 AMG (C 216) 2010-2013. S 500 / 63 AMG (C 217) 2014. CLS 300 (C 218) 2012. E 300 / 350 / 400 (C/A 207) 2011. CLS 350 / 400 / 500 / 63 AMG (C/X 218) 2011-2014. SLK 350 (R 172) 2011. SL 350 / 400 / 500 / 63 AMG (R 231) 2012. S 500 PLUG-IN HYBRID (V 222) 2014. ML 300 / 350 / 500 / 63 AMG (W 166) 2011.	C 400 (W 205) 2014. E 400 HYBRID (W 212) 2012. G 63 AMG (W 463) 2012. E 300 / 350 / 400 / 500 / 63 AMG (W/S 212) 2011. C 350 (W/S/C 204) 2011. S 350 / 500 / 63 AMG (W/V 221) 2010. S 400 / 63 AMG (W/V 222) 2013. R 350 BlueEFFICIENCY (W/V 251) 2012. GL 450 / 500 (X 166) 2012. GLK 350 (X 204) 2011.
CL 500 / 63 AMG (C 216) 2010-2013. S 500 / 63 AMG (C 217) 2014. CLS 300 (C 218) 2012. E 300 / 350 / 400 (C/A 207) 2011. CLS 350 / 400 / 500 / 63 AMG (C/X 218) 2011-2014. SLK 350 (R 172) 2011. SL 350 / 400 / 500 / 63 AMG (R 231) 2012. S 500 PLUG-IN HYBRID (V 222) 2014. ML 300 / 350 / 500 / 63 AMG (W 166) 2011.	C 400 (W 205) 2014. E 400 HYBRID (W 212) 2012. G 63 AMG (W 463) 2012. E 300 / 350 / 400 / 500 / 63 AMG (W/S 212) 2011. C 350 (W/S/C 204) 2011. S 350 / 500 / 63 AMG (W/V 221) 2010. S 400 / 63 AMG (W/V 222) 2013. R 350 BlueEFFICIENCY (W/V 251) 2012. GL 450 / 500 (X 166) 2012. GLK 350 (X 204) 2011.		



54318

105,00€

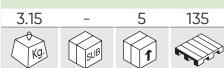

RIVETTATRICE PER CATENE DI DISTRIBUZIONE

MODELLO	CHRYSLER JEEP MERCEDES
UTENSILI OEM	112 589 026 300 (1) 103 589 016 300 (2) 602 589 026 300 (3) 602589023300 (4) 602589003900 (5) 602589046301 (6)
CODICE MOTORE	CHRYSLER/JEEP: 2.2D, 2.7D, 3.0D CRD (DIESEL). MERCEDES: 1.7D, 2.1D, 2.2D, 2.7D, 3.0D, 3.2D, 3.9D, 4.0D CDI (DIESEL)

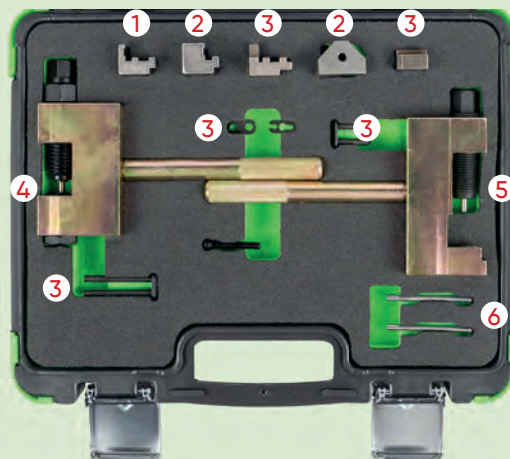

54414

97,50€



N

KIT DI MESSA IN FASE PER MERCEDES M651

MODELLO	A CLASS (2012-2018), B CLASS (2012-2019), C CLASS (2009-2015), C CLASS (2014-2018), CLA COUPE (2013-2019), CLS (2011-2018), E CLASS (2009-2016), GLA (2014-2020), GLC (2015-2019), GLE (2015-2019), GLK (2008-2015), M CLASS (2011-2015), S CLASS (2010-2013), S CLASS (2013-2017), SLC (2016-2017), SLK (2012-2016), SPRINTER (2009-2018), SPRINTER (2018-), V CLASS (2014-), VIANO (2010-2015), VITO (2010-2015), VITO (2014-) MERCEDES-BENZ
UTENSILI OEM	608 31 800 (1) 608 31 830 (2) 608 31 810 (3) 608 31 820 (4) 651 589 00 40 00 (5)
CODICE MOTORE	1.8: 651.901 2.1: 651.900, 651.910, 651.911, 651.912, 651.913, 651.916, 651.921, 651.922, 651.924, 651.930, 651.940, 651.950, 651.955, 651.956, 651.957, 651.958, 651.960, 651.961, 651.980 2.2: 651.925

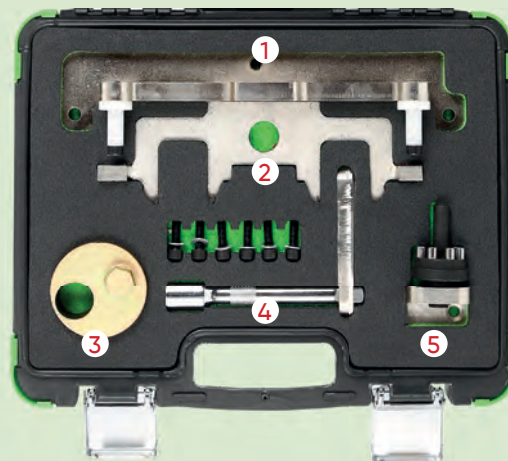

54415

60,00€

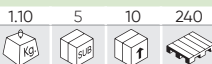

N

KIT DI MESSA IN FASE PER MERCEDES M651

MODELLO	GLA X156 200/220 CDI, GLK X 204 200/220/250 CDI, ML W166 250, SLK R172 250 CDI, SPRINTER W906 210/310/510/213/313 CDI, SPRINTER W906 513/216/316/416/516 CDI, V-CLASS W/V 639 2.0/2.2 CDI, VITO W/V 639 110/113/116 CDI MERCEDES-BENZ: A-CLASS W176 180/200/220 CDI, B-CLASS W246 200/220 CDI, C-CLASS W/S/C 204 180/200/220/250 CDI, CLA C117 200/220 CDI, CLD C/X 218 220/250, E-CLASS W/S 212 200/220/250 CDI E-CLASS C/A 207 220/250 CDI, E-CLASS W212 250/300 BLUETEC
UTENSILI OEM	651589004000 (1) 651589014000 (2)
CODICE MOTORE	1,8 651.901 2,1 651.900 651.910 651.911 651.912 651.913 651.916 651.921 651.922 651.924 651.925 651.930 651.940 651.950 651.955 651.956 651.957 651.958 651.960 651.961 651.980

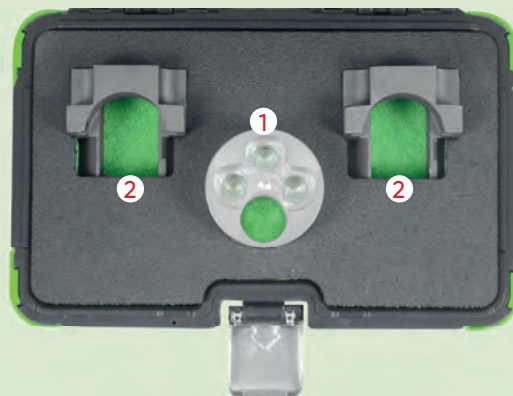

54416

31,00€



N

KIT DI MESSA IN FASE PER MERCEDES M642

MODELLO	G-CLASS (461/463) 2007-2015, GL-CLASS (164/166) 2006-2016, GLE/GLE COUPE (166/292) 2020 GLK (204) 2008-2015, GLS (166) 2016-2019, M-CLASS (164/166) 2005-2015, R-CLASS (251) 2005-2013, S-CLASS (221/222) 2005-2017, SPRINTER (906) 2006-2018, VIANO (639) 2005-2015, VITO (639) 2006-2015 MERCEDES-BENZ: C-CLASS (203/204) 2004-2014, CLK (209) 2005-2009, CLS (219/218) 2005-2018, E-CLASS (211/212/213) 2005-2018, E-CLASS COUPE/CABRIOLET (207) 2009-2017
UTENSILI OEM	642589003100 (1)
CODICE MOTORE	642.820 642.822 642.826 642.830 642.832 642.834 642.835 642.836 642.838 642.850 642.852 642.853 642.854 642.855 642.856 642.858 642.861 642.862 642.867 642.868 642.870 642.872 642.884 642.886 642.890 642.896 642.910 642.920 642.921 642.922 642.930 642.932 642.940 642.950 642.960 642.961 642.970 642.975 642.990 642.992 642.993

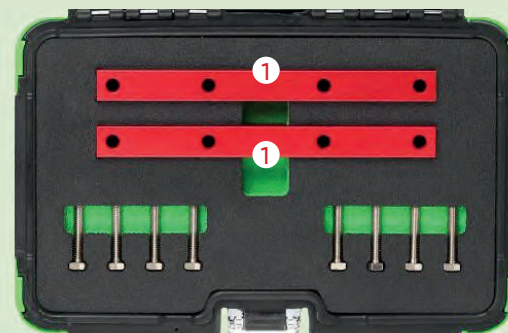

54417

153,00€



N

KIT DI MESSA IN FASE PER MERCEDES M133, M270, M274

MODELLO	MERCEDES.BENZ A -CLASS (W176) (2012), MODEL A180/A200 MERCEDES.BENZ B CLASS (W246) AS OF 2011, MODEL B180/ B200
UTENSILI OEM	270589006100 (1)
CODICE MOTORE	M133 M270 M274

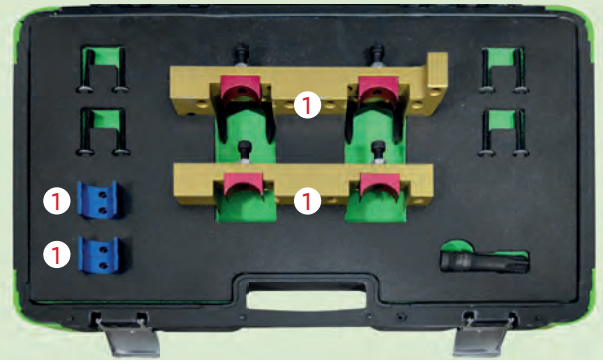

54418

37,00€



N

KIT DI MESSA IN FASE PER MERCEDES M112, M113

MODELLO	C-CLASS (202) 2.4/2.6/2.8/3.2/4.3 - 1998-00, CLK (208) 3.2/4.3/5.4 - 1997-03, E-CLASS (210) 2.4/3
UTENSILI OEM	112589003200 (1) 112589013200 (2) 112589000100 (3)
CODICE MOTORE	MERCEDES.BENZ: M112, M113

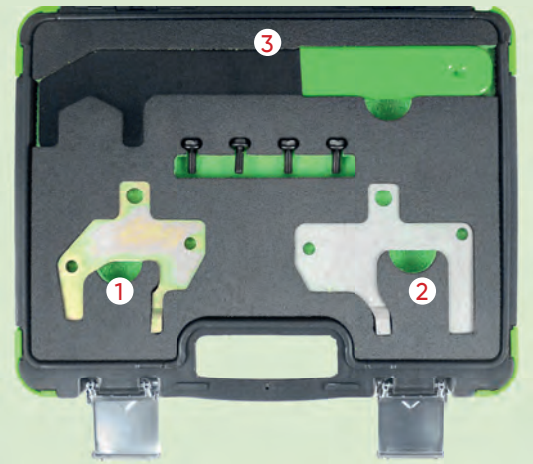

51488

16,00€

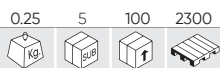

DISPOSITIVO BLOCCAGGIO ALBERO MOTORE / ALBERO PER RENAULT/NISSAN/DACIA/SUZUKI

MODELLO	RENAULT: CAPTUR, CLIO II.III.IV, ESPACE/GRAND ESPACE III.IV, FLUENCE, KADJAR, KANGOO, LAGUNA I,II,III, LOGAN/ LOGAN MCV, MEGANE I,II,III,IV, MODUS/GRAND MODUS, SCENIC/ GRAND SCENIC I,II,III,IV, TWING II, TRAFIC II, MASTER II 1.5DCI & 1.9 DCI. DACIA: DOKKER, DUSTER, LODGY, LOGAN, SANDERO 1.5DCI NISSAN: ALMERA, CUBE, JUKE, KUBISTAR, MICRA, NOTE, NV200/EVALIA, PRIMERA, TIIDA, INTERSTAR, PRIMASTAR 1.5DCI & 1.9 DCI SUZUKI: GRAND VITARA, JIMNY 1.5DDIS & 1.9DDIS
UTENSILI OEM	MOT1489, MOT1430, MOT1054.
CODICE MOTORE	K9K, F8Q, F9Q - benzina, Clío, R19, Laguna 1.8/2.0 F3R F3P



53289

45,00€

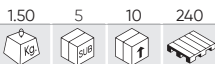

KIT DI ATTREZZI DI REGOLAZIONE CINGHIA DENTATA PER RENAULT 1.4, 1.6, 1.8, 2.0 16V

MODELLO	<p>RENAULT: ESPACE/GRAND ESPACE (98-02), ESPACE/GRAND ESPACE IV (02-10), KANGOO/TREKKA (01-09), LAGUNA (98-01), LAGUNA II (01-07), LAGUNA III (07-13), MEGANE (99-03), MEGANE II (02-10), MEGANE III/SPORT (08-13), MEGANE/SCENIC (99-00), SCENIC/RX4 (99-03), SCENIC/GRAND SCENIC II (03-09), TRAFIC II (01-11), TWINGO II (08-14), VEL SATIS (00-10), WIND (10-14)</p> <p>DACIA: LOGAN/MCV (05-11).</p> <p>NISSAN: KUBISTAR X76 (03-09), PRIMASTAR (02-11).</p> <p>VAUXHALL/OPEL: JETTA, TOURAN, GOLF, GOLF PLUS, POLO, PASSAT, TIUAN, SCIROCCO.</p>
UTENSILI OEM	MOT1489 (1), MOT1054 (2), MOT1496 (3)
CODICE MOTORE	<p>1.4 16V K4J: 730, 732, 740.</p> <p>1.6 16V K4M: 752, 753, 760, 761, 764, 788, 812, 813, 854, 856.</p> <p>1.8 16V F4P: 720, 722, 760, 770, 771, 772, 773, 774, 775.</p> <p>2.0 16V F4R: 700, 701, 712, 713, 714, 715, 720, 722, 730, 732, 736, 738, 740, 741, 744, 746, 747, 762, 763, 764, 765, 766, 767, 770, 771, 780, 790, 791, 792, 820, 830, 832, 867.</p> <p>2.0 16V F4R(11): 720, 722, 764, 765, 774, 776, 784, 786, 787, 794, 795, 796, 797, 800, 802, 810, 811, 870, 872, 874, 886, 887, 896, 897.</p>

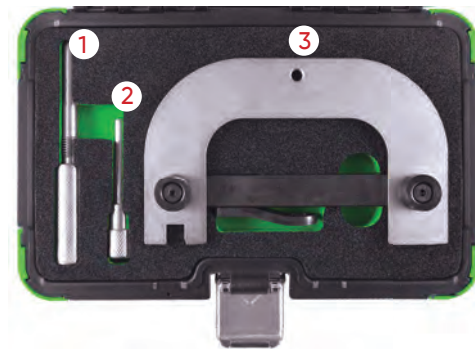

53290

51,00€

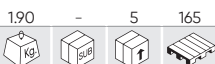

KIT DI ATTREZZI DI REGOLAZIONE CINGHIA DENTATA PER RENAULT/VOLVO 16V, 20V

MODELLO	<p>RENAULT: LAGUNA 2.0 16V / 2.5 20V (1996-1999), SAFRANE 2.0 16V / 2.5 20V (1996-2001)</p> <p>VOLVO: 850 (1992-1997), C70 (1998-2002), S40 (1996-2004), V40 (1996-2004), S60 (2001-2005), S70 (1997-2000), S80 (1999-2005).</p>
UTENSILI OEM	MOT1348 (1), MOT1337 (2), MOT1340 (3)
CODICE MOTORE	<p>RENAULT: N7Q 704/710/711(2.0 16V), N7U 700/701(2.5 20V).</p> <p>VOLVO: B4164S, B4164S2, B4184S, B4184S2, B4184S3, B4184S9, B4184S10, B4194T, BS194T2, B420S4, B4204S2, B4204T, B4204T2, B4204T3, B4204T5, B5202FS, B5204FT, B5204T2, B5204T3, B5204T4, B5204T5, B5234FS, B5204FT, B5234T3, B5234T4, B5234T5, B5234T6, B5234T7, B5234T8, B5234T9, B5244S, B5244S2, B5244SG, B5244SG2, B5244T, B5244T3, B5244T4, B5244T5, B5244T7.</p>

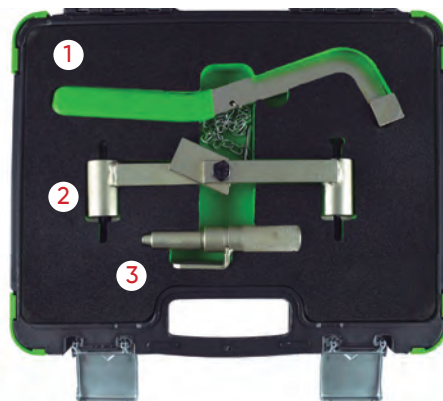

53291

68,00€



KIT DI ATTREZZI DI REGOLAZIONE CINGHIA DENTATA PER RENAULT

MODELLO	RENAULT: CLIO, LAGUNA, MEGANE
UTENSILI OEM	MOT1496 (1), MOT1489 (2), MOT861/1863 (3), MOT1490(4)
CODICE MOTORE	K4J, K4M, F4P, F4R.

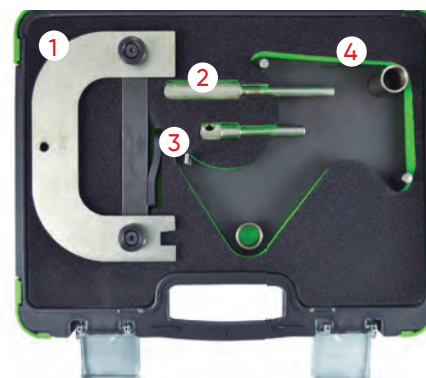

53292

116,00€



KIT DI ATTREZZI DI REGOLAZIONE CINGHIA DENTATA PER RENAULT/OPEL 2.2, 2.5 TDI DCI

MODELLO	RENAULT: LAGUNA II, ESPACE, MASTER, TRAFIC, 2.2 / 2.5 DCI OPEL: VIVARO, MOVANO, DIESEL: 2.2 / 2.5 DTI, ASTRA B, VECTRA B, SIGNUM, ZAFIRA, 2.2 16V
UTENSILI OEM	KM6205 (1), KM6204 (2), KM6077 (3)
CODICE MOTORE	2.2 / 2.5

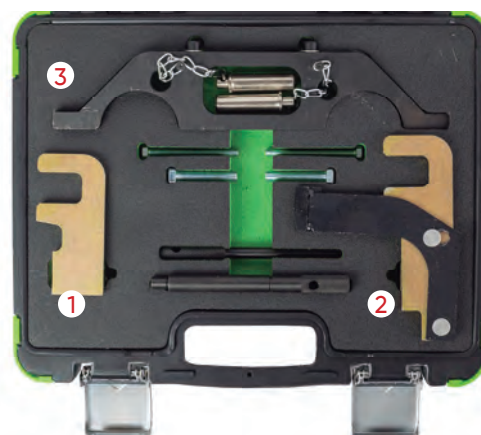

5311

97,00€



KIT DI MESSA IN FASE RENAULT/NISSAN/OPEL/VAUXHALL 2.0, 2.3 DCI, CDTI, M9R, M9T

MODELLO	NISSAN: PRIMASTAR X83 (06-15), QASHQAI/QASHQAI+2 J10 (07-14), X-TRAIL T31 (07-14). VAUXHALL/OPEL: MOVANO-B (10-17), VIVARO (06-15). RENAULT: ESPACE/GRAND ESPACE IV (06-10), KOLEOS (08-15), LAGUNA LL (05-07), LAGUNA LLL (07-14), MASTER LLL (10-15), MEGANE LL (06-10), SCENIC/GRAND SCENIC LL (06-09), SCENIC/GRAND SCENIC LLL (09-15), TRAFIC LL (06-14), VEL SATIS (05-10)
UTENSILI OEM	MOT1769 (1), EN-48334 (2), MOT1766 (3), EN-48330 (3), KM-6130 (4), EN-48332 (5), MOT1773 (6), EN-48831 (6)
CODICE MOTORE	2.0D DCI M9R: 630, 780, 782, 784, 786, 788, 830, 832, 833, 834, 835, 836, 838, 855, 856. 2.0D CDTI M9R: 630, 780, 782, 784, 786. 2.3 BI-CDTI: LP6/M9T706, LW7/M9T706. 2.3D DCI M9T: 670, 672, 676, 678, 680, 686, 690, 692, 694, 698.



53523

91,00€



KIT DI BLOCCAGGIO PER MOTORI DIESEL RENAULT/NISSAN/OPEL 1.6 DCI

MODELLO	RENAULT: ESPACE/GRAND ESPACE IV (06-10), KALEOS (08-11), LAGUNA LL (05-07), LAGUNA LLL (07-12), MASTER LLL (10-12), MAGANE LL (06-10), SCENIC/GRAND SCENIC LL (06-09), SCENIC/GRAND SCENIC LLL (09-12), TRAFIC LL (06-12), VEL SATIS (05-10) NISSAN: PRIMASTAR X83 (06-10), QASHQAI/QASHQAI+2 J10 (07-10), X-TRAIL T31 (07-12). VAUXHALL / OPEL: MOVANO-B (10-12), VIVARO (06-12).
UTENSILI OEM	MOT1969 (1), MOT1970 (2), MOT1770, MOT1773, EN-48330, EN-48332, EN-48334, EN-48831, KM-6130
CODICE MOTORE	M9R 2.0DCI: 610, 615, 630, 700, 721, 740, 742, 760, 761, 762, 763, 780, 782, 784, 786, 788, 800, 802, 803, 805, 808, 816, 830, 832, 833. M9T 2.3DCI: 670, 672, 676, 678, 680, 686, 690, 692, 694, 698.



54210

84,00€

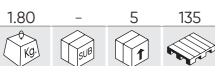

KIT DI ATTREZZI DI BLOCCAGGIO DELLA RUOTA DENTATA DELL'ALBERO A CAMME PER FORD RENAULT 1.8, 2.0 16V

MODELLO	RENAULT LAGUNA II (2001 - 2009), MEGANE II (2002 - 2009), Scenic (2002 - 2009)
UTENSILI OEM	MOT 1509-01 (1), 1509 (2)
CODICE MOTORE	700, 701, 712, 713, 714, 715, 720, 721, 722, 722, 730, 732, 736, 738, 740, 741, 744, 746, 747, 760, 761, 762, 763, 764, 765, 766, 767, 770, 771, 773, 774, 774, 775, 776, 784, 786, 787, 790, 792, 794, 797, 830, F4P, F4R



54225

133,00€

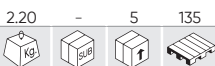

KIT DI BLOCCAGGIO DELLA PULEGGIA DELL'ALBERO MOTORE/DEL VOLANO PER RENAULT/NISSAN

MODELLO	NISSAN: PRIMASTAR (06-15), QASHQAI/QASHQAI+2 (07-14), X-TRAIL (07-14), NAVARA (15-16), NV400 (11-16) RENAULT: ESPACE V (15-16), CLIO (06-16), FLUENCE (09-15), LAGUNA (05-15), LATITUDE (10-15), MEGANE (06-15), SCENIC/ GRAND SCENIC (06-15), ESPACE/GRAND ESPACE IV (02-15), KOLEOS (08-16), TRAFIC II (07-15), VEL SATIS (00-10), MASTER III (10-16)
UTENSILI OEM	MOT 1431(1), MOT 1716(2), MOT 2019(2), MOT 1789(3), MOT 919-02(4)
CODICE MOTORE	1.4:H4 JT700 1.6:M5M400, M5M450 2.0:M4R700, M4R701, M4R704, M4R711, M4R713, M4R714, 2.0D:M9R726, M9R730, M9R735, M4R737, M9R740, M4R746, M9R742, M9R744, M9R746, M9R748, M4R750, M4R751, M4R752, M4R753, M4R754, M9R610, M9R613, M95615, M9R630, M9R750, M9R760, M9R761, M9R762, M9R762, M9R763, M9R700, M9R721, M9R722, M9R724, M9R756, M9R780, M9R782, M9R800, M9R802, M9R803, M9R804, M9R805, M9R806, M9R808, M9R809, M9R811, M9R812, M9R814, M9R815, M9R816, M9R817, M9R820, M9R824, M9R828, M9R830, M9R832, M9R833, M9R834, M9R835, M9R836, M9R838, M9R839, M9R844, M9R845, M9R846, M9R849, M9R854, M9R855, M9R856, M9R857, M9R858, M9R859, M9R865, M9R866, M9R784, M9R786, M9R788 2.3D:M9T670, M9T672, M9T676, M9T678, M9T680, M9T686, M9T690, M9T692, M9T694, M9T696, M9T698, M9T700, M9T702, M9T706, M9T708, M9T870, M9T880, M9T890, M9T896, M9T898, M9T899, YS23DDT, YS23DDTT 2.5:2TR700, 2TR702, 2TR703, 2TR704, 2TR705, 2ZV604, V4U604, VQ25 3.5:V4Y701, V4Y711, V4Y713, V4Y715



IL TUO KIT DI MESSA IN FASE ANCORA PIÙ VICINO

INSERISCI NELLA PAGINA WEB IL CODICE DEGLI ATTREZZI OEM O IL CODICE DEL MOTORE DELLA TUA AUTO E TROVA IL KIT COMPATIBILE

54289

38,00€



N

KIT BLOCCAGGIO VOLANO MOTORE PER MERCEDES/RENAULT/DACIA/NISSAN

MODELLO	DACIA DOKER 2015 + DACIA DUSTER 2015+ DACIA LODGY 2015+ DACIA LOGAN 2013/-2020 DACIA SANDERO 2013+ MERCEDES-BENZ A-CLASS 2018+ MERCEDES-BENZ B-CLASS 2019+ MERCEDES-BENZ CLA 2019+ MERCEDES-BENZ GLA 2019+ MERCEDES-BENZ GLB 2019+ RENAULT ARKANA 2019+ RENAULT CAPTUR 2018+ RENAULT CLIO V 2019 + RENAULT KADJAR 2018+ RENAULT MEGANE IV 2017+ RENAULT SCENIC/GRAND SCENIC IV 2018+ RENAULT TALISMAN 2018+
UTENSILI OEM	MOT.2188 (1)
CODICE MOTORE	HR13DDT, H4Bt 400, H4Bt 408, H4Bt 410, H4Bt 411, H4M 730, H4M 738, H4M 740, H5H 450, H5H 470, H5H 480, 282.914

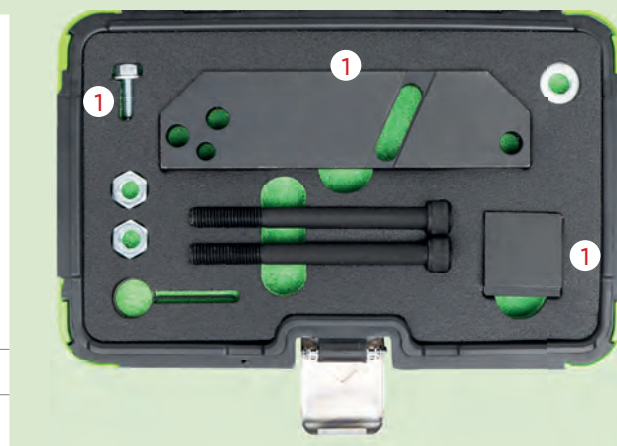

54438

40,00€



N

KIT DI MESSA IN FASE PER RENAULT/NISSAN 3.0DCI

MODELLO	NISSAN: NAVARA PICK UP, PATHFINDER, INFITI RENAULT: LAGUNA, LATITUDE
UTENSILI OEM	MOT 1880 (1) MOT 1970 (2) MOT 1874 (3)
CODICE MOTORE	V9X, V9X 791, 891

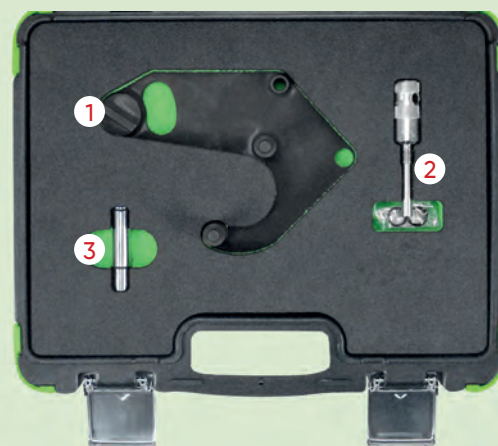

54439

32,50€

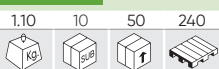

N

BLOCCAGGIO PULEGGIA ALBERO MOTORE RENAULT/DACIA 0.9, 1.0, 1.2, 1.6 TCE

MODELLO	DACIA DOKKER 2012 - 2019, PLUMERO 2013 - 2018, LOGIA 2012 - 2018 RENAULT CAPTURAR 2013 - 2019, CLIO IV 2012 - 2019, KADJAR 2015 - 2018, KANGOO II 2013 - EN, MEGANE III 2012 - 2017, MEGANE IV 2016 - 2020, ESCENICO/GRAN ESCENICO III 2012 - 2017, ESCENICO/GRAN ESCENICO IV 2016 - 2018, TWIN-GO III 2014 - EN
UTENSILI OEM	MOT. 2006 (1) MOT. 2054 (1) 281589004000 (1)
CODICE MOTORE	0.9TCE: H4B 453, H4Bt 400, 401, 408, 410, 411, 451. 1.0TCE: H4D, H4D 400, 450, 460, 470 1.2TCE: H5Ft 400, 403, 404, 405, 408, 410, 412. 1.6TCE: H4M 429, 438, 440, 729, 730, 738, 740, 748, 749

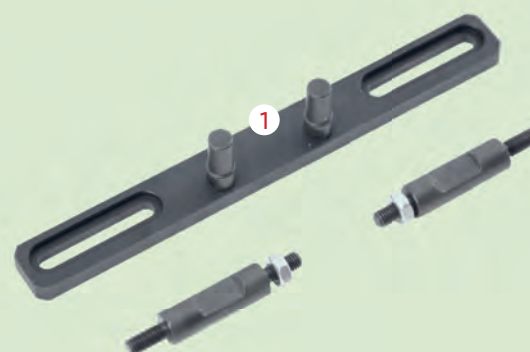

53299

291,00€



KIT DI ATTREZZI DI REGOLAZIONE CINGHIA DENTATA PER OPEL/VAUXHALL

MODELLO	OPEL / VAUXHALL
UTENSILI OEM	EN-46788 (1), KM927 (2), EN-46789 (3), KM929 (4), EN-46785 (5), EN-46788 (6), 1 860 985 000 (7), KM932 (8), KM933 (9), EN-49978 (10), KM933 (11)
CODICE MOTORE	1.3 CDTI 16V, 1.9 CDTI, 2.0 DTI, 2.2 DTI.

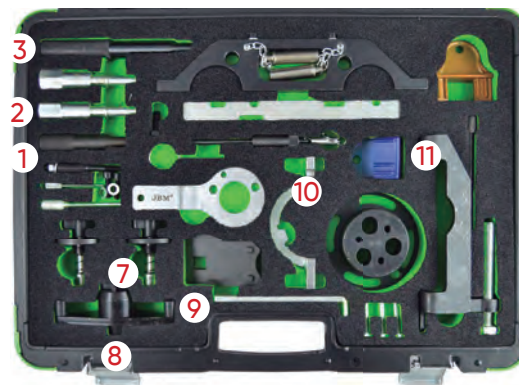

53300

41,00€



KIT DI ATTREZZI DI REGOLAZIONE CINGHIA DENTATA PER OPEL/VAUXHALL/CHEVROLET 2,0CDI

MODELLO	OPEL VAUXHALL CHEVROLET
UTENSILI OEM	EN-48245 (1), EN-48246 (2), 205083060 (3) (4) (5) (6)
CODICE MOTORE	OPEL / VAUXHALL: Z20DM, Z20DMH CHEVROLET: LLWZ20DMH, RA 420 , Z20SI, Z 20S3, Z 20S4, Z 20S5



53301

44,00€



KIT DI ATTREZZI DI REGOLAZIONE CINGHIA DENTATA PER SUZUKI/OPEL 1.0, 1.2, 1.4

MODELLO	SUZUKI: WAGON R (05-08). VAUXHALL / OPEL: AGILA (00-08), ASTRA-G (98-06), ASTRA G CLASSIC II (03-10), ASTRA-H (04-11), COMBO (04-12), CORSA-B (97-00), CORSA-C (00-07), CORSA-D (06-12), MERIVA-A (04-10), TIGRA-B (04-10).
UTENSILI OEM	KM-953/09919-58310 (1), KM-952/09912-38310 (2), KM-954/09919-08310 (3), KM-6130 (4), KM-955/09919-58320 (5)
CODICE MOTORE	1.0 12V: X10XE, Z10XE, Z10XEP. 1.2 16V: X12XE, Z12XE, Z12XEP. 1.4 16V/ECOFLEX: Z14XEL, Z14XEP.

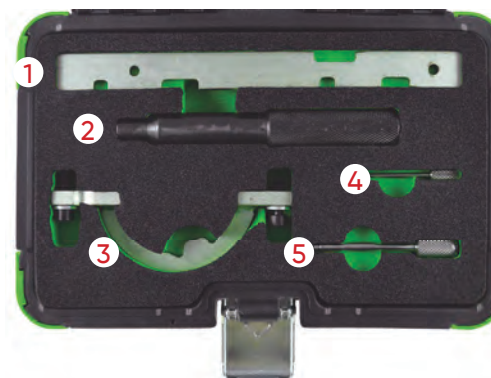

53302

44,00€

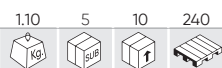

KIT DI ATTREZZI DI REGOLAZIONE CINGHIA DENTATA PER FIAT/ALFA ROMEO/VAUXHALL/OPEL/SAAB JTD

MODELLO	SAAB: 9-3 (04-08), 9-5 (05-08). VAUXHALL / OPEL: ASTRA-H, VECTRA-C, SIGNUM (04-07), ZAFIRA-B (05-07).
UTENSILI OEM	EN46789/32 025 008 (1) (3), EN46788/32 025 009 (2), KM6349 (4)
CODICE MOTORE	Z19DT, Z19DTH, Z19DTL.



53305

136,00€

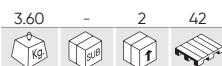

KIT DI ATTREZZI DI REGOLAZIONE CINGHIA DENTATA PER SAAB/OPEL/VAUXHALL

MODELLO	VAUXHALL / OPEL: ANTARA (06-10), CALIBRA (93-98), CAVALIER/VECTRA-A (93-95), OMEGA-B (94-03), SIGNUM (03-05), SINTRA (96-99), VECTRA-B (95-02), VECTRA-C (02-05). SAAB: 900 (93-98), 9000 (95-97), 9-5 (98-03)
UTENSILI OEM	KM-800-1 (1), KM-800-2 (2), KM-800-20 (3), KM-800-10 (4), 83 95 006 (5), KM-800-30 (6), MKM-6038, 83 95 006 (7)
CODICE MOTORE	2.5 V6: SAAB: B2581, VAUXHALL/OPEL: C25XE, X25XE. 2.6 V6: VAUXHALL/OPEL: Y26SE. 3.0 V6: SAAB: B308E, B308I, VAUXHALL / OPEL: X30XE. 3.2 V6: VAUXHALL/OPEL: Y32SE, .



53307

38,50€



KIT DI ATTREZZI DI REGOLAZIONE CINGHIA DENTATA PER ALFA/OPEL/VAUXHALL 1.6, 1.8 16V

MODELLO	OPEL / VAUXHALL: CORSA-D, AGILA, ASTRA-G-H, MERIVA, ZAFIRA-B, VECTRA-C, SIGNUM, INSIGNA	1.6, 1.8
	CHEVROLET: AVEO, CRUZE, ORLANDO	1.4, 1.6, 1.8
	ALFA ROMEO: 159 FIAT: CROMA	1.8
UTENSILI OEM	E10290 (1), 23056-06 (2) (3), E10230 (4), 23164-04 (5), 23174-01 (6), 23056-05 (7)	
CODICE MOTORE	OPEL / VAUXHALL: Z16LEL, Z16LER, Z16LET, Z16XE1, Z16XEP, Z16XER, A16XER, 18XER, A18XER, 2HO/A18XEL. CHEVROLET: G14D, LDD, LXV (F16D4), 2HO(Z18XER). ALFA / FIAT: 939A4.000.	



53316

34,00€

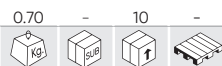

ATTREZZO DI REGOLAZIONE CINGHIA DENTATA PER FIAT/OPEL/VAUXHALL 2.2 16V CADENA

MODELLO	OPEL: ASTRA-G (2000-2006), ASTRA-H (2006-2011), SIGNUM (2003-2008), VECTRA-B (2000-2002, VECTRA-C (2002-2008), ZAFIRA-A (2000-2005), ZAFIRA-B (2005-2012), SPEEDSTER (2000-2006). VAUXHALL: VX220 (2000-2006). FIAT: CROMA (2005-2009).
UTENSILI OEM	VAUXHALL / OPEL: Z22SE, Z22YH FIAT: 194A1.000.



53317

34,00€

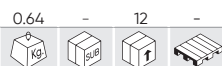

OPEL/VAUXHALL 2.2 BLOCCO POMPA ANTIGELO

MODELLO	OPEL 2.2 Catena VAUXHALL 2.2 Catena
---------	--



53452

26,50€



KIT DI ATTREZZI DI REGOLAZIONE CINGHIA DENTATA PER OPEL/FORD/FIAT/ ALFA ROMEO/ LANCIA/SUZUKI

MODELLO	VAUXHALL/OPEL 1.3 CDTI: AGILA, CORSA, COMBO (03-08), ASTRA-H(05-08), MERIVA, TIGRA-B(04-08) SUZUKI 1.3 DDIS: IGNIS, WAGON R(03-08), SWIFT(04-08) FORD: 1.3 TDCI FIAT/ALFA ROMEO/LANCIA: 1.3 JTD MULTIJET
UTENSILI OEM	104-A EN 46781 (1) , EN 46785 (2)

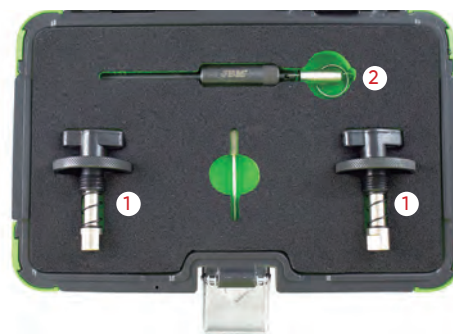

53651

91,00€



KIT DI ATTREZZI DI REGOLAZIONE CINGHIA DENTATA PER OPEL/VAUXHALL 1.0, 1.2, 1.4 TURBO

MODELLO	OPEL: ADAM, AMPERA, ASTRA-J, AVEO, CORSA-D, INSIGNIA, MERIVA-B, MOKKA, ZAFIRA-C TOURER
UTENSILI OEM	EN 49977-100 (1), EN 49977-200 (2), EN 49978 (3), KM 952 (4), KM 953-A (5), KM 955-1 (6), KM 955-2 (7).
CODICE MOTORE	1.0: A10XEP (LDB) 1.2: A12XEL (LWD), A12XER (LDC) 1.4: A14XEL (L2Z), A14XER (LDD), LDU A14NEL (LUH), A14NET (LUJ), TWINPORT / ECOFLEX ENGINES A14XFL (LUU), A14NEL (LDD), A14NEL (LUJ), A12XEL (L2Q)



54205

49,00€

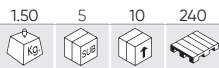

KIT DI ATTREZZI DI CRONOMETRAGGIO DEL MOTORE PER VAUXHALL/OPEL 1.6 CDTI

MODELLO	VAUXHALL/OPEL: Astra J (13-18), Astra K, (15-19), GTC (15-18), Insignia A (15-17), Insignia- B (17-20), Meriva B (13-17), Mokka (14-16), Mokka X (16-20), Zafira C Tourer (13-19).
UTENSILI OEM	EN-6349, EN-6130 (1), EN-51143 (2), EN-51140 (3), EN-50513 (4), EN-51188 (5)
CODICE MOTORE	B16DTC, B16DTE, B16DTH, B16DTJ, B16DTL, B16DTN, B16DTR and B16DTU. D16DTH, D16DTI, D16DTJ, D16DTN, D16DTR, D16DTU

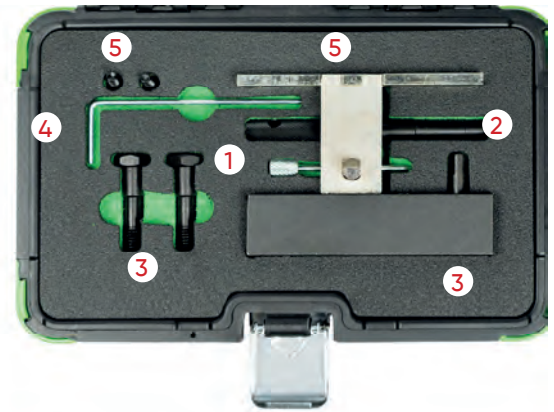

54214

96,00€



KIT DI ATTREZZI DI CRONOMETRAGGIO DEL MOTORE PER OPEL/ISUZU 1.6D, 1.7D

MODELLO	ASTRA, CAVALIES, VECTRA-A(87-00), ISUZU, NOVA, CORSA / COMBO, STRA, CAVALIER, VECTRA, FRONTERA, MONTEREY, MIDI, BRAVA (88-04)
UTENSILI OEM	VAS 6079 (1), KM 951 (2), KM 851 (3), 23-029 (4), KM 661-2 (5), KM 661 (6)
CODICE MOTORE	OPEL : 16DA, 17D, 17DR, X17DTL ISUZU : 4EC1, 4EE1, 4JB1, 4XJ1, 4JA1, 4JG1, 4FC1, 4FD1, 4FG1, Z17DT, Y17DT/DTL

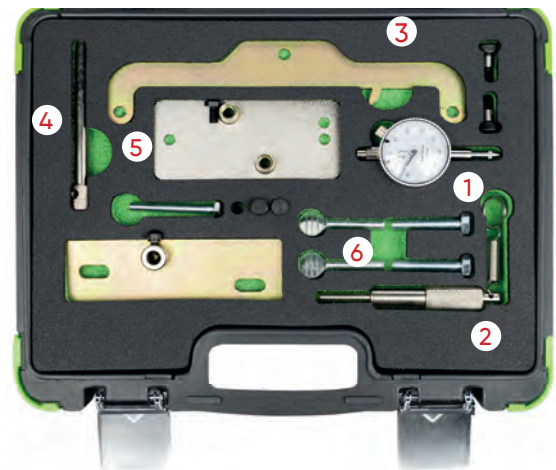

54217

104,00€

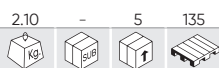

KIT DI ATTREZZI DI CRONOMETRAGGIO DEL MOTORE PER VAUXHALL/OPEL/SAAB 2.0, 2.2 DTI

MODELLO	VAUXHALL/OPEL: ASTRA-G (98-06), FRONTERA-B (98-04), OMEGA-B, (98-03), SIGNUM (03-05), SINTRA (98-99), VECTRA-B (97-02), VECTRA-C (02-05), ZAFIRA-A (99-05), SAAB: 9-3 (98-04), 9-5 (02-06)
UTENSILI OEM	SAAB: 83 95 394 (1), 83 95 337 (2), 83 95 352 (3), 83 95 386 (4) VAUXHALL/OPEL/SAAB: KM-927 (2), KM-929 (3), KM-932 (4), KM-933 (1)
CODICE MOTORE	OPEL: X20DTH, X20DTL, Y20DTH, Y20DTL, X22DYH, Y22DTH, Y22DTR SAAB: D223L



54221

111,00€



KIT DI ATTREZZI CRONOMETRAGGIO DEL MOTORE PER VAUXHALL/OPEL 1.3 CDTI

MODELLO	VAUXHALL/ OPEL 1.3 CDTI Corsa E Diesel Engine From 2015
UTENSILI OEM	KM-662-C (1), EN-50515 (2), EN-51500 (3), EN-46775 (4), KM-955-1 (5), EN-46785 (6)
CODICE MOTORE	LKU B13DTE, LKU B13DTR



54434

48,50€



KIT DI MESSA IN FASE PER OPEL 1.0, 1.4

MODELLO	VAUXHALL/OPEL ADAM 2014 - 2019, ASTRA-K 2015 - 2019, CORSA-E 2015 - 2019, INSIGNIA-B 2017 - 2020, MOKKA X 2016 - 2019, VIVA (KARL) 2015 - 2020
UTENSILI OEM	EN-51367 (1) EN-51298 (2) EN-51632 (3)
CODICE MOTORE	1.0 L5Q/B10XE, L5Q/D10XE, LE1/B10XFL, LE1/B10XFT, LE1/B10XFL, LE1/D10XFL, LE1/D10XFT, LE1/F10XFL, LE1/F10XFT, LWT/B10XL 1.4 LE2/B14XFL, LE2/B14XFT, LE2/D14XFL, LE2/D14XFT, LFE/B14XNT, LFE/D14XNT, LV7/B14XE 1.5 LFV/B15XHT, LFV/D15XHL, LFV/D15XHT

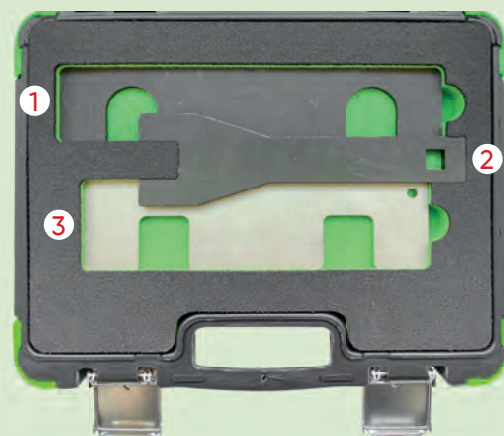

54435

14,50€



KIT DI MESSA IN FASE PER OPEL/CHEVROLET/SAAB 1.4, 1.6, 1.8 ECOTEC

MODELLO	CHEVROLET: LACETTI (2005-2010), NUBIRA (2005-2010) OPEL/VAUXHALL: ASTRA-G (1998-2004), ASTRA-H (2004-2007), COMBO-C (2005-2012), CORSA-C (2000-2007), MERIVA-A (2003-2010), SIGNUM (2003-2007), TIGRA-B (2004-2010) VECTRA-B (1995-2002), VECTRA-C (2002-2008), ZAFIRA-A (1999-2005), ZAFIRA-B (2006-2013) SAAB: 9-3 (2003-2010)
UTENSILI OEM	KM-911 (1) KM-6130 (2) KM-852 (3), EN-852 (3)
CODICE MOTORE	1.4: X14XE, Z14XE 1.6: X16SEJ, X16XEL, Y16XE, Z16XE, Z16YNG 1.8: F18D3 1.8: X18XE1, Z18XE, Z18XEL, X18E1 1.8: Z18XE

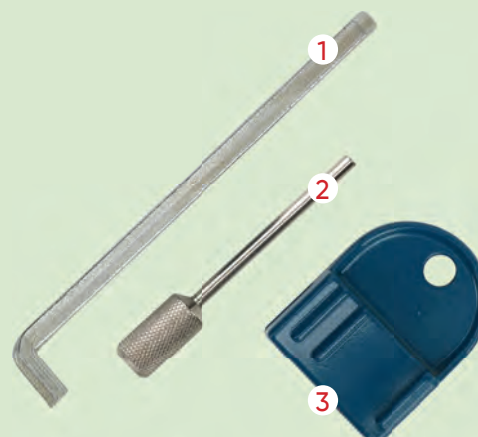

54436

124,00€



N

KIT DI MESSA IN FASE PER OPEL 1.6 SIDI

MODELLO	VAUXHALL ASTRA-J 2013 - 2017,ASTRA-K 2015 - 2019,CASCADA 2013 - 2019,GTC 2015 - 2019,INSIGNIA 2013 - 2017,INSIGNIA-B 2018 - 2020,ZAFIRA-C TOURER 2014 - 2019
UTENSILI OEM	EN 51153 (1) EN 50513 (2) EN 51148 (3) EN 51147 (4)
CODICE MOTORE	1,6 LWC/A16SHT LVP/A16XHT LWC/B16SHL LWC/B16SHT LVP/B16XHT LWC/D16SHJ LWC/D16SHL LWC/D16SHT

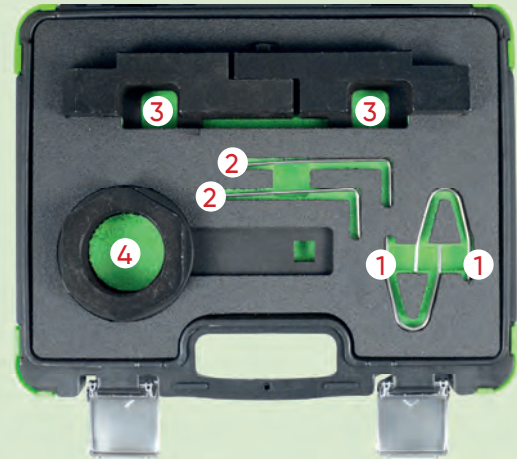

54437

110,00€

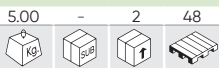

N

KIT DI MESSA IN FASE PER OPEL/CHEVROLET/SAAB 2.0, 2.4

MODELLO	CHEVROLET CAPTIVA 2011 - 2015,HHR 2008 - 2009, MALIBU 2012 - 2015 SAAB 9-3 (02-12) 2010 - 2012,9-5 (10-12) 2010 - 2012 VAUXHALL/OPEL ANTARA 2011 - 2016,ASTRA-J 2012 - 2017,GTC (15-19) 2015 - 2019,INSIGNIA-A (08-17) 2008 - 2013
UTENSILI OEM	EN-48585 (1) EN 43653 (2), J 43653 (2) EN 955 10 (3), KM 955 (3) EN-955-20 (4), KM 955-20 (4) EN 45027 1 (5), J 45027 1 (5) EN 45027 (6), EN45027 2 (6), J 45027 2 (6) EN 49212 (7), EN 49212 1 (7) EN 49212 (8), EN 49212 2 (8) EN 48953 (9)
CODICE MOTORE	LHU/A20NFT 2,0: LDK/A20NHT 2,0: LDK/A20NHT, LHU/A20NET, LHU/A20NFT, LHU/B20NFT 2,4: A24XE (LE5), A24XF (LE9) 2,4: LE5,LE9

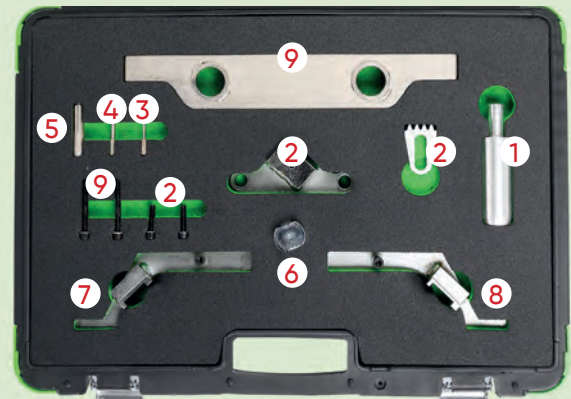

52271

18,00€

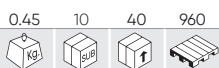

UTENSILI PER LA MESSA IN FASE DELLA DISTRIBUZIONE VAG

MODELLO	AUDI: A2 1.4TDI (02-06), A3 1.9, 2.0TDI (02-08), A4 1.6TDI (02-05), A4 1.9, 2.0TDI (04-08), A6 1.9TDI (02-05). SEAT: ALTEA 1.9SDI/TDI (05-08), LEON 1.9,2.0TDI (05-08), TOLEDO 1.9SDI/TDI (05-08). SKODA: FABIA 1.4TDI (03-06), OCTAVIA II 2.0TDI (03-06) VW :BEETLE 1.9TDI (02-08), BORA 1.9TDI (02-08), FOX 1.4TDI (02-08), GOLF 1.9, 2.0TDI (02-08), LUPO 1.4TDI (02-08), POLO 1.4, 1.9TDI (02-08), SHARAN 1.9TDI (02-08).
UTENSILI OEM	AUDI: AMF, ASZ, ATD, AVB, AVF, AWX, AXR, AZV, BHC, BKC, BKD, BKE, BLB, BMN, BNA, BPW, BRB, BR, BRD, BRE, BRF, BUY, BVA, BVF, BVG. SEAT: BJB, BKC, BLS, BMM, BXE SKODA: AMF, AZV, BKD VW: AJM, AMF, ANU, ARL, ASZ, ATD, AUJ, AVB, AVF, AWX, AXR, BAY, BMS, BNM, BNV, BWB



51489

12,00€

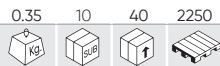

KIT DI BLOCCAGGIO DELL'ALBERO A CAMME VAG 1.4, 1.6

MODELLO	VW: LUPO 99 , POLO 95, CADDY 96, POLO CLASSIC, VARIANT 96, BEETLE 1.4L 99, GOLF 1.4L, 1.6L 98 Y 1.4L, BORA, 1.6L 99. AUDI: A2.
UTENSILI OEM	T10016
CODICE MOTORE	1.4 / 1.6 16V



53274

30,50€

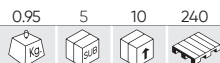

KIT DI ATTREZZI DI REGOLAZIONE CINGHIA DENTATA PER VOLKSWAGEN/SEAT/SKODA 1,2L

MODELLO	VOLKSWAGEN 1.2: LUPO / POLO / EOS / FOX. SEAT 1.2: IBIZA / CORDOBA SKODA 1.2: FABIA
UTENSILI OEM	T10123 (1) (2), T10120 (3), T10121 (4)
CODICE MOTORE	AWY / BMD / AZQ / BME.



53275

35,50€



KIT DI ATTREZZI DI REGOLAZIONE CINGHIA DENTATA PER VW-AUDI

MODELLO	DODGE: CALIBER (06-11) FORD: GALAXY (02-06) MITSUBISHI: GRANDIS (05-10), LANCER (05-10), OUTLANDER (07-10). SEAT: ALHAMBRA (00-15), ALTEA/ALTEA XL (04-15), CORDOBA (02-09), IBIZA (02-15), LEON (00-13), TOLEDO (04-11). SKODA: FABIA (00-14), FABIA II (07-15), OCTAVIA (00-10), OCTAVIA II (04-15), PRACTIK (10-15), RAPID (11-15), ROOMSTER (07-15), SUPERB (02-08), SUPERB II (08-15), YETI (09-14). AUDI: A1 (10-15), A2 (00-06), A3 (01-13), A4/ALLROAD (01-16), A5 (08-15), A6 (11-14), TT (08-14), Q3 (11-15), Q5 (08-15), A6 (10-14). VOLKSWAGEN: AMAROK (10-16), BEETLE (02-15), BORA (02-08), CADDY/MAXI (03-15), EOS (06-15), FOX (05-11), GOLF (02-15), GOLF PLUS (05-14), JETTA (05-15), LUPO (02-05), PASSAT/CC (02-15), POLO (99-14), SCIROCCO (08-14), SHARAN (02-15), TIGUAN (07-15), TOURAN (03-15), TRANSPORTER (03-17).
UTENSILI OEM	DODGE: 9882, 9883. FORD: 310-085/23-059, 303-1054. MITSUBISHI: MB995206, MB995208, MB995209. VAG: T10100 (4), T10050 (1), 3359 (3/6)/T20102, T10115 (3), T10060A (2)/T40098, T20167.
CODICE MOTORE	1.2D TDi CR: CFWA. 1.4D TDi PD: AMF, BAY, BMS, BNM, BNV, BWB. 1.6D TDi CR: CAYA, CAYB, CAYC, CAYD, CAYE, CLNA. 1.9D TDi PD: AJM, ANU, ARL, ASZ, ATD, AUY, AVB, AVF, AVQ, AWX, AXB, AXC, AXR, BJB, BKC, BLS, BLT, BMT, BPZ, BRM, BRR, BRS, BRU, BSU, BSV, BSW, BTB, BVK, BXE, BXF, BXJ. 2.0D TDi CR/TDi PD: AZV, BDJ, BDK, BEW, BGW, BHW, BKD, BKP, BKQ, BLB, BMA, BMM, BMN, BMP, BMR, BNA, BPW, BRA, BRC, BRD, BRE, BRF, BRG, BSS, BST, BSY, BUJ, BUZ, BVA, BVE, BVF, BVG, BVH, BWC, BWV, CAAA, CAAB, CAAC, CAAD, CAE, CAG, CAGB, CAGC, CAHA, CAHB, CBAA, CBAB, CBAC, CBBA, CBDB, CBDA, CBDC, CBEA, CCHA, CCHB, CDBA, CDCA, CEGA, CFCA, CFFA, CFFB, CFFD, CFFE, CFGB, CFGC, CFHA, CFHB, CFHC, CFHD, CFHE, CFHF, CFJA, CGLA, CGLB, CGLC, CGLD, CJAA, CJCA, CJC, CJC, CJC, CLCA, CLCB, CLJA, CLLA, CNEA, ECD, ECD/BSY, ECD/BYL, ECE/BWD.

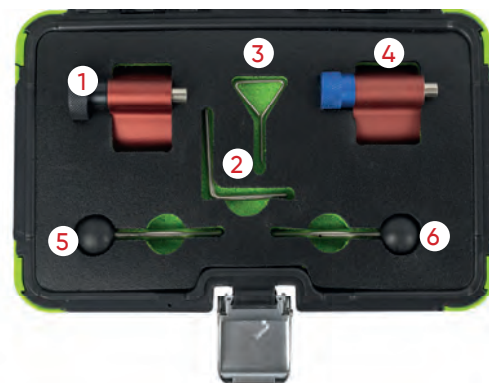

53276

160,00€

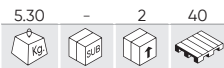

KIT DI ATTREZZI DI REGOLAZIONE CINGHIA DENTATA PER AUDI & SKODA

MODELLO	MOTOR AUDI, VW: V6 2.0, 2.8, 3.0T FSI. AUDI Q5: 2.0, A6L 2.8, 3.0T.
UTENSILI OEM	3418 (1), 3458 (2), T10100 (3), T10123 (4), T10121 (5), 3242 (6), 3551 (8), T10020 (9), T10098 (10), 3078 (12), 2064 (13), 3369 (14), T10092 (15), T40011 (17), 2065A (18), T10016 (19), 3359 (20), T10008 (21), T10050 (22) T10265 (23), T10264 (24), T10060A (25), T10120 (27), 3366 (28)
CODICE MOTORE	2.0, 2.8, 3.0

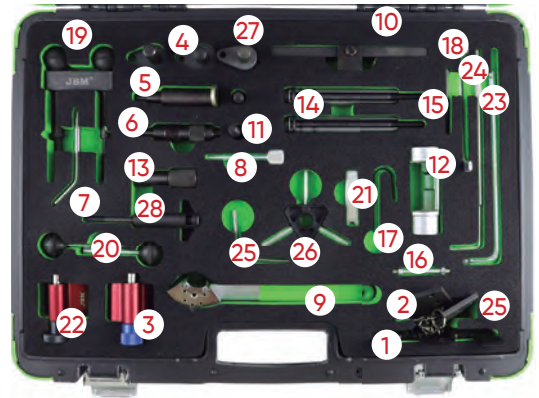

53277

45,00€

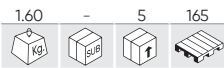

KIT DI ATTREZZI PER LA CINGHIA DI DISTRIBUZIONE VW/AUDI

MODELLO	BENZINA	AUDI: 80, 100, A3, A4, A6 1.6, 1.8/TURBO, 2.0, 2.0 16V, A3, A4 1.6 (96-). SEAT: IBIZA/CORDOBA, TOLEDO, ALHAMBRA, INCA 1.6, 1.8, 1.8 16V, 2.0, 2.0 16V, IBIZA/ CORDOBA, LEON, TOLEDO 1.6 (99-), ALHAMBRA 2.0 (00-). VOLKSWAGEN: POLO CLASSIC, SCIROCCO, CORRADO, GOLF, JETTA, VENTO, PASSAT, SHARAN, TRANSPORTER 1.6, 1.8/TURBO, 1.8 16V, 2.0, 2.0 16V, POLO CLASSIC, GOLF, BORA, BEETLE 1.6 (97-), 2.0 (99-). SKODA: OCTAVIA 1.6 (97-), 2.0 (99-).
	DIESEL	AUDI: 80, 100, A3, A4, A6 1.9 TURBO D, 1.9TDI, 2.5TDI, A3, A4, A6 2.0TDI, A2, A3, A4, A6 1.2TDI, 1.4TDI, 1.9TDI (99-). SEAT: IBIZA/CORDOBA, LEON, TOLEDO, ALHAMBRA, INCA 1.7SDI, 1.9D/TD /SDI/TDI. EQRD: GALAXY (02-06). SKODA: FELICIA, OCTAVIA 1.9D/TDI. VW: POLO, POLO CLASSIC, GOLF, JETTA, VENTO, BORA, BEETLE, PASSAT, SHARAN, CADDY, TRANSPORTER 1.5D, 1.6D/ TURBO, 1.7D/SDI, 1.9SDI/TDI, GOLF, PASSAT 2.0TDI.
UTENSILI OEM	T10020 (1), 3387 (2), V159 (3), T10060/T100604 (4), T10115 (5), T40011 (6)	
CODICE MOTORE	2.0, 2.8, 3.0	



53278

143,00€



KIT DI ATTREZZI DI REGOLAZIONE CINGHIA DENTATA PER AUDI 2.8, 3.2 FSI, 3.0 TFSI

MODELLO	A2, A4, A4 QUATTRO, A6 (2004-2007) A2, A3, A4, A3 FSI (2004-2007) A4, A6, A8 3.2 FSI A6 L QUATTRO 2.4 A6 2.4, A6 2.4 QUATTRO (2004-2007) A4 3.2 FSI (2004-2007) A6 3.2 FSI (2004-2007) A8 3.2 FSI (2005-2007)
UTENSILI OEM	T10172 (1), 3212 (2), T40070 (3), T40069 (4), T40071 (5), T10172/2 (6)
CODICE MOTORE	AUK / BDW / BDX / BKH / CAJA / CALA



53279

97,00€

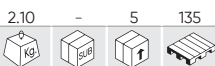

KIT DI ATTREZZI DI REGOLAZIONE CINGHIA DENTATA PER VW/AUDI 1.8, 2.0, TSI, TFSI

MODELLO	AUDI: A3 (96-09), A4 (94-09), A6 (95-11), S3 (99-13), TT (98-14). SEAT: ALHAMBRA (97-10), ALTEA/ALTEA XL (06-09), CORDOBA (99-02), EXEO (09-10), IBIZA (99-02), LEON (99-13), TOLEDO (99-09). SKODA: OCTAVIA/OCTAVIA TOUR (98-10), OCTAVIA II (04-09). VOLKSWAGEN: BEETLE (99-11), BORA (97-04), EOS (06-10), GOLF (97-12), GOLF PLUS (05-09), JETTA (05-09), PASSAT (96-10), SCIROCCO (09-14), SHARAN (97-10), TOURAN (03-09).
UTENSILI OEM	T10020 (1), T10252 (2), T10092 (3), T10115 (4), T40011 (4), 3366 (5), T10060 (6)
CODICE MOTORE	1.8: ADR, AFY, AGN, AJP, APG, APT, AQE, ARG, ARH, AVV. 1.8T: AEB, AGU, AJH, AJL, AJQ, AMK, AMU, ANB, APP, APU, APX, APY, AQA, AQX, ARX, ARY, ARZ, AUM, AUQ, AVC, AWC, AWWT, AWU, AYP, BAM, BFV, BVP, BVR. 2.0 TSI: AXW, BHD, BLR, BLX, BLY, BMB, BVX, BVY, BVZ. 2.0 TFSI/S/R/TSI: AXX, BPY, BWA, BGB, BPG, BPJ, BUL, BWE, BWT, BYK, BHZ, BZC, BWJ, BYD, CDLA, CDLB, CDLC, CDLD, CDLF, CDMA.



53280

112,00€

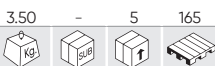

KIT DI ATTREZZI DI ALLINEAMENTO ALBERO A CAMME VW/AUDI 3.0 V6

MODELLO	AUDI: A4 (01-08), A6 (01-08), A8 (03-10).
UTENSILI OEM	3387 (1), T40030 (2) (4), T40026 (3), T40028 (5)
CODICE MOTORE	3.0 V6 30V: ASN, AVK, BBJ, BGN.



53281

55,00€



KIT DI ATTREZZI DI ALLINEAMENTO ALBERO A CAMME VW/AUDI

MODELLO	VOLKSWAGEN: 2.5 TDi V6 AUDI: A4, A6, A8
UTENSILI OEM	3369 (1), 3242 (2), 3458 (3)
CODICE MOTORE	AFB/AKN



53282

48,00€



KIT TRAFORO GRUPPO VAG 1.2, 1.4, 1.6

MODELLO	SEAT: ALHAMBRA (10-15), ALTEA/ALTEA XL (08-15), IBIZA/ CORDOBA (08-12), LEON (07-13), TOLEDO (07-15). VOLKSWAGEN: BEETLE (11-15), CADDY/CADDY MAXI (10-15), EOS (06-12), GOLF (03-12), GOLF PLUS (03-14), GOLF V ESTATE (07-13), GOLF VI CABRIOLET (10-15), JETTA (06-14), PASSAT (05-11), POLO (02-14), SCIROCCO (08-12), TIGUAN (07-12), TOURAN (03-15). SKODA: FABIA II (07-15), OCTAVIA II (04-15), PRAKTIK (10-15), RAPID (12-15), ROOMSTER (06-15), SUPERB II (09-14), YETI (09-14). AUDI: A1 (10-15), A3 (03-13).
UTENSILI OEM	T10171 (1), T10170 (2), T40011 (3)
CODICE MOTORE	1.2 TFSI: CBZA, CBZB, CBZC. 1.4 FSI: AXU, BKG, BLN. 1.4 TFSI: BLG, BMY, BWK, CAVA, CAVB, CAVC, CAVD, CAVE, CAVF, CAXA, CAXC, CDGA, CSMA. 1.6 FSI: BAG, BLF, BLP, BTS.



53283

92,00€



KIT DI SPESSORI GRUPPO VAG 2.7, 3.0 TDI

MODELLO	VOLKSWAGEN: TOUAREG, PHATEON VAG: DIESEL 2.7 / 3.0 V6 AUDI: A4, A5, A6
UTENSILI OEM	3242 (1), T40060 (2) (3), 3359 (4), T40058 (5), T40061 (6), T40062 (7), T40049 (8)
CODICE MOTORE	ASB, BKN, BKS, BWZ, BNG, BPP, BSG, BUG, BUN, CAWA, CAMB, CANA, CANB, CANC, CAND, CAPA, CARA, CARS, CASA, CASE, CASC, CAM, CC/HA, CCWA, CCWB, CDYA, CDVB, CDVC, CEXA, CGKA, CGKB.

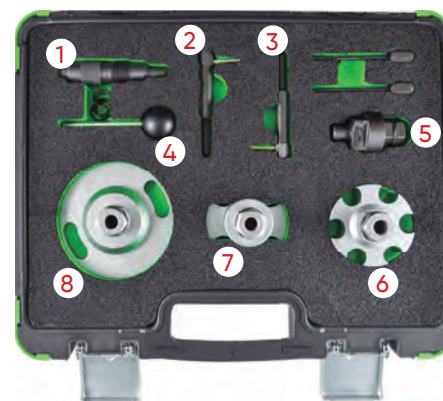

53284

306,00€



KIT TRAFORO GRUPPO VAG 2.5 TDI

MODELLO	VOLKSWAGEN: TOUAREG (03-10), TRANSPORTER (03-09).
UTENSILI OEM	T10225 (1), T10199 (2), T10234 (3), T10226 (4), T10193 (5), T10194 (6), T10199/01 (7), T10226 (8)
CODICE MOTORE	2.5D TDI PD: AXD, AXE, BAC, BLJ, BLK, BNZ, BPC, BPD, BPE.

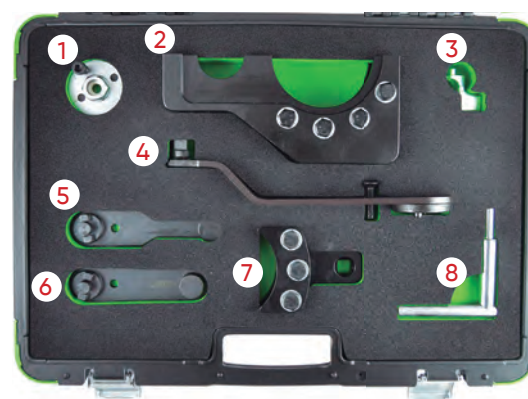

53285

56,00€

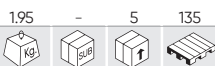

KIT DI ATTREZZI DI REGOLAZIONE CINGHIA DENTATA PER VAG 2.4, 2.5, SDI, TDI

MODELLO	VOLKSWAGEN: CRAFTER (06-13), LT (96-06), TRANSPORTER (90-03).
UTENSILI OEM	2065A (1), T50009 (2), T10025 (3), 3248/3419 (4), 2064 (5), 3355 (6)
CODICE MOTORE	2.4D: AAB, AJA. 2.5D SDI: AGX. 2.5D TDI: ACV, AHD, AHY, AJT, ANJ, APA, AUF, AVR, AXG, AXL, AYC, AYY, BBE, BBF. 2.5D TDI CR: BJJ, BJK, BJL, BJM.



53286

87,00€



KIT DI ATTREZZI DI REGOLAZIONE CINGHIA DENTATA PER VAG VAG 1.8, 2.0 TSI, TFSI

MODELLO	VOLKSWAGEN: 1.8 / 2.0 TSI / TFSI.
UTENSILI OEM	T10368 (2), T10354 (3), T40271 (1)(4), T10352/2 (5), T10352/1 (6), T10352 (7), T40196 (8) (9) (10) (11), T40267 (12) (13), T40098 (14), T10060A (15), T40011 (15)
CODICE MOTORE	BYT, BZB, CABA, CABB, CABD, CADA, CAEA, CAEB, CAWA, CAWB, CBFA, CCTA, CCZA, CCZB, CCZC, CDA, CDAB, CDHA, CDHB, CDNB, CDNC, CDND, CESA, CETA, CFKA, CGYA, CJEB, CJBA, CJSB.

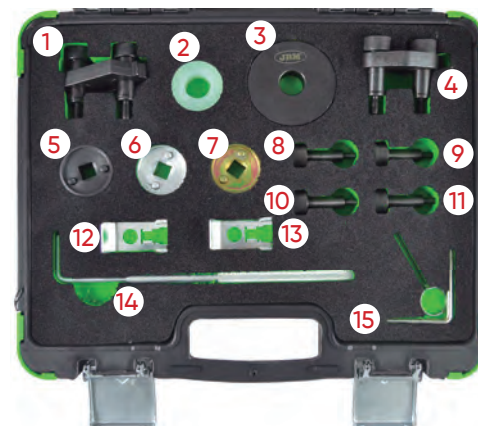

53287

245,00€



KIT DI ATTREZZI DI REGOLAZIONE CINGHIA DENTATA PER VW/AUDI 1.8, 2.0L TURBO

MODELLO	VOLKSWAGEN AUDI	1.8 / 2.0 TURBO
UTENSILI OEM	T10355 (1), T40196 (2), T40271 (3) (4), T10352 (5), T10352/1 (6), T10352/2 (7), T10368 (7), T40267 (8), T10354 (9), T40265 (10), T40011 (11) (14), T40098 (12), T10060A (13)	
CODICE MOTORE	BYT, BZB, CABB, CABD, CADA, CAEA, CAEB, CAWA, CAWB, CBFA, CCTA, CCZA, CCZB, CCZC, CDA, CDAB, CDHB, CDNB, CDNC, CDND, CESA, CETA, CFKA, CGYA, CJEB, CJA, CJSB.	

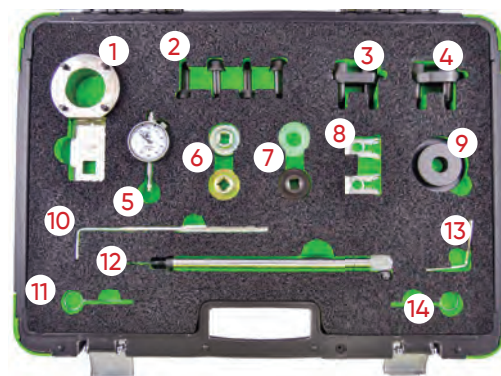

53288

72,00€



KIT DI ATTREZZI DI REGOLAZIONE CINGHIA DENTATA PER VAG 1.6, 2.0 TDI COMMON RAIL

MODELLO	SEAT: EXEO, LEON, ALTEA, TOLEDO, IBIZA. VOLKSWAGEN: JETTA, TOURAN, GOLF, GOLF PLUS, POLO, PASSAT, TIGUAN, SCIROCCO. SKODA: ROOMSTER, FABIA, PRAKTIK, OCTAVIA, YETI, SUPERB. AUDI: A1, A3, A4, A5, Q5, A6, TT.
UTENSILI OEM	T10264 (1), T10265 (2), T20102 (3), T10052 (4), T10051 (5), T10255 (6), T10050 (7), T10100 (8), T40098 (9)
CODICE MOTORE	1.2 TDI CR, 1.6 D TDI CR, 2.0 D TDI CR CAGA, CAGB, CAGC, CAHA, CAHB, CFHC, CBAA, CBAB, CFFB, CGLA, CGLB, CJCA, CJCB, CAAA, CBAA, CBAB, CBAC, CBBA, CBBB, CBDA, CBDB, CBDG, CCHA, CEGA, CJAA, CAAB, CAAC, CFJA, CFWA, CAYB, CAYC, CAYA.



53320

12,00€

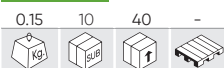

ATTREZZO PER FISSAGGIO ALBERO A GOMITI CON PIASTRA IN ACCIAIO

MODELLO	SEAT: ALHAMBRA, ALTEA, AROSA, CORDOBA, IBIZA, LEON, TOLEDO 1.4/1.9/2.0 TDI. VW: PASSAT 1.9. AUDI: A4/A6 1.9.
UTENSILI OEM	T10008, T20102, T10100.



53321

10,50€



CHIAVE REGOLAZIONE TENSIONAMENTO CINGHIA PER VW AUDI

MODELLO	AUDI: A4/1.8T, 2.0 1999-2004 A6/1.8T 2002-2004 A4/3.0 (2002 -), A6/3.0 (2002 -), A8/7.0 (2003 -). VW: GOLF PASSAT 2.0 TDI DIESEL, GOLF 88-97, PASSAT 92-97, VW T4/2.0 1992-2004.
UTENSILI OEM	T10020



53325

7,50€

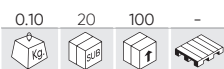

CHIAVE PER PULEGGIA DENTATA 35 MM PER VW AUDI

MODELLO	AUDI: 100 ('91-), A6 (2.5 TDI) 2.3, 2.4, 2.5, 2.8, 2.9D TDI (1991-2003) VW: LT, TRANSPORTER
UTENSILI OEM	3355
CODICE MOTORE	AAB, AAT, ACU, ACV, AEL, AET, AGX, AHG, AHY, AJA, AJT, ANJ, APA, APL, AUF, AVT, AXG, AXL, AYC.



53326

16,00€

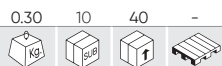

ATTREZZO DI REGOLAZIONE CINGHIA DENTATA PER VW/AUDI

MODELLO	VW: V6 2.5TDi. AUDI: V6 2.5TDi, V8 3.3TDi.
UTENSILI OEM	3458 (1), 3242 (2)



53327

11,00€

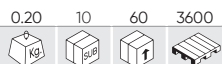

ATTREZZO DI REGOLAZIONE CINGHIA DENTATA PER VAG 1.2

MODELLO	SEAT: IBIZA1.2 6V/3CYL (2002-09), CORDOBA 1.2 12V/3CYL (2002-13). VW: POLO 1.2 6V-12V/3CYL (2002-14). SKODA: FABIA 1.2 6V-12V/3CYL (2002, 2003-), FABIA II 1.2 6V/3CYL (2007-13), ROOMSTER 1.2 12V/3CYL (2006-13), PRAKTIK 1.2 6V/3CYL (2007-13).
UTENSILI OEM	T10123
CODICE MOTORE	1.2 6V: AWY, BMD, BBM, CHFA, CHFB 1.2 12V: AZQ, BME, BVX, BZG, CEVA, CGPA, CGPB, CGPC.



53648

107,00€



KIT DI ATTREZZI PER LA MESSA IN FASE DELLA DISTRIBUZIONE PER VAG 1.0, 1.2, 1.4 TSI

MODELLO	AUDI: A1 (12-15), A1 SPORTBACK (12-15), A3 (13-15), A3 SPORTBACK (12-15). SEAT: IBIZA (12-15), LEON (12-15), TOLEDO (12-15). SKODA: FABIA (10-13), OCTAVIA II (10-13), OCTAVIA III (10-15).
UTENSILI OEM	T10060A (1), T10340 (2), T10476 (3), T10494 (4), T10499 (5), T10504/1 (6), T10504 (7), T10504/2 (8).
CODICE MOTORE	1.2 TSI: CJZA, CJZB. 1.4 TSI: CGGA, CHPA, CMBA, CPVA, CRJA, CXSA. 1.4 TSI ACT: CPTA.

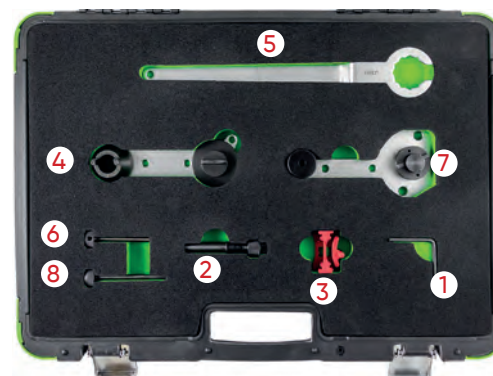

53649

89,00€



SET DI STRUMENTI PER LA FASATURA DEL MOTORE VAG GROUP

MODELLO	AUDI SEAT	SKODA VW
UTENSILI OEM	T10340 (1), T10476 (2), T10477 (3), T10487 (4), T10494 (5), T10499 (6)	
CODICE MOTORE	1.0 MPI: CHYA. 1.0 TSI: CHZE, CHZC, CHZA, CHZB, CHZC, CHZD, CHZJ. 1.2 TSI: CJZB, CJZC, CYVA, CJZA, CJZD, CYVB. 1.4 TSI: CZCC, CMBA, CZCA, CHPA, CPTA (ACT), CZDA, CVNA, CZEA (ACT).	

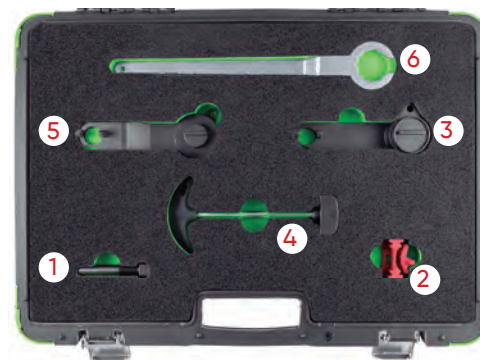

53706

98,00€



KIT PER CENTRAGGIO DEL L'ALBERO A CAMME VAG 1.4, 1.6, 2.0 TDI COMMON RAIL

MODELLO	VOLKSWAGEN: GOLF ALLTRACK, GOLF SPORTSVAN, GOLF VII, GOLF VII KOMBI, PASSAT, POLO. AUDI: A1, A1 SPORTBACK, A3, A3 CABRIOLET, A3 LIMOUSINE, A3 SPORTBACK, TT, TT ROADSTER. SEAT: IBIZA, IBIZA V SPORTCOUPE, IBIZA V ST, LEON, LEON SC, LEON ST, TOLEDO IV. SKODA: FABIA, FABIA KOMBI, OCTAVIA, OCTAVIA COMBI, RAPID, RAPID SPACEBACK.
UTENSILI OEM	OEM 3204 (1), OEM 3359 (2), OEM T10490 (3), OEM T10051 (4), OEM T10060A (5), OEM T10264 (6), OEM T10265 (7), OEM T10492 (8), OEM T40098 (9).
CODICE MOTORE	1.4, 1.6, 2.0 TDI CR CXXB, DBKA, DCXA, CGLE, CKFB, CKFC, CLHA, CLHB, CNHA, CNHC, CRBD, CRFA, CRFC, CRKA, CRKB, CRLB, CRLC, CRMB, CRUA, CRVA, CRVC, CSUA, CSUB, CUNA, CUPA, CUSA, CUSB, CUTA, CUUD, CXEB, DBKA, DCXA, DCZA, DFSD.

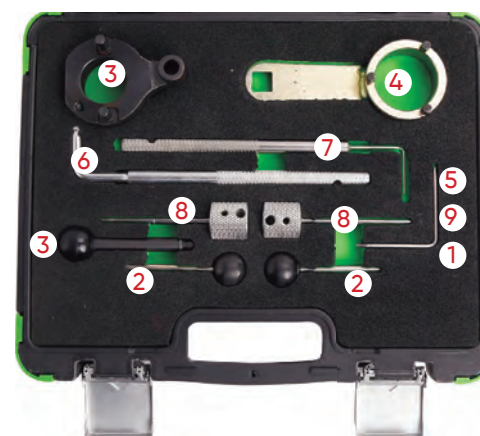

54092

24,00€



KIT DI CONTROLLO E REGOLAZIONE DI FASI DISTRIBUZIONE DEL GAS PER IL MOTORE VAG 1.2 TFSI

MODELLO	AUDI: A1, A3, A3 SPORTBACK, A3 CABRIO SEAT: ALTEA, ALTEA XL, IBIZA, LEON, TOLEDO SKODA: FABIA II, OKTAVIA II, PRAKTIK, RAPID, RAPID SPACEBACK, ROMMSTER, YETI VW: BEETLE, CADDY, CADDY MAXI, GOLF PLUS, GOLF VI, GOLF VI CABRIO, GOLF VI ESTATA, JETTA, POLO, TOURAN
UTENSILI OEM	T10340(1), T10414(2), T10341(3)
CODICE MOTORE	CBZA, CBZB, CBZC



54199

94,00€

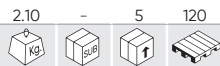

KIT DI ATTREZZI DI CRONOMETRAGGIO DEL MOTORE PER VAG TFSI, FSI

MODELLO	AUDI: A1 (10-15), A1 SPORTBACK (10-15), A3 CABRIOLET (10-13), A3 (10-15), A3 SPORTBACK (03-13) SEAT: ALTEA/ALTEA XL (10-15), IBIZA (10-15), LEON (10-13), TOLEDO (12-15) SKODA: FABIA II (10-15), PRAKTIK (10-15), RAPID (12-15), RAPID SPORTBACK (12-15), OCTAVIA II (04-13), YETI (09-15), YETI OUT-DOOR (13-15) VW: BEETLE (11-15), CADDY/CADDY MAXI (10-15), EOS (07-15), GOLF V (03-13), GOLF V ESTATE (07-09), GOLF VI (10-13), GOLF VI ESTATE (10-13), GOLF VI CABRIOLET (11-15), GOLF PLUS (05-14), JETTA (05-14), PASSAT (05-15), POLO (09-14), SCIROCCO (08-14), TIGUAN (07-15), TOURAN (03-15)
UTENSILI OEM	T10414 (1), VAS 6079 (2), T10170 (3), T10171/ T10171A (4), T40011 (5), T10340 (6), T10341 (7)
CODICE MOTORE	1.2 TFSI: CBZA, CBZB, CBZC 1.4 FSI/TFSI: BLG, BMY, BWK, CAVA, CAVB, CAVC, CAVD, CAVE, CAVF, CAXA, CAXC, CDGA, CSMA 1.6 FSI: BAG, BLF, BLP



54218

142,00€

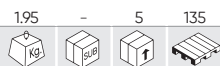

KIT DI ATTREZZI DI MONTAGGIO PER AMMORTIZZATORE DI VIBRAZIONI VAG

MODELLO	AUDI, SEAT, SKODA, VOLKSWAGEN
UTENSILI OEM	T10531/1 (1), T10531/2 (2), T10531/3 (3), T10531/4 (4)
CODICE MOTORE	1.8L TFSI: BZB, CDAA, BPU, BYT, CABA, CABB, CDHA, CDHB, CABD, DAJB, CJSA, CJSB, CJEB, CJEE, CJED, CYGA, CDAC, CJSC, CGYA, DAJA 2.0L TFSI: CAWB, CCZA, CBFA, CCTA, CDNB, CDNC, CDND, CJXA, CJXE, CJXH, CHHB, CHHA, CULA, CFKA, DEDA, CHJA, CAWA, CCZC, CCZD, CPSA, CJKA, CJKB, CESA, CETA, CFPA, CNCD, CPLA, CYRB, CYRC; CNCE, CYNB, CYPB, CULB, CULC, CNCB, CWZA, CJXF, CJXC, CJXB, CJXG, CHHC, CCZB

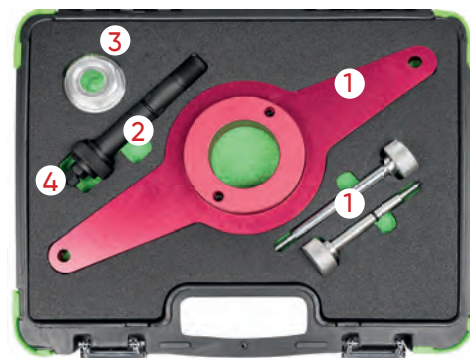

54407

397,00€



KIT ATTREZZI PER MONTAGGIO ALBERO A CAMME PER VAG/PORSCHE

MODELLO	AUDI, PORSCHE, SEAT, SKODA, VOLKSWAGEN 1.2 - 1.6 - 2.0 - 2.7 - 3.0 - 4.0 - 4.2 COMMON RAIL
UTENSILI OEM	T40094, T40094/1 (1), T40094/2 (2), T40094/3 (3), T40094/4 (4), T40094/5 (5), T40094/6 (6), T40094/7 (7), T40094/8 (8), T40094/9 (9), T40094/10 (10), T40094/11 (11), T40094/12 (12), T40095 (13), T40096 (14), T40096/1 (15)
CODICE MOTORE	ASB, ASE, BKN, BKS, BMK, BNG, BPP, BSG, BTR, BUG, BUN, BVN, CAAA, CAAB, CAAC, CAAD, CAAE, CAGA, CAGB, CAGC, CAHA, CAHB, CAMA, CAMB, CANA, CANB, CANC, CAND, CAPA, CARA, CASA, CASB,CASC, CASD, CATA, CAYA, CAYB, CAYC, CAYD, CAYE, CBAA, CBAB, CBAC, CBBA, CBBB, CBDA, CBDB, CBDC, CCFA, CCFC, CCHA, CCHB, CCLA, CCMA, CCWA, CCWB, CDBA, CDCA, CDSB, CDTA, CDTB, CDUC, CDUD, CDYA, CDYB, CDYC, CEGA, CEXA, CFCA, CFFA, CFFB, CFFD, CFFE, CFGB, CFGC, CFGD, CFHA, CFHB, CFHC, CFHD, CFHE, CFHF, CFJA, CFWA, CGKA, CGKB, CGLA, CGLB, CGLC, CGLD, CGLF, CGQB, CJAA, CJCA, CJCB, CJCC, CJCD, CJGA, CJGC, CJGD, CJMA, CKDA, CKTB, CKTC, CKUB, CKUC, CKVB, CKVC, CLAA, CLAB, CLCA, CLCB, CLJA, CLLA, CLNA, CLZB, CMEA, CMFA, CMFB, CMGB, CMHA, CNEA, CNFA, CNRB, CRCA,CSHA, M05/9D(CAS), M05/9E, M05/9E(CRCA), M05/9E(CRCB)

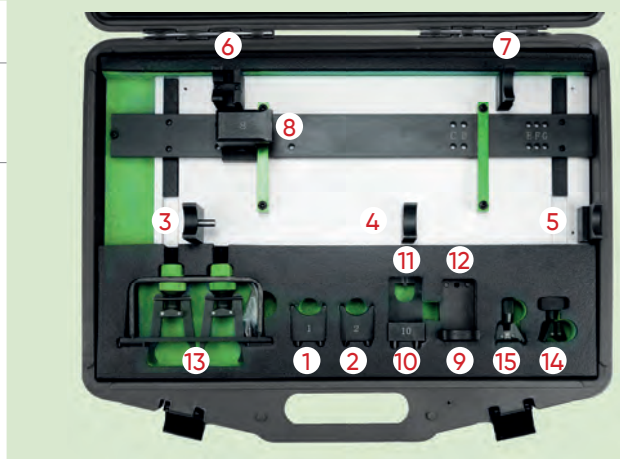

54408

46,00€

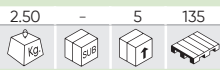

N

SET DI STRUMENTI PER LA FASATURA DEL MOTORE VAG DIESEL 1.7, 1.9, SDI, TDI

MODELLO	AUDI: A3, A4, A6, CABRIOLET, SEAT: ALHAMBRA, AROSA, CORDOBA, IBIZA, INCA, LEON, TOLEDO, SKODA: FELICIA, OCTAVIA VW: BORA, CADDY, FOX, GOLF, LT, LUPO, PASSAT, POLO, SHARAN, TRANSPORTER, VENTO
UTENSILI OEM	T1020 (1), 2587 (2), 2065A (3), T20044 (4), T10098 (5), T40011 (6), 2064 (7), T3359 (8), T10092 (9), M5x60M (10)
CODICE MOTORE	1.7TDI/SDI: AHB, AHG, AKU, AKW 1.9TDI/SDI: 1X, 1Y, 1Z, ABL, AAZ, AEF, AEY, AFF, AFN, AGD, AHF, AHH, AHU, AGP, AGR, ALE, ALH, AQM, ASV, ASY, ASX, AVG, AYQ 2.4D: 1G, 1S, DW, DV, ACL, ACT

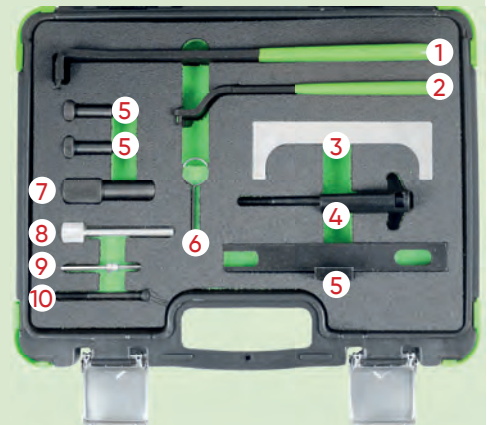

54409

32,00€

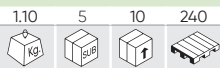

N

KIT DI MESSA IN FASE PER VAG 1.4 TSI

MODELLO	ATECA (2016-) A3 (2012-) SUPERB (2015-) A1 SPORTBACK (2012-2018) LEON/LEON ST (2012-2020) MK5 (2012-2018) Q2 (2016-) Q3 (2015-2018)
UTENSILI OEM	T10340 (1) T10504 (2) T10504/1 (3) T10504/2 (4)
CODICE MOTORE	1.4 TFSI (CoD)-CPTA, CZEA 1.4 TSI (ACT)-CPTA, CZEA



54410

33,50€



N

KIT DI MESSA IN FASE PER VAG 2.4, 3.2 FSI

MODELLO	AUDI: A4, A5, A6, A7, A8, Q5, Q7, R8, RS4, RS5, RS6, S4, S5, S6, S8 VW: TOUAREG
UTENSILI OEM	T40058 (1) T40069 (2) T40071 (3) T40133 (3) T40133/1 (3) T40133/1/2 (3) T40133/2 (3) 40071 (4)
CODICE MOTORE	2.4: BDW 3.2: AUK, BKH, BPK 4.2: BAR, BNS, BVJ, CAUA, CDRA, CFSA, BYH, CNDA 5.0: BUH 5.2: BSM, BUJ, BXA, CMPA, CTPA, CTYA

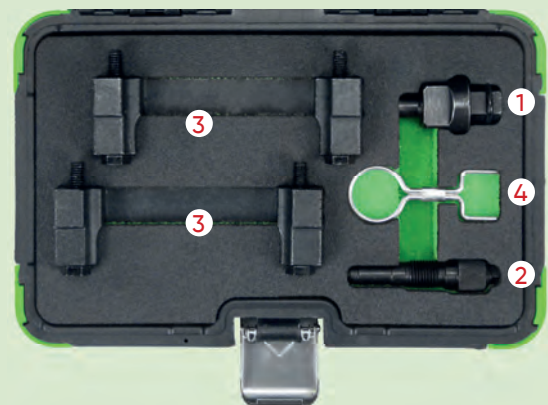

KIT DI MESSA IN FASE

54411

36,00€



N

KIT DI MESSA IN FASE PER VAG/PORSCHE 2.4, 2.8, 3.0 TFSI

MODELLO	AUDI: A4 (2011-2015) A5 (2007-2017) A6 (2007-2018) A7 (2010-2018) A8 (2010-2018) A8 (2010-2018) Q7 (2010-2018) S4 (2009-2017) S5 (2010-2017) S5 (2010-2017) Q5 (2008-2017) SQ5 (2013-2018) PORSCHE: CAYENNE (2010-2014) PANAMERA 2011-2013 VAG: TOUAREG (2010-2014)
UTENSILI OEM	T40133/1 (1) T40133/2 (2) T40058 (3) T40069 (4) T40071 (5)
CODICE MOTORE	AUDI: 2,5 CLXB, CPAA 2,8 BDX, CCDA, CCEA, CHVA, CJBA, CNYA 3,0 CAJA, CAKA, CCAA, CGEA, CGWA, CGWB, CGWC, CGWD, CGXB, CGXC, CHMA, CHMB, CJTB, CJTC, CJWC, CMDA, CMUA, CNA, CREA, CREC, CRED, CTTA, CTUA, CTUD, CTVA, CTWA, CTXA 3,2 CALA, CALB PORSCHE: 3,0 M06/EC VAG: 3,0 CJTA, CGFA

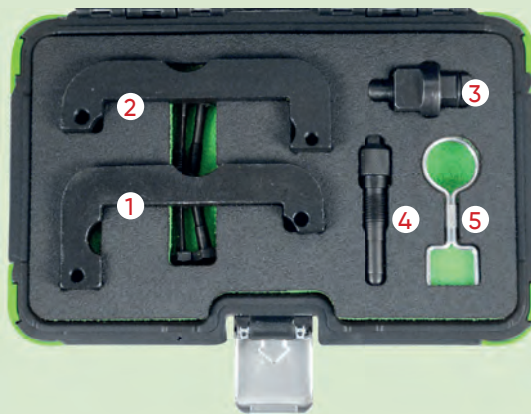

54412

57,00€



N

KIT DI MESSA IN FASE PER AUDI 2.5 TFSI

MODELLO	AUDI: RSQ3 (2013-2015), RSQ3 (2015-2018), RS3 (2010-2013), RS3 (2015-2017), TT (2009,2014)
UTENSILI OEM	T03003 (1) T40264/1/2 (2), T40264/2A (2) T40069 (3) T40011 (4) T40297 (5)
CODICE MOTORE	2,5 TFSI/RS CEPA, CEPB, CTSA, CZGA, CZGB

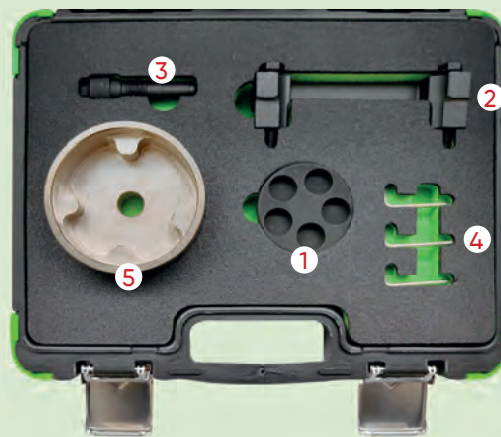

54413

115,00€



N

KIT DI MESSA IN FASE PER AUDI 4.0 FSI, TFSI

MODELLO	AUDI: A8, RS6, RS7, S6, S7, S8 (2012-2018)
UTENSILI OEM	T40071 (1) T40257 (2) T40264/1 (3) T40264/2 (4) T40264/3 (5) T40269 (6) T40272 (7)
CODICE MOTORE	CEUA CEUC CGTA CRDB CTFA CTGA CTGE CWUB CWUC DDTA

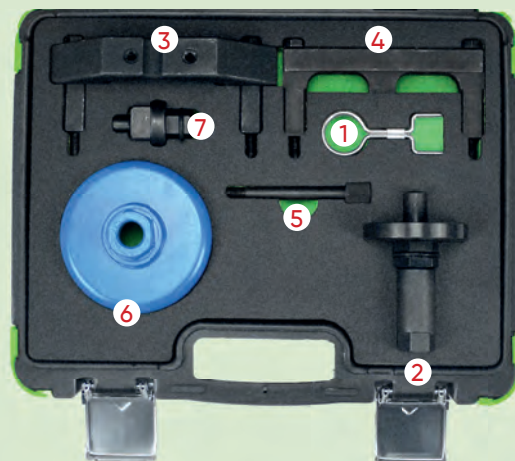

54431

184,00€



N

KIT DI MESSA IN FASE PER ALFA ROMEO/MASERATI 2.9

MODELLO	ALFA ROMEO: GIULIA, STELVIO MASERATI: 3,8T
UTENSILI OEM	1860815000 (1) 2024000090 (2) 2024100000 (3)
CODICE MOTORE	2.9: 670050436,670051007 ,670052721 ,670052722

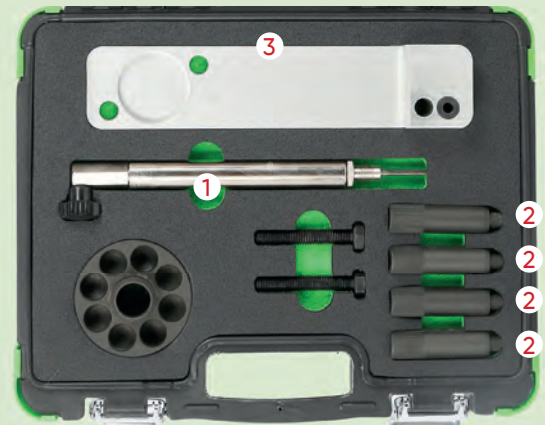

53315

285,00€



KIT DI ATTREZZI DI REGOLAZIONE CINGHIA DENTATA PER VOLVO 3.0, 3.2T6 / LAND ROVER 3.2

MODELLO	VOLVO: S60 (10-16), S80 (07-15), XC60 (08-15), XC70 (06-15), XC90 (10-14), V60 (10-15), V70 (10-15). LAND ROVER: FREELANDER II (11-14).
UTENSILI OEM	VOLVO: 999-7263 (3), 999-7264 (1), 999-7272 (5), 999-7257 (2), 999-7261 (4). LAND ROVER: 303-1225 (3), 303-1226 (1), 303-1219 (2), 303-1223 (4).
CODICE MOTORE	3.0 TURBO: B6304T2, B6304T4. 3.2: B6324S, B6324S5. 3.2i6: B6324S.

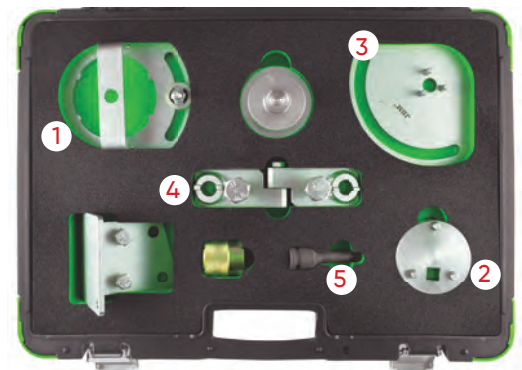

54226

71,00€



SET DI ESTRATTORI PER PULEGGIA POMPA AD ALTA PRESSIONE PER HYUNDAI/KIA

MODELLO	HYUNDAI: ACCENT (11-15), ELANTRA (07-10), I20 (09-18), I20 (10-18), I20 COUPE (15-17), I30 (07-19), IX35 (10-16), I40 (11-18) KIA: CARENS (13-18), CEED (07-18), OPTIMA (11-15), PRO-CEED (08-19), RIO (09-17), CERATO (05-07), SOUL (09-14), SPORTAGE (10-18), VENGA (09-18)
UTENSILI OEM	09331-2A000/2A010 (1), 09331-2A010 (1)
CODICE MOTORE	1.1D CRDI: D3FF 1.4D CRDI: D4FC(U1), D4FC(U2) 1.6D CRDI: D4FB(U1), D4FB(U2), D4FB-H(U1), D4FB-H(U2), D4FB-L(U1) 1.7D CRDI: D4FD(U2), D4FD-H(U2), D4FD-L, D4FD-L(U2)



KIT DI MESSA IN FASE

54200

56,00€

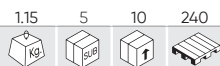

KIT DI ATTREZZI DI CRONOMETRAGGIO DEL MOTORE PER PORSCHE

MODELLO	911 (2001 - 2008), BOXSTER (2002 - 2011), CAYMAN (2006 - 2009)
UTENSILI OEM	9685 (1), 9686 (2), 9595 (3), 9595/1 (4)
CODICE MOTORE	M96/03, M96/05, M96/23, M96/25, M97/20, M96/24, M96/26, M97/01, M97/21, M97/22.



51927

25,00€

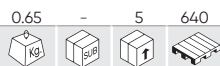

KIT DI SMONTAGGIO E MESSA IN TENSIONE DI CINGHIE POLY-V



51340

39,30€



CHIAVE UNIVERSALE PER ALBERO A CAMME + ADATTATORI



52616

44,00€

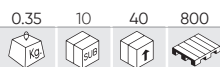

TENSIOMETRO PER CINGHIA DI DISTRIBUZIONE

- Due misure di regolazioni con lettura anteriore e posteriore.

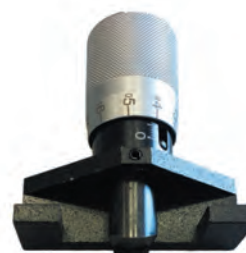

53769

178,00€

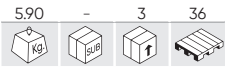

MODULO DI REGOLAZIONE CINGHIA DENTATA PER RENAULT/NISSAN/OPEL/VOLVO

<p>MODELLO</p>	<p>RENAULT: AVANTIME, CLIO, ESPACE, KANGOO, LAGUNA, MASTER, MEGANE, MODUS, SCENIC, TWINGO, TRAFFIC. OPEL/VAUXHALL: MOVANO, VIVARO. DACIA: DOKKER, DUSTER, LOGAN, SANDERO. NISSAN: ALMERA, INTERSTAR, KUBISTAR, MICRA, NOTE, PRIMERA, QASHQAI. VOLVO: S40, V40</p>
<p>UTENSILI OEM</p>	<p>MOT 1312 (1), MOT 1135-01 (2), MOT 1384 (3), MOT 1340 (4), MOT 1543 / KM-6234 / KV113 B0360 (5), MOT 1489 / KV113 B0130 (6), MOT 1536 / KM-6203 (7), MOT 1489 (8), MOT 1054 / KM-6031 / KV113 / B0280 (10), MOT 1318 (11), MOT 910 (12), MOT 910 (14), MOT 1386 (15), MOT 1534 / KM-6205 (16), MOT 1543 / KM-6234 / KV113 B0360 (17), MOT 1543 / KM-6234 / KV113 B0360 (18), MOT 1543 / KM-6234 / KV113 B0360 (19), MOT 1543 / KM-6234 / KV113 B0360 (20), MOT 1386 (22), MOT 1537 / KM-6204 (23), MOT 1348 (24), MOT 1538 (25), MOT 1337 (26), MOT 1496 / MOT 1750 (27), MOT 1490-01 (28), MOT 1200-01 (29)</p>
<p>CODICE MOTORE</p>	<p>PEROL: 2.0 16V, 2.5 20V, 1.4, 1.6 16V, 1.8, 2.0 16V, 1.2, 1.7, 1.8, 2.0 16V, 2.2 GASOIL: 1.9, 2.5, 2.8</p> <p>D4F702/706/708/712/714/716/722/728/730/740/764, D7F700/701/710/720/722/726/730/744/746/764/766, E7F700/704/706/750, E7J601/624/626/634/635/680/700/706/710/711/716/718/719/720/724/726/728/740/742/745/754/756/757/764/770/771/773/780, F3P670/682/700/704/706/708/710/712/714/720/724/755/758/760, F7P704/722, F3R611/722/723/728/729/750/751/752/791/796/797/798, F5R700/701/740, J7R732/733/734/735/768, F7R710/714, J7T600/760/761/762/766/772/780/782, N7Q704/710/711, N7U700/701, K4J700/710/711/712/713/714/715/730/732/740/750/770/780, K4M700/701/704/706/707/708/709/710/711/712/714/716/718/720/724/730/732/734/736/740/742/743/744/745/746/748/750/752/753/754/760/761/762/764/765/766/768/776/782/788/790/791/794/800/801/802/804/812/813/830, K9K700/702/704/706/710/712/714/716/718/722/724/728/729/732/734/740/750/752/760/762/764/766/768/802/804/806, F9Q610/650/664/670/674/71/716/717/718/720/722/730/731/732/733/734/736/738/740/744/748/750/752/754/758/759/760/768/762/770/772/774/780/782/784/786/788/790/799/800/803/804/808/812/816/818/820, G9T600/605/700/702/703/706/707/710/712/720/722/742/743/750, G9U720/724/726/730/750/754, F8M736/760, F8Q600/610/606/620/622/624/630/632/640/644/646/648/662/672/678/680/682/684/692/696/706/714/720/722/730/732/740/742/744/764/768/706/776/784/786/788, J8S620/621/622/758/760/776/778, G8T714/716/740/752/760/790/792/794, S8U720/722/730/731/742/748/750/752/770/772/780/782, S9U700/702/704/714/740, S9W700/702/206/208/212, E5F, E6J, K7M, F4P/F4R, FIN, F2N, F3N, F2R, F3P, F4P, F3R, J5T, J6R, J7R</p>

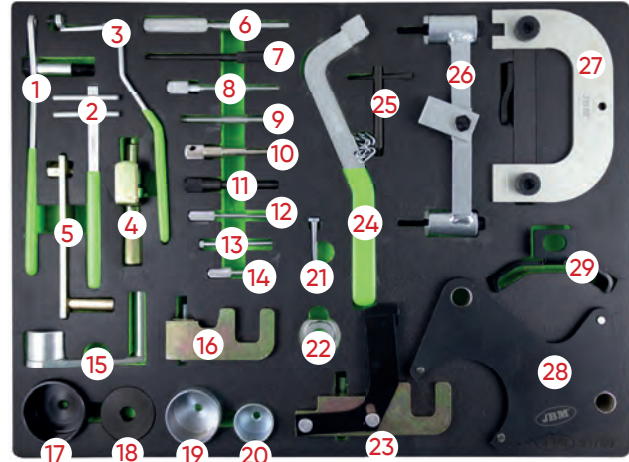

53773

298,00€

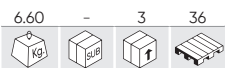

MODULO DI REGOLAZIONE CINGHIA DENTATA PER FIAT/ALFA/LANCIA/OPEL/SUZUKI/FORD

<p>MODELLO</p>	<p>ALFA: ROMEO 145, 146, 147, 155, 156, 159, 166, SPIDER, GTV, TS, GT, CROSSWAGON Q4 FIAT: PUNTO, GRANDE PUNTO, BRAVA, BRAVO, MAREA, WEEKEND, STILO, DOBLO, CARGO, IDEA, PANDA, MULTIPLA, PALIO, STILO, 500 LANCIA: LYBRA, YPSILON, THESIS, MUSA OPEL: CORSA, AGILA, MERIVA, COMBO, VECTRA, ZARA, ASTRA, INSIGNA, SIGNUM 19 CDTI SUZUKI: IGNIS, SWIFT, WAGON R+ FORD: KA</p>
<p>UTENSILI OEM</p>	<p>1860874000 (1), 1860874000 (2), 2000004400 / 2190754400 (3), 1860863000 (4), 1860898000 (5), 2190754500 (6), 2000004300 (7), 1870900400 (8), 1860703000 (9), 1860933000 (10), 1860845000 (11), 1870900300 (12), 1860905000 / EN-46788 (13), 1895443000 (14), 1860992000 (15), 1870896900 (16), 1860987000 (17), 1860905000 (18), 1860771000 (19), 1860161000 (20), 1860876000 (21), 1860876000 (22), 1871000900 (23), 1860985000 (24), 2000004200 / 2190754200 (25), 1860965000 (29)</p>
<p>CODICE MOTORE</p>	<p>176B9.000, 182B2.000, 188A5.000, 843A1.000, 323.02, 371.01, 182B4.000, 182B9.000, 186A6.000, 188A2.000, 188A7.000, 188B2.000, 192A1.000, 192A3.000, 937A2.000, 939A1.000, 192A5.000, 192B1.000, 198A5.000, 937A5.000, 939A2.000, 325.01, 342.02, 362.02, 185A6.000, 841C.000, 841G.000, 939A3.000, 940A3.000, 940A4.000, 940A5.000, Z19DT, DTH/DTR/DTL/DTL, 169A1.000, 955A4.000, 350A3.000, 192B4.000, 198A2.000, 350A2.000, 955A3.000, 192A8.000, 198A6.000, 198A3.000, 199B1.000, 199B2.000, 199A2.000, 199A3.000, 199A9.000, 188A3.000, 188A8.000, 188A9.000, 192A9.000, 186A8.000, 186A9.000, 199A5.000, 223A7.000, 223A9.000, 841H.000, 841P.000, 185A2.000, Z13DT, Z13DTJ, Z13DTH, 182A4.000, 182A6.000, 182B6.000, 178B3.000, 186A3.000, 186A4.000, 350A1.000, 169A4.000, 188A4.000, 199A4.000, 199A7.000</p>

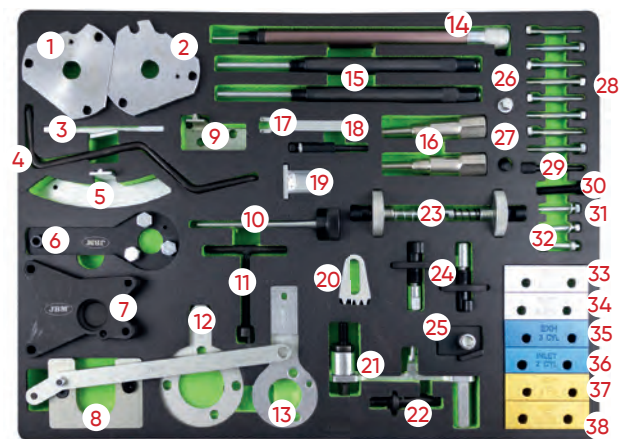

53770

198,00€

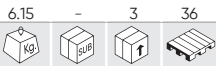

ATTREZZO DI REGOLAZIONE CINGHIA DENTATA PER FORD/SEAT/VOLKSWAGEN/MAZDA/VOLVO

MODELLO	FORD: FIESTA, FUSION, COURIER, ESCORT, FOCUS, FOCUS C MAX, PUMA, MONDEO, SIERRA, COUGAR, GALAXY, C-MAX, ORION, TOURNEO CONNECT, TRANSIT, TRANSIT CONNECT. VW: SHARAN. SEAT: ALHAMBRA. MAZDA: I21. VOLVO: S40, V50.
UTENSILI OEM	303-1061 (1), 303-1054 (2), 23-059 / 310-085 (3), 21-105 (4), 323-029 (6), 0194-B / 21-263 / 303-735 / 49 JE 02 021 (7), 0132-AB / 0178-D / 21-151 (9), 0194-C, 21-262, 303-734, 49 JE 02 020 (10), 21-238 / 303-679A / 303-1151 (11), 21-238 / 303-679A / 303-1151 (12), 303-1054 (13), 303-1151 (14), 21-238 / 303-679A (15), 303-393 / 303-393-02 (16), 303-1097 (17), 21-168 / 303-393 (18), 303-0985 (20), 2064 / 23-047 / 310-055 / U20003 (21), 303-652 (22), 21-229, 303-651 (23), 303-748 (24), 21-210 (25), 21-260, 303-732 (26), 21-163, 303-620 (27), 21-234 / 21-251 (28), 303-675 / 303-698 (29), 21-104 / 303-193 (30) / 21-162B / 303-367 / 303-376 (31), 21-162B / 303-376 / 303-376B (32), 23-019 (33), 23-058 / 310-084 (34), 0153-M / 0178-C / 0178-D (35), 0178-B / 5711-TB (36), 21-123 (37), 23-020 (38), 21-234 / 21-251 (39), 303-1059 (40), 23-019 (41), 303-1060 (42), 303-393 / 303-393-01 (43)
CODICE MOTORE	FUJA, FUJB, FXJA, FXJB, FYJA, FYJB, F8JA, F8JB, M7JA, M7JB, DHA, DHB, DHC, DHD, DHE, DHF, DHG, FHA, FHE, LIT, LIV, LIE, LIG, LIH, LIK, RDA, RDB, RKC, RQB, RQC, FXDA/C, FXDB/D, FYDA/C, FYDB/D, FYDH, HWDA1Z, AHU, AVG, AFN, D24, D24T, D24TIC, RFN, RTJ, RTK, RVA, RFK, RKD, B4164S3, DV4TD (8HW/8HX/8HZ), DV4TED4(8HV/8HY), DV6ATED4 (9HX/9HY/9HZ) F6JA, F6JB, F6JC, G8DA, G8DB, KKDA, SNJA, SNJB, STJA, STJB, ASDA, ASDB, FXJC, SPJA, SPJC, FYJC, HWDA, HWDB, SHDA, SHDB, SHDC, JQDA, LQDB, JTDA, JTDB, HXDA, HXJA, HXJB, IQDA/B, IQDB, PNBA, PNDA, RHBA, SIDA, F6JD, TZJA, TZJB, HHDA, HHDB, HHJA, HHJC, HHJD, HHJE, HHJF, RTA, RTB, RTC, RTD, RTE, RTF, RTH, RTJ, RTK, RFN, BHPA, HCPA, HCPB, KKDA, P7PA, P9PA, P9PB, R2PA, R3PA, RWPA, RWPC, F9DA/B, FFBA, FFWA, KHBA, QYBA, QYWA, KKDB, C9DC, RVA, 1Z, AFN, AHU, ANU, AUY, G6DA, G6DB, G6DC, G6DD, G6DE, G6DF, G6DG, UFDB, TXDB, TYDA, UKDB, QXBA, AZBA, KLBA, QXBB, LPBA, AZBC, TYBA, UKBA, UFBA, TXBA, IXDA, QXWA, QXWB, AZWA, KLWA, AZWC, TYWA, UKWA, TXWA, UFWA, UFDA, TXDA, UKDA, Q4BA, KNBA, 4BA, 4BB, 4BC, 4CC, 4FA, 4CA, 4CB, 4DA, 4EA, 4FA, 4FB, 4FC, 4FD, 4GA, 4HB, 4HC, 4EB, 4EC, 4ED, 4GA, 4GB, 4GC, 4GD, 4GE, 4GF, 4HA, 4HD, FMBA/B, D5BA, ABFA, D3FA, D6BA, HJBA/B, F3FA, D2FA, D4FA, F4FA, F5FA, DOFA, QJBA, QJBB, QJBC, QJBD, FXFA, H9FA, H9FB, N7BA, N7BB, MZ-CD 1.6, Y6

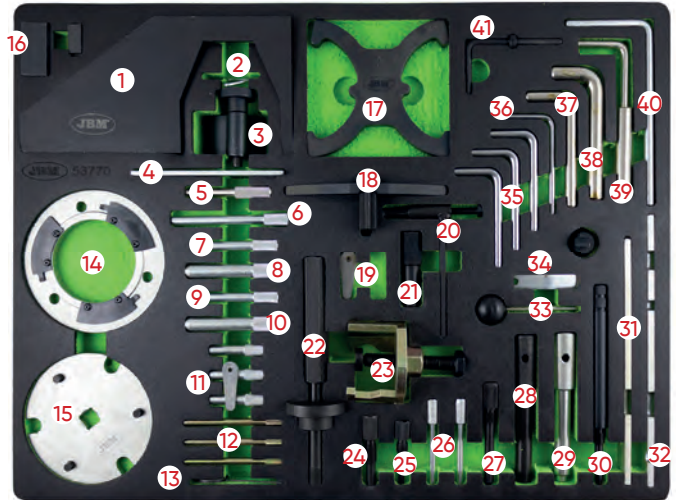

53774

190,00€



ATTREZZO DI REGOLAZIONE CINGHIA DENTATA PER OPEL/CHEVROLET/SAAB/FIAT/LANCIA/SUZUKI/FORD

MODELLO	ALFA: 145, 146, 147, 156, 159, 166, GT, CROSSWAGON Q4 FIAT: PUNTO, GRANDE PUNTO, BRAVO, BRAVA, MAREA WEEKEND, STILO, DOBLÒ, CARGO, MULTIPLA IDEA, PANDA LANCIA: YPSILON, MUSA, LYBRA, THESIS OPEL: CORSA B/C, COMBO, TIGRA, AGILA, TIGRA B, MERIVA, ASTRA F/G/H, ASTRAVAN, SPEEDSTER VX220, ZAFIRA A/B, VECTRA B/C, SIGNUM, OMEGA B, SINTRA, FRONTERA A/B, ASTRAVAN, KADETT, ASCONA, OMEGA, MONTEREY, ANTARA, CROMA, SPEEDSTER VX220 SUZUKI: IGNIS, SWIFT, WAGON R+ FORD: KA CHEVROLET & DAEWOO: EPICA, CAPTIVA, NUBIRA, LACETTI, EVANDA SAAB: 9-3, 9-5 (98-04)
UTENSILI OEM	1860905000 / 1860905010 / EN-46788 (1), KM-6148 (2), KM-6148 (3), 1870900400 / 1871000200 (4), KM-954 (5), KM-J-43651 (6), 1860905000 / 1860905010 / EN-46788 (7), KM-852 (8), KM-853 (9), 1870900300 / 303-1468 (10), EN-46785 / KM-951 (11), KM-932 (12), 1860703000 (13), KM-955 (14), KM-6130 / KM-6349 / KM-6349 (15), KM-927 (16), EN-48245 (17), KM-933 (18), EN-46785 (19), 1860985000 / 1871000900 / EN-46781 (20), 1860985000 / 1871000900 / EN-46781 (21), EN-48246 (22), KM-929 (23), 1870896900 / EN-46789 (24), KM-952 (25), 21-162B / 303-376 / 303-376B (26), KM-933 (27)
CODICE MOTORE	X14XE, Z14XE, X16SEJ, X16XE, X16XEL, Y16XE, Z16XE, Z16YNG, C18XEL, X18XE, X18XE1, Z18XE, Z18XEL, C20SEL, C20XE, X20XEV, Z20LEH, Z20LEL, Z20LER, Z20LET, X22SE, Y22SE, Y22XE, Z22XE, D223L, X10XE, Z10XE, Z10XEP, X12XE, Z12XE, Z14XEP, X20DTL, X20DTH, X22DTH, Y20DTL, Y20DTH, Y22DTR, 169A1.000, 955A4.000, 350A3.000, 192B4.000, 198A2.000, 350A2.000, 955A3.000, 192A8.000, 198A6.000, 198A3.000, 199B1.000, 199B2.000, 199A2.000, 199A3.000, 199A9.000, 940A3.000, 188A3.000, 939A2.000, 188B2.000, 188A8.000, 188A9.000, 323.02, 371.01, 937A2.000, 182B4.000, 182B9.000, 188A2.000, 188A7.000, 192A9.000, 186A6.000, 186A8.000, 192A1.000, 192A3.000, 192B1.000, 192A5.000, 186A9.000, 939A1.000, 199A5.000, 223A7.000, 223A9.000, 342.02, 362.02, 84TG.000, 84TH.000, 84IP.000, 939A3.000, 185A2.000, 185A6.000, Z13DT, Z13DTJ, Z13DTH, Z19DT, Z19DTH, Z19DTJ, Z19DTL, X10XE, Z10XE, Z10XEP, Z12XE, Z14XEP, X16S2R, Z16SE, 4EC1/T, 4EC1, 4EE1/T, 4EE1, X17DT, Y17DT, Y17DTI, Y17DTL, 16DA, 17D, 17DR/X, 7DTL, X17DTL, 4JX1/4, JG2T, 4FC1/T, 4FD1, X20DTL, Y20DTL, D223L Z20DMH, Z20DM, RA420, Z20S1, 194A1.000, Z22SE, Z22YH

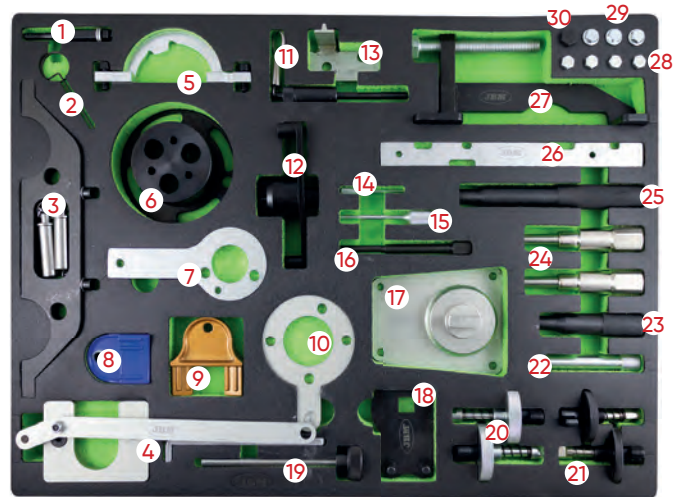

53771

158,00€

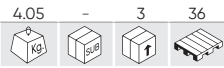

MODULO DI REGOLAZIONE CINGHIA DENTATA PER FIAT/FORD/CITROËN/PEUGEOT

<p>MODELLO</p>	<p>FIAT: ULYSSE, SCUDO, DUCATO LANCIA: ZETA, PHEDRA FORD: FIESTA, FUSION, FOCUS, FOCUS C-MAX CITROËN: C15, C1, C2, C3 PLURIEL, C4, C4 PICASSO, C5, C6, C8, DS3, DS4, DS5, XANTIA, XSARA, XSARA PICASSO, EVASION, BERLINGO, JUMPY, JUMPER, SAXO, ZX, XM, EVASION, AX PEUGEOT: 107, 1007, 206 CC, 207, 208, 306, 307 CC, 308, 406, 407, 508, 607, 806, 807, PARTNER, EXPERT, BOXER, 206, 106, 605, 205, 405</p>	
<p>UTENSILI OEM</p>	<p>4200-TH (1), 0117-AR (2), 0188-X (3), 0606-A1.A2 (4), 0188-Q2 (5), 0189-S1 (6), 7017-TR (7), 0132-P / 4507-TL (8), 0189-C (9), 0188-J1 (10), 0188-J2 (11), 0178-E (12), 0189-R (13), 0132-AK / 0188-AK / 0189-K / 0153-AK / 4533-TAD / MOT 1436 (14), 0188-AH (15), 0189-S2 (16), 0153-AB / 9041-TZ (17), 0153-M / 0178-C / 0178-D / 7014-TM / 9767-94 (18), 0189-A (19), 4527-TS1 (20), 0153-AB / 9041-TZ (21), 0189-B / 21-163 (22), 0132-AJ1 / 0153-G / 0188-M / 0189-J / 4533-TAC1 / 5711-TA (24), 0189-L (25), 0188-D / 7017-TM (26), 0132-X / 0188-Q1 / 4507-TJ / 9767-89 (27), 0194-B (28), 0132-AB / 0194-A (29), 0194-C / 21-262 / 303-734 (30), 4527-TS2 (31), 0188-E (32), 0153-A / 6012-T / 9765-54 (33), 0134-AF / 0134-Q / 0188-F / 9004-T (34), 0188-P2 / 0188-P / 174 / 7015-T (35), 0153-U 7019-T (36), 0153-N / 0188-Y / 7014-TJ / 7099-TM / 9797-34 (37)</p>	
<p>CODICE MOTORE</p>	<p>F6JA, F6JB, F6JC, G8DA, G8DB, HHDA, HHDB, HHJA, HHJB CITROËN, PEUGEOT: 1.0 / 1.1 / 1.4 / 1.6 / 1.6 16V, 1.4 / 1.6HDI / 1.8 / 1.8 16V / 2.0 / 2.0 TURBO, 1.9D / 2.0HDI / 2.2HDI / 1.8 16V / 2.0 16V TU9 (CDY/CDZ), TU1 (HDY/HDZ/HFX/HFY/HFZ), TU3 (KDX/KDY/KDZ/KFX/KFZ), TU5JP4 (NFU/NFX), TU5 (BDY/BFZ/NFT/NFV/NFW/NFY/NFZ), XU7 (LFW/LFX/LFZ), EW7J4 (RLZ), XU7JP4 (LGY), XU10 (RFL/RFU/RFW/RFX/RGX/RGY), XU10JP4 (RGX/RGY), EW10A (RFJ), EW10J4S (RFK), EW10D (RLZ), EW12J4 (3FZ), ET3JE (KFU), TU3A/JP (KFV/KFW), DV4TD (8HW/8HX/8HZ), DV4TED4 (8HV/8HY), DV6ATED4 (9HX/9HY/9HZ), EW10-CVI (RLZ), EW12 (3FZ), DW8 (WJZ/WJY), DW10 (RHY/RHV/RHZ/RHS/RHM/RHW/RHT/RHR/RHX), DW12 (4HX/4HZ/4HW/4HY), EW7J4 (6FZ), EW10J4 (RFR), EW10J4D (RLZ), DW12TED4 (4HW), DW10ATED (RHT/RHV/RHW/RHX/RHZ) FORD 1.4 / 1.6 DURATORQ TDCI</p>	

53772

229,00€

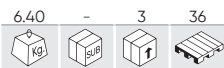

ATTREZZO DI REGOLAZIONE CINGHIA DENTATA PER FORD/VAG/MAZDA/VOLVO

<p>MODELLO</p>	<p>AUDI: 80, A1, A2, A3, S3, A4, A5, A6, TT, Q5 SEAT: AROSA, IBIZA, CORDOBA, LEON, TOLEDO, ALHAMBRA, ALTEA, INCA (99-04) SKODA: FABIA, OCTAVIA, SUPERB VW: LUPO, POLO, FOX, GOLF, BORA, JETTA, GOLF PLUS, PASSAT, BEETLE, TOURAN, SHARAN, CADDY, CADDY MAXI, TRANSPORTER, GOLF VI CABRIO, TIGUAN FORD: GALAXY</p>	
<p>UTENSILI OEM</p>	<p>T10252 (1), VAS6079 (2), T10121 (3), MP1-1312 / T10098 / T20038 / T20038 (4), T10123 (5), 23-058 / 310-084 / T10008 (6), 2065A / T10008 / U40021 (7), 3418 (8), T10171 (9), 23-059 / 23-059 / 310-085 / T10050 / T10050 (10), 3458 / T30094 (11), T10016 / T10074 / T10074 (12), T10100 (14), T10414 (15), 3366 / T20018 / T20044 (16), 3411 (17), 3369 / T30092 (18), T10341 (19), 3242 / T40069 / T30052 (20), T 40026 (21), 3359 / MP1-301 / T20102 (22), 2064 / U20003 (23), T10120 (24), MP1-1312 / T10098 / T20038 (25), T10170 (26), T00115 / T10264 / T40098 (27), T10092 (28), T00115 / T10264 / T40098 (29), 303-1054 / T10115 (30), T10060 / T10060A (31), 3359 / MP1-301 / T20102 (32), T10340 (33), 2587 (34), 3387 / U30009A (35), 3387 / T10020 (36)</p>	
<p>CODICE MOTORE</p>	<p>ARC, ATN, AUS, AVY, AZD, AFH, BCA, AJV, AKQ, AUA, AUB, AXP, AFH, AFN, AFK, AHW, AHU, APE, AQQ, AUS, AXP, AZD, BBY, BBZ, BCB, ANY, AYZ, AMF, ATL, BAY, BHC, BMS, BNM, BNV, BWB, AJM, AMG, ANU, ARL, ASZ, ATD, ATJ, AUJ, AVB, AVF, AVQ, AWX, AXB, AXC, AXR, BEW, BJB, BKC, BKE, BLS, BLT, BMT, BPX, BRB, BRM, BRR, BRU, BSU, BSV, BTB, BUK, BVK, BXE, BXF, AZV, BDJ, BDK, BGV, BHW, BKD, BKP, BLB, BMA, BMM, BMN, BMP, BMR, BNA, BPW, BRC, BRE, BRF, BRT, BUZ, BE, BVF, BVG, BVH, BWK, BTS, BMY, BLF, BWV, AZV, BKD, AWY, AZQ (55 - 64 PF), AXU, BAG, BKG, BLF, BLN, BLP, BVF, BKF, BNU, BVP, BVR, IZ, CBZA, CBZC, CBZB, CAXA, CAGA, CAGB, CAGC, CAHA, CAYA, CAYB, CAYC, CBAA, CBAB, CBAC, CBBA, CBBB, CBDA, CBDB, CBDC, CBEA, CEGA, CKUB, AZV, BDJ, BHP, BKD, BLB, BMA, BMM, BMN, BMP, BMR, BNA, BPW, BRC, BRE, BRF, BRT, BSS, BUJ, BUZ, BVA, BVE, BVF, BVG, BVH, BWA, ACV, AFB, AGX, AHD, AHY, AHY, AJT, AKE, ANJ, APA, AUF, AXG, AXG, AXL, AYC, AYM, AYY, BAU, BBE, BBF, BCZ, BDG, BDH, BFC, BJJ, BJK, BJL, BJM</p>	

KIT DI MESSA IN FASE

CARRELLO 7 CASSETTI CON MODULI DI UTENSILI SPECIALI PER KIT DI MESSA IN FASE

53951 1.794,00€

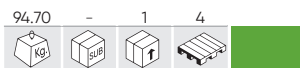

CON UTENSILI

53952 1.794,00€



CON UTENSILI

54501 1.794,00€



CON UTENSILI

54502 1.794,00€

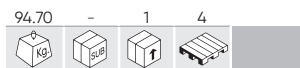

CON UTENSILI

MISURE INTERNE

CASSETTI PICCOLI (X5)

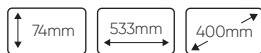

CASSETTI GRANDI (X2)



CAPACITÀ DI CARICO DEL CASSETTO: 30KG.
CAPACITÀ DI CARICO TOTALE: 70KG.

DIMENSIONI TOTALI

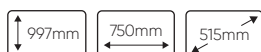

CON ATTREZZATURE EVA:

SET DI 6 MODULI KIT DI MESSA IN FASE

53775 1.109,00€

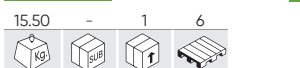

GASOLINA/PETROL

DIESEL/GASOIL

CONTIENE

REF.	Kg	Box	Box	Pallet	€
53769	5.90	-	3	36	178,00€
53770	6.15	-	3	36	198,00€
53771	4.05	-	3	36	158,00€
53772	6.40	-	3	36	229,00€
53773	6.60	-	3	36	298,00€
53774	6.95	-	3	36	190,00€

53769



RENAULT / NISSAN / OPEL / VOLVO

53770



FORD / SEAT / VOLKSWAGEN / MAZDA / VOLVO

53771



FIAT / FORD / CITROËN / PEUGEOT

53772



FORD / VAG / MAZDA / VOLVO

53773



FIAT / ALFA / LANCIA / OPEL / SUZUKI / FORD

53774



OPEL / CHEVROLET / SAAB / FIAT / LANCIA / SUZUKI / FORD

PER MAGGIORI INFORMAZIONI

PAGINA 297

ACCESSORI E RICAMBI

PAGINA 90

300 IVA esclusa



www.jbmcamp.com

LUBRIFICAZIONE / CARBURANTE

- 302 POMPE DI RIFORMIMENTO GASOLIO
- 303 POMPE DI RIFORMIMENTO UREA
- 304 POMPE DI ESTRAZIONE / RIEMPIMENTO
- 307 RACCOGLITORI DI OLIO
- 308 PISTOLE DI ASPIRAZIONE
- 309 VASCHE PER RACCOLTA D'OLIO
- 310 ALTRO



53697

398,00€

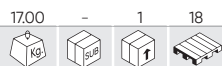
**POMPA PER IL TRAVASO DEL GASOLIO CON DOSATORE E INDICATORE (200-240 V)**

- Tensione nominale: 200-240V.
- Potenza nominale: 550W.
- Flusso massimo: 60 l/min.
- Lunghezza del cavo: 2m.
- Lunghezza del tubo flessibile di aspirazione: 2m.
- Lunghezza del tubo flessibile di pressione: 4m.

CON ARRESTO AUTOMATICORICAMBI
DISPONIBILI**53610**

294,00€

**POMPA DI DISTRIBUZIONE GASOLIO CON PISTOLA (230 V)**

- Lunghezza del tubo di alimentazione: 2 m.
- Lunghezza del tubo di uscita: 4 m.
- Elettrico.
- Fornito con pistola e tubi

CON ARRESTO AUTOMATICORICAMBI
DISPONIBILI**53609**

182,50€

**POMPA DI DISTRIBUZIONE GASOLIO CON PISTOLA (12 V)**

- Lunghezza del tubo di alimentazione: 2 m.
- Lunghezza del tubo di uscita: 4 m.

CON ARRESTO AUTOMATICORICAMBI
DISPONIBILI**54100**

265,00€

**POMPA DIESEL-ELETRICA**

- Portata: 18.4LPM (4.86GPM)
- Lunghezza del tubo di aspirazione: 850-1245mm
- Lunghezza del tubo: 2m
- Temperatura di lavoro: 5° - 40°C (41° a 104°F)
- Tensione di corrente continua: 12V
- Corrente alternata: 100-240V
- Lunghezza del cavo: 4m

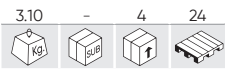

53645**POMPA ELETTRICA PER ADDITIVO UREA AUS32**

- La pompa rotativa elettrica è adatta ai lavori con fluidi a base di acqua, Urea AUS32 DEF e permette di travasare il contenuto dalle taniche IBC da 205 lt o 1000-1250 lt.
- Struttura compatta e leggera.
- Fusibile incorporatore per la protezione contro il sovraccarico e per il motore silenzioso.
- Filtro incorporato nel tubo di aspirazione, in acciaio inox, contro la penetrazione della sporcizia, il che aiuta ad evitare danni.

268,00€

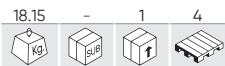
**53644****SERBATOIO PER ADDITIVO UREA AUS32 (DA 75 LT)**

- Autonomo e completamente mobile, da 75 lt, dotato di una pompa con alimentazione di 12V (permette di raggiungere la capacità di 10 lt/min con la pressione di esercizio di 40 libbre per pollice quadrato), completo di un tubo flessibile e di una valvola di intercettazione automatica.
- Il serbatoio in polietilene è compatto e resistente alla corrosione e ai raggi UV.
- Le ruote di diametro maggiorato (200mm) garantiscono un'alta manovrabilità anche su superfici non piate.

1.238,00€

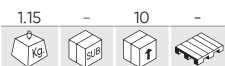
**15631****PISTOLA AUTOMATICA PER ALIMENTAZIONE D'UREA AUS32 (ART. N. 53645)**

98,00€

**52329****POMPA MANUALE IN PLASTICA ESTRAZIONE BENZINA / OLIO / AD BLUE**

- Per i fusti di 25, 50, 200L.
- 350ml pompato.
- Corpo e pistone in polipropilene.
- Manico in plastica ABS.
- Applicazioni: oli Spirits, lubrificanti, benzina, diesel, cherosene, etc.
- Linea di aspirazione: Lunghezza minima: 320 millimetri. Lunghezza massima: 900 millimetri.

36,40€

**13982**

4,00€

**ADATTATORE FILETTATO PER TAMBURI IN PLASTICA**

- Prevede la regolazione e la compensazione di diverse filettature di serbatoi, barili e pompe.



52601

397,00€

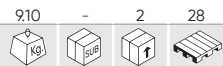

200L

POMPA DELL'OLIO

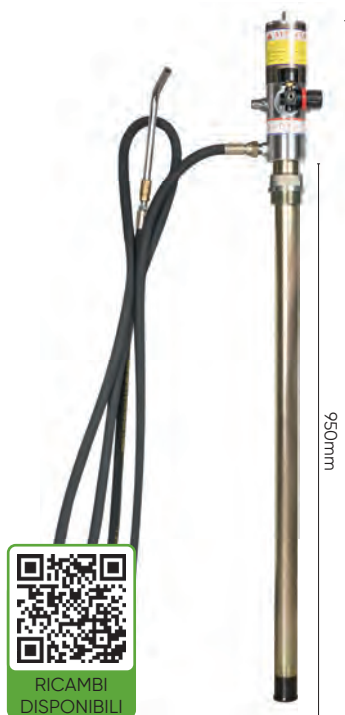

- Rapporto di pressione: 5:1.
- Entrata d'aria: 1/4".
- Uscita d'aria: 1/4".
- Pressione di funzionamento: 6-8bar.
- Pressione massima: 8 bar.
- Consumo d'aria: 250 l/min.
- Capacità relativa a 6 bar: 18 l/min.
- Range della temperatura dell'olio: -10 ~ 50°C.
- Viscosità massima dell'olio: 240 SAE.
- Lunghezza del tubo: 950 mm.

50918

341,00€



200L

POMPA DELL'OLIO

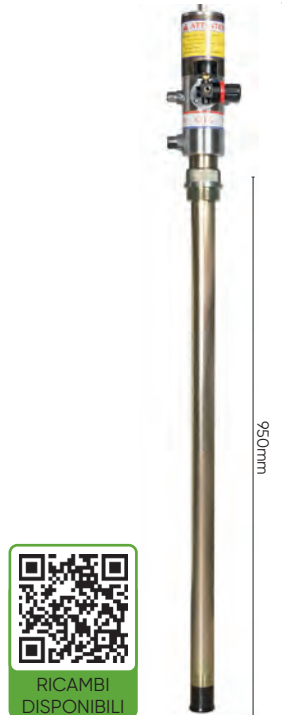

- Rapporto di pressione: 5:1.
- Entrata d'aria: 1/4".
- Uscita d'aria: 1/2".
- Pressione di funzionamento: 6 - 8 bar.
- Pressione massima: 8 bar.
- Consumo d'aria: 250 l/min.
- Capacità relativa a 6 bar: 18 l/min.
- Range della temperatura dell'olio: 10 ~ 50°C.
- Viscosità massima dell'olio: 240 SAE.
- Lunghezza del tubo metallico: 950 mm.

50935

595,00€



200L

KIT DI POMPA DELL'OLIO + TUBO + PISTOLA EROGAZIONE OLIO DIGITALE

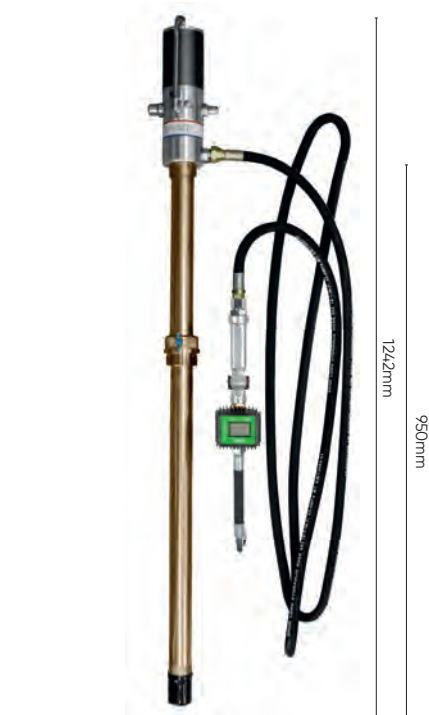

- Lunghezza del tubo flessibile: 2 m.
- Lunghezza del tubo metallico: 950 mm.
- Viscosità massima dell'olio: 240 SAE.
- Range della temperatura dell'olio: -10 ~ 50°C.
- Capacità relativa a 6 bar: 18 l/min.
- Pressione di funzionamento: 6 - 8 bar.
- Rapporto di pressione: 5:1.
- Entrata d'aria: 1/4".
- Uscita d'aria: 1/2".
- Pressione massima: 8 bar.
- Consumo d'aria: 250 l/min.

53566

32,00€

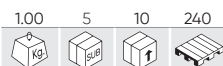

POMPA DI ASPIRAZIONE OLIO - 12V



- La presente pompa di estrazione olio è una soluzione perfetta per il cambio rapido dell'olio.
- Esso funziona collegando i suoi morsetti alla batteria del veicolo (12 V).
- L'estrazione dell'olio avviene attraverso l'apertura del tubo per asta di misurazione di livello.
- Usare la pompa di estrazione per estrarre esclusivamente oli per motori, oli diesel e oli di riscaldamento.



51253

41,00€

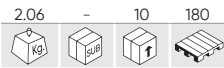

POMPA MANUALE PER L'ESTRAZIONE DELL'OLIO

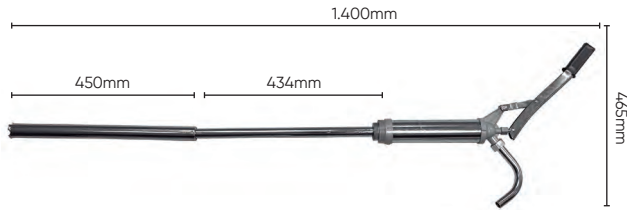

50917

271,00€

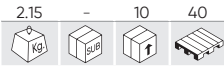

PISTOLA DI POMPAGGIO DELL'OLIO CON CONTALITRI DIGITALE

- Entrata d'aria: 1/2" BSPF
- Range di portata: 1-35 L/min
- Pressione di funzionamento: 6-8 bar
- Pressione massima di funzionamento: 100 Bar
- Range della temperatura dell'olio: -10-60 °C
- Viscosità massima dell'olio: 240 SAE
- Batteria: 2x1.5V (batteria inclusa)
- Precisione del flussometro: ±0,5%
- Ripetibilità del flussometro: 0,2%
- Tasso di scarico per rivoluzione: 25ml/R



REF. DESCRIZIONE

REF.	DESCRIZIONE	Icona	Icona	€
10000	SISTEMA DI MISURAZIONE DIGITALE PER 50917	2.10	-	7,00€

52797

198,00€

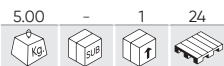

POMPA MANUALE PER CARICO SISTEMI DI TRASMISSIONE

- Capacità: 7,5L.
- Tubo: 80cc cicli.
- Campo di viscosità: SAE 140.
- Supporta il riempimento e lo svuotamento



REF. DESCRIZIONE

REF.	DESCRIZIONE	Icona	Icona	€
13234	SISTEMA DI RIEMPIMENTO DELLA POMPA DI TRASMISSIONE SENZA ACCESSORI P/52797	3.75	24	224,50€

52428

40,00€

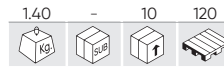

POMBA MANUALE PER ESTRAZIONE DIESEL / OLIO / AD BLUE

- Per i fusti tra 50 e 200L.
- 400ml flusso impulse.
- Capacità di pompaggio: 32L x min.
- Adattatore 2" incluso.
- Tubo di aspirazione di 101cm con 1 ingresso aria 1/4" e 1".
- Non consentito per gli acidi forti, candeggianti, uscita di benzina.
- Adatto a: oli, lubrificanti, diesel, fluidi a base di olio.
- Consigliato per: solventi, liquidi freni.



53627

22,50€

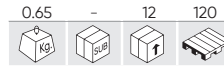

KIT DI ESTRAZIONE OLIO E CARBURANTE

1,6L

Il dispositivo è progettato e costruito per l'estrazione rapida di olio, carburante, nonché fluidi per trasmissioni/differenziali dai serbatoi dei generatori, pulitrici ad alta pressione, compressori d'aria, trattori da giardino o fuoristrada.



12044

147,00€

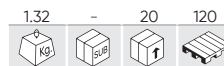

SET DI ADATTATORI PER RIEMPIMENTO SISTEMA DI POMPA DI TRASMISSIONE (15 PEZZI)

- ATF101: FORD 1/8 - 27 (NPT).
- ATF102: Universal BMW, Honda, Nissan, etc.
- ATF103: VW/Audi. Skoda.
- ATF104: VW/Audi. Porsche.
- ATF105: VW/Audi, Mini cooper M10x1.0
- ATF106: VW/Audi DSG M24 x 1.5
- ATF107: VW/Audi CVT M22x1.5
- ATF108: Mercedes M12 x 1.5
- ATF109: V/W. Skoda M18x1.5
- ATF110: Audi/VW, Skoda M30x1.5
- ATF111: Universal flexible 300mm. Honda. Hyundai. KIA...
- ATF112: Volvo 5/16 - 24 (UNF)
- ATF113: Toyota, Lexus M18 x 1.5
- ATF114: Nissan, Infinity M8 x 1.0
- ATF115: ATF-Adapter VW Passat



54290

4.307,00€

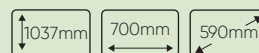

N

MACCHINA PER CAMBIO OLIO - CAMBIO AUTOMATICO

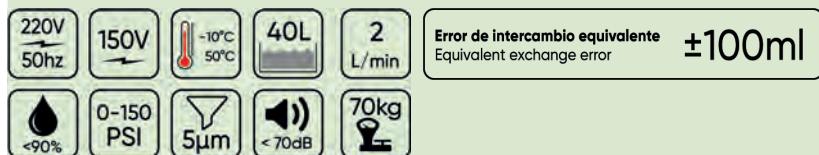

- Riempimento automatico del fluido di trasmissione
- Identificazione automatica della direzione del liquido
- Pulizia automatica
- Cambio automatico del liquido nuovo/usato.
- Visualizzazione dei livelli di pressione del liquido
- Visualizzazione accurata della temperatura del fluido
- Controllo elettronico intelligente
- Database aggiornabile
- Include adattatori per diverse marche
- Migliora le prestazioni del sistema di trasmissione automatica



VIDEO TUTORIAL



RICAMBI DISPONIBILI

54367

729,00€



SET DI ADATTATORI PER RIF.54290 (105 PZ)

CONTIENE



INFORMAZIONI TECNICHE

54050

895,00€



MACCHINA PER CAMBIO OLIO DELLE TRASMISSIONI AUTOMATICHE

- Alimentazione: 12 V (batteria dell'auto)
- Potenza della pompa: 70 W
- Diametro del manometro ad olio: 70 mm (entrambi i manometri ad olio)
- Campo di misurazione dei manometri ad olio: 0-10 bar (0-150 psi)
- Capacità del serbatoio dell'olio nuovo: 30 l
- Capacità del serbatoio dell'olio nuovo: 30 l



VIDEO TUTORIAL



RICAMBI DISPONIBILI

53874

398,00€

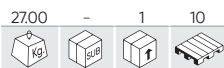

RACCOGLITORE DI OLIO 90L CON SISTEMA DI ASPIRAZIONE

90L 8-10 BAR



RICAMBI DISPONIBILI



PER CAMION / VEICOLI

- Pressione di lavoro dell'aria : 8~10 bar
- Livello di vuoto: negativo 0 ~ 0,8 bar
- Capacità del serbatoio: 70 l
- Capacità del filtro a rete per la raccolta 10 litri
- Volume del misurino: 10 l
- Velocità di aspirazione dell'olio secondo il diametro della sonda: 0,8 l/min (Ø5x3,5 mm); 1 l/min (Ø6x4,5 mm); 1,6 l/min (Ø8x6,5 mm)
- Dimensioni: 43x49x163 cm
- Mezzo: Olio per macchine e olio trasmissione.
- Temperatura dell'olio di esercizio consigliata: 40 ~ 60°C
- Con vuoto di estrazione.
- Sistema di misura dimostartivo.
- Serbatoio di grande capacità.
- Maniglia per il controllo dell'uso.
- Ruote per un facilitare il trasporto.

53873

285,00€

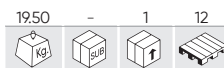

RACCOGLITORE DI OLIO 80L

80L 1-3 BAR



RICAMBI DISPONIBILI



PER CAMION / VEICOLI

- Pressione di lavoro dell'aria : 1-3 bar
- Capacità del serbatoio: 70 l
- Capacità del filtro a rete per la raccolta 10 litri
- Dimensioni: 35x48x163 cm
- Mezzo: Olio per macchine e olio trasmissione
- Serbatoio di grande capacità.
- Maniglia per il controllo dell'uso.
- Ruote per un facilitare il trasporto.
- Può essere usato per oli ad alta temperatura (senza restrizioni).

15084

68,00€

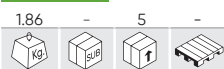

MODULO DI RIMOZIONE DEI TAPPI DEL CARTER

	x2	5/16", 3/8"		x7	8, 9, 10, 12, 13, 14, 17mm
	x7	7, 8, 10, 11, 12, 13, 14mm		x1	T45
	x1	10mm		x1	M16
	x1	10mm		x1	200mm
				x1	150mm



53215

19,00€

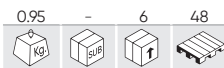

185mm Ø380mm

VASCA DI RACCOLTA ANTIGELO CAP. 18L

18L



53144

18,00€

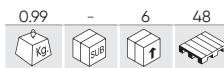

185mm Ø380mm

RACCOGLITORE DI OLIO DA 18 LT

18L



54051

39,00€

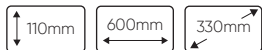
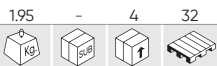

VASCHETTA DELL'OLIO 8 L

8L PE



51356

48,00€

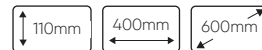

VASCA RACCOLTA LIQUIDI IN ACCIAIO

23L



52498

58,00€

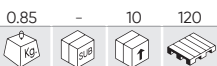

SIRINGA PLASTICA PER ESTRAZIONE OLIO



- Realizzato in polipropilene.
- Corpo trasparente.
- Adatto all'uso con olio di trasmissione e differenziale.
- Resistente al liquido dei freni e anticongelante.



TUBO FLESSIBILE

52628

26,50€



POMPA MANUALE PER ASPIRAZIONE



- Per liquido freni.
- Connettore veloce sulla punta.



TUBO FLESSIBILE

REF. DESCRIZIONE

11867 DUE O-RINGS PER REF. 52498

0.02 - 100 - 9,00€

51928

14,00€

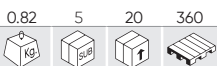

PISTOLA ASPIRAZIONE OLIO

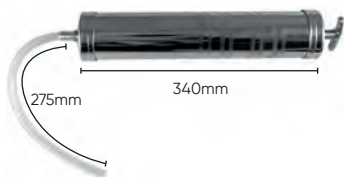

52789

15,20€



POMPA MANUALE RIMOZIONE GASOLIO



- Lunghezza del tubo: 90cm ad ogni estremità.

50924

342,00€

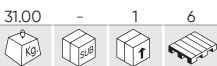

CARRELLO PORTABIDONI

200L



SERBATOI DI STOCCAGGIO PER FUSTI

52804 343,00€

14.50 - 1 5

230L 400Kg

DIBT APPROVATO
VASCA DI RACCOLTA 1 FUSTO VERTICALE

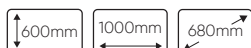

52805 426,00€

13.35 - 1 6

250L 650Kg

DIBT APPROVATO
VASCA DI RACCOLTA 2 FUSTI VERTICALI

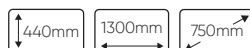

52806 742,00€

17.50 - 1 5

250L 1250Kg

DIBT APPROVATO
NON ADATTO PER TRANSPALLET
VASCA DI RACCOLTA 4 FUSTI VERTICALI



53214 285,00€

16.50 - 1 12

380mm 1310mm 910mm

VASCA DI RACCOLTA PER FUSTI SPECIALE EUROPALET 2 FUSTI

230L 650Kg

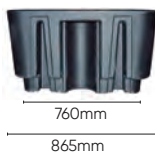

52807 1.714,00€

30.00 - 1 7

700mm 1680mm 1680mm

VASCA DI RACCOLTA - CONTAINER IBC 1.000L

1000L 2500Kg



DIBT APPROVATO



54498 6.090,00€

221.00 - 1 -

IBC HARDCOVER

Consente lo stoccaggio di contenitori IBC. Offre la massima protezione dalle intemperie per il contenitore. Con vaschetta di raccolta liquidi da 2 litri, vaschetta di ritenzione integrata e fessure di ventilazione.

CAPACITÀ DEL CONTENITORE DA 1000 LITRI: 1 UNITÀ

CAPACITÀ FUSTO DA 200 LITRI: 4 UNITÀ

CAPACITÀ DI CARICO TOTALE: 2500KG



CONTENITORE IBC NON INCLUSO

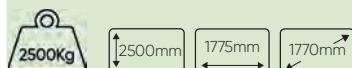

53612

96,00€

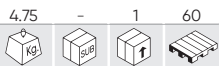

PINZA PER FUSTI (PORTATA FINO A 500 KG)



- Per gestire i bidoni di olio.
- Capacità: 500 kg.
- Impugnatura del tamburo - Tipo verticale.
- Speciale per bidoni dell'olio da 200 litri.



TANICA DI METALLO

REF.	L/mm				€
54181	5L - 550x260x350mm	1.45	4	72	25,10€
54182	10L - 570x350x425mm	2.55	4	48	34,70€
54184	20L - 760x370x500mm	4.10	4	24	44,00€



54183

38,20€



TANICA ANTIRIBALTAMENTO IN METALLO 10L

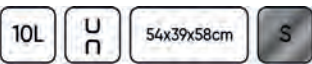

REF.	DESCRIZIONE				€	
15874	TUBO FLESSIBILE DI RIEMPIMENTO PER TANICA (REF.54181, 54182, 54183, 54184)	0.30	-	50	800	6,50€

52452

8,00€

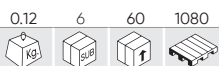

CHIAVE DI PLASTICA TAMBURO



- Materiale: Nylon.
- Anti-scintilla e anti-polvere.
- Rilievi in 3/4" e 2".
- Utile per fusti da 200L.

53078

18,00€

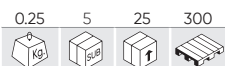

TAPPO PER BIDONE 200L



- Prevede lo svuotamento rapido di barili da 200 litri.
- Adatto per acqua, tutti i tipi di oli, alcool o chetoni, nonché per acidi poco concentrati e liquidi poco alcalini.
- Materiale: PE.
- Guarnizione EPDM.
- Molla in acciaio inox.

53518

3,50€



RUBINETTO PLASTICO DE 3/4"



- Adatto a tutti i tipi di liquidi.
- 3/4" filetto femmina".

52453

21,00€

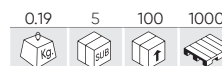

RUBINETTO DA 3/4" PER BIDONE OLIO



- Rubinetto di sicurezza.
- Filo 3/4".
- Lega e nylon.
- Applic. oli, lubrificanti, benzina, gasolio, cherosene e Urea AUS32.

52242

12,00€

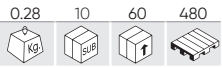

OLIATORE 500ML

500ml



52243

8,50€

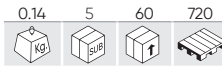

OLIATORE 0.25L

250ml

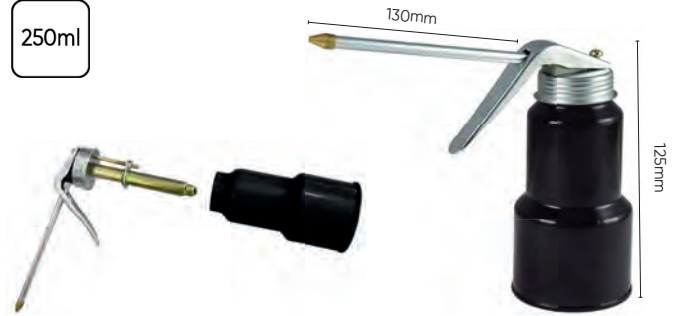

52991

10,50€

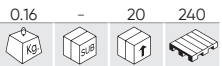

CARAFFA CON COLLO FLESSIBILE 2L

2L



52992

18,00€



CARAFFA CON COLLO FLESSIBILE 5L

5L



53187

39,00€

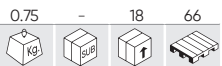

IMBUTO PER TANICA DA 200L CON COPERCHIO E FILTRO

4,5L



- Ø Interno: 245mm.
- Ø Esterno: 255mm.

53188

7,00€

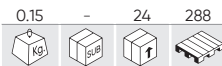

SET DI 3 IMBUTI

Ø 90,130,180mm



52391

5,00€

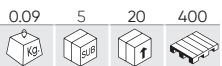

IMBUTO CON FILTRO

950ml



140x15mm



53198

9,50€

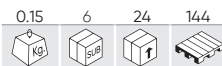

IMBUTO CON IL TUBO FLESSIBILE

1,8L



Ø 180mm



53849

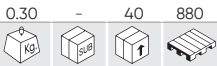

SIRINGA PER LUBRIFICAZIONE COMPATTA



16,10€

50852

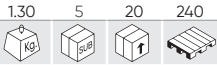

PISTOLA DI INGRASSAGGIO MANUALE CON TUBO FLESSIBILE



24,50€

50751

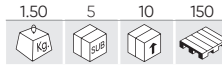

INGRASSATORE PNEUMATICO

- Ø 14mm esterno.
- Ø 5mm interno.
- Pressione: 20Mpa.



43,00€

53592

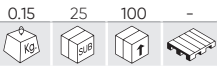

GIUNTO A INNESTO RAPIDO



25,00€

54255

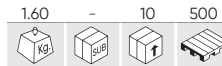

SET DI ACCESSORI PER PISTOLA INGRASSATRICE



68,00€

Si consiglia di usarlo con l'ingrassatore pneumatico JBM ref. 50751 e 50852, sebbene sia adatto all'uso nella maggior parte delle pistole.

60038

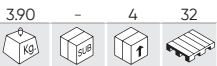

PISTOLA ELETTRICA A SIRINGA

BATTERIA NON INCLUSA.

Questo strumento è un ingrassatore per l'erogazione di grasso. Grazie all'alimentazione a batteria, l'utensile è facile da usare e da trasportare.

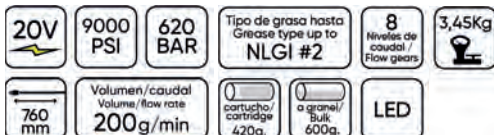

255,00€



UTENSILI IDRAULICI

- 314 MARTINETTI
- 316 SOLLEVATORI A BOTTIGLIA
- 317 MARTINETTI A CRICCHETTO
- 317 MARTINETTI TELESCOPICI
- 318 CAVALLETTI
- 318 ALTRO
- 320 TRANSPALLET
- 321 PRESSE
- 322 GRU
- 323 TAVOLI ELEVATORI
- 325 CUSCINETTI PER PONTI SOLLEVATORI



UTENSILI IDRAULICI

53725

248,00€



MARTINETTO IDRAULICO A CARRELLO 3T - SISTEMA VELOCE



MAX: 465mm
MIN: 133mm



RICAMBI DISPONIBILI

CONFORME ALLE: EN 1494:2001

50818

198,00€

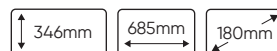

MARTINETTO IDRAULICO A CARRELLO 3,5T



MAX: 495mm
MIN: 133mm



RICAMBI DISPONIBILI

CONFORME ALLE: EN 1494:2001

53422

368,00€

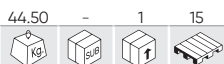

MARTINETTO IDRAULICO 3 TON CON PEDALLO DI SOLLEVAMENTO



MAX: 533mm
MIN: 100mm



RICAMBI DISPONIBILI

50815

88,00€

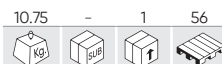

MARTINETTO IDRAULICO A CARRELLO 2T



MAX: 355mm
MIN: 130mm



RICAMBI DISPONIBILI

53112

298,00€



MARTINETTO IDRAULICO CON PEDALE



MAX: 520mm
MIN: 140mm



RICAMBI DISPONIBILI

53968

49,00€



MARTINETTO IDRAULICO A CARRELLO 2T



MAX: 300mm
MIN: 130mm



RICAMBI DISPONIBILI

CONFORME ALLE: EN 1494:2001

51895 99,00€

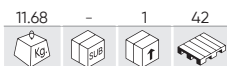

MARTINETTO IDRAULICO A CARRELLO VALIGETTA DI PLASTICA 2T



↑ MAX: 355mm
↓ MIN: 130mm



RICAMBI DISPONIBILI

50816 88,00€



MARTINETTO IDRAULICO A CARRELLO 2T SPECIALE PER AUTO CON PIANALE BASSO



↑ MAX: 340mm
↓ MIN: 90mm



RICAMBI DISPONIBILI

53421 298,00€

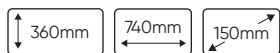

MARTINETTO IDRAULICO A CARRELLO 2T SPECIALE PER AUTO CON PIANALE BASSO



↑ MAX: 505mm
↓ MIN: 75mm



RICAMBI DISPONIBILI

54137 288,00€



MARTINETTO IDRAULICO A CARRELLO 2,5T SPECIALE PER AUTO CON PIANALE BASSO



↑ MAX: 505mm
↓ MIN: 78mm

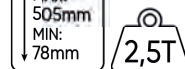

DOBPIO PISTONE

TUTORIAL DI MANUTENZIONE



MARTINETTI IDRAULICI PER VETTURE BASSE

FORNISCONO UN ADATTAMENTO OTTIMALE AI VEICOLI A BASSO PROFILO, GRAZIE ALLA LORO ALTEZZA RIDOTTA E AL DESIGN CURVO.

SOLLEVATORE A BOTTIGLIA

<p>50819 28,00€</p> <p>2.42 - 6 330</p> <p>↑ MAX: 345mm ↓ MIN: 181mm</p> <p>2T</p> 	<p>50820 34,50€</p> <p>3.20 - 6 300</p> <p>↑ MAX: 372mm ↓ MIN: 194mm</p> <p>3T</p> 	<p>50821 47,00€</p> <p>4.10 - 5 200</p> <p>↑ MAX: 413mm ↓ MIN: 216mm</p> <p>5T</p> 
<p>50822 59,00€</p> <p>5.60 - 4 200</p> <p>↑ MAX: 460mm ↓ MIN: 230mm</p> <p>10T</p> 	<p>52304 84,00€</p> <p>7.20 - 2 136</p> <p>↑ MAX: 365mm ↓ MIN: 225mm</p> <p>15T</p> 	<p>50823 94,00€</p> <p>10.18 - 2 96</p> <p>↑ MAX: 452mm ↓ MIN: 242mm</p> <p>20T</p> 
<p>50824 88,00€</p> <p>8.47 - 2 120</p> <p>↑ MAX: 355mm ↓ MIN: 190mm</p> <p>20T</p> <p>SPECIALE PER AUTO CON PIANALE BASSO</p> 	<p>50825 154,00€</p> <p>7.62 - 2 96</p> <p>↑ MAX: 465mm ↓ MIN: 285mm</p> <p>30T</p> 	

SOLLEVATORE A BOTTIGLIA CASSA PLASTICA

<p>51905 34,50€</p> <p>2.90 - 6 144</p> <p>↑ MAX: 340mm ↓ MIN: 185mm</p> <p>2T</p> 	<p>51906 39,00€</p> <p>3.53 - 4 144</p> <p>↑ MAX: 385mm ↓ MIN: 195mm</p> <p>3T</p> 	<p>51907 48,00€</p> <p>4.59 - 4 128</p> <p>↑ MAX: 450mm ↓ MIN: 215mm</p> <p>5T</p> 
---	--	---

MARTINETTO DI SOLLEVAMENTO A CRICCHETTO 3T

REF.	Min.	Max.	mm				€
53895	130mm	330mm	510x265x140	9.15	1	42	107,00€
53896	130mm	645mm	840x265x140	11.60	1	28	127,00€
53897	130mm	1045mm	1220x265x140	13.85	1	21	140,00€
53898	130mm	1320mm	1520x265x140	15.65	1	21	148,00€



ACCESSORI

REF.	DESCRIZIONE				€
15093	GIREVOLE DEL SUPPORTO RUOTA	3.65	1	50	38,00€
15094	SUPPORTO PER IL MARTINETTO	1.35	5	140	39,50€
15095	CHIAVISTELLO PER LA MANIGLIA	0.10	50	-	13,00€
15096	DISPOSITIVO DI SOLLEVAMENTO PER LA RUOTA	2.00	10	560	40,00€



IVA esclusa

54001

285,00€

28.50	-	1	20

MARTINETTO IDRAULICO TELESCOPICO DA BUCA 0,5T

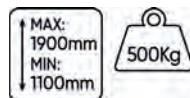

- Campo di sollevamento da 110 a 190 cm.
- Supporto in doppia posizione.
- Elevazione comoda e veloce con pedale.
- Valvola con molla per discesa controllata.
- Consente il sollevamento e il movimento di cambi, differenziali, serbatoi, ecc. sicuro e stabile.



50830

560,00€

52.10	-	1	6

MARTINETTO IDRAULICO TELESCOPICO CON PORTATA DI 0,5 T



- Con impugnatura.
- Rapido.
- Doppio idraulico.



UTENSILI IDRAULICI

SET DI 2 CAVALLETTI

REF.	DESCRIZIONE						€
53779	3T 290-430mm	5.05	-	1	72		36,00€
53845	6T 370-610mm	9.35	-	1	30		64,00€
54143	12T 500-770mm	35.50	-	1	12		249,00€



54144

198,00€



SUPPORTO DI SOLLEVAMENTO DA 1,8 TONNELLATE (1220-2146MM)

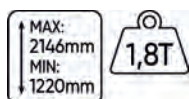

SET DI 2 MARTINETTI DA 10 TONNELLATE

REF.	DESCRIZIONE						€
54145	10T 482-775mm	37.90	-	1	4		377,00€
54146	10T 736-1212mm	2.00	-	1	4		492,00€



54144

298,00€



SET DI 2 MARTINETTI DA 22 TONNELLATE (338-500MM)

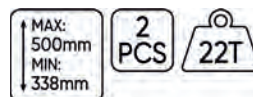

53200

69,00€

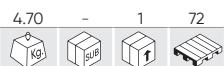

SUPPORTO DI SOLLEVAMENTO IN ALLUMINIO 3T



53218

26,00€



MARTINETTO A FORBICE 1.5T

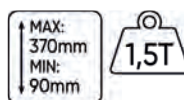

51901

999,00€

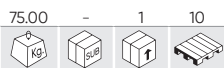

PORTARUOTE IDRAULICO CAP. 1T.



- Lunghezza: 1040 mm
- Larghezza: 1090 mm
- Altezza: 890 mm
- Campo di sollevamento: 50-100 mm
- Diametro massimo della ruota: 1320 mm

UTENSILI PER CAMION



52241

1.690,00€

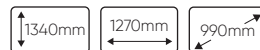
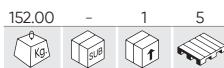

PORTARUOTE IDRAULICO 1.5TON



- Portata: 1,5 T
- Campo di sollevamento: 0-770 mm
- Lunghezza complessiva: 1270 mm
- Larghezza complessiva: 990 mm
- Altezza complessiva: 1340 mm
- Diametro massimo delle ruote: 2200 mm (86")
- Diametro minimo delle ruote: 1000 mm (39")
- Larghezza massima delle ruote: 800 mm



54257

318,00€

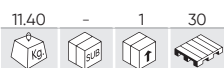

POMPA A MANO IDRAULICA

10000 PSI
3/8" NPT

PRESSIONE DI LAVORO:
- Fase 1: 0-20 kg/cm³
- Fase 2: 20-700 kg/cm³

1,8m

FLUSSO:
- Fase 1: 13 cc
- Fase 2: 2.3cc



50835

290,00€

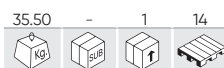

PIEGATUBI 12T



- Pressione: 0,75 - 0,75mpa.
- Piegare tubi fino a 2" (50mm).
- Barre di piegatura regolabili.
- Dimensione acc: 1/2", 3/4", 1", 1-1/4", 1-1/2", 2".

UTENSILI IDRAULICI

53880

598,00€

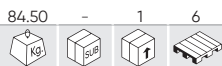

TRANSPALLET MANUALE A SOLLEVAMENTO RAPIDO

- Capacità di carico: 2500kg
- Lunghezza dello spingitore: 1150mm
- Maniglia: Quadratisch, gummiert
- Ruota sterzante (girevole): PU (200x50mm)
- Ruota fissa: Gedoppelt, PU (80x70mm)
- Altezza minima delle forche: 85mm
- Altezza massima delle forche: 200mm
- Numero di corsa del pistone della pompa: 8

SCHNELL FUNKTIONIEREND
(GUSSTAHL)



RICAMBI
DISPONIBILI

54396

2.250,00€



N

TRANSPALLET ELETTRICO



RICAMBI
DISPONIBILI



INFORMAZIONI
TECNICHE

50839

180,00€

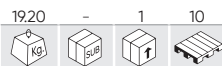

TRASPORTATORE IDRAULICO 680 KG



RICAMBI
DISPONIBILI



50923

454,00€

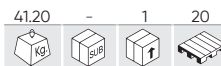

CARRELLO TRASPORTATORE SPECIALE LAMIERA



RICAMBI
DISPONIBILI



52514

84,00€

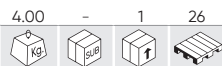

SUPPORTO SOLLEVATORE PER MOTO INDIETRO 200KG



RICAMBI
DISPONIBILI



51751

99,00€



SUPPORTO SOLLEVATORE PER MOTO POSTERIORE 200KG



RICAMBI
DISPONIBILI



53684

1.880,00€



PRESSA DA 30 TONNELLATE

- Capacità (T): 30.
- Corsa (mm): 160.
- Campo di lavoro (mm): 166-1126.
- Larghezza del telaio (mm): 540.
- Corsa laterale (mm): 200.
- Percorso: 150mm.
- Manuale e a pedale.



RICAMBI
DISPONIBILI

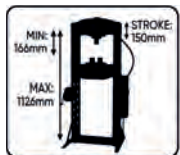

53590

1.190,00€

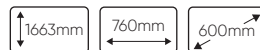
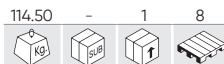

PRESSA DA 20 TONNELLATE

- Capacità (T): 20.
- Corsa (mm): 145.
- Campo di lavoro (mm): 58-1018.
- Larghezza del telaio (mm): 540.
- Larghezza interna (mm): 536.
- Corsa laterale (mm): 180.



RICAMBI
DISPONIBILI

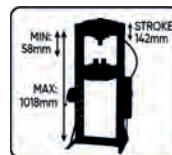

2 VELOCIDADES
2 SPEEDS



REF. DESCRIZIONE

14616 RETE DI PROTEZIONE PER LA PRESSA IDRAULICA 20 T/30 T (RIF. 53590/53684)



€

96,00€



52999

178,00€



BASE DELLA PRESSA

BASE GRANDE



BASE PICCOLA



50827

387,00€

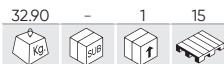

PREMIMOLLA AMMORTIZZATORE

- Capacità: 1T (2200 lbs)
- Diametro della molla compressa: 200mm
- Lunghezza di compressione: 200-500mm



50831

460,00€



PARANCO DA 2 TONNELLATE PIEGHEVOLE



RICAMBI DISPONIBILI

52985

598,00€

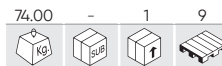

PARANCO DA 1T PIEGHEVOLE



RICAMBI DISPONIBILI

50631

68,00€

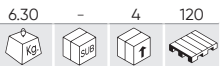

SUPPORTO ALLINEATORE DEL MOTORE 750KG



50840

138,00€

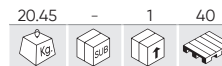

SUPPORTO PER MOTORI 500KG (1750MM)



REF.	DESCRIZIONE	3.43	1	50	€
51452	SUPPORTO PER MOTORI				69,00€

53682

98,00€

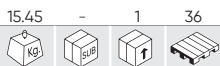

SUPPORTO PER MOTORI 500KG - (1480MM)



52055

139,00€



TRAVERSA DI SUPPORTO UNIVERSALE



50836

148,00€

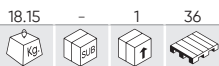

SUPPORTO PER MOTORI 340KG



50838

299,00€



SUPPORTO PER MOTORI 900KG



- Dimensioni piegato:
1000x500x440mm.



CARRELLO CON PIATTAFORMA IN ACCIAIO

54262

88,00€

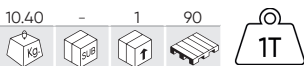

54263

130,00€



54264

240,00€

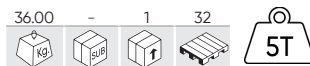

	54262	54263	54264
ALTEZZA DI SOLLEVAMENTO	2,8m	2,8m	2,8m
TIRANTE DELLA CATENA	1	2	2
MISURE DELLA CATENA		Catena di carico: 6x30mm Catena manuale: 4,5x25mm	
LUNGHEZZA		Catena di carico: 3m Catena manuale: 2,5m	
SFORZO PER IL MASSIMO CARICO	304N	310N	361N
MATERIALE		Catena di carico: Acciaio 20Mn2 Catena manuale: Acciaio Q235	



52845

170,00€

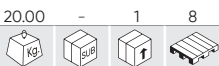

2 X RAMPA DI SOLLEVAMENTO 1 TON

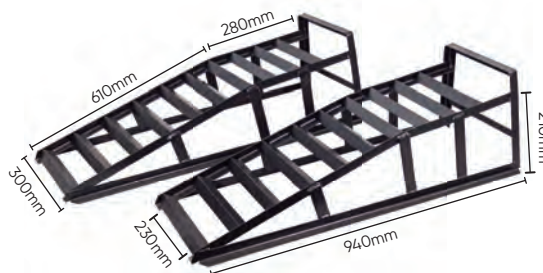
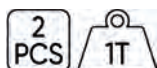

53423

199,00€

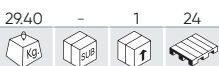

MARTINETTO ATV



RICAMBI
DISPONIBILI

53969

96,00€



SOLLEVATORE MOTOCICLETTA



54386

5.839,00€

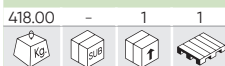

N

TAVOLA IDRAULICA PER BATTERIE PER VEICOLI ELETTRICI

Questo veicolo elettrico a forche presenta i vantaggi del sollevamento libero, della mobilità flessibile, della praticità di utilizzo, dell'estetica e dell'assenza di inquinamento. Può essere ampiamente utilizzato come piattaforma di lavoro temporanea per la movimentazione delle merci in officine, magazzini, scali merci e altri piccoli siti. È uno strumento ideale per ridurre la fatica, migliorare l'efficienza produttiva e realizzare operazioni di carico e scarico sicure.

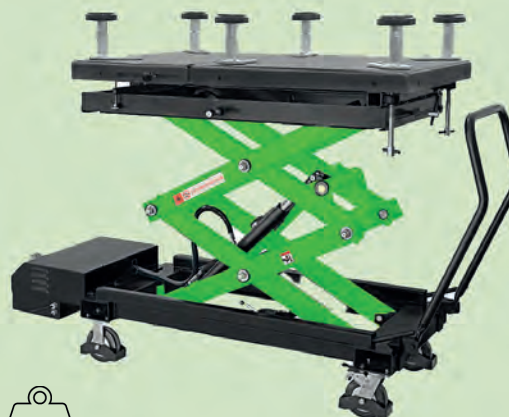

RICAMBI DISPONIBILI

Caratteristiche di caricamento	Carico distribuito
Tempo di sollevamento (senza carico)	60"
Tempo di abbassamento (senza carico)	45"
Piattaforma	1290 - 1400x768mm

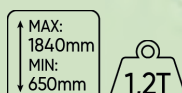

52692

129,00€



TAVOLO PER MOTOCICLETTE



50911

788,00€



TAVOLO IDRAULICO PER MOTOCICLETTE 365KG

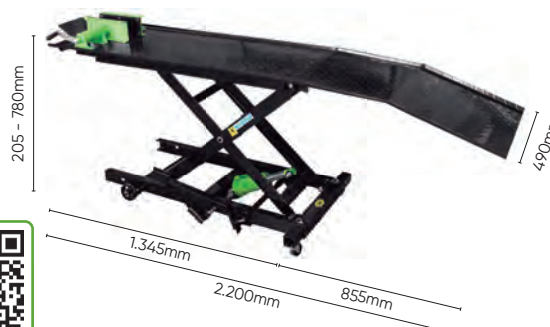

RICAMBI DISPONIBILI

53246

1.144,00€



TAVOLO IDRAULICO 360KG



50630

590,00€



TAVOLO IDRAULICO 400KG



RICAMBI DISPONIBILI

CUSCINETTO DI GOMMA PER ELEVATORE

<p>54349 8,00€</p> <p>0.48 - 68 -</p> <p>A 160mm B 120mm C 20mm</p>	<p>54350 12,50€</p> <p>0.67 - 48 -</p> <p>A 160mm B 120mm C 30mm</p>	<p>54351 14,00€</p> <p>0.97 - 32 -</p> <p>A 160mm B 120mm C 40mm</p>	<p>54352 18,00€</p> <p>1.43 - 20 -</p> <p>A 160mm B 120mm C 60mm</p>
<p>54353 23,50€</p> <p>1.85 4 12 -</p> <p>A 160mm B 120mm C 80mm</p>	<p>54354 34,50€</p> <p>2.91 - 8 270</p> <p>A 160mm B 120mm C 120mm</p>	<p>54483 14,00€</p> <p>0.70 - 40 -</p> <p>A 160mm B 120mm C 35mm</p>	<p>54484 26,00€</p> <p>1.75 - 20 -</p> <p>A 160mm B 120mm C 70mm</p>
<p>54485 36,00€</p> <p>2.40 - 8 -</p> <p>A 160mm B 120mm C 100mm</p>	<p>54355 12,00€</p> <p>0.20 - 60 -</p> <p>RAVAGLIOLI/SIRIO/SPACE A 123mm D 108mm B 26mm E 10mm C 104mm</p>	<p>54360 14,00€</p> <p>0.19 - 72 -</p> <p>RAVAGLIOLI/SIRIO/SPACE A 130mm D 125mm B 23mm E 10mm C 121mm</p>	<p>54486 9,50€</p> <p>0.10 - 120 -</p> <p>RAVAGLIOLI/SIRIO/SPACE A 100mm D 85mm B 22mm E 8,5mm C 81mm</p>
<p>54488 15,00€</p> <p>0.25 - 40 -</p> <p>RAVAGLIOLI A 150mm D 135mm B 25mm E 10mm C 128mm</p>	<p>54493 13,50€</p> <p>0.20 - 60 -</p> <p>RAVAGLIOLI A 120mm B 110mm C 27mm</p>	<p>54494 14,00€</p> <p>0.30 - 48 1152</p> <p>RAVAGLIOLI A 145mm B 135mm C 26mm</p>	<p>54357 15,00€</p> <p>0.29 - 60 -</p> <p>TWIN BUSCH A 120mm D 105mm B 30mm E 8,5mm C 100mm F 66mm</p>
<p>54358 18,50€</p> <p>0.36 - 44 -</p> <p>TWIN BUSCH A 140mm D 125mm B 25mm E 10mm C 116mm F 66mm</p>	<p>54361 14,00€</p> <p>0.25 - 52 -</p> <p>TWIN BUSCH A 140mm D 125mm B 28mm E 8mm C 120mm</p>	<p>54363 14,00€</p> <p>0.30 - 44 -</p> <p>ISTOBAL/VELYEN A 155mm D 147mm B 24mm E 6mm C 140mm</p>	<p>54365 12,50€</p> <p>0.20 - 108 -</p> <p>ISTOBAL/VELYEN A 145mm B 10mm C 60mm</p>

CUSCINETTO DI GOMMA PER ELEVATORE

54359	14,00€	54491	17,50€	54366	18,50€	54362	14,00€
0.31 - 48 1440		0.30 - 44 -		0.30 - 80 -		0.25 - 48 -	
OMCN		OMCN		NASSBAUM/AMI		CASCOS	
A 140mm		A 145mm		A 125mm D 120mm		A 138mm D 130mm	
B 133mm		B 25mm		B 24mm		B 25mm E 9mm	
C 27mm				C 90mm		C 120mm	

54487	15,00€	54495	18,00€	54496	16,50€	54497	12,50€
0.15 - 80 -		0.25 - 108 3240		0.10 - 400 2400		0.15 - 88 2700	
ROTARY		ROTARY		ROTARY		MAHA	
A 123mm D 112mm		A 125mm		A 104mm D 80mm		A 120mm D 113mm	
B 22mm E 8mm		B 15mm		B 82mm E 56mm		B 22mm E 8mm	
C 90,5mm		C 90mm		C 8mm		C 102mm F 83mm	

54492	19,50€	54356	19,50€	54364	14,00€	54489	19,50€
0.35 - 60 -		0.44 - 48 1152		0.29 - 52 -		0.35 - 28 -	
SLIFT/IME		500E/500X/ JEEP RENEGADE		LAUNCH/TWIN BUSCH/RP TOOLS		KONI/ROMERICO/CAR-O-LINER	
A 125mm D 110mm		A 55mm		A 120mm D 108mm		A 160mm D 153mm	
B 25mm E 9mm		B 100mm		B 32mm		B 29mm E 10mm	
C 120mm F 83mm				C 70mm		C 140mm	

54490	15,00€
0.20 - 88 -	
ATH/HOFMANN/ HERMANN/ J.A.B. BECKER	
A 120mm D 110mm	
B 19mm E 4mm	
C 130mm	

54175	34,00€
0.80 5 20 360	
SET DI 4 APPOGGI PER IL SOLLEVAMENTO TESLA	
NR	TESLA 3/X/S/Y



UTENSILI ELETTRICI

- 328 AVVIATORI PER VEICOLI
- 329 MANUTENZIONE DELLA BATTERIA
- 330 MISURAZIONE DELLA CORRENTE
- 332 ISPEZIONE VISIVA
- 332 SALDATURA
- 334 ATTREZZATURA DA OFFICINA
- 337 ARIA CONDIZIONATA
- 338 TERMOMETRI
- 338 ALTRO



CAVI DI AVVIAMENTO

PINZA IN OTTONE MASSICCIO

REF.	Ø CAVO	LUNGO	A	SEZIONE					€
51238	17mm	5m	700	70mm ²	4.95	-	2	84	138,00€
51239	15mm	7m	700	70mm ²	5.90	-	2	72	159,00€

PINZA IN OTTONE

REF.	Ø CAVO	LUNGO	A	SEZIONE					€
52069	11mm	2,5m	250	25mm ²	1.55	-	10	240	29,50€
52070	12mm	3m	350	35mm ²	1.95	-	5	160	40,00€
52071	13mm	3m	500	50mm ²	2.35	-	5	90	47,00€

PINZA IN OTTONE MASSICCIO CON PROTEZIONE DI SOVRACCARICO

REF.	Ø CAVO	LUNGO	A	SEZIONE					€
51363	12mm	3m	350	35mm ²	2.63	-	5	120	114,00€
51365	12mm	3m	600	50mm ²	3.10	-	5	90	118,00€



REF.	DESCRIZIONE					€
14145	FASCETTE PER CAVI DI AVVIAMENTO IN RAME	0.20	-	30	-	8,50€
14146	FASCETTE PER CAVI DI AVVIAMENTO IN RAME	0.20	-	30	1920	8,00€
14147	PINZA OTTONE	0.35	-	15	-	25,00€
14148	PINZA OTTONE	0.35	-	15	-	25,00€

53687

298,00€

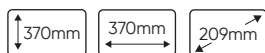
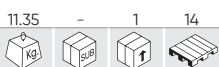

AVVIATORE DI EMERGENZA PER AUTO 12V

- Tensione: 12V.
- Batteria: 22Ah, piombo-acido (1 pz.)
- Corrente di spunto: 750A.
- Corrente di picco: 1500A.

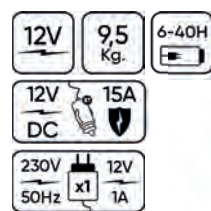

RICAMBI DISPONIBILI

- A MISURATORE DI TENSIONE DELLA BATTERIA INTERNA
- B PULSANTE DI CONTROLLO DELLA TENSIONE DELLA BATTERIA INTERNA
- C INTERRUTTORE ON / OFF
- D LUCE A LED INTEGRATA: AMPLIA LA VISIBILITÀ DELL'AREA DI LAVORO

53688

495,00€

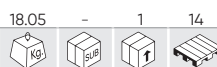

AVVIATORE DI EMERGENZA PER AUTO 12/24V

- Tensione: 12V/24V.
- Batteria: 22Ah al piombo-acido (2 pz.)
- Corrente di avviamento: 12V: 1500A/3000A.
- Corrente di picco: 24V: 750A/1500A.
- Tempo di ricarica della batteria:
Carica completa della batteria: 40 h
Carica fino al 10-20 %: 6 ore

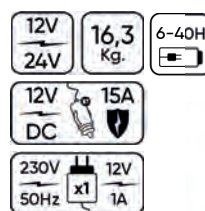

RICAMBI DISPONIBILI

- A MISURATORE DI TENSIONE DELLA BATTERIA INTERNA
- B PULSANTE DI CONTROLLO DELLA TENSIONE DELLA BATTERIA INTERNA
- C INTERRUTTORE ON / OFF
- D LUCE A LED INTEGRATA: AMPLIA LA VISIBILITÀ DELL'AREA DI LAVORO

51816 58,00€



TESTER DIGITALE PER BATTERIE

- 150Ah.
- Per batterie da 12 V.
- Misurazione in SAE CCA), EN, IEC, DIN, CA.
- Range: 200 ~ 1200 CAA (SAE).
- Misuratore di Volt: 7 V ~ 15 V.
- Display 4+3 Leds (verde, rosso, giallo).



51235 49,00€



TESTER PER BATTERIE

- Per batterie da 6 V e 12 V.
- Carica di sino a 100 Ah.
- Test dello stato di carica.
- Test di consumo all'avviamento.
- Test di voltaggio di carica.
- Test delle condizioni della batteria.



52884 73,00€



DEPOSITO DI MEMORIA PER LA SOSTITUZIONE DELLE BATTERIE



- Utile per mantenere la corrente al sistema elettrico del veicolo durante la sostituzione della batteria.
- Connessione via cavo OBDII o presa accendisigari.



53209 8,50€



IDROMETRO PER BATTERIA

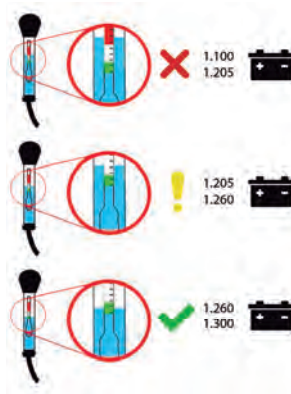

CARICABATTERIE

Compatibile con Batterie al piombo-acido: batterie a liquido, ad elio, MF e AGM

53927 66,00€



100V 240V	60W	50-60 HZ
72 VDC 0.9-3.6A	0°C 40°C	
6V 7.2V	12V 14.4V	NORM
6V 7.4V	12V 14.7V	COLD/AGM



53929 95,00€



100V 240V	150W	50-60 HZ
14.7 VDC 3.6-7.2A	-20°C 40°C	
12V 14.4V	24V 28.8V	NORM
12V 14.7V	24V 29.4V	COLD/AGM



52233

328,00€



TESTER DIGITALE PER BATTERIE E ALTERNATORI CON STAMPANTE

- Per batterie da 6V e 12V.
- Sistema di carico e avviamento da 12V e 24V.
- Range: 40 - 2000 CCA (SAE).
- Misuratore di volt: 1.5V - 30V.
- Set di cavi da 180cm.
- Include:
- 1 rotolo di carta termica 57mm x 30m.



AGM, GEL, VRLA, SLI



54040

240,00€



TESTER BATTERIA CON FUNZIONE DI STAMPA

- Applicabile a batterie da 12 V, AGM (mat di vetro assorbente), GEL (di gel), VRLA (ermetizzato di piombo-acido), SLI (con elettrolito liquido).
- Range operativo: 100-2.000 di corrente di avviamento a freddo CCA (SAE)
- Lingue del sistema disponibili: Spagnolo (ES), Inglese (EN), Francese (FR), Tedesco (DE), Italiano (IT), Portoghese (PT), Rumeno (RO)
- Applicabile ai sistemi di avviamento 12/24 V.
- Applicabile a batterie da 12 V, AGM (mat di vetro assorbente), GEL (di gel), VRLA (ermetizzato di piombo-acido), SLI (con elettrolito liquido).
- Tester per starter e generatori.
- Include: Una batteria CR2032



REF.	DESCRIZIONE				€
51842	CARTA TERMICA PER STAMPANTE REF. 52233-54040	0.10	6	72	6,90€

54256

48,00€



AUTO PROTEZIONE DA SOVRACCARICO 12/24V

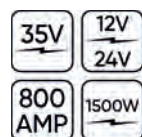

52231

49,00€

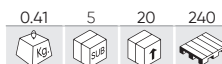

KIT DI ACCESSORI PER MULTIMETRO

- Questo kit è adatto per quasi tutti di multimetri.

- CONTIENE**
- 2 sonde.
 - 2 pinze piccole
 - 2 pinze lunghe.
 - Cavi d'estensione.



54114

248,00€

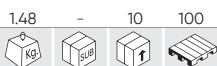

MISURATORE DI ISOLAMENTO

Categoria d'installazione:	2
Categoria di misura:	CAT III
Altitudine:	fino a 2000 metri
Display	LCD con doppio display
Tensione CA:	0 - 750V
Tensione CC:	0 - 1000V
Resistenza:	0 - 200Ω / 200 - 2000 Ω
Resistenza di isolamento:	0 - 200MΩ / 200 - 2000 MΩ
Frequenza di campionamento:	2,5 volte al secondo
Azzeramento:	regolazione automatica
Temperatura di esercizio:	00 - 400C (320F - 1040F), umidità relativa inferiore all'80%

Temperatura di conservazione:	-100C - 600C (140F - 1400F), umidità relativa inferiore al 70%
Fonte di alimentazione:	DC9V (6 batterie "AA" da 1.5V)
Dimensioni (lunghezza x larghezza x altezza):	200 x 92 x 50mm

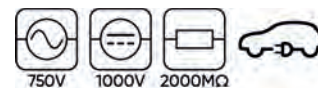

50942

28,00€

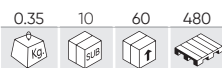

MULTIMETRO DIGITALE

- Caratteri 3" 1/2.
- Misurazione: 2000.
- Dati istantanei.
- Spegnimento automatico.
- Indicatore livello di carica della batteria.
- Batteria da 9 V.
- Sonda della temperatura.
- Temperatura: da -40 °C a 1000 °C.



V AC	200mV, 2V, 20V, 200V, 1000V	A AC	20mA, 200mA, 20A
V DC	200mV, 2V, 20V, 200V, 750V	A DC	20mA, 200mA, 20A
Ω	200Ω, 2KΩ, 20KΩ, 200KΩ, 2MΩ, 20MΩ, 2000MΩ	F	2nF, 20nF, 200nF, 2μF, 20μF, 200μF

52439

227,00€



KIT DI CAVI E ACCESSORI

- 2 misurazione della resistenza variabile.
- Controllare due luci LED.
- 2 SRS sostituzione e dispositivi di test.
- 2 pinze cocodrillo.
- 2 prese attacco rapido.
- 4 sensori.
- 24 connettori circolari.
- 48 connettori piatti.



52382

19,50€

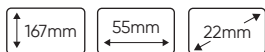
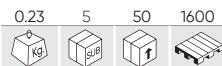

MULTIMETRO CON PINZA AMPEROMETRICA

- Massimo valore sul display: 1999, indicazione di polarità automatica.
- Temperatura funzionamento: 0°C a 40°C, umidità <80%RH.
- Temperatura di stoccaggio: -10°C a 40°C, umidità <85%RH.
- Alimentazione: 2 batterie tipo AAA.
- Indicatore di batteria scariche.
- Electricità statica: circa 4mA.
- Metodo di misura: doppio.
- Interruttore integrato AC/DC.



DCB	600V	- FUNZIONI: Test filo vivo.
ACB	600V	
DCA	-	
ACA	20A, 200A, 600A	
OHM	2KΩ, 200KΩ, 2MΩ	

52952

74,00€

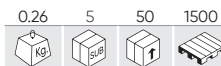

MULTIMETRO CON PINZA AMPEROMETRICA PROFESSIONALE

- Massimo valore sul display: 1999, indicazione di polarità automatica.
- Temperatura funzionamento: 0°C a 40°C, umidità <80%RH.
- Temperatura di stoccaggio: -10°C a 40°C, umidità <85%RH.
- Alimentazione: 2 batterie tipo AAA.
- Indicatore di batteria scariche.
- Electricità statica: circa 4mA.
- Metodo di misura: doppio.
- Interruttore integrato AC/DC.



DCB	20V, 600V	- FUNZIONI: Test filo vivo. Prova diodi.
ACB	600V	
DCA	200A	Prova continuità, Funzione ADP.
ACA	200A	Funzione rilevazione di fase.
OHM	2000Ω	Pulsante ZERO.

53028

5,80€

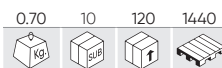

TESTER CIRCUITO AUTOMOTIVE 1,8X190MM

6-12-24V
1,8 x 190mm



- Adatto per il controllo della polarità.

53029

6,80€

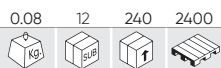

TESTER CIRCUITO AUTOMOTIVE 2X115MM

6-12-24V
2 x 115mm



53030

12,00€



TESTER CIRCUITO AUTOMOTIVE 3X142MM

6-12-24V
3 x 142mm
LED



53724



ENDOSCOPIO CON WIFI

- Un endoscopio che ha la funzione di trasmettere immagini tramite Wi-Fi. Possibilità di connettersi a qualsiasi smartphone. Compatibile con tablet o computer.

- Componenti inclusi nella fornitura:
Camera endoscopica.
Trasmettitore Wi-Fi.
Insero a gancio.
Insero magnetico.
Insero a specchio laterale.

CAVO SEMIRIGIDO DA 1M



Funziona con l'APP JBM:



615,00€

53484

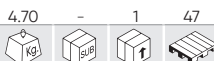

RILEVATORE DI FUGHE DI GAS

- OLIO NO INCLUSO.



CONTIENE



RICAMBI DISPONIBILI

53977

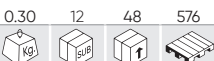

SALDATORE 40W

17,50€



- Tensione 220-240 V
- 40 W
- Frequenza: 50Hz
- Lunghezza: 240 mm
- Cavo: 1.3 m
- Temperatura massima di lavoro: 450°+/-10%



53111

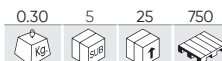

PISTOLA SALDATRICE A STAGNO 100W

19,00€



- Voltaggio: 220-240V.
- Temperatura.: 420°C +/- 10%.
- Lunghezza: 250mm.
- Cavo: 1,5m.



53145



PISTOLA DA ARIA CALDA 2000W

39,20€

- 220V-240V.
- 50Hz-60HZ.
- 2000W.
- Temperatura di uscita: 50-600°C.
- Flusso d'aria: 220-480L / min.
- 2 Opzioni di temperatura: 300 i 600.



53162



PISTOLA DA ARIA CALDA DIGITALE 2000W

60,00€

- 220V-240V.
- 50Hz-60HZ.
- 2000W.
- Temperatura di uscita: 100-600°C.
- Flusso d'aria: 280-480L / min.



53981

143,00€

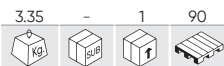

APPARECCHIO PER SALDATURA MANUALE AD ARCO ELETTRICO CON INVERTITORE DI CORRENTE CONTINUA 100A

CONTIENE

Porta elettrodo con cavo da 2 m.
 Presa di terra con cavo da 1,5 m.
 Spazzola a martello.
 Visiera manuale.

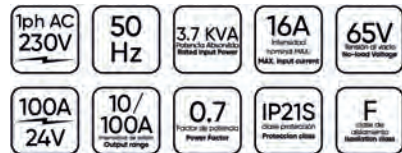

- ✓ INVERTITORE CON TECNOLOGIA IGBT
- ✓ SALDATURA AD ARCO MANUALE CON CORRENTE CONTINUA
- ✓ PROTEZIONE DA BRUCIATURA
- ✓ POTENZA ARCO
- ✓ ACCENSIONE AD ARCO CALDO



53982

219,00€



APPARECCHIO PER SALDATURA MANUALE AD ARCO ELETTRICO CON INVERTITORE DI CORRENTE CONTINUA 160A

CONTIENE

Porta elettrodo con cavo da 2 m.
 Presa di terra con cavo da 1,5 m.
 Spazzola a martello.
 Visiera manuale.



- ✓ INVERTITORE CON TECNOLOGIA IGBT
- ✓ SALDATURA AD ARCO MANUALE CON CORRENTE CONTINUA
- ✓ PROTEZIONE DA BRUCIATURA
- ✓ POTENZA ARCO
- ✓ ACCENSIONE AD ARCO CALDO



53414

49,00€



CASCO PER BRASATURA CON REGOLATORE MANUALE



REGOLATORE ANALOGICO PER LA REGOLAZIONE DELLA SENSIBILITÀ E DELL'OSCURAMENTO

53415

188,00€



CASCO PER BRASATURA CON REGOLATORE DIGITALE



REGOLATORE DIGITALE

QUADRATO MAGNETICO 45°, 90°, 135°

REF.	←→					€
54111	75mm	0.35	10	40	1680	4,75€
54113	100mm	0.60	10	20	1100	7,65€



54482



677,00€

N

PULITORE AD ULTRASUONI 30L

Questa macchina consente di pulire i pezzi emettendo ultrasuoni. È particolarmente indicata per la pulizia di parti con forme complesse.



POTENZA ULTRASONICA: 600W	ALIMENTAZIONE: 200~240V (50HZ)
POTENZA DI RISCALDAMENTO: 500W	NUMERO DI TRASDUTTORI: 10
CAPACITÀ SERBATOIO: 30L	RISCALDATORE: 0~80°C
FREQUENZA ULTRASONICA: 40KHZ	MATERIALE: ACCIAIO INOX SUS304
TIMER: 1~30 MIN.	DIMENSIONI DEL SERBATOIO: 500x300x200mm

53220



260,00€

PULITRICE PORTATILE

- FORMATO PORTATILE.
- Permette la chiusura a tenuta stagna per evitare perdite durante il trasporto.
- Usare con solvente a base acquosa.
- Interruttore di accensione laterale.
- Filtro di pulizia liquido incluso.
- Supporto flessibile per utensili e tubo incluso.
- Scomparto di stoccaggio.
- Separazione delle aree di lavoro, area di pulizia e zona di asciugamento, consente di lavorare con più pezzi alla volta.

- Capacità massima: 27,5 litri.
- Capacità di pompaggio: 1.000 L / h.
- Capacità di lavoro: 20L.
- Collegamento a 220V.
- Tubo di 1,10 m.



MOLA ELETTRICA

REF.	W	V/W	RPM	HZ	Ø	Ø	Ø					€
53656	450W	230V/450W	2950RPM	50Hz	Ø 150mm	Ø 20mm	Ø 12,7mm	11.05	-	1	50	198,00€
53657	600W	230V/600W	2950RPM	50Hz	Ø 200mm	Ø 25mm	Ø 15,88mm	16.35	-	1	24	248,00€
53658	250W	230V/250W	2950RPM	50Hz	Ø 150mm	Ø 20mm	Ø 12,7mm	6.95	-	1	60	99,00€
53659	250W	230V/250W	2950RPM	50Hz	Ø 150mm Ø 200mm	Ø 20mm Ø 40mm	Ø 12,7mm Ø 20mm	9.70	-	1	15	121,00€



53656
53657



53658



53659

52195



170,00€

MOLA ELETTRICA 150MM

- Potenza nominale di entrata: 250W.
- Tensione nominale: 230V / 50Hz.
- Velocità senza carico: 2.950rpm.
- Ø della ruota: 150 x 20 x 12.7mm.



53660



146,00€

BASE IN ACCIAIO PER AFFILATRICE

- Altezza: 790mm.
- Dimensioni della piastra di fissaggio: 250x280mm.



54342 858,00€

49.50 - 1 4

MACCHINA LAVAPEZZI CON TERMOSTATO

70-120 PSI 0,8 L/min
 MAX 50°C 8-14L
 5 CFM

740mm 560mm 452mm

1710mm 790mm 610mm

Macchina progettata per il lavaggio perfetto delle parti sporche. Include una pistola pneumatica per la pulizia con solvente e può essere utilizzata anche per asciugare le parti utilizzando l'aria compressa.

Grazie alla cabina chiusa, l'operatore è completamente protetto dagli schizzi e dall'odore del solvente. Dispone di un termostato con il quale è possibile regolare il livello di temperatura del liquido detergente e la luce all'interno del serbatoio, per una maggior visione.

RICAMBI DISPONIBILI

54341 643,00€

51.00 - 1 7

SABBIATRICE 220L

100V 40-120 PSI
 240V
 15-25 PSI 33L

860mm 560mm 560mm

390mm 905mm 632mm

Questa sabbia-trice è facile da usare, portatile e offre un ambiente sicuro, pronta per l'uso con i mezzi abrasivi di tua scelta con la possibilità di pulire le seguenti parti: parti arrugginite, macchie ecc.

RICAMBI DISPONIBILI

52980 480,00€

45.00 - 1 4

PULITRICE DI PEZZI 150L

150L

MISURE TOTALI: 890mm x 1.090mm x 520mm

MISURE INTERNE DELLA VASCA: 270mm x 1.060mm x 490mm

RICAMBI DISPONIBILI

50632 298,00€

24.20 - 1 6

PULITRICE DI PEZZI

100L

MISURE TOTALI: 890mm x 780mm x 540mm

MISURE INTERNE DELLA VASCA: 260mm x 725mm x 490mm

RICAMBI DISPONIBILI

- Flusso: 25L.
 - Funziona con soluzioni detergenti per motori idrosolubili.

- Flusso: 25L.
 - Funziona con soluzioni detergenti per motori idrosolubili.

51837

195,00€

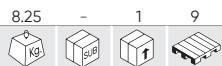

ASPIRATORE SECCO DA 30 LITRI

30L

Volume (l)	30
Volume di aspirazione al secondo (l/s)	26
Potenza	1x1.200W
Tensione	230V
Frequenza	50Hz
Aspirazione	> 17Kpa
Ø tubo flessibile	32mm
Lung. Del tubo flessibile	1,5m
Lunghezza del cavo	4,5m
Guarnizione	IPx4



RICAMBI DISPONIBILI

CONTIENE



* Questo aspirapolvere ha un sistema che permette un'accensione automatica se è collegato a una levigatrice.

51838

667,00€



ASPIRATORE DA 80 LITRI (SECCO - UMIDO)

80L

Volume (l)	80
Volume di aspirazione al secondo (l/s)	50
Potenza	3x1.000W
Tensione	230V
Frequenza	50Hz
Aspirazione	> 20Kpa
Ø tubo flessibile	48mm
Lung. Del tubo flessibile	2m
Lunghezza del cavo	4,5m
Guarnizione	IPx4



RICAMBI DISPONIBILI

CONTIENE



53947

145,00€

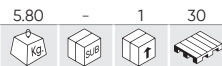

IDROPULITRICE AD ALTA PRESSIONE 1400 W

230V	1400W	MAX 105 Bar	MAX AGUA WATER 50°C	5,0Kg
MAX 6,8L/min	5m	3m	50 Hz	IP X5

CONTIENE



RICAMBI DISPONIBILI

- A PISTOLA A SPRUZZO
- B CAVO DI ALIMENTAZIONE
- C SCARICO DELL'ACQUA
- D TUBO FLESSIBILE AD ALTA PRESSIONE

53948

324,00€

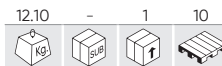

IDROPULITRICE AD ALTA PRESSIONE 2400 W

230V	2400W	MAX 180 Bar	MAX AGUA WATER 50°C	10,0Kg
MAX 8L/min	5m	8m	50 Hz	IP X5

CONTIENE



RICAMBI DISPONIBILI

- A TUBO FLESSIBILE AD ALTA PRESSIONE
- B PISTOLA A SPRUZZO
- C SCARICO DELL'ACQUA
- D CAVO DI ALIMENTAZIONE

53189 128,00€

7.10 - 1 12

1325mm 480mm Ø565mm

VENTILATORE A PIANTANA

230V 50 Hz
120V Hz

X3 SPEED RPM 1050/1150/1300 CFM 2700/3000/3400



54125 152,00€

8.25 - 1 14

1250mm 400mm Ø430mm

VENTILATORE SPRUZZATORE D'ACQUA

3,2L 75W
220V 50 Hz
240V Hz
0.5-7.5H motor de cobre/ copper engine
mando/remote

QR CODE
RICAMBI DISPONIBILI



53543 13,80€

0.75 5 20 160

VENTILATORE PER AUTO - 12 V

Icons for car, bus, and truck use.

12V 15,20cm

X2 VELOCITÀ



53190 98,00€

6.10 - 1 16

575mm 230mm Ø620mm

VENTILATORE DA TAVOLO

230V 50 Hz
120V Hz
X3 SPEED RPM 1050/1150/1300 CFM 2700/3000/3400



54229 48,00€

1.76 - 4 80

RADIATORE DA 2KW

2Kw 220V 240V 1000-3000 RPM 20m²
SPCC PTC 197m³/h 210-160 -217mm



54229
54230

54230 68,00€

3.10 - 1 56

RADIATORE DA 3KW

3Kw 220V 240V 1000-3000 RPM 30m²
SPCC PTC 197m³/h 210-160 -217mm

54231 138,00€

4.80 - 1 27

RADIATORE DA 5KW

5Kw 380V 400V 1000-3000 RPM 48m²
SPCC PTC 588m³/h 300-235 -345mm
1,4m

54231
54232

54232 248,00€

7.90 - 1 12

RADIATORE DA 9KW

9Kw 380V 400V 1000-3000 RPM 80m²
SPCC PTC 1180m³/h 395-307 -455mm
1,4m



UTENSILI ELETTRICI

52162

38,00€



TERMOMETRO LASER -50°C A 550°C



52450

105,00€

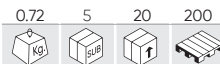

TERMOMETRO LASER -50° ~1000°



53503

12,00€

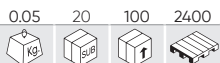

TERMOMETRO A CONTATTO DIGITALE

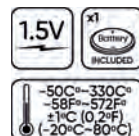

53585

168,00€



AVVOLGITORE DI CAVO ELETTRICO

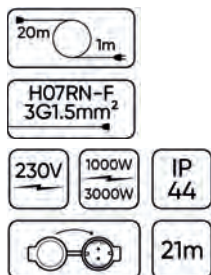

53586

168,00€

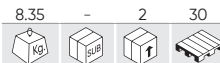

AVVOLGITORE DI CAVO ELETTRICO 21M

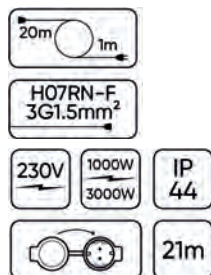

REF. DESCRIZIONE

14771 STAFFA A PARETE PER AVVOLGITUBI RIF. 53532, 53581, 53585, 53586

0.35 - 30 - 10,50€

53584

119,00€



AVVOLGITORE DI CAVO ELETTRICO - 12M

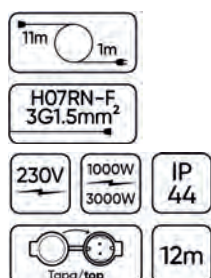

53526

119,00€



AVVOLGITORE DI CAVO ELETTRICO 12M

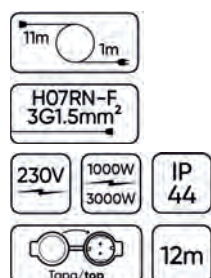

REF. DESCRIZIONE

14774 STAFFA A PARETE PER AVVOLGITUBI RIF. 53526, 53584

0.40 - 10 - 10,50€

51831 **24,00€**

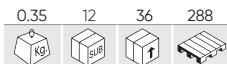

PISTOLA PER ADESIVO TERMOFUSIBILE

- Voltaggio: 100 ~ 230 V.
- Temperatura: 190 ~ 230 °C.
- Consumo: 60 ~ 150 W.
- Diametro beccuccio: 2,0 ~ 2,3 mm.
- Range: da 8 a 16 g di prodotto/minuto.



REF.	DESCRIZIONE					€
51859	BLISTER 10U ADESIVO TERMOFUSIBILE PER REF. 51831	0.12	8	32	1520	3,80€

51033 **98,00€**



AVVOLGITORE DI CAVO ELETTRICO 25M



- Protezione da sovraccarico.
- Protezione infantile.



PROLUNGA ELETTRICA LINEARE

REF.	m					€
53166	3m	0.45	5	30	600	10,50€
53167	5m	0.65	5	20	600	12,50€
53168	10m	1.20	-	10	300	19,00€



52643 **596,00€**



MACCHINA PER MARCARE LO PNEUMATICO

REGOLABILE DIGITALMENTE

REF.	DESCRIZIONE				€
11974	RICAMBI R1 PER MACCHINA PER MARCARE IL PNEUMATICI REF. 52643	0.01	20	500	1,80€
11975	RICAMBI R2 PER MACCHINI PER MARCARE IL PNEUMATICI REF. 52643	0.01	20	500	1,80€
11976	RICAMBI R3 MACCHINA PER MARCARE IL PNEUMATICI REF. 52643	0.01	20	500	1,80€
11977	RICAMBI R4 MACCHINA PER MARCARE IL PNEUMATICI REF. 52643	0.01	20	500	1,80€
11978	RICAMBI R5 MACCHINA PER MARCARE IL PNEUMATICI REF. 52643	0.04	20	100	1,80€
11979	RICAMBI W1 PER MACCHINA MARCARE IL PNEUMATICI REF. 52643	0.04	20	500	1,80€
11980	RICAMBI W2 PER MACCHINA MARCARE IL PNEUMATICI REF. 52643	0.04	20	500	1,80€
11981	RICAMBI W3 PER MACCHINA MARCARE IL PNEUMATICI REF. 52643	0.01	20	500	1,80€
11982	RICAMBI W4 PER MACCHINA MARCARE IL PNEUMATICI REF. 52643	0.01	20	200	1,80€
11983	RICAMBI W5 PER MACCHINA MARCARE IL PNEUMATICI REF. 52643	0.04	20	500	1,80€



RICAMBI

REF.	11974	11975	11976	11977	11978
TIPO DI LAMA	R1	R2	R3	R4	R5
LAME ARROTONDATE	mm	mm	mm	mm	mm
	A 3	5	6	8	10
	B 7	7	10	12	12
	C 5	8	15	16	18
	D 21	21	23	25	24

REF.	11979	11980	11981	11982	11983
TIPO DI LAMA	W1	W2	W3	W4	W5
LAME QUADRATE	mm	mm	mm	mm	mm
	A 3	5	7	9	11
	B 7	7	10	12	12
	C 5	6	10	13	15
	D 21	21	22	24	23

52598

1.080,00€

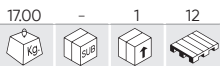

ROBOT TOSAERBA



RICAMBI DISPONIBILI

5200 mAh capacità della batteria battery capacity	1400m ² area di lavoro working area	IP X4 protezione contro l'acqua water protection	DC 15-25.5V tensione di lavoro working voltage	2,5h autonomia runtime	22m/min velocità di taglio cutting speed
115,44W consumo di energia power consumption	AC 100-240V 50/60Hz tensione di rete input voltage	7,5Kg peso weight	2h tempo di ricarica charging time	70 dB(A) rumore noise	50-35,5-24 cm altezza di taglio cutting height



CONNESSIONE ALL'APP



- A MOTOR BRUSHLESS
- B PULSANTE STOP
- C STAZIONE DI RICARICA
- D RUOTA POSTERIORE
- E COPERCHIO DELLA MANIGLIA

54252

199,00€



SPAZZATRICE A SPINTA MANUALE

- A CONTENITORE PER LA RACCOLTA DELLO SPORCO
- B CORPO PRINCIPALE
- C SPAZZOLA A DISCO SINISTRA
- D SPAZZOLA A DISCO DESTRA
- E TAPPO SUPERIORE
- F MANIGLIA DI SPINTA INFERIORE SUPERIORE
- G MANIGLIA DI SPINTA INFERIORE
- H MANIGLIA PER IL TRASPORTO

1800 m ² /h capacità di aspirazione suction capacity	200 mm PVC larghezza della spazzola brush width	50 mm PVC altezza della spazzola brush height
25L capacità del contenitore container capacity	650 x15mm diametro della spazzola brush diameter	

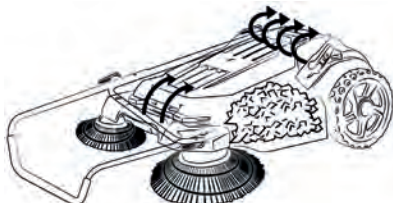

RICAMBI DISPONIBILI

ENERGIA RINNOVABILE E MOBILITÀ DEL FUTURO

342 CAVI DI RICARICA PER AUTO ELETTRICHE

342 CARICABATTERIE PER AUTO ELETTRICHE

343 GENERATORE DI ENERGIA

344 STRUMENTI ISOLATI



CAVO ELETTRICO

TIPO 1-2 TYPE 1-2

REF.	DESCRIZIONE					€
54053	CAVO ELETTRICO DI RICARICA PER AUTO, 3,6KW, 16 A, DAL TIPO 1 AL TIPO 2 (SINGLE-PHASE)	2.15	-	5	-	248,00€
54054	CAVO ELETTRICO DI RICARICA PER AUTO, 7,5KW, 32 A, DAL TIPO 1 AL TIPO 2 (SINGLE-PHASE)	2.90	-	5	100	268,00€

-25°
+55°

Tipo
1-2

IP66

5m



TIPO 2-2 TYPE 2-2

REF.	DESCRIZIONE					€
54055	CAVO ELETTRICO DI RICARICA PER AUTO, 3,6KW, 16 A, DAL TIPO 2 AL TIPO 2 (SINGLE-PHASE)	2.15	-	5	100	220,00€
54056	CAVO DI RICARICA PER VEICOLI ELETTRICI, 11KW, 16 A, DAL TIPO 2 AL TIPO 2 (TRIFASE)	2.85	-	5	102	260,00€
54057	CAVO ELETTRICO DI RICARICA PER AUTO, 7,5KW, 32 A, DAL TIPO 2 AL TIPO 2 (SINGLE-PHASE)	2.95	-	5	102	248,00€
54058	CAVO ELETTRICO DI RICARICA PER AUTO, 22KW, 32 A, DAL TIPO 2 AL TIPO 2 (TRIFASE)	3.85	-	5	100	348,00€

-25°
+55°

Tipo
2-2

IP66

5m



CARICABATTERIE DA RETE

REF.	DESCRIZIONE					€
52600	CARICABATTERIE DA RETE 3,6 KW, 16 A, PER VEICOLI ELETTRICI (SINGLE-PHASE)	4.65	-	4	80	884,00€
52902	CARICABATTERIE DA RETE 7,5 KW, 32 A, PER VEICOLI ELETTRICI (SINGLE-PHASE)	4.90	-	4	40	970,00€
52903	CARICABATTERIE DA RETE 11 KW, 16 A, PER VEICOLI ELETTRICI (TRIFASE)	5.25	-	1	40	1.100,00€

295mm

195mm

65mm

IP66

-25°
+55°

Tipo
2



54265

1.290,00€

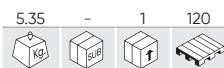

CARICABATTERIE DA RETE 22 KW, 32 A, PER VEICOLI ELETTRICI (TRIFASE)

32A 22 kW Tipo 2

Trifásico
Three-Phase



Unisciti al futuro con il nostro sistema di ricarica rapida per la tua auto elettrica. Design moderno e minimalista. Oggi con il caricatore da parete JBM puoi trasformare il tuo garage, terrazzo o parcheggio dell'ufficio in un luogo di facile utilizzo per il tuo EV / PHEV.

REF.	DESCRIZIONE				€
16130	CONTATORE DI CORRENTE PER CARICABATTERIE 54265	0.40	-	15	290,00€
16198	CARTA D'IDENTIFICAZIONE RADIOFREQUENZA (CARTA RFID) - 54265	0.01	-	-	5,00€

54059

428,00€



STAZIONE DI RICARICA PORTATILE 16A, CON CAVO DI RICARICA DI TIPO 2

16A 3.68 kW IP66
6m -25° +55° Tipo 2



Con questo caricatore portatile puoi caricare il veicolo ovunque si trovi, con una normale presa di corrente, senza preoccupazioni. Anche una soluzione rapida ed economica per ricaricare la tua auto elettrica nella tua officina. Display LCD con accesso ai parametri più importanti, cavo di tipo 2 integrato, design compatto, rivestimento estremamente resistente e 5 m di lunghezza del cavo totale, offre una garanzia di comfort e affidabilità.

REF.	DESCRIZIONE				€
15460	CARTA D'IDENTIFICAZIONE RADIOFREQUENZA (CARTA RFID)	0.01	-	250	5,00€

53970

3.790,00€

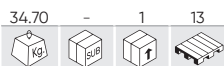

CENTRALE ELETTRICA PORTATILE 1920WH/48V 40AH

MPPT	CC-CA	2W(x2) LED	200VAC ±10%	Carga rápida Fast Charging 54V/10A 3-4H	Carga solar Solar Charging 54V/7.5A 4-5H
50-60 Hz	UNIVERSAL	12V 10A	3000W	Salida nominal de CA Rated AC output	1920Wh LiFePO4
5000W	Pico de salida de CA Peak AC output	x2000	Ciclos de carga Battery life cycles	Temperatura de descarga Discharging Temperature -10°C/60°C	Temperatura de carga Temperature 0°C/45°C
USB-QC 5V 9V/12V/3A	DC(x2) 12V/10A	USB-Type-C 5V/3A - 9V/2A 12V/1.5A	USB 5V 2.4A*2		



La stazione di forza portatile è un potente generatore elettrico portatile che viene caricato dall'energia solare. In assenza di luce solare può anche essere caricato da qualsiasi fonte di energia.

CONTIENE

CARICABATTERIA
CARICATORE PER PANNELLO SOLARE
CAVO CONNETTORE PER CARICATORE A PARETE

COMPATIBILE CON
54321



54321

898,00€

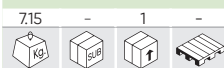

PANNELLO SOLARE 200 W

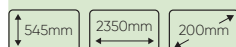

200W



REF.	DESCRIZIONE				€
15448	SET DI 2 CONNETTORI MC4 1000V 30A	0.01	-	186	5,50€

53940

13,20€



PALO IN PLASTICA PER CATENA - GIALLO / NERO

- Materiale: PVC.
- La base si può riempire di acqua o sabbia.

CATENA NON INCLUSA.



SPECIALE SEGNALEZIONE DI ALTA TENSIONE



54326

7,30€

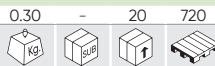

N

CATENA IN PLASTICA - GIALLO/NERO 7m



53987

9,50€



NASTRO SEGNALETICO GIALLO/NERO - 200M

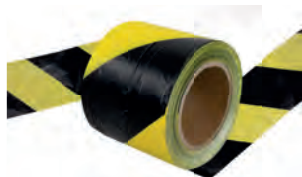

53942

0,50€

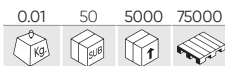

ANELLO DELLA CATENA IN PLASTICA NERO



54322

19,00€

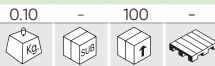

N

SET DI 2 CARTELLI DI AVVERTIMENTO PER L'ALTA TENSIONE



52382

19,50€

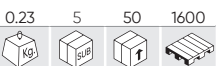

MULTIMETRO CON PINZA AMPEROMETRICA

DCB	600V
ACB	600V
DCA	-
ACA	20A, 200A, 600A
OHM	2KΩ, 200KΩ, 2MΩ



52952

74,00€



MULTIMETRO CON PINZA AMPEROMETRICA

DCB	20V, 600V
ACB	600V
DCA	200A
ACA	200A
OHM	2000Ω



50942

28,00€

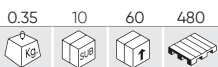

MULTIMETRO DIGITALE

- Caratteri 3" 1/2.
- Misurazione: 2000.
- Dati istantanei.
- Spegnimento automatico.
- Indicatore livello di carica della batteria.
- Batteria da 9 V.
- Sonda della temperatura.
- Temperatura: da -40 °C a 1000 °C.



54091

441,00€

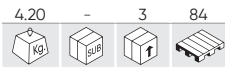

VALIGETTA DI UTENSILI ISOLATI VDE 26 PEZZI

26PCS
3/8"
CrV
VDE
GS: Geprüfte Sicherheit
1000V
IEC 60900C



54093

441,00€

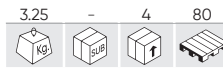

MODULO IN EVA CON UTENSILI ISOLATI VDE 25 PEZZI

26PCS
3/8"
CrV
VDE
GS: Geprüfte Sicherheit
1000V
IEC 60900C



53154

462,00€

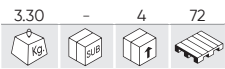

VALIGETTA DI UTENSILI ISOLATI 20 PEZZI DA 3/8"

20PCS
3/8"
CrV
VDE
GS: Geprüfte Sicherheit
1000V
IEC 60900C



15162

30,20€

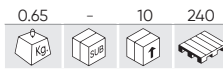

SET DI 8 CACCIAVITI ISOLATI VDE IN MODULO EVA IN FIBRA DI CARBONIO

8PCS
VDE
GS: Geprüfte Sicherheit
1000V
IEC 60900C



52519

25,50€

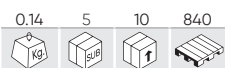

SET DI 7 CACCIAVITI ISOLATI 1.000V

7PCS
CrV
VDE
GS: Geprüfte Sicherheit
1000V
IEC 60900:2004



GUANTI ISOLANTI PER LAVORI IN TENSIONE

REF.	DESCRIZIONE					€
54130	T.9	0.35	-	1	100	58,00€
54131	T.10	0.40	-	1	100	58,00€

AZC
LATEX
CAT III
CLASS 0
1000V AC / 1500V DC
IEC ELECTRICAL SAFETY
GLOVES 60903-2014 CLASS 0



COLTELLO ISOLATO

REF.	DESCRIZIONE					€
53164	DRITTO	0.10	6	36	1152	16,50€
53165	CURVO	0.10	6	36	1152	19,60€

CrV
VDE
GS: Geprüfte Sicherheit
1000V
IEC 60900C



CARRELLO 7 CASSETTI

54236 1.856,00€

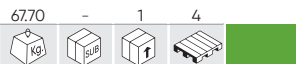

54233 1.856,00€

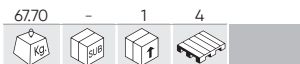

54234 1.856,00€



54235 1.856,00€

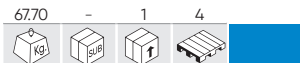

CONTIENE

REF.	UNI.	€	REF.	UNI.	€	REF.	UNI.	€
A	52162	1 38,00€	E	54093	1 441,00€	I	54132	1 190,00€
B	53940	4 13,20€	F	54114	1 248,00€	J	54241	1 120,00€
C	54326	1 7,30€	G	54129	1 110,00€			
D	53942	8 0,50€	H	54130	1 58,00€			



54386



TAVOLA IDRAULICA PER BATTERIE PER VEICOLI ELETTRICI

Caratteristiche di caricamento	Carico distribuito
Tempo di sollevamento (senza carico)	60"
Tempo di abbassamento (senza carico)	45"
Piattaforma	1290 - 1400x768mm



5.839,00€

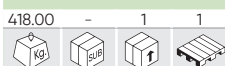
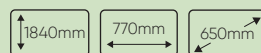

1,2T
MAX: 1840mm
MIN: 650mm



54241

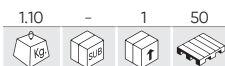

PALO DI SOCCORSO ISOLATO - 45KV



120,00€



54129



TAPPETINO ISOLANTE CLASSE 0

CLASS 0
ENROLLABLE ROLLS
SLIP RESISTANT
OIL RESISTANT
RECYCLABLE
1000V AC / 1500V DC
IEC ELECTRICAL SAFETY
MATTING 60903-2024 CLASS 0

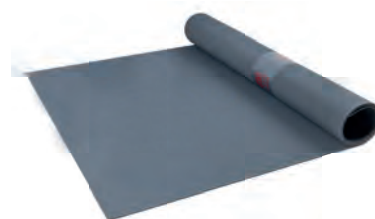

110,00€

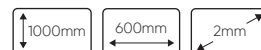

54132

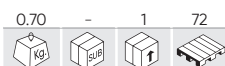

VISIERA ISOLANTE PER LAVORI IN TENSIONE

ANTI-RALLADURAS / SCRACHING PROOF
ANTI-VAHO / ANTI FOG
EN 170:2022
EN 166:2001
ANSI Z87.1
CLASS 1



190,00€

54114

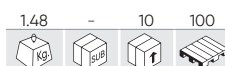

MISURATORE DI ISOLAMENTO

2000MΩ
1000V
750V
CAT III



248,00€

ACCESSORI PER OFFICINA

348 AVVOLGITUBO

349 SCALE

350 CARRELLI E PIATTAFORME



AVVOLGITUBO DELL'ARIA

REF.		m					€
53582		22m	10.85	-	1	14	174,00€
53583		22m	10.75	-	1	14	174,00€
53532		13m	6.60	-	2	30	119,00€
53581		13m	6.70	-	2	30	119,00€
53881		11m	4.50	-	4	48	79,00€
53882		11m	4.50	-	4	48	79,00€

300 PSI
20 BAR

3/8"

Ø 9.5mm



CON RIPARTITORE

AVVOLGITUBO DELL'ACQUA

REF.		m					€
53872		16,5m	7.50	-	1	21	118,00€

15m + 1,5m

120 PSI
8 BAR

3/4"

Ø 15.8mm
Ø 11.5mm

PVC



RICAMBI
DISPONIBILI



AVVOLGITORE DI CAVO ELETTRICO

REF.		m					€
53586		21m	8.35	-	2	30	168,00€
53585		21m	8.35	-	2	36	168,00€
53584		12m	5.10	-	4	48	119,00€
53526		12m	5.15	-	4	48	119,00€

230V

1000W
3000W

IP44

H07RN-F
3G1.5mm²



CON RIPARTITORE



AVVOLGITUBO DELL'OLIO. ATTACCO DA 1/2" 15M

REF.	m					€
50797	16m	26.60	-	1	14	490,00€

- Bobina per l'olio
- Lunghezza del tubo flessibile: 15+1 m
- Pressione massima di lavoro: 2 450 psi
- Ingresso dell'aria: 1/2", BSPT (filettatura gas conica britannica)
- Uscita dell'aria: 1/2", filettatura gas conica britannica
- Materiale: acciaio

160
BAR

SCALA TELESCOPICA

REF.	DESCRIZIONE					€
51982	SCALA TELESCOPICA 6 GRADINI - 2M	5.51	-	1	34	120,00€
51983	SCALA TELESCOPICA 10 GRADINI - 3.2M	9.41	-	1	34	185,00€
51984	SCALA TELESCOPICA 12 GRADINI - 3,8M	9.78	-	1	22	190,00€

CONFORME A: EN 131

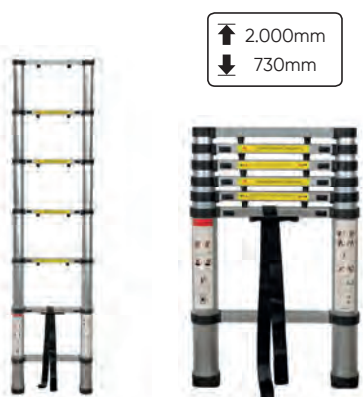

51982

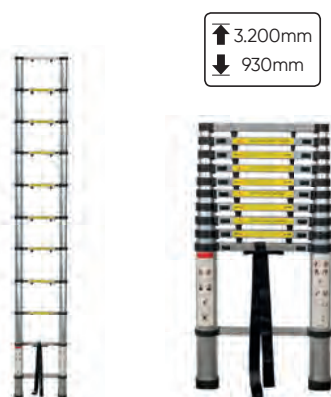

51983

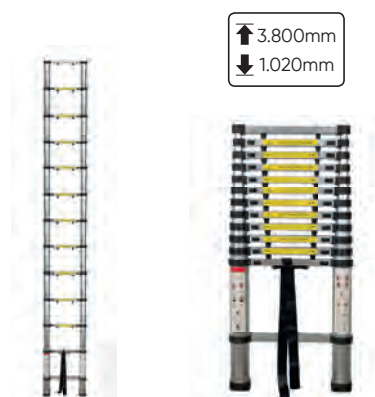

51984

52149

14.00	-	1	14

230,00€

CONFORME A: EN 131

SCALA TELESCOPICA A V PIEGHEVOLE

- Scala pieghevole e leggera.
- Sistema di piegatura mediante bloccaggio.
- Fabbricata in alluminio e plastica.
- Altezza piegata 835mm.
- Altezza estesa: 3800mm.
- Altezza piegata: 1900mm.



54176

188,00€

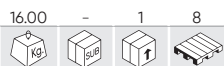

CONFORME A: EN 131

SCALA MULTIUSO

- Lunghezza massima: 3,7 m
- Capacità: 150 kg
- Materiale: Alluminio
- Spessore dell'alluminio: 1,2 mm
- Spazio tra due pioli: 28 cm



CONTIENE

REF. DESCRIZIONE

15866 SET DI 2 PIATTAFORME PER RIF. 54176

5.00	-	1	-	€ 32,00€
------	---	---	---	----------

50517

129,00€

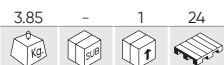

SCALA D'ALLUMINIO A 4 GRADINI

- 4 GRADINI
- Altezza totale: 1,30m.
- Altezza massima di lavoro: 0,79m.



50518

169,00€



SCALA D'ALLUMINIO A 6 GRADINI

- 6 GRADINI
- Altezza totale: 1,91m.
- Altezza massima di lavoro: 1,31m.

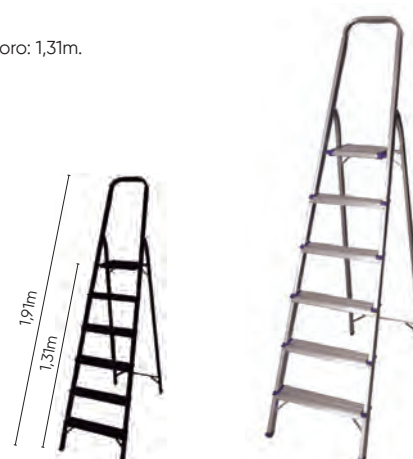

52230

398,00€



CONFORME A: EN 131

PIATTAFORMA D'ALLUMINIO TELESCOPICA



MIN			MAX		
520mm	1090mm	300mm	900mm	1750mm	300mm

REF. DESCRIZIONE

10964 COPRIANGOLO PER PIATTAFORMA CON REF. 52230
 10965 BLOCCAPIOLO PER PIATTAFORMA CON REF. 52230
 10966 PIEDE RICAMBI PER PIATTAFORMA CON REF. 52230

0.01	-	1	-	€ 9,00€
0.01	-	1	-	€ 6,00€
0.06	-	1	-	€ 13,50€

50656

290,00€

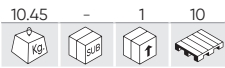

CONFORME A: EN 131

KIT DI 2 PIATTAFORME D'ALLUMINIO



REF.	cm						€
11897	100x30x30cm	4.66	-	1	16	155,00€	
15552	130x30x55cm	6.80	-	1	18	181,00€	

50913

195,00€

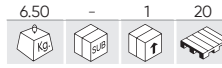

CONFORME A: EN 131

PIATTAFORMA D'ALLUMINIO GRANDE

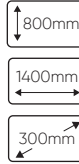

52202

88,00€

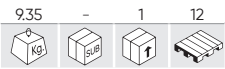

CARRELLO D'ACCIAIO BASE CAP. 200KG



REF.	DESCRIZIONE					€
12055	RUOTA	1.11	10	160	20,00€	

50924

342,00€

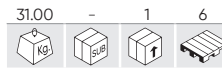

CARRELLO PORTABIDONI



52200

88,00€

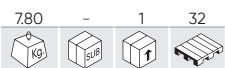

CARRELLO CON PIATTAFORMA IN ACCIAIO CAP. 130KG



ESTESO	PIEGATO



54305

232,50€



CARRELLO PIATTAFORMA PIEGHEVOLE IN ALLUMINIO 300KG



N

ESTESO	PIEGATO



54308

89,00€

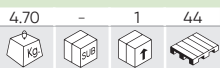

N

CARRELLO PIEGHEVOLE IN ALLUMINIO 90KG



ESTESO

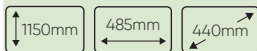

PIEGATO

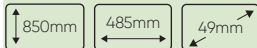

54310

57,00€

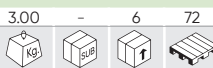

N

CARRELLO PIEGHEVOLE IN ALLUMINIO 75KG



ESTESO

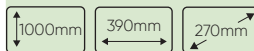

PIEGATO

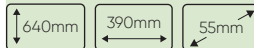

54306

219,50€



N

CARRELLO PIEGHEVOLE IN ALLUMINIO 250KG



ESTESO

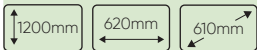

PIEGATO



54309

71,00€



N

CARRELLO SALISCALE PIEGHEVOLE



ESTESO



PIEGATO



ACCESSORI PER VEICOLI

- 354 SEGNALETICA
- 355 KIT DI EMERGENZA
- 357 LAMPADINE
- 358 KIT PRONTO SOCCORSO
- 359 SICUREZZA
- 359 SOFFIETTI E MORSETTI
- 361 TAPPETINI
- 362 TERGICRISTALLI
- 363 BICICLETTA
- 364 ALTRO
- 366 SENSORI DI PARCHEGGIO
- 366 TUBI FLESSIBILI



ACCESSORI PER VEICOLI

53778
4,50€

TRIANGOLO DI
SEGNALAZIONE
OMOLOGATO 27R032736



CONFORME A: E4 27R-032736

52795
5,80€



TRIANGOLO DI
SEGNALAZIONE
OMOLOGATO 27R032738



CONFORME A: E4 27R-032738

54298
7,50€

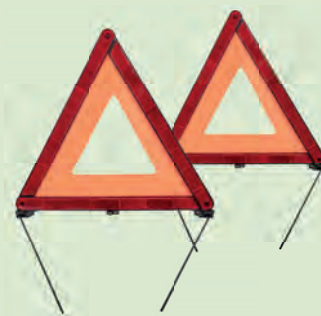
2 TRIANGOLI DI
SEGNALAZIONE OMOLOGATI
27R032736



CONFORME A: E4 27R-032736

N

GIUBBOTTO RIFLETTENTE AD ALTA VISIBILITÀ OMOLOGATO

CONFORME A: EN ISO20471:2013

+A1:2016

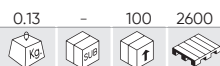
51817
4,50€

Fascia segnata

50654
4,00€

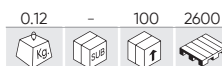
50966
4,00€

50966C
3,00€

N

DISTINTIVO PER VEICOLI DESTINATI AL TRASPORTO

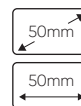
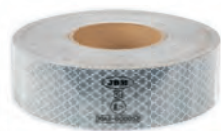
REF.					€
51935		1.04	10	280	135,00€
51936		1.04	10	140	135,00€
51937		1.02	10	280	135,00€



Omologazione: REGOLAMENTO CEPE/ONU 104R

- Applicabile a partire dal 10 luglio 2011, ai sensi della modifica del Regolamento Generale sui Veicoli, approvato per il Regio Decreto 2822/1998 del 23/12/2010.
- Bobine indivisibili di 50m.

CARTELLO DI AVVERTIMENTO "CARICO SPORGENTE" V-20

REF.					€
53636	PRODOTTO IN POLIPROPILENE PER MAGGIORE FLESSIBILITÀ	0.87	25	700	22,00€
53507	FRONTALE IN POLIMETILMETACRILATO (PMMA) E RETRO IN ALLUMINIO	0.75	25	800	27,00€



KIT D'EMERGENZA SICUREZZA

ASTUCCI CON RIVETTO

REF.						€
51692	550x90x130mm	0.11	-	100	1600	3,55€
51693	550x90x130mm	0.12	-	100	1200	3,55€
51694	550x90x130mm	0.14	-	100	1200	3,55€
51696	550x90x130mm	0.12	-	80	1200	3,55€



ASTUCCIO NERO CON RIVETTO

REF.						€
11328	557x110x70mm	0.12	-	100	1200	4,00€



ASTUCCI MINI

REF.						€
53621	550x150mm	0.05	-	100	3200	2,50€
53622	550x150mm	0.05	-	100	3200	2,50€
53623	550x150mm	0.05	-	100	3200	2,50€
53624	550x150mm	0.05	-	100	3200	2,50€



ASTUCCIO NERO NYLON

REF.						€
15619	330x100x80mm	0.09	-	100	1500	4,00€



N

53721

18,80€

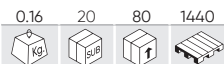

FARO DI EMERGENZA A LUCE INTERMITTENTE LED



KIT D'EMERGENZA

REF.						€
54534	330x100x80mm	0.37	-	10	200	24,00€



N

METTI IL TUO LOGO



KIT D'EMERGENZA ASTUCCIO IN PVC

REF.							€
53185	x1	0.69	-	10	200	13,20€	
53186	x2	1.04	-	10	200	13,20€	



METTI IL TUO LOGO



* Doppio triangolo, obbligatorio solo in Spagna.

KIT D'EMERGENZA

REF.		△					€
52768	■	x2	MK H1	1.81	-	10 200	13,80€
52772	■	x2	MK H1	1.88	-	10 200	13,90€
52776	■	x2	MK H1	1.81	-	10 200	13,80€
52780	■	x2	MK H1	1.94	-	10 200	13,90€
52769	■	x2	MK H4	1.01	-	10 200	14,50€
52773	■	x2	MK H4	1.01	-	10 200	14,60€
52777	■	x2	MK H4	1.07	-	10 200	15,50€
52781	■	x2	MK H4	1.14	-	10 200	14,60€
52770	■	x2	MK H7	2.55	-	10 200	23,00€
52774	■	x2	MK H7	0.99	-	10 200	14,80€
52778	■	x2	MK H7	0.99	-	10 200	14,60€
52782	■	x2	MK H7	1.11	-	10 200	14,80€
52771	■	x2	MK H7+H1	2.75	-	10 200	23,40€
52775	■	x2	MK H7+H1	1.01	-	10 200	15,20€
52779	■	x2	MK H7+H1	1.13	-	10 200	17,10€
52783	■	x2	MK H7+H1	1.01	-	10 200	15,20€



H1 (12V)
H4 (12V)
H7 (12V)

* Doppio triangolo, obbligatorio solo in Spagna.

KIT D'EMERGENZA ASTUCCIO CON RIVETTO

REF.		△				€
53177	■	x1	0.63	-	10 200	11,90€
53178	■	x1	0.64	-	10 200	12,20€
53179	■	x1	0.65	-	10 200	12,20€
53180	■	x1	0.63	-	10 200	12,20€
53181	■	x2	0.98	-	10 200	11,90€
53182	■	x2	0.99	-	10 200	12,20€
53183	■	x2	0.99	-	10 200	12,70€
53184	■	x2	0.98	-	10 200	12,20€



METTI IL TUO LOGO

* Doppio triangolo, obbligatorio solo in Spagna.

KIT D'EMERGENZA ASTUCCIO CON RIVETTO

REF.		△				€
53087	■	x1	0.58	-	10 200	11,20€
53088	■	x1	0.59	-	10 200	11,50€
53089	■	x1	0.61	-	10 200	11,50€
53090	■	x1	0.59	-	10 200	11,50€



METTI IL TUO LOGO

KIT D'EMERGENZA ASTUCCIO

REF.		△				€
53091	■	x1	0.52	-	10 200	10,20€
53092	■	x1	0.52	-	10 200	10,20€
53093	■	x1	0.52	-	10 200	10,20€
53094	■	x1	0.52	-	10 200	10,20€



METTI IL TUO LOGO

MINI KIT DI LAMPADE

REF.							€
51613	12V	H1	0.90	10	100	1500	2,90€
51615	12V	H9	0.09	10	100	1500	5,95€
51612	12V	H11	0.09	10	100	1500	5,95€
50523	12V	HB3	0.09	10	100	1500	4,70€
50524	12V	HB4	0.09	10	100	1500	4,70€
50915	12V	H7+H1	0.10	10	100	1800	4,20€
51614	12V	H4	0.10	10	100	1800	3,60€
50431	12V	H7	0.08	10	100	1800	3,80€
52047	24V	H4	0.09	10	100	1500	3,30€
52048	24V	H7	0.10	10	100	1500	3,95€



50551



350,00€



ARMADIO LAMPADINE PER AUTO

LUCE D'ARRESTO A 1 POLO
P21W 21 W BA15S UNITÀ 30
P21WA 21 W BA15S
ARANCIONE UNITÀ 10
PY21W 21 W BAU15S
AMBO SC. UNITÀ 10

LUCE D'ARRESTO A 2 POLI
R21/5W 21/5 W BAY15D UNITÀ 40

PLAFONIERA
C5W 5 W SV8.5 11X38 UNITÀ 22

LAMPADA SPIA
R5W 5 W BA15S UNITÀ 30
R10W 10 W BA15S UNITÀ 30

INDICATORI DI DIREZIONE
T4W 4 W BA9S UNITÀ 22

LAMPADE ALOGENE
H1 55 W P14.5S UNITÀ 10
H2 55 W X511 UNITÀ 4
H3 55 W PK22S UNITÀ 4
H4 60/55 W P43T UNITÀ 10
H7 55 W PX26D UNITÀ 10
HB3 65 W P20D UNITÀ 4
HB4 55 W P20D UNITÀ 4
H9 65 W PGJ19-5 UNITÀ 4
H11 65 W PGJ19-2 UNITÀ 4

ILLUMINAZIONE EUROPEA
T5 1,2 W W2.1X4,6D UNITÀ 20
T10 5 W W2.1X9,6D UNITÀ 12
T10 3 W W2.1X9,6D UNITÀ 12
T13 10 W W2.1X9,6D UNITÀ 10
T15 18 W W2.1X9,6D UNITÀ 10
T20 21 W W5X16D UNITÀ 10
T20A 21 W W5X16D ARANCIONE 10U.
T20 21/5 W W5X16D UNITÀ 10



LAMPADINE OBN

REF.	DESCRIZIONE					€
52365	LAMPADA H7 12V 55W	0.02	10	200	9000	2,46€
52364	LAMPADA OBN H1 12V 55W	0.02	10	200	4400	2,86€
52362	LAMPADA OBN H1 12V 55W	0.01	10	200	14400	1,23€
10766	LAMPADA DI RICAMBIO PER 51960, 51962	0.01	-	200	-	1,59€
52363	LAMPADA H3 12V 55W	0.02	10	200	14400	1,23€
53203	LAMPADE OBN AMBER 12V 21W BA15S	0.01	10	200	-	0,46€
52369	LAMPADA 12V 2POLI 21/5 W T20	0.01	10	1000	18000	1,19€
52368	LAMPADA 12V 21W SENZA ATTACO T20A	0.01	10	1000	18000	1,14€
53007	LAMPADA OBN R5W 12W 5V	0.05	10	200	1500	0,42€
52862	LAMPADE OBN 21W 12V T 20	0.01	10	1000	1500	1,15€
52370	LAMPADA AMBAR 12V 21W SENZA ATTACO T20	0.01	10	1000	18000	1,17€
52864	LAMPADE OBN 21/5W 12V T20	0.01	10	500	1500	1,20€
52865	LAMPADA OBN WEDGE 10W 12V T13	0.01	10	2000	-	0,50€
52866	LAMPADA OBN WEDGE 18W 12V T15	0.01	10	2000	256000	0,25€



54042



KIT DI PRIMO SOCCORSO DIN13164:2022

- x1 Cerotto adesivo DIN13019-A 5X2,5
- x4 Cerotti adesivi din 13019-E 10X6
- x2 Cerotti elastici per le dita da 4x7 cm
- x2 Cerotti elastici per le dita da 12x2 cm
- x2 Strisce di cerotto adesivo impermeabile 1,9x7,2 cm
- x4 Strisce di cerotto adesivo impermeabile 2,5x7,2 cm
- x1 Benda sterile DIN 13151-K 6X8 cm
- x2 Bende sterili DIN 13151-M 8x10 cm
- x1 Benda sterile DIN 13151-G 10x12 cm
- x1 Bendaggio di primo soccorso DIN 13152-BR 60x40 cm
- x1 Bendaggio di primo soccorso DIN 13152-A 60x80 cm
- x2 Bende sterili DIN 61634FB6 6 cm x 400 cm
- x3 Bende sterili DIN 61634FB6 8 cm x 400 cm
- x1 Coperta di soccorso 160 x 210 cm

13,00€

44
PCS



- x6 Compresse sterili per ferite 10 x 10 cm
- x2 Bende triangolari DIN 13168-D
- x1 Forbice DIN 58279-A 145 145 cm
- x4 Guanti monouso DIN EN 455-1
- x2 Salviette umide per la pulizia della pelle
- x1 Elenco dei contenuti
- x1 Manuale di primo soccorso

51246

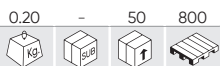

KIT DI PRIMO SOCCORSO

- x1 Volantino di primo soccorso
- x1 Fobrici
- x1 Paio di guanti
- x2 Cartine all'alcol
- x2 Tiritas adhesivas
- x1 25gr. de algodón
- x1 Sobre con 5 garze
- x1 Benda
- x1 Rotolo nastro adesivo

6,40€

11
PCS



54072



CASSETTA DI PRIMO SOCCORSO DIN13157

- x1 Cerotto adesivo 5 x 25 - DIN13019-A
- x1 Set di bende adesive 10 x 6 cm (8 pezzi) - DIN13019-E
- x6 Cerotti per il dito 4 x 6,5 cm
- x6 Cerotti per il dito 120 x 20 mm
- x6 Cerotti per il dito 7,2 x 1,9 cm
- x12 Cerotti per il dito 25 x 72 mm
- x1 Set di bende per il primo soccorso, impacco sterile 6 x 8 cm - DIN13151-K
- x3 Set di bende per il primo soccorso, impacco sterile 8 x 10 cm - DIN13151-M
- x1 Set di bende per il primo soccorso, impacco sterile 10 x 12 cm - DIN13151-G
- x1 1 Impacco sterile 60 x 80 cm - DIN13152-A
- x3 Fasciature sterili per le ferite 100 x 100 cm, 2 pezzi/confezione - DIN58953-2
- x2 Bende per gli occhi - 55 mm x 75 mm 1,5 g
- x1 Impacco freddo per l'aiuto d'emergenza, min. 200 Cm2
- x1 Coperta di primo soccorso, 160 x 210 cm, 12 micron
- x2 Bende elastiche secondo i requisiti della norma, 6 cm x 400 cm - DIN61634 FB6
- x2 Bende elastiche secondo i requisiti della norma, 8 cm x 400 cm - DIN61634 FB8
- x2 Fasce triangolari 96x96x136 cm - DIN13168-D
- x1 Forbice di metallo 190 mm - DIN58279-B190
- x2 Sacchi della spazzatura di plastica, 300 x 400 mm, 45 µm
- x5 Tessuti non tessuti 20 x 30 cm, min. 15 G/m2
- x1 Guanto monouso in pvc l-aq1.5 (Set di 4 pz.) - DIN EN 455-1

38,50€

67
PCS



- x1 Opuscolo informativo
- x2 Maschere chirurgiche DIN EN 14683
- x4 Salviette detergenti per una pelle sana

50644 11,60€

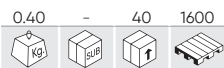

CINTURE DI SICUREZZA A 2 PUNTI PER PULLMAN



CONFORME A: E4-16R-0436213

50717 21,90€

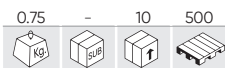

CINTURE DI SICUREZZA A 2 PUNTI AVVOLGIBILI PER PULLMAN



CONFORME A: E4-16R-0436232

51266 28,00€

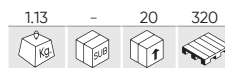

CINTURE DI SICUREZZA A 3 PUNTI AVVOLGIBILE PER PULLMAN



CONFORME A: E4-16R-0436232

52259 3,75€

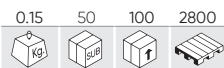

MARTELLETTO ROMPIVETRO CON BASE DI SUPPORTO E TAGLIACINTURE

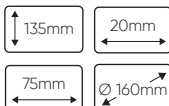

51861 199,00€

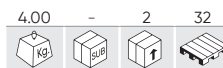

UTENSILE PNEUMATICO PER IL MONTAGGIO DI SOFFIETTI SEMIASSE



- Materiale: Alluminio.
- Apertura da 20 a 100mm.

FASCETTE STRINGITUBO

REF.	DESCRIZIONE					€
11890	FASCETTE STRINGITUBO 50-125MM	0.01	100	1000	18000	0,55€
11891	FASCETTE STRINGITUBO 15-45MM	0.01	100	5000	90000	0,50€
52633	PACK 2 RONDELLE	0.02	100	800	14400	1,00€



KIT DI CUSCINETTI PER SEMIASSE 100% NEOPRENE UNIVERSALI

REF.	DESCRIZIONE				€
51703	KIT CUSCINETTO SEMIASSE PER FURGONE	0.28	20	320	10,50€
51705	KIT DI CUSCINETTO SEMIASSE PER BERLINA	0.23	20	400	8,45€



52644



KIT SOFFIETTO UNIVERSALE



8,80€

53693

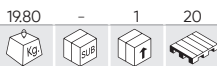

CASSETTA DI 100 SOFFIETTI SEMIASSE

521,00€



x100 **52633**

x100 **13738**

x100 **13879**

53698



CASSETTA DI 100 SOFFIETTI SEMIASSE PER FURGONI

717,00€



x100 **52633**

x100 **13739**

x100 **13880**

53695

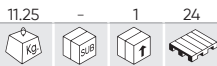

CASSETTA DI 80 SOFFIETTI UNIVERSALE

504,00€



x80 **52633**

x80 **13740**

x80 **13880**

SERIE124



KIT SPECIALE SOFFIETTO

710,00€



x1 **51861**

x100 **52633**

x100 **13738**

x100 **13879**

RICAMBI

REF.	DESCRIZIONE					€
13738	CUFFIA DI PROTEZIONE DEL GIUNTO PER AUTOVETTURA	0.08	-	150	1800	3,50€
13739	CUFFIA DI PROTEZIONE DEL GIUNTO PER FURGONE	0.15	-	100	1600	5,50€
13740	CUFFIA DI PROTEZIONE DELLA GUIDA PER AUTOVETTURA	0.10	-	72	-	5,50€
13879	SACCHETTO GRASSO SOFFIETTO	0.09	-	150	5250	1,38€
13880	SOFFIETTO PER LA LUBRIFICAZIONE DEL SISTEMA DI STERZO	0.01	-	600	21000	1,50€

50585

14,70€

**TAPPETINI UNIVERSALI REVERSIBILI IN GOMMA**

- Gomma di alta qualità.
- Molto resistenti.
- Adattabili alla maggior parte dei veicoli.

REVERSIBILI!

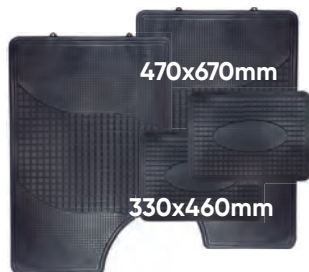
**53241**

9,00€

**TAPPETINI UNIVERSALI IN GOMMA**

- Gomma di alta qualità.
- Molto resistenti.
- Adattabili alla maggior parte dei veicoli.

**52534**

15,00€

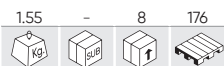
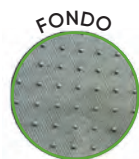
**TAPETTINI UNIVERSALI CON TALLONERA PLASTICA**

- 2 Anteriori (425x660mm).
- 2 Posteriori (295x425mm).
- Leggero, confortevole, con tacco plastico.
- Reverso con borchie in gomma.

52535

16,50€

**TAPPETI UNIVERSALI CON TALLONERA MOQUETTE**

- 2 Anteriori (425x660mm).
- 2 Posteriori (295x425mm).
- Leggero, confortevole, con tacco plastico.
- Reverso con borchie in gomma.

52530

14,00€

**TAPETTINI UNIVERSALI**

- 2 Anteriori (390mm).
- 2 Posteriori (365x480mm).
- Leggero, confortevole, con batti tacco in plastica fondo con borchie in gomma.

**METEXP**

62,00€

**ESPOSITORE PER TAPPETINI**

SPAZZOLA UNIVERSALE PER LA PULIZIA DEI VETRI



99%

Installazione semplice dell'adattatore in più del 99% dei veicoli.

38dB

L'ergonomia e l'eliminazione delle parti pesanti, riducono il rumore di 38 dB.

30%

Pressione uniforme sulla lunghezza della spazzola grazie alla molla in acciaio, per una maggiore visibilità rispetto alle spazzole originali e prestazioni superiori del 30%.

100%

100% gomma naturale resistente a tutte le condizioni meteorologiche estreme.

160km/h

Design aerodinamico che consente l'utilizzo fino a 160 km/h.

45°

Angolo di taglio di 45° e precisione di pulizia trasversale che elimina le gocce più piccole.

REF.	"	mm					€
53745	11"	280mm	0.20	10	50	800	6,40€
53746	12"	310mm	0.20	10	50	800	6,40€
53747	13"	330mm	0.20	10	50	900	6,40€
53748	14"	350mm	0.20	10	50	800	6,60€
53749	15"	380mm	0.20	10	50	900	6,70€
53750	16"	410mm	0.20	10	50	900	6,70€
53751	17"	430mm	0.20	10	50	900	6,80€
53752	18"	460mm	0.25	10	50	800	6,95€
53753	19"	480mm	0.25	10	50	700	7,10€
53754	20"	510mm	0.25	10	50	900	7,40€
53755	21"	530mm	0.25	10	50	600	7,50€
53756	22"	560mm	0.25	10	50	600	7,90€
53757	24"	610mm	0.25	10	50	600	7,90€
53758	26"	650mm	0.30	10	50	600	8,20€
53759	28"	700mm	0.30	10	50	550	8,50€
53760	30"	750mm	0.30	10	50	500	9,60€

11 ADATTATORI DIVERSI: PER PIÙ APPLICAZIONI



12 PCS

JBMWBEXP

24,50€

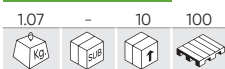

ESPOSITORE SPAZZOLE TERGICRISTALLO OBN



53919

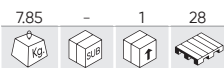

81,00€



CAVALLETTO RIPARAZIONE BICICLETTE

- Materiale: acciaio Q195, ABS, nylon
- Dimensioni in stato assemblato: 198x104 cm
- Altezza regolabile: 107-188 cm
- Lunghezza del tubo trasversale girevole: 37 cm
- Lunghezza del supporto: 69 cm
- Diametro del tubo trasversale girevole: 35 mm
- Diametro del tubo telescopico: 35 mm
- Diametro del tubo principale: 38 mm
- Diametro del tubo di supporto: 25 mm
- Capacità di carico massimo: 30 kg

IN MATERIALE ABS RINFORZATO E NYLON PER GIRARE LA BICI CON QUALSIASI ANGOLO SENZA DANNEGGIARE LA VERNICE.

DIMENSIONI DEL VASSOIO MULTIFUNZIONALE PER UTENSILI 25X13CM

CONSTRUZIONE ANTISCIVOLO 4 PIEDI



Per tutti i tipi di biciclette
bicicletta da città / strada / montagna



Asta regolabile per il fissaggio: 50-90cm

54166

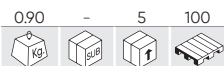

32,40€

POMPA MANULE PER BICICLETTA



54170



16,50€



POMPA MANUALE PORTATILE PER BICICLETTA



54073

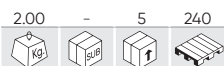

70,00€

KIT DI ATTREZZI PER BICICLETTA - 20 PEZZI



54074



18,50€

STRUMENTO DI RIPARAZIONE BICI MULTIFUNZIONE



54169



13,80€

LUCCHETTO A COMBINAZIONE PER BICICLETTA



ACCESSORI PER VEICOLI

51858 15,00€

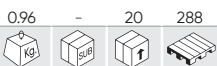

PALA PIEGHEVOLE

- Fabbricata con metallo resistente.
- Piegata: 240mm.
- Aperta: 580mm.



53033 21,50€

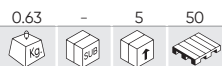

PALA ESTENSIBILE IN ALLUMINIO

- Fabbricata con plastica e alluminio.
- Piegata: 85mm.
- Aperta: 119mm.



52187 21,80€



PALA METALLICA DI 215MM



52251 21,80€

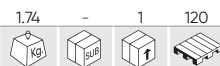

PALA METALLICA DI 215MM



53964 9,65€

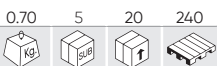

CORDA MULTIUSO 30M 1/4"

ø 1/4"
550Kg



53965 25,80€

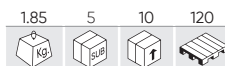

CORDA MULTIUSO 30M 1/2"

ø 1/2"
1200Kg



51412 2,10€

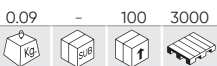

PIASTRA PORTATARGA ANONIMA

- Misure: 53,20cm x 13,70cm.
- Area disponibile: 52cm x 1,60cm.

GRAFICA E SERIGRAFIA NON INCLUSA



51697 0,80€

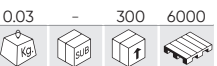

RASCHIETTO TOGLIGHIACCIO



50526 4,80€



OMBRELLO PIEGHEVOLE



50525 1,00€



PONCHO IMPERMEABILE



51925 1,00€



MINIFORBICI PER CASSETTA DI PRIMO SOCCORSO 9CM



52618 29,00€



SET ORGANIZZATORE MULTIFUNZIONE

- Composto da 4 pezzi:
 - Cassa flessibile con coperchio 37L (300mm x 490mm).
 - Bidone circolare 180mm diam. con copertura (230mm altezza).
 - Portaoggetti a gancio (90mm altezza x 260mm lungo).
 - Vassoio rigido (175mm altezza x 300mm lungo).



53221 4,75€



SET 3 PANNI IN MICROFIBRA



53561 28,00€



CUNEO FERMARUOTA

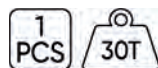

53508 14,00€



CUNEI FERMARUOTE



REF.	DESCRIZIONE	Kg	PCS	UNITA'	€
14118	SOSTEGNO PER CUNEO FERMARUOTA	1.25	4	80	26,00€

51863

54,00€

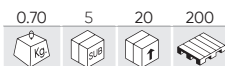

SENSORE DI PARCHEGGIO CON AVVISATORE ACUSTICO E DISPLAY VISIVO

- Tensione: 12 V DC.
- Potenza: 3,6 W.
- Temperatura di lavoro: Da -20°C a 70°C.
- 4 sensori di avvicinamento.
- Distanza di rilevamento: 0,3 - 2,0 m.
- Angolo di rilevamento: H >60°, V >60°.
- Radiofrequenza: 315 MHz / 433 MHz.
- Angolo di macchina fotografica: 92° o 120°.
- Include buzzer 4 centimetri diam.



51973

45,00€

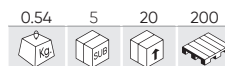

SENSORE DI PARCHEGGIO CON SOLO AVVISATORE ACUSTICO

- Tensione: 12 V DC.
- Potenza: 3,6 W.
- Temperatura di lavoro: Da -20°C a 70°C.
- 4 sensori di avvicinamento.
- Distanza di rilevamento: 0,3 - 2,0 m.
- Angolo di rilevamento: H >60°, V >60°.
- Radiofrequenza: 315 MHz / 433 MHz.
- Angolo macchina fotografica: 92° o 120°.
- Nessun indicatore visivo.
- Include buzzer 4 centimetri diam.



TUBI FLESSIBILI INNERBRAID

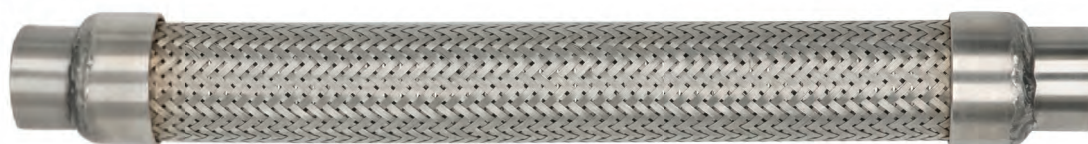

REF.	DESCRIZIONE					€
51706	Ø 25mmL x 300mmL	0.35	-	25	1500	22,80€
51707	Ø 45mmL x 100mmL	0.27	-	25	1200	9,05€
51708	Ø 45mmL x 150mmL	0.38	-	25	-	14,20€
51709	Ø 45mmL x 200mmL	0.50	-	25	-	14,70€
51710	Ø 45mmL x 250mmL	0.65	-	25	600	17,80€
51711	Ø 45mmL x 300mmL	0.71	-	25	-	21,20€
51712	Ø 50mmL x 100mmL	0.30	-	25	-	8,65€
51713	Ø 50mmL x 150mmL	0.45	-	25	-	13,10€
51714	Ø 50mmL x 200mmL	0.56	-	25	-	15,80€
51715	Ø 50mmL x 250mmL	0.70	-	25	-	20,30€
51716	Ø 50mmL x 300mmL	0.83	-	25	450	23,60€

REF.	DESCRIZIONE					€
51717	Ø 55mmL x 100mmL	0.35	-	25	-	11,20€
51718	Ø 55mmL x 150mmL	0.50	-	25	-	14,80€
51719	Ø 55mmL x 200mmL	0.65	-	25	-	22,00€
51720	Ø 55mmL x 250mmL	0.85	-	25	350	23,50€
51721	Ø 55mmL x 300mmL	1.00	-	25	375	25,00€
51722	Ø 60mmL x 100mmL	0.36	-	25	750	13,10€
51723	Ø 60mmL x 150mmL	0.50	-	25	450	18,70€
51724	Ø 60mmL x 200mmL	0.66	-	25	400	24,40€
51725	Ø 60mmL x 250mmL	0.83	-	25	-	28,30€
51726	Ø 60mmL x 300mmL	0.96	-	25	250	31,40€
51727	Ø 60mmL x 400mmL	1.62	-	25	200	49,00€

DISPONIBILE IN SCATOLA SINGOLA

ACCESSORI PER PNEUMATICI

368 CONTRAPPESI

369 RIPARAZIONE DELLE FORATURE

370 VALVOLE PNEUMATICI

371 ESTRAZIONE E INSTALLAZIONE DI PNEUMATICI

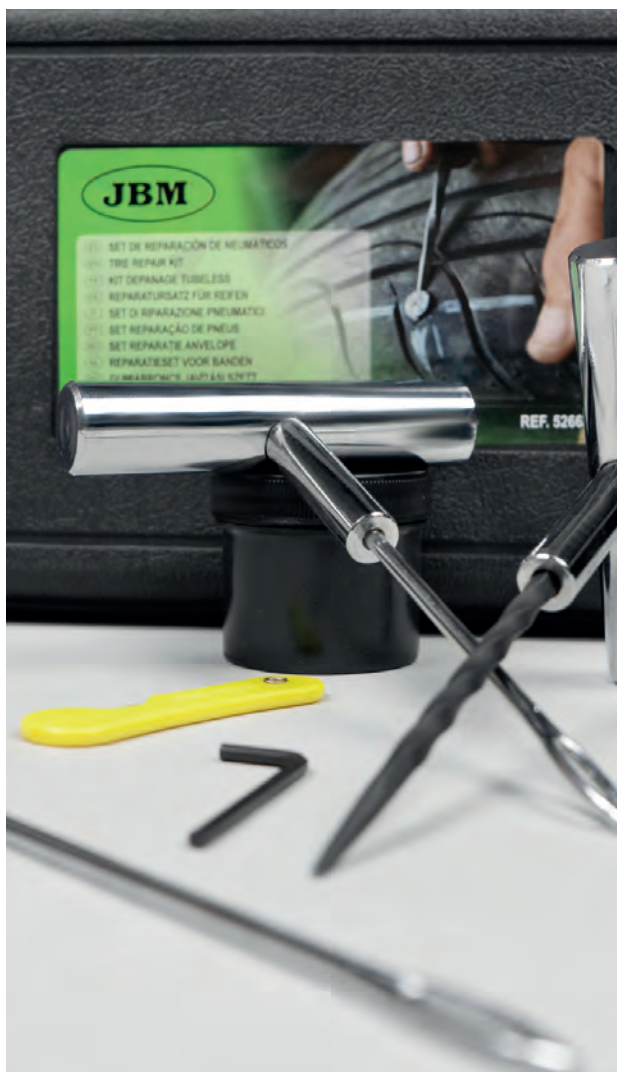

ACCESSORI PER PNEUMATICI

51908

44,00€



DISPENSER DI CONTRAPPESI ADESIVI 5GRX1.000

- 1.000 barrette da 5g.
- Adesivo di 4 mm di spessore.
- Dimensioni del dispenser: 29,5 cm x 29,5 cm.



Con magneti di ritenzione in eccesso.

53256

34,00€



DISPENSER DI CONTRAPPESI ADESIVI 5G X 1.000

- 1.000 barrette da 5g.
- Adesivo di 4 mm di spessore.
- Dimensioni del dispenser: 29,5 cm x 29,5 cm.



CONTRAPPESO ADESIVO

REF.	g					€
50600	45g: 3x5g/3x10g	0.05	100	400	36000	0,60€
50601	45g: 3x5g/3x10g	0.05	100	400	48000	0,29€



50600
ZINC



50601
FERRO

CONTRAPPESO ADESIVO IN FERRO

REF.	g					€
52665	60g: 12x5g	0.06	100	400	20000	0,37€
52666	60g: 4x10g/4x5g	0.06	100	400	20000	0,36€



52665



52666

CONTRAPPESO A GRAFFA IN ZINCO

SPECIALE CERCHIO UNIVERSALE

REF.	g					€
50760	5g	0.01	100	1600	80000	0,10€
50761	10g	0.01	100	1600	102400	0,19€
50762	15g	0.02	100	800	76800	0,29€
50763	20g	0.02	100	800	64000	0,38€
50764	25g	0.03	100	800	48000	0,49€
50765	30g	0.03	100	600	50400	0,58€
50766	35g	0.04	100	400	32000	0,68€
50767	40g	0.04	100	400	25600	0,78€
50768	45g	0.05	100	400	32000	0,88€
51055	50g	0.05	100	400	2000	0,98€



SPECIALE CERCHIO IN LEGA

REF.	g					€
50778	5g	0.01	100	1600	80000	0,10€
50779	10g	0.01	100	800	76800	0,19€
50780	15g	0.02	100	1200	60000	0,29€
50781	20g	0.02	100	800	80000	0,38€
50782	25g	0.03	100	600	48000	0,49€
50783	30g	0.03	100	600	30000	0,58€
50784	35g	0.04	100	400	32000	0,68€
50785	40g	0.04	100	400	32000	0,78€
50786	45g	0.05	100	400	32000	0,88€
51604	50g	0.05	100	400	25600	0,98€



CONTRAPPESO UNIVERSALE CAMION

REF.	g					€
52667	50g	0.05	50	400	25600	0,76€
52668	100g	0.10	25	200	12800	1,49€
52669	150g	0.15	20	160	10240	2,22€
52670	200g	0.20	10	80	5120	2,95€
52671	250g	0.25	10	80	5120	3,70€
52672	300g	0.30	10	80	5120	4,45€



52667



52668



52669



52670



52671



52672

53864

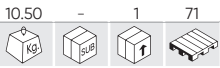

138,00€



VALIGETTA DI CONTRAPPESI ASSORTITI

CONTRAPPESO IN ZINCO CON GRAFFA

SPECIALE CERCHIO UNIV.

- 5g - 20 uds (ref. 50760)
- 10g - 20 uds (ref. 50761)
- 15g - 20 uds (ref. 50762)
- 20g - 20 uds (ref. 50763)
- 25g - 20 uds (ref. 50764)
- 30g - 10 uds (ref. 50765)
- 35g - 10 uds (ref. 50766)
- 40g - 10 uds (ref. 50767)

SPECIALE CERCHIO IN LEGA

- 5g - 20 uds (ref. 50778)
- 10g - 20 uds (ref. 50779)
- 15g - 20 uds (ref. 50780)
- 20g - 20 uds (ref. 50781)
- 25g - 20 uds (ref. 50782)
- 30g - 10 uds (ref. 50783)
- 35g - 10 uds (ref. 50784)
- 40g - 10 uds (ref. 50785)

CONTRAPPESO ADESIVO IN BARRETTE

60gr: 4x10gr 4x5gr - 70u. (ref. 52666)



51355



19,00€

PINZA SPECIALE PER CONTRAPPESI



- Toglie facilmente e sostituisce i contrappesi.
- Taglia e piega con facilità
- Realizzata in acciaio temperato.
- Include manico ergonomico.
- Con molle automatico in aperto ne'll impugnatura per agevolarne l'uso.



53150

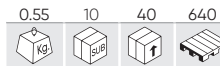

24,00€

COMPRESSORE D'ARIA PORTATILE



54013

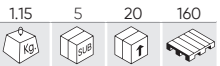

35,00€

KIT DI RIPARAZIONE PNEUMATICI - LIQUIDO SIGILLANTE E COMPRESSORE D'ARIA

REF.	DESCRIZIONE	Kg	SUB	Q	P	€
A 15317	BORSA PER KIT 54013 (53150)	0.10	-	220	-	4,50€
B 15300	LIQUIDO SIGILLANTE PER PUNTURE - 500ML	0.50	-	12	936	5,00€
C 11960	ESTRATTORE OBICI	0.01	10	500	-	1,50€
D 53150	COMPRESSORE D'ARIA PORTATILE	0.55	10	40	640	24,00€

- Sigilla le forature con diam. fino a 6 mm.
- Non provoca la corrosione del metallo ne' della gomma.
- Liquido infiammabile e incongelabile con durata elevata.



51814

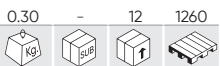

8,00€

SPRAY PER RIPARARE FORATURE 300ML

300ml



52653

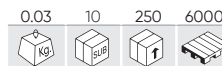

3,00€

STRUMENTO PER OBICI

- Per installare e disinstallare OBICI.



52652

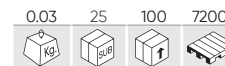

2,80€

CHIAVE MULTIFUNZIONALE OBICI



ACCESSORI PER PNEUMATICI

52662
36,50€

KIT DI RIPARAZIONE PNEUMATICI



- A 1 x puntal de trivelo
- B 1 x trivella de inserire stoppini
- C 1 x utile per gonfiare pneumatici
- D 4 x bombole 16gr
- E 1 x fresa
- F 10 x stoppini
- G 1 x chiave obici multifunzione

52663
30,00€

KIT DI RIPARAZIONE PNEUMATICI



- A 1 x trivella de inserire stoppini
- B 1 x punta di trivello de inserire stoppini
- C 1 x trivella di perforazione
- D 1 x fresa
- E 20 x stoppini
- F 1 x lubrificanti

REF.	DESCRIZIONE					€
12973	STOPPINO DI RICAMBIO PER 52662/52663	0.01	10	500	13500	1,00€
13805	VITE PER INSERIMENTO DELLA MICCIA (NO. 52663)	0.50	10	50	-	10,50€
13806	COCLEA PERFORANTE (NO. 52663)	0.35	5	50	-	10,50€

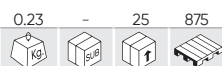
52673
18,00€

SET DI TAPPI E NUCLEI PER VALVOLE PNEUMATICHE



RICAMBI DISPONIBILI

REF.	DESCRIZIONE				€
11903	SACCO 16U. TAPPO DI ALLUMINIO PARA VALVOLA PNEUM.	0.01	1	100	5,00€
11904	SACCO 50U. TAPPO PLÁSTICO VERDI P/VALVOLA PNEUM.	0.10	10	500	2,00€
11905	SACCO 50U. TAPPO PLÁSTICO NERO P/VALVOLA PNEUM.	0.01	-	10	1,50€
11906	SACCO 50U. DI OBICI STANDARD	0.04	-	100	8,50€
11907	SACCO 50U. DI OBICI ALTA PRESSIONE	0.05	-	100	11,00€
11960	ESTRATTORE OBICI	0.01	10	500	1,50€

DISPONIBILE ANCHE

REF.	DESCRIZIONE				€
11900	SET CON 4 TAPPI IN ALLUMINIO PER VALVOLA PNEUMATICA	0.01	4	25 250	3,50€
11901	TAPPO DI PLÁSTICO VERDI P/VALVOLA PNEUM.	0.01	4	25 500	2,50€
11902	SET DI 4 TAPPI DI PLÁSTICO NERO P/VALVOLA PNEUM.	0.01	4	25 300	3,50€

VALVOLE PER CERCHI

REF.	DESCRIZIONE					€
51741	TR413 45mm	0.01	100	1000	48000	0,50€
51742	TR414 51mm	0.01	100	1000	48000	0,50€
51743	TR418 64mm	0.02	100	1000	48000	0,55€



STRUMENTO PER INSTALLARE VALVOLE

REF.	DESCRIZIONE					€
52649	METAL	0.32	10	50	2250	5,00€
52650	PLASTICO	0.15	10	100	2400	5,00€



52657 37,50€

0.18 5 20 800

STRUMENTO PER CAMBIO GOMME PER RIMUOVERE PNEUMATICI



52658 39,70€

0.17 - 20 800

STRUMENTO PER CAMBIO GOMME PER RIMUOVERE PNEUMATICI



52659 39,70€

0.26 - 20 1920

STRUMENTO PER CAMBIO GOMME PER RIMUOVERE PNEUMATICI



54329 37,50€

0.20 10 100 -

N

STRUMENTO PER CAMBIO GOMME PER RIMUOVERE PNEUMATICI

EUR - MADE IN SPAIN

52655 39,70€

0.39 - 25 1500

LEVA PLASTICA PER RIMUOVERE PNEUMATICI

↑ 155-180mm ← 95mm

52656 39,50€

0.40 5 20 1920

LEVA PLASTICA PER RIMUOVERE PNEUMATICI

↑ 160mm ← 170mm ↘ 55mm

LEVA PER TOGLIERE IL PNEUMATICO DAL CERCHIO

REF.	"					€
51362	12" (30,48cm)	0.15	5	60	500	3,00€
51358	16" (40,64cm)	0.47	6	24	1008	7,50€
51359	24" (60,96cm)	0.90	6	30	1440	9,00€



CILINDRO CENTRALE

REF.	mm					€
52645	25x22x2,5mm	0.01	50	1000	38000	0,55€
52646	25x12x2,0mm	0.00	50	1000	80000	0,50€
53037	23x12x2,5mm	0.01	50	1000	35000	0,50€
53038	21x12x2,5mm	0.01	50	1000	35000	0,50€
53039	25x19x2,5mm	0.02	50	1000	35000	0,50€
53040	25x9x2,5mm	0.01	50	1000	35000	0,50€



52664

168,00€



LEVA PER IL CAMBIO DI PNEUMATICI INDUSTRIALI



53605

141,00€



950mm

MACCHINA PER MONTAGGIO PNEUMATICO MANUALE

- Uso: Tutti i pneumatici da 8 pollici a pneumatici per camion leggeri (7-1/2 pollici x 16 pollici).
- Tenuta di strada: Fino a 12.5L 16.
- Contiene: 1 manovella per rompere il tallone del pneumatico della lunghezza di 37 pollici. Strumento di montaggio/ smontaggio.



52660

126,00€

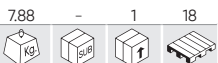

CARRELLO PORTA PNEUMATICI, CAP. 200KG



52552

128,00€



TALON DE PNEUMATICI PORTATILE

- 87-116 PSI
6-8 BAR
- MAX
10 BAR
145 PSI
- 18L
- 20°C
40°C



REF. DESCRIZIONE

REF.	DESCRIZIONE	Kg	SUB	UNITA'	€
13741	RICAMBIO 52552	0.35	-	32	21,00€

53542

980,00€

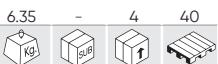

STALLONATORE PNEUMATICO



54198

59,00€



CARRELLO PER PNEUMATICI CON ROTELLE

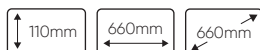

54136

107,00€

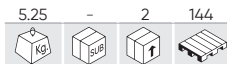

MACCHINA PER MONTAGGIO PNEUMATICO MANUALE



52842

11,00€

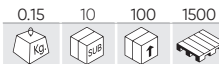

RULLO PER RIPARAZIONE DI PNEUMATICI



53419

9,70€

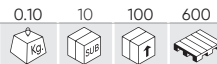

KIT DI PROTEZIONI PER CERCHI DI RUOTA (3 PZ.)



SICUREZZA E DPI

374 GUANTI / DPI

377 MASCHERINE/DISTRIBUTORE GEL

379 DELIMITAZIONE

380 TRATTAMENTI DI OZONO

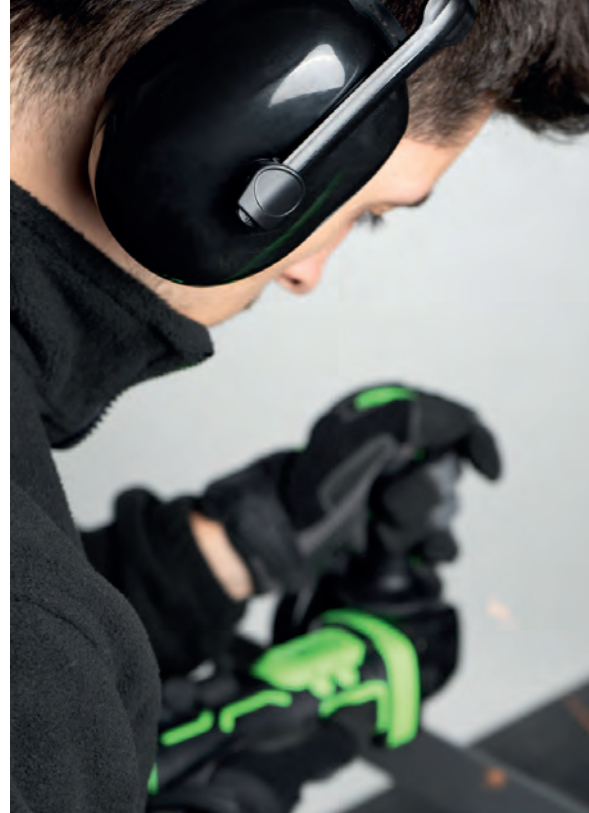



**GUANTI
100% NITRILE**

GUANTI NITRILE

3.5MIL
4.2g

REF.	UDS.				€
54294	S	100	0.40	10 500	8,00€
53984	M	100	0.45	10 500	8,00€
53985	L	100	0.50	10 500	8,00€
53986	XL	100	0.55	10 500	8,00€



3.5MIL
4.2g

REF.	UDS.				€
54155	M	100	0.46	10 570	8,00€
54156	L	100	0.50	10 570	8,00€
54157	XL	100	0.55	10 570	8,00€



5MIL
5.5g

REF.	UDS.				€
54151	M	100	0.60	10 500	9,00€
54152	L	100	0.60	10 500	9,00€
54153	XL	100	0.60	10 500	9,00€



GUANTI NITRILE - DIAMANTATI

7MIL
8.4g

REF.	UDS.				€
53551	M	100	0.90	10 300	16,00€
53552	L	100	1.00	10 300	16,00€
53553	XL	90	1.00	10 300	16,00€



7MIL
8.4g

REF.	UDS.				€
54177	M	100	0.92	10 300	16,00€
54178	L	100	0.96	10 300	16,00€
54179	XL	90	0.97	10 300	16,00€

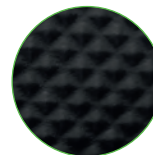

7MIL
8.4g

REF.	UDS.				€
54369	M	100	0.90	10 300	16,00€
54370	L	100	0.88	10 300	16,00€
54371	XL	100	1.05	10 300	16,00€

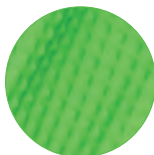

GUANTI CON IL PALMO RINFORZATO IN POLIURETANO

REF.						€	
51640N	T.8		0.05	12	144	3456	1,54€
51642N	T.9		0.01	12	144	3456	1,54€
51636N	T.10		0.05	12	144	3456	1,54€
51638N	T.11		0.05	12	144	3456	1,54€



GUANTI CON IL PALMO RINFORZATO IN NITRILE

REF.						€	
51633	T.8		0.04	12	144	3456	1,54€
51634	T.9		0.05	12	144	2592	1,54€
51632N	T.10		0.05	12	144	3456	1,54€
51398N	T.11		0.05	12	144	2592	1,54€



GUANTI DA LAVORO TERMICI

REF.						€	
54192	T.8		0.15	12	144	3456	8,90€
54193	T.9		0.10	12	144	3456	8,90€
54194	T.10		0.15	12	144	3456	8,90€
54195	T.11		0.10	12	144	3456	8,90€



GUANTI ANTI-TAGLIO TATTILI

REF.						€	
52570	T.8		0.03	12	144	3456	2,60€
52571	T.9		0.03	12	144	2592	2,60€
52572	T.10		0.03	12	144	2592	2,60€
52573	T.11		0.04	12	144	2592	2,60€



GUANTI IN PELLE

REF.						€	
52738	T.9		0.10	12	144	2304	5,00€
52739	T.10		0.12	12	144	2304	5,00€



GUANTI IN PELLE E TELA

REF.						€
52310	0.20	12	120	1920		3,65€



SICUREZZA E DPI

GUANTI IN FILO DI COTONE

REF.						€
51745	0.05	12	144	4320		0,70€



GUANTI IN FILO DI COTONE CON IL PALMO RINFORZATO A PUNTINI

REF.						€
51785	0.04	12	300	3600		1,00€



GUANTI DA LAVORO

REF.						€
54188	T.8	0.15	12	60	2040	19,00€
54189	T.9	0.15	12	60	720	19,00€
54190	T.10	0.15	12	60	720	19,00€
54191	T.11	0.15	12	60	720	19,00€



PER TOUCH SCREEN



52430

10,90€

0.34	6	24	288

CUFFIE DI PROTEZIONE OMOLOGATE



CONFORME A: EN352 - 1:2003

53785

4,80€

0.05	14	112	896

OCCHIALI DI PROTEZIONE ANTIAPPANNANTI



CONFORME A: EN166:2002-04

OCCHIALI DI PROTEZIONE SPORTIVI, ANTIAPPANNANTI

REF.					€
53596	0.01	12	144	2016	3,65€
53597	0.01	12	144	2016	3,70€
53598	0.01	12	144	2016	3,95€



IN ESPOSITORE DA 12 UNITÀ

CONFORME A: EN166:2002-04 / EN166:2003-01



53596



53597



53598

53794

28,00€

0.15	80	1280	

TERMOMETRO PROFESSIONALE A INFRAROSSI

- Misura la temperatura corporea in 1 secondo e senza contatto.
- Spegnimento automatico dopo 1 minuto.

TEMPERATURA CORPOREA	32.0°C - 42.2°C (89.6°F - 108°F)
PRECISIONE	±0.2°C (35°C - 42°C)



CE 0123
2 BATTERIE A

53862 6,00€

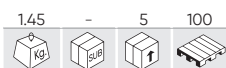

TAPPETO CON CONTENITORE PER LIQUIDO DISINFETTANTE

- Misure: 85x55x10cm
- Materiale: TPE
- Capacità massima consigliata: 3L
- Capacità massima: 8L



53863 3,00€

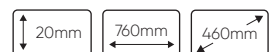

TAPPETO ASSORBENTE

- Misure: 76x48 cm
- Materiale: poliestere



53781 18,00€

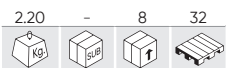

DISTRIBUTORE AUTOMATICO DI COPRISCARPE



REF.	DESCRIZIONE	kg	box	unit	€
14781	COPRISCARPE 100 PEZZI	0.25	84	336	990€

53797 0,10€

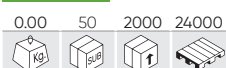

MASCHERA DI PROTEZIONE IGIENICA MONOUSO



Presentazione in scatola con 5 buste da 10 ciascuna.

USO NON MEDICO

EFFICACIA DELL'EFB ALLA FILTRAZIONE BATTERICA	>98%
RESISTENZA ALLA RESPIRAZIONE	35-50 Pa

Questo dispositivo non è un dispositivo medico ai sensi della Direttiva 93/42 o del Regolamento UE / 2017/745, né è un dispositivo di protezione individuale ai sensi del Regolamento UE / 2016/425. PER USO PERSONALE, NON RIUTILIZZABILE.

53957 0,26€

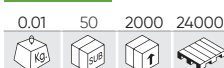

MASCHERA NERA DI PROTEZIONE IGIENICA MONOUSO



Presentazione in scatola con 5 buste da 10 ciascuna.

USO NON MEDICO

EFFICACIA DELL'EFB ALLA FILTRAZIONE BATTERICA	>90%
RESISTENZA ALLA RESPIRAZIONE	63-69 Pa

53946 0,83€



MASCHERA DI PROTEZIONE AUTOFILTRANTE FFP2 - NERA



Approvato secondo il regolamento UE 2016/425
Conforme alla norma EN149:2001+A1:2009

53826

16,00€

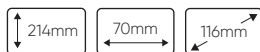
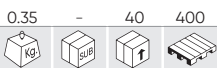

DISPENSER GEL AUTOMATICO - 400 ML

- Compatibile con sapone liquido, alcool, gel e disinfettante per le mani.
- Sensore a infrarossi spia LED blu.
- Dosaggio: 1ml.
- Voltaggio: 6 V (4 batterie da 1,5 V).
- Batterie non incluse.



14793

12,00€



POMPA DOSATRICE PER BOTTIGLIA DA 5L



53902

25,00€

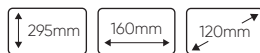
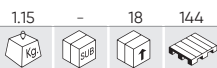

DOSATORE AUTOMATICO - 1200 ML

- Dosaggio: 0,7 ml/1,4 ml
- Distanza di attivazione del sensore: 80-120 mm
- Tensione: 6 V, 1,5 A
- (4 batterie da 1,5 V dimensione tipo C - incluse)
- Dimensioni d'ingombro: 160x120x295mm
- Materiale: ABS



53827

32,00€



SUPPORTO PER DISPENSER DI GEL AUTOMATICO

- Peso: 4,3 kg.
- Materiale: acciaio.
- Colore: nero.
- Misure del vassoio: 417x67mm.
- Misure supporto dispenser: 480x133mm.
- Diametro base: 395 mm.



REF.	DESCRIZIONE	kg	unit	ml	€
15059	ADATTATORE AC/DC 6V 1.5A	0.10	-	200	10,00€
15062	BATTERIA R14 C1.5V	0.05	24	480	1,00€

ESTENSIBILE
1.25m - 1.58m

53832

1,81€



GEL DA MANI IGIENIZZANTE 60ML



IN ESPOSITORE
DA 24 UNITÀ

53791

4,80€



GEL DA MANI IDROALCOLICO 500ML



52493

4,50€



PISTOLA DI PLASTICA UNIVERSALE PER SPRAY



53940 13,20€

0.55 - 6 90

850mm

PALO IN PLASTICA PER CATENA - GIALLO / NERO

- Materiale: PVC.
- La base si può riempire di acqua o sabbia.

CATENA NON INCLUSA.



54322 19,00€

0.10 - 100 -

N

SET DI 2 CARTELLI DI AVVERTIMENTO PER L'ALTA TENSIONE

165mm 500mm



53987 9,50€

0.59 - 40 560

NASTRO SEGNALETICO GIALLO/NERO - 200M

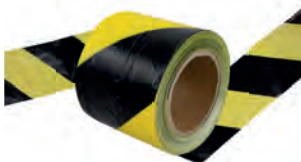

53942 0,50€

0.01 50 5000 75000

ANELLO DELLA CATENA IN PLASTICA NERO



54326 7,30€

0.30 - 20 720

N

CATENA IN PLASTICA - 7M - GIALLO/NERO

7m



53808 16,50€

0.55 - 6 114

850mm

PALO IN PLASTICA PER CATENA

- Materiale: PVC.
- La base si può riempire di acqua o sabbia.



53914 75,00€

8.50 - 5 90

PALO DI SEPARAZIONE CON NASTRO RETRATTILE

- Materiale: acciaio
- Diametro del tubo: 63 mm
- Diametro di base: 320 mm
- Altezza: 910 mm

- Nastro su 4 lati
- Lunghezza del nastro: 3 m
- Larghezza della nastro: 48 mm



53811 8,90€

0.45 - 40 560

NASTRO SEGNALETICO BIANCO-ROSSO - 200M



53839 0,25€

0.01 10 2000 16000

ANELLO DELLA CATENA IN PLASTICA



53809 8,00€

0.30 - 40 960

CATENA IN PLASTICA - 5M

- Lunghezza: 5 m
- Collegamento: 6mm
- Colore: rosso / bianco

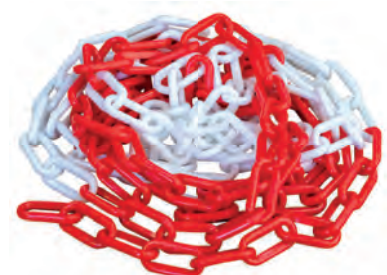

53796

76,00€

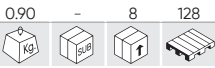

GENERATORE PORTATILE DI OZONO 600 MG/H (12V/220V)

TEMPORIZADOR
TIMER

15W

15m³/h

O₃
600mg/h

12V

220V

3x10⁶
Ions/cm³



600mg/h

Temporizador/Timer	30/30min	60min	HOLD
--------------------	----------	-------	------

53786

98,00€



GENERATORE PORTATILE DI OZONO 5000 MG/H (220V)

67W

80 CFM

2 Amp

5x20mm

TEMPORIZADOR
TIMER

O₃
5000mg/h



5.000mg/h

50m ³	20 min
100m ³	40 min
150m ³	60 min
200m ³	80 min
300m ³	100 min

REF. DESCRIZIONE



€

14775	PIASTRA DI RICAMBIO PER GENERATORE PORTATILE DI OZONO (RIF. 53786)	0.02	-	1	-	30,50€
-------	--	------	---	---	---	--------

53806

250,00€

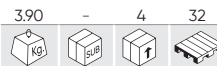

GENERATORE PORTATILE DI OZONO 20000 MG/H (220V)

TEMPORIZADOR
TIMER

190W

50 dB

O₃
L:1000mg/h
H:20000mg/h

220V

240V

120 CFM

O₃
2000mg/h



10.000mg/h

50m ³	8 min
100m ³	16 min
150m ³	24 min
200m ³	32 min
300m ³	48 min
500m ³	65 min

20.000mg/h

500m ³	30 min
600m ³	40 min
700m ³	50 min
800m ³	60 min
900m ³	70 min
1.000m ³	80 min

REF. DESCRIZIONE



€

14803	PIASTRA DI RICAMBIO PER GENERATORE PORTATILE DI OZONO	0.03	-	50	-	43,00€
-------	---	------	---	----	---	--------

53838

38,00€

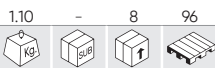

SCATOLA PER IL TRATTAMENTO DELL'OZONO

12V

Amp
0.38
0.42

5V

2W

UV
1550
µW/cm²

O₃
1.5-2.0mg/h

3 MIN



- Lunghezza d'onda ultravioletta: 254nm
- Presa di alimentazione: connettore Micro-USB
- La scatola è facilmente assemblabile e smontabile, facilitando così il suo trasporto.

ESTESO



PIEGATO



53802

120,00€

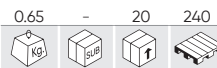

MISURATORE DI OZONO

- Precisione: ≤±5% F.S.
- Campo di misura: 0-50ppm (0-98mg/m³)
- Allarme bassa: 5ppm (9.8mg/m³)
- Allarme alta: 10ppm (19.6 mg/m³)
- Tempo di risposta: <30 segundos
- Campo di temperatura di esercizio: -10°C - 55°C
- Protezione IP65.



DUE LIVELLI DI ALLARME CONFIGURABILI PER DIVERSI LIVELLI DI CONCENTRAZIONE

TEMPO DI FUNZIONAMENTO: >8H

TEMPO DI CARICAMENTO: 4H-6H



CONFORME A:
EN61326-1, EN61000-4-2, EN61000-4-3

CONSUMABILI

383 PERNI E CIRCLIPS

384 RIVETTI

384 VITI, DADI E RONDELLE

388 RONDELLE CARTER E MOTORE

391 ALTRO

391 GUARNIZIONI E O-RING

392 CONNETTORI PER TUBI

393 ELETTRICI

396 RIVETTI DI PLASTICA



52044

19,00€

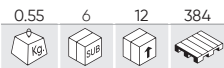

ASTUCCIO CLIP "R" 150 PEZZI



REF.	Image	PCS	€
10793		2,3x43	25 0,25€
10794		3,2x52	20 0,40€
10795		3,8x75	8 0,60€
10882		2x32	42 0,25€
10883		1,6x36	30 0,25€
10884		1,6x42	25 0,25€

52027

14,00€

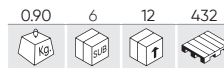

ASTUCCIO CON SPINOTTI 365 PEZZI



REF.	Image	PCS	€
10796		1,2x25	50 0,07€
10797		1,6x32	50 0,09€
10798		2x40	50 0,12€
10799		2,5x40	50 0,13€
10800		3,2x40	50 0,15€
10801		3,2x50	50 0,17€
10802		4x50	40 0,19€
10803		5x63	10 0,05€
10804		6,3x63	15 0,22€

53348

14,00€

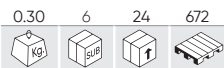

ASTUCCIO DI ANELLI AD "E"



Image	PCS
	M1.5 - 1/16" 15
	M3 - 1/8" 15
	M5 - 3/16" 20
	M6 - 1/4" 25
	M9 - 3/8" 25
	M12 - 1/2" 20
	M15 - 5/8" 10
	M19 - 3/4" 10
	M22 - 7/8" 10

53350

14,00€

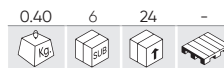

ASTUCCIO DI SPINE ELASTICHE



1/16" x 3/16"	4	3/16" x 5/8"	5
1/16" x 5/16"	4	3/16" x 1"	5
1/16" x 3/4"	4	3/16" x 1-1/4"	5
5/64" x 1/4"	4	7/32" x 5/8"	4
5/64" x 1/2"	4	7/32" x 1-1/4"	4
5/64" x 1"	4	7/32" x 1-3/4"	4
3/32" x 5/8"	4	1/4" x 5/8"	4
3/32" x 1"	4	1/4" x 1-1/4"	4
3/32" x 1-1/4"	4	1/4" x 1-3/4"	4
1/8" x 5/8"	5	5/16" x 3/4"	4
1/8" x 1"	5	5/16" x 1-1/2"	4
1/8" x 1-1/4"	5	5/16" x 2"	4
5/32" x 5/8"	4	3/8" x 3/4"	2
5/32" x 1"	4	3/8" x 1-1/2"	2
5/32" x 1-1/2"	4	3/8" x 2"	2

53363

34,00€

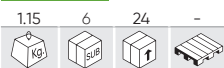

ASTUCCIO DI PERNI CON FORO PER COPIGLIA



Image	PCS
	3.5x44 6
	2.5x42 20
	2.5x58 7
	2x3 7

Image	PCS
	8x50 5
	9.5x50 18
	11x63 5
	12.5x50 3

53364

16,00€



ASTUCCIO DI CHIAVETTE



Image	PCS
	3x3x25 4
	3x3x20 4
	5x5x30 5
	5x5x25 5
	5x5x20 5
	6x6x40 5
	6x6x30 5
	6x6x20 5
	8x8x40 5
	8x8x30 5
	10x10x40 5
	10x10x30 5
	12x12x40 2

53371

29,00€

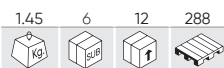

ASTUCCIO DI PERNI DI FISSAGGIO CON ANELLO

50 PCS



	PCS
5x36	16
6x45	18
8x45	6
11x45	10

53372

26,00€



ASTUCCIO DI COPIGLIE IN ACCIAIO INOX

144 PCS



	PCS
M3x50	50
M4x60	30
M5x75	20
M6x50	20
M6x75	16
M8x60	8

53373

14,50€



ASTUCCIO DI RONDELLE ONDULATE

260 PCS



	PCS
M3x10	30
M4x12	30
M5x14	40
M6x14	50
M8x18	50
M10x20	40
M12x25	20

53383

11,50€

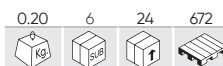

ASTUCCIO DI RONDELLE ESTERNE SEEGER

300 PCS



	PCS
M4	50
M6	40
M8	45
M10	30
M12	30
M14	25
M16	25
M18	25
M20	15
M22	15

53382

11,00€



ASTUCCIO DI RONDELLE INTERNE SEEGER

300 PCS



	PCS
M4	50
M6	40
M8	45
M10	30
M12	30
M14	25
M16	25
M18	25
M20	15
M22	15

52711

27,50€



ASTUCCIO DI RIVETTI PLASTICI

150 PCS



REF.		PCS	€
13674	6x19,3mm	25	0,50€
13675	6x17,8mm	25	0,50€
13676	6x25,5mm	25	0,50€
13677	6x24,5mm	25	0,50€
13678	6x24mm	50	0,50€

52703

22,00€

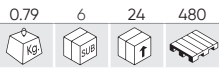

ASTUCCIO DI DADI A RIVETTO

235 PCS



REF.		PCS	€
13235	M3	50	0,15€
13236	M4	50	0,15€
13237	M5	50	0,15€
13238	M6	40	0,20€
13239	M8	20	0,20€
13240	M10	15	0,40€
13241	M12	10	0,55€

53360

18,00€

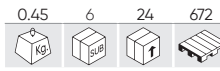

ASTUCCIO DI DADI A RIVETTO CON ZIGRINATURA IN ZINCO

150 PCS



	PCS
3x9	40
4x11	35
5x13	25
6x15	25
8x18	15
10x21	10

53361

24,00€

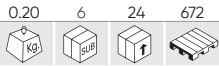

ASTUCCIO DI DADI A RIVETTO CON ZIGRINATURA IN ALLUMINIO

150 PCS



	PCS
3x9	40
4x11	35
5x13	25
6x15	25
8x18	15
10x21	10

52043

16,50€

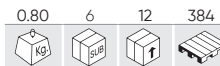

ASTUCCIO DI RIVETTI 300 PEZZI

300 PCS



REF.		PCS	€
10877	4,8x16,90mm	50	0,25€
10878	4,8x24,80mm	40	0,30€
10879	3,2x9,70mm	90	0,20€
10880	4,8x12,70mm	70	0,20€
10881	4,80x20mm	50	0,25€

53351

12,50€

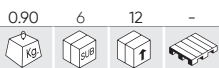

ASTUCCIO DI VITI METRICHE CON TESTA ESAGONALE

240 PCS



	PCS		PCS
M4x12	10	M4	20
M4x20	10	M5	20
M5x16	10	M6	20
M5x25	10	M8	10
M6x20	10	M10	10
M6x30	10		PCS
M8x25	5	M4	20
M8x40	5	M5	20
M10x16	5	M6	20
M10x40	5	M8	10
		M10	10

53354

14,00€

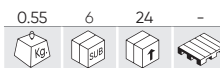

ASTUCCIO DI VITI AUTOFORANTI CON TESTA ESAGONALE

200 PCS



	PCS
#8x12.5	30
#8x16	30
#8x19	30
#8x25	30
#10x12.5	20
#10x16	20
#10x19	20
#10x25	20

53362

14,00€

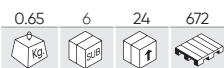

ASTUCCIO DI VITI CON TESTA AD INCAVO ESAGONALE



	PCS
4x12	25
5x12	25
5x25	20
10x40	3
6x25	10
8x40	5
10x25	3
6x12	10
8x25	5



53365

14,00€

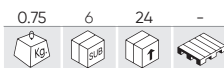

ASTUCCIO DI DADI METRICI AD ALETTE



	PCS
M4	40
M5	40
M6	25
M8	25
M10	20



53366

14,00€

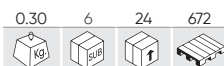

ASTUCCIO DI STAFFE A "U"



	PCS
M3.5x8	40
M4.2x16	20
M5x12	15
M6.35x19	10

	PCS
M3.5	20
M3.5 Con muesca/with notch	20
M4	20
M5	15
M6.35	10



53369

14,00€



ASTUCCIO DI VITI AUTOFILETTANTI A TESTA SVASATA



	PCS
2.8x13mm	65
2.8x16mm	55
3.5x10mm	60
3.5x13mm	65
3.5x16mm	60
3.5x19mm	45
4.2x13mm	50
4.2x16mm	40
4.2x25mm	30
4.2x31mm	20
4.8x19mm	25
4.8x25mm	20
4.8x32mm	15



52029

14,00€



ASTUCIO CON DADI AUTOBLOCCAGGIO 228U.



	PCS
M3	50
M4	50
M5	40
M6	30
M8	20
M10	15
M12	10
M14	8
M16	5



52028

15,20€



ASTUCCIO CON DADI 243 PEZZI



REF.		PCS	€
10805	M3	50	0,10€
10779	M4	50	0,05€
10780	M5	50	0,05€
10781	M6	30	0,05€
10784	M8	20	0,05€
10785	M10	20	0,10€
10786	M12	10	0,15€
10812	M14	8	0,30€
10813	M16	5	0,30€



52032

28,00€

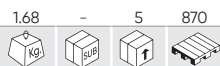

ASTUCCIO DI RONDELLE DI RAME NERO 1.735 PEZZI

1735 PCS

	PCS
3mm	600
4mm	400
5mm	220
6mm	220
8mm	110
10mm	65
12mm	50
14mm	40
16mm	30



53377

20,00€

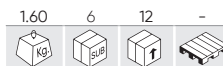

ASTUCCIO DI RONDELLE

240 PCS

	PCS
20x6x1.5	20
20x8x1.5	20
20x10x1.5	20
25x6x1.5	20
25x8x1.5	20
25x10x1.5	20
32x2x1.5	20
32x4x1.5	20
32x6x1.5	20
32x8x1.5	20
32x10x1.5	20
32x10x1.5	20



52158

38,50€



ASTUCCIO DI RONDELLE DI FERRO GALVANIZZATO, 475PCS

475 PCS

	PCS		PCS
5x20x1.5	50	6x30x2	25
6x20x1.5	50	7x30x2	25
7x20x1.5	50	8x30x2	25
8x20x1.5	50	4x11x0.98	50
8x25x1.75	50	12x40x3	25
10x30x2.5	25	4x20x1.5	50



51804

58,00€



ASTUCCIO CON ASSORTIMENTO DI BULLONI, DADI E RONDELLE

828 PCS

REF.	DESCRIZIONE	PCS	€
10772	VITE ZINCATA DIN 933 8.8 M4X25	25	0,05€
10773	VITE ZINCATA DIN 933 8.8 M5X50	25	0,10€
10774	VITE ZINCATA DIN 933 8.8 M6X50	25	0,10€
10775	VITE ZINCATA DIN 933 8.8 M7X50	15	0,15€
10776	VITE ZINCATA DIN 933 8.8 M8X50	15	0,20€
10777	VITE ZINCATA DIN 933 8.8 M10X50	12	0,20€
10778	VITE ZINCATA DIN 933 8.8 M12X60	20	0,35€
10779	DADO ZINCATO DIN 934 M4	50	0,05€
10780	DADO ZINCATO DIN 934 M5	50	0,05€
10781	DADO ZINCATO DIN 934 M6	50	0,05€
10782	DADO ZINCATO DIN 934 M7	50	0,05€
10783	RONDELLA ZINCATA DIN 125 M12	50	0,05€
10784	DADO ZINCATO DIN 934 M8	50	0,05€
10785	DADO ZINCATO DIN 934 M10	50	0,10€
10786	DADO ZINCATO DIN 934 M12	40	0,15€
10787	RONDELLA ZINCATA DIN 125 M4	50	0,05€
10788	RONDELLA ZINCATA DIN 125 M5	50	0,05€
10789	RONDELLA ZINCATA DIN 125 M6	50	0,05€
10790	RONDELLA ZINCATA DIN 125 M7	50	0,05€
10791	RONDELLA ZINCATA DIN 125 M8	50	0,05€
10792	RONDELLA ZINCATA DIN 125 M10	50	0,05€

REF.	DESCRIZIONE	PCS	€
50959	CASSETTA 20+1 SCOMPARTIMENTI	1	14,00€



53464

153,00€



551 PCS

ASTUCCIO DI RONDELLE DI RAMA PER INIETTORI 551 PZ.

RICAMBI DISPONIBILI

REF.	DESCRIZIONE	PCS	€
13945	Ø15.0x8.0x1.5 - UNIVERSAL	30	7,40€
13946	Ø15.0x7.0x1.5 - MERCEDES	12	6,70€
13947	Ø13.0x7.5x2.5 - RENAULT	30	5,85€
13948	Ø15.0x7.5x1.5 - IVECO, FORD, BMW, MAN	30	5,00€
13949	Ø15.0x7.5x2.0 - IVECO, FORD, BMW, MAN	30	6,50€
13950	Ø15.45x8.0x2.0 - UNIVERSAL	30	7,80€
13951	Ø13.5x10x2.0 - MAZDA (REF.. 53464)	12	5,15€
13952	Ø15.5x7.5x2.5 - FORD	30	10,90€
13953	Ø15.5x7.5x1.5 - LAND ROVER	12	8,00€
13954	Ø15.0x7.5x3.0 - RENAULT	30	12,70€
13955	Ø13.0x7.0x1.5 - DEUTZ	12	4,95€
13956	Ø13.5x7.5x1.5 - FORD	30	4,30€
13957	Ø15.0x7.5x1.5 - FIAT	12	9,70€
13958	Ø15.5x7.5x1 - MAN ROVER	12	5,45€
13959	Ø16.5x7.5x2 - MERCEDES	30	10,10€
13960	Ø13.7x7.3x3 - KIA	12	9,65€
13961	Ø13.7x7.3x2 - KIA	12	9,25€
13962	Ø10x6.0x1.0	50	1,76€
13963	Ø15.8x7.5x3.0	30	12,40€
13964	SACCA DI 30 CONNETTORI TUBO IN "T"	20	15,00€
13965	Ø8x5.8x1	30	1,50€
13966	SACCA DI 30 CONNETTORI TUBO IN "L"	30	12,90€
13967	SACCA DI 30 RITEGNO SPRINGS	25	4,65€



52031

44,00€



ASTUCCIO DI RONDELLE D'ALLUMINIO - 18 TIPI - 900 PEZZI



Ø	PCS
3x7x1.5	50
4x8x1.5	50
5x6x1.5	50
16x22x1.5	50
14x22x1.5	50
14x20x1.5	50
6x10x1.5	50
6x11x1.5	50
7x11x1.5	50
7x12x1.5	50
8x12x1.5	50
8x14x1.5	50
9x12x1.5	50
10x14x1.5	50
11x16x1.5	50
11x17x1.5	50
12x16x1.5	50
12x18x1.5	50



53353

18,00€



ASSORTIMENTO DI RONDELLE IN RAME



Ø	PCS
M6	30
M8	25
M10	20
M12	15
M14	10
M16	10



52163

95,00€

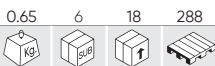

ASTUCCIO RONDELLE DI RAME



RICAMBI DISPONIBILI

REF.	mm	PCS	€
51538	Ø 10mm	100	0,15€
51539	Ø 12mm	100	0,15€
51540	Ø 14mm	100	0,15€
51541	Ø 16mm	100	0,25€
51542	Ø 18mm	100	0,20€
51543	Ø 20mm	25	0,25€

POTREBBE PIACERTI ANCHE...

REF.	mm	PCS	€
51544	Ø 22mm	100	0,25€
51545	Ø 26mm	100	0,30€

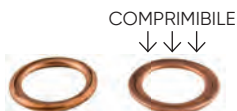

52030

98,00€



ASTUCCIO DI RONDELLE DI RAME - 18TIPI- 900 PEZZI



RICAMBI DISPONIBILI

REF.	mm	PCS	€
10823	3x7x1,5mm	50	0,20€
10824	4x8x1,5mm	50	0,20€
10825	5x6x1,5mm	50	0,20€
10826	16x22x1,5mm	50	0,40€
10827	14x22x1,5mm	50	0,60€
10828	14x20x1,5mm	50	0,45€
10829	6x10x1,5mm	50	0,20€
10830	6x11x1,5mm	50	0,20€
10831	7x11x1,5mm	50	0,20€

REF.	mm	PCS	€
10832	7x12x1,5mm	50	0,20€
10833	8x12x1,5mm	50	0,20€
10834	8x14x1,5mm	50	0,25€
10835	9x12x1,5mm	50	0,25€
10836	10x14x1,5mm	50	0,30€
10837	11x16x1,5mm	50	0,30€
10838	11x17x1,5mm	50	0,30€
10839	12x16x1,5mm	50	0,40€
10840	12x18x1,5mm	50	0,35€



ASTUCCIO DI RONDELLE DI RAME PER INIETTORI

53229

38,70€



PCS	PCS
13,8 x 7,3 x 1,4mm 10	15,0 x 7,5 x 3,0mm 10
14,6 x 7,5 x 1,3mm 10	15,5 x 7,5 x 2,0mm 10
14,6 x 7,5 x 3,0mm 10	16,0 x 7,5 x 1,5mm 10
15,0 x 7,0 x 2,0mm 10	16,0 x 7,5 x 1,7mm 10
15,0 x 7,5 x 1,0mm 10	16,0 x 7,5 x 2,0mm 10
15,0 x 7,5 x 1,5mm 10	16,4 x 7,5 x 2,0mm 10
15,0 x 7,5 x 2,0mm 10	20,0 x 9,4 x 0,9mm 10
15,0 x 7,5 x 2,5mm 10	



53340

86,00€



PCS	PCS
13,8 x 7,3 x 1,4mm 25	15,0 x 7,5 x 3,0mm 25
14,6 x 7,5 x 1,3mm 25	15,5 x 7,5 x 2,0mm 25
14,6 x 7,5 x 3,0mm 25	16,0 x 7,5 x 1,5mm 25
15,0 x 7,0 x 2,0mm 25	16,0 x 7,5 x 1,7mm 25
15,0 x 7,5 x 1,0mm 25	16,0 x 7,5 x 2,0mm 25
15,0 x 7,5 x 1,5mm 25	16,4 x 7,5 x 2,0mm 25
15,0 x 7,5 x 2,0mm 25	20,0 x 9,4 x 0,9mm 25
15,0 x 7,5 x 2,5mm 25	



53229 - 53340 RICAMBI DISPONIBILI

REF.	mm	PCS	€
13819	13,8 x 7,3 x 1,4mm	50	6,50€
13820	14,6 x 7,5 x 1,3mm	50	7,00€
13821	14,6 x 7,5 x 3,0mm	50	14,00€
13822	15,0 x 7,0 x 2,0mm	50	11,00€

REF.	mm	PCS	€
13823	15,0 x 7,5 x 1,0mm	50	6,00€
13824	15,0 x 7,5 x 1,5mm	50	8,00€
13825	15,0 x 7,5 x 2,0mm	50	11,50€
13826	15,0 x 7,5 x 2,5mm	50	13,00€

REF.	mm	PCS	€
13827	15,0 x 7,5 x 3,0mm	50	15,00€
13828	15,5 x 7,5 x 2,0mm	50	11,50€
13829	16,0 x 7,5 x 1,5mm	50	10,50€
13830	16,0 x 7,5 x 1,7mm	50	10,50€

REF.	mm	PCS	€
13831	16,0 x 7,5 x 2,0mm	50	12,60€
13832	16,4 x 7,5 x 2,0mm	50	13,00€
13833	20,0 x 9,4 x 0,9mm	50	9,00€

54390

199,00€



N

SET DI RACCORDI E TUBI PER CARBURANTE (95 PEZZI)

RICAMBI DISPONIBILI

REF.	mm	PCS	€	REF.	mm	PCS	€
16462	6,3x6mm	3	36,50€	16538	7,5x200mm	3	19,50€
16463	7,89x8mm	3	36,50€	16539	12x200mm	1	18,00€
16464	9,49x8 mm	3	36,50€	16540		1	13,00€
16465	9,89x8 mm	3	39,50€	16541	6x340mm	2	13,00€
16466	11,80x10mm	3	50,00€	16542	8x340mm	6	23,50€
16467	6,3x6 mm	3	36,50€	16543	9,5x340mm	2	13,00€
16468	7,89x8 mm	3	36,50€				
16469	9,49x8 mm	3	36,50€				
16470	9,89x8 mm	3	39,50€				
16471	11,8x10mm	3	50,00€				
16472	6,3x6 mm	5	17,50€				
16473	7,89x8mm	5	17,50€				
16474	9,49x8 mm	5	17,50€				
16475	9,89x8mm	5	17,50€				
16476	11,8x10 mm	5	24,00€				
16477	6x7,5mm	3	24,50€				
16478	8x7,5mm	6	24,50€				
16479	15 - 18mm	12	7,50€				
16480	17-20mm	4	7,50€				

95 PCS



RONDELLA METALLO-PLASTICA

REF.	DESCRIZIONE					€
52719	RONDELLA METALLO-PLASTICA 10MM DIAM.	0.00	100	5000	150000	0,19€
51843	RONDELLA METALLO-PLASTICA 12MM DIAM.	0.01	100	5000	200000	0,19€
51554	RONDELLA GOMMA (FORD) 13MM DIAM.	0.00	100	5000	180000	0,28€
51546	RONDELLA METALLO-PLASTICA 14MM DIAM.	0.00	100	5000	150000	0,19€
51799	RONDELLA METALLO-PLASTICA 16MM DIAM.	0.01	100	120000	120000	0,20€



53599

30,30€

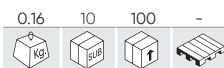

SET DI ANIME DELLA VALVOLA PER SISTEMA DI ARIA CONDIZIONATA

134 PCS

RICAMBI DISPONIBILI

REF.	mm	PCS	€	REF.	mm	PCS	€
14594	5x19mm R12	50	2,00€	14599	7x20mm R134A	10	4,50€
14595	5x19mm	30	1,50€	14600	6x22mm	5	9,50€
14596	5x19mm R12	30	2,00€	14601	8x22mm	1	11,00€
14597	6x19mm	3	7,60€	14602	9x22mm	4	11,00€
14598	6x26mm	1	17,80€				



53358

11,50€



ASTUCCIO DI MOLLE



	PCS	mm	PCS
	12	5/16x1-3/4	10
		13/64x13/16	10
		7/32x1	10
		1/4x7/8	10
	10	9/32x1/2	8
	10	5/16x1-1/8	10
	10	5/16x1-1/4	10
	10	3/16x1-3/4	8
	10	9/32x1-1/2	10
	6	11/32x1-7/16	10
	12	3/8x3/4	12
	8	23/64x1-3/8	12
	10	9/32x3/4	12



53352

12,00€

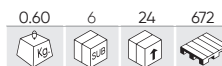

ASTUCCIO DI BULLONI A OCCHIELLO



	PCS
	50
2.4x41	12
4.2x85	5

	PCS
	60
2.4x25	12
4x45	12
4x50	12



52033

43,00€



ASTUCCIO D'INGRASSATORE 135 PEZZI



REF.	90°	PCS	€
10874	6x1	20	0,30€
10875	8x1	15	0,40€
10876	10x1	10	0,45€

REF.	ANGOLO DRITTO	PCS	€
10868	6x1	20	0,30€
10869	8x1	15	0,30€
10870	10x1	10	0,45€

REF.	45°	PCS	€
10871	6x1	20	0,30€
10872	8x1	15	0,40€
10873	10x1	10	0,45€



53359

16,00€

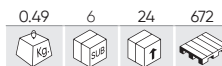

SET DI INGRASSATORI CON FILETTATURA METRICA



90°	PCS
6x1	60
8x1.25	10
10x1.5	10

ANGOLO DRITTO	PCS
6x1	5
8x1.25	5
10x1.5	5

45°	PCS
6x1	5
8x1.25	5
10x1.5	5



53378

13,00€

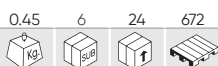

ASTUCCIO DI FASCETTE PER TUBO FLESSIBILE 20 PZ



	PCS
	4
1"	2
2-1/2"	2
1-1/4"	2
3"	2
1-3/4"	2
3-1/2"	2
2"	4
4"	2



53381

14,50€

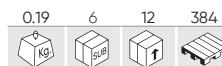

ORGANIZER DI RONDELLE IN FIBRA 600 PZ



	PCS
	160
10x5.5x1	80
16x10x1	40
19x12x1	30
22x16x1	20
22.5x14x1	20
32x22x1	100
12x6.5x1	60
16x8x1	40
20x12.5x1	20
27x20x1	15
25.4x17.5x1	15
32x24x1	15



50651

18,00€

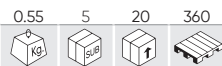

ORGANIZER DI O-RING METRICI



	COPERCHIO DEL ASTUCCIO						BASE DEL ASTUCCIO					
POSIZIONE DEL SET	006	007	008	009	010	011	211	212	213	214	215	216
LARGHEZZA DELLA GOMMA(MM)	2	2	2	2	2	2	3	3	3	3	3	3
Ø INTERNI (MM)	A 3	4	5	6	7	8	D 20	22	24	25	27	28
QUANTITÀ	16	16	16	16	16	16	12	12	12	12	12	12
POSIZIONE DEL SET	113	112	111	110	012	221	220	219	218	217		
LARGHEZZA DELLA GOMMA(MM)	B 2.5	2.5	2.5	2.5	2	E 3	3	3	3	3		
Ø INTERNI (MM)	14	12	11	10	10	36	35	33	32	30		
QUANTITÀ	13	13	13	13	17	12	12	12	12	12		
POSIZIONE DEL SET	114	115	116	210	222	325	326	327				
LARGHEZZA DELLA GOMMA(MM)	C 2.5	2.5	2.5	3	F 3	4	4	4				
Ø INTERNI (MM)	16	17	19	19	38	38	41	44				
QUANTITÀ	13	13	13	10	12	10	9	9				



50652

16,50€

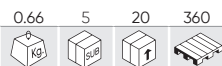

ORGANIZER DI O-RING POLLICI



	COPERCHIO DEL ASTUCCIO						BASE DEL ASTUCCIO					
POSIZIONE DEL SET	006	007	008	009	010	011	211	212	213	214	215	216
LARGHEZZA DELLA GOMMA(MM)	1/16	1/16	1/16	1/16	1/16	1/16	D 1/8	1/8	1/8	1/8	1/8	1/8
Ø INTERNI (MM)	A 1/8	5/32	3/16	7/32	1/4	5/16	13/16	7/8	15/16	1	11/16	11/18
QUANTITÀ	20	20	20	20	20	20	10	10	10	10	10	10
POSIZIONE DEL SET	113	112	111	110	012	221	220	219	218	217		
LARGHEZZA DELLA GOMMA(MM)	B 3/32	3/32	3/32	3/32	1/16	E 1/8	1/8	1/8	1/8	1/8		
Ø INTERNI (MM)	9/16	1/2	7/16	3/8	3/8	17/16	13/8	15/16	11/4	13/16		
QUANTITÀ	13	13	13	13	13	10	10	10	10	10		
POSIZIONE DEL SET	114	115	116	210	222	325	326	327				
LARGHEZZA DELLA GOMMA(MM)	C 3/32	3/32	3/32	1/8	F 1/8	3/16	3/16	3/16				
Ø INTERNI (MM)	5/8	11/16	3/4	3/4	11/2	11/2	15/8	13/4				
QUANTITÀ	13	13	13	10	10	7	7	7				
QUANTITÀ												



50807

38,00€

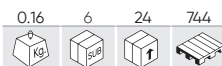

ORGANIZER DI O-RING PER ARIA CONDIZIONATA



Ø	PCS	Ø	PCS	Ø	PCS
5.29x1.78	20	8.80x1.90	20	13.95x2.62	10
6.07x1.78	20	10.82x1.78	15	14.0x2.0	10
6.8x1.9	20	10.77x2.62	15	15.0x2.0	10
7.65x1.78	20	11.0x2.0	15	17.0x2.0	10
7.80x1.90	20	12.0x2.0	15	17.17x1.78	10
8.0x2.0	20	13.9x1.80	10	17.04x3.53	10



CONSUMABILI

53910

19,00€

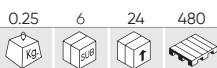

KIT DI 113 RACCORDI PER VUOTO PER AUTO



DRITTO

4.8x4.8	10
6.3x6.3	8
7.9x7.9	6
9.5x9.5	6
3.17x3.17	30

RACCORDO A T

3.9x3.9x3.9	8
4.8x4.8x4.8	8
6.3x6.3x6.3	6
9.5x9.5x9.5	3
3.17x3.17x3.17	12

RIDUTTORE

9.5x6.3	6
6.3x4.8	10



53434

18,00€

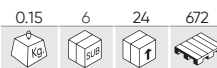

KIT DI 65 RACCORDI PER VUOTO PER AUTO



PCS

4x28.7	10
3.9x30.8	5
10.4x4.4	10
5.6x4.71	5
7.9x3.8	10
4.7x3.8.9	5
5.2x3.3.9	10
7x3.0	10



53992

18,00€



ASTUCCIO DI MANICOTTI PER SALDATURA TERMORESTRINGENTI 100PZ



Ø1.7mm / 0.25-0.34mm2 / 26-24 AWG	25
Ø2.7mm / 0.5-1.0mm2 / 22-18 AWG	35
Ø4.7mm / 1.5-2.5mm2 / 16-14 AWG	30
Ø6.0mm / 4.0-6.0mm2 / 12-10 AWG	10

53349

14,00€

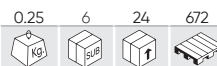

ASTUCCIO DI MANICOTTI IN GOMMA



APERTI	PCS	CHIUSI	PCS
M19,5x23	2	M25	2
M16x24	3	M22	3
M13x15	3	M19	4
M11,5x19	4	M15	5
M10x20	3	M12	10
M10x12	5	M9	20
M9,8x11,5	6	M7	20
M8x14	3		
M7,5x13	7		
M6x7,5	10		
M3,5x6	15		



53374

10,00€

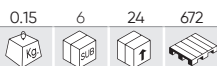

ASTUCCIO DI TUBI DI RISCALDAMENTO



REF.	PCS
M2x40	30
M2.5x40	25
M3.5x40	20
M5x40	20
M7x80	16
M10x80	8
M13x85	8



53376

10,50€



ASTUCCIO DI TUBI DI RISCALDAMENTO ROSSI



REF.	PCS
M2x40	30
M2.5x40	25
M3.5x40	20
M5x40	20
M7x80	16
M10x80	8
M13x85	8



REF. DESCRIZIONE

51920 CANNELLO A GAS

0.14 10 100 400 € 18,00€

53370

26,00€

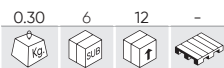

ASTUCCIO DI PASSACAVO IN GOMMA (180 PEZZI) M2,3,4,5,6,8, 10



	PCS
M2	25
M3	25
M4	30
M5	30
M6	30
M8	20
M10	20

53355

11,50€



ASTUCCIO DI FUSIBILI MINI



	PCS
5A	20
10A	20
15A	20
20A	20
25A	20
30A	20

53356

11,50€



ASTUCCIO DI FUSIBILI PER AUTO



REF.		PCS	€
10915	5A	20	0,25€
10917	10A	20	0,30€
10918	15A	20	0,30€
10919	20A	20	0,30€
10920	25A	20	0,25€
10921	30A	20	0,30€

53367

9,50€



ASTUCCIO DI FUSIBILI PER AUTO



	PCS
5A	8
10A	8
15A	8
20A	8
25A	8
30A	8

53368

9,00€



ASTUCCIO DI MINIFUSIBILI DA 50 U.



	PCS
5A	8
10A	8
15A	8
20A	8
25A	8
30A	10

53380

11,50€



ASTUCCIO DI MINIFUSIBILI



	PCS
5A	20
10A	20
15A	20
20A	20
25A	20
30A	20

52054

17,00€

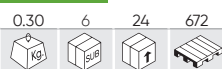

ASTUCCIO CON 252 FUSIBILI



REF.	Icon	PCS	€
10905	3A	20	0,25€
10906	4A	20	0,25€
10907	5A	20	0,25€

REF.	Icon	PCS	€
10908	7,5A	20	0,30€
10909	10A	20	0,30€
10910	15A	20	0,30€

REF.	Icon	PCS	€
10911	20A	20	0,30€
10912	25A	20	0,25€
10913	30A	20	0,30€

REF.	Icon	PCS	€
10914	4A	8	0,25€
10915	5A	8	0,25€
12954	3A	8	0,25€

REF.	Icon	PCS	€
10916	7,5A	8	0,30€
10917	10A	8	0,30€
10918	15A	8	0,30€

REF.	Icon	PCS	€
10919	20A	8	0,30€
10920	25A	8	0,25€
10921	30A	8	0,30€



52053

45,00€



ASTUCCIO CON 635 PEZZI DI TERMINALI



REF.	Icon	PCS	€
10885	RV1.25-4S	50	0,20€
10886	RV2-4S	50	0,20€
10887	RV2-6S	30	0,25€
10888	RV5.5-6S	20	0,30€
10889	RV5.5-5S	20	0,30€
10893	RV2-5S	40	0,25€

REF.	Icon	PCS	€
10894	SV1-4S	50	0,20€
10895	SV2-4S	40	0,20€

REF.	Icon	PCS	€
10896	FDD1.25-250	45	0,30€
10898	FDD2-250	40	0,30€
10900	FDD5.5-250	25	0,30€

REF.	Icon	PCS	€
10890	BV5.5	15	0,35€
10891	BV2	25	0,25€
10892	BV1.25	30	0,30€

REF.	Icon	PCS	€
10897	MDD1.25-250	50	0,30€
10899	MDD2-250	50	0,30€
10901	MDD5.5-250	30	0,25€

REF.	Icon	PCS	€
10902	FDN 1.25-250	25	0,30€



PINZA PER CAPICORDA

VEDI PAG. 61



53357

7,00€



SET DI PINZE ELETTRICHE



53385

19,30€



PINZA PER L'ESTRAZIONE DI GRAFFETTE DA CARROZZERIA



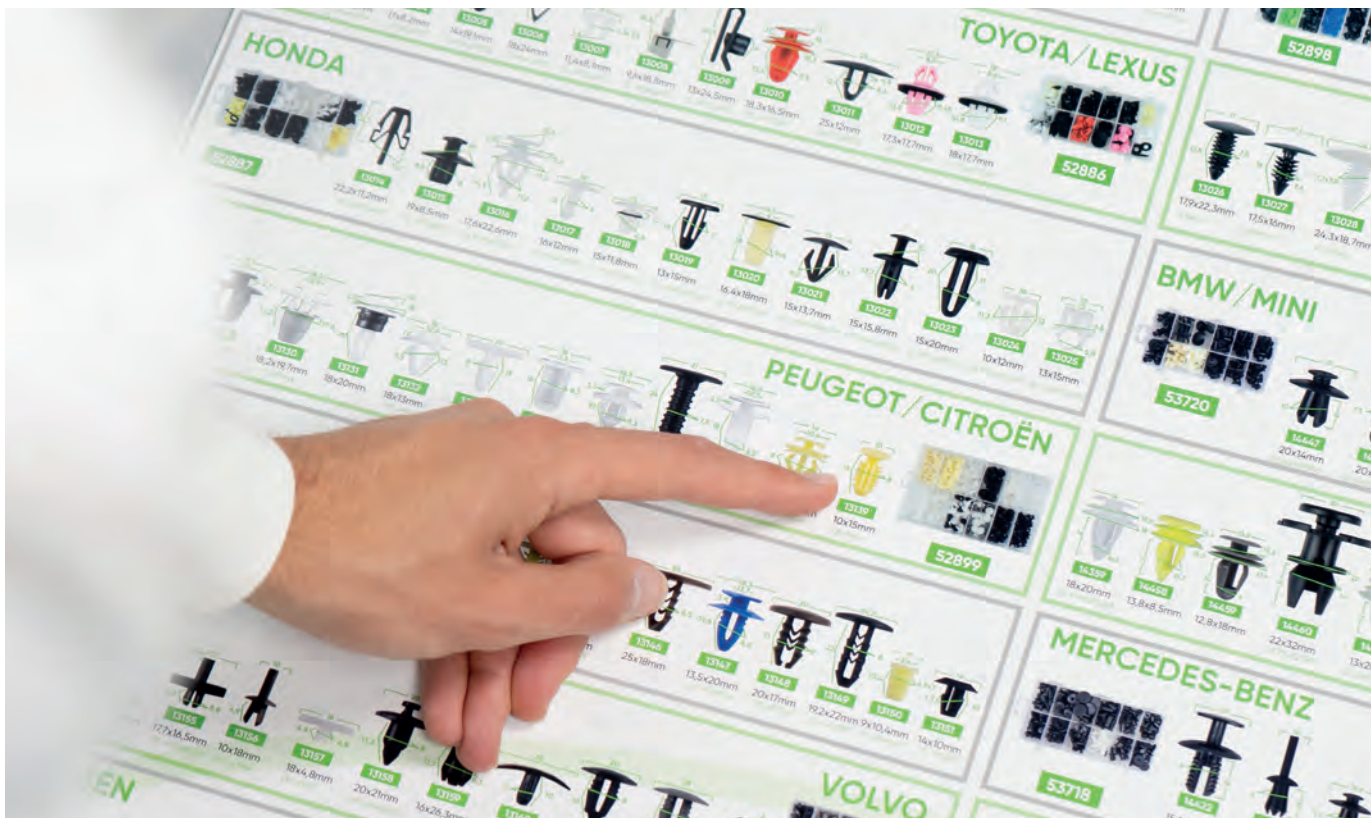

16294 14,00€

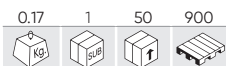

POSTER CLIPS DIMENSIONE REALE

SPECIFICHE TECNICHE:

Dimensione del poster: 1000x640mm
 Materiale: Carta plastificata 250g
 Con fori per appenderlo.

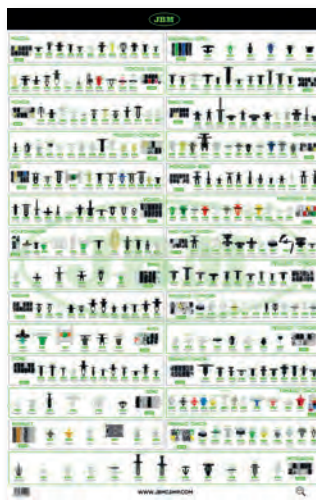

TAMAÑO REAL DE LOS CLIPS
 CLIPS REAL SIZE

52851 9,65€ **53110** 27,30€



SET DI 2 LEVE



SET DI 6 LEVE



- 5"x8.5mm
- 5"x10.3mm
- 5"x4.5mm
- 15"x8.5mm
- 15"x10.3mm
- 15"x4.5mm



CONSUMABILI



UNITÀ DEL SET



QUANTITÀ SACCHETTO



PRESENTAZIONE IN DISPLAY

52896

26,00€

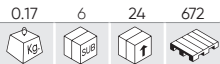

ASSORTIMENTO CLIP DI FISSAGGIO PER MAZDA 190 PEZZI

REF.	DESCRIZIONE	Unità	Sacchetto	€
13104	OE:2042301	8	8	1,90€
13105	OE:999100402	15	15	2,50€
13106	OE:B0016830200	8	8	2,00€
13107	OE:N30413356A	8	8	2,15€
13108	OE:992640543A	20	20	1,90€
13109	OE:99249051B	30	30	2,90€
13110	OE:6508197AA	15	15	1,85€
13111	OE:B1016825200	10	10	1,20€
13112	OE:B09251833	6	6	1,65€
13113	OE:992640543A	20	20	2,20€
13114	OE:B45556741	20	20	2,20€
13115	OE:G03158762	30	30	2,50€

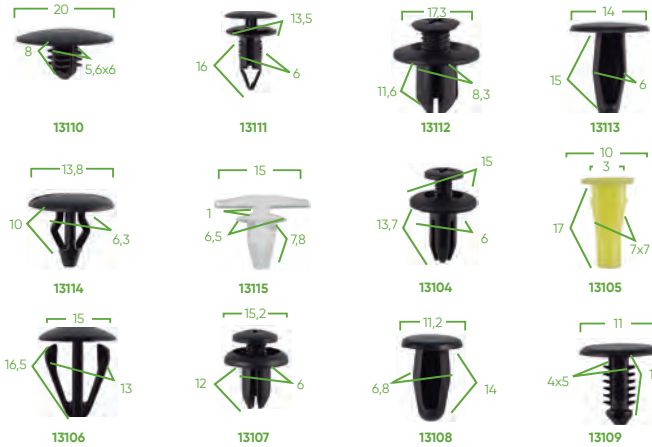

52886

18,00€

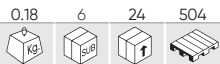

ASSORTIMENTO CLIP DI FISSAGGIO PER TOYOTA / LEXUS 89 PEZZI

REF.	DESCRIZIONE	Unità	Sacchetto	€
13002	OE:9018906001	8	8	1,45€
13003	OE:9046707138	5	4	1,70€
13004	OE:9046707117	10	10	1,85€
13005	OE:9046709138	10	10	1,25€
13006	OE:9046709101	5	5	1,40€
13007	OE:75521611000	10	10	1,30€
13008	OE:7503933060	8	8	2,25€
13009	OE:9017905060	4	4	1,65€
13010	OE:677711250	8	8	1,75€
13011	OE:9046708124	5	5	1,15€
13012	OE:7539533030	8	8	1,80€
13013	OE:9046711063	8	8	1,75€



52887

22,00€



ASSORTIMENTO CLIP DI FISSAGGIO PER HONDA 150 PEZZI

REF.	DESCRIZIONE	Unità	Sacchetto	€
13014	OE:75103SJ4003	12	12	1,45€
13015	OE:90675SB003	5	5	1,20€
13016	OE:91566SP0003	6	6	1,15€
13017	OE:91513SE003	25	25	2,60€
13018	OE:91530ST5003	25	25	1,45€
13019	OE:90687SA50030	15	15	1,75€
13020	OE:91620SR2003	8	8	1,70€
13021	OE:38529689A6300	8	8	1,30€
13022	OE:90683SA5003	10	10	2,10€
13023	OE:90672671003	10	10	1,50€
13024	OE:91534SEO000	18	18	2,45€
13025	OE:34355SD2003	8	8	1,50€

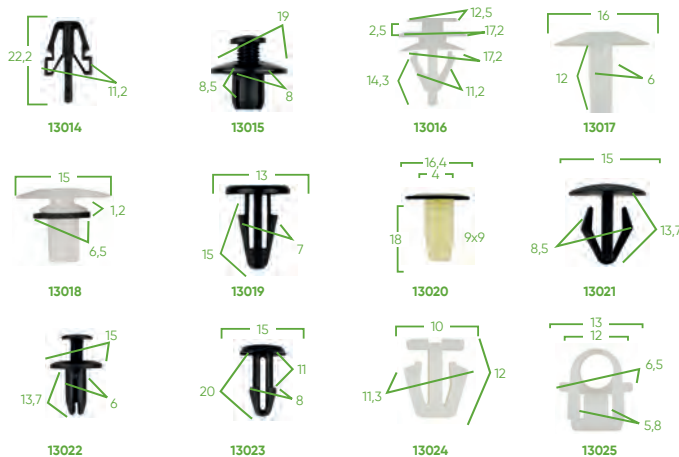

52899

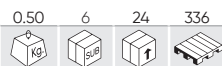

34,00€



ASSORTIMENTO CLIP DI FISSAGGIO PER PEUGEOT / CITROEN 345 PEZZI

REF.	DESCRIZIONE			€
13128	OE:947098	50	50	1,85€
13129	OE:856535	20	20	2,00€
13130	OE:6991W4	20	20	3,75€
13131	-	20	20	3,45€
13132	OE:694143	25	25	2,65€
13133	OE:743707	35	35	3,45€
13134	OE:7703074022	30	30	3,95€
13135	OE:7703077059	35	35	3,45€
13136	OE:698317	15	15	2,60€
13137	OE:699502	25	25	2,25€
13138	OE:6995X3	30	30	2,85€
13139	OE:69945	40	40	3,85€



52900



34,00€



ASSORTIMENTO CLIP DI FISSAGGIO PER FIAT 308 PEZZI

REF.	DESCRIZIONE			€
13140	OE:14591784	30	30	2,65€
13141	OE:1459487	20	10	1,80€
13142	OE:1300433650	25	25	3,10€
13143	OE:71717421	8	8	1,95€
13144	OE:82456515	25	25	2,20€
13145	OE:5757139	25	25	3,85€
13146	-	20	8	4,50€
13147	OE:46306526	25	25	3,10€
13148	OE:14591687	25	25	3,30€
13149	OE:14592387	25	25	3,10€
13150	OE:83468473	30	30	2,25€
13151	OE:7677865	50	30	5,35€

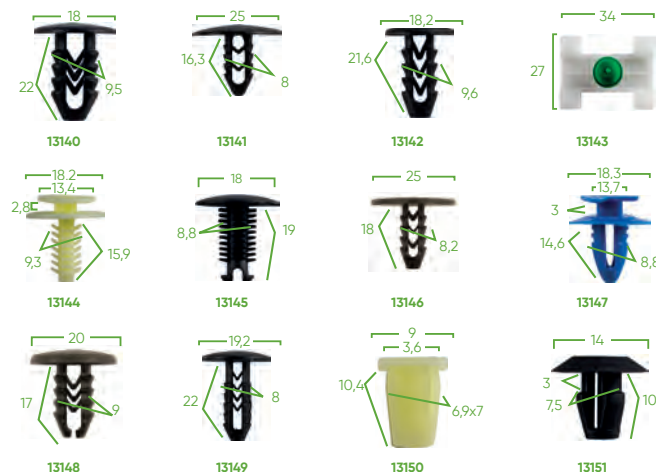

52901

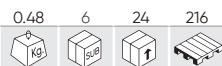

34,00€



ASSORTIMENTO CLIP DI FISSAGGIO PER VOLVO 350 PEZZI

REF.	DESCRIZIONE			€
13152	OE:8099905N07	25	25	3,05€
13153	OE:4292906	30	30	3,10€
13154	OE:12681763	20	20	3,20€
13155	OE:51131804205	40	40	5,60€
13156	OE:947098	40	40	3,30€
13157	OE:591740	40	40	3,85€
13158	OE:6384801G00	25	25	3,75€
13159	OE:9133417	20	20	3,20€
13160	OE:9133073	40	40	5,00€
13161	OE:3272075327462B	30	30	3,55€
13162	OE:327462A	20	20	2,60€
13163	OE:3923712	20	20	2,80€

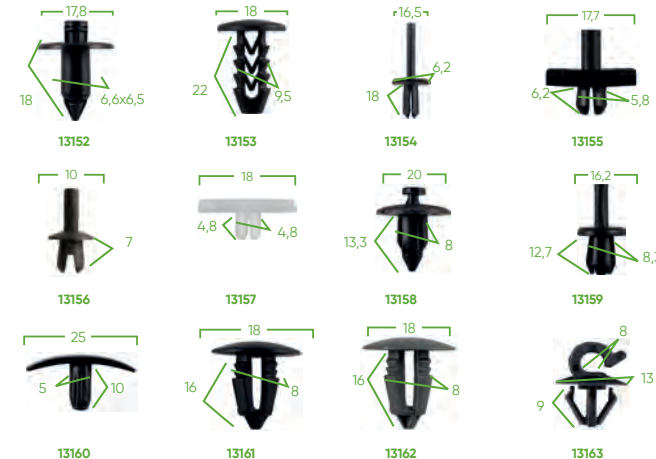

52889

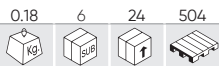

19,00€



ASSORTIMENTO CLIP DI FISSAGGIO PER VOLKSWAGEN 85 PEZZI

REF.	DESCRIZIONE	Immagini	€
13038	OE:1H0868243B	2 2	1,40€
13039	OE:N90833801	10 10	1,65€
13040	OE:3A0853575	8 8	1,80€
13041	OE:4A0853825	5 5	1,55€
13042	OE:6U085733	15 15	1,95€
13043	OE:3B0853576	3 3	1,20€
13044	OE:1H0819055B01C	6 6	1,55€
13045	OE:443853909A	5 5	1,20€
13046	OE:171885767	6 6	1,55€
13047	OE:N9020160H	5 5	1,45€
13048	OE:NO385501	10 10	2,20€
13049	OE:191941142	10 10	2,05€

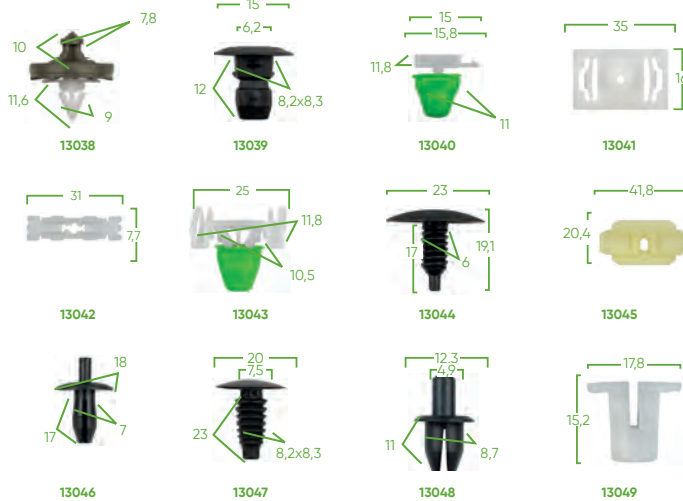

52891

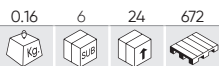

28,00€



ASSORTIMENTO CLIP DI FISSAGGIO PER FORD 169 PEZZI

REF.	DESCRIZIONE	Immagini	€
13056	OE:388577S	8 8	1,55€
13057	OE:N801925S	5 5	1,50€
13058	OE:N806289S	20 20	2,20€
13059	OE:N379830S	20 20	2,35€
13060	OE:1007932	5 5	1,60€
13061	OE:16500308	20 20	2,65€
13062	OE:N803170S	20 20	2,35€
13063	OE:W706713S300	6 6	1,15€
13064	OE:N388246S	20 20	2,60€
13065	OE:F22Z16774A	15 15	2,00€
13066	OE:1673046	5 5	2,25€
13067	OE:F1CZ16674A	25 25	2,55€

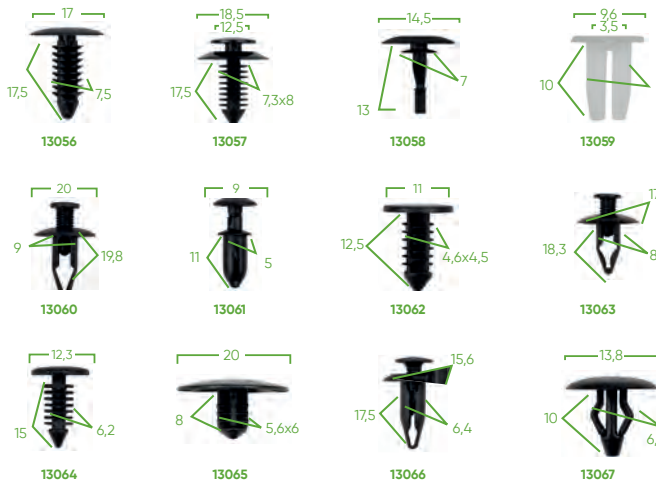

52894

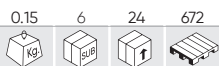

22,00€



ASSORTIMENTO CLIP DI FISSAGGIO PER NISSAN 139 PEZZI

REF.	DESCRIZIONE	Immagini	€
13080	OE:76906T300	15 15	1,75€
13081	OE:0155300172	20 20	2,30€
13082	OE:68425H5000	10 10	1,35€
13083	OE:75521611000	6 6	1,50€
13084	OE:62869N4700	20 20	2,10€
13085	OE:6384401A00	5 5	1,60€
13086	OE:7688257A00	5 5	1,25€
13087	OE:6684101G00	25 25	3,30€
13088	OE:1099830880	10 10	2,40€
13089	OE:8942798070	10 10	1,70€
13090	OE:6384801G00	8 8	1,70€
13091	OE:6385401A00	5 5	1,25€



52890

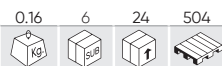

22,00€



ASSORTIMENTO CLIP DI FISSAGGIO PER AUDI 31 PEZZI

REF.	DESCRIZIONE			€
13050	OE:3B0868243	5	15	1,55€
13051	OE:1H0867199A	5	20	1,50€
13052	OE:1H0868243B	3	3	1,25€
13053	OE:357853575	10	10	2,80€
13054	OE:1H0853585A	5	5	2,35€
13055	OE:3A0853575	3	3	3,00€

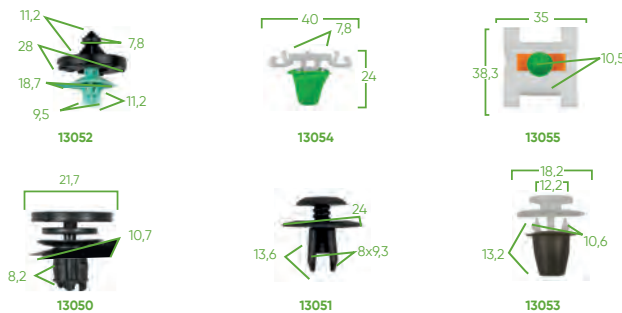

52892

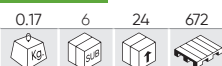

22,00€



ASSORTIMENTO CLIP DI FISSAGGIO PER BMW 95 PEZZI

REF.	DESCRIZIONE			€
13068	OE:51311802258	25	25	2,85€
13069	OE:5131804205	30	30	4,55€
13070	OE:51118174185	10	10	2,15€
13071	OE:51481938725	10	10	2,05€
13072	OE:703867299	15	15	2,75€
13073	OE:51131960054	5	5	2,10€

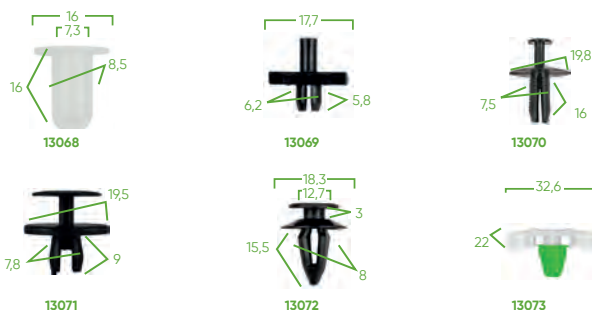

52897

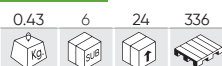

38,00€



ASSORTIMENTO CLIP DI FISSAGGIO PER RENAULT 300 PEZZI

REF.	DESCRIZIONE			€
13116	OE:7703077421	50	50	5,45€
13117	-	50	50	3,65€
13118	OE:7703081184	60	60	15,90€
13119	-	15	15	5,60€
13120	OE:7703074022	60	60	5,50€
13121	OE:7703077059	65	65	8,75€

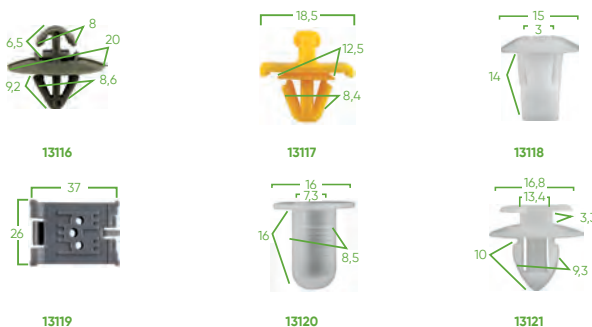

52898



36,00€



ASSORTIMENTO CLIP DI FISSAGGIO VAUXHALL/OPEL 300 PEZZI

REF.	DESCRIZIONE			€
13122	OE:90218614	20	20	1,95€
13123	OE:174864	40	40	5,35€
13124	OE:NO385501	100	100	8,20€
13125	OE:2345959	50	50	5,95€
13126	OE:2240582	50	50	1,55€
13127	OE:180942	40	40	5,60€

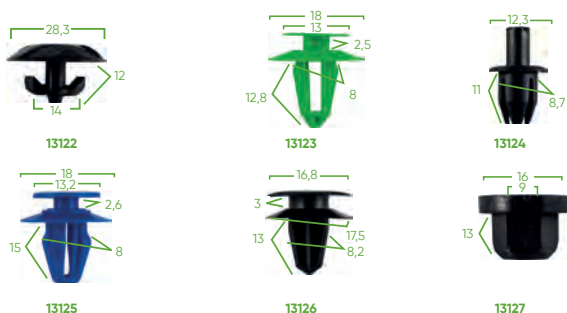

52893

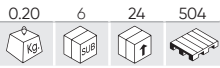

26,00€



ASSORTIMENTO CLIP DI FISSAGGIO PER BENZ 95 PEZZI

REF.	DESCRIZIONE	Tray	Box	€
13074	OE:A0019884481	30	30	4,65€
13075	OE:A0019882981	20	20	5,35€
13076	OE:A1249900492	15	15	3,90€
13077	OE:A0019888081	4	4	2,55€
13078	OE:A1249880492	6	6	2,55€
13079	OE:A0019880325	20	20	3,35€

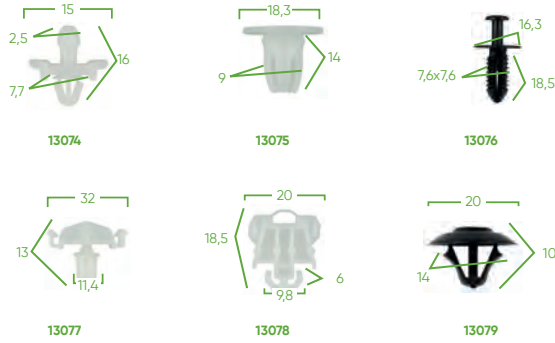

52895

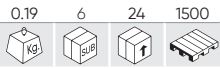

22,00€



ASSORTIMENTO CLIP DI FISSAGGIO PER MITSUBISHI 134 PEZZI

REF.	DESCRIZIONE	Tray	Box	€
13092	OE:8942180270	15	50	1,65€
13093	OE:9018905013	30	30	2,95€
13094	OE:MU480033	10	10	1,50€
13095	OE:128100231	8	6	1,20€
13096	OE:MU480034	8	8	1,70€
13097	OE:MR138807	3	3	1,20€
13098	OE:MB253964	4	4	1,65€
13099	OE:HB121467	30	30	2,75€
13100	OE:MB271999	3	3	1,20€
13101	OE:MB696120	8	8	1,50€
13102	OE:MR200300	5	5	1,60€
13103	OE:MB846992	10	10	1,80€

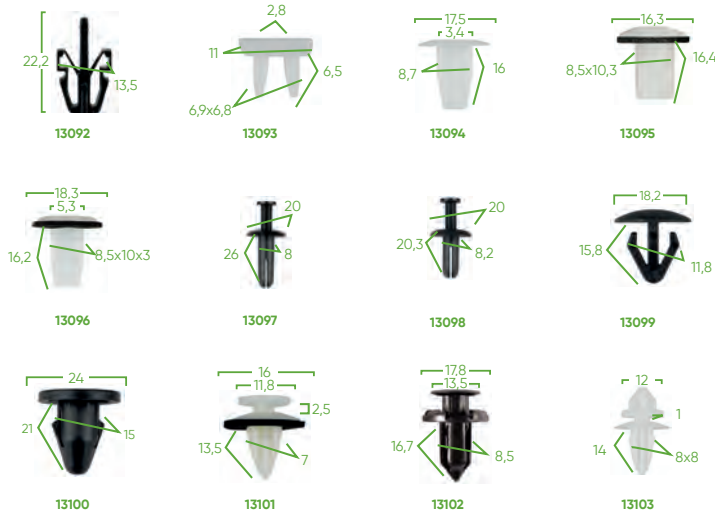

52888

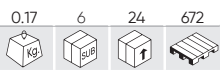

24,00€



ASSORTIMENTO CLIP DI FISSAGGIO UNIVERSAL 128 PEZZI

REF.	DESCRIZIONE	Tray	Box	€
13026	OE:388577S	8	8	1,55€
13027	-	10	10	1,85€
13028	OE:6003423	6	6	1,45€
13029	OE:VW:N989022 CHRYSLER: 6003349 FORD:385661	6	6	1,65€
13030	OE:CHRYSLER: 6502328 GM:20699808	25	25	2,80€
13031	OE:N804379S	4	4	1,85€
13032	OE:FORD:F22Z16774A MAZDA:6508197AA	15	15	2,00€
13033	OE:GM:16674629 FORD:N806113S	10	10	1,60€
13034	OE:0153301781	20	20	2,65€
13035	OE:GM:10124502 BMW:52201964201 LAND ROVER:- DZM10080	6	6	1,65€
13036	OE:VW:N9020160H BMW:51471904317 OPEL:2207713	6	6	1,40€
13037	-	12	12	2,10€

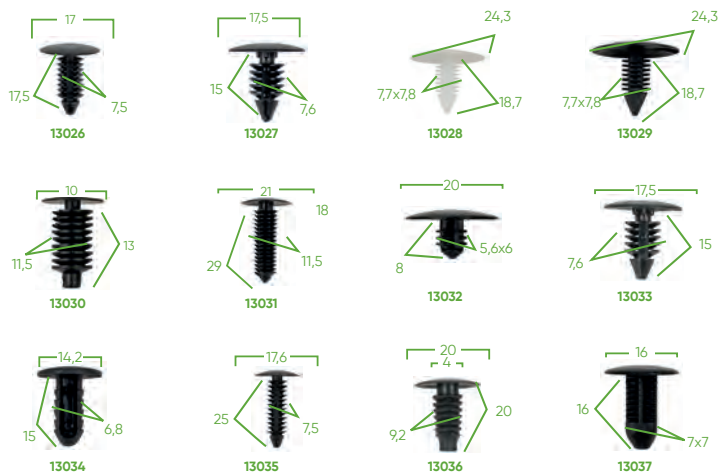

53720

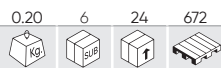

19,00€



ASSORTIMENTO DI 112 PZ. CLIP PER TAPPEZZATURA BMW MINI

REF.	DESCRIZIONE	1	2	€
14447	OE: 51471911992	7	6	1,45€
14449	OE: 51717002953	13	10	2,20€
14471	OE: 51489119216	5	5	1,90€
14472	OE: A0009905492	5	5	1,35€
14474	OE: 51118174185	8	8	1,50€
14475	OE: 2019900050	6	6	1,65€
14476	OE: 51481915964	9	9	2,05€
14477	OE: 0009881625	15	15	2,45€
14478	OE: 7146976114	15	15	4,05€
14479	OE: 91503SP0003	6	6	1,65€
14480	-	15	15	2,05€
14481	OE: 51161943122	8	8	1,70€



53719

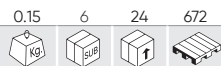

19,00€



ASSORTIMENTO DI 92 PZ. CLIP PER PANNELLI PORTA/MODANATURA BMW MINI

REF.	DESCRIZIONE	1	2	€
14359	-	8	8	1,05€
14458	-	6	6	1,70€
14459	OE: 7147122912	2	2	1,45€
14460	OE: 51411973500	8	8	1,15€
14461	-	8	8	1,35€
14462	-	8	8	1,65€
14463	OE: 611769	10	10	1,65€
14464	OE: 7147145753	10	10	1,50€
14465	-	8	8	2,00€
14466	OE: 51418224768	8	4	1,65€
14468	-	8	8	1,30€
14469	OE: 7147133419	8	8	1,45€

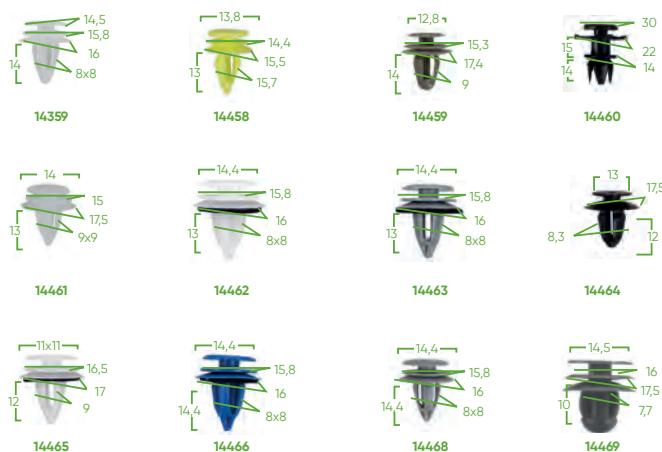

53718

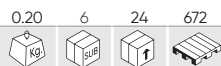

19,00€



ASSORTIMENTO DI 96 PZ. CLIP PER PANNELLI PORTA/TAPPEZZATURA MERCEDES-BENZ

REF.	DESCRIZIONE	1	2	€
14422	OE: A0009913940	20	20	1,50€
14446	OE: 9903492	6	6	2,80€
14447	OE: 51471911992	12	12	1,45€
14448	OE: NI05835019B9	10	10	2,05€
14449	OE: A0009905492	12	12	2,20€
14450	OE: N0385012	12	12	2,15€
14451	OE: A1239900092	25	25	2,15€
14452	-	20	20	2,55€
14453	-	6	6	3,05€
14455	-	12	12	2,10€
14456	-	6	6	1,35€
14457	OE: A1249900492	10	10	1,70€

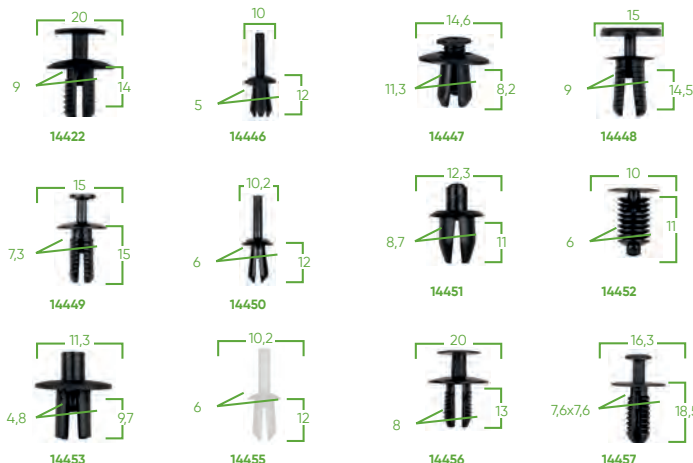

53717

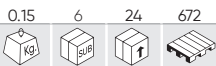

19,00€



ASSORTIMENTO DI 96 PZ. CLIP PER PANNELLI PORTA/MODANATURA MERCEDES-BENZ

REF.	DESCRIZIONE			€
14434	-	8	8	1,60€
14435	-	6	6	1,45€
14436	OE: A0009910198	8	8	1,70€
14437	OE: A0019912698	6	6	1,45€
14438	OE: A0089880978	8	8	1,35€
14439	OE: 0069884378	8	8	1,75€
14440	-	8	8	1,75€
14441	OE: 0019884981	10	10	1,65€
14442	-	6	6	1,45€
14443	-	8	8	1,45€
14444	OE: 0019886081	10	10	1,90€
14445	-	10	10	1,45€

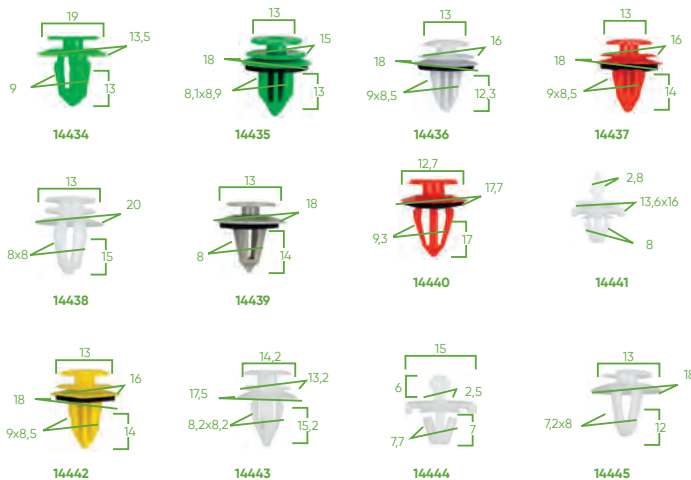

53716

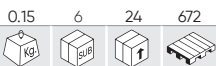

19,00€



ASSORTIMENTO DI 79 PZ. CLIP PER PANNELLI PORTA/MODANATURA/TAPPEZZATURA VAG/ SEAT/SKODA

REF.	DESCRIZIONE			€
14422	OE: A0009913940	6	6	1,50€
14423	OE: 6E0837732	15	15	3,55€
14424	-	7	7	1,85€
14425	OE: 6Q0868243	2	2	2,05€
14426	OE: 171201969	8	8	1,90€
14427	OE: 4D0807300	8	4	1,20€
14428	OE: 251823717	12	12	1,40€
14429	-	6	6	1,80€
14430	OE: 8E0821989A	3	3	2,25€
14431	OE: 3B0868243	2	2	1,45€
14432	OE: 1H0823171	10	10	1,45€

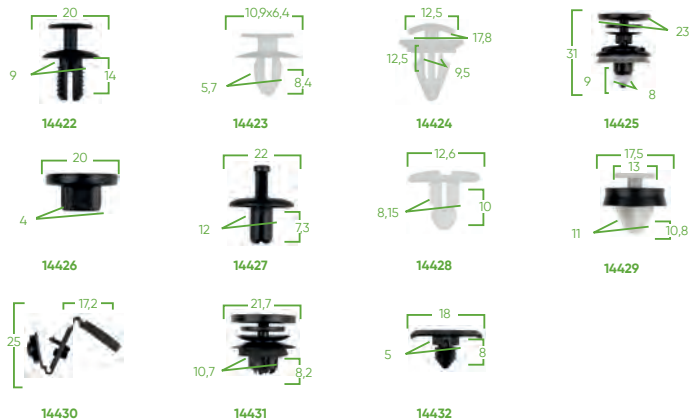

53715

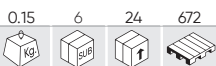

19,00€



KIT DI 110 PZ. CLIP PER TAPPEZZATURA PEUGEOT/CITROËN

REF.	DESCRIZIONE			€
14410	-	10	10	1,85€
14411	-	10	5	1,70€
14412	-	10	10	1,70€
14413	-	10	10	3,25€
14414	OE: 2346824	10	10	1,70€
14415	OE: A1249900492	10	10	1,70€
14416	OE: 6992C6	10	5	1,25€
14419	-	15	15	1,95€
14420	-	15	15	1,50€
14421	OE: 14093311	10	10	2,45€



53714

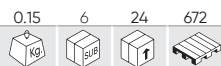

16,00€



ASSORTIMENTO DI 80 PZ. CLIP PER MODANATURA PEUGEOT/CITROËN

REF.	DESCRIZIONE			€
14398	OE: 6995X3	8	8	1,30€
14399	OE: 129943	12	6	1,90€
14402	OE: 856548	8	8	1,50€
14404	OE: 71728806	8	8	2,10€
14405	OE: 968865987703	16	8	1,45€
14406	OE: 856540	10	10	1,55€
14408	OE: 856534	10	10	1,45€
14409	OE: 357853586	8	8	1,35€

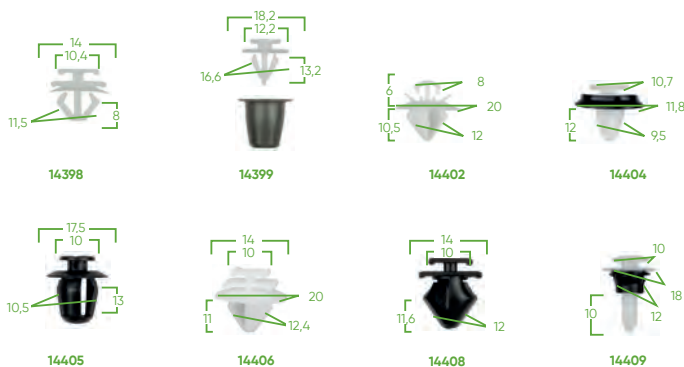

53713

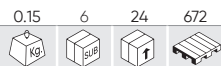

16,00€



ASSORTIMENTO DI 93 PZ. CLIP PER PANNELLI PORTA PEUGEOT/CITROËN

REF.	DESCRIZIONE			€
14350	OE: 6991Y8	6	6	1,80€
14358	OE: PG 6991Y8 CT 6991Y8 FIAT 9654280780 RENAULT 703077469	10	10	1,70€
14387	-	8	8	1,45€
14388	OE: 7703077250	8	8	2,05€
14389	OE: 6995A3	6	6	1,25€
14390	-	6	6	1,35€
14391	-	15	15	2,15€
14392	-	6	6	1,35€
14393	-	8	8	1,50€
14395	-	8	8	1,65€
14396	-	6	6	1,20€
14397	-	6	6	1,45€

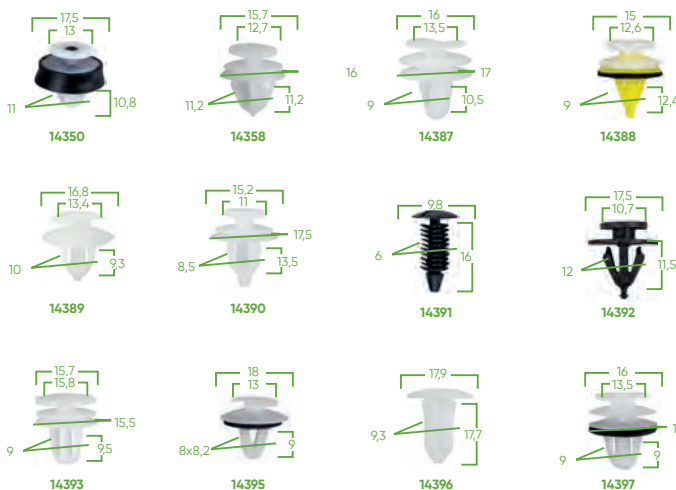

53712

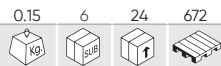

16,00€



ASSORTIMENTO DI 109 PZ. CLIP PER TAPPEZZATURA RENAULT DACIA

REF.	DESCRIZIONE			€
14374	OE: 7703077435	3	3	1,70€
14375	-	15	15	1,85€
14376	OE: 7L6868307	20	20	2,60€
14377	-	10	10	1,90€
14378	OE: 7703077117	12	12	1,90€
14379	-	6	6	1,45€
14381	-	10	10	1,70€
14382	OE: 7703077153	6	6	1,85€
14383	OE: 7703072360	10	10	1,35€
14384	OE: W705956S300	12	12	2,10€
14416	OE: 6992C6	5	5	1,25€



53711



16,00€



ASSORTIMENTO DI 90 PZ. CLIP PER MODANATURA DACIA RENAULT

REF.	DESCRIZIONE	10	10	€
14356	OE: RENAULT 7703077368 OPEL 4430858	10	10	1,90€
14358	OE: PG 6991Y8 CT 6991Y8 FIAT 9654280780 RENAULT 703077469	12	10	1,70€
14364	OE: OP 7701470779 NI 7703077421 RENAULT 7703077421 IV 500326896	10	10	1,90€
14365	OE: OP 7701470779 NI 7703077421 RENAULT 7703077421 IV 500326896	10	10	1,90€
14366	OE: PG 6991Y8 CT 6991Y8 FIAT 9654280780 RENAULT 703077469	8	8	1,45€
14367	-	3	3	1,30€
14368	OE: 7L5853994	8	8	1,45€
14369	OE: 7701061797	15	15	4,95€
14370	-	3	3	3,00€
14371	-	3	3	3,00€
14372	-	4	4	1,20€
14373	-	4	4	1,35€

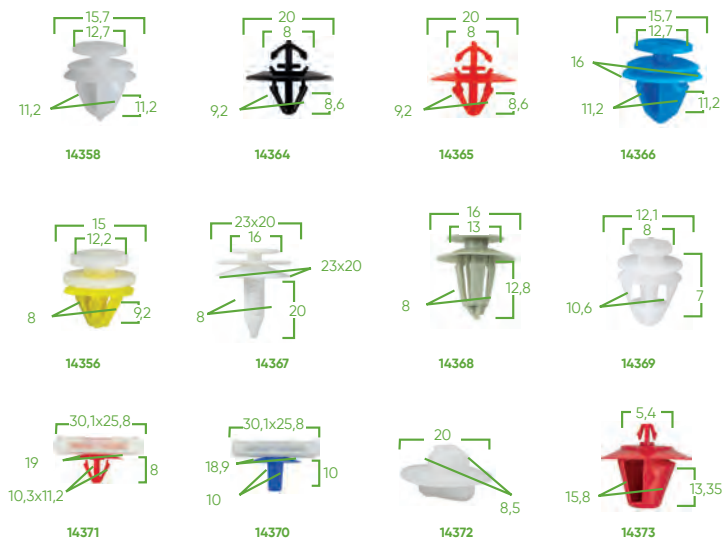

53710



16,00€



ASSORTIMENTO DI 85 PZ. CLIP PER PANNELLI PORTA RENAULT DACIA

REF.	DESCRIZIONE	12	6	€
14350	OE: 6991Y8	12	6	1,80€
14351	-	8	15	1,65€
14352	OE: 51447780135	7	7	1,30€
14353	OE: 7703077476	8	2	2,10€
14355	OE: 7703077354	8	8	1,70€
14356	OE: RENAULT 703077368 OPEL 4430858	10	4	1,90€
14357	OE: 7703077430	10	12	1,90€
14358	OE: PG 6991Y8 CT 6991Y8 FIAT 9654280780 RENAULT 703077469	10	6	1,70€
14359	OE: 51418224768	4	3	1,05€
14361	-	8	15	1,70€

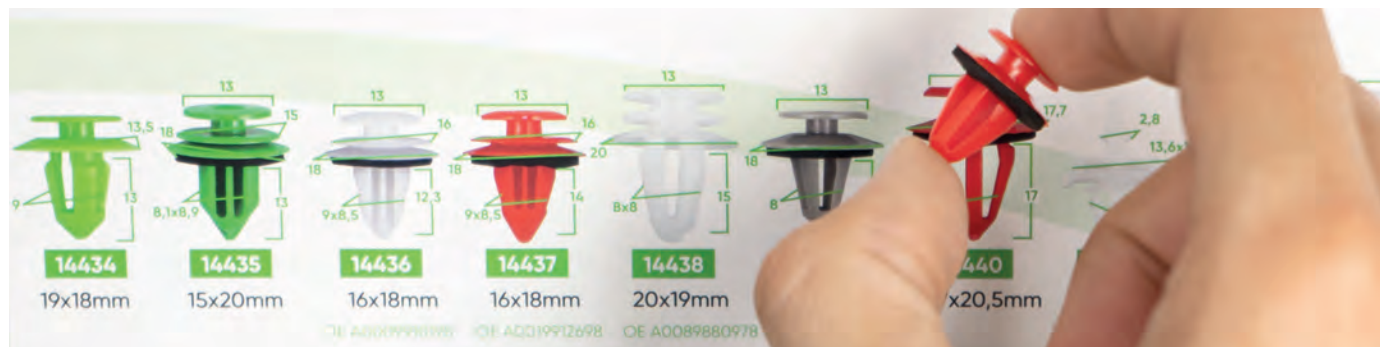
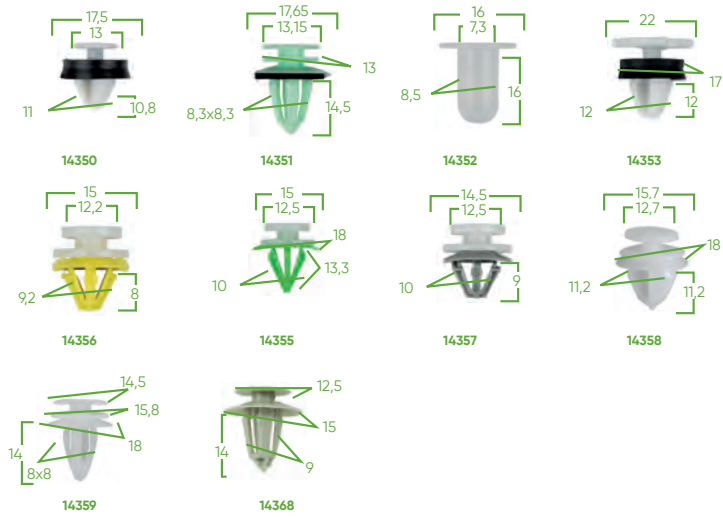

ABBIGLIAMENTO DA LAVORO

406 GILET

406 GIACCHE

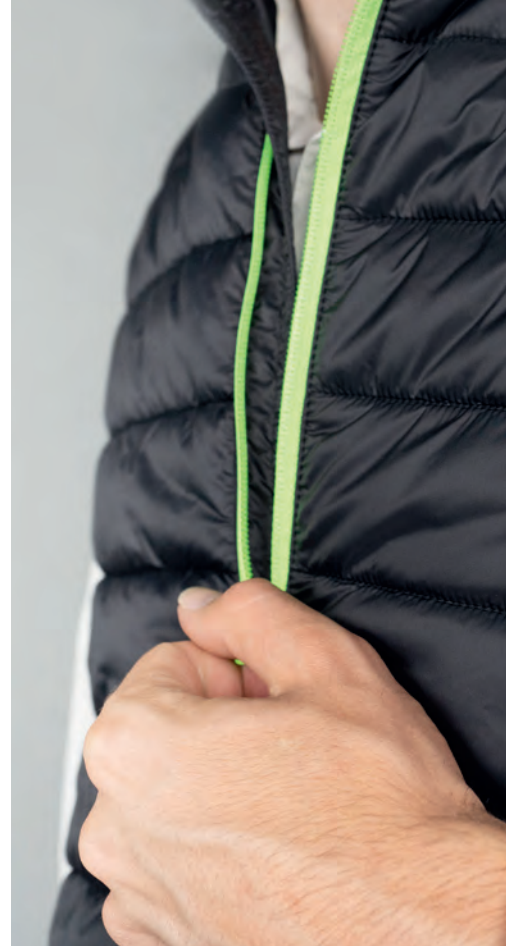



GILET JBM



70001
70002
70003



70013
70014
70015
70016
70017



70009

REF.		■	■	■	📦	📦	📦	🚚	€
70001	M	●			0.30	-	5	200	35,00€
70002	L	●			0.40	-	5	200	35,00€
70003	XL	●			0.40	-	5	200	35,00€
70009	XL		●		0.40	-	5	180	35,00€
70013	S		●		0.30	-	10	240	44,00€
70014	M		●		0.30	-	10	240	44,00€
70015	L		●		0.30	-	10	240	44,00€
70016	XL		●		0.35	-	10	240	44,00€
70017	XXL		●		0.35	-	10	200	44,00€

GIACCA JBM

70004
70005
70006



70011
70012

REF.		■	■	■	📦	📦	📦	🚚	€
70004	M	●			0.60	-	5	140	42,00€
70005	L	●			0.70	-	5	140	42,00€
70006	XL	●			0.70	-	5	140	42,00€
70011	L		●		0.60	-	5	120	42,00€
70012	XL		●		0.70	-	5	120	42,00€

13929

3,45€



GRUCCIA PER ABBIGLIAMENTO 49 CM

490mm



METEXP

62,00€



ESPOSITORE



PRODOTTI PROMOZIONALI

408 PRODOTTI PROMOZIONALI

410 ESPOSITORI / ACCESSORI

412 PACKAGING



53956

353,00€

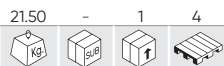

SEDIA ROTATIVA

DIMENSIONI: 70x55x126-136cm

ALTEZZA REGOLABILE

CUSCINO LOMBARE

CUSCINO POGGIATESTA



Materiale: PU
 Spessore del telaio in ferro: 1,2cm
 Sedile: polistirolo espanso modellato
 Schienale: schiuma di poliuretano
 Bracciolo: 2D
 Pistone a gas: Classe 3
 Base in nylon: 350mm



RICAMBI DISPONIBILI

54043

48,00€

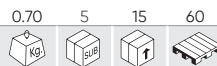

ZAINO JBM

Spazio di stoccaggio e tasche: grazie a due scomparti, permette di riporre, tra le altre cose, computer portatili fino a 17,3" e tablet.

Materiale: Poliuretano; zaino impermeabile, resistente e robusto.

Leggero e comodo: la struttura dello schienale è comoda ed è fatta di rete traspirante e le spalline sono in materiale spugnoso.



53973

284,00€



GAZEBO PIEGHEVOLE JBM 3X3M

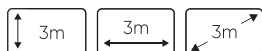

REF.	DESCRIZIONE	Icona	Icona	Icona	Icona	€
14347	CUSTODIA PROTETTIVA PER LO STAND JBM	0.60	-	5	-	36,50€

15152

160,00€



COPERTURA LATERALE PER DISPLAY JBM RIF. 53973

Si compone di due parti:
 - Parte laterale che copre 3/4 della tenda.
 - Parte anteriore che copre 1/4 della tenda. Con cerniera verticale come porta.



54325 22,50€

2.30 - 10 120

Kg SUB f

N

TAPPETO 100X65CM



54278 4,50€

0.10 5 200 1800

Kg SUB f

N

BERRETTO JBM



54480 1,00€

0.00 500 2000 40000

Kg SUB f

N

PORTACHIAVI JBM



53949 4,50€

0.10 - 15 540

Kg SUB f

BORSA FRIGO JBM NERA



53950 4,50€

0.10 - 15 630

Kg SUB f

BORSA FRIGO JBM VERDE



13968 1,35€

0.01 50 200 2400

Kg SUB f

SACCHETTO JBM



53533 1,50€

0.01 50 1000 12000

Kg SUB f

PENNA DI 4 COLORI JBM
PROMOZIONALE



54076 9,00€

0.50 - 50 700

Kg SUB f

TAZZA JBM



340ml



53504

38,00€



SCOOTER



14975

64,00€

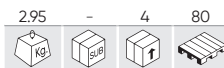

PORTA PROSCIUTTO



GANCI

REF. PER					€	
14034	UTENSILI PNEUMATICI	0.20	20	80	1920	9,00€
14623	REF. 60046, 60044, 60048, 60005, 60006	0.10	-	10	800	8,00€
14626	REF. 60023	0.10	-	10	-	7,00€
11318	GANCIO DRITTO PER ESPOSITORE ATTREZZATURA	0.04	20	600	-	2,50€
16364	GANCIO DRITTO PER ESPOSITORE ATTREZZATURA 280MM	0.20	-	200	-	3,50€
51315	GANCIO DRITTO PER ESPOSITORE ATTREZZATURA DOPPIO CHIUSO	0.02	20	320	44800	2,50€

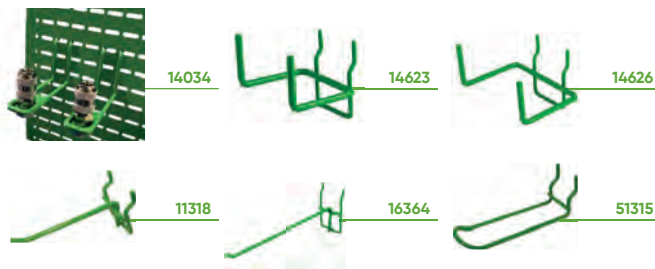

MENSOLE

REF. PER					€	
14622	REF. 60001, 60003, 60004, 60020	0.95	-	10	360	17,00€
14624	REF. 60007, 60010, 60011	0.65	-	10	300	17,00€
14625	REF. 60028, 60009	0.50	-	10	700	14,00€



53492

380,00€



ESPOSITORE DI UTENSILI PNEUMATICI



CONSEGNA SENZA UTENSILI



METEXP

62,00€



ESPOSITORE



REF.	DESCRIZIONE					€
13929	GRUCCEA PER ABBIGLIAMENTO 49 CM	0.10	-	-	280	3,45€



53877 430,50€

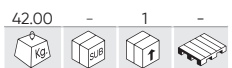

ESPOSITORE DI UTENSILI

53878 574,00€

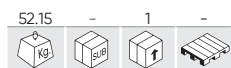

ESPOSITORE UTENSILI + TESTA CON ILLUMINAZIONE

53879 838,50€

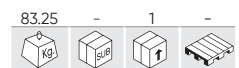

ESPOSITORE UTENSILI + TESTA CON ILLUMINAZIONE E PORTA



CONTIENE

14945	x1
14346	x1
14380	x1
11318	x20



CONTIENE

14945	x1
14947	x1
14380	x1
11318	x20



CONTIENE

14945	x1
14947	x1
14948	x1
14996	x1
11318	x20



RICAMBI PER ESPOSITORE

REF.	DESCRIZIONE					€
14945	PANNELLO PER GLI ATTREZZI - BASE	37.80	-	1	15	303,50€
14946	TESTA PER ESPOSITORE UTENSILI	3.40	-	1	51	58,00€
14947	SUPPORTO ALLEGGERITO PER IL PANNELLO PER GLI ATTREZZI	8.55	-	1	6	201,50€
14948	SET DI 2 PORTE PER PORTAUTENSILI	31.10	-	1	40	251,50€
14380	VASSOIO DEL SUPPORTO DEGLI ATTREZZI 53877	5.00	-	1	34	51,00€
14996	VASSOIO DEL SUPPORTO DEGLI ATTREZZI CON LA PORTICINA	5.00	-	1	33	65,00€

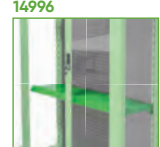
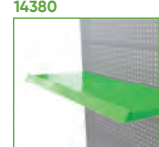

53914

75,00€

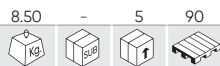

PALO DI SEPARAZIONE CON NASTRO RETRATTILE

- Materiale: acciaio
- Diametro del tubo: 63 mm
- Diametro di base: 320 mm
- Altezza: 910 mm
- Nastro su 4 lati
- Lunghezza del nastro: 3 m
- Larghezza della nastro: 48 mm



14807

11,00€

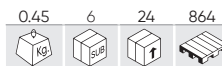

NASTRO ADESIVO PER GARANZIA JBM



TUTTE LE LINGUE NELLO STESSO SIGILLO

- 75mm di larg. x 125m di lung.
- Realizzato in polipropilene
- Adesivo solvente
- Spessore: 28 micron

SCATOLA DI CARTONE JBM

SCATOLA PER ATTREZZI MANUALI DI RICAMBIO

REF. DESCRIZIONE				€
14922 SCATOLA PER ATTREZZI MANUALI DI RICAMBIO 14,5 X 9 X 10 CM	0.10	100	-	0,84€
14923 SCATOLA PER ATTREZZI MANUALI DI RICAMBIO 17,5 X 9 X 7 CM	0.10	100	-	0,84€
14924 SCATOLA PER ATTREZZI MANUALI DI RICAMBIO 24 X 11 X 7 CM	0.10	100	-	0,84€
14925 SCATOLA PER ATTREZZI MANUALI DI RICAMBIO 31,5 X 13 X 4 CM	0.10	100	-	0,84€
14926 SCATOLA PER ATTREZZI MANUALI DI RICAMBIO 32 X 8,5 X 7 CM	0.10	100	-	1,05€



SCATOLA PROMOZIONALE

REF. DESCRIZIONE				€
13717 SCATOLA PER PROSCIUTTO JBM 76X14X29CM	0.90	1	200	7,65€
14083 SCATOLA DI CARTONE VERDE PROMO 80X28X49CM	1.80	1	100	13,20€
14976 SCATOLA DI CARTONE, PROMOZIONALE, 80X31X61 CM	2.20	1	80	18,84€
15056 SCATOLA DI CARTONE, PROMOZIONALE, 40X30X61 CM	1.60	1	70	11,70€









SCATOLA JBM

REF. DESCRIZIONE				€
11330 JBM SCATOLA DI CARTONE PICCOLA 19X10X11CM (KIT DI AVVIO DEL GIUNTO)	0.05	50	4200	0,57€
12950 SCATOLA DI CARTONE JBM 60X40X30CM	0.80	15	75	3,45€
12952 SCATOLA DI CARTONE JBM 40X30X20CM	0.40	20	240	1,92€
13217 SCATOLA DI CARTONE JBM 57X30X25CM (KIT DI EMERGENZA)	0.55	15	150	1,31€
14974 SCATOLA DI CARTONE JBM 54X24X40CM (20 KIT DI SCARPONI PER GIUNTI)	0.65	20	240	2,28€
15051 SCATOLA DI CARTONE 40X32X30 CM	0.40	20	160	1,92€
14189 CONTENITORE PALLET AMERICANO A TRIPLA CANNALE	10.00	1	40	52,00€
14507 CONTENITORE PALLET EUROPEO	8.00	1	40	50,00€



















LEGGENDA













LOGISTICA

 PESO IN CHILOGRAMMI	 QUANTITA' PACCHETTO	 QUANTITA' SCATOLA	 QUANTITA' PALLET
 QUANTITA' SACCHETTO	 QUANTITÀ SET	 PRESENTAZIONE IN DISPLAY	

GENERALE

 NUMERO DI PEZZI	 PRESENTAZIONE IN BLISTER	 MAGNETICO	 TATTILE
 CAPACITÀ DI CARICA DELLA BATTERIA	 TEMPO DI RICARICA	 MANICO ERGONOMICO	 NON SI PUÒ LAVARE
 PROTEGGE DA PIOGGIA E UMIDITÀ	 PRODOTTO RICICLABILE	 INFORMAZIONE	 SENZA FILI
 MACCHINA ELETTRICA	 SEGNALE AD ALTA TENSIONE	 NORMATIVA EUROPEA	 REGOLAMENTO AMERICANO
 UNIVERSAL	REGOLAMENTO UNIVERSALE		



















UNITÀ DI MISURA

 LUNGHEZZA	 MASSA	 DIAMETRO	  ALTRI
 CAPACITÀ	 POLLICI	 MASSIMO-MINIMO	  GRADI
 SUPERFICIE	 GRADI CENTIGRADI	 SUONO	

UNITÀ DI MISURA ARTICOLI SPECIFICI

 DIAMETRO DISCO	 DIAMETRO FORO DISCO IN "	 DIAMETRO TUBO	 DIAMETRO INTERNO ED ESTERNO DEL TUBO
 LUNGHEZZA DEL TUBO	 LUNGHEZZA DELLA SPINA		

MATERIALE

 LEGNA	 ACCIAIO	 ACCIAIO S2	 ALLUMINIO
 RAME	 CROMATO	 CROMO VANADIO	 CROMO MOLIBDENO
 NEODIMIO	 ZINCO	 CLORURO DI POLIVINILE	 POLIPROPILENE
 POLIETILENE	 POLIETILENE AD ALTA DENSITÀ	 ACCIAIO LAMINATO	 OTTONE
 LATTICE	 NYLON	 GOMMA NITRILE BUTADIENE IDROGENATA	

PUOI TROVARE ANCHE

 MURATURA	 LEGNA	 ACCIAIO
---	---	---

SPECIFICAZIONI TECNICHE

UTENSILI MANUALI

PUNTE

	PUNTA SLOTTED		PUNTA PHILIPS		PUNTA POZIDRIV		PUNTE TORQ
	PUNTE RIBE		PUNTA QUADRUPLA		PUNTA TRIPLA		PUNTA ALLEN
	CHIAVE TORX		PUNTA A 12 PUNTI		PUNTA QUADRATA		PUNTA TORX A CINQUE PUNTI
	PUNTO DI SPLINE		PUNTA A FARFALLA		PUNTA ALLEN A PROVA DI MANIMMISSIONE		PUNTA TORX A PROVA DI MANIMMISSIONE
	PUNTA A 12 PUNTI A PROVA DI MANIMMISSIONE		PUNTA QUADRATA A PROVA DI MANIMMISSIONE		PUNTA TORX A CINQUE PUNTI A PROVA DI MANIMMISSIONE		PUNTO DI SPLINE INVIOLEBBILE
	PUNTA TENSOR						

BUSSOLE

	BUSSOLA ESAGONALE		BUSSOLA TORX		BUSSOLA A 12 PUNTI		BUSSOLA QUADRATA
	BUSSOLA A 5 PUNTI		BUSSOLA SPLINE		BUSSOLA ESAGONALE A PROVA DI MANIMMISSIONE		BUSSOLA TORX A PROVA DI MANIMMISSIONE
	BUSSOLA A 12 PUNTI A PROVA DI MANIMMISSIONE		BUSSOLA QUADRATA A PROVA DI MANIMMISSIONE		BUSSOLA A CINQUE PUNTI A PROVA DI MANIMMISSIONE		A PROVA DI MANIMMISSIONE

CHIAVI

	CHIAVE ESAGONALE		CHIAVI TORX		CHIAVE A DODICI SPIGOLI		CHIAVE QUADRATA
	CHIAVE A CINQUE PUNTI						

CRICCHETTO

	24 DENTI		72 DENTI		90 DENTI
---	----------	---	----------	---	----------

UTENSILI ELETTRICI

	WATT		VOLT		HERTZ		CHILOWATT
	AMPERE		CORRENTE ALTERNATA		CORRENTE CONTINUA		RESISTENZA ELETTRICA
	BATTERIA AGLI IONI DI LITIO		USB MICROUSB		PRESA ACCENDISIGARI		

UTENSILI NEUMATICI

	LIBBRE PER POLLICE QUADRATO (PRESSIONE)		UNITÀ DI PRESSIONE		PIEDI CUBI AL MINUTO (FLUSSO)		CAVALLI (POTENZA)
	GIRI AL MINUTO GENERALE		GIRI INVERSI AL MINUTO		GIRI IN AVANTI AL MINUTO		NEWTON MASSIMO PER METRO
	NEWTON PER METRO		IMPULSI AL MINUTO		KILOPASCAL		MEGAPASCAL
	ALTO VOLUME D'ARIA E BASSA PRESSIONE		USCITA POSTERIORE		COLLEGABILE A TUBO		ENTRATA D'ARIA
	CAPACITÀ DI VELOCITÀ		SISTEMA A MARTELLO JUMBO		MECCANISMO A DOPPIO MARTELLO		

INDICE NUMERICO

REF.	PAGINA	PREZZO
10000	305	7,00 €
10054	232	2,90 €
10055	232	3,90 €
10264	53	2,00 €
10485	231	8,10 €
10486	231	8,00 €
10494	231	6,50 €
10495	231	3,00 €
10496	231	3,00 €
10497	231	3,00 €
10498	231	3,00 €
10499	231	3,00 €
10500	231	3,00 €
10501	231	8,10 €
10502	231	3,50 €
10526	57	10,00 €
10531	41	3,00 €
10532	41	2,70 €
10533	41	3,00 €
10534	41	3,25 €
10535	41	3,50 €
10536	41	3,65 €
10537	41	3,90 €
10538	41	4,30 €
10539	41	4,75 €
10540	41	5,25 €
10541	41	5,55 €
10542	41	5,85 €
10543	41	7,00 €
10544	41	8,10 €
10545	41	9,75 €
10546	41	11,60 €
10547	41	13,50 €
10548	41	1,75 €
10549	41	2,00 €
10550	41	2,15 €
10551	41	2,15 €
10552	38	7,10 €
10553	38	7,35 €
10554	38	7,50 €
10555	38	7,80 €
10556	38	8,10 €
10557	38	8,10 €
10558	38	9,35 €
10559	38	9,50 €
10560	38	10,60 €
10561	38	11,00 €
10562	38	12,30 €
10563	38	12,50 €
10564	42	2,50 €
10565	42	3,50 €
10566	42	3,50 €
10567	42	3,50 €

REF.	PAGINA	PREZZO
10568	42	4,00 €
10569	42	4,50 €
10570	42	4,50 €
10571	42	5,00 €
10579	42	3,00 €
10580	42	3,10 €
10581	42	3,40 €
10582	42	4,00 €
10583	42	4,15 €
10584	42	5,05 €
10585	42	6,75 €
10586	42	7,60 €
10587	42	9,80 €
10588	42	10,50 €
10589	42	2,00 €
10590	42	2,40 €
10591	44	2,50 €
10592	44	2,55 €
10593	44	3,15 €
10594	44	3,20 €
10595	44	3,35 €
10596	44	4,25 €
10597	44	4,50 €
10598	44	4,60 €
10599	44	6,00 €
10600	44	6,25 €
10601	44	6,50 €
10602	44	7,05 €
10603	44	2,10 €
10604	44	2,25 €
10617	46	14,10 €
10618	46	15,10 €
10619	46	15,70 €
10620	46	16,20 €
10621	46	9,50 €
10622	46	10,00 €
10623	46	12,60 €
10624	46	13,50 €
10625	46	15,70 €
10626	46	17,80 €
10627	44	2,80 €
10628	44	3,10 €
10629	44	3,65 €
10630	44	3,90 €
10631	44	4,20 €
10632	44	5,30 €
10633	44	6,60 €
10634	44	7,80 €
10635	44	8,15 €
10636	44	8,80 €
10637	44	12,10 €
10638	44	12,70 €
10642	57	10,00 €

REF.	PAGINA	PREZZO
10643	57	10,00 €
10644	57	10,00 €
10672	242	9,50 €
10673	242	9,50 €
10674	242	9,50 €
10675	242	9,50 €
10732	89	18,70 €
10735	89	20,30 €
10750	139	13,00 €
10751	139	15,00 €
10766	139, 357	1,59 €
10772	386	0,05 €
10773	386	0,10 €
10774	386	0,10 €
10775	386	0,15 €
10776	386	0,20 €
10777	386	0,20 €
10778	386	0,35 €
10779	385, 386	0,05 €
10780	385, 386	0,05 €
10781	385, 386	0,05 €
10782	386	0,05 €
10783	386	0,05 €
10784	385, 386	0,05 €
10785	385, 386	0,10 €
10786	385, 386	0,15 €
10787	386	0,05 €
10788	386	0,05 €
10789	386	0,05 €
10790	386	0,05 €
10791	386	0,05 €
10792	386	0,05 €
10793	382	0,25 €
10794	382	0,40 €
10795	382	0,60 €
10796	382	0,07 €
10797	382	0,09 €
10798	382	0,12 €
10799	382	0,13 €
10800	382	0,15 €
10801	382	0,17 €
10802	382	0,19 €
10803	382	0,05 €
10804	382	0,22 €
10805	385	0,10 €
10812	385	0,30 €
10813	385	0,30 €
10823	388	0,20 €
10824	388	0,20 €
10825	388	0,20 €
10826	388	0,40 €
10827	388	0,60 €
10828	388	0,45 €

REF.	PAGINA	PREZZO
10829	388	0,20 €
10830	388	0,20 €
10831	388	0,20 €
10832	388	0,20 €
10833	388	0,20 €
10834	388	0,25 €
10835	388	0,25 €
10836	388	0,30 €
10837	388	0,30 €
10838	388	0,30 €
10839	388	0,40 €
10840	388	0,35 €
10868	390	0,30 €
10869	390	0,30 €
10870	390	0,45 €
10871	390	0,30 €
10872	390	0,40 €
10873	390	0,45 €
10874	390	0,30 €
10875	390	0,40 €
10876	390	0,45 €
10877	384	0,25 €
10878	384	0,30 €
10879	384	0,20 €
10880	384	0,20 €
10881	384	0,25 €
10882	382	0,25 €
10883	382	0,25 €
10884	382	0,25 €
10885	394	0,20 €
10886	394	0,20 €
10887	394	0,25 €
10888	394	0,30 €
10889	394	0,30 €
10890	394	0,35 €
10891	394	0,25 €
10892	394	0,30 €
10893	394	0,25 €
10894	394	0,20 €
10895	394	0,20 €
10896	394	0,30 €
10897	394	0,30 €
10898	394	0,30 €
10899	394	0,30 €
10900	394	0,30 €
10901	394	0,25 €
10902	394	0,30 €
10905	394	0,25 €
10906	394	0,25 €
10907	394	0,25 €
10908	394	0,30 €
10909	394	0,30 €
10910	394	0,30 €

REF.	PAGINA	PREZZO
10911	394	0,30 €
10912	394	0,25 €
10913	394	0,30 €
10914	394	0,25 €
10915	393, 394	0,25 €
10916	394	0,30 €
10917	393, 394	0,30 €
10918	393, 394	0,30 €
10919	393, 394	0,30 €
10920	393, 394	0,25 €
10921	393, 394	0,30 €
10923	134	1,10 €
10953	229	12,50 €
10955	200	11,00 €
10961	144	13,00 €
10964	190, 350	9,00 €
10965	190, 350	6,00 €
10966	190, 350	13,50 €
11103	139	6,00 €
11106	202	3,00 €
11107	144	4,50 €
11121	168, 169, 176	4,10 €
11122	168, 169, 176	5,45 €
11123	168, 176	6,50 €
11124	176	7,65 €
11125	176	8,50 €
11126	176	11,20 €
11127	176	13,80 €
11128	176	14,10 €
11129	176	14,10 €
11130	176	13,10 €
11131	176	14,10 €
11132	176	13,70 €
11133	176	12,00 €
11134	176	15,00 €
11135	176	17,20 €
11136	176	15,30 €
11137	176	18,20 €
11138	176	18,00 €
11139	176	18,80 €
11140	176	20,40 €
11141	176	18,60 €
11142	176	21,30 €
11143	176	26,40 €
11144	176	33,30 €
11145	176	35,30 €
11146	176	37,30 €
11147	176	41,00 €
11148	176	47,00 €
11149	176	45,00 €
11150	176	55,00 €
11151	176	57,00 €
11152	176	57,00 €
11153	172, 176	23,40 €
11154	176	21,70 €
11155	172, 176	24,40 €

REF.	PAGINA	PREZZO
11156	176	28,90 €
11157	176	26,60 €
11158	172, 176	28,50 €
11159	176	30,30 €
11160	176	27,00 €
11161	176	32,30 €
11162	176	29,10 €
11163	176	32,70 €
11164	176	30,70 €
11165	176	34,60 €
11166	176	30,90 €
11167	176	38,00 €
11168	176	41,00 €
11169	176	39,20 €
11170	176	40,00 €
11171	176	51,00 €
11172	176	48,00 €
11173	176	47,00 €
11174	176	47,00 €
11175	176	49,00 €
11176	176	56,00 €
11177	176	55,00 €
11178	176	53,00 €
11179	176	65,00 €
11180	176	59,00 €
11181	176	65,00 €
11182	176	73,00 €
11183	176	70,00 €
11184	176	87,00 €
11185	176	97,00 €
11186	176	91,00 €
11187	176	98,00 €
11188	176	103,00 €
11189	176	121,00 €
11190	176	138,00 €
11191	176	149,00 €
11192	176	152,00 €
11193	176	183,00 €
11194	176	176,00 €
11195	168, 169, 176	3,70 €
11212	63	5,00 €
11213	63	10,60 €
11214	63	12,50 €
11244	45	8,50 €
11245	45	9,15 €
11246	45	12,40 €
11247	45	14,00 €
11248	45	14,60 €
11249	45	26,50 €
11258	43	7,30 €
11259	43	8,30 €
11260	43	9,75 €
11261	43	11,35 €
11262	43	13,50 €
11314	173	8,50 €
11315	173	8,50 €
11316	173	8,50 €

REF.	PAGINA	PREZZO
11318	410	2,50 €
11324	139	17,50 €
11325	139	17,50 €
11328	355	4,00 €
11330	412	0,57 €
11360	32	2,60 €
11361	32	3,20 €
11362	32	5,20 €
11363	32	3,90 €
11364	32	4,50 €
11365	32	9,40 €
11374	200	5,50 €
11375	200	6,50 €
11376	200	5,50 €
11377	200	5,50 €
11378	200	6,50 €
11379	200	6,00 €
11380	200	6,50 €
11381	200	6,50 €
11382	200	6,00 €
11383	200	6,00 €
11384	200	6,00 €
11385	200	5,50 €
11386	200	6,00 €
11387	200	6,00 €
11388	200	6,00 €
11389	200	6,00 €
11390	200	6,00 €
11391	200	6,50 €
11392	200	6,00 €
11393	200	6,00 €
11394	200	6,00 €
11434	226	12,00 €
11435	226	12,00 €
11436	226	12,00 €
11437	226	12,00 €
11438	226	12,00 €
11439	226	12,00 €
11440	226	12,00 €
11441	226	12,00 €
11442	226	12,00 €
11443	227	14,00 €
11444	227	14,00 €
11445	227	15,00 €
11446	227	15,00 €
11447	227	15,50 €
11450	226	12,00 €
11541	180	11,00 €
11542	180	11,00 €
11543	180	11,00 €
11544	180	7,00 €
11545	180	11,00 €
11546	180	12,00 €
11547	180	12,00 €
11613	176	11,00 €
11614	176	13,00 €
11615	176	14,20 €

REF.	PAGINA	PREZZO
11616	176	18,10 €
11617	176	18,70 €
11618	176	18,80 €
11619	176	19,50 €
11621	176	290,00 €
11622	176	399,00 €
11623	176	489,00 €
11624	176	189,00 €
11625	176	282,00 €
11628	173	9,50 €
11639	43	4,00 €
11640	43	4,50 €
11641	43	5,00 €
11642	43	5,00 €
11643	43	6,00 €
11644	43	7,00 €
11645	43	7,00 €
11646	43	9,45 €
11867	308	9,00 €
11878	214	4,10 €
11879	214	5,10 €
11880	214	10,50 €
11890	359	0,55 €
11891	359	0,50 €
11893	211	7,00 €
11894	211	7,00 €
11895	211	8,65 €
11896	211	8,80 €
11897	190, 351	155,00 €
11900	370	3,50 €
11901	370	2,50 €
11902	370	3,50 €
11903	370	5,00 €
11904	370	2,00 €
11905	370	1,50 €
11906	370	8,50 €
11907	370	11,00 €
11936	202	4,00 €
11937	202	5,00 €
11938	174	47,00 €
11945	53	7,00 €
11946	53	4,50 €
11947	53	19,00 €
11956	152	5,50 €
11957	152	5,50 €
11959	189	10,50 €
11960	369, 370	1,50 €
11962	32, 168, 169, 175	7,50 €
11963	175	9,00 €
11964	32, 175	12,50 €
11965	175	16,00 €
11966	175	18,00 €
11967	175	18,00 €
11971	99	3,60 €
11974	339	1,80 €
11975	339	1,80 €
11976	339	1,80 €

REF.	PAGINA	PREZZO
11977	339	1,80 €
11978	339	1,80 €
11979	339	1,80 €
11980	339	1,80 €
11981	339	1,80 €
11982	339	1,80 €
11983	339	1,80 €
11989	144	2,00 €
11990	168, 169, 174	15,30 €
11994	89	33,00 €
11996	88	48,00 €
11997	88	39,00 €
11998	88	49,00 €
12009	162	11,00 €
12022	188	33,70 €
12029	35	5,50 €
12030	35	6,50 €
12044	305	147,00 €
12055	351	20,00 €
12060	64	2,50 €
12061	169, 170, 176	9,50 €
12062	169, 170, 176	9,50 €
12063	169, 170, 176	9,50 €
12064	169, 176	9,00 €
12065	169, 170, 176	9,00 €
12066	169, 170, 172, 176	9,00 €
12067	169, 176	9,50 €
12068	169, 170, 172, 176	9,50 €
12069	169, 170, 172, 176	9,50 €
12070	169, 170, 176	10,50 €
12071	169, 170, 176	11,00 €
12072	169, 176	12,00 €
12074	169, 174	11,50 €
12075	168, 169, 174	15,50 €
12093	226	12,00 €
12200	219	14,50 €
12901	207	5,20 €
12926	241	21,50 €
12927	241	21,50 €
12928	241	22,00 €
12929	241	23,00 €
12930	241	23,50 €
12931	171	7,50 €
12932	171	7,50 €
12933	171	8,00 €
12934	171	7,50 €
12935	171	8,00 €
12936	171	8,50 €
12937	168, 169, 174	9,50 €
12938	171	10,00 €
12939	171	10,00 €
12940	171	10,00 €
12941	171	10,00 €

REF.	PAGINA	PREZZO
12942	171	10,00 €
12943	171	10,00 €
12944	171	10,00 €
12945	171	10,50 €
12950	412	3,45 €
12952	412	1,92 €
12954	394	0,25 €
12955	180	27,80 €
12956	180	27,80 €
12957	180	27,80 €
12958	180	27,80 €
12959	180	27,80 €
12960	180	27,80 €
12961	180	27,80 €
12973	370	1,00 €
12974	196	21,00 €
12975	196	23,00 €
12977	221	36,50 €
12984	176	379,00 €
12987	152	1,50 €
12988	166	12,00 €
12995	53	7,00 €
12996	53	7,00 €
12997	53	7,50 €
12998	53	9,00 €
12999	53	9,50 €
13002	396	1,45 €
13003	396	1,70 €
13004	396	1,85 €
13005	396	1,25 €
13006	396	1,40 €
13007	396	1,30 €
13008	396	2,25 €
13009	396	1,65 €
13010	396	1,75 €
13011	396	1,15 €
13012	396	1,80 €
13013	396	1,75 €
13014	396	1,45 €
13015	396	1,20 €
13016	396	1,15 €
13017	396	2,60 €
13018	396	1,45 €
13019	396	1,75 €
13020	396	1,70 €
13021	396	1,30 €
13022	396	2,10 €
13023	396	1,50 €
13024	396	2,45 €
13025	396	1,50 €
13026	400	1,55 €
13027	400	1,85 €
13028	400	1,45 €
13029	400	1,65 €
13030	400	2,80 €
13031	400	1,85 €
13032	400	2,00 €

REF.	PAGINA	PREZZO
13033	400	1,60 €
13034	400	2,65 €
13035	400	1,65 €
13036	400	1,40 €
13037	400	2,10 €
13038	398	1,40 €
13039	398	1,65 €
13040	398	1,80 €
13041	398	1,55 €
13042	398	1,95 €
13043	398	1,20 €
13044	398	1,55 €
13045	398	1,20 €
13046	398	1,55 €
13047	398	1,45 €
13048	398	2,20 €
13049	398	2,05 €
13050	399	1,55 €
13051	399	1,50 €
13052	399	1,25 €
13053	399	2,80 €
13054	399	2,35 €
13055	399	3,00 €
13056	398	1,55 €
13057	398	1,50 €
13058	398	2,20 €
13059	398	2,35 €
13060	398	1,60 €
13061	398	2,65 €
13062	398	2,35 €
13063	398	1,15 €
13064	398	2,60 €
13065	398	2,00 €
13066	398	2,25 €
13067	398	2,55 €
13068	399	2,85 €
13069	399	4,55 €
13070	399	2,15 €
13071	399	2,05 €
13072	399	2,75 €
13073	399	2,10 €
13074	400	4,65 €
13075	400	5,35 €
13076	400	3,90 €
13077	400	2,55 €
13078	400	2,55 €
13079	400	3,35 €
13080	398	1,75 €
13081	398	2,30 €
13082	398	1,35 €
13083	398	1,50 €
13084	398	2,10 €
13085	398	1,60 €
13086	398	1,25 €
13087	398	3,30 €
13088	398	2,40 €
13089	398	1,70 €

REF.	PAGINA	PREZZO
13090	398	1,70 €
13091	398	1,25 €
13092	400	1,65 €
13093	400	2,95 €
13094	400	1,50 €
13095	400	1,20 €
13096	400	1,70 €
13097	400	1,20 €
13098	400	1,65 €
13099	400	2,75 €
13100	400	1,20 €
13101	400	1,50 €
13102	400	1,60 €
13103	400	1,80 €
13104	396	1,90 €
13105	396	2,50 €
13106	396	2,00 €
13107	396	2,15 €
13108	396	1,90 €
13109	396	2,90 €
13110	396	1,85 €
13111	396	1,20 €
13112	396	1,65 €
13113	396	2,20 €
13114	396	2,20 €
13115	396	2,50 €
13116	399	5,45 €
13117	399	3,65 €
13118	399	15,90 €
13119	399	5,60 €
13120	399	5,50 €
13121	399	8,75 €
13122	399	1,95 €
13123	399	5,35 €
13124	399	8,20 €
13125	399	5,95 €
13126	399	1,55 €
13127	399	5,60 €
13128	397	1,85 €
13129	397	2,00 €
13130	397	3,75 €
13131	397	3,45 €
13132	397	2,65 €
13133	397	3,45 €
13134	397	3,95 €
13135	397	3,45 €
13136	397	2,60 €
13137	397	2,25 €
13138	397	2,85 €
13139	397	3,85 €
13140	397	2,65 €
13141	397	1,80 €
13142	397	3,10 €
13143	397	1,95 €
13144	397	2,20 €
13145	397	3,85 €
13146	397	4,50 €

REF.	PAGINA	PREZZO
13147	397	3,10 €
13148	397	3,30 €
13149	397	3,10 €
13150	397	2,25 €
13151	397	5,35 €
13152	397	3,05 €
13153	397	3,10 €
13154	397	3,20 €
13155	397	5,60 €
13156	397	3,30 €
13157	397	3,85 €
13158	397	3,75 €
13159	397	3,20 €
13160	397	5,00 €
13161	397	3,55 €
13162	397	2,60 €
13163	397	2,80 €
13217	412	1,31 €
13226	67	4,50 €
13227	67	4,50 €
13228	67	4,50 €
13229	67	4,50 €
13230	67	4,50 €
13231	67	4,50 €
13232	67	4,50 €
13234	305	224,50 €
13235	384	0,15 €
13236	384	0,15 €
13237	384	0,15 €
13238	384	0,20 €
13239	384	0,20 €
13240	384	0,40 €
13241	384	0,55 €
13447	40	16,50 €
13448	40	17,50 €
13449	40	20,00 €
13450	40	23,00 €
13451	40	28,00 €
13452	40	29,50 €
13453	39	9,00 €
13454	39	9,50 €
13455	39	10,50 €
13456	39	11,50 €
13457	39	12,00 €
13460	39	15,00 €
13462	39	17,00 €
13463	40	5,30 €
13464	40	5,30 €
13465	38, 39, 40	5,55 €
13466	38, 39, 40	5,55 €
13467	38, 39, 40	6,00 €
13468	38, 39, 40	6,25 €
13469	38, 39, 40	6,25 €
13470	38, 39, 40	6,60 €
13471	38, 39, 40	6,90 €
13472	38, 39, 40	7,25 €
13473	38, 39, 40	8,10 €

REF.	PAGINA	PREZZO
13474	38, 39, 40	8,70 €
13475	38, 39, 40	9,10 €
13476	38, 39, 40	9,60 €
13477	40	9,85 €
13478	40	12,20 €
13479	40	13,10 €
13480	40	15,50 €
13481	40	15,80 €
13482	40	22,10 €
13483	40	25,50 €
13484	40	27,20 €
13491	40	5,30 €
13492	40	5,35 €
13493	40	5,50 €
13494	40	6,00 €
13495	40	6,40 €
13496	40	6,60 €
13497	40	7,50 €
13498	40	8,50 €
13499	162	12,50 €
13500	162	12,90 €
13667	66, 89	17,60 €
13668	88	18,70 €
13674	68, 383	0,50 €
13675	68, 383	0,50 €
13676	68, 383	0,50 €
13677	68, 383	0,50 €
13678	68, 383	0,50 €
13680	174	15,50 €
13681	174	15,50 €
13682	174	15,50 €
13683	174	15,50 €
13684	174	15,50 €
13685	174	15,50 €
13686	174	15,50 €
13687	174	15,50 €
13688	174	15,50 €
13689	174	15,50 €
13704	69	21,00 €
13707	59	14,00 €
13708	59	14,00 €
13709	59	14,00 €
13710	59	14,00 €
13712	59	14,00 €
13717	412	7,65 €
13723	176	18,50 €
13724	176	19,20 €
13725	176	19,20 €
13726	176	19,00 €
13727	176	18,70 €
13728	176	18,50 €
13729	176	22,00 €
13730	176	22,00 €
13731	176	21,60 €
13732	176	23,80 €
13733	176	24,90 €
13734	176	25,70 €

REF.	PAGINA	PREZZO
13735	176	25,80 €
13736	176	25,90 €
13738	360	3,50 €
13739	360	5,50 €
13740	360	5,50 €
13741	372	21,00 €
13745	176	25,20 €
13746	176	25,40 €
13747	176	25,40 €
13748	176	24,90 €
13805	370	10,50 €
13806	370	10,50 €
13809	166	18,50 €
13810	166	20,50 €
13813	185	7,00 €
13814	185	11,00 €
13817	151	17,00 €
13818	151	20,50 €
13819	388	6,50 €
13820	388	7,00 €
13821	388	14,00 €
13822	388	11,00 €
13823	388	6,00 €
13824	388	8,00 €
13825	388	11,50 €
13826	388	13,00 €
13827	388	15,00 €
13828	388	11,50 €
13829	388	10,50 €
13830	388	10,50 €
13831	388	12,60 €
13832	388	13,00 €
13833	388	9,00 €
13839	144	8,50 €
13842	180	8,50 €
13843	180	7,00 €
13844	180	9,00 €
13845	180	8,00 €
13856	202	7,80 €
13859	172	16,00 €
13874	172	17,50 €
13875	172	18,50 €
13876	172	18,50 €
13877	172	18,50 €
13879	360	1,38 €
13880	360	1,50 €
13923	89	7,45 €
13929	406, 410	3,45 €
13930	165	1,50 €
13931	165	2,50 €
13932	165	2,50 €
13933	165	2,00 €
13934	165	2,50 €
13935	165	2,50 €
13936	165	3,50 €
13937	165	4,00 €
13938	165	3,50 €

REF.	PAGINA	PREZZO
13939	165	4,00 €
13945	387	7,40 €
13946	387	6,70 €
13947	387	5,85 €
13948	387	5,00 €
13949	387	6,50 €
13950	387	7,80 €
13951	387	5,15 €
13952	387	10,90 €
13953	387	8,00 €
13954	387	12,70 €
13955	387	4,95 €
13956	387	4,30 €
13957	387	9,70 €
13958	387	5,45 €
13959	387	10,10 €
13960	387	9,65 €
13961	387	9,25 €
13962	387	1,76 €
13963	387	12,40 €
13964	387	15,00 €
13965	387	1,50 €
13966	387	12,90 €
13967	387	4,65 €
13968	409	1,35 €
13969	204	19,00 €
13982	303	4,00 €
14004	171	9,50 €
14005	171	10,50 €
14006	171	9,50 €
14007	171	9,50 €
14008	171	9,50 €
14009	171	9,50 €
14010	171	11,00 €
14011	171	11,00 €
14013	152	3,50 €
14026	53	5,50 €
14027	53	5,60 €
14029	53	8,50 €
14030	53	9,50 €
14031	131, 144	7,90 €
14032	144	12,00 €
14033	144	4,50 €
14034	410	9,00 €
14049	237	8,00 €
14050	237	10,50 €
14051	237	18,00 €
14052	237	19,50 €
14075	165	2,00 €
14076	165	1,50 €
14077	165	4,50 €
14078	165	4,00 €
14083	412	13,20 €
14114	89	19,30 €
14118	365	26,00 €
14120	146	22,00 €
14121	146	26,00 €

REF.	PAGINA	PREZZO
14122	148	34,00 €
14123	148	33,00 €
14124	150	20,50 €
14125	150	19,50 €
14126	153	54,00 €
14127	155	32,50 €
14129	151	12,50 €
14130	151	21,00 €
14131	149	24,00 €
14133	155	16,50 €
14135	155	12,50 €
14136	152	12,00 €
14137	159	131,00 €
14145	328	8,50 €
14146	328	8,00 €
14147	328	25,00 €
14148	328	25,00 €
14153	149	20,50 €
14154	153	42,00 €
14157	161	8,30 €
14158	161	9,95 €
14159	161	12,60 €
14160	161	12,80 €
14161	161	13,70 €
14162	153	25,50 €
14163	153	25,50 €
14164	153	25,50 €
14165	146	26,50 €
14167	70	2,50 €
14168	160	7,00 €
14169	163	3,00 €
14172	173	8,50 €
14173	173	9,50 €
14177	173	9,50 €
14178	173	9,50 €
14179	58	8,50 €
14180	58	7,90 €
14183	68	31,00 €
14187	219	6,00 €
14188	160	0,50 €
14189	412	52,00 €
14190	165	2,00 €
14191	165	2,00 €
14192	165	4,00 €
14193	165	4,00 €
14195	166	4,00 €
14196	166	4,00 €
14197	166	4,50 €
14198	166	4,00 €
14199	166	4,00 €
14200	166	4,50 €
14201	165	4,00 €
14202	165	4,00 €
14203	165	4,50 €
14204	165	1,50 €
14205	165	1,50 €
14206	165	1,50 €

REF.	PAGINA	PREZZO
14207	165	1,50 €
14208	165	1,50 €
14209	165	1,50 €
14211	237	11,00 €
14212	237	12,00 €
14213	237	12,00 €
14214	237	14,00 €
14286	153	2,99 €
14287	153	2,99 €
14288	153	6,00 €
14289	153	6,10 €
14296	74, 75, 76, 77, 83	118,00 €
14297	74, 75, 76, 77, 83	87,00 €
14298	74, 75, 76, 77, 83	51,50 €
14299	74, 75, 76, 77, 83	87,00 €
14300	220	19,00 €
14301	220	19,00 €
14314	166	5,00 €
14315	166	4,50 €
14330	153	3,50 €
14336	149	58,00 €
14340	237	10,50 €
14341	237	10,50 €
14342	237	10,50 €
14343	237	10,50 €
14344	237	11,00 €
14345	237	11,00 €
14346	237	11,00 €
14347	408	36,50 €
14348	212	12,50 €
14349	212	20,50 €
14350	403, 404	1,80 €
14351	404	1,65 €
14352	404	1,30 €
14353	404	2,10 €
14354	90	14,00 €
14355	404	1,70 €
14356	404	1,90 €
14357	404	1,90 €
14358	403, 404	1,70 €
14359	401, 404	1,05 €
14361	404	1,70 €
14364	404	1,90 €
14365	404	1,90 €
14366	404	1,45 €
14367	404	1,30 €
14368	404	1,45 €
14369	404	4,95 €
14370	404	3,00 €
14371	404	3,00 €
14372	404	1,20 €
14373	404	1,35 €
14374	403	1,70 €
14375	403	1,85 €
14376	403	2,60 €
14377	403	1,90 €

REF.	PAGINA	PREZZO
14378	403	1,90 €
14379	403	1,45 €
14380	411	51,00 €
14381	403	1,70 €
14382	403	1,85 €
14383	403	1,35 €
14384	403	2,10 €
14387	403	1,45 €
14388	403	2,05 €
14389	403	1,25 €
14390	403	1,35 €
14391	403	2,15 €
14392	403	1,35 €
14393	403	1,50 €
14395	403	1,65 €
14396	403	1,20 €
14397	403	1,45 €
14398	403	1,30 €
14399	403	1,90 €
14402	403	1,50 €
14404	403	2,10 €
14405	403	1,45 €
14406	403	1,55 €
14408	403	1,45 €
14409	403	1,35 €
14410	402	1,85 €
14411	402	1,70 €
14412	402	1,70 €
14413	402	3,25 €
14414	402	1,70 €
14415	402	1,70 €
14416	402, 403	1,25 €
14419	402	1,95 €
14420	402	1,50 €
14421	402	2,45 €
14422	401, 402	1,50 €
14423	402	3,55 €
14424	402	1,85 €
14425	402	2,05 €
14426	402	1,90 €
14427	402	1,20 €
14428	402	1,40 €
14429	402	1,80 €
14430	402	2,25 €
14431	402	1,45 €
14432	402	1,45 €
14434	402	1,60 €
14435	402	1,45 €
14436	402	1,70 €
14437	402	1,45 €
14438	402	1,35 €
14439	402	1,75 €
14440	402	1,75 €
14441	402	1,65 €
14442	402	1,45 €
14443	402	1,45 €
14444	402	1,90 €

REF.	PAGINA	PREZZO
14445	402	1,45 €
14446	401	2,80 €
14447	401	1,45 €
14448	401	2,05 €
14449	401	2,20 €
14450	401	2,15 €
14451	401	2,15 €
14452	401	2,55 €
14453	401	3,05 €
14455	401	2,10 €
14456	401	1,35 €
14457	401	1,70 €
14458	401	1,70 €
14459	401	1,45 €
14460	401	1,15 €
14461	401	1,35 €
14462	401	1,65 €
14463	401	1,65 €
14464	401	1,50 €
14465	401	2,00 €
14466	401	1,65 €
14468	401	1,30 €
14469	401	1,45 €
14471	401	1,90 €
14472	401	1,35 €
14474	401	1,50 €
14475	401	1,65 €
14476	401	2,05 €
14477	401	2,45 €
14478	401	4,05 €
14479	401	1,65 €
14480	401	2,05 €
14481	401	1,70 €
14507	412	50,00 €
14534	161	16,50 €
14560	161	8,80 €
14561	166	8,80 €
14563	214	18,00 €
14564	183	9,20 €
14565	183	26,70 €
14566	183	16,70 €
14567	183	38,00 €
14568	183	9,20 €
14569	183	9,20 €
14570	183	4,05 €
14571	183	9,20 €
14573	183	4,05 €
14578	92	12,50 €
14580	92	41,00 €
14583	148	6,00 €
14594	221, 389	2,00 €
14595	221, 389	1,50 €
14596	221, 389	2,00 €
14597	221, 389	7,60 €
14598	221, 389	17,80 €
14599	221, 389	4,50 €
14600	221, 389	9,50 €

REF.	PAGINA	PREZZO
14601	221, 389	11,00 €
14602	221, 389	11,00 €
14611	240	12,00 €
14612	240	11,00 €
14613	240	13,50 €
14616	321	96,00 €
14618	147	19,00 €
14622	123, 410	17,00 €
14623	123, 410	8,00 €
14624	123, 410	17,00 €
14625	123, 410	14,00 €
14626	123, 410	7,00 €
14633	147	22,50 €
14710	183	3,50 €
14711	183	3,75 €
14712	183	4,00 €
14713	183	4,25 €
14714	183	4,50 €
14715	183	4,75 €
14723	172	18,00 €
14724	172	18,50 €
14725	172	18,50 €
14726	172	17,50 €
14728	168, 169, 176	3,80 €
14729	168, 169, 176	3,80 €
14730	168, 169, 176	3,80 €
14731	168, 169, 176	3,80 €
14732	168, 169, 176	3,80 €
14733	168, 169, 176	4,30 €
14734	168, 169, 176	5,40 €
14735	169	6,50 €
14736	170, 176	5,00 €
14737	170, 176	5,00 €
14738	170, 176	5,50 €
14739	170, 176	5,50 €
14740	170, 176	5,55 €
14741	170, 176	5,55 €
14742	170, 176	5,55 €
14743	170, 176	5,15 €
14744	170, 176	5,35 €
14745	170, 176	6,25 €
14746	170, 176	6,40 €
14747	170, 176	7,10 €
14748	170, 176	8,30 €
14749	32, 175	2,00 €
14750	32, 175	2,00 €
14751	32, 175	4,00 €
14752	32, 175	4,00 €
14753	143	13,00 €
14771	164, 338	10,50 €
14772	164	8,50 €
14774	338	10,50 €
14775	380	30,50 €
14779	150	33,00 €
14781	377	9,90 €

REF.	PAGINA	PREZZO
14783	92	5,50 €
14793	378	12,00 €
14803	380	43,00 €
14807	412	11,00 €
14825	123	1,50 €
14826	123	1,50 €
14827	123	2,00 €
14828	123	1,50 €
14829	123	1,50 €
14830	123	1,50 €
14831	123	1,50 €
14832	123	2,00 €
14833	123	2,05 €
14834	123	2,50 €
14835	123	3,00 €
14836	123	3,50 €
14837	123	3,30 €
14838	123	3,40 €
14839	123	4,70 €
14840	123	3,35 €
14841	124	2,58 €
14842	124	9,50 €
14843	125	0,50 €
14844	125	0,50 €
14845	125	0,50 €
14846	125	0,50 €
14847	125	0,50 €
14848	125	0,50 €
14849	125	1,00 €
14850	125	1,00 €
14851	125	1,00 €
14852	125	1,00 €
14853	125	1,00 €
14854	125	1,00 €
14855	125	1,00 €
14856	125	1,00 €
14857	125	1,50 €
14858	125	1,50 €
14859	125	1,50 €
14860	125	2,00 €
14861	125	2,00 €
14862	125	2,00 €
14863	125	2,50 €
14864	125	2,50 €
14865	125	2,50 €
14866	125	3,00 €
14867	125	3,00 €
14868	125	0,55 €
14869	125	0,60 €
14870	125	1,00 €
14871	125	1,00 €
14872	125	1,00 €
14873	125	1,00 €
14874	125	1,00 €
14875	125	1,50 €
14876	125	1,50 €
14877	125	1,50 €

REF.	PAGINA	PREZZO
14878	125	2,00 €
14879	125	2,00 €
14880	125	2,50 €
14881	125	2,50 €
14882	125	3,00 €
14883	125	3,50 €
14884	125	3,65 €
14885	125	4,00 €
14886	125	4,60 €
14887	125	5,00 €
14888	125	6,00 €
14889	125	6,50 €
14890	125	7,00 €
14891	125	7,50 €
14892	125	8,00 €
14893	128	2,00 €
14894	128	1,20 €
14895	128	1,90 €
14896	128	2,10 €
14897	128	0,88 €
14898	128	0,98 €
14899	128	0,88 €
14900	128	0,98 €
14901	124	3,60 €
14902	124	4,65 €
14903	124	5,25 €
14904	124	6,85 €
14905	124	8,50 €
14906	124	10,20 €
14907	124	0,50 €
14908	124	0,60 €
14909	124	0,80 €
14910	124	1,00 €
14911	124	1,30 €
14912	124	1,55 €
14913	124	1,90 €
14914	124	2,10 €
14915	124	2,65 €
14916	124	2,95 €
14917	124	3,45 €
14920	123	2,50 €
14922	412	0,84 €
14923	412	0,84 €
14924	412	0,84 €
14925	412	0,84 €
14926	412	1,05 €
14930	204	9,50 €
14931	204	8,00 €
14932	204	9,50 €
14933	204	9,50 €
14934	124	4,25 €
14935	124	8,45 €
14945	411	303,50 €
14946	411	58,00 €
14947	411	201,50 €
14948	411	251,50 €
14950	116	6,50 €

REF.	PAGINA	PREZZO
14951	116	9,50 €
14952	116	19,00 €
14953	116	8,50 €
14970	168	2,50 €
14971	168	2,50 €
14972	168	3,50 €
14973	168, 169	11,50 €
14974	412	2,28 €
14975	410	64,00 €
14976	412	18,84 €
14978	53	7,50 €
14979	53	9,00 €
14980	53	13,00 €
14981	53	22,50 €
14982	53	27,50 €
14985	128	6,00 €
14986	128	4,00 €
14987	128	8,50 €
14988	128	8,00 €
14989	128	6,00 €
14990	128	10,50 €
14991	128	2,00 €
14992	200	8,50 €
14993	128	5,00 €
14994	128	3,50 €
14995	128	8,00 €
14996	411	65,00 €
15010	97	16,50 €
15011	97	18,00 €
15012	97	31,50 €
15014	127	20,00 €
15023	92	12,50 €
15024	92	15,00 €
15025	92	12,50 €
15026	92	15,00 €
15030	92	8,00 €
15033	92	6,00 €
15034	92	57,00 €
15035	92	8,50 €
15036	92	8,50 €
15037	92	8,00 €
15038	92	34,50 €
15040	92	12,50 €
15041	92	15,00 €
15042	92	7,50 €
15049	117	37,40 €
15050	92	9,50 €
15051	412	1,92 €
15052	219	3,00 €
15053	219	10,50 €
15054	219	34,00 €
15056	412	11,70 €
15058	92	7,50 €
15059	378	10,00 €
15062	378	1,00 €
15065	92	6,50 €
15068	90	15,20 €

REF.	PAGINA	PREZZO
15069	90	32,80 €
15070	82	0,50 €
15071	82	0,60 €
15072	82	0,70 €
15073	82	1,00 €
15074	82	1,00 €
15075	82	1,20 €
15076	82	3,50 €
15083	88	8,50 €
15084	88, 203, 307	68,00 €
15093	317	38,00 €
15094	317	39,50 €
15095	317	13,00 €
15096	317	40,00 €
15122	39, 75, 85	74,00 €
15138	51	10,50 €
15139	51	12,00 €
15140	51	13,50 €
15144	93	30,00 €
15145	94	20,45 €
15146	94	16,20 €
15147	50	5,00 €
15148	50	5,00 €
15149	50	5,00 €
15152	408	160,00 €
15155	75, 85	59,00 €
15156	43, 85	70,00 €
15157	85	42,00 €
15158	85	59,00 €
15159	85	44,00 €
15160	85	42,00 €
15161	75, 85	62,00 €
15162	36, 87, 345	30,20 €
15206	43	15,00 €
15207	43	16,50 €
15208	43	17,00 €
15209	43	18,00 €
15227	36	3,50 €
15228	36	4,00 €
15229	36	5,00 €
15230	36	5,00 €
15231	36	3,50 €
15232	36	4,00 €
15233	36	5,00 €
15234	36	3,00 €
15253	222, 225	62,00 €
15300	369	5,00 €
15313	90	14,00 €
15315	86	28,20 €
15316	39, 86	58,00 €
15317	369	4,50 €
15328	39	6,00 €
15329	39	5,50 €
15330	39	5,50 €
15331	39	5,50 €
15332	39	6,00 €
15333	39	6,50 €

REF.	PAGINA	PREZZO
15334	39	7,00 €
15335	39	7,50 €
15336	39	8,00 €
15337	39	8,50 €
15338	39	9,00 €
15339	39	9,50 €
15375	183	28,00 €
15385	135	18,00 €
15448	343	5,50 €
15454	57, 86	35,40 €
15460	343	5,00 €
15494	200	12,50 €
15495	200	12,50 €
15496	200	11,50 €
15497	200	11,00 €
15498	200	11,50 €
15499	200	11,00 €
15500	200	10,00 €
15501	200	10,00 €
15502	200	10,00 €
15503	200	11,00 €
15504	200	10,00 €
15505	200	4,00 €
15506	200	4,00 €
15507	200	4,50 €
15508	200	4,50 €
15509	200	5,00 €
15510	200	5,00 €
15511	200	8,00 €
15514	75, 86	9,35 €
15515	39	15,50 €
15516	39	19,00 €
15517	39	22,50 €
15541	86	27,60 €
15552	190, 351	181,00 €
15564	148	11,90 €
15619	355	4,00 €
15631	303	98,00 €
15632	38	9,00 €
15633	38	9,50 €
15634	38	11,00 €
15635	38	12,50 €
15636	38	14,00 €
15637	38	15,00 €
15681	85	134,00 €
15706	63, 86	31,00 €
15730	78, 84	289,00 €
15731	78, 84	214,00 €
15732	78, 84	293,50 €
15733	78, 84	113,00 €
15734	78, 84	288,50 €
15735	78, 84	152,00 €
15736	78, 84	488,50 €
15737	66, 86	45,00 €
15783	65	3,50 €
15784	65	3,50 €
15785	65	3,50 €

REF.	PAGINA	PREZZO
15786	65	3,50 €
15787	65	3,50 €
15799	63, 87	28,30 €
15866	350	32,00 €
15874	310	6,50 €
16010	46	4,00 €
16011	46	4,00 €
16012	46	4,00 €
16013	46	4,50 €
16014	46	4,50 €
16015	46	5,00 €
16016	46	5,00 €
16017	46	5,00 €
16018	46	5,50 €
16019	46	6,00 €
16020	41	17,00 €
16021	41	19,50 €
16022	41	23,00 €
16023	41	26,50 €
16024	41	34,50 €
16025	41	37,50 €
16052	137, 144	2,09 €
16053	137, 144	2,85 €
16111	61, 87	19,20 €
16130	343	290,00 €
16161	91	17,50 €
16162	91	35,10 €
16163	91	10,20 €
16188	91	39,60 €
16198	343	5,00 €
16237	237	23,00 €
16238	237	23,00 €
16239	237	23,00 €
16240	237	26,00 €
16241	237	23,00 €
16242	237	26,00 €
16243	237	23,00 €
16273	150	12,50 €
16294	395	14,00 €
16295	206	30,00 €
16300	227	7,60 €
16301	227	7,60 €
16302	227	7,60 €
16304	172	31,00 €
16305	172	31,00 €
16309	220	149,00 €
16316	221	18,50 €
16318	126	0,50 €
16319	126	0,50 €
16320	126	0,50 €
16321	126	1,00 €
16322	126	1,00 €
16323	126	1,00 €
16324	126	1,50 €
16325	126	1,50 €
16326	126	2,00 €
16327	126	2,00 €

REF.	PAGINA	PREZZO
16328	126	2,50 €
16329	126	3,00 €
16330	126	3,50 €
16331	126	3,50 €
16332	126	4,00 €
16333	126	4,50 €
16334	126	5,50 €
16335	126	6,00 €
16336	126	6,50 €
16341	147	32,50 €
16342	65	2,50 €
16343	65	2,50 €
16344	90	43,00 €
16354	90	1,50 €
16355	90	2,00 €
16356	90	2,50 €
16357	90	2,50 €
16358	90	12,00 €
16359	90	10,00 €
16360	90	12,00 €
16361	90	16,50 €
16362	90	20,00 €
16363	90	14,50 €
16364	123, 410	3,50 €
16366	206	11,00 €
16367	206	10,00 €
16368	206	12,00 €
16369	206	12,00 €
16370	206	12,00 €
16371	206	11,00 €
16372	206	11,50 €
16373	206	12,00 €
16374	206	12,00 €
16375	206	15,00 €
16376	206	15,00 €
16377	206	16,00 €
16378	206	15,00 €
16379	206	15,00 €
16380	206	16,00 €
16381	206	10,00 €
16382	206	10,00 €
16383	206	15,00 €
16384	206	15,00 €
16385	242	10,00 €
16386	242	11,50 €
16387	92	10,50 €
16388	242	11,50 €
16389	242	11,50 €
16391	39	4,60 €
16392	39	4,60 €
16393	39	4,60 €
16394	39	5,10 €
16395	39	5,10 €
16396	39	5,10 €
16397	39	5,50 €
16398	39	5,50 €
16399	39	5,50 €

REF.	PAGINA	PREZZO
16400	259	6,50 €
16401	39	6,10 €
16402	39	6,10 €
16403	39	6,10 €
16430	233	20,50 €
16431	233	20,50 €
16432	233	20,50 €
16433	233	20,50 €
16434	233	20,50 €
16435	233	21,50 €
16436	233	21,50 €
16448	222	16,50 €
16462	389	36,50 €
16463	389	36,50 €
16464	389	36,50 €
16465	389	39,50 €
16466	389	50,00 €
16467	389	36,50 €
16468	389	36,50 €
16469	389	36,50 €
16470	389	39,50 €
16471	389	50,00 €
16472	389	17,50 €
16473	389	17,50 €
16474	389	17,50 €
16475	389	17,50 €
16476	389	24,00 €
16477	389	24,50 €
16478	389	24,50 €
16479	389	7,50 €
16480	389	7,50 €
16481	93	14,00 €
16482	93	13,50 €
16490	73	650,00 €
16491	73	307,00 €
16492	73	675,00 €
16493	73	436,00 €
16494	73	139,00 €
16496	73	127,00 €
16497	73	77,00 €
16498	73	84,00 €
16499	73	162,00 €
16500	73	463,00 €
16516	73	121,00 €
16538	389	19,50 €
16539	389	18,00 €
16540	389	13,00 €
16541	389	13,00 €
16542	389	23,50 €
16543	389	13,00 €
16546	43	5,00 €
16547	43	5,50 €
16548	43	9,00 €
16549	43	14,00 €
16561	73	36,50 €
16564	147	17,00 €
16565	233	19,50 €

REF.	PAGINA	PREZZO
16566	233	22,50 €
16571	172	32,00 €
16572	172	33,50 €
16574	172	34,00 €
16575	172	34,50 €
16576	172	35,50 €
16577	172	36,00 €
16583	126	8,50 €
16584	126	10,50 €
16585	126	11,50 €
16586	126	13,00 €
16587	126	14,00 €
16588	126	15,00 €
16600	73	252,00 €
16627	73	225,00 €
16628	73	382,00 €
16629	73	419,00 €
16642	65	1,00 €
16737	226	12,00 €
50400	191	168,00 €
50403	191	98,00 €
50409	192	26,00 €
50410	191	168,00 €
50431	357	3,80 €
50517	350	129,00 €
50518	350	169,00 €
50523	357	4,70 €
50524	357	4,70 €
50525	365	1,00 €
50526	365	4,80 €
50551	357	350,00 €
50562	44	23,50 €
50564	42	30,00 €
50567	57	9,60 €
50577	186	12,60 €
50585	361	14,70 €
50600	368	0,60 €
50601	368	0,29 €
50622	46	64,00 €
50623	21	60,00 €
50630	324	590,00 €
50631	322	68,00 €
50632	335	298,00 €
50644	359	11,60 €
50651	391	18,00 €
50652	391	16,50 €
50654	354	4,00 €
50656	190, 351	290,00 €
50717	359	21,90 €
50724	69	28,00 €
50731	217	68,00 €
50751	156, 312	43,00 €
50760	368	0,10 €
50761	368	0,19 €
50762	368	0,29 €
50763	368	0,38 €
50764	368	0,49 €

REF.	PAGINA	PREZZO
50765	368	0,58 €
50766	368	0,68 €
50767	368	0,78 €
50768	368	0,88 €
50778	368	0,10 €
50779	368	0,19 €
50780	368	0,29 €
50781	368	0,38 €
50782	368	0,49 €
50783	368	0,58 €
50784	368	0,68 €
50785	368	0,78 €
50786	368	0,88 €
50787	98	8,00 €
50788	98	14,50 €
50789	98	29,00 €
50792	236	105,00 €
50793	236	94,00 €
50797	349	490,00 €
50807	221, 391	38,00 €
50808	99	77,00 €
50815	314	88,00 €
50816	315	88,00 €
50818	314	198,00 €
50819	316	28,00 €
50820	316	34,50 €
50821	316	47,00 €
50822	316	59,00 €
50823	316	94,00 €
50824	316	88,00 €
50825	316	154,00 €
50827	223, 321	387,00 €
50830	317	560,00 €
50831	322	460,00 €
50835	319	290,00 €
50836	323	148,00 €
50838	323	299,00 €
50839	320	180,00 €
50840	322	138,00 €
50843	99	79,00 €
50844	99	65,00 €
50852	312	24,50 €
50901	181	16,00 €
50902	54	13,00 €
50903	181	30,80 €
50910	142	45,00 €
50911	324	788,00 €
50913	190, 351	195,00 €
50915	357	4,20 €
50916	192	0,88 €
50917	305	271,00 €
50918	304	341,00 €
50923	188, 320	454,00 €
50924	308, 351	342,00 €
50935	304	595,00 €
50937	69	10,50 €
50942	331, 344	28,00 €

REF.	PAGINA	PREZZO
50957	95	22,00 €
50959	95, 386	14,00 €
50966	354	4,00 €
50966C	354	3,00 €
50980	34	22,00 €
50982	34	22,00 €
50983	30	48,00 €
50985	30	59,00 €
51017	56	6,80 €
51018	56	7,05 €
51020	56	6,65 €
51021	56	7,05 €
51028	172	163,00 €
51033	339	98,00 €
51035	94	799,00 €
51050	95	285,00 €
51051	95	34,80 €
51055	368	0,98 €
51059	195	99,00 €
51119	229	62,00 €
51120	213	41,00 €
51121	222	27,30 €
51123	229	91,00 €
51124	241	88,00 €
51125	238	88,00 €
51126	234	18,00 €
51127	52	56,00 €
51127R	52	14,00 €
51131	180	61,00 €
51140	240	64,00 €
51206	146	228,00 €
51207	146	289,00 €
51210	148	650,00 €
51211	148	560,00 €
51212	148	488,00 €
51213	148	690,00 €
51214	150	148,00 €
51215	150	119,00 €
51216	153	650,00 €
51218	155	288,00 €
51220	151	240,00 €
51221	151	199,00 €
51222	149	128,00 €
51226	155	233,00 €
51235	329	49,00 €
51238	328	138,00 €
51239	328	159,00 €
51245	155	99,00 €
51246	358	6,40 €
51253	305	41,00 €
51258	134	0,15 €
51259	231	58,00 €
51260	29	37,00 €
51262	52	51,00 €
51262R	52	14,00 €
51266	359	28,00 €
51272	62	7,50 €

REF.	PAGINA	PREZZO
51277	157	64,00 €
51283	196	78,00 €
51305	50	28,90 €
51306	50	28,10 €
51307	50	29,70 €
51315	410	2,50 €
51318	38	98,00 €
51326	134	4,40 €
51332	200	98,00 €
51333	32	18,00 €
51336	173	29,30 €
51337	204	50,00 €
51338	52	53,00 €
51338R	52	14,00 €
51340	296	39,30 €
51341	163	35,00 €
51347	230	9,90 €
51349	242	37,30 €
51352	201	9,80 €
51353	201	11,50 €
51354	202	13,20 €
51355	60, 369	19,00 €
51356	308	48,00 €
51358	371	7,50 €
51359	371	9,00 €
51360	181	8,05 €
51361	181	9,80 €
51362	371	3,00 €
51363	328	114,00 €
51364	221	26,00 €
51365	328	118,00 €
51368	224	19,00 €
51369	224	28,00 €
51383	157	11,10 €
51385	162	4,55 €
51386	162	5,95 €
51387	162	3,25 €
51388	153	22,00 €
51389	153	22,00 €
51390	153	22,00 €
51391	153	22,00 €
51392	153	34,00 €
51393	153	34,00 €
51398N	375	1,54 €
51400	204	17,00 €
51401	204	22,00 €
51402	204	20,50 €
51403	204	17,50 €
51405	50	21,10 €
51406	50	29,20 €
51409	33	36,00 €
51410	33	36,00 €
51412	364	2,10 €
51414	224	14,00 €
51416	47	12,00 €
51419	91	2,79 €
51422	91	2,97 €

REF.	PAGINA	PREZZO
51439	153	26,00 €
51440	153	28,00 €
51441	153	26,00 €
51442	153	28,00 €
51443	162	5,50 €
51444	162	5,05 €
51445	162	5,05 €
51447	53, 87	16,00 €
51448	53, 87	52,00 €
51452	322	69,00 €
51479	53	31,80 €
51488	273	16,00 €
51489	284	12,00 €
51490	225	36,00 €
51491	230	154,00 €
51493	207	68,00 €
51494	205	107,00 €
51495	232	59,00 €
51496	236	8,00 €
51500	240	29,00 €
51501	233	38,00 €
51504	63	8,50 €
51525	62	9,80 €
51526	62	9,80 €
51528	44	49,00 €
51538	388	0,15 €
51539	388	0,15 €
51540	388	0,15 €
51541	388	0,25 €
51542	388	0,20 €
51543	388	0,25 €
51544	388	0,25 €
51545	388	0,30 €
51546	389	0,19 €
51554	389	0,28 €
51573	134	2,50 €
51574	95	52,00 €
51575	96	317,00 €
51576	93	125,00 €
51600	96	109,00 €
51604	368	0,98 €
51612	357	5,95 €
51613	357	2,90 €
51614	357	3,60 €
51615	357	5,95 €
51616	23	378,00 €
51622	192	25,30 €
51632N	375	1,54 €
51633	375	1,54 €
51634	375	1,54 €
51636N	375	1,54 €
51638N	375	1,54 €
51640N	375	1,54 €
51642N	375	1,54 €
51653	91	5,10 €
51654	91	4,80 €
51655	91	4,10 €

REF.	PAGINA	PREZZO
51656	91	3,65 €
51657	91	5,85 €
51658	91	4,50 €
51659	46	59,00 €
51661	47	12,00 €
51674	63	7,75 €
51692	355	3,55 €
51693	355	3,55 €
51694	355	3,55 €
51696	355	3,55 €
51697	364	0,80 €
51703	359	10,50 €
51705	359	8,45 €
51706	366	22,80 €
51707	366	9,05 €
51708	366	14,20 €
51709	366	14,70 €
51710	366	17,80 €
51711	366	21,20 €
51712	366	8,65 €
51713	366	13,10 €
51714	366	15,80 €
51715	366	20,30 €
51716	366	23,60 €
51717	366	11,20 €
51718	366	14,80 €
51719	366	22,00 €
51720	366	23,50 €
51721	366	25,00 €
51722	366	13,10 €
51723	366	18,70 €
51724	366	24,40 €
51725	366	28,30 €
51726	366	31,40 €
51727	366	49,00 €
51737	94	699,00 €
51738	93	850,00 €
51741	370	0,50 €
51742	370	0,50 €
51743	370	0,55 €
51745	376	0,70 €
51746	34	12,00 €
51751	320	99,00 €
51785	376	1,00 €
51795	47	9,00 €
51796	47	14,00 €
51797	47	18,00 €
51798	47	39,60 €
51799	389	0,20 €
51801	51	62,00 €
51804	386	58,00 €
51805	53, 87	17,00 €
51812	56	46,00 €
51814	369	8,00 €
51816	329	58,00 €
51817	354	4,50 €
51818	18	109,00 €

REF.	PAGINA	PREZZO
51824	192	36,80 €
51830	52	94,00 €
51831	339	24,00 €
51832	181	18,00 €
51837	336	195,00 €
51838	336	667,00 €
51839	198	24,00 €
51842	330	6,90 €
51843	389	0,19 €
51853	70	18,00 €
51855	23	378,00 €
51858	364	15,00 €
51859	339	3,80 €
51861	159, 359	199,00 €
51863	366	54,00 €
51864	45, 87	64,00 €
51886	142	44,00 €
51889	130	49,00 €
51890	46	92,00 €
51895	315	99,00 €
51896	235	82,00 €
51897	235	122,00 €
51898	235	139,00 €
51899	235	137,00 €
51901	319	999,00 €
51902	229	84,00 €
51905	316	34,50 €
51906	316	39,00 €
51907	316	48,00 €
51908	368	44,00 €
51909	65	2,46 €
51918	63	12,50 €
51919	228	89,00 €
51920	234, 392	18,00 €
51923	201	12,50 €
51925	365	1,00 €
51927	296	25,00 €
51928	308	14,00 €
51929	143	22,00 €
51934	201	11,50 €
51935	354	135,00 €
51936	354	135,00 €
51937	354	135,00 €
51951	70	15,60 €
51958	228	422,00 €
51960	138	34,00 €
51961	138	34,00 €
51962	138	25,00 €
51963	138	29,00 €
51964	138	28,00 €
51965	138	29,50 €
51966	139	18,00 €
51967	144	16,00 €
51968	144	16,00 €
51969	139	14,00 €
51972	60	12,00 €
51973	366	45,00 €

REF.	PAGINA	PREZZO
51975	91	2,27 €
51976	91	1,63 €
51978	191	84,00 €
51980	156	15,00 €
51981	157	21,50 €
51982	349	120,00 €
51983	349	185,00 €
51984	349	190,00 €
51985	191	84,00 €
51986	234	11,90 €
51989	216	49,00 €
51991	230	54,00 €
51995	58, 59	24,50 €
51998	226	38,00 €
52010	239	80,00 €
52012	228	68,00 €
52016	235	2,10 €
52017	235	2,40 €
52018	235	2,60 €
52019	235	3,20 €
52021	235	3,40 €
52022	235	4,50 €
52023	235	6,60 €
52024	235	10,60 €
52025	235	13,00 €
52026	181	31,80 €
52027	382	14,00 €
52028	385	15,20 €
52029	385	14,00 €
52030	388	98,00 €
52031	387	44,00 €
52032	386	28,00 €
52033	390	43,00 €
52043	384	16,50 €
52044	382	19,00 €
52047	357	3,30 €
52048	357	3,95 €
52049	66	14,00 €
52050	59	98,00 €
52052	57	53,00 €
52053	394	45,00 €
52054	394	17,00 €
52055	322	139,00 €
52056	242	66,00 €
52057	191	6,80 €
52058	191	4,50 €
52059	35	29,00 €
52060	35	32,00 €
52065	191	45,00 €
52066	218	12,00 €
52069	328	29,50 €
52070	328	40,00 €
52071	328	47,00 €
52076	211	111,00 €
52077	183	29,50 €
52148	99	65,00 €
52149	349	230,00 €

REF.	PAGINA	PREZZO
52152	60	13,50 €
52153	227	46,00 €
52156	149	140,00 €
52157	155	48,00 €
52158	386	38,50 €
52159	151	64,00 €
52160	151	48,00 €
52162	79, 338, 346	38,00 €
52163	388	95,00 €
52165	149	118,00 €
52167	150	48,00 €
52169	55	25,00 €
52170	55	16,00 €
52171	155	39,00 €
52180	63	19,00 €
52181	63	22,50 €
52182	63	24,00 €
52183	63	26,20 €
52184	63	43,00 €
52185	63	55,00 €
52186	63	72,00 €
52187	364	21,80 €
52188	63	15,50 €
52190	216	8,00 €
52191	197	198,00 €
52195	334	170,00 €
52197	50	36,30 €
52198	32	37,70 €
52200	351	88,00 €
52202	351	88,00 €
52207	50	24,20 €
52227	223	247,00 €
52230	190, 350	398,00 €
52231	330	49,00 €
52233	330	328,00 €
52235	48	11,00 €
52236	48	13,30 €
52237	48	18,10 €
52238	48	24,90 €
52241	319	1.690,00 €
52242	311	12,00 €
52243	311	8,50 €
52244	191	84,00 €
52251	364	21,80 €
52254	135	64,00 €
52259	359	3,75 €
52262	185	7,50 €
52263	185	13,50 €
52264	185	18,60 €
52265	185	30,50 €
52269	202	7,00 €
52270	224	109,00 €
52271	283	18,00 €
52272	57	24,60 €
52273	212	44,00 €
52275	198	38,00 €
52293	231	98,00 €

REF.	PAGINA	PREZZO
52295	185	6,50 €
52296	239	119,00 €
52297	239	172,00 €
52298	239	177,00 €
52302	140	25,40 €
52303	140	26,40 €
52304	316	84,00 €
52305	205	106,00 €
52308	100	440,00 €
52309	100	941,00 €
52310	375	3,65 €
52311	201	19,00 €
52312	201	9,00 €
52313	201	8,00 €
52314	201	26,60 €
52315	198	16,00 €
52316	232	18,90 €
52317	232	19,90 €
52318	69	73,00 €
52319	232	8,80 €
52320	34	22,00 €
52321	186	8,80 €
52327	186	12,00 €
52328	197	99,00 €
52329	303	36,40 €
52330	194	99,00 €
52331	159	201,00 €
52337	168	65,00 €
52338	173	41,00 €
52339	171	61,00 €
52340	171	58,00 €
52341	169	58,00 €
52342	170	63,00 €
52343	173	52,00 €
52344	171	197,00 €
52345	168	109,00 €
52346	169	103,00 €
52347	171	158,00 €
52348	172	179,00 €
52349	48	22,10 €
52350	48	22,60 €
52351	48	25,40 €
52352	48	32,40 €
52353	48	33,40 €
52354	48	34,40 €
52355	48	36,60 €
52357	48	54,00 €
52358	48	63,00 €
52362	357	1,23 €
52363	357	1,23 €
52364	357	2,86 €
52365	357	2,46 €
52368	357	1,14 €
52369	357	1,19 €
52370	357	1,17 €
52373	93	252,00 €
52375	137	38,00 €

REF.	PAGINA	PREZZO
52378	163	10,00 €
52381	157	20,50 €
52382	331, 344	19,50 €
52384	132	29,00 €
52385	186	251,00 €
52386	186	23,60 €
52390	187	35,20 €
52391	311	5,00 €
52412	59	5,00 €
52414	141	19,00 €
52415	141	19,00 €
52416	203	14,00 €
52417	203	28,00 €
52418	21	179,00 €
52419	89	80,00 €
52420	89	108,00 €
52421	89	172,00 €
52422	213	24,70 €
52424	47	64,00 €
52425	63	33,30 €
52426	63	52,00 €
52427	63	64,00 €
52428	305	40,00 €
52430	376	10,90 €
52432	224	35,00 €
52433	69	4,80 €
52434	197	125,00 €
52439	331	227,00 €
52450	338	105,00 €
52451	43	42,00 €
52452	310	8,00 €
52453	310	21,00 €
52454	238	12,90 €
52455	198	16,00 €
52456	137	36,00 €
52460	63	16,60 €
52461	63	25,70 €
52462	68	25,30 €
52463	67	26,10 €
52464	67	42,00 €
52466	98	11,00 €
52468	62	5,90 €
52472	62	4,90 €
52473	62	9,90 €
52474	187	68,00 €
52475	187	62,00 €
52476	187	50,00 €
52477	187	70,00 €
52478	187	49,00 €
52479	187	24,70 €
52480	187	44,00 €
52481	187	52,00 €
52482	187	44,00 €
52483	187	41,00 €
52484	187	66,00 €
52485	187	51,00 €
52486	187	62,00 €

REF.	PAGINA	PREZZO
52487	187	63,00 €
52488	211	28,00 €
52489	210	58,00 €
52490	156	6,65 €
52491	156	10,50 €
52493	378	4,50 €
52494	241	227,00 €
52495	216	14,50 €
52497	192	26,80 €
52498	308	58,00 €
52500	54	19,00 €
52502	187	31,40 €
52503	187	32,50 €
52504	187	27,60 €
52505	187	20,80 €
52506	187	16,00 €
52507	187	30,10 €
52508	59	38,40 €
52509	59	36,20 €
52511	187	42,00 €
52512	187	50,00 €
52514	320	84,00 €
52515	70, 216	9,10 €
52516	98	28,00 €
52517	98	6,00 €
52518	201	115,00 €
52519	36, 345	25,50 €
52524	53	51,00 €
52525	53	13,80 €
52526	53	28,40 €
52527	151	82,00 €
52528	155	49,00 €
52530	361	14,00 €
52533	161, 182	10,00 €
52534	361	15,00 €
52535	361	16,50 €
52536	130	57,00 €
52538	31	62,00 €
52539	31	59,00 €
52540	159, 182	221,00 €
52541	222	45,00 €
52542	99	109,00 €
52543	160	182,00 €
52544	175	93,00 €
52545	175	177,00 €
52546	171	39,60 €
52547	168	96,00 €
52550	30	92,00 €
52551	242	151,00 €
52552	372	128,00 €
52555	134	2,38 €
52558	134	2,38 €
52565	63	11,50 €
52566	140	28,00 €
52567	140	29,00 €
52568	141	28,00 €
52569	141	28,00 €

REF.	PAGINA	PREZZO
52570	375	2,60 €
52571	375	2,60 €
52572	375	2,60 €
52573	375	2,60 €
52574	152	69,00 €
52575	68, 160	119,00 €
52583	69	8,50 €
52587	50	39,90 €
52588	50	45,00 €
52591	214	12,00 €
52592	214	22,00 €
52593	214	34,00 €
52595	68	64,00 €
52596	67	114,00 €
52597	67	146,00 €
52598	121, 340	1.080,00 €
52599	210	230,00 €
52600	342	884,00 €
52601	304	397,00 €
52603	28	74,00 €
52604	28	78,00 €
52605	28	76,00 €
52606	28	88,00 €
52607	203	49,00 €
52608	203	44,00 €
52609	68	29,00 €
52615	201	112,00 €
52616	296	44,00 €
52617	204	7,00 €
52618	365	29,00 €
52619	59	23,10 €
52620	31	8,80 €
52621	232	11,00 €
52624	241	28,00 €
52625	60, 198	9,00 €
52626	238	46,00 €
52627	238	120,00 €
52628	308	26,50 €
52629	208	99,00 €
52633	359	1,00 €
52634	91	5,25 €
52635	91	4,80 €
52636	194	114,00 €
52637	229	48,00 €
52638	69	9,95 €
52639	209	123,00 €
52640	225	52,00 €
52641	225	55,00 €
52642	228	32,00 €
52643	339	596,00 €
52644	360	8,80 €
52645	371	0,55 €
52646	371	0,50 €
52648	158	9,00 €
52649	370	5,00 €
52650	370	5,00 €
52652	369	2,80 €

REF.	PAGINA	PREZZO
52653	369	3,00 €
52655	371	39,70 €
52656	371	39,50 €
52657	371	37,50 €
52658	371	39,70 €
52659	371	39,70 €
52660	372	126,00 €
52662	370	36,50 €
52663	370	30,00 €
52664	372	168,00 €
52665	368	0,37 €
52666	368	0,36 €
52667	368	0,76 €
52668	368	1,49 €
52669	368	2,22 €
52670	368	2,95 €
52671	368	3,70 €
52672	368	4,45 €
52673	370	18,00 €
52675	154	84,00 €
52676	154	98,00 €
52677	202	17,00 €
52678	202	18,00 €
52685	210	88,00 €
52687	218	168,00 €
52690	215	54,00 €
52691	232	54,00 €
52692	324	129,00 €
52693	213	24,50 €
52694	168	49,00 €
52696	213	12,00 €
52697	213	16,00 €
52699	228	22,00 €
52700	70	20,50 €
52703	384	22,00 €
52711	383	27,50 €
52714	33	15,70 €
52715	33	10,00 €
52716	33	15,90 €
52717	33	11,00 €
52718	152	48,00 €
52719	389	0,19 €
52722	22	87,00 €
52724	151	381,00 €
52725	151	349,00 €
52727	239	34,60 €
52728	239	68,00 €
52729	239	128,00 €
52730	239	288,00 €
52731	239	38,00 €
52732	239	58,00 €
52733	239	98,00 €
52734	213	51,00 €
52735	166	4,85 €
52736	166	5,35 €
52737	166	5,50 €
52738	375	5,00 €

REF.	PAGINA	PREZZO
52739	375	5,00 €
52740	184	690,00 €
52749	189	79,00 €
52753	30	107,00 €
52754	204	54,00 €
52757	209	16,00 €
52758	154	88,00 €
52760	70, 216	4,10 €
52761	61	8,00 €
52762	61	9,00 €
52765	185	21,70 €
52768	356	13,80 €
52769	356	14,50 €
52770	356	23,00 €
52771	356	23,40 €
52772	356	13,90 €
52773	356	14,60 €
52774	356	14,80 €
52775	356	15,20 €
52776	356	13,80 €
52777	356	15,50 €
52778	356	14,60 €
52779	356	17,10 €
52780	356	13,90 €
52781	356	14,60 €
52782	356	14,80 €
52783	356	15,20 €
52786	64	14,60 €
52787	157	9,00 €
52788	181	39,00 €
52789	308	15,20 €
52791	58, 59	18,00 €
52794	69	28,00 €
52795	354	5,80 €
52796	228	98,00 €
52797	305	198,00 €
52798	156	18,00 €
52801	212	26,00 €
52802	226	54,00 €
52804	309	343,00 €
52805	309	426,00 €
52806	309	742,00 €
52807	309	1.714,00 €
52809	201	8,50 €
52810	170	9,00 €
52811	170	9,90 €
52812	59	65,00 €
52813	212	79,00 €
52814	149	528,00 €
52815	208	110,00 €
52816	232	28,10 €
52817	232	23,50 €
52819	216	22,00 €
52821	212	28,80 €
52822	230	32,00 €
52823	226	124,00 €
52827	138	46,00 €

REF.	PAGINA	PREZZO
52828	138	43,00 €
52829	222	19,00 €
52830	64	24,00 €
52831	64	18,00 €
52832	215	75,00 €
52833	237	39,30 €
52834	224	195,00 €
52835	224	272,00 €
52836	184	1.100,00 €
52838	142	56,00 €
52839	142	64,00 €
52842	372	11,00 €
52843	139	31,60 €
52845	323	170,00 €
52846	57	37,80 €
52847	57	41,00 €
52849	230	8,50 €
52850	215	7,80 €
52851	181, 395	9,65 €
52852	230	6,80 €
52858	206	298,00 €
52862	357	1,15 €
52864	357	1,20 €
52865	357	0,50 €
52866	357	0,25 €
52869	100	52,00 €
52870	100	100,00 €
52871	100	258,00 €
52873	69	11,00 €
52874	225	82,00 €
52875	225	79,00 €
52876	180	182,00 €
52877	64	15,80 €
52878	64	11,20 €
52879	64	10,10 €
52880	47	42,00 €
52881	47	17,00 €
52882	213	14,00 €
52884	329	73,00 €
52885	64	18,00 €
52886	396	18,00 €
52887	396	22,00 €
52888	400	24,00 €
52889	398	19,00 €
52890	399	22,00 €
52891	398	28,00 €
52892	399	22,00 €
52893	400	26,00 €
52894	398	22,00 €
52895	400	22,00 €
52896	396	26,00 €
52897	399	38,00 €
52898	399	36,00 €
52899	397	34,00 €
52900	397	34,00 €
52901	397	34,00 €
52902	342	970,00 €

REF.	PAGINA	PREZZO
52903	342	1.100,00 €
52904	69	61,00 €
52905	70	28,00 €
52906	196	38,00 €
52908	34	17,00 €
52909	34	12,50 €
52910	138	39,00 €
52912	45, 87	91,00 €
52913	51	292,00 €
52914	177	223,00 €
52915	177	199,00 €
52916	177	218,00 €
52917	177	122,00 €
52918	177	146,00 €
52919	177	181,00 €
52920	177	155,00 €
52921	177	117,00 €
52922	177	180,00 €
52923	177	59,00 €
52924	177	52,00 €
52925	177	176,00 €
52926	177	201,00 €
52927	177	59,00 €
52928	177	172,00 €
52929	177	185,00 €
52930	178	117,00 €
52931	178	45,00 €
52932	178	45,00 €
52933	178	194,00 €
52934	178	102,00 €
52935	178	94,00 €
52936	178	199,00 €
52937	178	265,00 €
52938	178	199,00 €
52939	178	28,00 €
52940	178	235,00 €
52941	178	70,00 €
52942	178	105,00 €
52943	178	75,00 €
52944	178	110,00 €
52945	178	281,00 €
52952	331, 344	74,00 €
52953	152	38,00 €
52955	61	19,80 €
52956	61	19,60 €
52957	61	23,80 €
52958	61	28,20 €
52959	61	42,00 €
52960	61	46,00 €
52962	226	42,00 €
52963	217	49,00 €
52964	56	9,45 €
52965	56	9,20 €
52966	56	9,45 €
52967	56	9,40 €
52969	172	20,70 €
52973	42	59,00 €

REF.	PAGINA	PREZZO
52977	182	137,00 €
52980	335	480,00 €
52982	60, 186	53,00 €
52985	322	598,00 €
52987	132	20,00 €
52991	311	10,50 €
52992	311	18,00 €
52998	185	48,00 €
52999	321	178,00 €
53001	217	242,00 €
53007	357	0,42 €
53008	201	15,50 €
53009	209	42,00 €
53010	54	18,00 €
53017	38	57,00 €
53018	40	119,00 €
53025	69	3,50 €
53026	69	5,80 €
53027	69	9,00 €
53028	331	5,80 €
53029	331	6,80 €
53030	331	12,00 €
53031	100	59,00 €
53032	100	126,00 €
53033	364	21,50 €
53037	371	0,50 €
53038	371	0,50 €
53039	371	0,50 €
53040	371	0,50 €
53041	235	37,60 €
53042	69	9,90 €
53043	175	53,00 €
53044	175	121,00 €
53045	140	35,00 €
53046	140	39,00 €
53047	141	330,00 €
53048	141	89,00 €
53049	140	89,00 €
53051	141	158,00 €
53052	140	158,00 €
53053	215	12,00 €
53054	238	6,00 €
53055	236	33,00 €
53056	241	127,00 €
53057	217	149,00 €
53058	241	193,00 €
53059	242	52,00 €
53060	170	34,90 €
53062	240	99,00 €
53063	162	36,70 €
53064	162	37,40 €
53065	162	36,90 €
53066	162	61,00 €
53067	162	61,00 €
53068	162	63,00 €
53069	208	98,00 €
53070	48	16,20 €

REF.	PAGINA	PREZZO
53071	48	26,10 €
53072	48	31,60 €
53073	48	50,00 €
53074	17	78,00 €
53077	174	62,00 €
53078	310	18,00 €
53079	189	89,00 €
53080	189	99,00 €
53081	52	115,00 €
53082	52	148,00 €
53083	65	64,00 €
53084	34	24,00 €
53085	135	30,00 €
53086	238	9,00 €
53087	356	11,20 €
53088	356	11,50 €
53089	356	11,50 €
53090	356	11,50 €
53091	356	10,20 €
53092	356	10,20 €
53093	356	10,20 €
53094	356	10,20 €
53095	66	20,50 €
53096	209	28,80 €
53108	22	92,00 €
53110	181, 395	27,30 €
53111	332	19,00 €
53112	314	298,00 €
53118	230	231,00 €
53119	213	52,00 €
53120	65	6,00 €
53121	65	7,35 €
53122	65	9,50 €
53124	188	287,00 €
53125	188	477,00 €
53126	189	243,00 €
53127	34	12,00 €
53129	216	84,00 €
53134	189	144,00 €
53137	155	38,00 €
53140	152	98,00 €
53141	155	68,00 €
53144	307	18,00 €
53145	332	39,20 €
53146	239	30,50 €
53147	163	41,00 €
53150	369	24,00 €
53151	143	14,00 €
53154	36, 345	462,00 €
53156	32	26,20 €
53159	25	289,00 €
53162	332	60,00 €
53164	36, 345	16,50 €
53165	36, 345	19,60 €
53166	339	10,50 €
53167	339	12,50 €
53168	339	19,00 €

REF.	PAGINA	PREZZO
53177	356	11,90 €
53178	356	12,20 €
53179	356	12,20 €
53180	356	12,20 €
53181	356	11,90 €
53182	356	12,20 €
53183	356	12,70 €
53184	356	12,20 €
53185	355	13,20 €
53186	355	13,20 €
53187	311	39,00 €
53188	311	7,00 €
53189	337	128,00 €
53190	337	98,00 €
53191	98	14,80 €
53192	98	52,00 €
53196	192	33,00 €
53197	174	46,00 €
53198	311	9,50 €
53200	318	69,00 €
53202	160	15,70 €
53203	357	0,46 €
53204	160	81,00 €
53205	157	19,00 €
53206	202	38,20 €
53207	225	118,00 €
53208	225	126,00 €
53209	329	8,50 €
53210	48	48,00 €
53211	99	75,00 €
53212	16	174,00 €
53214	309	285,00 €
53215	307	19,00 €
53216	130	49,00 €
53217	132	47,00 €
53218	318	26,00 €
53220	334	260,00 €
53221	365	4,75 €
53224	180	142,00 €
53225	56	3,50 €
53226	192	14,90 €
53227	135	28,00 €
53229	388	38,70 €
53230	183	19,70 €
53232	185	39,00 €
53235	203	10,40 €
53236	203	11,50 €
53237	203	12,90 €
53238	203	18,40 €
53240	234	58,00 €
53241	361	9,00 €
53246	324	1.144,00 €
53249	231	192,00 €
53250	208	85,00 €
53251	213	88,00 €
53253	96	98,00 €
53256	368	34,00 €

REF.	PAGINA	PREZZO
53259	249	97,00 €
53260	249	168,00 €
53261	249	214,00 €
53262	250	251,00 €
53263	250	57,00 €
53264	250	143,00 €
53265	251	195,00 €
53266	251	224,00 €
53267	251	277,00 €
53268	258	92,00 €
53269	252	50,00 €
53270	270	70,00 €
53271	270	227,00 €
53272	271	195,00 €
53273	271	75,00 €
53274	284	30,50 €
53275	284	35,50 €
53276	285	160,00 €
53277	285	45,00 €
53278	285	143,00 €
53279	286	97,00 €
53280	286	112,00 €
53281	286	55,00 €
53282	287	48,00 €
53283	287	92,00 €
53284	287	306,00 €
53285	288	56,00 €
53286	288	87,00 €
53287	288	245,00 €
53288	289	72,00 €
53289	274	45,00 €
53290	274	51,00 €
53291	274	68,00 €
53292	275	116,00 €
53293	261	134,00 €
53294	261	119,00 €
53295	262	77,00 €
53296	262	60,00 €
53297	267	45,00 €
53298	267	91,00 €
53299	278	291,00 €
53300	278	41,00 €
53301	278	44,00 €
53302	279	44,00 €
53303	244	89,00 €
53304	244	279,00 €
53305	279	136,00 €
53306	244	53,00 €
53307	279	38,50 €
53308	245	55,00 €
53309	245	285,00 €
53310	245	498,00 €
53311	275	97,00 €
53312	246	127,00 €
53313	258	139,00 €
53314	258	98,00 €
53315	295	285,00 €

REF.	PAGINA	PREZZO
53316	280	34,00 €
53317	280	34,00 €
53318	261	24,00 €
53319	246	18,00 €
53320	289	12,00 €
53321	289	10,50 €
53324	264	12,50 €
53325	289	7,50 €
53326	290	16,00 €
53327	290	11,00 €
53328	226	76,00 €
53330	212	38,00 €
53331	67	31,80 €
53332	67	34,50 €
53339	70	9,50 €
53340	388	86,00 €
53343	149	285,00 €
53346	50	18,00 €
53347	205	100,00 €
53348	382	14,00 €
53349	392	14,00 €
53350	382	14,00 €
53351	384	12,50 €
53352	390	12,00 €
53353	387	18,00 €
53354	384	14,00 €
53355	393	11,50 €
53356	393	11,50 €
53357	394	7,00 €
53358	390	11,50 €
53359	390	16,00 €
53360	384	18,00 €
53361	384	24,00 €
53362	385	14,00 €
53363	382	34,00 €
53364	382	16,00 €
53365	385	14,00 €
53366	385	14,00 €
53367	393	9,50 €
53368	393	9,00 €
53369	385	14,00 €
53370	393	26,00 €
53371	383	29,00 €
53372	383	26,00 €
53373	383	14,50 €
53374	392	10,00 €
53376	392	10,50 €
53377	386	20,00 €
53378	390	13,00 €
53380	393	11,50 €
53381	390	14,50 €
53382	383	11,00 €
53383	383	11,50 €
53384	225	165,00 €
53385	61, 394	19,30 €
53388	233	90,00 €
53389	57	31,50 €

REF.	PAGINA	PREZZO
53390	58	34,50 €
53391	234	86,00 €
53393	234	118,00 €
53394	223	598,00 €
53395	218	16,00 €
53396	58	18,30 €
53399	92	3,50 €
53400	92	5,70 €
53401	92	7,40 €
53402	92	9,60 €
53403	92	6,50 €
53404	92	6,50 €
53405	92	5,30 €
53406	92	8,55 €
53407	92	12,70 €
53408	92	19,30 €
53409	92	9,00 €
53410	217	92,00 €
53411	60	5,00 €
53412	60	4,00 €
53414	333	49,00 €
53415	333	188,00 €
53416	158	14,10 €
53417	158	26,30 €
53418	158	16,90 €
53419	372	9,70 €
53420	44	72,00 €
53421	315	298,00 €
53422	314	368,00 €
53423	323	199,00 €
53426	217	39,80 €
53427	134	5,00 €
53428	139	18,00 €
53429	139	18,00 €
53430	178	286,00 €
53434	392	18,00 €
53441	201	9,80 €
53444	27	195,00 €
53445	60	17,10 €
53449	158	16,40 €
53450	158	28,30 €
53452	280	26,50 €
53453	218	7,00 €
53456	220	98,00 €
53459	221	66,00 €
53463	242	98,00 €
53464	209, 387	153,00 €
53468	52	8,50 €
53470	171	176,00 €
53472	204	12,00 €
53473	204	36,00 €
53474	234	94,00 €
53477	217	36,10 €
53478	52	4,55 €
53479	52	6,40 €
53480	52	19,90 €
53481	52	27,40 €

REF.	PAGINA	PREZZO
53484	332	615,00 €
53485	205	140,00 €
53486	183	29,30 €
53487	59	16,70 €
53488	229	61,00 €
53489	211	68,00 €
53490	209	275,00 €
53492	163, 410	380,00 €
53499	220	29,00 €
53500	220	29,00 €
53501	209	24,00 €
53502	236	38,70 €
53503	338	12,00 €
53504	410	38,00 €
53505	135	77,00 €
53506	135	36,00 €
53507	354	27,00 €
53508	365	14,00 €
53517	64	9,50 €
53518	310	3,50 €
53519	130	42,00 €
53520	146	228,00 €
53522	209	24,00 €
53523	275	91,00 €
53524	237	51,00 €
53525	182	12,00 €
53526	338, 348	119,00 €
53531	169	109,00 €
53532	164, 348	119,00 €
53533	409	1,50 €
53536	143	34,00 €
53537	204	14,50 €
53538	204	14,50 €
53539	219	66,00 €
53541	152	168,00 €
53542	159, 372	980,00 €
53543	337	13,80 €
53545	180	35,70 €
53547	56	14,70 €
53548	56	15,60 €
53549	56	14,30 €
53550	56	14,70 €
53551	374	16,00 €
53552	374	16,00 €
53553	374	16,00 €
53561	365	28,00 €
53565	24	258,00 €
53566	304	32,00 €
53567	161	43,00 €
53568	133	12,00 €
53569	133	18,00 €
53570	136	154,00 €
53572	161	348,00 €
53573	151	36,00 €
53574	31	47,00 €
53575	55	16,00 €
53576	153	189,00 €

REF.	PAGINA	PREZZO
53581	164, 348	119,00 €
53582	164, 348	174,00 €
53583	164, 348	174,00 €
53584	338, 348	119,00 €
53585	338, 348	168,00 €
53586	338, 348	168,00 €
53587	173	44,00 €
53588	146	178,00 €
53589	70	12,00 €
53590	321	1.190,00 €
53591	64	5,50 €
53592	312	25,00 €
53593	160	41,00 €
53594	163	54,00 €
53595	163	61,00 €
53596	376	3,65 €
53597	376	3,70 €
53598	376	3,95 €
53599	221, 389	30,30 €
53602	61	30,50 €
53603	61	45,00 €
53604	61	118,00 €
53605	372	141,00 €
53606	158	55,00 €
53608	148	98,00 €
53609	302	182,50 €
53610	302	294,00 €
53611	156	27,50 €
53612	310	96,00 €
53613	68	19,50 €
53614	68	21,50 €
53615	68	34,60 €
53616	68	10,40 €
53617	68	9,25 €
53618	68	13,90 €
53620	89	88,00 €
53621	355	2,50 €
53622	355	2,50 €
53623	355	2,50 €
53624	355	2,50 €
53625	160	68,00 €
53626	154, 184	18,00 €
53627	305	22,50 €
53629	164	14,30 €
53630	164	18,80 €
53631	164	33,50 €
53632	164	46,00 €
53633	164	46,00 €
53634	164	63,00 €
53635	225	85,00 €
53636	354	22,00 €
53637	215	85,00 €
53638	222	243,00 €
53639	47	28,60 €
53640	47	34,40 €
53641	47	41,00 €
53642	47	54,00 €

REF.	PAGINA	PREZZO
53643	47	92,00 €
53644	303	1.238,00 €
53645	303	268,00 €
53646	153	69,00 €
53648	290	107,00 €
53649	291	89,00 €
53650	212	47,00 €
53651	280	91,00 €
53652	237	53,00 €
53653	264	207,00 €
53654	47	81,00 €
53655	182	12,00 €
53656	334	198,00 €
53657	334	248,00 €
53658	334	99,00 €
53659	334	121,00 €
53660	334	146,00 €
53661	77	790,00 €
53662	214	89,00 €
53663	235	8,00 €
53664	238	38,00 €
53665	238	19,00 €
53666	238	28,00 €
53667	35	32,00 €
53668	35	34,00 €
53669	215	45,00 €
53670	202	29,50 €
53671	51, 89	41,00 €
53672	82	440,00 €
53673	183	80,00 €
53674	94	447,00 €
53675	186	50,00 €
53676	186	44,00 €
53677	186	55,00 €
53678	186	52,00 €
53681	149	743,00 €
53682	322	98,00 €
53683	196	116,00 €
53684	321	1.880,00 €
53685	189	310,00 €
53686	77	790,00 €
53687	328	298,00 €
53688	328	495,00 €
53689	147	238,00 €
53690	137	34,00 €
53691	137	36,00 €
53693	360	521,00 €
53694	54	18,40 €
53695	360	504,00 €
53696	209	22,00 €
53697	302	398,00 €
53698	360	717,00 €
53701	240	188,00 €
53702	97	28,50 €
53703	97	41,00 €
53704	97	42,00 €
53705	191	80,00 €

REF.	PAGINA	PREZZO
53706	291	98,00 €
53707	136	153,00 €
53708	74, 76, 77, 83	325,00 €
53710	404	16,00 €
53711	404	16,00 €
53712	403	16,00 €
53713	403	16,00 €
53714	403	16,00 €
53715	402	19,00 €
53716	402	19,00 €
53717	402	19,00 €
53718	401	19,00 €
53719	401	19,00 €
53720	401	19,00 €
53721	355	18,80 €
53724	332	46,00 €
53725	314	248,00 €
53726	148	128,00 €
53727	23	198,00 €
53728	23	198,00 €
53729	184	19,10 €
53733	147	238,00 €
53734	130	23,70 €
53735	203	44,00 €
53736	189	98,00 €
53737	45	12,50 €
53738	45	10,90 €
53739	45	10,50 €
53740	45	9,10 €
53741	204	14,00 €
53742	223	1.325,00 €
53743	32, 175	39,70 €
53744	170	63,00 €
53745	362	6,40 €
53746	362	6,40 €
53747	362	6,40 €
53748	362	6,60 €
53749	362	6,70 €
53750	362	6,70 €
53751	362	6,80 €
53752	362	6,95 €
53753	362	7,10 €
53754	362	7,40 €
53755	362	7,50 €
53756	362	7,90 €
53757	362	7,90 €
53758	362	8,20 €
53759	362	8,50 €
53760	362	9,60 €
53761	77	490,00 €
53762	77	490,00 €
53767	77	790,00 €
53768	77	490,00 €
53769	80, 297, 300	178,00 €
53770	80, 298, 300	198,00 €
53771	80, 299, 300	158,00 €

REF.	PAGINA	PREZZO
53772	80, 299, 300	229,00 €
53773	80, 297, 300	298,00 €
53774	80, 298, 300	190,00 €
53775	80, 300	1.109,00 €
53776	131	19,10 €
53778	354	4,50 €
53779	318	36,00 €
53780	132	14,50 €
53781	377	18,00 €
53782	96	14,00 €
53784	150	148,00 €
53785	376	4,80 €
53786	380	98,00 €
53791	378	4,80 €
53794	376	28,00 €
53796	380	76,00 €
53797	377	0,10 €
53802	380	120,00 €
53806	380	250,00 €
53808	379	16,50 €
53809	379	8,00 €
53811	379	8,90 €
53826	378	16,00 €
53827	378	32,00 €
53832	378	1,81 €
53838	380	38,00 €
53839	379	0,25 €
53845	318	64,00 €
53849	312	16,10 €
53850	123	14,90 €
53851	125	88,00 €
53852	125	207,00 €
53853	125	14,40 €
53854	125	27,00 €
53855	125	24,80 €
53856	125	62,00 €
53857	126	27,00 €
53858	126	28,80 €
53859	124	67,00 €
53860	124	3,65 €
53861	124	5,45 €
53862	377	6,00 €
53863	377	3,00 €
53864	369	138,00 €
53867	82	1.095,00 €
53868	74	1.090,00 €
53869	75	990,00 €
53870	75	990,00 €
53872	348	118,00 €
53873	307	285,00 €
53874	307	398,00 €
53875	216	134,00 €
53876	259	64,00 €
53877	411	430,50 €
53878	411	574,00 €
53879	411	838,50 €

REF.	PAGINA	PREZZO
53880	320	598,00 €
53881	164, 348	79,00 €
53882	164, 348	79,00 €
53883	50	18,40 €
53884	50	30,20 €
53885	50	35,70 €
53886	50	20,30 €
53887	50	30,30 €
53888	50	37,90 €
53895	317	107,00 €
53896	317	127,00 €
53897	317	140,00 €
53898	317	148,00 €
53902	378	25,00 €
53903	97	59,00 €
53904	77	790,00 €
53905	56	7,30 €
53906	56	8,65 €
53908	56	7,25 €
53909	56	9,70 €
53910	392	19,00 €
53911	57	8,80 €
53912	75	1.280,00 €
53913	75	1.280,00 €
53914	379, 412	75,00 €
53915	22	65,00 €
53917	54	9,00 €
53919	363	81,00 €
53921	190	39,00 €
53922	190	29,00 €
53927	329	66,00 €
53928	26	278,00 €
53929	329	95,00 €
53932	61	8,00 €
53939	74	1.280,00 €
53940	79, 344, 346, 379	13,20 €
53942	79, 344, 346, 379	0,50 €
53943	54, 86	21,50 €
53944	54, 86	19,50 €
53945	54, 86	18,90 €
53946	377	0,83 €
53947	336	145,00 €
53948	336	324,00 €
53949	409	4,50 €
53950	409	4,50 €
53951	80, 300	1.794,00 €
53952	80, 300	1.794,00 €
53953	20	29,00 €
53954	45	8,50 €
53955	45	10,00 €
53956	408	353,00 €
53957	377	0,26 €
53958	98	6,50 €
53964	364	9,65 €
53965	364	25,80 €
53967	57	10,20 €

REF.	PAGINA	PREZZO
53968	314	49,00 €
53969	323	96,00 €
53970	343	3.790,00 €
53972	52	550,00 €
53973	408	284,00 €
53974	134	38,00 €
53976	61	9,00 €
53977	332	17,50 €
53978	195	38,90 €
53979	45, 88	34,60 €
53980	45, 88	34,60 €
53981	333	143,00 €
53982	333	219,00 €
53983	188	215,00 €
53984	374	8,00 €
53985	374	8,00 €
53986	374	8,00 €
53987	344, 379	9,50 €
53988	173	101,00 €
53992	392	18,00 €
53993	66	77,00 €
53997	211	48,00 €
53999	127	2,00 €
54000	127	2,50 €
54001	317	285,00 €
54002	127	3,00 €
54003	238	104,00 €
54004	133	16,00 €
54005	46	14,00 €
54006	77	490,00 €
54008	127	3,50 €
54010	127	4,50 €
54011	127	5,00 €
54013	369	35,00 €
54015	57	10,20 €
54016	211	76,00 €
54017	182	12,00 €
54018	49	9,85 €
54019	49	17,90 €
54021	49	13,50 €
54022	49	9,95 €
54023	49	13,50 €
54024	49	17,90 €
54028	49	28,00 €
54029	49	28,00 €
54030	49	18,80 €
54031	49	19,30 €
54032	39, 88	84,00 €
54033	161	49,00 €
54034	9	178,00 €
54035	12	149,00 €
54036	13	99,00 €
54037	14	88,00 €
54038	15	88,00 €
54039	135	154,00 €
54040	330	240,00 €
54041	40	198,00 €

REF.	PAGINA	PREZZO
54042	358	13,00 €
54043	408	48,00 €
54044	143	99,00 €
54045	9	179,00 €
54046	12	150,00 €
54047	13	100,00 €
54048	14	89,00 €
54049	15	89,00 €
54050	306	895,00 €
54051	308	39,00 €
54053	342	248,00 €
54054	342	268,00 €
54055	342	220,00 €
54056	342	260,00 €
54057	342	248,00 €
54058	342	348,00 €
54059	343	428,00 €
54060	55	6,00 €
54061	55	6,00 €
54066	39, 87	83,00 €
54068	200	120,00 €
54069	221	29,50 €
54070	55	18,00 €
54071	55	26,50 €
54072	358	38,50 €
54073	363	70,00 €
54074	363	18,50 €
54076	409	9,00 €
54078	144	68,00 €
54079	41	83,00 €
54080	96	53,50 €
54081	43	28,00 €
54082	11	189,00 €
54083	49	9,75 €
54084	49	13,10 €
54085	49	17,80 €
54086	49	9,25 €
54087	49	17,30 €
54088	135	132,00 €
54089	65	17,50 €
54090	21	56,00 €
54091	35, 345	441,00 €
54092	291	24,00 €
54093	35, 79, 87, 345, 346	441,00 €
54097	41	38,90 €
54098	47	158,50 €
54099	66	13,80 €
54100	302	265,00 €
54101	38	61,00 €
54105	21	33,00 €
54106	17, 46	89,00 €
54108	18	66,00 €
54109	20	34,00 €
54110	40	46,00 €
54111	333	4,75 €
54112	62	18,00 €
54113	333	7,65 €

REF.	PAGINA	PREZZO
54114	79, 330, 346	248,00 €
54115	43	26,80 €
54116	18	66,00 €
54117	38	74,00 €
54119	44	78,00 €
54120	41	59,00 €
54122	131	38,00 €
54123	131	40,00 €
54124	131	47,00 €
54125	337	152,00 €
54126	54	39,00 €
54129	79, 346	110,00 €
54130	79, 345, 346	58,00 €
54131	345	58,00 €
54132	79, 346	190,00 €
54133	135	547,00 €
54134	78, 84	1.415,00 €
54135	197	82,00 €
54136	372	107,00 €
54137	315	288,00 €
54139	218	147,00 €
54140	17	36,00 €
54141	22	42,00 €
54142	62	15,20 €
54143	318	249,00 €
54144	318	298,00 €
54145	318	377,00 €
54146	318	492,00 €
54147	318	198,00 €
54149	42	60,00 €
54150	42	23,50 €
54151	374	9,00 €
54152	374	9,00 €
54153	374	9,00 €
54154	29	37,50 €
54155	374	8,00 €
54156	374	8,00 €
54157	374	8,00 €
54158	86	38,00 €
54159	43	47,00 €
54160L	143	17,50 €
54160R	143	17,50 €
54161	142	90,00 €
54162	142	81,00 €
54163	142	80,00 €
54164	29	34,00 €
54166	363	32,40 €
54168	20	49,00 €
54169	363	13,80 €
54170	363	16,50 €
54172	137	81,00 €
54173	137	87,00 €
54174	41	139,00 €
54175	326	34,00 €
54176	350	188,00 €
54177	374	16,00 €

REF.	PAGINA	PREZZO
54178	374	16,00 €
54179	374	16,00 €
54181	310	25,10 €
54182	310	34,70 €
54183	310	38,20 €
54184	310	44,00 €
54186	206	250,00 €
54187	46	39,30 €
54188	376	19,00 €
54189	376	19,00 €
54190	376	19,00 €
54191	376	19,00 €
54192	375	8,90 €
54193	375	8,90 €
54194	375	8,90 €
54195	375	8,90 €
54198	372	59,00 €
54199	292	94,00 €
54200	296	56,00 €
54201	264	37,60 €
54202	246	68,00 €
54203	247	91,00 €
54204	265	124,00 €
54205	281	49,00 €
54206	252	113,00 €
54207	270	38,90 €
54208	265	76,00 €
54209	265	29,70 €
54210	276	84,00 €
54211	247	74,00 €
54212	247	39,40 €
54213	260	19,80 €
54214	281	96,00 €
54215	248	57,00 €
54216	248	49,00 €
54217	281	104,00 €
54218	292	142,00 €
54219	253	60,00 €
54220	208	197,00 €
54221	282	111,00 €
54222	253	59,00 €
54223	266	149,00 €
54224	266	64,50 €
54225	276	133,00 €
54226	295	71,00 €
54227	253	122,00 €
54228	254	187,00 €
54229	337	48,00 €
54230	337	68,00 €
54231	337	138,00 €
54232	337	248,00 €
54233	79, 346	1.856,00 €
54234	79, 346	1.856,00 €
54235	79, 346	1.856,00 €
54236	79, 346	1.856,00 €
54237	78	1.887,00 €
54238	78	1.887,00 €

REF.	PAGINA	PREZZO
54239	78	1.887,00 €
54240	78	1.887,00 €
54241	79, 346	120,00 €
54246	182	104,00 €
54247	182	99,00 €
54248	158	58,00 €
54249	158	103,00 €
54250	10	188,00 €
54251	157	43,00 €
54252	340	199,00 €
54253	227	166,00 €
54254	62	43,00 €
54255	156, 312	68,00 €
54256	330	48,00 €
54257	319	318,00 €
54258	19	58,00 €
54260	266	277,00 €
54261	24	321,00 €
54262	323	88,00 €
54263	323	130,00 €
54264	323	240,00 €
54265	343	1.290,00 €
54266	29	39,50 €
54267	133	9,50 €
54269	51	56,00 €
54270	136	42,00 €
54271	136	54,00 €
54273	214	10,10 €
54274	214	11,00 €
54275	214	13,20 €
54277	19	53,50 €
54278	409	4,50 €
54279	58	6,00 €
54280	237	156,50 €
54288	259	72,50 €
54289	277	38,00 €
54290	306	4.307,00 €
54291	220	5.054,00 €
54293	254	17,50 €
54294	374	8,00 €
54295	81	500,00 €
54296	81	520,00 €
54297	81	540,00 €
54298	354	7,50 €
54299	227	227,00 €
54302	53	11,50 €
54304	50	26,00 €
54305	351	232,50 €
54306	352	219,50 €
54308	352	89,00 €
54309	352	71,00 €
54310	352	57,00 €
54311	58	13,00 €
54312	210	191,50 €
54313	126	43,00 €
54314	126	82,00 €
54316	172	182,00 €

REF.	PAGINA	PREZZO
54317	226	124,00 €
54318	271	105,00 €
54321	343	898,00 €
54322	344, 379	19,00 €
54323	259	119,00 €
54324	257	11,00 €
54325	409	22,50 €
54326	79, 344, 346, 379	7,30 €
54327	72	2.788,00 €
54328	94	199,00 €
54329	371	37,50 €
54330	58	12,50 €
54331	65	27,00 €
54336	150	259,00 €
54338	39	60,00 €
54339	51	273,00 €
54340	147	296,00 €
54341	335	643,00 €
54342	335	858,00 €
54343	53	31,00 €
54344	132	10,50 €
54345	206	15,00 €
54346	127	11,50 €
54347	214	46,00 €
54348	126	291,00 €
54349	325	8,00 €
54350	325	12,50 €
54351	325	14,00 €
54352	325	18,00 €
54353	325	23,50 €
54354	325	34,50 €
54355	325	12,00 €
54356	326	19,50 €
54357	325	15,00 €
54358	325	18,50 €
54359	326	14,00 €
54360	325	14,00 €
54361	325	14,00 €
54362	326	14,00 €
54363	325	14,00 €
54364	326	14,00 €
54365	325	12,50 €
54366	326	18,50 €
54367	306	729,00 €
54368	219	2.329,00 €
54369	374	16,00 €
54370	374	16,00 €
54371	374	16,00 €
54372	198	157,00 €
54373	210	395,00 €
54374	96	75,50 €
54376	58	12,00 €
54379	131	28,00 €
54380	233	119,00 €
54381	233	5,00 €
54382	233	5,00 €
54383	233	5,00 €

REF.	PAGINA	PREZZO
54384	222	32,50 €
54386	324, 346	5.839,00 €
54388	93	366,00 €
54389	76	790,00 €
54390	389	199,00 €
54391	207	221,00 €
54392	207	1.855,00 €
54393	95	92,00 €
54394	95	64,00 €
54395	95	53,00 €
54396	320	2.250,00 €
54397	147	249,00 €
54398	254	41,00 €
54399	255	56,50 €
54400	255	141,00 €
54401	255	57,00 €
54402	256	201,00 €
54403	256	225,00 €
54404	256	131,00 €
54405	257	111,00 €
54406	257	73,00 €
54407	292	59,50 €
54408	293	46,00 €
54409	293	32,00 €
54410	293	33,50 €
54411	294	36,00 €
54412	294	57,00 €
54413	294	115,00 €
54414	272	97,50 €
54415	272	60,00 €
54416	272	31,00 €
54417	273	153,00 €
54418	273	37,00 €
54419	262	57,00 €
54420	263	102,00 €
54421	263	52,00 €

REF.	PAGINA	PREZZO
54422	267	140,00 €
54423	268	108,00 €
54424	263	64,50 €
54425	268	124,00 €
54426	268	69,00 €
54427	269	113,00 €
54428	269	31,00 €
54429	269	55,00 €
54430	248	34,00 €
54431	295	184,00 €
54432	260	43,00 €
54433	260	18,00 €
54434	282	48,50 €
54435	282	14,50 €
54436	283	124,00 €
54437	283	110,00 €
54438	277	40,00 €
54439	277	32,50 €
54479	59	36,50 €
54480	409	1,00 €
54482	334	677,00 €
54483	325	14,00 €
54484	325	26,00 €
54485	325	36,00 €
54486	325	9,50 €
54487	326	15,00 €
54488	325	15,00 €
54489	326	19,50 €
54490	326	15,00 €
54491	326	17,50 €
54492	326	19,50 €
54493	325	13,50 €
54494	325	14,00 €
54495	326	18,00 €
54496	326	16,50 €
54497	326	12,50 €

REF.	PAGINA	PREZZO
54498	309	6.090,00 €
54501	80, 300	1.794,00 €
54502	80, 300	1.794,00 €
54503	76	490,00 €
54534	355	24,00 €
60001	116	88,00 €
60003	116	110,00 €
60004	117	79,00 €
60005	105	132,00 €
60006	106	182,00 €
60007	111	170,00 €
60009	108	168,00 €
60010	111	170,00 €
60011	112	175,00 €
60012	122	48,00 €
60013	122	80,00 €
60015	122	138,00 €
60016	122	49,00 €
60017	122	64,00 €
60019	110	178,00 €
60020	110	175,00 €
60022	112	470,00 €
60023	106	212,00 €
60024	105	190,00 €
60025	105, 122	31,60 €
60026	105, 122	3790 €
60027	118	99,00 €
60028	109	142,00 €
60029	119	240,00 €
60030	119	112,00 €
60031	120	142,00 €
60032	113	123,00 €
60033	108	104,00 €
60035	117	30,00 €
60037	114	222,00 €
60038	113, 312	255,00 €

REF.	PAGINA	PREZZO
60039	118	265,00 €
60040	120	440,00 €
60041	114	77,00 €
60042	115	106,00 €
60043	115	123,00 €
60044	103	330,00 €
60044C	103	485,00 €
60045	121	298,00 €
60046	102	174,00 €
60046C	102	339,00 €
60047C	107	318,00 €
60048	104	366,00 €
60048C	104	560,00 €
60049C	109	329,00 €
70001	406	35,00 €
70002	406	35,00 €
70003	406	35,00 €
70004	406	42,00 €
70005	406	42,00 €
70006	406	42,00 €
70009	406	35,00 €
70011	406	42,00 €
70012	406	42,00 €
70013	406	44,00 €
70014	406	44,00 €
70015	406	44,00 €
70016	406	44,00 €
70017	406	44,00 €
90003	160	35,20 €
90004	160	25,80 €
JBMW-BEXP	362	24,50 €
METEXP	361, 406, 410	62,00 €
SERIE124	360	710,00 €
SERIE262	154, 184	199,00 €





www.jbmcamp.com



JBMprofessionaltools



@jbmtools



jbmtools



JBM Campllong S.L.U.



CAT2024IT

8 435034 988864