



DEIN WERKZEUG

PREISE GÜLTIG AB
01/04/2024



2024



WERKZEUGSÄTZE

7

WERKZEUGKOFFER
 STECKSCHLÜSSEL-KOFFER
 WERKZEUGKOFFER / -KÄSTEN
 BIT-KÄSTEN
 MINI-KNARRENKOFFER
 ADAPTER-KITS
 STECKSCHLÜSSEL-SATZ
 BIT-SET
 ISOLIERTE WERKZEUGE



HANDWERKZEUGE

37

SCHLÜSSEL
 SCHRAUBZWINGEN
 RÄTSCHE
 DREHMOMENTSCHLÜSSEL
 VERLÄNGERUNGSSTANGEN
 SCHRAUBENDREHER
 ZANGEN
 INSPEKTIONSWERKZEUGE
 HÄMMER
 SCHNEIDWERKZEUGE
 MEISEL
 NIETEN MASCHINEN
 MESSGERÄTE
 VERSCHIEDENES



WERKSTATT AUSRÜSTUNG

71

WERKZEUG-WAGEN
 WERKZEUG-MODULE
 ZUBEHÖR/ERSATZELEMENTE
 ARBEITSTISCHE
 LAGER
 HOCKER/ROLLWAGEN
 AMBOSSE/SCHRAUBSTÖCKE



AKKU-WERKZEUGE

101

SCHRAUBENDREHEN
 BOHREN
 SCHLEIFEN/POLIEREN
 SÄGEN
 SPEZIALWERKZEUGE
 GARTENGERÄTE
 BATTERIEN / LADEGERÄTE
 ZUBEHÖR / VERBRAUCHSMATERIAL



BELEUCHTUNG

129

TRAGBARE WERKSTÄTTLAMPEN
 STIRNLAMPEN
 TACHENLAMPEN
 LEUCHTEN
 HAUBENBELEUCHTUNG
 RUNDLEUCHTEN
 ARBEITSSCHEINWERFER
 SIGNALISIERUNG
 ZUBEHÖR UND ERSATZTEILE



DRUCKLUFTWERKZEUGE

145

SCHRAUBENDREHEN
BOHREN
SCHNEIDEN/SCHNEIDEN
SCHLEIFEN/POLIEREN
LUFTPISTOLEN
REIFENWARTUNG
SONSTIGES
ROLLEN/SCHLÄUCHE
ANSCHLÜSSE
ZUBEHÖR UND VERBRAUCHSMATERIAL



SCHLAGWERKZEUGE, STECKSCHLÜSSEL UND BITS

167

SCHLAGEINSÄTZE
SCHLEIFSCHUHE
ADAPTER
ERSATZTEILE FÜR SCHLAGEINSÄTZE
LASTWAGENSPEZIAL



KAROSSERIEWERKSTATT

179

FÜR KAROSSERIE
RESTAURIERUNG VON SCHEINWERFERN
GLASERSATZ
CHASSIS-REPARATUR
HILFSMÖBEL
INSTANDHALTUNG DES INNENRAUMS



BREMSEN

193

AUSTAUSCHER
ENTLÜFTER
WARTUNG



SPEZIALWERKZEUG

199

SCHMIERSYSTEM
EINSPRITZSYSTEM
BLOCK/KULAT
KUPPLUNG
KÜHLSYSTEM
KLIMASYSTEM
GETRIEBE
FEDERUNG
ABGASLEITUNG
ELEKTRISCHE ANLAGE
SCHRAUBENREPARATUR
MOTORRAD
ABZIEHUNGEN



TIMING TOOLS-KITS

243

FIAT/ALFA ROMEO
BMW/MINI
PSA
FORD
JAGUAR/LAND ROVER
JEEP/CHRYSLER

MERCEDES-BENZ
RENAULT/DACIA/NISSAN
OPEL/VAUXHALL
VAG
SONSTIGES
HILFSWERKZEUGE



SCHMIERZUBEHÖR

301

DIESELKRAFTSTOFF-FÖRDERPUMPEN
HARNSTOFF-VERSORGUNGSPUMPEN
ABSAUG-/ABFÜLLPUMPEN
ÖLSAMMLER
SAUGPISTOLEN
ÖLAUFFANGBEHÄLTER
SONSTIGES



HYDRAULISCHE WERKZEUGE

313

RANGIERWAGENHEBER
STEMPELHEBER
ATV-HEBER
GETRIEBEHEBER
UNTERSTELLBÖCKE
SONSTIGES
HUBWAGEN
PRESSEN
KRANE
HUBTISCHEN
GUMMI-STOPFEN FÜR HEBEBÜHNEN



ELEKTROWERKZEUGE

327

BOOSTER
BATTERIEWARTUNG
STROMMESSUNG
SICHTPRÜFUNG
SCHWEISSEN
WERKSTATT-AUSRÜSTUNG
KLIMATISIERUNG
THERMOMETER
SONSTIGES



ERNEUERBARE ENERGIEN UND MOBILITÄT DER ZUKUNFT

341

LADEKABEL FÜR ELEKTROAUTOS
LADEGERÄTE FÜR ELEKTROAUTOS
STROMERZEUGER
ISOLIERTE WERKZEUGE



WERKSTATT-ZUBEHÖR

347

AUFROLLER
LEITERN
WAGEN UND PLATTFORMEN



ZUBEHÖR FÜR FAHRZEUGE

353

SIGNALISIERUNG
NOTAUSRÜSTUNGEN
GLÜHBIRNEN
FLÜSSIGKEITEN
SICHERHEIT
MANSCHETTEN SÄTZE/KLAMMERN
AUTOMATTEN
WISCHERBLÄTTER
FAHRRAD
SONSTIGES
PARKSENSOREN
FLEXIBELE BUIZEN



REIFENZUBEHÖR

367

AUSWUCHTGEWICHTE
PANNENHILFE
REIFENVENTILE
AUSBAU UND MONTAGE



SICHERHEIT UND PSA

373

HANDSCHUHE / PSA
ATEMSCHUTZMASKEN / SPENDER
DELIMITIERUNG
OZON-MESSGERÄT



VERBRAUCHSMATERIALIEN

381

STIFTE UND SPRENGRINGE
NIETEN
SCHRAUBEN MUTTERN UNTERLEGSCHLEIBEN
UNTERLEGSCHLEIBEN FÜR KURBELGEHÄUSE UND MOTOR
SONSTIGE
DICHTUNGEN UND O-RINGE
SCHLAUCHANSCHLÜSSE
ELEKTRISCH
KUNSTSTOFFKLAMMERN UND HEFTKLAMMERN



ARBEITSKLEIDUNG

405

WESTE
JACKEN



WERBEMITTEL

407

WERBEARTIKEL
DISPLAYS / ZUBEHÖR
VERPACKUNGEN

JBM DEIN WERKZEUG

JBM IST IHRE MARKE FÜR PROFESSIONELLE WERKZEUGE

Führendes Unternehmen, spezialisiert auf Industrie und Automobilindustrie

+7.000

PRODUKTE
VERFÜGBAR

+23.000

EUROPALETTEN
AUF LAGER

+68

WIR EXPORTIEREN IN
MEHR ALS 68 LÄNDER

+550

NEUE PRODUKTE
PRO JAHR

MEHR ALS 30 JAHRE ERFAHRUNG IM SEKTOR

JBM hat sich auf den Vertrieb von Werkzeugen und Ausrüstungen für die Automobilindustrie spezialisiert und bietet seinen über 11.000 Kunden in mehr als 68 Ländern einen engen und qualitativ hochwertigen Service.

EXPERTEN FÜR VERTRIEB UND LOGISTIK

JBM verfügt über ein ständig verbessertes Logistiknetz, das eine schnelle und effiziente Verteilung nicht nur auf der Iberischen Halbinsel, sondern auch an alle internationalen Kunden ermöglicht.

EINE BREITE PALETTE VON PRODUKTEN

Wir bieten ein komplettes Sortiment von mehr als 7.000 Artikel an Werkzeugkästen, Werkzeugkoffer, Handwerkzeuge aller Art, Werkzeugschränke, Werkstattwerkzeugen, Beleuchtung, Verbrauchsmaterialien...



**QUALITÄTSDIENSTLEISTUNGEN,
FÜR DIE MEHR ALS 11.000
KUNDEN GARANTIEREN**

**INTERNATIONALE LIEFERUNGEN
WIR EXPORTIEREN IN MEHR ALS
68 LÄNDER**

**HAUPTSITZ IN SPANIEN
UND LAGER MIT MEHR
ALS 6.000M²**

WERKZEUGSÄTZE

- 9 WERKZEUGKOFFER
- 17 STECKSCHLÜSSEL-KOFFER
- 24 WERKZEUGKOFFER / -KÄSTEN
- 28 BIT-KÄSTEN
- 32 MINI-KNARRENKOFFER
- 32 ADAPTER-KITS
- 33 STECKSCHLÜSSEL-SATZ
- 34 BIT-SET
- 35 ISOLIERTE WERKZEUGE



HOCHWERTIGE WERKZEUGE FÜR DEN TÄGLICHEN GEBRAUCH

01

ENTWICKELT FÜR EINE OPTIMALE
LEISTUNG BEI ALLEN ARTEN VON
ARBEITEN

02

WIDERSTANDSFÄHIGES MATERIAL MIT
VERCHROMTER STAHL OBERFLÄCHE
VON OPTIMALER QUALITÄT

03

ERGONOMISCHER GRIFF MIT
GROSSEM DURCHMESSER FÜR EINE
BESSERE TORSIONS FÄHIGKEIT



54034

178,00€

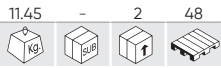

216-TEILIGER WERKZEUGSATZ MIT VERZINKTEN INNENSECHSKANT-EINSÄTZEN



Verzinkt

54045

179,00€

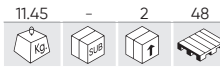

SATZ VON SECHSKANTIGEN NÜSSEN, 216-TEILIG - VERCHROMT



Verchromt



ENTHALTEN

	1/2" x14	13, 14, 15, 16, 17, 18, 19, 20, 21, 22, 24, 27, 30, 32mm
	3/8" x10	10, 11, 12, 13, 14, 15, 16, 17, 18, 19mm
	1/4" x13	4, 4.5, 5, 5.5, 6, 7, 8, 9, 10, 11, 12, 13, 14mm
	1/2" x5	16, 17, 18, 19, 22mm
	3/8" x6	10, 11, 12, 13, 14, 15mm
	1/4" x7	4, 5, 6, 7, 8, 9, 10mm
	1/2" x3	E20, E22, E24
	3/8" x6	E10, E11, E12, E14, E16, E18
	1/4" x5	E4, E5, E6, E7, E8
	1/2" x3	1/2" - 3/8" - 1/4"
	1/2" x2	125, 250mm
	3/8" x1	125mm
	1/4" x2	50, 100mm
	x3	1/2" - 3/8" - 1/4"
	1/2" x1	Übergangsstück 3/8"(H) x 1/2"M
	1/2" x1	8mm
	3/8" x1	8mm
	1/4" x1	6mm

	1/2" x2	16, 21mm
	3/8" x1	18mm
	1/2" x12	8, 9, 10, 11, 12, 13, 14, 15, 16, 17, 18, 19mm
	1/2" x7	1.27, 1.5, 2, 2.5, 3, 4, 5mm
	1/4" x1	
	1/4" x1	
	1/4" x1	
	1/2" x1	T70
	1/2" x1	14mm
	x3	PH0, PH1, PH2
	x3	P20, P21, P22
	x4	3, 4, 5, 6mm
	x4	SL4, SL5.5, SL6.5, SL7
	x8	T8, T9, T10, T15, T20, T25, T27, T30
	x8	T8, T9, T10, T15, T20, T25, T27, T30

	8mm x4	7, 8, 10, 12mm
	6mm x6	2, 2.5, 3, 4, 5, 6mm
	8mm x3	SL8, SL10, SL12
	8mm x3	PH2, PH3, PH4
	8mm x3	P22, P23, P24
	8mm x5	T40, T45, T50, T55, T60
	6mm x3	T5, T6, T7
	8mm x5	T40, T45, T50, T55, T60
	6mm x1	T7
	8mm x4	M10, M11, M12, M13
	6mm x5	M5, M6, M7, M8, M9
	8mm x2	M10, M12
	6mm x3	M5, M6, M8
	8mm x1	TS50
	6mm x8	TS10, TS15, TS20, TS25, TS27, TS30, TS40, TS45
	x4	0, 1, 2, 3mm
	x3	6, 8, 10mm
	6mm x4	4, 6, 8, 10mm
	x3	1, 2, 3mm
	x4	1, 2, 3, 4mm
	6mm x1	1/4"

54250

188,00€

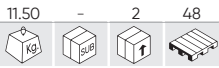

STECKSCHLÜSSEL-SET, 12-KANT NÜSSE 216 -TEILE



Verzinkt



ENTHALTEN

	1/2" x14	13, 14, 15, 16, 17, 18, 19, 20, 21, 22, 24, 27, 30, 32mm
	3/8" x10	10, 11, 12, 13, 14, 15, 16, 17, 18, 19mm
	1/4" x13	4, 4.5, 5, 5.5, 6, 7, 8, 9, 10, 11, 12, 13, 14mm
	1/2" x5	16, 17, 18, 19, 22mm
	3/8" x6	10, 11, 12, 13, 14, 15mm
	1/4" x7	4, 5, 6, 7, 8, 9, 10mm
	1/2" x3	E20, E22, E24
	3/8" x6	E10, E11, E12, E14, E16, E18
	1/4" x5	E4, E5, E6, E7, E8
	12	x3 1/2" - 3/8" - 1/4"
	1/2"	x2 125, 250mm
	3/8"	x1 125mm
	1/4"	x2 50, 100mm
		x3 1/2" - 3/8" - 1/4"
	1/2"	x1 Übergangsstück 3/8"(H) x 1/2"M

	1/2"	x1 8mm
	3/8"	x1 8mm
	1/4"	x1 6mm
	1/2"	x2 16, 21mm
	3/8"	x1 18mm
	1/2"	x12 8, 9, 10, 11, 12, 13, 14, 15, 16, 17, 18, 19mm
	1/2"	x7 1.27, 1.5, 2, 2.5, 3, 4, 5mm
	1/4"	x1
	1/4"	x1
	1/4"	x1
	1/2"	x1 T70
	1/2"	x1 14mm
		x3 PH0, PH1, PH2
		x3 PZ0, PZ1, PZ2
		x4 3, 4, 5, 6mm
	1/4"	x4 SL4, SL5.5, SL6.5, SL7
		x8 T8, T9, T10, T15, T20, T25, T27, T30
		x8 T8, T9, T10, T15, T20, T25, T27, T30

	8mm	x4 7, 8, 10, 12mm
	6mm	x6 2, 2.5, 3, 4, 5, 6mm
	8mm	x3 SL8, SL10, SL12
	8mm	x3 PH2, PH3, PH4
	8mm	x3 PZ2, PZ3, PZ4
	8mm	x5 T40, T45, T50, T55, T60
	6mm	x3 T5, T6, T7
	8mm	x5 T40, T45, T50, T55, T60
	6mm	x1 T7
	8mm	x4 M10, M11, M12, M13
	6mm	x5 M5, M6, M7, M8, M9
	8mm	x2 M10, M12
	6mm	x3 M5, M6, M8
	8mm	x1 TS50
	6mm	x8 TS10, TS15, TS20, TS25, TS27, TS30, TS40, TS45
		x4 0, 1, 2, 3mm
		x3 6, 8, 10mm
	6mm	x4 4, 6, 8, 10mm
		x3 1, 2, 3mm
		x4 1, 2, 3, 4mm
	6mm	x1 1/4"

54082

189,00€

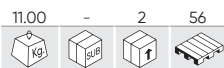

132-TEILIGER WERKZEUGKOFFER MIT VERZINKTEN INNENSECHSKANT-EINSÄTZEN

132 PCS CrV

Verzinkt



SPEZIAL KFZ



ENTHALTEN

	1/2" x7 19, 21, 22, 24, 27, 30, 32mm
	3/8" x12 8, 9, 10, 11, 12, 13, 14, 15, 16, 17, 18, 19mm
	1/4" x11 4, 5, 5.5, 6, 7, 8, 9, 10, 11, 12, 13mm
	3/8" x4 13, 14, 15, 17mm
	1/4" x4 8, 10, 12, 13mm
	3/8" x6 E8, E10, E11, E14, E16, E20
	1/2" x1
	3/8" x1
	1/4" x1
	1/2" x2 127, 254mm
	3/8" x2 76, 152mm
	1/4" x1 50mm
	x1 Ø14mm
	x1

	x1 3/8"(H) - 1/2"(M)
	x1 3/8"(H) - 1/2"(M)
	x1 3/8"(H) - 1/2"(M)
	1/2" x1
	3/8" x1
	1/4" x1
	1/2" x3 17, 19, 21mm
	1/4" x1 6mm
	x1
	x1 PH2x100
	x1 SL6x100
	x12 8, 9, 10, 11, 12, 13, 14, 15, 16, 17, 18, 19mm
	x1
	1/2" x1 H17
	x1

	1/2" x1 21mm
	3/8" x2 16, 18mm
	1/2" x1 T52
	1/2" x1 M16
	x2 5.5, 6.5mm
	x2 PH1, PH3
	3/8" x2 PZ1, PZ3
	x4 4, 5, 6, 8mm
	x6 T20, T30, T40, T45, T50, T55
	x3 4, 5, 6.5mm
	x3 PH1, PH2, PH3
	6mm x3 PZ1, PZ2, PZ3
	x4 3, 4, 5, 6
	x7 T10, T15, T20, T25, T27, T30, T40
	x9 1.5, 2, 2.5, 3, 4, 5, 6, 8, 10mm

54035

149,00€

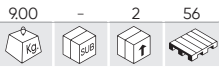

179-TEILIGER WERKZEUGSATZ MIT VERZINKTEN INNENSECHSKANT-EINSÄTZEN



Verzinkt

54046

150,00€

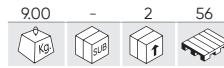

SATZ VON SECHSKANTIGEN NÜSSEN, 179-TEILIG - VERCHROMT



Verchromt



ENTHALTEN

	1/2" x17	10, 11, 12, 13, 14, 15, 16, 17, 18, 19, 20, 21, 22, 24, 27, 30, 32mm
	3/8" x10	10, 11, 12, 13, 14, 15, 16, 17, 18, 19mm
	1/4" x13	4, 4.5, 5, 5.5, 6, 7, 8, 9, 10, 11, 12, 13, 14mm
	1/2" x5	16, 17, 18, 19, 22mm
	3/8" x6	10, 11, 12, 13, 14, 15mm
	1/4" x7	4, 5, 6, 7, 8, 9, 10mm
	1/2" x2	E20, E24
	3/8" x6	E10, E11, E12, E14, E16, E18
	1/4" x5	E4, E5, E6, E7, E8
	1/2" x3	1/2" - 3/8" - 1/4"
	1/2" x2	125, 250mm
	3/8" x1	125mm
	1/4" x2	50, 100mm

	x3	1/2" - 3/8" - 1/4"
	1/2" x2	16, 21mm
	3/8" x1	18mm
	1/2" x1	8mm
	3/8" x1	8mm
	1/4" x1	6mm
	x7	1.27, 1.5, 2, 2.5, 3, 4, 5mm
	x1	1/4"
	x1	1/4"
	x3	PH1, PH2, PH3
	x3	PZ1, PZ2, PZ3
	x5	2, 3, 4, 5, 6mm
	x3	SL4, SL5.5, SL7
	x8	T8, T9, T10, T15, T20, T25, T27, T30
	x8	T8, T9, T10, T15, T20, T25, T27, T30

	x11	T5, T6, T7, T8, T9, T10, T15, T20, T25, T27, T30
	x9	T7, T10, T15, T20, T25, T27, T30, T40, T45
	x5	M5, M6, M7, M8, M9
	x3	M5, M6, M8
	x2	PH3, PH4
	x2	PZ3, PZ4
	x5	7, 8, 10, 12, 14mm
	x3	SL8, SL10, SL12
	x6	T40, T45, T50, T55, T60, T70
	x6	T40, T45, T50, T55, T60, T70

54036

99,00€

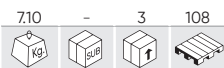

113-TEILIGER WERKZEUGSATZ MIT VERZINKTEN INNENSECHSKANT-EINSÄTZEN



Verzinkt

54047

100,00€



STECKSCHLÜSSEL -SET, 12-KANT NUSS 113 TEILE - VERCHROMT



Verchromt



ENTHALTEN

	1/2"	x17	10, 11, 12, 13, 14, 15, 16, 17, 18, 19, 20, 21, 22, 24, 27, 30, 32mm
	1/4"	x13	4, 4.5, 5, 5.5, 6, 7, 8, 9, 10, 11, 12, 13, 14mm
	1/2"	x5	14, 15, 17, 19, 22mm
	1/4"	x8	6, 7, 8, 9, 10, 11, 12, 13mm
	1/2"	x8	E10, E11, E12, E14, E16, E18, E20, E24
	1/4"	x5	E4, E5, E6, E7, E8
	1/2"	x2	1/2" - 1/4"
	1/2"	x2	125, 250mm
	1/4"	x2	50, 100mm

	x2	1/2" - 1/4"
	1/2"	x1 Übergangsstück 3/8"(H) x 1/2"
	1/2"	x1 8mm
	x5	7, 8, 10, 12, 14mm
	x3	SL8, SL10, SL12
	x2	PH3, PH4
	8mm	x2 PZ3, PZ4
	x5	T40, T45, T50, T55, T60
	x5	5, 6, 8, 10, 12mm

	1/2"	x2	16, 21mm
	x3	1.5, 2, 2.5mm	
	x1	1/4"	
	x1	1/4"	
	x2	PH1, PH2	
	x2	PZ1, PZ2	
	1/4"	x4	3, 4, 5, 6mm
	x3	SL4, SL5.5, SL6.5	
	x7	T8, T10, T15, T20, T25, T27, T30	



54037

88,00€

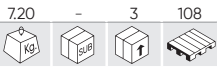

108-TEILIGER WERKZEUGSATZ MIT VERZINKTEN INNENSECHSKANT-EINSÄTZEN



Verzinkt

54048

89,00€

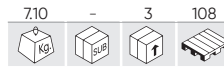

SATZ VON SECHSKANTIGEN NÜSSEN, 108 -TEILIG - VERCHROMT



Verchromt



ERSATZTEILE VERFÜGBAR



ERSATZTEILE VERFÜGBAR

ENTHALTEN

	1/2"	x17	10, 11, 12, 13, 14, 15, 16, 17, 18, 19, 20, 21, 22, 24, 27, 30, 32mm
	1/4"	x13	4, 4.5, 5, 5.5, 6, 7, 8, 9, 10, 11, 12, 13, 14mm
	1/2"	x5	14, 15, 17, 19, 22mm
	1/4"	x8	6, 7, 8, 9, 10, 11, 12, 13mm
	1/2"	x8	E10, E11, E12, E14, E16, E18, E20, E24
	1/4"	x5	E4, E5, E6, E7, E8
	1/2"	x2	1/2" - 1/4"
	1/2"	x2	125, 250mm
	1/4"	x2	50, 100mm
	1/2"	x2	1/2" - 1/4"
	1/2"	x1	Übergangsstück 3/8"(H) x 1/2"M

	1/2"	x2	16, 21mm
	1/2"	x1	8mm
		x3	1.5, 2, 2.5mm
		x1	1/4"
		x1	1/4"
		x2	PH3, PH4
		x2	PZ3, PZ4
	8mm	x5	7, 8, 10, 12, 14mm
		x3	SL8, SL10, SL12
		x5	T40, T45, T50, T55, T60

		x2	PH1, PH2
		x2	PZ1, PZ2
	1/4"	x4	3, 4, 5, 6mm
		x3	SL4, SL5.5, SL6.5
		x7	T8, T10, T15, T20, T25, T27, T30

54038

88,00€

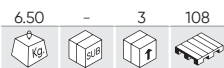

94-TEILIGER WERKZEUGSATZ MIT VERZINKTEN INNENSECHSKANT-EINSÄTZEN



Verzinkt



ERSATZTEILE VERFÜGBAR

54049

89,00€



SATZ VON SECHSKANTIGEN NÜSSEN, 94-TEILIG - VERCHROMT



Verchromt



ERSATZTEILE VERFÜGBAR

ENTHALTEN

	1/2"	x18	10, 11, 12, 13, 14, 15, 16, 17, 18, 19, 20, 21, 22, 23, 24, 27, 30, 32mm
	1/4"	x13	4, 4.5, 5, 5.5, 6, 7, 8, 9, 10, 11, 12, 13, 14mm
	1/2"	x4	14, 15, 17, 19mm
	1/4"	x8	6, 7, 8, 9, 10, 11, 12, 13mm
		x2	1/2" - 1/4"
	1/2"	x2	125, 250mm
	1/4"	x2	50, 100mm
		x2	1/2" - 1/4"
	1/2"	x1	Übergangsstück 3/8"(H) x 1/2"M

	1/2"	x1	8mm
		x3	1.5, 2, 2.5mm
	1/2"	x2	16, 21mm
		x2	PH3, PH4
		x2	PZ3, PZ4
	8mm	x4	8, 10, 12, 14mm
		x3	SL8, SL10, SL12
		x4	T40, T45, T50, T55
	8mm	x1	1/4"

		x1	1/4"
		x1	1/4"
		x1	1/4"
		x2	PH1, PH2
		x2	PZ1, PZ2
	1/4"	x4	3, 4, 5, 6mm
		x3	SL4, SL5.5, SL7
		x6	T8, T10, T15, T20, T25, T30

53212

174,00€

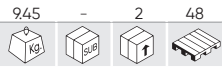

303-TEILIGER WERKZEUGKOFFER MIT VERZINKTEN SECHSKANT-EINSÄTZEN



Verzinkt



ENTHALTEN

	x18	10, 11, 12, 13, 14, 15, 16, 17, 18, 19, 20, 21, 22, 23, 24, 27, 30, 32mm
	x2	125, 250mm
	x2	16, 21mm
	x1	8mm
	x1	Übergangsstück 3/8"(H) x 1/2"M
	x1	UNIVERSAL
	x1	72
	x13	4, 4.5, 5, 5.5, 6, 7, 8, 9, 10, 11, 12, 13, 14mm
	x2	50, 100mm
	x1	6,3mm
	x1	1/4"
	x1	UNIVERSAL
	x1	72
	x8	T25, T27, T30, T35, T40 (x2), T45, T50
	x2	PH3, PH4
	x2	PZ3, PZ4
	x4	H5.5, H6.5, H7, H8
	x4	5.5, 6.5, 7, 8mm
	x4	5, 6, 8, 10mm

	x9	3, 4, 4.5, 5, 5.5, 6, 6.5, 7, 8mm
	x9	T8, T10, T15, T20, T25, T27, T30, T35, T40
	x9	H1.5, H2, H2.5, H3, H.4, H5, H5.5, H6, H8
	x3	5, 6, 8mm
	x4	1, 2, 3, 4
	x3	6, 8, 10
	x3	C1, C2, C3
	x6	2, 2.5, 3, 4, 5, 6mm
	x4	S0, S1, S2, S3
	x6	5/64, 3/32, 7/64, 1/8, 9/64, 5/32
	x4	4, 6, 8, 10mm
	x10	PH0 (x2), PH1 (x2), PH2 (x4), PH3 (x2)
	x10	PZ0 (x2), PZ1 (x2), PZ2 (x4), Z3 (x2)
	x10	1/16, 5/64, 3/32, 7/64, 1/8, 9/64, 5/32, 3/16, 7/32, 1/4
	x10	T8, T10, T15, T20, T25, T27, T30, T35, T40, T45
	x6	1.5, 2, 2.5, 3, 3.5, 4mm
	x4	PH000, PH00, PH0, PH1
	x2	PZ0, PZ1
	x8	T5, T6, T7, T8, T9, T10, T15, T20

	x1		x1	300g
	x1		x1	
	x10		x1	
	x1		x23	
	x1	3m		x22
	x1			x10
	x1	8"		x10
	x2	0.4x2.5, 0.5x3.0x50mm		
	x3	PH0x50, PH00x50, PH000x50mm		
	x2	0.8x4x100, 1.2x6.5x125mm		
	x2	PH1x80, PH2x100mm		
	x7	1.27, 1.5, 2, 2.5, 3, 4, 5mm		
	x13	1.5, 2, 2.5, 3, 3.2, 3.5, 4, 4.5, 4.8, 5, 5.5, 6, 6.5mm		



54106

89,00€

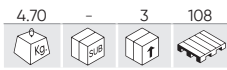

37-TEILIGER VERZINKTER ZOLL-WERKZEUGKOFFER



Verzinkt



ERSATZTEILE VERFÜGBAR

ENTHALTEN

	1/2" x17	5/16", 3/8", 7/16", 1/2", 9/16", 19/32", 5/8", 11/16", 3/4", 13/16", 7/8", 15/16", 1", 1-1/16", 1-1/8", 1-3/16", 1-1/4"		1/2" x2	5" - 10"
	1/4" x8	3/16", 7/32", 1/4", 9/32", 5/16", 11/32", 3/8", 7/16"		1/4" x1	3"
	x2	1/2" - 1/4"		x1	1/2" - 1/4"
	1/2" x2	16, 21mm		x1	1/4"

53074

78,00€

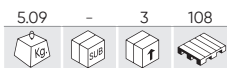

74-TEILIGER WERKZEUGKOFFER MIT 12-KANTIGEN STECKEINSÄTZEN, VERZINKT



Verzinkt



ERSATZTEILE VERFÜGBAR



ENTHALTEN

	1/2" x18	10, 11, 12, 13, 14, 15, 16, 17, 18, 19, 20, 21, 22, 23, 24, 27, 30, 32mm
	1/4" x10	4, 5, 5.5, 6, 7, 8, 10, 11, 12, 13mm
	x2	1/2" - 1/4"
	1/2" x2	125, 250mm
	1/4" x1	100mm
	x1	1/2"
	x5	PH0, PH1, PH2, PH3, PH4
	x5	PZ0, PZ1, PZ2, PZ3, PZ4
	x6	3, 4, 5, 6, 8, 10mm
	x5	SL3, SL4, SL5.5, SL6, SL7
	x8	T8, T10, T15, T20, T25, T27, T30, T40
	x4	4, 5, 6, 7mm
	1/2" x1	Übergangsstück 3/8"(H) x 1/2"M
	1/2" x1	21mm
	x3	1.5, 2, 2.5mm
	x1	1/4"
	1/4" x1	6mm

54140

36,00€

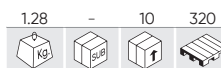

56-TEILIGER WERKZEUGSATZ MIT 12-KANTIGEN STECKSCHLÜSSELN VERZINKT

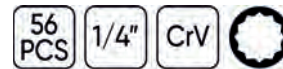

Verzinkt



ERSATZTEILE VERFÜGBAR



ENTHALTEN

	x13	4, 4.5, 5, 5.5, 6, 7, 8, 9, 10, 11, 12, 13, 14mm
	x1	12
	x2	50, 100mm
	x1	1/4"
	x1	
	x1	
	x1	
	x1	
	x4	SL4, SL5, SL6, SL7
	x3	M5, M6, M8
	x8	T8, T10, T15, T20, T25, T27, T30, T40
	x8	T8, T10, T15, T20, T25, T27, T30, T40
	x3	PH0, PH1, PH2
	x3	PZ0, PZ1, PZ2
	x6	3, 4, 5, 6, 7, 8mm



54108

66,00€

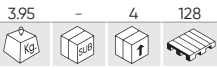

WERKZEUGKOFFER 22 STÜCK 1/2" SECHSKANT-EINSÄTZE VERZINKT

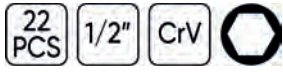

Verzinkt



ENTHALTEN

	1/2"	x17	10, 11, 12, 13, 14, 15, 16, 17, 18, 19, 20, 21, 22, 24, 27, 30, 32mm
	1/2"	x1	
	1/2"	x2	75, 125mm
		x1	3/8" (H) - 1/2" (M)
		x1	1/2"

54116

66,00€

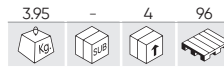

WERKZEUGKOFFER 22 STÜCK 12-KANTIGE STECKNÜSSE 1/2" VERZINKT

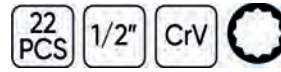

Verzinkt



ENTHALTEN

	1/2"	x17	10, 11, 12, 13, 14, 15, 16, 17, 18, 19, 21, 22, 24, 27, 30, 32mm
	1/2"	x1	1/2"
	1/2"	x2	125, 250mm
	1/2"	x1	
	1/2"	x1	3/8" (H) - 1/2" (M)

51818

109,00€

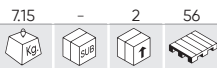

72-TEILIGER WERKZEUGKOFFER MIT VERZINKTEN INNENSECHSKANT-EINSÄTZEN



Verzinkt



ENTHALTEN

	1/2"	x13	10, 11, 12, 13, 14, 15, 17, 19, 22, 24, 27, 30, 32mm
	1/4"	x10	4, 5, 6, 7, 8, 9, 10, 11, 12, 13mm
	1/4"	x5	5, 6, 7, 8, 9mm
	1/2"	x1	1/2"
	1/4"	x1	1/4"
	1/2"	x1	125mm
	1/4"	x1	75mm

	x1	
	x1	300gr
	x1	
	x1	
	x4	SL3, SL4, SL5, SL6
	x3	PH1, PH2, PH3
	x7	T10, T15, T20, T25, T27, T30, T40

	x2	1/2" - 1/4"
	1/2"	x2 16, 21mm
	1/4"	x1 6mm
		x8 10, 11, 12, 13, 14, 15, 17, 19mm
	x3	1.5, 2, 2.5mm
	x1	1/4"
	x2	PH2x100, PH1x40mm
	x3	8x200, 6x100, 6x40mm

54258

58,00€

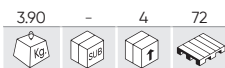

77-TEILIGER VERZINKTER WERKZEUGSATZ



Verzinkt



ENTHALTEN

	x5 PH0, PH1, PH2, PH2, PH3		x1
	x5 PZ0, PZ1, PZ2, PZ2, PZ3		x10
	x5 SL3, SL4, SL5, SL5.5, SL6mm		x1
	x5 T10, T15, T20, T25, T30		x1
	x4 6x7, 8x9, 10x11, 12x13mm		x1
	x9 1.5, 2, 2.5, 3, 4, 5, 6, 8, 10mm		x1
	x3 PH2x100, PH00x50, PH000x50		x1
	x3 SL6x100, SL2.5x50, SL3.0x50		x10
	x1		x10



54277

53,50€

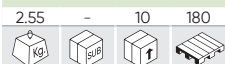

STECKSCHLÜSSEL-SET, 6-KANT NUSS 3/8" ANTRIEB 59 TEILE MIT VERZINKTEN INNENSECHSKANT-EINSÄTZEN

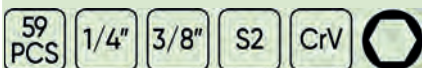

N

Verzinkt



ENTHALTEN

	3/8" x17	6, 7, 8, 9, 10, 11, 12, 13, 14, 15, 16, 17, 18, 19, 20, 21, 22mm		x2	PH3, PH4		x2	PH1, PH2
	x1	3/8"		x2	PZ3, PZ4		x2	PZ1, PZ2
	3/8" x2	75, 150mm		8mm x5	7, 8, 10, 12, 14mm		1/4" x4	3, 4, 5, 6mm
	3/8" x1	8mm		x3	SL8, SL10, SL12		x3	SL4, SL5.5, SL6.5
	3/8" x1	8mm		x5	T40, T45, T50, T55, T60		x7	T8, T10, T15, T20, T25, T27, T30
	x1	3/8"						
	x1	1/4"						

53953

29,00€

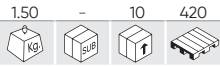

130-TLG. STECKSCHLÜSSEL- UND BITSATZ VERZINKT

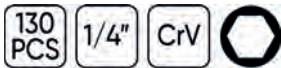

Verzinkt



IM AUSSTELLER MIT 10 STÜCK



ERSATZTEILE VERFÜGBAR

ENTHALTEN

	1/4"	x13	4, 4.5, 5, 5.5, 6, 7, 8, 9, 10, 11, 12, 13, 14mm
	1/4"	x1	1/4"
	1/4"	x1	50mm
	1/4"	x1	1/4"
	1/4"	x1	6mm
	1/4"	x1	1/4"
	1/4"	x1	1/4"
	1/4"	x7	1.27, 1.5, 2, 2.5, 3, 4, 5mm

	25mm	x10	T8, T10, T15, T20, T25, T27, T30, T35, T40, T45
	25mm	x9	T8, T10, T15, T20, T25, T27, T30, T35, T40
	25mm	x3	M5, M6, M8
	25mm	x3	6, 8, 10mm
	25mm	x3	C1, C2, C3
	25mm	x4	1, 2, 3, 4mm
	25mm	x4	4, 6, 8, 10mm
	25mm	x4	0, 1, 2, 3mm

	25mm	x10	1/16, 5/64, 3/32, 7/64, 1/8, 9/64, 5/32, 3/16, 7/32, 1/4
	25mm	x9	1.5, 2, 2.5, 3, 4, 5, 5.5, 6, 8mm
	25mm	x6	5/64, 3/32, 7/64, 1/8, 9/64, 5/32
	25mm	x6	2, 2.5, 3, 4, 5, 6mm
	25mm	x9	3, 4, 4.5, 5, 5.5, 6, 6.5, 7, 8mm
	50mm	x2	4, 6mm
	25mm	x10	PH0(x2), PH1(x2), PH2(x4), PH3(x2)
	50mm	x2	PH1, PH2
	25mm	x10	P20(x2), PZ1(x2), PZ2(x4), PZ3(x2)

54109

34,00€

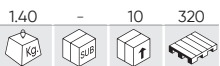

SATZ ZU 46 STÜCK MIT SECHSKANTANSATZ VERZINKT



Verzinkt



ERSATZTEILE VERFÜGBAR



ENTHALTEN

	1/4"	x13	4, 4.5, 5, 5.5, 6, 7, 8, 9, 10, 11, 12, 13, 14mm
	1/4"	x1	
	1/4"	x1	
	1/4"	x1	
	1/4"	x2	50, 100mm
		x4	1.27, 1.5, 2.0, 2.5mm
		x1	
		x1	UNIVERSAL
		x1	1/4"
		x3	SL4, SL5.5, SL7
		x3	PH1, PH2, PH3
		x3	PZ1, PZ2, PZ3
		x6	H3, H4, H5, H6, H7, H8
		x6	T10, T15, T20, T25, T30, T40

54168

49,00€

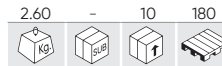

59-TEILIGER 3/8"-WERKZEUGSATZ MIT 12-KANTIGEN STECKSCHLÜSSELN, VERZINKT

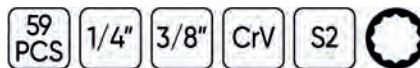

Verzinkt



ERSATZTEILE VERFÜGBAR



ENTHALTEN

		x2	PH3, PH4
		x2	PZ3, PZ4
	8mm	x5	7, 8, 10, 12, 14mm
		x3	8, 10, 12mm
		x5	T40, T45, T50, T55, T60
		x2	PH1, PH2
		x2	PZ1, PZ2
	1/4"	x4	3, 4, 5, 6mm
		x3	4, 5.5, 6.5mm
		x7	T8, T10, T15, T20, T25, T27, T30
	3/8"	x17	6, 7, 8, 9, 10, 11, 12, 13, 14, 15, 16, 17, 18, 19, 20, 21, 22mm
		x1	3/8"
	3/8"	x2	75, 150mm
	3/8"	x1	8mm
	3/8"	x1	8mm
	3/8"	x1	
	1/4"	x1	

54105 33,00€

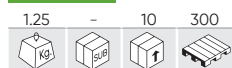

59-TEILIGER 3/8"-WERKZEUGSATZ MIT 12-KANTIGEN STECKSCHLÜSSELN, VERZINKT



Verzinkt



ENTHALTEN

	1/4"	x13	4, 4.5, 5, 5.5, 6, 7, 8, 9, 10, 11, 12, 13, 14mm		x4	SL4, SL5, SL6, SL7
	1/4"	x1			x3	M5, M6, M8
	1/4"	x2	50, 100mm		x8	6mm T8, T10, T15, T20, T25, T27, T30, T40
	1/4"	x1			x8	T8, T10, T15, T20, T25, T27, T30, T40
	1/4"	x1			x8	T8, T10, T15, T20, T25, T27, T30, T40
	1/4"	x1			x1	6mm 1/4"
	1/4"	x1	6mm		x3	PH0, PH1, PH2
	6mm	x3	PZ0, PZ1, PZ2		x6	3, 4, 5, 6, 7, 8mm

52418 179,00€



39-TEILIGER DURCHGEHENDER WERKZEUGKOFFER VERCHROMT



Verchromt

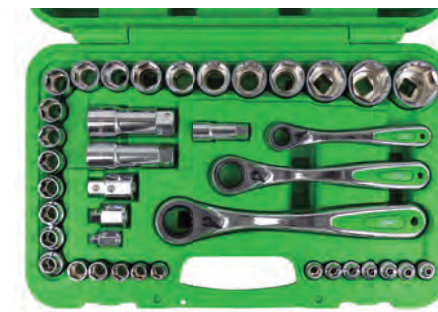

ENTHALTEN

	13mm	x12	4, 4.5, 5, 5.5, 6, 7, 8, 9, 10, 11, 12, 13mm		1/4"	x1	13mm
	19mm	x10	10, 11, 12, 13, 14, 15, 16, 17, 18, 19mm		3/8"	x1	19mm
	22mm	x5	20, 21, 22, 23, 24mm		1/2"	x1	22mm
	22mm	x3	27, 30, 32mm		1/2"	x3	13, 19, 22mm
	1/2"	x3	13, 19, 22mm		1/2"	x3	13, 19, 22mm

54090 56,00€



14-TEILIGER WERKZEUGSATZ FÜR DURCHSTECARBEITEN VERZINKT

Verzinkt



ENTHALTEN

	x11	13, 14, 15, 16, 17, 18, 19, 21, 22, 24, 27mm
	x1 (75mmL)	12,5mm
	x1	1/2"
	x1 (go-through)	

50623 60,00€



17-TEILIGES, DURCHGEHEND VERCHROMTES GEHÄUSE

Verchromt



ENTHALTEN

	x13	4, 4.5, 5, 5.5, 6, 7, 8, 9, 10, 11, 12, 13, 14mm
	x1	75mm
	x1	1/4"
	x1	145mm

52722

87,00€

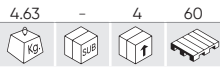

61-TEILIGER WERKZEUGKOFFER 1/2" UND 1/4" STECKSCHLÜSSELEINSÄTZE VERZINKT

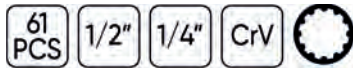

Verzinkt



ERSATZTEILE VERFÜGBAR



53108

92,00€



WERKZEUGKOFFER 61 STÜCK 1/2" UND 1/4" STECKSCHLÜSSELEINSÄTZE VERCHROMT

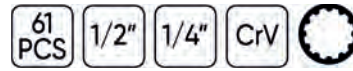

Verchromt



ERSATZTEILE VERFÜGBAR



ENTHALTEN

	1/2" x11	14, 15, 16, 17, 18, 19, 22, 24, 27, 30, 32mm
	1/4" x12	4, 4.5, 5, 5.5, 6, 7, 8, 9, 10, 11, 12, 13mm
	x2	1/2" - 1/4"
	x2	5" - 10"
	x2	2" - 4"
	x2	1/2" - 1/4"

	x1	Übergangsstück 3/8"(H) x 1/2" M
	x2	16, 21mm
	x1	25mm
	x3	1.5, 2, 2.5mm
	x1	1/4"
	x1	1/4"
	x1	AD

	x3	PH1, PH2, PH3
	x3	PZ1, PZ2, PZ3
	x5	3, 4, 5, 6, 8mm
	x3	SL4, SL5.5, SL7
	x5	T10, T15, T20, T25, T30

53915

65,00€

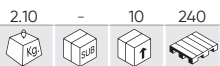

SATZ VON 6 EINSÄTZEN 1/2" TORX TYP E EXTRA LANG VERZINKT

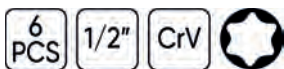

Verzinkt



ENTHALTEN

	x6	E10, E12, E14, E16, E18, E20
--	----	------------------------------

E12 Schraubfuß für Zylinderkopf BMW:
 - Motor M42, 1,8 L, 4 Zylinder, 16 V, Modell 318 (1989)
 - Motor M50, 2,0 L, 2,5 L, 6 Zylinder, 24 V, Modelle 520i, 525i (1991)

54141

42,00€

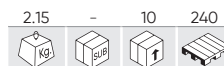

SATZ 28 KURZE UND LANGE TORX-EINSÄTZE VERZINKT

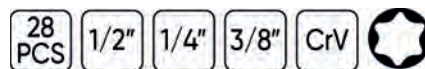

Verzinkt



ENTHALTEN

	x5 (25mm)	E4, E5, E6, E7, E8
	x5 (28mm)	E10, E11, E12, E14, E16
	x4 (38mm)	E18, E20, E22, E24
	x5 (50mm)	E4, E5, E6, E7, E8
	x5 (63mm)	E10, E11, E12, E14, E16
	x4 (76mm)	E18, E20, E22, E24



ERSATZTEILE VERFÜGBAR



51616 378,00€



METALLKOFFER MIT 22 STÜCK 1" VERZINKTEN SECHSKANT-AUTOKLAVEN



Verzinkt



METALLBOX ENTHALTEN

		1"	x17	36, 38, 41, 46, 50, 54, 55, 58, 60, 63, 65, 67, 70, 71, 75, 77, 80mm
		1"	x1	650mm
		1"	x2	205, 410mm
		1"	x1	
		1"	x1	



51855 378,00€



METALLKOFFER MIT 22 STÜCK 1" AUTOKLAVEN AUF 12 VERZINKTEN KANTEN

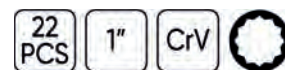

Verzinkt



METALLBOX ENTHALTEN

		1"	x17	36, 38, 41, 46, 50, 54, 55, 58, 60, 63, 65, 67, 70, 71, 75, 77, 80mm
		1"	x1	650mm
		1"	x2	205, 410mm
		1"	x1	
		1"	x1	



53727 198,00€

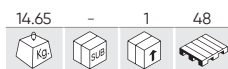

WERKZEUGKOFFER MIT 21 STÜCK 3/4" INNENSECHSKANT VERZINKT

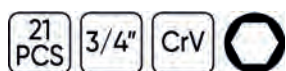

Verzinkt



ENTHALTEN

		3/4"	x16	19, 21, 22, 23, 24, 26, 27, 29, 30, 32, 35, 36, 38, 41, 46, 50mm
		3/4"	x1	495mm
		3/4"	x3	100, 200, 400mm
		3/4"	x1	445mm



53728 198,00€



WERKZEUGKOFFER MIT 21 STÜCK 3/4" 12-KANTEN VERZINKT

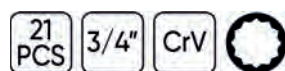

Verzinkt



ENTHALTEN

		3/4"	x16	19, 21, 22, 23, 24, 26, 27, 29, 30, 32, 35, 36, 38, 41, 46, 50mm
		3/4"	x1	495mm
		3/4"	x3	100, 200, 400mm
		3/4"	x1	445mm



54261

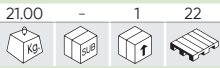

321,00€



N

METALLKASTEN MIT WERKZEUGEN 143 STÜCK VERZINKT



Verzinkt



ENTHALTEN

	x13	4, 4.5, 5, 5.5, 6, 7, 8, 9, 10, 11, 12, 13, 14mm		x20	8, 9, 10, 11, 12, 13, 14, 15, 16, 17, 18, 19, 20, 21, 22, 23, 24, 27, 30, 32mm		x4	SL5x75, SL6x100, SL8x150, SL10x200mmL
	x6	8, 10, 11, 12, 13, 14mm		x2	5" - 10"		x3	PH1x80, PH2x100, PH3x150mmL
	x7	E4, E5, E6, E7, E8, E10, E11		x2	1/2" x2 16, 21mm		x4	PH1, PH2x2, PH3
	x2	2", 4"		x1	UNIVERSAL		x4	PZ1, PZ2x2, PZ3
	x1	110mmL		x1	3/8"(F) - 1/2"(M)		x4	SL3, SL4, SL5, SL6
	1/4" x1			x1			x4	H3, H4, H5, H6
	x1	150L		x2	1/2" x2		x7	T10, T15, T20, T25, T27, T30, T40
	x3	PH1,PH2,PH3		x1	1/4" x1		x7	TT10,TT15,TT20,TT25,TT27,TT30,TT40
	x3	SL4,SL5.5,SL6.5		x12	6,7,8,9,10,11,12,13,14,17,19,22mm		x1	1/4"
	x6	TT10,TT15,TT20,TT25,TT30,TT40		x8	6x7,8x9,10x11,12x13,14x15,16x17,18x19,20x22mm		x1	6.35mmx60mmL
	x6	H3,H4,H5,H6,H7,H8		x1	7"-180mm		x1	1/4"-6.35mm
	x1			x1	8"-200mm		x1	7"-180mm
	x1	250mm		x1			x1	10"-250mm

53565

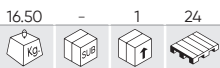

258,00€



EISEN WERKZEUGKASTEN 64 STÜCK VERZINKT



Verzinkt

ENTHALTEN

	1/2" x18	10, 11, 12, 13, 14, 15, 16, 17, 18, 19, 20, 21, 22, 23, 24, 27, 30, 32mm		x1	1/2"
	x1	1/2"		x1	1/2"
	x3	76, 127, 254mm		x1	255mm
	x1	21mm		x1	457mm
	x18	6, 7, 8, 9, 10, 11, 12, 13, 14, 15, 16, 17, 18, 19, 20, 21, 22, 24mm		x9	1.5, 2, 2.5, 3, 4, 5, 6, 8, 10mm
	x3	PH1x100, PH2x150, H3x200mm		x3	SL5x100, SL6x150, SL8x200mm
	x1	250mm		x1	180mm
	x1	200mm		x1	180mm



53159

289,00€

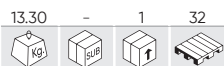

ALUMINIUM WERKZEUGKOFFER 159 STÜCK VERZINKT



Verzinkt



ENTHALTEN



	1/2" x14	14, 15, 16, 17, 18, 19, 20, 21, 22, 23, 24, 27, 30, 32mm
	1/4" x10	4, 5, 6, 7, 8, 9, 10, 11, 12, 13mm
	x2	1/4" - 1/2"
	1/2" x2	50, 100mm
	1/4" x2	125, 250mm
	1/4" x1	150mm
	x2	1/4" - 1/2"
	1/2" x1	Übergangsstück 3/8"(H) x 1/2"M
	x2	1/4" - 1/2"
	1/4" x1	250mm
	1/4" x1	110mm
	1/2" x2	16, 21mm
	x1	1/4"

	x9	8, 10, 11, 12, 13, 15, 17, 19, 22mm
	x9	1.5, 2, 2.5, 3, 4, 5, 6, 8, 10mm
	x1	100-250V
	x1	
	x2	PH1x80, PH2x10mm
	x4	SL3x75, SL4x100, SL6.5x125, SL8x150mm
	x1	PH00x50mm
	x1	SL2.5x50mm
	x1	250mm
	x1	200mm
	x1	160mm
	x1	7" (180mm)
	x1	180mm
	x1	220mm
	x1	160mm
	x1	160mm

	x1	
	x6	1,5mm
	x1	
	x1	300gr
	x1	3m
	x1	200mm
	x5	
	x1	18mm
	x10	
	x40	6.35mm
	x15	8mm



53928

278,00€

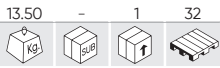

135-TEILIGER WERKZEUGKOFFER MIT VERZINKTEN INNENSECHSKANT-EINSÄTZEN



Verzinkt



ERSATZTEILE VERFÜGBAR

ENTHALTEN



	x10	10, 11, 12, 13, 14, 15, 17, 19, 22, 24mm
	x2	16, 21mm
	x1	UNIVERSAL
	x2	125, 250mm
	x1	3/8" - 1/2"
	x1	
	x9	4, 5, 6, 7, 8, 9, 10, 11, 12mm
	x1	UNIVERSAL
	x1	
	x2	50, 100mm
	x1	6mm
	x9	8, 10, 11, 12, 13, 14, 17, 19, 22mm
	x1	150mm
	x1	

	x4	PH1, PH2, PH2, PH3
	x4	PZ1, PZ2, PZ2, PZ3
	x4	SL3, SL4, SL5, SL6
	x4	H3, H4, H5, H6
	x7	TT10, TT15, TT20, TT25, TT27, T30, T40
	x7	TT10, TT15, TT20, TT25, TT27, TT30, TT40
	x1	6mm
	x1	6mmL
	x5	
	x1	
	x2	PH1x80mm, PH2x100mm
	x4	SL3.0x75mm, SL4.0x100mm, SL6.5x125mm, SL8x150mm

	x1	
	x1	
	x3	SL1.5, SL2, SL3
	x4	PH000, PH00, PH0, PH1
	x4	T4, T5, T6, T7, T8, T10, T15, T20
	x8	T8, T10, T15, T20
	x4	TS0.8, TS1.2, TS1.5, TS2.0
	x1	H2.0
	x1	
	x1	
	x1	
	x9	1.5, 2, 2.5, 3, 4, 5, 6, 8, 10mm
	x1	
	x1	5m
	x1	300g

	x1	250mm
	x1	180mm
	x1	180mm
	x1	200mm
	x1	160mm
	x1	200mm
	x1	
	x3	
	x1	18mm

53444

195,00€

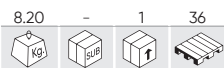

ALUMINIUM WERKZEUGKOFFER 108 STÜCK STECKSCHLÜSSEL 1/2" VERZINKT

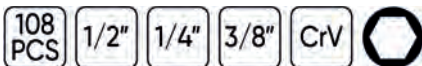

Verzinkt



ENTHALTEN



	x9	10, 11, 12, 13, 14, 15, 17, 18, 19mm
	x2	75, 150mm
	x1	16mm
	x1	Übergangsstück 3/8"(H) x 1/2"M
	x8	4, 4.5, 5, 5.5, 6, 7, 8, 9mm
	x1	150mmL
	x1	6mm
	x2	PH1x80, PH2x100mm
	x4	SL3.5x75, SL4x100, SL6.5x125, SL8x150mm
	x1	PH00x50mm
	x1	SL2.5x50mm
	x1	

	x9	6x7, 8x9, 10x11, 12x13, 14x15, 16x17, 18x19, 20x22mm
	x9	1.5, 2, 2.5, 3, 4, 5, 6, 8, 10mm
	x1	
	x6	
	x1	200mm
	x1	18mm
	x10	
	x1	220mm
	x1	180mm
	x1	160mm
	x1	250mm
	x1	160mm

	x30	
	x1	
	x1	300g
	x1	3m



52603

74,00€

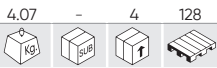

BIT-SET, 1/2" 12-KANT 26 TEILE



ENTHALTEN

	x8 (55mmL)	M5, M6, M8, M9, M10, M12, M14, M16
	x7 (100mmL)	M5, M6, M8, M9, M10, M12, M14
	x7 (140mmL)	M5, M6, M8, M9, M10, M12, M14
	x4 (200mmL)	M8, M10, M12, M14

52606

88,00€



BIT-SET, RIBE 1/2" 32 TEILE

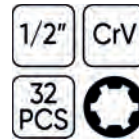

ENTHALTEN

	x9 (55mmL)	M5, M6, M7, M8, M9, M10, M12, M13, M14
	x9 (100mmL)	M5, M6, M7, M8, M9, M10, M12, M13, M14
	x7 (140mmL)	M7, M8, M9, M10, M12, M13, M14
	x7 (200mmL)	M7, M8, M9, M10, M12, M13, M14

52604

78,00€

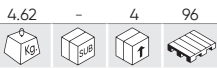

BIT-SET, 6-KANT 1/2" 30 TEILE

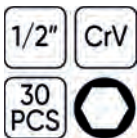

ENTHALTEN

	x9 (55mmL)	5, 6, 7, 8, 10, 12, 14, 17, 19mm
	x8 (100mmL)	5, 6, 7, 8, 10, 11, 12, 13mm
	x7 (140mmL)	5, 6, 7, 8, 10, 12, 14mm
	x6 (200mmL)	5, 6, 7, 8, 10, 12mm

52605

76,00€



BIT-SET, TORX 1/2" 32 TEILE

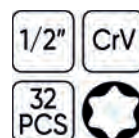

ENTHALTEN

	x10 (55mmL)	T20, T25, T27, T30, T40, T45, T50, T55, T60, T70
	x10 (100mmL)	T20, T25, T27, T30, T40, T45, T50, T55, T60, T70
	x6 (140mmL)	T40, T45, T50, T55, T60, T70
	x6 (200mmL)	T40, T45, T50, T55, T60, T70



54266

39,50€

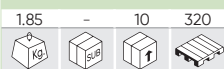

N

1/2" TORX-EINSÄTZE UND BITS SET - 19 TEILE



ENTHALTEN

	x9	E10, E11, E12, E14, E16, E18, E20
	x10	T20, T25, T27, T30, T40, T45, T50, T55, T60, T70



ERSATZTEILE VERFÜGBAR

54154

37,50€



TORX-SET 1/2", 12 TEILE

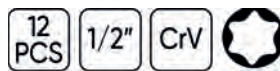

ENTHALTEN

	x6	T20, T25, T30, T40, T45, T50
	x6	T55, 60, T70, T80, T90, T100



ERSATZTEILE VERFÜGBAR

51260

37,00€



BIT-SET 6-KANT, 1/2" 12 TEILE

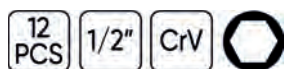

ENTHALTEN

	x6	H5, H6, H7, H8, H10, H12
	x1	H14
	x5	H16, H17, H18, H19, H20



ERSATZTEILE VERFÜGBAR

54164

34,00€



BIT-SET 12-KANT, 1/2" 12 TEILE

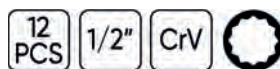

ENTHALTEN

	x6 (55mmL)	M4, M5, M6, M8, M9
	x6 (70mmL)	M10, M12, M14, M16, M18, M20



ERSATZTEILE VERFÜGBAR

50983

48,00€

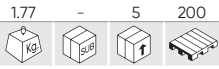

BIT-SET 6-KANT 12-KANT TORX, S-2 3/8" 1/2" 42 TEILE

42 PCS 1/2"
3/8" S-2



ENTHALTEN

	3/8"	x1	10mm
	1/2"	x1	10mm
	30mm	x7	4, 5, 6, 7, 8, 10, 12mm
	75mm	x7	4, 5, 6, 7, 8, 10, 12mm
	30mm	x8	T20, T25, T30, T40, T45, T50, T55, T60
	75mm	x8	T20, T25, T30, T40, T45, T50, T55, T60
	30mm	x5	M5, M6, M8, M10, M12
	75mm	x5	M5, M6, M8, M10, M12



50985

59,00€

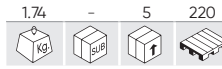

BIT-SET 6-KANT 12-KANT TORX MIT LOCH, S-2 3/8" 1/2" 42 TEILE

42 PCS 1/2"
3/8" S-2



ENTHALTEN

	3/8"	x1	10mm
	1/2"	x1	10mm
	30mm	x7	4, 5, 6, 7, 8, 10, 12mm
	75mm	x7	4, 5, 6, 7, 8, 10, 12mm
	30mm	x8	T20, T25, T30, T40, T45, T50, T55, T60
	75mm	x8	T20, T25, T30, T40, T45, T50, T55, T60
	30mm	x5	M5, M6, M8, M10, M12
	75mm	x5	M5, M6, M8, M10, M12



52550

92,00€

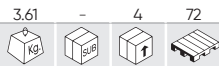

BIT-SET 6-KANT 12-KANT TORX TORX MIT LOCH UND RIBE, S-2 3/8" 1/2" 75 TEILE

75 PCS 1/2"
3/8" S-2

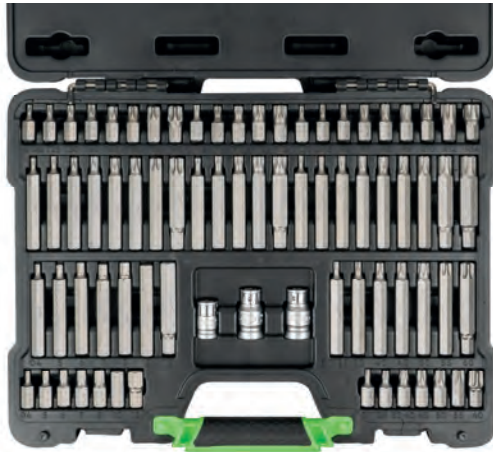

ENTHALTEN

	3/8"	x1	10mm
	1/2"	x2	10mm
	30mm	x7	4, 5, 6, 7, 8, 10, 12mm
	75mm	x7	4, 5, 6, 7, 8, 10, 12mm
	30mm	x8	T20, T25, T30, T40, T45, T50, T55, T60
	75mm	x8	T20, T25, T30, T40, T45, T50, T55, T60
	30mm	x5	M5, M6, M8, M10, M12
	75mm	x5	M5, M6, M8, M10, M12
	30mm	x8	R5, R6, R7, R8, R9, R10, R12, R14
	75mm	x8	R5, R6, R7, R8, R9, R10, R12, R14
	30mm	x8	TT20, TT25, TT30, TT40, TT45, TT50, TT55, TT60
	75mm	x8	TT20, TT25, TT30, TT40, TT45, TT50, TT55, TT60

52753

107,00€

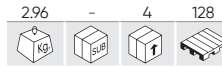

BIT-SET, S-2 3/8" 1/2" 55 TEILE HEAVY DUTY

55 PCS 1/2"
3/8" S-2



ENTHALTEN

	3/8"	x1	10mm
	1/2"	x2	10, 14mm
	30mm	x9	4, 5, 6, 7, 8, 10, 12, 14, 16mm - ISO 2136
	75mm	x9	4, 5, 6, 7, 8, 10, 12, 14, 16mm - ISO 2136
	30mm	x10	T20, T25, T30, T40, T45, T50, T55, T60, T70, T80 - DIN 2325
	75mm	x10	T20, T25, T30, T40, T45, T50, T55, T60, T70, T80 - DIN 2325
	30mm	x7	M5, M6, M8, M10, M12, M14, M16 - DIN 2325
	75mm	x7	M5, M6, M8, M10, M12, M14, M16 - DIN 2325

52539

59,00€

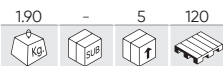

BIT-SET FÜR SCHRAUBENDREHER, METRISCH
85 TEILE



ENTHALTEN

	x10	PH3, PH4
	x10	PZ3, PZ4
	x25	7, 8, 10, 12, 14mm
	x15	SL8, SL10, SL12
	x25	T40, T45, T50, T55, T60



52538

62,00€



BIT-SET FÜR SCHRAUBENDREHER, 1/4" 90
TEILE



ENTHALTEN

	x10	PH1, PH2
	x10	PZ1, PZ2
	x20	3, 4, 5, 6mm
	x15	SL4, SL5.5, SL6.5
	x35	T8, T10, T15, T20, T25, T27, T30



53574

47,00€

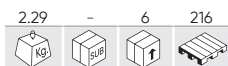

BIT-SET MIT SCHRAUBENDREHER, 208 BITS



ENTHALTEN

	x12	1.5, 2, 2.5, 3, 3.5, 4, 4.5, 5, 5.5, 6, 7, 8mm
	x10	1/16, 5/64, 3/32, 7/64, 1/8, 9/64, 5/32, 3/16, 7/32, 1/4
	x5	2.5, 3, 4, 5, 6mm
	x5	2.5, 3, 4, 5, 6mm
	x18	PH00, PH0, PH1(x5), PH2(x5), PH3(x5), PH4
	x3	PH1, PH2, PH3
	x3	PH1, PH2, PH3
	x17	PZ00, PZ0, PZ1(x5), PZ2(x5), PZ3(x4), PZ4
	x3	PZ1, PZ2, PZ3
	x3	PZ1, PZ2, PZ3
	x14	T5, T6, T7, T8, T9, T10, T15, T20, T25, T27, T30, T35, T40, T45
	x7	T10, T15, T20, T25, T27, T30, T40
	x7	T10, T15, T20, T25, T27, T30, T40

	x3	6, 8, 10mm
	x3	6, 8, 10mm
	x4	4, 6, 8, 10mm
	x4	4, 6, 8, 10mm
	x4	1, 2, 3, 4mm
	x4	1, 2, 3, 4mm
	x6	2, 2.5, 3, 4, 5, 6mm
	x6	5/64, 3/32, 7/64, 1/8, 9/64, 5/32
	x13	T5, 6, 7, 8, 9, 10, 15, 20, 25, 27, 30, 40, 45
	x3	1, 2, 3mm
	x4	0, 1, 2, 3mm
	x3	M5, M6, M8
	x9	TS10, TS15, TS20, TS25, TS27, TS30, TS40, TS45, TS50

	x12	SL2, SL2.5, SL3, SL3.5, SL4, SL4.5, SL5, SL5.5, SL6, SL6.5, SL7, SL8
	x10	4, 5, 6, 7, 8, 9, 10, 11, 12, 13
	x10	5/32, 3/16, 7/32, 1/4, 9/32, 5/16, 11/32, 3/8, 7/16, 1/2
	x1	1/4"
	x1	
	x1	



52620

8,80€

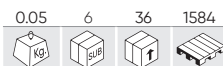

WINKELBITHALTER



- Bit-Halter, geeignet für enge Stellen
Extra niedriges Profil (37 mm) mit schnell austauschbare Verbindung.
- Bohrer 6mm.

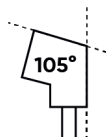

53156

26,20€

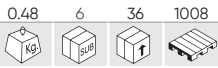

STECKSCHLÜSSEL-SET 1/4" MIT MINI-RATSCHHE, 6-KANT 38 TEILE



ENTHALTEN

1/4" x11	4, 4.5, 5, 6, 7, 8, 9, 10, 11, 12, 13mm	6mm x5	4, 5, 6, 7, 8mm
1/4" x1		6mm x3	SL6, SL8, SL10
x2	PH3, PH4	6mm x8	T8, T9, T10, T15, T20, T25, T30, T40
x2	PZ3, PZ4	x4	M5, M6, M9, M10
		x1	1/4"

52198

37,70€

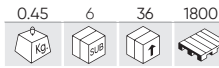

STECKSCHLÜSSEL-SET 1/4" MIT MINI-RATSCHHE, 6-KANT 38 TEILE

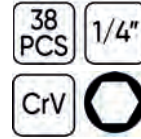

ENTHALTEN

1/4" x11	4, 4.5, 5, 6, 7, 8, 9, 10, 11, 12, 13mm	6mm x5	4, 5, 6, 7, 8mm
1/4" x1		6mm x3	SL6, SL8, SL10
x2	PH3, PH4	6mm x8	T8, T9, T10, T15, T20, T25, T30, T40
x2	PZ3, PZ4	x4	M5, M6, M9, M10
		x1	1/4"

51333

18,00€

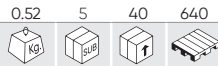

6 ADAPTER IM SET, IN ZOLL



ERSATZTEILVERFÜGBARKEIT

REF.	mm				€
11360	1/4H - 3/8M	0.03	10	100	2,60€
11361	1/4M - 3/8H	0.03	5	300	3,20€
11362	1/2H - 3/4M	0.14	10	100	5,20€
11363	3/8H - 1/2M	0.50	10	100	3,90€
11364	1/2H - 3/8M	0.05	10	100	4,50€
11365	3/4H - 1/2M	0.14	10	100	9,40€

53743

39,70€

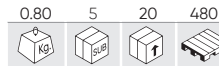

6 ADAPTER IM SET, IN ZOLL FÜR SCHLAGNUSS



ERSATZTEILVERFÜGBARKEIT

REF.	mm				€
14749	1/4"H - 3/8"M	0.03	20	200	2,00€
14750	3/8"H - 1/4"M	0.05	20	100	2,00€
14751	3/8"H - 1/2"M	0.15	20	100	4,00€
14752	1/2"H - 3/8"M	0.16	10	100	4,00€
11962	1/2"H - 3/4"M	0.17	10	100	7,50€
11964	3/4"H - 1/2"M	0.35	10	100	12,50€



52714 15,70€

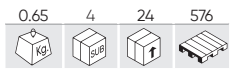

NUSS-SET 1/2", 6-KANT 10 TEILE

10 PCS 1/2" CrV
 10, 11, 12, 13, 14, 15, 16, 17, 18, 19mm



52716 15,90€

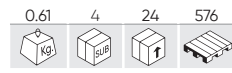

NUSS-SET 1/2", 12-KANT 10 TEILE

10 PCS 1/2" CrV
 10, 11, 12, 13, 14, 15, 16, 17, 18, 19mm



52715 10,00€

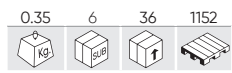

NUSS-SET 1/4", 6-KANT 13 TEILE

13 PCS 1/4" CrV
 4, 4.5, 5, 5.5, 6, 7, 8, 9, 10, 11, 12, 13, 14mm



52717 11,00€

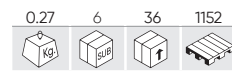

NUSS-SET 1/2", 12-KANT 13 TEILE

13 PCS 1/2" CrV
 4, 4.5, 5, 5.5, 6, 7, 8, 9, 10, 11, 12, 13, 14mm



51410 36,00€

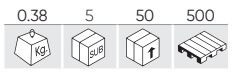

TORX MIT LOCH SET, 1/2" 6 TEILE

6 PCS 1/2" CrV
 T55, T60, T70, T80, T90, T100



51409 36,00€

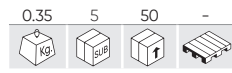

12-KANT BIT-SET FORM XZN, 1/2" 6 TEILE

6 PCS 1/2" CrV
 M10, M12, M14, M16, M18, M20



WERKZEUGSÄTZE

52909

12,50€

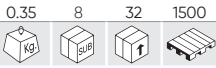

BIT-SET 1/4", S-2 18 TEILE



ERSATZTEILE VERFÜGBAR

ENTHALTEN

	x2	PH1, PH2		x3	SL4, SL5.5, SL6.5
	x2	PZ1, PZ2		x7	T8, T9, T10, T15, T20, T25, T27, T30
	x4	3, 4, 5, 6mm			

52908

17,00€

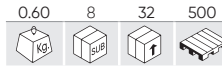

BIT-SET 1/4", S-2 30 TEILE

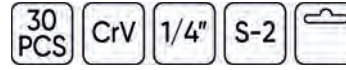

ERSATZTEILE VERFÜGBAR

ENTHALTEN

	x3	PH0, PH1, PH2		x4	SL4, SL5.5, SL6.5, SL7
	x3	PZ0, PZ1, PZ2		x8	T8, T9, T10, T15, T20, T25, T27, T30
	x4	3, 4, 5, 6mm		x8	T8, T9, T10, T15, T20, T25, T27, T30

53084

24,00€

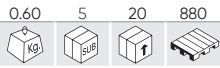

TORX-SET 3/8" - 1/2", 7 TEILE

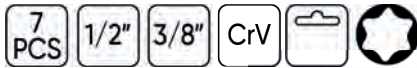

ERSATZTEILE VERFÜGBAR

	T55, T60, T70		T30, T40, T45, T50
--	---------------	--	--------------------

53127

12,00€

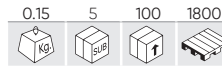

TORX-SET MIT LOCH 1/4", 7 TEILE



ERSATZTEILE VERFÜGBAR

	T10, T15, T20, T25, T30, T40, T45
--	-----------------------------------

51746

12,00€

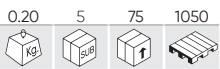

TORX-SET SECURITY 1/4", 7 TEILE



TS10, TS15, TS20, TS25, TS30, TS40, TS45



50980

22,00€

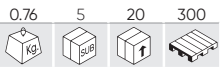

BIT-SET 3/8" 1/2", 7 TEILE



	100mm	M12, M13, M14
	90mm	M6, M7, M8, M10

50982

22,00€

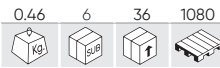

BIT-SET 3/8", 7 TEILE



	100mm	
	4, 5, 6, 7, 8, 10mm	

52320

22,00€

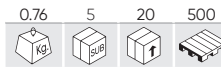

BIT-SET 3/8" 1/2", 7 TEILE



	100mm	M12, M13, M14
	90mm	M6, M7, M8, M10

12029 5,50€

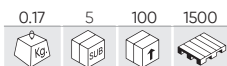

BIT 1/2" XZN MIT LOCH M16X58MM SP. VAG



12030 6,50€



BIT 1/2" XZN MIT LOCH M16X58MM SP. VAG



XZN (12-KANT) EXTRALANGER STECKSCHLÜSSEL-BIT 800MM 1/2"

REF.	BESCHREIBUNG					€
52059	Ø 8mm - 800mm	0.57	-	25	1750	29,00€
52060	Ø 10mm - 800mm	0.57	-	25	1750	32,00€
53667	Ø 12mm - 800mm	0.80	10	20	-	32,00€
53668	Ø 14mm - 800mm	1.05	10	20	-	34,00€



54091 441,00€



ISOLIERTER WERKZEUGSATZ NACH VDE - 26 STÜCK



54093 441,00€



VDE ISOLIERTES WERKZEUGMODUL EVA (ETHYLENVINYLACETAT) - 26 STÜCK



ENTHALTEN

	3/8" x10	8, 10, 11, 12, 13, 14, 16, 17, 18, 19, 21, 22mm
	3/8" x1	200mm
	1/2" x1	125mm
	3/8" x1	200mm

	x2	4x100mmL, 5,5x125mmL
	x2	PH1x80mm, PH2x100mm
	x1	185mm
	x1	

	x6	7x86, 8x99, 10x109, 12x127, 14x141, 17x156mm
	x1	185mm

15162

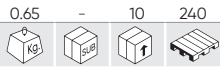

8 ST. SCHRAUBENZIEHERSÄTZE VDE MIT KOHLENFASERBESCHICHTUNG, RINNE AUS EVAC



ERSATZTEILVERFÜGBARKEIT

REF.	Ø	kg	10	50	€
15227	0.5x3.0x75mm	0,02	10	50	3,50€
15228	0.8x4.0x100mm	0,05	10	50	4,00€
15229	1.0x5.5x125mm	0,08	5	50	5,00€
15230	1.2x6.5x150mm	0,11	5	50	5,00€
15231	PH0x75mm	0,02	10	50	3,50€
15232	PH1x80mm	0,05	10	50	4,00€
15233	PH2x100mm	0,08	5	50	5,00€
15234	Kfz-Spannungsprüfer 140mm	0,02	10	50	3,00€

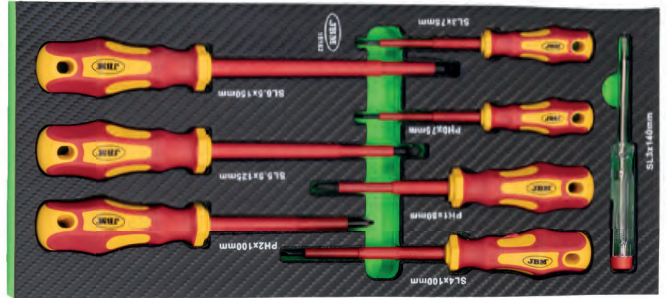

- ⊖ x4 0.5x3.0x75, 0.8x4.0x100, 1.0x5.5x125, 1.2x6.5x150mm
- ⊕ x3 PH0x75, PH1x80, PH2x100mm
- 🔧 x1 SL3x140mm

53154

462,00€

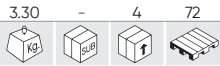

WERKZEUG-SET 3/8" ISOLIERT, 20 TEILE



ENTHALTEN

🔧	3/8"	x12	8, 10, 11, 12, 13, 14, 16, 17, 18, 19, 21, 22mm
🔧	3/8"	x1	200mm
🔧	3/8"	x2	125, 250mm
🔧	3/8"	x1	200mm
🔧	3/8"	x4	75mm, 4, 5, 6, 8mm

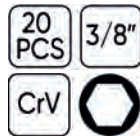

52519

25,50€

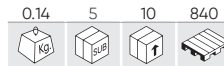

SCHRAUBENDREHER-SET ISOLIERT, 7 STÜCK



ENTHALTEN

- ⊕ x2 PH00x50, PH0x50mm
- ⊖ x5 SL1.5x0.23x50, SL1.8x0.30x50, SL2.0x0.40x50, SL2.5x0.40x50, SL3.0x0.50x50mm

ISOLIERTER KABELMESSER

REF.	BESCHREIBUNG	kg	6	36	1152	€
53164	GERADE	0.10	6	36	1152	16,50€
53165	GEBOGEN	0.10	6	36	1152	19,60€



HANDWERKZEUGE

- 38 SCHLÜSSEL
- 48 SCHRAUBZWINGEN
- 49 RATSCHEN
- 51 DREHMOMENTSCHLÜSSEL
- 53 VERLÄNGERUNGSSTANGEN
- 53 SCHRAUBENDREHER
- 56 ZANGEN
- 62 INSPEKTIONSWERKZEUGE
- 63 HÄMMER
- 64 SCHNEIDWERKZEUGE
- 65 MEISEL
- 66 NIETEN MASCHINEN
- 68 MESSGERÄTE
- 69 VERSCHIEDENES

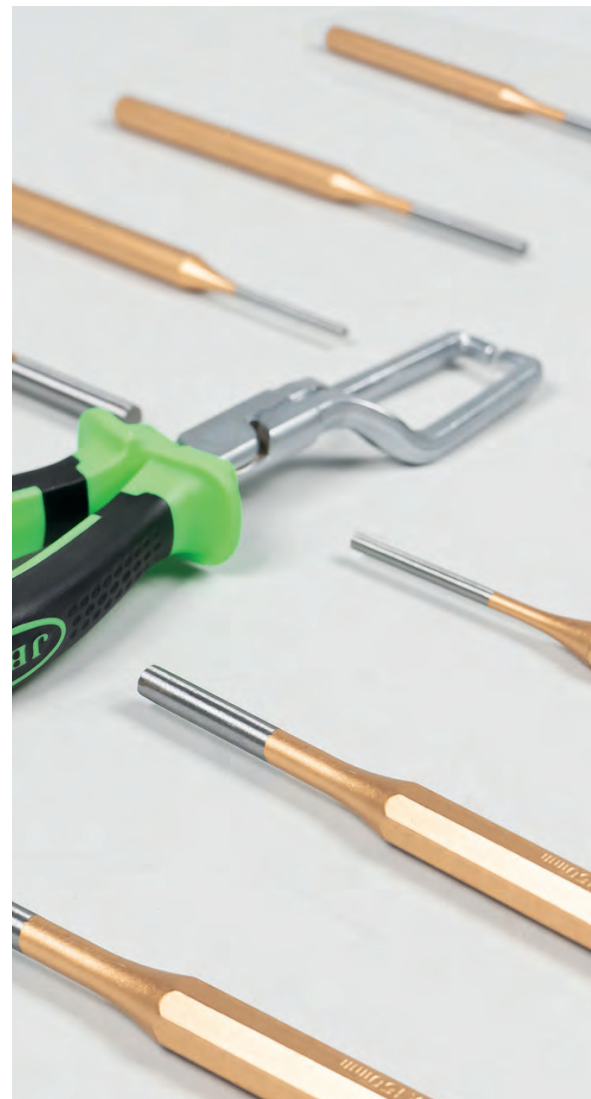

54101

61,00€



RING-RATSCHENSCHLÜSSEL SET METRISCH, 6 TEILE VERCHROMT



8x9, 10x11, 12x13, 14x15, 16x18, 17x19mm



ERSATZTEIL VERFÜGBAR

REF.	mm	Kg	Box	Box	€
15632	8x9	0.04	10	100	9,00€
15633	10x11	0.07	10	100	9,50€
15634	12x13	0.11	10	100	11,00€

REF.	mm	Kg	Box	Box	€
15635	14x15	0.13	10	100	12,50€
15636	16x18	0.19	10	100	14,00€
15637	17x19	0.25	10	100	15,00€

53017

57,00€

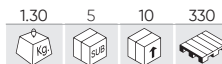

GELENKMAUL-RING-RATSCHENSCHLÜSSEL SET METRISCH, 7 TEILE VERCHROMT



8, 10, 11, 13, 14, 17, 19 mm



ERSATZTEIL VERFÜGBAR

REF.	mm	Kg	Box	Box	€
10552	8	0.06	10	100	7,10€
10554	10	0.09	10	100	7,50€
10555	11	0.09	10	100	7,80€
10557	13	0.13	10	100	8,10€

REF.	mm	Kg	Box	Box	€
10558	14	0.14	5	100	9,35€
10561	17	0.22	10	100	11,00€
10563	19	0.28	10	100	12,50€

54117

74,00€

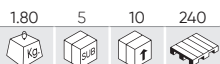

MAUL-RING-RATSCHENSCHLÜSSEL SET METRISCH, 12 TEILE VERCHROMT



8, 9, 10, 11, 12, 13, 14, 15, 16, 17, 18, 19 mm



ERSATZTEIL VERFÜGBAR

REF.	mm	Kg	Box	Box	€
13465	8	0.05	10	100	5,55€
13466	9	0.06	10	100	5,55€
13467	10	0.10	10	100	6,00€
13468	11	0.08	10	100	6,25€
13469	12	0.09	10	100	6,25€
13470	13	0.10	10	100	6,60€

REF.	mm	Kg	Box	Box	€
13471	14	0.11	10	100	6,90€
13472	15	0.13	10	100	7,25€
13473	16	0.15	10	100	8,10€
13474	17	0.19	10	100	8,70€
13475	18	0.22	10	100	9,10€
13476	19	0.22	10	100	9,60€

51318

98,00€

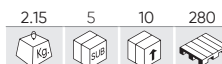

GELENKMAUL-RING-RATSCHENSCHLÜSSEL SET METRISCH, 12 TEILE VERCHROMT



8, 9, 10, 11, 12, 13, 14, 15, 16, 17, 18, 19 mm



ERSATZTEIL VERFÜGBAR

REF.	mm	Kg	Box	Box	€
10552	8	0.06	10	100	7,10€
10553	9	0.07	10	100	7,35€
10554	10	0.09	10	100	7,50€
10555	11	0.09	10	100	7,80€
10556	12	0.11	10	100	8,10€
10557	13	0.13	10	100	8,10€

REF.	mm	Kg	Box	Box	€
10558	14	0.14	5	100	9,35€
10559	15	0.16	10	100	9,50€
10560	16	0.19	5	50	10,60€
10561	17	0.22	10	100	11,00€
10562	18	0.26	5	100	12,30€
10563	19	0.28	10	100	12,50€

54338

60,00€

0,95	5	20	420

N

RATSCHENSCHLÜSSEL MIT AUSTAUSCHBAREM KOPF 12 STÜCK

ERSATZTEIL VERFÜGBAR

REF.	mm				€
16391	8	0.01	30	100	4,60€
16392	9	0.05	30	100	4,60€
16393	10	0.05	30	100	4,60€
16394	11	0.05	30	100	5,10€
16395	12	0.05	30	100	5,10€
16396	13	0.05	30	100	5,10€

REF.	mm				€
16397	14	0.05	30	100	5,50€
16398	15	0.05	30	100	5,50€
16399	16	0.05	30	100	5,50€
16401	17	0.05	30	100	6,10€
16402	18	0.05	30	100	6,10€
16403	19	0.10	30	100	6,10€

12 PCS

8, 9, 10, 11, 12, 13, 14, 15, 16, 17, 18, 19 mm

ARTICULADA ARTICULATED



15316

58,00€

0,85	-	10	260

SET MIT 3 SCHLÜSSELN MIT 72 ZÄHNEN - TYP "4 IN 1"

3 PCS



ERSATZTEIL VERFÜGBAR

REF.	mm				€
15515	12-13mm x 8-10mm	0.15	10	50	15,50€
15516	14-15mm x 9-11mm	0.20	10	50	19,00€
15517	18-19mm x 16-17mm	0.40	5	50	22,50€

54066

83,00€

2,00	-	5	175

SATZ VON 7 EXTRALANGEN SCHRAUBENSCHLÜSSELN MIT RATSCHENKLINKE

7 PCS



ERSATZTEIL VERFÜGBAR

REF.	mm				€
13453	8	0.10	6	36	9,00€
13454	10	0.15	10	100	9,50€
13455	12	0.20	6	36	10,50€
13456	13	0.20	6	36	11,50€

REF.	mm				€
13457	14	0.25	6	36	12,00€
13460	17	0.40	6	24	15,00€
13462	19	0.50	6	24	17,00€

54032

84,00€

1,45	-	10	240

SATZ VON KURZEN KOMBI-GELENK-RATSCHENSCHLÜSSELN

12 PCS

ARTICULADA ARTICULATED



ERSATZTEIL VERFÜGBAR

REF.	mm				€
15328	8	0.05	12	96	6,00€
15329	9	0.05	12	96	5,50€
15330	10	0.05	12	96	5,50€
15331	11	0.07	12	96	5,50€
15332	12	0.09	12	96	6,00€
15333	13	0.10	12	96	6,50€

REF.	mm				€
15334	14	0.11	12	96	7,00€
15335	15	0.13	12	96	7,50€
15336	16	0.14	12	96	8,00€
15337	17	0.16	12	96	8,50€
15338	18	0.18	12	96	9,00€
15339	19	0.20	12	96	9,50€

15122

74,00€

1,70	-	10	200

SATZ VON 12 SCHLÜSSELN MIT KOHLEFASERBESCHICHTUNG

12 PCS



ERSATZTEIL VERFÜGBAR

REF.	mm				€
13465	8	0.05	10	100	5,55€
13466	9	0.06	10	100	5,55€
13467	10	0.10	10	100	6,00€
13468	11	0.08	10	100	6,25€
13469	12	0.09	10	100	6,25€
13470	13	0.10	10	100	6,60€

REF.	mm				€
13471	14	0.11	10	100	6,90€
13472	15	0.13	10	100	7,25€
13473	16	0.15	10	100	8,10€
13474	17	0.19	10	100	8,70€
13475	18	0.22	10	100	9,10€
13476	19	0.22	10	100	9,60€

53018

119,00€



GELENK-MAUL-RATSCHENSCHLÜSSEL SET METRISCH, 6 TEILE VERCHROMT

6 PCS **72**

8x9, 10x11, 12x13, 14x15, 16x18, 17x19mm

ARTICULADA
ARTICULATED



ERSATZTEIL VERFÜGBAR

REF.	mm				€
13447	8x9	0.10	6	36	16,50€
13448	10x11	0.15	6	36	17,50€
13449	12x13	0.25	6	36	20,00€

REF.	mm				€
13450	14x15	0.30	6	36	23,00€
13451	16x18	0.35	6	24	28,00€
13452	17x19	0.40	6	24	29,50€

54110

46,00€



RING-RATSCHENSCHLÜSSEL SET, 8 TEILE VERCHROMT KURZ

8 PCS **72**

10, 11, 12, 13, 14, 15, 17, 19mm



ERSATZTEIL VERFÜGBAR

REF.	mm				€
13491	10	0.05	10	100	5,30€
13492	11	0.06	10	100	5,35€
13493	12	0.07	10	100	5,50€
13494	13	0.08	5	100	6,00€

REF.	mm				€
13495	14	0.09	10	100	6,40€
13496	15	0.12	10	100	6,60€
13497	17	0.14	10	100	7,50€
13498	19	0.19	10	100	8,50€

54041

198,00€

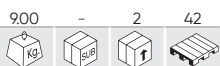

MAUL-RING-RATSCHENSCHLÜSSEL SET METRISCH, 22 TEILE VERCHROMT

22 PCS **90**

6, 7, 8, 9, 10, 11, 12, 13, 14, 15, 16, 17, 18, 19, 20, 21, 22, 23, 24, 27, 30, 32mm



ERSATZTEIL VERFÜGBAR

REF.	mm				€
13463	6	0.03	10	100	5,30€
13464	7	0.04	10	100	5,30€
13465	8	0.05	10	100	5,55€
13466	9	0.06	10	100	5,55€
13467	10	0.10	10	100	6,00€
13468	11	0.08	10	100	6,25€
13469	12	0.09	10	100	6,25€
13470	13	0.10	10	100	6,60€
13471	14	0.11	10	100	6,90€
13472	15	0.13	10	100	7,25€
13473	16	0.15	10	100	8,10€

REF.	mm				€
13474	17	0.19	10	100	8,70€
13475	18	0.22	10	100	9,10€
13476	19	0.22	10	100	9,60€
13477	20	0.23	6	60	9,85€
13478	21	0.37	6	60	12,20€
13479	22	0.37	6	60	13,10€
13480	23	0.37	6	48	15,50€
13481	24	0.53	6	48	15,80€
13482	27	0.60	6	24	22,10€
13483	30	0.80	6	24	25,50€
13484	32	1.12	6	24	27,20€

54079

83,00€

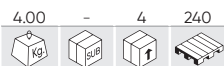

21 KOMBISCHLÜSSEL-SATZ

21 PCS 6, 7, 8, 9, 10, 11, 12, 13, 14, 15, 16, 17, 18, 19, 20, 21, 22, 24, 27, 30, 32mm

ERSATZTEIL VERFÜGBAR

REF.	mm				€
10531	10	0.05	10	100	3,00€
10532	11	0.06	10	100	2,70€
10533	12	0.07	10	100	3,00€
10534	13	0.08	10	100	3,25€
10535	14	0.10	10	100	3,50€
10536	15	0.10	10	100	3,65€
10537	16	0.11	10	100	3,90€
10538	17	0.14	10	100	4,30€
10539	18	0.16	10	100	4,75€

REF.	mm				€
10540	19	0.20	10	100	5,25€
10541	20	0.21	6	60	5,55€
10542	21	0.25	-	50	5,85€
10543	22	0.25	-	50	7,00€
10544	24	0.33	10	100	8,10€
10545	27	0.41	10	50	9,75€
10546	30	0.52	-	25	11,60€
10547	32	0.59	-	25	13,50€
10548	6	0.03	10	100	1,75€



REF.	mm				€
10549	7	0.03	10	100	2,00€
10550	8	0.03	10	100	2,15€
10551	9	0.04	10	100	2,15€

54097

38,90€

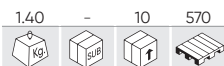

SET MAUL-RINGSCHLÜSSEL 14 TEILE

14 PCS CrV 6, 7, 8, 9, 10, 11, 12, 13, 14, 15, 16, 17, 18, 19 mm

ERSATZTEIL VERFÜGBAR

REF.	mm				€
10531	10	0.05	10	100	3,00€
10532	11	0.06	10	100	2,70€
10533	12	0.07	10	100	3,00€
10534	13	0.08	10	100	3,25€
10535	14	0.10	10	100	3,50€
10536	15	0.10	10	100	3,65€
10537	16	0.11	10	100	3,90€

REF.	mm				€
10538	17	0.14	10	100	4,30€
10539	18	0.16	10	100	4,75€
10540	19	0.20	10	100	5,25€
10548	6	0.03	10	100	1,75€
10549	7	0.03	10	100	2,00€
10550	8	0.03	10	100	2,15€
10551	9	0.04	10	100	2,15€



54120

59,00€



SET MAUL-RINGSCHLÜSSEL 7 TEILE

7 PCS CrV 20, 21, 22, 24, 27, 30, 32mm



ERSATZTEIL VERFÜGBAR

REF.	mm				€
10541	20	0.21	6	60	5,55€
10542	21	0.25	-	50	5,85€
10543	22	0.25	-	50	7,00€
10544	24	0.33	10	100	8,10€

REF.	mm				€
10545	27	0.41	10	50	9,75€
10546	30	0.52	-	25	11,60€
10547	32	0.59	-	25	13,50€

54174

139,00€



SET MAUL-RINGSCHLÜSSEL 6 TEILE

6 PCS CrV XL 34, 36, 38, 41, 46, 50mm



ERSATZTEIL VERFÜGBAR

REF.	mm				€
16020	34	0.36	10	100	17,00€
16021	36	0.00	10	100	19,50€
16022	38	0.43	10	100	23,00€

REF.	mm				€
16023	41	0.47	10	100	26,50€
16024	46	0.51	10	100	34,50€
16025	50	0.58	10	100	37,50€

50564

30,00€

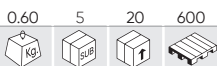

SET KURZER MAUL-RINGSCHLÜSSEL



ERSATZTEIL VERFÜGBAR

REF.	mm	Kg	SUB	PCS	€	REF.	mm	Kg	SUB	PCS	€	REF.	mm	Kg	SUB	PCS	€
10564	10	0.05	10	100	2,50€	10567	13	0.05	10	100	3,50€	10570	17	0.10	10	100	4,50€
10565	11	0.05	10	100	3,50€	10568	14	0.05	10	100	4,00€	10571	19	0.15	10	100	5,00€
10566	12	0.05	10	100	3,50€	10569	15	0.05	10	100	4,50€						



54150

23,50€

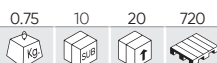

MAULSCHLÜSSEL VERCHROMT

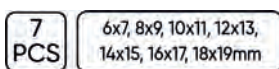

ERSATZTEIL VERFÜGBAR

REF.	mm	Kg	SUB	PCS	€	REF.	mm	Kg	SUB	PCS	€
10579	10x11	0.06	10	100	3,00€	10583	18x19	0.19	10	100	4,15€
10580	12x13	0.07	10	100	3,10€	10589	6x7	0.03	10	100	2,00€
10581	14x15	0.10	10	100	3,40€	10590	8x9	0.04	10	100	2,40€
10582	16x17	0.14	10	100	4,00€						

54149

60,00€



MAULSCHLÜSSEL

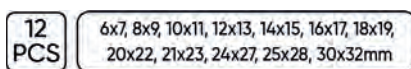

ERSATZTEIL VERFÜGBAR

REF.	mm	Kg	SUB	PCS	€	REF.	mm	Kg	SUB	PCS	€
10579	10x11	0.06	10	100	3,00€	10585	21x23	0.31	-	50	6,75€
10580	12x13	0.07	10	100	3,10€	10586	24x27	0.35	10	100	7,60€
10581	14x15	0.10	10	100	3,40€	10587	25x28	0.36	-	50	9,80€
10582	16x17	0.14	10	100	4,00€	10588	30x32	0.54	-	25	10,50€
10583	18x19	0.19	10	100	4,15€	10589	6x7	0.03	10	100	2,00€
10584	20x22	0.25	6	60	5,05€	10590	8x9	0.04	10	100	2,40€

52973

59,00€



MAULSCHLÜSSEL VERCHROMT

ERSATZTEIL VERFÜGBAR

REF.	mm	Kg	SUB	PCS	€	REF.	mm	Kg	SUB	PCS	€
10579	10x11	0.06	10	100	3,00€	10585	21x23	0.31	-	50	6,75€
10580	12x13	0.07	10	100	3,10€	10586	24x27	0.35	10	100	7,60€
10581	14x15	0.10	10	100	3,40€	10587	25x28	0.36	-	50	9,80€
10582	16x17	0.14	10	100	4,00€	10588	30x32	0.54	-	25	10,50€
10583	18x19	0.19	10	100	4,15€	10589	6x7	0.03	10	100	2,00€
10584	20x22	0.25	6	60	5,05€	10590	8x9	0.04	10	100	2,40€



6x7, 8x9, 10x11, 12x13, 14x15, 16x17, 18x19, 20x22, 21x23, 24x27, 25x28, 30x32mm



54115 26,80€

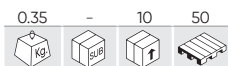

SET TORX-SCHLÜSSEL FLACH 4

4 PCS E6xE8, E10xE12, E14xE18, E20xE24



ERSATZTEIL VERFÜGBAR

REF.	mm				€
16546	E6xE8	0.05	10	100	5,00€
16547	E10xE12	0.07	10	100	5,50€
16548	E14xE18	0.08	10	100	9,00€
16549	E20xE24	0.09	10	100	14,00€

54081 28,00€

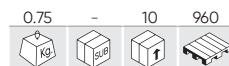

SET RINGSCHLÜSSEL 12-KANT OFFEN 8 TEILE

5 PCS 10x11HEX, 12x13HEX, 14x15HEX, 16x17HEX, 18x19HEX



ERSATZTEIL VERFÜGBAR

REF.	mm				€
11258	10x11	0.10	5	100	7,30€
11259	12x13	0.10	5	100	8,30€
11260	14x15	0.11	5	100	9,75€
11261	16x17	0.18	5	100	11,35€
11262	18x19	0.21	-	100	13,50€

54159 47,00€



SET STARTERSCHLÜSSEL RING C-FÖRMIG 8 TEILE

8 PCS

6x7, 8x9, 10x11, 12x13, 14x15, 16x17, 18x19, 20X22mm



ERSATZTEIL VERFÜGBAR

REF.	mm				€
11639	6x7	0.61	5	50	4,00€
11640	8x9	0.04	5	50	4,50€
11641	10x11	0.04	5	50	5,00€
11642	12x13	0.06	5	50	5,00€
11643	14x15	0.09	5	-	6,00€
11644	16x17	0.12	5	50	7,00€
11645	18x19	0.15	5	50	7,00€
11646	20x22	0.22	5	-	9,45€

52451 42,00€



SET STARTERSCHLÜSSEL RING C-FÖRMIG 8 TEILE

8 PCS

6x7, 8x9, 10x11, 12x13, 14x15, 16x17, 18x19, 20X22mm



ERSATZTEIL VERFÜGBAR

REF.	mm				€
11639	6x7	0.61	5	50	4,00€
11640	8x9	0.04	5	50	4,50€
11641	10x11	0.04	5	50	5,00€
11642	12x13	0.06	5	50	5,00€
11643	14x15	0.09	5	-	6,00€
11644	16x17	0.12	5	50	7,00€
11645	18x19	0.15	5	50	7,00€
11646	20x22	0.22	5	-	9,45€

15156 70,00€



4 ST. GESCHLOSSENE DOPPELSCHLÜSSEL MIT KOHLENFASERBESCHICHTUNG, RINNE AUS EVAC

ERSATZTEIL VERFÜGBAR

REF.	mm				€
15206	21x23	0.45	5	50	15,00€
15207	24x27	0.50	5	50	16,50€
15208	25x28	0.45	5	50	17,00€
15209	30x32	0.67	10	50	18,00€

4 PCS 21x23, 24x27, 25x28, 30x32mm



54119

78,00€



DOPPEL-RINGSCHLÜSSEL, GEKRÖPFT

12 PCS 6x7, 8x9, 10x11, 12x13, 14x15, 16x17, 18x19, 20x22, 21x23, 24x27, 25x28, 30x32mm



ERSATZTEIL VERFÜGBAR

REF.	mm				€	REF.	mm				€
10627	6x7	0.04	10	100	2,80€	10633	18x19	0.22	10	100	6,60€
10628	8x9	0.06	10	100	3,10€	10634	20x22	0.43	-	50	7,80€
10629	10x11	0.08	10	100	3,65€	10635	21x23	0.30	-	50	8,15€
10630	12x13	0.11	10	100	3,90€	10636	24x27	0.35	-	25	8,80€
10631	14x15	0.14	10	100	4,20€	10637	25x28	0.48	6	24	12,10€
10632	16x17	0.18	10	100	5,30€	10638	30x32	0.73	6	24	12,70€

50562

23,50€

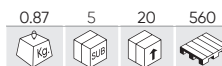

DOPPEL-RINGSCHLÜSSEL, GEKRÖPFT

7 PCS 6x7, 8x9, 10x11, 12x13, 14x15, 16x17, 18x19mm



ERSATZTEIL VERFÜGBAR

REF.	mm				€	REF.	mm				€
10627	6x7	0.04	10	100	2,80€	10631	14x15	0.14	10	100	4,20€
10628	8x9	0.06	10	100	3,10€	10632	16x17	0.18	10	100	5,30€
10629	10x11	0.08	10	100	3,65€	10633	18x19	0.22	10	100	6,60€
10630	12x13	0.11	10	100	3,90€						

51528

49,00€

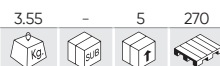

SET DOPPEL-STECKSCHLÜSSEL GEBOGEN, 14 TEILE

14 PCS 8, 9, 10, 11, 12, 13, 14, 15, 16, 17, 18, 19, 20, 21mm



ERSATZTEIL VERFÜGBAR

REF.	mm				€	REF.	mm				€
10591	10	0.09	10	200	2,50€	10598	17	0.32	10	60	4,60€
10592	11	0.12	10	200	2,55€	10599	18	0.43	10	40	6,00€
10593	12	0.16	10	120	3,15€	10600	19	0.41	10	40	6,25€
10594	13	0.17	10	100	3,20€	10601	20	0.45	10	30	6,50€
10595	14	0.20	10	100	3,35€	10602	21	0.47	10	30	7,05€
10596	15	0.25	10	70	4,25€	10603	8	0.07	10	300	2,10€
10597	16	0.30	10	70	4,50€	10604	9	0.08	10	200	2,25€

53420

72,00€



SET DOPPEL-STECKSCHLÜSSEL GERADE, 8 TEILE

8 PCS 6x7, 8x9, 10x11, 12x13, 14x15, 16x17, 18x19, 20x22mm



53979

34,60€

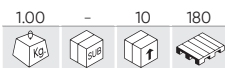

SATZ AUS 8 TORX-SCHRAUBENDREHERN



T10x75, T15x75, T20x100, T25x100, T30x150, T40x150, T45x200, T50x200mm

53980

34,60€

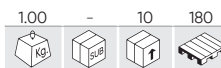

SATZ AUS 8 T-FÖRMIGEN SCHLÜSSELN MIT RUNDEM END

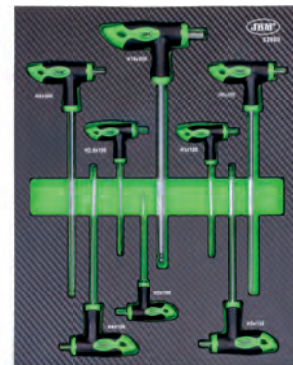

H2x100, H2.5x100, H3x100, H4x150, H5x150, H6x200, H8x200, H10x200

SET RINGSCHLÜSSEL EXTRA LANG 6 -TEILE

51864

64,00€



10x11mm (290mmL), 12x14mm (330mmL), 13x15mm (368mmL), 16x18mm (407mmL), 17x19mm (407mmL), 22x24mm (430mmL)



52912

91,00€



E6xE7 (200mmL), E8xE10 (235mmL), E11xE12 (290mmL), E14xE16 (370mmL), E18xE20 (410mmL), E22xE24 (420mmL)



ERSATZTEIL VERFÜGBAR

REF.	mm	kg	box	unit	€	REF.	mm	kg	box	unit	€
11244	10x11	0.13	5	100	8,50€	11247	16x18	0.30	6	36	14,00€
11245	12x14	0.18	10	50	9,15€	11248	17x19	0.31	10	36	14,60€
11246	13x15	0.25	6	36	12,40€	11249	22x24	0.43	5	-	26,50€

SCHLÜSSEL SET 9 -TEILE

TORX

REF.	mm	BESCHREIBUNG	kg	box	unit	€	
53737	90-218mm	SET TORX-SCHLÜSSEL EXTRALANG	0.42	10	40	1000	12,50€
53739	86-150mm	SET TORX-SCHLÜSSEL KURZ	0.32	10	40	960	10,50€
53955	72-170mm	TORX DÜSEN-SET 9 STCK. (KURZ)	0.25	10	40	1480	10,00€



T10, T15, T20, T25, T27, T30, T40, T45, T50

SECHSECKIGEN

REF.	mm	BESCHREIBUNG	kg	box	unit	€	
53738	90-220mm	9 INNENSECHSKANTSCHLÜSSEL SET (EXTRALANG)	0.45	10	40	1000	10,90€
53740	72-170mm	SET INBUS-SCHLÜSSEL KURZ	0.37	10	40	960	9,10€
53954	43-97mm	SECHSKANTDÜSEN-SET 9 STCK. (KURZ)	0.25	10	40	1480	8,50€



1,5, 2, 2,5, 3, 4, 5, 6, 8, 10mm



HANDWERKZEUGE

51659

59,00€

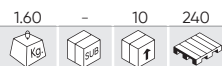

GELENKKOPF-SCHLÜSSEL SET, 12-KANT 6 TEILE VERCHROMT

6 PCS

8x9, 10x11, 12x13, 14x15, 16x17, 18x19mm



ERSATZTEIL VERFÜGBAR

REF.	mm				€
10621	8-9	0.09	10	100	9,50€
10622	10-11	0.13	10	100	10,00€
10623	12-13	0.16	5	100	12,60€

50622

64,00€

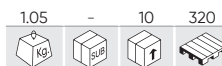

SET VON 4 TORX-GELENKSCHLÜSSELN

4 PCS

E6 x E8, E10 x E12, E14 x E18, E20 x E24



ERSATZTEIL VERFÜGBAR

REF.	mm				€
10617	E6x E8	0.07	10	100	14,10€
10618	E10x E12	0.11	10	100	15,10€
10619	E14x E18	0.20	10	100	15,70€
10620	E20x E24	0.34	10	100	16,20€

54187

39,30€

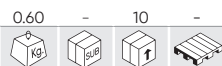

3/8" HAHNENFUSSSCHLÜSSEL 10 TEILE

ERSATZTEIL VERFÜGBAR

REF.	mm				€
16010	10	0.04	10	100	4,00€
16011	11	0.04	10	100	4,00€
16012	13	0.04	10	100	4,00€
16013	14	0.05	10	100	4,50€
16014	15	0.05	10	100	4,50€

REF.	mm				€
16015	16	0.05	10	100	5,00€
16016	17	0.05	10	100	5,00€
16017	18	0.06	10	100	5,00€
16018	19	0.06	10	100	5,50€
16019	22	0.08	10	100	6,00€



10 PCS

10, 11, 13, 14, 15, 16, 17, 18, 19, 22mm

CrV 3/8"

ZÖLLIGES WERKZEUG

51890

92,00€



RING-MAULSCHLÜSSEL SET IN ZOLL, 17 TEILE

17 PCS

5/16, 3/8, 7/16, 1/2, 9/16, 19/32, 5/8, 11/16, 3/4, 13/16, 7/8, 15/16, 1", 1 1/16, 1 1/8, 1 3/16, 1 1/4



54005

14,00€

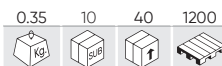

SATZ VON 9 IMBUSSSCHLÜSSELN

9 PCS CrV

1/16", 5/64", 3/32", 1/8", 5/32", 3/16", 1/4", 5/16", 3/8"

72-170mm



54106

89,00€



37-TEILIGER VERZINKTER ZOLL-WERKZEUGKOFFER

37 PCS CrV

1/2" 1/4"



KREUZSCHLÜßEL GESCHWEIßT

51661 12,00€

1.17 5 20 360

1/2" 355mm

17, 19, 21mm



52880 42,00€

3.75 - 5 120

3/4" 700mm

24, 27, 32mm



52881 17,00€

1.40 - 10 480

1/2" 400mm

17, 19, 21, 22mm



51416 12,00€

1.05 10 20 360

VERLÄNGERBARER RADSCHLÜßEL MIT STECKNÜßEN, 330-490 MM



1/2"



17/19mm
21/23mm





ROLLGABELSCHLÜßEL

MODELL 1

REF.	BESCHREIBUNG		mm					€
51798	VERSTELLSCHLÜßEL 18"	53mm	450mm	1.90	3	12	480	39,60€
52424	VERSTELLSCHLÜßEL 24"	62mm	610mm	3.75	-	5	350	64,00€



MODELL 2

REF.	BESCHREIBUNG		mm					€
51795	VERSTELLSCHLÜßEL 8"	22mm	200mm	0.28	6	60	3600	9,00€
51796	VERSTELLSCHLÜßEL 10"	28mm	250mm	0.48	6	36	2400	14,00€
51797	VERSTELLSCHLÜßEL 12"	37mm	300mm	0.71	6	24	960	18,00€



MODELL 3

REF.	BESCHREIBUNG		mm					€
53639	VERSTELLSCHLÜßEL 6"	28mm	150mm	0.15	6	96	576	28,60€
53640	VERSTELLSCHLÜßEL 8"	30mm	200mm	0.28	6	72	504	34,40€
53641	VERSTELLSCHLÜßEL 10"	33mm	250mm	0.50	6	36	1151	41,00€
53642	VERSTELLSCHLÜßEL 12"	40mm	300mm	0.83	6	10	1200	54,00€
53643	VERSTELLSCHLÜßEL 16"	52mm	400mm	1.53	-	12	336	92,00€
54098	VERSTELLSCHLÜßEL 20"	65mm	640mm	2.70	-	6	-	158,50€





53654 81,00€

1.40 - 5 200





SET HAKENSCHLÜßEL

8 PCS 35-60, 60-90, 90-120mm

160mm 177mm 250mm









ROHRSCHLÜSSEL

REF.	BESCHREIBUNG		"					€
52235	ROHRSCHLÜSSEL 300MM	50mm	12"	0.90	6	24	1140	11,00€
52236	ROHRSCHLÜSSEL 350MM	60mm	14"	1.09	6	24	760	13,30€
52237	ROHRSCHLÜSSEL 450MM	70mm	18"	1.75	4	12	720	18,10€
52238	ROHRSCHLÜSSEL 600MM	75mm	24"	2.50	2	8	600	24,90€
53210	ROHRSCHLÜSSEL 915MM	110mm	36"	4.95	-	4	96	48,00€







EINHAND-ROHRSCHLÜSSEL

REF.	BESCHREIBUNG		mm					€
53070	EINHAND-ROHRSCHLÜßEL 12"	45mm	270mm	0.68	6	24	900	16,20€
53071	EINHAND-ROHRSCHLÜßEL 14"	50mm	320mm	0.92	4	12	900	26,10€
53072	EINHAND-ROHRSCHLÜßEL 18"	65mm	410mm	1.35	4	12	900	31,60€
53073	EINHAND-ROHRSCHLÜßEL 24"	75mm	540mm	2.05	2	8	1000	50,00€



SCHRAUBZWINGE

REF.	BESCHREIBUNG					€
52349	SCHRAUBZWINGE 90X200MM	1.25	-	10	480	22,10€
52350	SCHRAUBZWINGE 90X300MM	1.41	-	10	540	22,60€
52351	SCHRAUBZWINGE 90X400MM	1.60	-	10	480	25,40€
52352	SCHRAUBZWINGE 120X300MM	1.99	-	10	360	32,40€
52353	SCHRAUBZWINGE 120X400MM	2.10	-	10	350	33,40€
52354	SCHRAUBZWINGE 120X500MM	2.41	-	6	300	34,40€
52355	SCHRAUBZWINGE 120X600MM	2.62	-	4	300	36,60€
52357	SCHRAUBZWINGE 150X800MM	4.60	-	5	125	54,00€
52358	SCHRAUBZWINGE 150X1000MM	5.35	-	5	120	63,00€



72-ZAHN RATSCHEN MIT STECKSHLÜSSEL SET

REF.	BESCHREIBUNG					€
54028	72-ZAHN RATSCHEN MIT 1/2" MIT INBUSEINSÄTZEN	1.30	4	24	432	28,00€
54029	1/2" 72-ZAHN RATSCHEN MIT 12-PUNKT-BUCHSEN	1.25	4	24	432	28,00€
54030	72-ZAHN RATSCHEN MIT 1/4" MIT INBUSEINSÄTZEN	0.35	6	36	1008	18,80€
54031	72-ZAHN RATSCHEN MIT 1/4" MIT 12-KANT-EINSÄTZEN	0.35	6	36	864	19,30€



54028 - 54029	10, 11, 12, 13, 14, 15, 16, 17, 18, 19mm
54030 - 54031	4, 5, 6, 7, 8, 9, 10, 11, 12, 13mm

72-ZAHN RATSCHEN

Verchromte

REF.	BESCHREIBUNG					€
54022	1/4" 72-VERCHROMTE ZAHNRATSCHEN 145 MM	0.15	12	36	1440	9,95€
54023	3/8" 72-VERCHROMTE ZAHNRATSCHEN 200MM	0.30	12	24	1440	13,50€
54024	1/2" 72-VERCHROMTE ZAHNRATSCHEN 255MM	0.60	12	24	960	17,90€



IM AUSSTELLER MIT 12 STÜCK



Verzinkte

REF.	BESCHREIBUNG					€
54018	1/4" VERZINKTE 72-ZAHN-RATSCHEN 145MM	0.15	12	36	1440	9,85€
54019	1/2" VERZINKTE 72-ZAHN-RATSCHEN 255MM	0.60	12	24	864	17,90€
54021	3/8" VERZINKTE 72-ZAHN-RATSCHEN 200MM	0.60	12	24	1440	13,50€



IM AUSSTELLER MIT 12 STÜCK



72-ZAHN RATSCHEN

REF.	BESCHREIBUNG					€
54083	GERADE RATSCHEN MIT 72 ZÄHNEN - 1/4"	0.14	12	24	2592	9,75€
54084	GERADE RATSCHEN MIT 72 ZÄHNEN - 3/8"	0.30	12	24	1440	13,10€
54085	GERADE RATSCHEN MIT 72 ZÄHNEN - 1/2"	0.60	12	24	960	17,80€



IM AUSSTELLER MIT 12 STÜCK



KURZE 72-ZAHN RATSCHEN

REF.	BESCHREIBUNG					€
54086	KURZE RATSCHEN MIT 72 ZÄHNEN 1/4"	0.10	12	24	2592	9,25€
54087	KURZE RATSCHEN MIT 72 ZÄHNEN - 1/2"	0.50	12	24	1008	17,30€



IM AUSSTELLER MIT 12 STÜCK



HANDWERKZEUGE

52197

36,30€

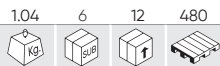

1/2" RATSCHKE VERLÄNGERBAR 72-ZAHN

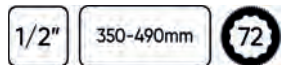

AUSSTELLER MIT 6 STÜCK

52207

24,20€



1/4" RATSCHKE 72-ZAHN - VERZINKT 85MM



IM AUSSTELLER MIT 12 STÜCK

72-ZAHN GELENK-RATSCHKE

REF.							€
52587	1/4" 172mm	0.16	12	144	3456		39,90€
52588	1/2" 172mm	0.17	12	144	3456		45,00€



IM AUSSTELLER MIT 12 STÜCK



72-ZAHN GELENK-RATSCHKE

REF.							€
51305	1/2" 175mm	0.31	12	48	816		28,90€
51306	1/4" 165mm	0.30	12	48	816		28,10€



IM AUSSTELLER MIT 12 STÜCK



72-ZAHN RATSCHKE MIT DREHKOPF

REF.							€
51405	1/4" 145mm	0.58	12	24	-		21,10€
51406	1/2" 280mm	0.66	12	24	864		29,20€



IM AUSSTELLER MIT 12 STÜCK



TELESKOP 72-ZAHN RATSCHKE

REF.							€
51307	1/2" 305-445mm	0.92	6	12	360		29,70€
53346	1/4" 150-200mm	0.25	6	12	-		18,00€
54304	1/2" 450-610mm	1.15	-	6	480		26,00€



AUSSTELLER MIT 6 STÜCK



GELENK-RATSCHKE LANG 72-ZAHN

REF.	BESCHREIBUNG						€
53886	1/4" 305mm	0.27	10	40	1680		20,30€
53887	3/8" 457mm	0.68	10	20	700		30,30€
53888	1/2" 609mm	1.27	4	16	480		37,90€



ERSTAZTEILSATZ

REF.	"						€
15147	3/8"	0.10	-	100	-		5,00€
15148	1/2"	0.20	-	100	-		5,00€

RATSCHKE LANG 72-ZAHN

REF.	BESCHREIBUNG						€
53883	1/4" 305mm	0.27	10	40	1680		18,40€
53884	3/8" 457mm	0.61	10	20	700		30,20€
53885	1/2" 609mm	1.25	4	16	480		35,70€



REF.	"						€
15149	1/4"	0.05	-	100	-		5,00€

51801 62,00€



3/8" RATSCH FLEXIBEL 72-ZAHN LANG 500MM



BESONDERS BEQUEM FÜR SCHWER ZUGÄNLICHE STELLEN

KNÜPPELSTEUERUNG

ROTATIONS KOPF



53671 41,00€



SET MIT 3 MINI-RATSCHEN 1/4" 1/2" 3/8"

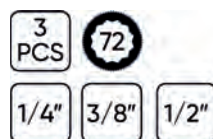

REPARATUR SET FÜR RATSCHENSCHLÜSSEL

REF.	BESCHREIBUNG					€
15138	1/4"	0.10	-	50	-	10,50€
15139	3/8"	0.15	-	50	-	12,00€
15140	1/2"	0.20	-	50	-	13,50€

54339 273,00€



DIGITALER DREHMOMENTSCHLÜSSEL 1/2" 10-200NM



N

52913 292,00€



DREHMOMENTSCHLÜSSEL MIT AUSTAUSCHKÖPFEN

1/2"

	x1	1/2"
	x9	13, 14, 15, 17, 19, 22, 24, 27, 30mm
	x1	40-200Nm

- Einschließlich Werkskalibrierungszertifikat.



54269 56,00€



21-TEILIGER SATZ MIT DYNAMOMETRISCHEM 1/4 ZOLL-SCHLÜSSEL

1/4" N

	x1	5-25Nm		x3	PH1, PH2, PH3
	x1	100mm		x8	H2, H2.5, H3, H4, H5, H6, H8, H10 (37mmL)
	x1	UNIVERSAL		x1	H5 (87mmL)
	x1	1/4" (F) - 3/8" (M)		x5	T10, T15, T20, T25, T30



53972

550,00€



DREHMOMENTSCHLÜSSEL 3/4"



200-800Nm
21.4-86.6M.Kg

1000-1210mm



- Einschließlich Werkskalibrierungszertifikat.

DREHMOMENTSCHLÜSSEL MIT ANZEIGE

REF.	BESCHREIBUNG						€
53081	1/4" 4-20NM (36T) 375mm	1.10	5	25	350	115,00€	
53082	1/2" 40-210NM (24T) 560mm	1.90	4	8	168	148,00€	

- Einschließlich Werkskalibrierungszertifikat.



DREHMOMENTSCHLÜSSEL

REF.	BESCHREIBUNG						€
51127	1/2" 28-210NM 470mm	1.70	4	8	256	56,00€	
51262	1/4" 5-25NM 270mm	0.80	4	16	384	51,00€	
51338	3/8" 19-110NM 365mm	1.05	4	16	384	53,00€	



REPARATUR SETS

REF.	"						€	REF.	"						€	REF.	"						€
51127R	1/2"	0.15	-	20	-	14,00€		51262R	1/4"	0.05	-	20	-	14,00€		51338R	3/8"	0.05	-	20	-	14,00€	



51830

94,00€

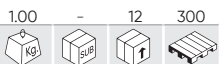

DREHMOMENTSCHLÜSSEL - MECHANISCH

- Genauigkeit: Im Uhrzeigersinn: ± 4%
- Arbeitsbereich: 2 ~ 10 Nm
- Arbeit: Nm, PSI
- Länge (mm): 242mm
- Anschluss: 1/4"
- Dienstzeit: 2000 Zyklen

- Einschließlich Werkskalibrierungszertifikat.

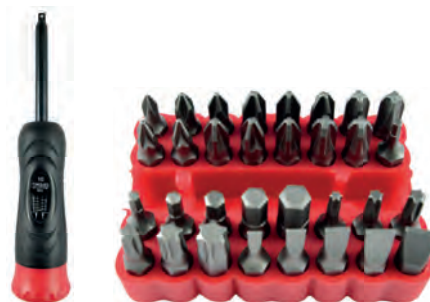

SCHIEBEGRIFF

REF.	BESCHREIBUNG					€
53468	1/2" 250mm	0.35	6	48	600	8,50€
53478	1/4" 115mm	0.50	5	100	1200	4,55€
53479	3/8" 200mm	0.15	5	50	300	6,40€
53480	3/4" 460mm	1.35	5	10	440	19,90€
53481	1" 550mm	2.85	-	5	300	27,40€



GELENKGRIFF

REF.	BESCHREIBUNG						€
52524	3/4" 1020mm	3.60	3	6	144		51,00€
52526	1/2" 600mm	1.65	5	10	600		28,40€
52525	1/2" 430mm	0.85	10	20	1500		13,80€



ERSTAZTEILSATZ

REF.	"					€
11945	1/2"	0.15	25	100	-	7,00€

FÜR 52526

REF.	"					€
11946	1/2"	0.06	25	300	-	4,50€

FÜR 52525

REF.	"					€
11947	3/4"	0.51	10	40	960	19,00€

FÜR 52524



54343 31,00€

1.15 - 6 594

1/2" 450-600mm

1/2" AUSZIEHBARER GELENKGRIFF 450-600MM

51479 31,80€

0.65 12 24 1056

1/2" 260-410mm

VERLÄNGERUNG 1/2" ABGERUNDET

IM AUSSTELLER MIT 12 STÜCK

51805 17,00€

0.33 4 20 640

SET VERLÄNGERUNGEN 1/4" ABGERUNDET

1/4" 50, 75, 100, 152, 227mm

51447 16,00€

0.34 5 20 960

SET VERLÄNGERUNGEN 1/4" ABGERUNDET

1/4" 50, 75, 100, 152, 227mm

51448 52,00€

2.38 - 5 300

SET VERLÄNGERUNGEN 1/2" ABGERUNDET

1/2" 50, 125, 250, 380, 510mm

ERSATZTEIL VERFÜGBAR

REF.	mm				€
12995	50	0.03	5	100	7,00€
12996	75	0.04	20	100	7,00€
12997	100	0.06	20	100	7,50€
12998	152	0.08	5	100	9,00€
12999	227	0.11	5	100	9,50€

ERSATZTEIL VERFÜGBAR

REF.	mm				€
14026	50	0.03	10	100	5,50€
14027	75	0.04	-	50	5,60€
10264	100	0.05	10	100	2,00€
14029	152	0.07	-	50	8,50€
14030	227	0.11	-	50	9,50€

ERSATZTEIL VERFÜGBAR

REF.	mm				€
14978	50	0.10	5	100	7,50€
14979	125	0.20	5	50	9,00€
14980	250	0.40	5	25	13,00€
14981	380	0.60	5	20	22,50€
14982	510	0.60	5	10	27,50€

54302 11,50€

0.45 10 40 650

SATZ VON 6 PRÄZISIONSSCHRAUBENDREHERN

6 PCS CrV

x3 PH00, PH0, PH1
x3 SL2, SL3, SL4

HANDWERKZEUGE

52500

19,00€

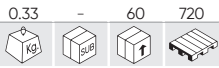

SET SCHRAUBENZIEHER KURZ 8 TEILE

8 PCS



ENTHALTEN

- ⊕ x3 PH00x25, PH0x25, PH1x25
- ⊖ x5 SL0.4x2x25, SL0.4x2.5x25, SL0.5x3x.25, SL0.5x3.5x25, SL0.8x4x25

53917

9,00€

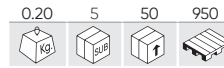

SET SCHRAUBENZIEHER KURZ 7 TEILE

7 PCS



ENTHALTEN

- ⊕ x3 PH00, PH0, PH1
- ⊖ x4 SL.1.4, SL2.0, SL.2.4, SL3.0

53694

18,40€

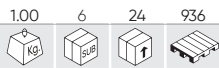

SCHLAG-SCHRAUBENDREHER 1/2", 8 IN 1

8 PCS CrV 1/2"



ENTHALTEN

- ⊕ x1 1/2"
- ⊖ x1 1/2" - 8mm
- ⊕ x3 PH 2x36mm, 3x36mm, 3x70mm
- ⊖ x3 SL 7x36mm, 8x36mm, 8x70mm

54126

39,00€

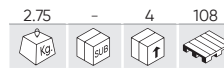

SATZ VON SCHLAGSCHRAUBENDREHERN

12 PCS GO-THROUGH



ENTHALTEN

- ⊕ x6 PH0x75mm, PH1x75mm, PH2x38mm, PH2x100mm, PH3x125mm, PH4x200mm
- ⊖ x6 SL3.2x75mm, SL5x75mm, SL6x38mm, SL6x100mm, SL8x150mm, SL9.5x200mm

53010

18,00€

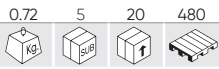

SCHRAUBENZIEHER MIT WECHSELGRIFF 20 IN 1

11 PCS



ENTHALTEN

- ⊕ x2 PH1, PH2
- ⊖ x2 4x6, 5x7mm
- ⊕ x3 T10x15, T20x25, T30x40
- ⊖ x3 H4x4mm, H5x5mm, H6x6mm
- x1

50902

13,00€

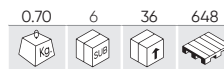

SET FLACH-SCHRAUBENZIEHER, 4 STÜCK

4 PCS 3", 4", 6", 8"



SCHRAUBENDREHER SET IN MODUL MIT KOHLEFASER FINISH

53943

21,50€

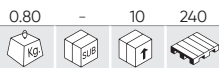

- ⊕ PH4x200, PH3x150, PH2x100, PH2x38, PH1x80, PH0x120, PH1x100

53944

19,50€

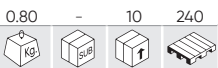

- ⊖ SL9x200, SL4x125, SL5x100, SL5x80, SL6x38, SL6x100, SL8x150mm

53945

18,90€

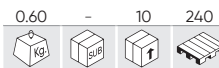

- ⊕ T8x75, T9x75, T10x75, T15x75, T20x75, T25x100, T27x100

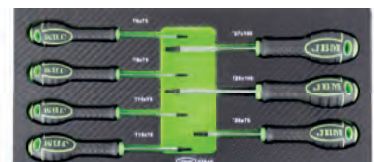
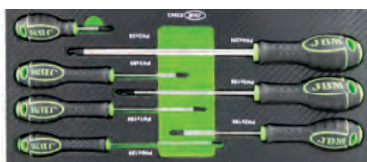

54060 6,00€

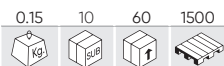

UMKEHRBARER SCHRAUBENDREHER MIT FLACHEN EINSÄTZEN PHILLIPS 6X150MM



54061 6,00€

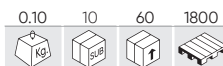

UMKEHRBARER SCHRAUBENDREHER MIT FLACHEN EINSÄTZEN PHILLIPS 6X100MM

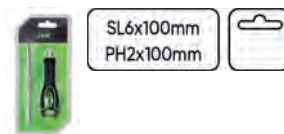

54071 26,50€



SATZ VON 6 DURCHSTECKSCHRAUBENDREHERN (3 KREUZSCHRAUBENDREHERN + 3 FLACHSCHRAUBENDREHERN)



ENTHALTEN

- ⊕ x3 PH3x150, PH2x100, PH1x75mm
- ⊖ x3 SL8x150, SL6.5x100, SL5.5x75mm

54070 18,00€



SATZ VON 6 SCHRAUBENDREHERN (2 KREUZSCHRAUBENDREHERN + 4 FLACHSCHRAUBENDREHERN)



ENTHALTEN

- ⊕ x2 PH1x80, PH2x100mm
- ⊖ x4 SL6.5x150, SL5.5x125, SL4x100, SL3x80mm

52170 16,00€

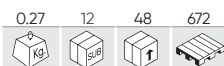

STECKSCHLÜSSEL-HALTER FLEXIBEL 1/4"

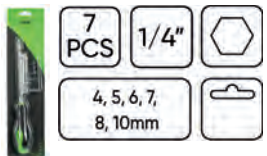

52169 25,00€



SET STECKSCHLÜSSEL FLEXIBEL 6-KANT

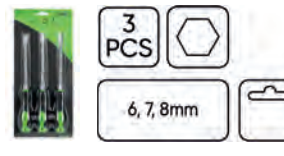

53575 16,00€



STECKSCHLÜSSEL-HALTER FLEXIBEL 1/4" LANG



- x3 1/4" 4 mm
- 5 mm
- 7 mm

HANDWERKZEUGE

53225

3,50€

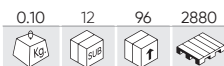

MAGNETISIERER / ENTMAGNETISIERER



51812

46,00€



SET VON ZANGEN IN TASCHE - 5 TEILE



ENTHALTEN

A	x1	160mm
B	x1	160mm
C	x1	180mm
D	x1	200mm
E	x1	250mm

SICHERUNGSRINGE ZANGEN -GERADE



FÜR INNEN

REF.	BESCHREIBUNG					€
51018	7" 180mm	0.14	5	100	1800	7,05€
52964	9" 225mm	0.23	6	60	1440	9,45€
53549	13" 330mm	0.45	5	30	-	14,30€



FÜR AUSSEN

REF.	BESCHREIBUNG					€
51017	7" 180mm	0.17	5	100	1800	6,80€
52966	9" 225mm	0.28	6	60	1800	9,45€
53547	13" 330mm	0.50	5	30	-	14,70€



SICHERUNGSRINGE ZANGEN -GEBOGEN



FÜR INNEN

REF.	BESCHREIBUNG					€
51021	7" 180mm	0.16	5	100	-	7,05€
52965	9" 225mm	0.24	6	60	1440	9,20€
53550	13" 330mm	0.45	5	30	-	14,70€



FÜR AUSSEN

REF.	BESCHREIBUNG					€
51020	7" 180mm	0.13	5	100	1600	6,65€
52967	9" 225mm	0.24	6	60	1440	9,40€
53548	13" 330mm	0.50	5	30	-	15,60€



SEITENSCHNEIDER

REF.	BESCHREIBUNG					€
53905	6" 160mm	0.20	6	60	1440	7,30€
53906	7" 180mm	0.20	6	60	1560	8,65€



SPITZZANGE

REF.	BESCHREIBUNG					€
53908	6" 160mm	0.15	6	60	1440	7,25€
53909	8" 200mm	0.20	6	60	1440	9,70€



KOMBIZANGE

REF.	BESCHREIBUNG						€
53911	6" 160mm	0.20	6	60	1440		8,80€
53967	8" 200mm	0.30	6	60	1440		10,20€
54015	7" 180mm	0.20	6	60	1920		10,20€



15454

35,40€

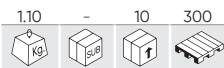

8"

SATZ VON AUSSORTIERTEN EVA-WERKZEUGEN

REF.	BESCHREIBUNG						€
10526	8" GERADE SEEGERRINGZANGE	0.21	5	50	-		10,00€
10642	8" GERADE SEEGERRINGZANGE	0.22	5	50	-		10,00€
10643	8" GEBogene SEEGERRINGZANGE GEBogen	0.21	5	50	-		10,00€
10644	8" GEBogene SEEGERRINGZANGE GEBogen	0.22	5	50	-		10,00€



53389

31,50€

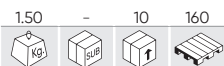

SET SEEGERRINGZANGE AUSWECHSELBARE SPITZEN



WASSERPUMPENZANGE

REF.								€
52052	515mm	140mm	1.88	5	10	400		53,00€
50567	250mm	40mm	0.34	10	60	1500		9,60€



52846

37,80€

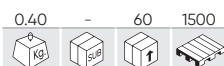

SPITZZANGE EXTRALANG

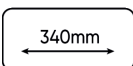

52847

41,00€



SPITZZANGE EXTRALANG 45° SPITZE

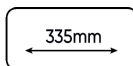

52272

24,60€



SET SPITZZANGEN 0°, 45° UND 90°



HANDWERKZEUGE

53390

34,50€

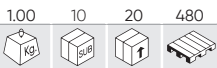

SCHLAUCHKLEMMENZANGE



REF.	BESCHREIBUNG					€
14180	ERSATZTEILSET FÜR 53390	0,01	-	100	-	7,90€

51995

24,50€

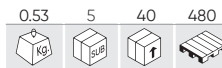

SCHLAUCHKLEMMENZANGE



REF.	BESCHREIBUNG					€
14179	ERSATZTEILSET FÜR 51995	0,01	-	100	-	8,50€

53396

18,30€

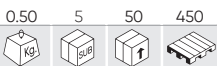

SCELLEN-ZANGE FÜR ABGASANLAGE

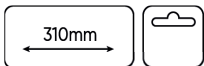

52791

18,00€

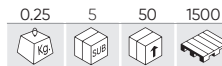

SCELLEN-ZANGE CLIC-R

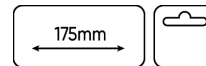

54376

12,00€



CV-GELENKKLEMMER MIT MESSER

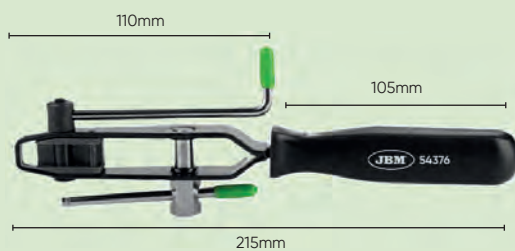

54311

13,00€



SCELLENZANGE - ANTRIEBSWELLE



54330

12,50€



VENTILSCHAFTDICHTUNGSZANGE



OPEL, VW, FORD



54279

6,00€



ZANGE ZUM ENTFERNEN VON AUTOGLÜHBIRNEN



54479

36,50€

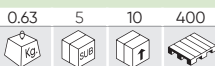

N

ZANGE FÜR SELBSTSICHERNDE METALLBÄNDER



52412

5,00€



MULTIFUNKTIONSZANGE KLAPPBAR 105 MM MIT BITS-SET

ENTHALTEN

- x2 Schraubendreher
- x1 Phillips Schraubendreher
- x1 Dosenöffner
- x1 Korkenzieher
- x1 25 mm Feil
- x1 Sägefeil 40 mm
- x1 Klinge mit Senkung der Rückenlinie 40mm



52050

98,00€



SET FEDERKLEMMZANGEN

ERSATZTEIL VERFÜGBAR

REF.	BESCHREIBUNG	Kg	Sub	Ein	Pa	€
A 13707	FEDERKLEMMZANGE MIT DREHBARER SPITZE (IN SET REF. 52050)	0.25	10	40	-	14,00€
B 13708	FEDERKLEMMZANGE (IN SET REF. 52050)	0.24	6	48	-	14,00€
C 13709	FEDERKLEMMZANGE MIT GERADER SPITZE (IN SET REF. 52050)	0.24	6	48	576	14,00€
D 13710	ZANGE FÜR ELASTISCHE KLAMMERN 45° (IN SET REF. 52050)	0.70	6	48	1536	14,00€
E 13712	ROHRENTFERNUNGSZANGE (IN SET REF. 52050)	0.21	10	40	-	14,00€
F 51995	SCHLAUCHKLEMMZANGE	0.53	5	40	480	24,50€
G 52791	SCELLEN-ZANGE CLIC-R	0.25	5	50	1500	18,00€



52619

23,10€

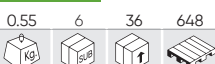

SCELLENZANGE - ANTRIEBSWELLE



Löcher 1/2" in Griffen für den Einsatz als Schlüssel
Öffnung: 0-20mm



52812

65,00€



SCELLENZANGE - ANTRIEBSWELLE



3/8" Innenvertiefung zum Spannen der Ratsche.
Öffnung: 0-34mm



53487

16,70€



ZANGE - KRAFTSTOFFLEITUNG



52508

38,40€



BEISSZANGE FÜR SCHLAUCHSCELLEN



52509

36,20€



ANTIBLOCKIER

52625

9,00€

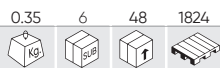

SPEZIALZANGE - TROMMELBREMSE



51355

19,00€

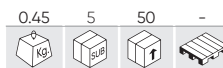

SPEZIALZANGE - AUSWUCHTGEWICHTE



52982

53,00€

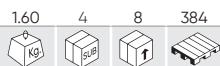

SET GRIPZANGEN EXTRALANG - 3 TEILE



53445

17,10€

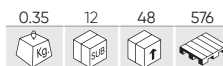

SET ZANGEN - KRAFTSTOFFLEITUNGEN LOSEN



- x1 5/16" Ø 8mm
- x1 3/8" Ø 10mm
- x1 SPEZIELLE ANWENDUNG



51972

12,00€

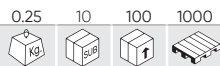

ABISOLIER-ZANGE AUTOMATISCH



0.25~2.5mm²

08-6mm



52152

13,50€

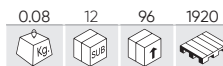

DRAHTSCHERE

ACERO INOXIDABLE
STAINLESS STEEL

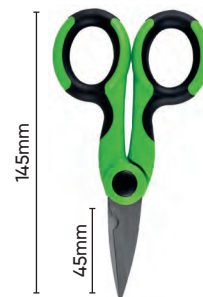

53411

5,00€

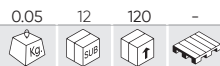

ABISOLIER-ZANGE MINI



53412

4,00€

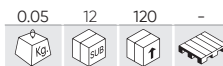

ABISOLIER-ZANGE MINI



KABELSCHNEIDER ZANGE

REF.	BESCHREIBUNG					€
53602	360mm - Ø 125mm ²	0.60	-	5	300	30,50€
53603	550mm - Ø 250mm ²	1.75	-	5	300	45,00€
53604	800mm - Ø 500mm ²	3.70	-	5	120	118,00€



BOLZENSCHNEIDER

REF.	BESCHREIBUNG					€
52955	12" - 300mm	0.77	-	20	200	19,80€
52956	14" - 350mm	0.95	-	20	200	19,60€
52957	18" - 450mm	1.47	-	10	360	23,80€
52958	24" - 600mm	2.40	-	8	210	28,20€
52959	30" - 750mm	3.78	-	5	100	42,00€
52960	36" - 900mm	5.15	-	5	105	46,00€



53385 19,30€

0.15	6	54	1026
------	---	----	------

ZANGE - KAROSSERIEKLAMMERN LOSEN



53976 9,00€

0.20	6	60	1440
------	---	----	------

SPITZZANGE MIT ABISOLIEREN DES DRAHTES 6" - 160MM



52761 8,00€

0.25	12	72	1800
------	----	----	------

KABELSCHUHZANGE FÜR ISOLIERTE UND NICHT ISOLIERTE KLEMMEN 9"

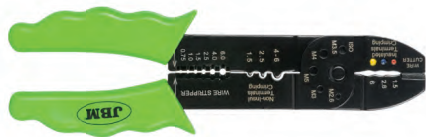

53932 8,00€

0.25	12	72	1296
------	----	----	------

KABELSCHUHZANGE FÜR ISOLIERTE UND NICHT ISOLIERTE KLEMMEN 9"



52762 9,00€

0.25	12	72	1800
------	----	----	------

KABELSCHUHZANGE FÜR NICHT ISOLIERTE KLEMMEN 8" 200MM

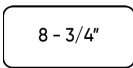

16111 19,20€

0.61	-	10	200
------	---	----	-----

SCHRANKMODUL AUS EVA MIT ABISOLIERWERKZEUG + QUETSCHVERBINDER



54254

43,00€

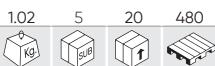

CRIMPZANGE MIT ZWANGSSPERRE UND AUSWECHSELBARER SPITZE

7 PCS

ENTHALTEN

- 9° ZANGE
- 0,15-6 MM° BIT
- 10-35 MM° BIT
- 0,5-6 MM° BIT

- 0,5-10 MM° BIT
- 0,5-4MM° BIT
- SCHRAUBENDREHER PH2X150



54112

18,00€

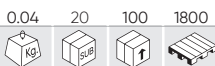

KLEMMENAUSZIEHVORRICHTUNG MIT SECHS ANSCHLÜSSEN

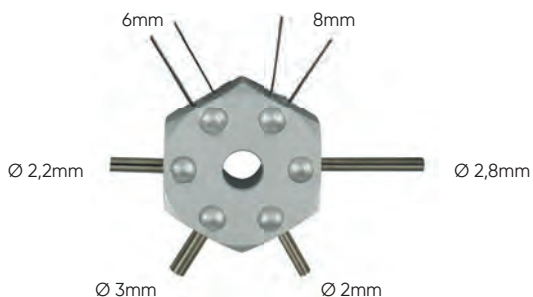

54142

15,20€



NICHT BESCHÄDIGENDER HAKEN, PICKEL- UND BRECHSTANGENSET (6 TEILE)

6 PCS

ENTHALTEN

- 2 Hakenspitzen
- 2 gerade Spitzen
- 2 gewinkelte Spitzen
- 6 Spitzen mit Hebeln



GREIFER FLEXIBEL

REF.	BESCHREIBUNG	Ø	—					€
51525	MAGNETISCHER GREIFER FLEXIBEL	A	7mm	500mm	0.14	10	60 960	9,80€
51526	GREIFER FLEXIBEL 4ER KRALLE	B	20mm	500mm	0.10	12	144 2016	9,80€
52473	LED-GREIFER FLEXIBEL MAGNETISCH	C	15mm	545mm	0.18	10	60 960	9,90€

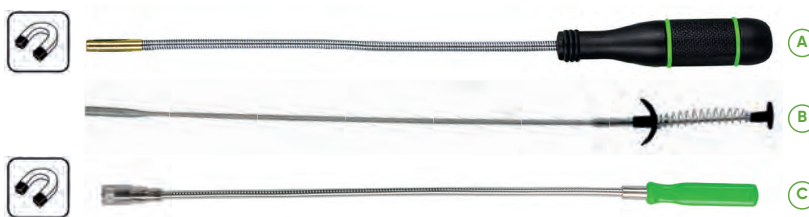

INSPEKTIONSWERKZEUGE

REF.	BESCHREIBUNG	Ø	—					€
51272	MAGNETISCHER GREIFER MIT LED-LICHT	A	18mm	90-810mm	0.05	12	72 1512	7,50€
52472	MAGNETISCHER GREIFER VERLÄNGERBAR	B	10mm	135-600mm	0.15	12	108 4320	4,90€
52468	SPIEGEL SCHWENKBAR VERLÄNGERBAR	C	50mm	280-445mm	0.09	12	48 1536	5,90€



15706

31,00€

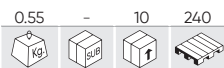

GREIFERMAGNETENSET
- 5 STÜCK



15799

28,30€



HAMMERSORTIMENT
- EVA
KOHLENSTOFFFASER-
MODUL



SCHLÄGEL MIT FASERSCHAFT

REF.	BESCHREIBUNG					€
52182	2Kg - 297mm	2.20	6	12	504	24,00€
52184	4Kg - 880mm	4.31	-	4	128	43,00€
52185	6Kg - 895mm	6.97	-	4	72	55,00€
52186	8Kg - 900mm	8.68	-	2	72	72,00€



NYLON-SCHONHAMMER RÜCKSCHLAGFREI

REF.	BESCHREIBUNG					€
52425	Ø 40mm	0.70	6	12	768	33,30€
52426	Ø 60mm	1.50	2	12	288	52,00€
52427	Ø 70mm	2.02	2	12	204	64,00€



AUSTAUSCHBARER KOPF

REF.	mm					€	REF.	mm					€	REF.	mm					€
11212	Ø 40	0.02	5	100	-	5,00€	11213	Ø 60	0.08	5	50	-	10,60€	11214	Ø 70	0.11	5	50	-	12,50€



SCHLOSSERHAMMER

REF.	BESCHREIBUNG					€
51674	505g	0.60	6	36	864	7,75€
52565	1000g	1.13	6	24	720	11,50€



AUSBEULHAMMER

REF.	BESCHREIBUNG					€
51504	454g	0.55	4	40	800	8,50€
51918	1000g	1.25	6	18	648	12,50€



PROFI SCHONHAMMER RÜCKSCHLAGFREI

REF.	BESCHREIBUNG					€
52180	1,35Kg - 355mm	1.45	6	12	432	19,00€
52181	1,80Kg - 370mm	1.81	6	12	300	22,50€
52183	2,20Kg - 405mm	2.30	6	12	288	26,20€



AXT MIT HOLZSCHAFT

REF.	BESCHREIBUNG					€
52188	360mm	0.82	4	24	875	15,50€
52460	410mm	1.17	4	24	864	16,60€
52461	700mm	2.00	4	12	240	25,70€



52830 24,00€

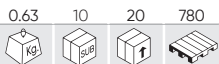

BÜGELSÄGE MIT ERGONOMISCHEM GRIF

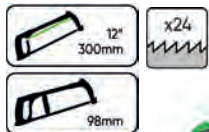

IM AUSSTELLER MIT 10 STÜCK

52831 18,00€

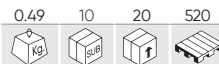

BÜGELSÄGE

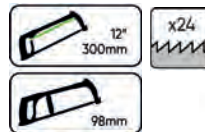

IM AUSSTELLER MIT 10 STÜCK

REF. BESCHREIBUNG

12060 BLATT FÜR BÜGELSÄGE REF.52830 + 52831 + 51675

				€
0.02	100	800	-	2,50€

53591 5,50€

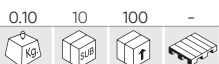

ABISOLIER-MEßER

- Schnittbereich: 8-28mm.
- Länge des Erzeugnisses: 170mm.
- Länge des Sägeblatts: 20mm.
- Hakentiefe: 5mm.



52786 14,60€

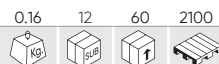

KLAPPMESSER - SICHERHEITSGURTSCHNEIDERUND GLASBRECHER SYSTEM



IM AUSSTELLER MIT 12 STÜCK

ROHRSCHEIDER

REF.	BESCHREIBUNG					€
52878	3-32mm	0.22	10	50	1500	11,20€
52879	3-35mm	0.24	10	50	1500	10,10€
52877	Ø MAX: 42mm	0.43	6	48	624	15,80€
53517	Ø MAX: 30mm	0.13	10	60	600	9,50€



52885 18,00€

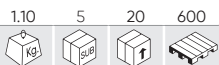

SET AUS 12 LOCHEISEN



3, 4, 5, 6, 7, 8, 9, 10, 12, 14, 16, 19mm



54331

27,00€



N

SATZ MIT 3 PROFESSIONELLEN SCHNEIDWERKZEUGEN



	KLINGENGRÖSSE	KLINGENGRÖSSE	LÄNGE	GEWICHT
A	x4	60x19mm	175mm	115,5g
B	x1	100x10mm	160mm	129,7g
C	x4	60x19mm	175mm	115,5g



ERSATZTEIL VERFÜGBAR

REF.	BESCHREIBUNG				€
16342	SATZ MIT 10 SCHNEIDKLINGEN FÜR REF. 54331	0.01	10	100	2,50€
16343	SATZ MIT 10 TRAPEZFÖRMIGEN SCHNEIDEKLINGEN FÜR REF. 54331	0.01	10	100	2,50€

51909

2,46€

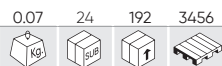

TEPPICHMESSER CUTTER



IM AUSSTELLER MIT 24 STÜCK



ERSATZTEIL VERFÜGBAR

REF.	BESCHREIBUNG				€
16642	SATZ MIT 10 SCHNEIDKLINGEN FÜR REF. 51909	0.01	10	100	1,00€

MEISSEL

REF.	BESCHREIBUNG					€
53120	150mm	0.35	6	24	1200	6,00€
53121	250mm	0.55	6	24	864	7,35€
53122	350mm	0.90	6	12	720	9,50€



ACERO 45C

53083

64,00€

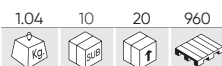

MEISSEL SET - 4 TEILE

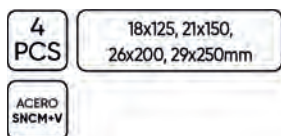

54089

17,50€



SATZ VON LANGEN SCHLOSSERMEISSELN



ERSATZTEIL VERFÜGBAR

REF.	mm				€
15783	155x10	0.09	6	24	3,50€
15784	155x11	0.09	6	24	3,50€
15785	155x12	0.09	6	24	3,50€
15786	155x14	0.09	6	24	3,50€
15787	155x16	0.09	6	24	3,50€



53095

20,50€

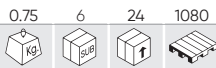

SATZ SPLINTTREIBER, 6 TEILE



54099

13,80€

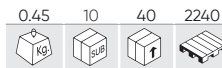

SET SPLINTTREIBER, 5 TEILE

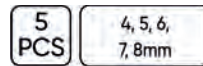

15737

45,00€

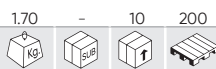

MEISSEL UND SPLINTENTREIBER MODUL MIT KOHLEFASER-FINISH



52049

14,00€

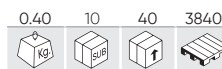

SET DURCHSCHLÄGER



13667

17,60€

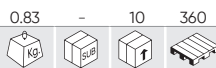

SCHRANKMODUL AUS EVA



53993

77,00€



MEHRZWECKGELENKNIETHAMMER

- 360° drehbarer Kopf
- Kompakt, erlaubt einfach, in kleinen Räumen zu arbeiten
- Der Aufbau ermöglicht die Arbeit mit einer Hand

ENTHALTEN

- Standardnietdüsen 2,4 mm (3/32") - 3,2 mm (1/8") - 4,0 mm (5/32") - 4,8 mm (3/16")
- Lochdörner für Nietmuttern M3x0, 5 - M4x0, 7 - M5x0, 8 - M6x1
- Lochdörner für Nieten M6x1 - M5x0, 8 - M4x0, 7
- 3 Schraubenschlüssel 5, 5x8,5 mm - 12x17 mm - 15x19 mm
- Spindelhalter M6x1 - M5x0, 8 - M4x0, 7 - M3x0, 5



52596

114,00€

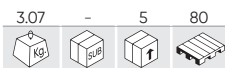

MUTTERN NIETZANGE 400MM / 16"



52597

146,00€



MUTTERN NIETZANGE, AUTOMATISCH 440MM / 17"



ERSATZTEILE 52595, 52596, 52597

REF.	BESCHREIBUNG				€
13226	M3	0.03	-	100	4,50€
13227	M4	0.04	20	100	4,50€
13228	M5	0.04	20	100	4,50€
13229	M6	0.04	20	100	4,50€

REF.	BESCHREIBUNG				€
13230	M8	0.04	20	100	4,50€
13231	M10	0.05	-	100	4,50€
13232	M12	0.05	-	100	4,50€



52463

26,10€

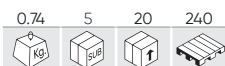

NIETZANGE 300MM / 12"



52464

42,00€



NIETZANGE 400MM/16"

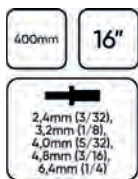

53331

31,80€

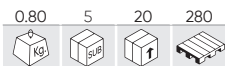

DRUCK-NIETZANGE 10" 250MM

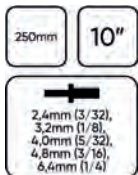

53332

34,50€

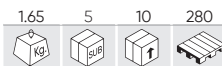

SCHEREN-NIETZANGE 8" 200MM

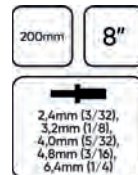

HANDWERKZEUGE

52595

64,00€

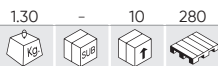

MUTTERN NIETZANGE KOMPAKT 200MM / 8"

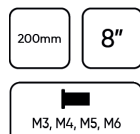

52462

25,30€



NIETZANGE KOMPAKT 200MM / 8"



52609

29,00€

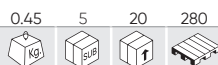

NIETZANGE + KUNSTSTOFF-NIETE

Ø 6,6mm x 17,2mm (10u.)
Ø 6,3mm x 25,2mm (10u.)
Ø 5mm x 17,2mm (10u.)
Ø 5mm x 15,8mm (10u.)



ERSATZTEIL VERFÜGBAR

REF.	Ø					€
13674	6x19,3mm	0,04	25	2500	0,50€	
13675	6x17,8mm	0,01	25	500	0,50€	
13676	6x25,5mm	0,01	100	1000	0,50€	
13677	6x24,5mm	0,03	25	1000	0,50€	
13678	6x24mm	0,01	25	1000	0,50€	

52575

119,00€

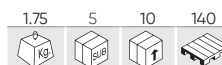

DRUCKLUFT NIET-PISTOLE



- Kraft: 1586 PSI / 720 kp.
- Länge: 9/16 " - 14 mm.
- Max. 60 Fuß IB / 23-69 NM.
- Luftverbrauch: 0,03 ft3 min / 0,86 l/min.
- Luftzufuhr: 1/4 ".

ENTHALTEN

- Dichtringe - Sicherheitsdeckel für Sammlung der Abfälle von Nieten
- 2 Mehrfunktionswerkzeuge
- Schnell auswechselbarer Bauteil



WASSERWAAGEN

ALU-GEHÄUSE

REF.	BESCHREIBUNG					€
53613	500mm	0.55	5	30	1260	19,50€
53614	600mm	0.60	5	30	840	21,50€
53615	800mm	0.85	5	20	600	34,60€



ALU-GEHÄUSE MIT MAGNET

REF.	BESCHREIBUNG					€
53616	500mm	0.30	5	60	1260	10,40€
53617	600mm	0.30	5	60	840	9,25€
53618	800mm	0.35	5	30	600	13,90€

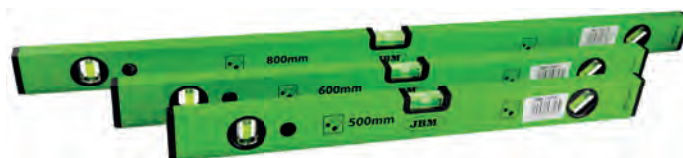

PRÄSENTIERBOX

REF.					€
14183	0.80	-	10	-	31,00€



BANDMASS

REF.	BESCHREIBUNG					€
53025	3m x 16mm	0.13	12	48	2016	3,50€
53026	5m x 25mm	0.26	12	48	2016	5,80€
53027	7,5m x25mm	0.40	12	48	1500	9,00€



IM AUSSTELLER MIT 12 STÜCK

52433 4,80€

0.10	10	50	1820

LEHREN-SET-20 (0.05-1.0 MM)

0,05-1mm



52638 9,95€

0.35	5	50	1800

LOCHZANGE

Ø 2, 2.5, 3, 3.5, 4, 4.5mm



52318 73,00€

0.64	6	24	336

STURZMESSGERÄT MIT MAGNETFUSS

-6° / +6°



52904 61,00€

2.00	-	5	175

TIEFENMESSSCHIEBER MIT MAGNETISCHEM FUSS

REF.	BESCHREIBUNG					€
13704	TIEFENMESSSCHIEBER FÜR REF.52904	0.10	-	50	1500	21,00€



SCHIEBLEHRE 150MM

REF.				€
50724	0.30	5	50	28,00€
50937	0.24	10	50	10,50€



50724 DIGITAL
50937 MECHANISCh

TIEFENMESSSCHIEBER

REF.				€
52873	0.04	5	300	11,00€
53042	0.05	10	100	9,90€



52873 MECHANISCh
53042 DIGITAL

WINKELMESSER

REF.				€
52583	0.20	4	48	8,50€
52794	0.48	6	24	28,00€



52583
52794 MAGNETISCH

HANDWERKZEUGE

51951

15,60€

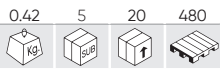

STEMMSPICHEL -3TLG



53339

9,50€

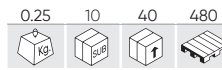

KARROSSERIESPACHTEL-SET



53589

12,00€

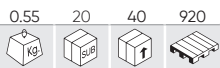

INDUSTRIELLEN HEFTER



Heftklammerhöhe: 4-14 mm



52700

20,50€

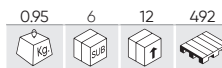

ROHR-BÖRDEL SET

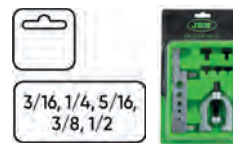

REF.	BESCHREIBUNG					€
14167	1000 HEFTKLAMMERN FÜR REF. 53589 (11,3X0,7X8 MM)	0.10	50	100	-	2,50€

51853

18,00€

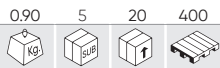

SATZ AUS 5 STAHLFEILEN



52760

4,10€

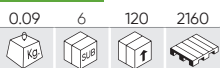

DRAHTBÜRSTE



52515

9,10€



DRAHTBÜRSTE



52905

28,00€



ROHRBIEGER 6-8-10 MM



GRAD MARKIERT

ALUMINIUM-, KUPFER- UND STAHLROHRE

WERKSTATT AUSRÜSTUNG

- 72 WERKZEUG-WAGEN
- 83 WERKZEUG-MODULE
- 90 ZUBEHÖR/ERSATZELEMENTE
- 93 ARBEITSTISCHE
- 95 LAGER
- 99 HOCKER/ROLLWAGEN
- 100 AMBOSSE/SCHRAUBSTÖCKE



54327

2.788,00€

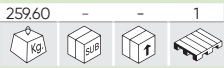

N

MODULARES WERKSTATTMÖBEL-SET (18 TEILE)



MOBILER SCHRANK MIT 6 SCHUBLADEN UND GUMMIAUFLAGE

MASSE

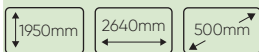

QUADRAT LÖCHER FÜR HAKEN

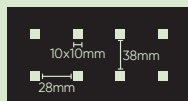

KONKRETE MASSNAHMEN

	A	B	C	D	E	F	G
HÖHE	1890mm	340mm	340mm	38mm	900-950mm	750-880mm	900-950mm
LÄNGE	600mm	680mm	680mm	2040mm	680mm	666mm	680mm
BREITE	500mm	280mm	25mm	500mm	500mm	460mm	500mm

INNENMASSE

	A1	B1	E1	E2	E3	F1	F2	G1
HÖHE	1890mm	340mm	58mm	136mm	216mm	58mm	137mm	715mm
LÄNGE	600mm	680mm	567mm	567mm	567mm	567mm	567mm	596mm
BREITE	500mm	280mm	408mm	408mm	408mm	408mm	408mm	475mm

WERKZEUGPLATTEN SIND MIT UNSEREN HAKEN KOMPATIBEL: REF.16354, 16355, 16356, 16357



WERKZEUG NICHT ENTHALTEN

ERSATZTEILE UND ZUBEHÖR

REF.	BESCHREIBUNG					€
16490	HOCHSCHRANK (ART. 54327)	56.20	-	1	-	650,00€
16491	ECKSCHRANK 800X800X338MM (ART.54327)	22.00	-	1	-	307,00€
16492	ECKSCHRANK MIT MDF-PLATTE (REF.54327)	59.40	-	1	-	675,00€
16493	SCHRANK MIT 3 SCHUBLADEN MIT PAPIERROLLENHALTER (ART. 54327)	41.20	-	1	-	436,00€
16494	WANDSCHRANK (ART. 54327)	10.40	-	1	-	139,00€
16496	MDF-PLATTE 1360X500X38MM (ART. 16627/16628/16500)	19.40	-	1	-	127,00€
16497	MDF-PLATTE 680X500X38MM (ART. 16627/16628/16500)	9.80	-	1	-	77,00€
16498	3-TLG. STECKTAFEL-SET 680X338X25MM (ART.54327)	6.00	-	1	-	84,00€
16499	6-TLG. STECKTAFEL-SET 775X338X25MM (ART.54327)	13.00	-	1	-	162,00€
16500	SCHRANK MIT 2 TÜREN (ART.54327)	33.60	-	1	-	463,00€
16516	4-TLG. STECKTAFEL-SET FÜR DEN ECKSCHRANK (ART. 16492)	9.20	-	1	-	121,00€
16561	STÜTZSTANGE (ART.54327)	7.80	-	4	-	36,50€
16627	4-SCHUBLADEN-SCHRANK (REF.54327)	43.50	-	1	-	225,00€
16628	6-SCHUBLADENSCHRANK (REF.54327)	49.00	-	1	-	382,00€
16629	ARBEITSTISCH MDF 2040X500X38MM (REF.54327)	27.80	-	1	-	419,00€
16600	EDELSTAHLTAFEL 2040 X 500 MM (REF.54327)	33.00	-	1	-	252,00€



WERKZEUGWAGEN MIT 12 FÄCHER

53939 1.280,00€

98.70 - 1 4

EVA-WERKZEUGEN

172 PCS

INNENMASSE, 1. SPALTE

A KLEINE SCHUBLADEN (X4)



B MITTLERE SCHUBLADE (X1)



C GROSSE SCHUBLADE (X1)



MASSE



53868 1.090,00€

83.50 - 1 4

LEEREN

172 PCS

INNENMASSE, 2. SPALTE

D KLEINE SCHUBLADEN (X4)



E MITTLERE SCHUBLADE (X1)



F GROSSE SCHUBLADE (X1)



QUADRAT LÖCHER FÜR HAKEN

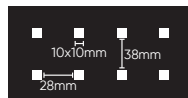

SORTIERTE EVA-WERKZEUGSÄTZE:

53708 325,00€

15.20 - 1 20

WERKZEUG-SORTIMENT 4 MODULE IN EVA KOHLEFASER-FINISH

ENTHALTEN

REF.	Box	Box	Box	€
14296	6.05	4	80	118,00€
14297	3.30	4	96	87,00€
14298	2.10	4	96	51,50€
14299	3.25	4	96	87,00€

14296



14297

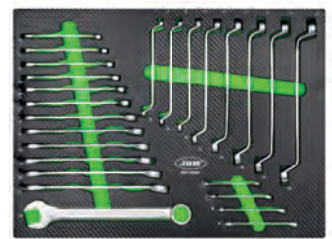

14298



14299



FÜR WEITERE INFORMATIONEN

SEITE 83



WERKZEUGWAGEN XL KIPPSICHER 7 SCHUBLADEN

53912 1.280,00€

74.50 - - 4

EVA-WERKZEUGEN

199 PCS XL

53869 990,00€

74.50 - 1 4

LEEREN

199 PCS XL

53913 1.280,00€

74.50 - - 4

EVA-WERKZEUGEN

199 PCS XL

53870 990,00€

74.50 - 1 4

LEEREN

199 PCS XL



INNENMASSE

KLEINE SCHUBLADEN (X5)

74mm 705mm 400mm 25Kg

GROSSE SCHUBLADEN (X2)

151,5mm 705mm 400mm 35Kg

QUADRAT LÖCHER FÜR HAKEN

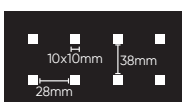

MASSE

984mm 980mm 510mm



SORTIERTE EVA-WERKZEUGSÄTZE:

ENTHALTEN

REF.				€
14296	6.05	4	80	118,00€
14297	3.30	4	96	87,00€

REF.				€
14298	2.10	4	96	51,50€
14299	3.25	4	96	87,00€

REF.				€
15122	1.70	10	200	74,00€
15155	2.45	10	180	59,00€

REF.				€
15161	2.10	10	180	62,00€
15514	0.05	10	360	9,35€

14296

ERSATZTEILE VERFÜGBAR

15122

ERSATZTEILE VERFÜGBAR

14297

ERSATZTEILE VERFÜGBAR

15161

ERSATZTEILE VERFÜGBAR

14298

ERSATZTEILE VERFÜGBAR

15155

ERSATZTEILE VERFÜGBAR

14299

ERSATZTEILE VERFÜGBAR

15514

WERKZEUGWAGEN 7 SCHUBLADEN - GRÜN

172 PCS 300Kg

N

54389 790,00€

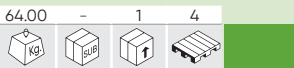

EVA-WERKZEUGEN

54503 490,00€

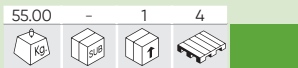

LEEREN

INNENMASSE

KLEINE SCHUBLADEN (X5)



GROSSE SCHUBLADEN (X2)



SCHUBLADENLADEKAPAZITÄT: 35KG.
GESAMTLADEKAPAZITÄT: 300KG.

MASSE

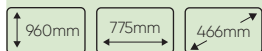

QUADRAT LÖCHER FÜR HAKEN

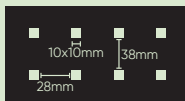

SORTIERTE EVA-WERKZEUGSÄTZE:

53708

325,00€



WERKZEUG-SORTIMENT 4 MODULE IN EVA KOHLEFASER-FINISH

ENTHALTEN

REF.	Kg	Sub	Q	€
14296	6.05	4	80	118,00€
14297	3.30	4	96	87,00€
14298	2.10	4	96	51,50€
14299	3.25	4	96	87,00€

14296



ERSATZTEILE VERFÜGBAR



14297



ERSATZTEILE VERFÜGBAR

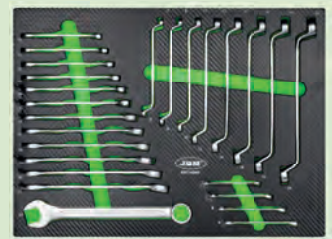

14298



ERSATZTEILE VERFÜGBAR



14299



ERSATZTEILE VERFÜGBAR



FÜR WEITERE INFORMATIONEN

SEITE 83

WERKZEUGWAGEN MIT 7 FÄCHER

53661 790,00€

65.50 - 1 4

EVA-WERKZEUGEN

53761 490,00€

52.50 - 1 4

LEEREN

53767 790,00€

56.00 - 1 4

EVA-WERKZEUGEN

53768 490,00€

56.00 - 1 4

LEEREN

53686 790,00€

65.00 - 1 4

EVA-WERKZEUGEN

53762 490,00€

55.50 - 1 4

LEEREN

53904 790,00€

65.00 - 1 4

EVA-WERKZEUGEN

54006 490,00€

55.00 - 1 4

LEEREN

INNENMASSE

KLEINE SCHUBLADEN (X5)



GROSSE SCHUBLADEN (X2)



SCHUBLADENLADEKAPAZITÄT: 30KG.
GESAMTLADEKAPAZITÄT: 70KG.

MASSE



QUADRAT LÖCHER FÜR HAKEN

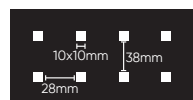

172 PCS 280Kg



SORTIERTE EVA-WERKZEUGSÄTZE:

53708 325,00€

15.20 - 1 20

WERKZEUG-SORTIMENT 4 MODULE IN EVA KOHLEFASER-FINISH

ENTHALTEN

REF.	Kg	1	4	€
14296	6.05	4	80	118,00€
14297	3.30	4	96	87,00€
14298	2.10	4	96	51,50€
14299	3.25	4	96	87,00€

14296



ERSATZTEILE VERFÜGBAR



14297



ERSATZTEILE VERFÜGBAR



14298



ERSATZTEILE VERFÜGBAR



14299



ERSATZTEILE VERFÜGBAR



FÜR WEITERE INFORMATIONEN

SEITE 83



WERKZEUGWAGEN MIT 7 SCHUBLADEN, SPEZIELL FÜR LKW

54240 1.887,00€

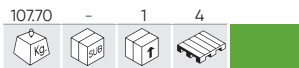

EVA-WERKZEUGEN

54237 1.887,00€



EVA-WERKZEUGEN

54238 1.887,00€



EVA-WERKZEUGEN

54239 1.887,00€

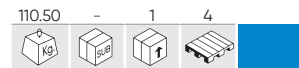

EVA-WERKZEUGEN

INNENMASSE

KLEINE SCHUBLADEN (X5)



GROSSE SCHUBLADEN (X2)



SCHUBLADENLADEKAPAZITÄT: 30KG.
GESAMTLADEKAPAZITÄT: 70KG.

MASSE

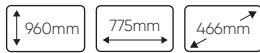

QUADRAT LÖCHER FÜR HAKEN

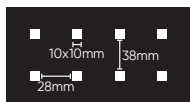

SORTIERTE EVA-WERKZEUGSÄTZE:

54134

1.415,00€

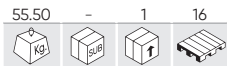

LKW-REPARATUR-WERKZEUGSATZ

ENTHALTEN

REF.	Box	Box	Pallet	€
15730	10.22	2	48	289,00€
15731	5.20	2	48	214,00€

REF.	Box	Box	Pallet	€
15732	6.40	2	48	293,50€
15733	3.55	2	48	113,00€

REF.	Box	Box	Pallet	€
15734	9.40	2	48	288,50€
15735	10.00	2	48	152,00€

REF.	Box	Box	Pallet	€
15736	14.80	2	40	488,50€

15730

ERSATZTEILE VERFÜGBAR

15731

ERSATZTEILE VERFÜGBAR

15732

ERSATZTEILE VERFÜGBAR

15733

ERSATZTEILE VERFÜGBAR

15734

ERSATZTEILE VERFÜGBAR

15735

ERSATZTEILE VERFÜGBAR

15736

ERSATZTEILE VERFÜGBAR

FÜR WEITERE
INFORMATIONEN

SEITE 84



WERKZEUGWAGEN MIT 7 FÄCHER, SPEZIAL ELEKTRO

54236 1.856,00€

67.70 - 1 4

EVA-WERKZEUGEN

54233 1.856,00€

67.70 - 1 4

EVA-WERKZEUGEN

54234 1.856,00€

67.70 - 1 4

EVA-WERKZEUGEN

54235 1.856,00€

67.70 - 1 4

EVA-WERKZEUGEN

INNENMASSE

KLEINE SCHUBLADEN (X5)



GROSSE SCHUBLADEN (X2)



SCHUBLADENLADEKAPAZITÄT: 30KG.
GESAMTLADEKAPAZITÄT: 70KG.

MASSE



QUADRAT LÖCHER FÜR HAKEN

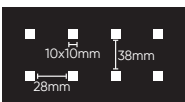

Speziell konfigurierter werkzeugwagen, der den gesamten grundbedarf für die wartung und reparatur von hybrid und elektrofahrzeugen sowie für hochspannungsarbeiten abdeckt.

24 PCS

CLASS CLASS 0 ENROLLABLE ROLLS

1000V IEC 60900 C



ENTHALTEN

REF.	BESCHREIBUNG	UNI.					€
52162	LASERTHERMOMETER -50°C BIS +550°C	1	0.17	6	72	576	38,00€
53940	SCHUTZGELÄNDERPFOSTEN FÜR PVC - GELB/SCHWARZ	4	0.55	-	6	90	13,20€
54326	PVC-KETTE - 7M - GELB/SCHWARZ	4	0.30	-	20	720	7,30€
53942	KUNSTSTOFFKETTENGLIED SCHWARZ	8	0.01	50	5000	75000	0,50€
54093	VDE ISOLIERTES WERKZEUGMODUL EVA (ETHYLENVINYLAZETAT) – 26 STÜCK	1	3.25	-	4	80	441,00€
54114	ISOLATIONSWIDERSTANDSMESSGERÄT	1	1.48	-	10	100	248,00€
54129	ISOLIERMATTE KLASSE 0	1	0.03	10	50	-	110,00€
54130	ISOLIERENDE HANDSCHUHE FÜR SPANNUNGSARBEITEN T9	1	0.35	-	1	100	58,00€
54132	ISOLIERENDER GESICHTSSCHUTZ FÜR SPANNUNGSARBEITEN	1	0.70	-	1	72	190,00€
54241	ISOLIERTER RETTUNGSMAST - 45KV	1	1.10	-	1	50	120,00€

FÜR WEITERE
INFORMATIONEN

SEITE 345

WERKZEUGWAGEN MIT 7 FÄCHER SPEZIAL AUSSTATTUNG MOTOREINSTELLUNG

53951 1.794,00€

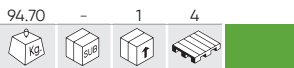

EVA-WERKZEUGEN

53952 1.794,00€

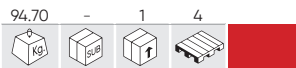

EVA-WERKZEUGEN

54501 1.794,00€

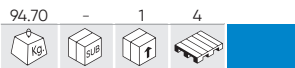

EVA-WERKZEUGEN

54502 1.794,00€

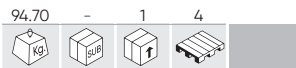

EVA-WERKZEUGEN

INNENMASSE

KLEINE SCHUBLADEN (X5)



GROSSE SCHUBLADEN (X2)



SCHUBLADENLADEKAPAZITÄT: 30KG.
GESAMTLADEKAPAZITÄT: 70KG.

MASSE



QUADRAT LÖCHER FÜR HAKEN

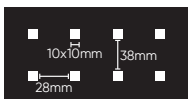

SORTIERTE EVA-WERKZEUGSÄTZE:

53775

1.109,00€



6 MODULE MOTOREINSTELLUNG WERKZEUG SET

ENTHALTEN

REF.	Kg	Box	Drawer	€
53769	5.90	3	36	178,00€
53770	6.15	3	36	198,00€

REF.	Kg	Box	Drawer	€
53771	4.05	3	36	158,00€
53772	6.40	3	36	229,00€

REF.	Kg	Box	Drawer	€
53773	6.60	3	36	298,00€
53774	6.95	3	36	190,00€

**FÜR WEITERE
INFORMATIONEN**

SEITE 297



53769



RENAULT / NISSAN / OPEL / VOLVO

53770



FORD / SEAT / VOLKSWAGEN / MAZDA / VOLVO

53771



FIAT / FORD / CITROËN / PEUGEOT

53772



FORD / VAG / MAZDA / VOLVO

53773



FIAT / ALFA / LANCIA / OPEL / SUZUKI / FORD

53774



OPEL / CHEVROLET / SAAB / FIAT / LANCIA / SUZUKI / FORD

54295

500,00€



N

WERKZEUSCHRANK 7 GLEICHE SCHUBLADEN - GRÜN - LEEREN

INNENMASSE

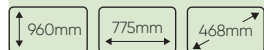

QUADRAT LÖCHER FÜR HAKEN

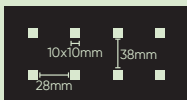

MASSE



54296

520,00€



N

WERKZEUSCHRANK 8 GLEICHE SCHUBLADEN - GRÜN - LEEREN

INNENMASSE



QUADRAT LÖCHER FÜR HAKEN

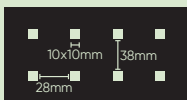

MASSE



54297

540,00€

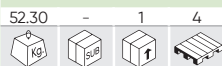

N

WERKZEUSCHRANK 9 GLEICHE SCHUBLADEN - GRÜN - LEEREN

INNENMASSE



QUADRAT LÖCHER FÜR HAKEN

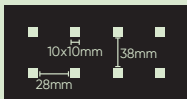

MASSE



53672

440,00€

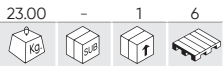

97 PCS

WERKZEUGTROLLEY



3 UNABHÄNGIGE KASTEN AUSGESTATTET MIT:



	1/2"	x11	8,10,11,12,13,14,16,17,19,21,22mm
	1/4"	x13	4,4.5,5,5.5,6,7,8,9,10,11,12,13,14mm
	1/2"	x1	
	1/4"	x1	
	1/2"	x2	125,300mm
	1/4"	x2	50,100mm
		x1	180mm
		x1	160mm
		x2	160mm, 180mm
		x2	PH2x125, PH1x100mm
		x2	6x150mm, 5x100mm
		x9	8,9,10,11,12,13,14,17,19mm
		x1	250mm
		x1	300g
		x1	250mm
		x1	200mm
		x8	1,5x8mm
		x1	3mm
	1/4"	x32	
	1/4"	x1	
	1/4"	x1	
	1/4"	x1	
	1/2"	x1	
	1/4"	x1	

A WERKZEUGKASTEN IN EVA-MODULEN + HERAUSNEHMBARES OBERES FACH



B 2 SCHUBLADEN MIT WERKZEUGEN IN EVA-MODULEN



C FACH MIT ÖFFNUNG VORNE



53867

1.095,00€

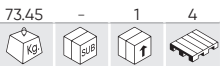

WERKZEUGWAGEN MIT 9 UNTERTEILTEN SCHUBLADEN - GRÜN

MASSE

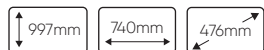

INNENMASSE



REF.	mm	UNI.			€
15073	174x53mm	21	0.05	200	1,00€
15076	396x53mm	18	0.30	50	3,50€

AUCH IN VERSCHIEDENE MÖGLICHKEITEN...

REF.	mm			€
15070	67x53mm	0.05	200	0,50€
15071	103x53mm	0.05	200	0,60€
15072	138x53mm	0.05	200	0,70€
15074	210x53mm	0.10	200	1,00€
15075	280x53mm	0.10	200	1,20€



MIT TRENNWÄNDE
FREIE ORGANISATION

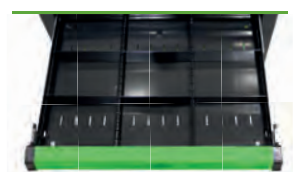

QUADRAT LÖCHER FÜR HAKEN

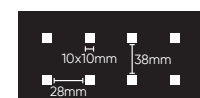



WERKZEUG MODULE IN KOHLEFASER FINISH

53708 325,00€

15.20 - 1 20

WERKZEUG-SORTIMENT 4 MODULE IN EVA KOHLEFASER-FINISH

ENTHALTEN

14296 118,00€

6.05 - 4 80

	1/2"	x17	x10, 11, 12, 13, 14, 15, 16, 17, 18, 19, 20, 21, 22, 24, 27, 30, 32mm
	1/4"	x13	4, 4.5, 5, 5.5, 6, 7, 8, 9, 10, 11, 12, 13, 14mm
	1/2"	x5	14, 15, 17, 19, 22mm
	1/4"	x8	6, 7, 8, 9, 10, 11, 12, 13mm
	1/2"	x8	E10, E11, E12, E14, E16, E18, E20, E24
	1/4"	x5	E4, E5, E6, E7, E8
	172	x2	1/2" - 1/4"
	1/2"	x2	125, 250mm
	1/4"	x2	50, 100mm
		x2	
	1/2"	x1	
	1/2"	x2	16, 21mm

		x2	PH1, PH2
		x2	PZ1, PZ2
	1/4"	x4	3, 4, 5, 6mm
		x3	SL4, SL5.5, SL6.5
		x8	T8, T10, T15, T20, T25, T27, T30
		x2	PH3, PH4
		x2	PZ3, PZ4
	8mm	x5	7, 8, 10, 12, 14mm
		x3	SL8, SL10, SL12
		x5	T40, T45, T50, T55, T60
		x1	1/4"
		x1	1/4"
	1/2"	x1	8mm
		x3	1.5, 2, 2.5mm

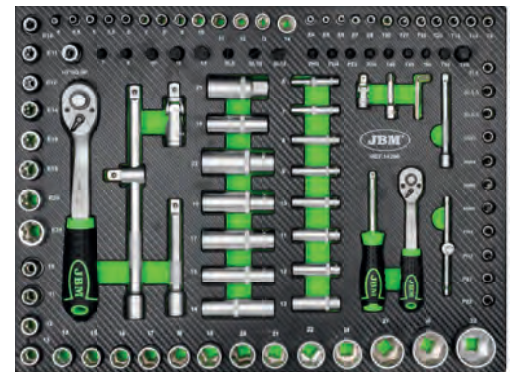

14297 87,00€

3.30 - 4 96

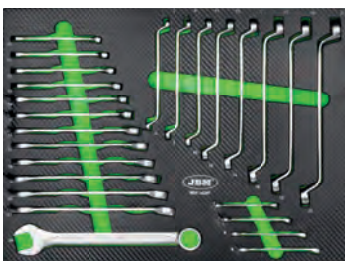

	6x7, 8x9, 10x11, 12x13, 14x15, 16x17, 18x19, 20x22mm
	6, 7, 8, 10, 11, 12, 13, 14, 15, 17, 19, 22mm

14298 51,50€

2.10 - 4 96



		PH0x75, PH1x100, PH2x100, PH3x150, PH4x200
		6, 7, 8, 10, 11, 12, 13, 14, 15, 17, 19, 22mm
		2x38mm
		6x38mm
		1.5, 2, 2.5, 3, 4, 5, 6, 8, 10mm
		10, 15, 20, 25, 27, 30, 40, 45, 50mm

14299 87,00€

3.25 - 4 96



	35mm		8"
	450g		10"
	10"		7.5"
	8"		3m
	8"		

54134

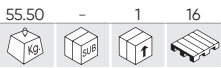

1.415,00€



LKW-REPARATUR-WERKZEUGSATZ

ENTHALTEN

15730

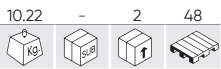

289,00€

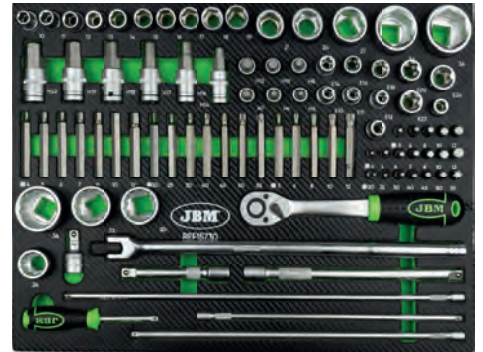

	55mm	H5, H6, H7, H8, H10, H12
	65mm	H14
	70mm	H16, H17, H18, H18, H20
	30mm	H4, H5, H6, H7, H8, H10, H12 T20, T25, T30, T40, T45, T50, T55
	75mm	H4, H5, H6, H7, H8, H10, H12 M5, M6, M8, M10, M12 T20, T25, T30, T40, T45, T50, T55
	1/2"	x9 E10, E11, E12, E14, E16, E18, E20, E22, E24
	1/2"	x10 10, 11, 12, 13, 14, 15, 16, 17, 18, 19mm

	1/2"	x3 50, 125, 250mm
	1/2"	x1 430mm
	1/2"	x1 10mm
	3/4"	x5 21, 24, 27, 34, 36mm
	3/4"	x4 24, 30, 32, 36 mm
		1/2x10, 3/8x10mm
		1/2x10, 3/8x10mm
	3/8"	10mm
	1/4"	300, 380, 450mm
	1/4"	
	1/2"	12

15731

214,00€

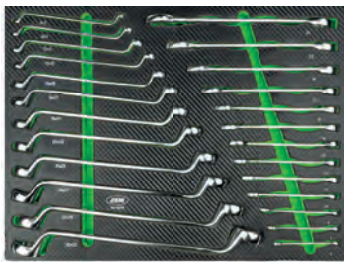
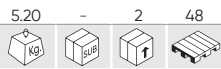

	6x7, 8x9, 10x11, 12x13, 14x15, 16x17, 18x19, 20x22, 21x23, 24x27, 25x28, 30x32mm
	6, 7, 8, 10, 11, 12, 13, 14, 15, 17, 19, 22, 24mm

15732

293,50€

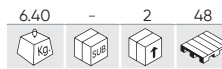

	10, 13, 17mm
	10x11, 12x13, 14x17mm
	E10xE12, E14xE18, E20xE24
	8x10, 11x13, 14x15, 16x17, 18x19mm
	27, 30, 32, 36mm
	10, 13, 17, 19mm

15733

113,00€

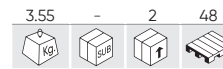

	PH0x75mmL, PH1x75mmL, PH2x100mmL, PH2x38mmL, PH3x150mmL, PH4x200mmL
	SL3.5x75mmL, SL5x75mmL, SL6x100mmL, SL6x38mmL, SL8x150mmL, SL9.5x200mmL
	10x11, 12x13, 14x15mm
	10x11, 12x13, 14x15, 16x17, 18x19mm

15734

288,50€

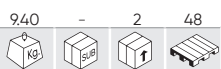

	1kg
	24, 27, 30, 32, 36, 41mm
	3/4" 500mm
	3/4" 500mm
	1.5, 2, 2.5, 3, 4, 5, 6, 8, 10mm

15735

152,00€

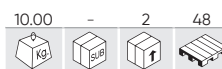

	220mm		250mm
	330mm		6" - 160mm
	330mm		7" - 180mm
	330mm		0°/45°/90°
	330mm		300mm

15736

488,50€

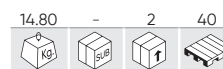

	1/2"	13, 14, 15, 16, 17, 18, 19, 21, 22, 24mm
	3/4"	78mmL 22, 24, 27, 30, 32, 33, 36, 38, 46mm
	1/2"	90mmL 51, 60mm
	1/2"	T40, T45, T50, T60, T70
	1/2"	78mmL H6, H8, H14, H17
	3/4"	100mmL T80, T90, T100
	1/2"	40mmL M18
	1/2"(M)x3/4"(H) - 3/4"(M)x1/2"(H)	
	1/2" - 3/4"	125mm

15681

134,00€

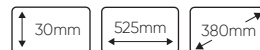
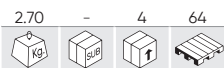

	H3, H4, H5, H6, H7, H8		7, 8, 10, 12, 14mm
	M8, M10, M12		PH3, PH4
	PH0, PH1, PH2, PH3		PZ3, PZ4
	PZ0, PZ1, PZ2, PZ3		8mm
	1/2"		SL8, SL10, SL12
	SL4, SL5.5, SL6.5, SL7		T40, T45, T50, T55, T60, T70
	T8, T9, T10, T15, T20, T25, T27, T30, T40		T40, T45, T50, T55, T60, T70
	T8, T9, T10, T15, T20, T25, T27, T30, T40		H7 (230mmL), H10, H11, H13 (140mmL), H14, H17, H19, H22, H24 (55mmL)
	TS10, TS15, TS20, TS25, TS27, TS30, TS40, TS45, TS50		M9 (100mmL), M10, M12, M14 (140mmL), M16 (53mmL), M16 (100mmL)
	1/2" 8mm		R7, R8 (240mmL), R9 (100mmL), R10 (140mmL)
	3/8" 8mm		T30 (300mmL), T40, T45, T50, T55, T60, T70 (140mmL), T80 (100mmL)
	1/4" 6mm		1/2"
	1/2" M18		HT5 (160mmL)

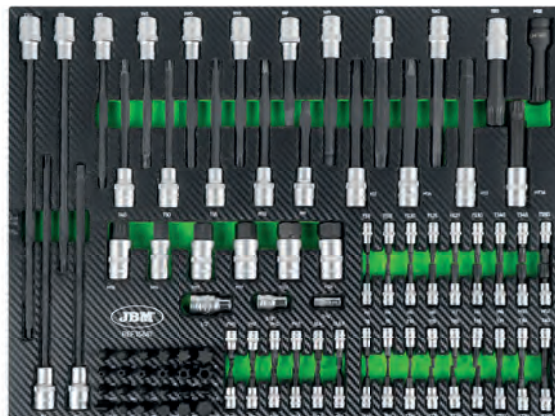

15122 74,00€

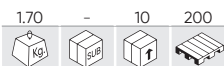

x12 8, 9, 10, 11, 12, 13, 14, 15, 16, 17, 18, 19mm

15155 59,00€

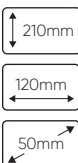
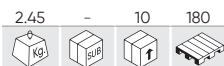

x11 8, 10, 11, 12, 13, 14, 15, 16, 17, 18, 19mm

15156 70,00€

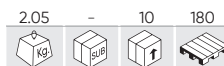

x4 21x23, 24x27, 25x28, 30x32mm

15157 42,00€

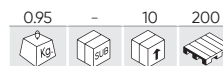

x7 6x8, 10x12, 13x14, 15x17, 19x21, 22x24mm

15158 59,00€

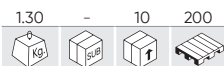

x7 8, 10, 11, 13, 14, 17, 19mm

15159 44,00€

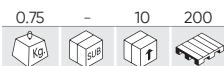

x5 8x10, 11x13, 14x15, 17x19, 20x22mm

15160 42,00€

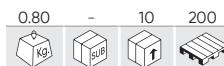

x6 8x9, 10x11, 12x13, 14x15, 16x17, 18x19mm

15161 62,00€

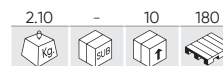

x4 27, 29, 30, 32mm

15316 58,00€

0.85 - 10 260



x3 8, 9, 10, 11, 12, 13, 14, 15, 16, 17, 18, 19mm

53943 21,50€

0.80 - 10 240



x7 PH4x200, PH3x150, PH2x100, PH2x38 PH1x80, PH0x120, PH1x100

53944 19,50€

0.80 - 10 240

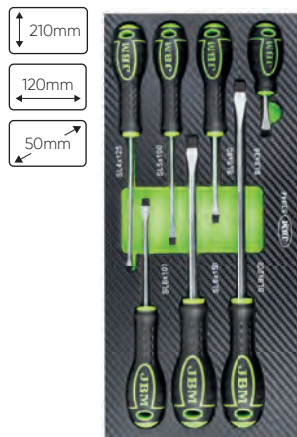

x7 SL9x200, SL4x125, SL5x100, SL5x80, SL6x38, SL6x100, SL8x150mm

53945 18,90€

0.60 - 10 240

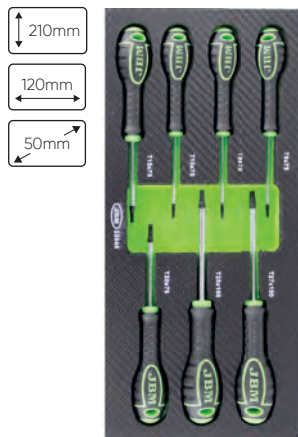

x7 T8x75, T9x75, T10x75, T15x75, T20x75, T25x100, T27x100

15454 35,40€

1.10 - 10 300

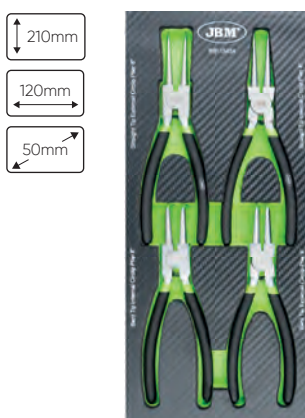

x1 8" x1 8"
 x1 8" x1 8"

15541 27,60€

0.95 - 10 220



x1 7" - 180mm
 x1 8" - 200mm
 x1 8" - 200mm

15706 31,00€

0.55 - 10 240

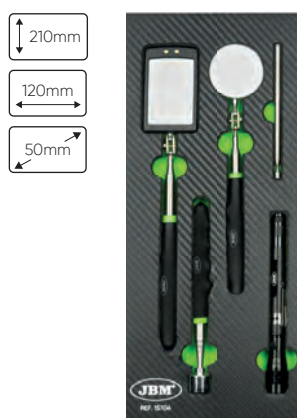

x1 180 - 770mm x1 280 - 870mm
 x1 130 - 640mm x1 170-580mm
 x1 495mm

15737 45,00€

1.70 - 10 200

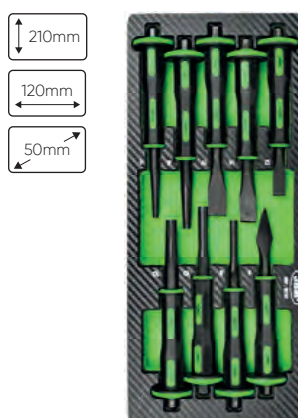

x1 6x180mm
 x2 8x180, 10x180mm
 x3 6x180, 8x180, 10x180mm
 x3 2x160, 16x175, 19x180mm

15315 28,20€

1.05 - 10 260



x1 8" x1 8"
 x1 8" x1 8"
 x1 8"

15514 9,35€

0.05 - 10 360

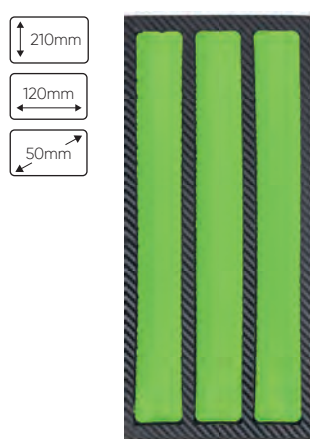

LEEREN

54158 38,00€

1.70 - 10 200

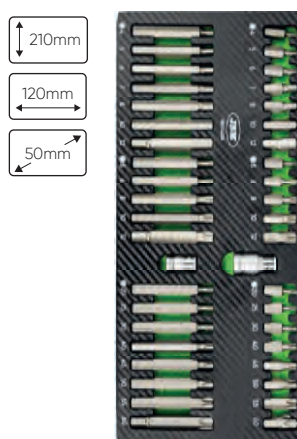

3/8" x1 10mm
1/2" x1 10mm
30mm x7 4, 5, 6, 7, 8, 10, 12mm
75mm x7 4, 5, 6, 7, 8, 10, 12mm
30mm x8 T20, T25, T30, T40, T45, T50, T55, T60
75mm x8 T20, T25, T30, T40, T45, T50, T55, T60
30mm x5 M5, M6, M8, M10, M12
15mm x5 M5, M6, M8, M10, M12

15162 30,20€

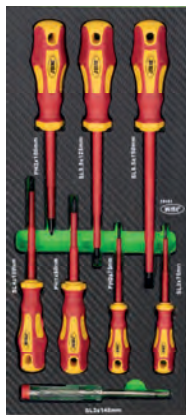
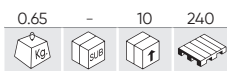

- ⊖ **x4** SL3x75, SL4x100, SL5.5x125, SL6.5x150mm
- ⊕ **x3** PH0x75, PH1x80, PH2x100mm
- ⌵ **x1** 140mm

54093



- ⊖ **3/8"** x10 45mm 8, 10, 11, 12, 13, 14, 16, 17, 18, 19, 21, 22mm
- ⊖ **x2** 4x100, 5,5x125mmL
- ⊕ **x2** PH1x80, PH2x100mm
- x1** 185mm
- x1** 52mm
- x1** 185mm
- x6** 7x86, 8x99, 10x109, 12x127, 14x141, 17x156mm
- 1/2"** **x1** 125mm
- 3/8"** **x1** 200mm
- 3/8"** **x1** 200mm

15799 28,30€



- x1** 450g
- x1** 35mm

16111 19,20€

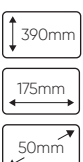

- ⌵ **x1** 220mm
- ⊖ **BV1.25** ⊖ **BV2**
- ⊖ **RV2-4** ⊖ **RV2-4L**
- ⊖ **SV2-4** ⊖ **SV5.5-6**
- ⊖ **MDD2-250** ⊖ **FDD2-250**

51805 17,00€



- x5** 50, 75, 100, 152, 227mm

51447 16,00€



- x5** 50, 75, 100, 152, 227mm

51448 52,00€



- x5** 50, 125, 250, 380, 510mm

52912 91,00€



- x6** E6xE7 (200mmL), E8xE10 (235mmL), E11xE12 (290mmL), E14xE16 (370mmL), E18xE20 (410mmL), E22xE24 (420mmL)

54066 83,00€

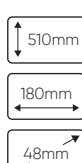

- x7** 8mm (23,5mmL), 10mm (29,3mmL), 12mm (32,8mmL), 13mm (34,9mmL), 14mm (36,7mmL), 17mm (41mmL), 19mm (42mmL)

51864 64,00€

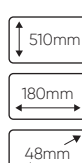

- x6** 10x11mm (290mmL), 12x14mm (330mmL), 13x15mm (368mmL), 16x18mm (407mmL), 17x19mm (407mmL), 22x24mm (430mmL)

54032 84,00€

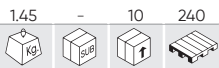

400mm
180mm
50mm



x12 8mm (89mmL), 9mm (94mmL), 10mm (95mmL), 11mm (99mmL), 12mm (102mmL), 13mm (107mmL), 14mm (114mmL), 15mm (117mmL), 16mm (123mmL), 17mm (125mmL), 18mm (130mmL), 19mm (135mmL)

15083 8,50€

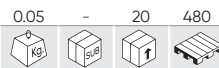

380mm
175mm
50mm



LEEREN

15084 68,00€

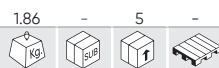

380mm
175mm
50mm

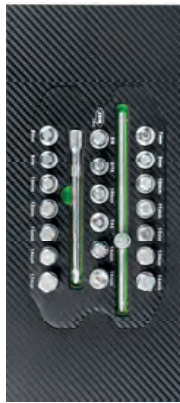

x2 5/16", 3/8"
x7 7, 8, 10, 11, 12, 13, 14mm
x1 10mm
x1 10mm
x7 8, 9, 10, 12, 13, 14, 17mm
x1 T45
x1 M16
x1 200mm
x1 150mm

53979 34,60€

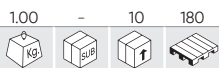

390mm
340mm
50mm



x8 T10x75, T15x75, T20x100, T25x100, T30x150, T40x150, T45x200, T50x200mm

53980 34,60€

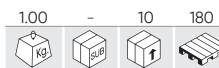

390mm
340mm
50mm



x8 H2x100, H2.5x100, H3x100, H4x150, H5x150, H6x200, H8x200, H10x200

WERKZEUG MODULE

11996 48,00€



390mm
175mm
50mm



x10 6x7, 8x9, 10x11, 12x13, 14x15, 16x17, 18x19, 20x22, 24x27, 30x32mm

11997 39,00€



390mm
175mm
50mm



x8 6x7, 8x9, 10x11, 12x13, 14x15, 16x17, 18x19, 20x22mm

11998 49,00€



390mm
175mm
50mm

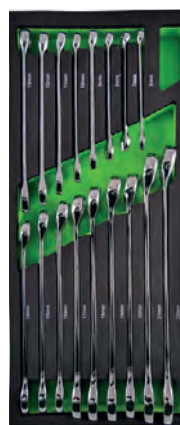

x17 6, 7, 8, 9, 10, 11, 12, 13, 14, 15, 16, 17, 18, 19, 20, 21, 22mm

13668 18,70€



390mm
175mm
50mm



x1 3m
x1 230mm
x1 50mm
x1 250mm

11994 33,00€

0.68 - 10 233
Kg SUB f

390mm
175mm
50mm



- x1 1/4" x1 250mm
- x1 1/4" x1 125mm
- x1 1/4"
- x13 4, 4.5, 5, 5.5, 6, 7, 8, 9, 10, 11, 12, 13, 14mm

14114 19,30€

0.93 - 10 360
Kg SUB f

390mm
175mm
50mm



- x1 10"
- x1 10"

13667 17,60€

0.83 - 10 360
Kg SUB f

390mm
175mm
50mm



- x1 253mm
- 2x6, 3x7, 3x9, 6x10mm

13923 7,45€

0.05 - 30 1299
Kg SUB f

390mm
175mm
50mm

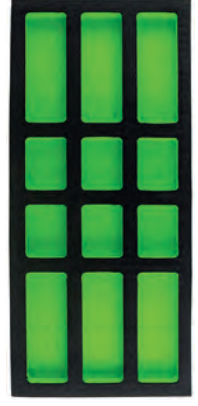

LEEREN

53671 41,00€

0.85 - 10 520
Kg SUB f

210mm
120mm
50mm



- x3 1/4" - 85 mm
- 1/2" - 135 mm
- 3/8" - 102 mm

53620 88,00€

3.52 - 4 112
Kg SUB f

30mm 525mm 380mm



- x17 6, 7, 8, 9, 10, 11, 12, 13, 14, 15, 16, 17, 18, 19, 20, 21, 22mm
- x8 6x7, 8x9, 10x11, 12x13, 14x15, 16x17, 18x19, 20x22mm

KUNSTSTOFF MODULE

10732 18,70€

0.70 - 10 220
Kg SUB f

390mm
175mm
50mm



- x1 3m
- x1 230mm
- x1 50mm
- x1 250mm

10735 20,30€

0.98 - 10 300
Kg SUB f

390mm
175mm
50mm



- x1 8"
- x1 8"
- x1 8"
- x1 8"
- x1 8"

WERKZEUG WANDTAFEL

REF.	mm	Kg	SUB	f		€
52419	A 1000x600mm	7.07	-	1	30	80,00€
52420	B 1500x600mm	10.80	-	2	35	108,00€
52421	C 2000x600mm	14.00	-	1	38	172,00€

QUADRAT LÖCHER FÜR HAKEN

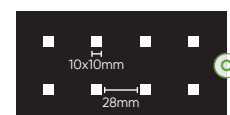
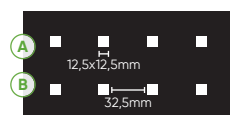
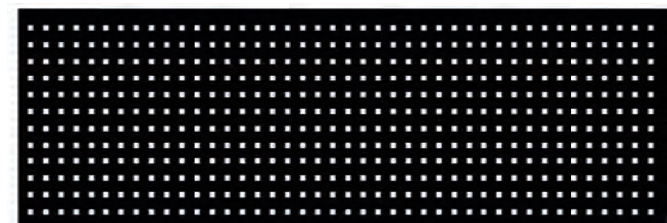

ZUBEHÖR

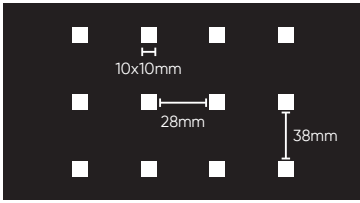

15068 15,20€

0.65	-	25	500



15069 32,80€

1.65	-	1	80



15313 14,00€

0.60	-	1	340

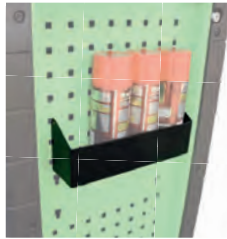

14354 14,00€

0.60	-	1	184



16359 10,00€

0.20	1	30	-	N

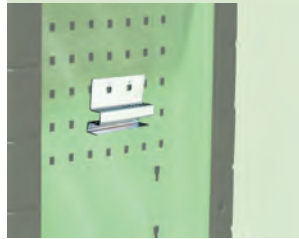

16361 16,50€

0.60	1	30	280	N



16362 20,00€

2.00	1	30	-	N

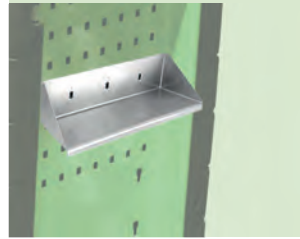

16363 14,50€

0.40	1	30	-	N



16344 43,00€

2.00	-	4	72	N

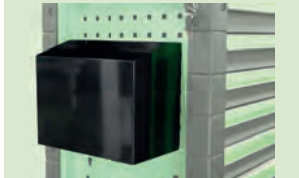

16358 12,00€

0.45	1	30	-	N

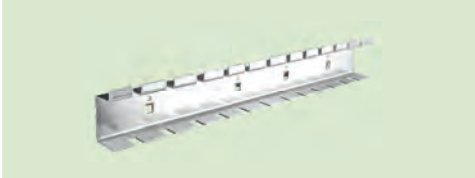

16360 12,00€

0.38	1	30	15	N



16354 1,50€

0.50	10	100	-	N

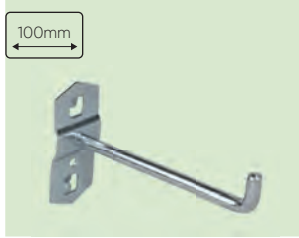

16355 2,00€

0.10	10	100	-	N

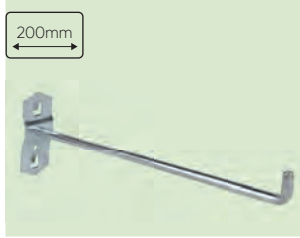

16356 2,50€

0.01	10	100	-	N

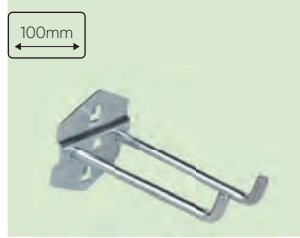

16357 2,50€

0.10	10	100	-	N

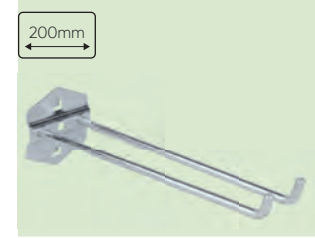

ZUBEHÖR

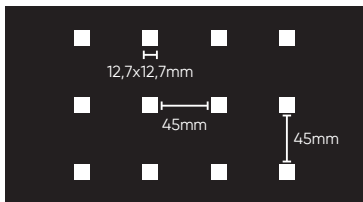

16161 17,50€

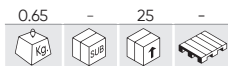

16162 35,10€

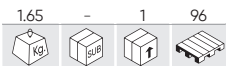

16163 10,20€

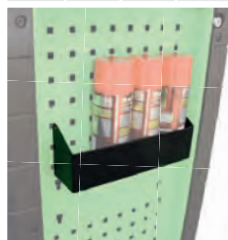

16188 39,60€

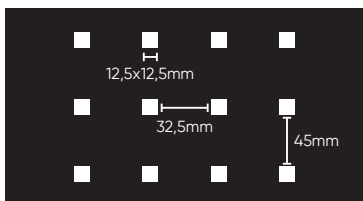
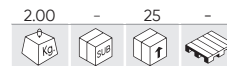

51655 4,10€

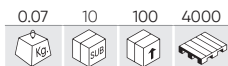

51976 1,63€

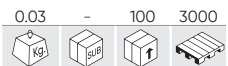

51658 4,50€

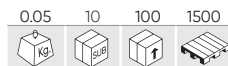

51422 2,97€

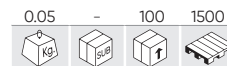

52634 5,25€

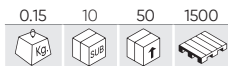

51975 2,27€

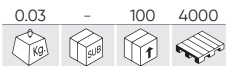

51419 2,79€



51656 3,65€

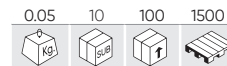

51654 4,80€

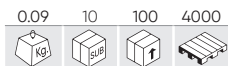

52635 4,80€

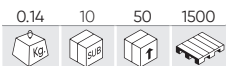

51657 5,85€

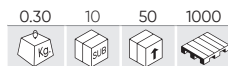

51653 5,10€

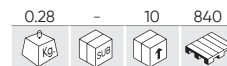

ERSATZTEILE

REF.	BESCHREIBUNG					€
14578	KUGELLAGERFÜHRUNG FÜR REF. 53661, 53686, 53904, 54006	1.05	-	25	-	12,50€
14580	ARBEITSFLÄCHE FÜR REF. 53661, 53686, 53904, 54006, 54389	2.60	-	3	39	41,00€
14783	SEITENSCHUTZ RECHTS FÜR REF. 53686, 53661, 53904, 54006, 54389	0.25	-	50	-	5,50€
15023	RAD FÜR REF. 53765, 53766, 53870	0.65	-	10	-	12,50€
15024	LENK-RAD FÜR REF. 53765, 53766, 53870	0.95	-	8	-	15,00€
15025	RAD FÜR REF. 53900, 53901	0.65	-	10	-	12,50€
15026	LENK-RAD FÜR REF. 53900, 53901	0.95	-	8	-	15,00€
15030	SCHUBLADENGRIF FÜR REF. 53765, 53766	0.30	-	50	-	8,00€
15033	SCHUBLADENGRIF SCHMAL FÜR REF. 53868	0.14	-	50	-	6,00€
15034	ARBEITSFLÄCHE FÜR REF. 53868	2.00	-	2	-	57,00€
15035	SCHUBLADENGRIF FÜR REF. 53869	0.36	-	20	-	8,50€
15036	SCHUBLADENGRIF FÜR REF. 53870	0.36	-	20	-	8,50€
15037	SCHUBLADENGRIF FÜR REF. 53900, 53901	0.10	-	-	-	8,00€
15038	ARBEITSFLÄCHE FÜR REF. 53869, 53870	2.00	-	2	-	34,50€
15040	RAD FÜR REF. 53904, 54006, 54389	0.66	-	10	-	12,50€
15041	LENK-RAD FÜR REF. 53904, 54006, 54389	0.98	-	8	-	15,00€
15042	SCHUBLADENGRIF FÜR REF. 53904, 54006	0.10	-	1	-	7,50€
15050	SCHUBLADENGRIF FÜR REF. 53661, 53686	0.10	-	50	-	9,50€
15058	KANTENSCHUTZ FÜR REF. 53868	0.36	-	-	-	7,50€
15065	KANTENSCHUTZ FÜR REF. 53869, 53870	0.28	-	12	-	6,50€
16387	SCHUBLADENGRIF FÜR REF. 54389	0.40	-	-	-	10,50€



VORHÄNGESCHLOSS

KURZ

REF.	BESCHREIBUNG					€
53403	38mm	0.15	8	96	3168	6,50€
53405	32mm	0.10	8	96	3168	5,30€
53406	50mm	0.30	8	48	1728	8,55€
53407	63mm	0.35	8	48	3168	12,70€
53408	75mm	0.48	3	24	840	19,30€

LANG

REF.	BESCHREIBUNG					€
53404	38mm	0.15	8	96	3168	6,50€
53409	50mm	0.30	8	48	3168	9,00€



WASSERDICHTES VORHÄNGESCHLOSS

REF.	BESCHREIBUNG					€
53399	30mm	0.90	8	48	3168	3,50€
53400	40mm	0.20	8	48	499	5,70€
53401	50mm	0.35	8	48	499	7,40€
53402	65mm	0.05	10	40	499	9,60€



54388

366,00€

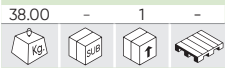

DIAGNOSEWAGEN

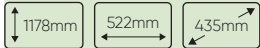

Multifunktionaler Werkstattwagen mit vier Fächern und einem abgeschlossenen Fach. Er eignet sich zur Unterbringung von Laptops, Prüfgeräten und Ladegeräten. Er hat zwei Griffe und drehbare Räder, die den Transport auf sehr bequeme Weise erleichtern. Er verfügt außerdem über eine perforierte Platte, einen Papierrollenhalter und zwei seitliche Ablagen für Werkzeuge

MASSE DER OBEREN ABLAGE	433x398mm
MASSE DER GELOCHTEN PLATTE	430x475mm
ABLAGEN INSGESAMT	4
KAPAZITÄT DER OBEREN ABLAGE	20Kg
RADDURCHMESSER	101mm
RÄDER MIT BREMSEN	2



N

REF. BESCHREIBUNG

REF. BESCHREIBUNG	Kg	Sub	Q	R	€
16481 REIFEN MIT BREMSE FÜR REF. 54388	11.60	-	20	-	14,00€
16482 RAD FÜR REF. 50818	2.80	-	20	-	13,50€



51576

125,00€

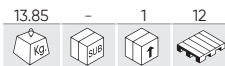

WERKSTATTWAGEN



52373

252,00€

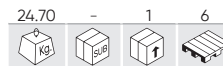

WERKSTATTWAGEN XL



51738

850,00€

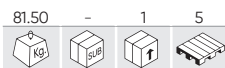

ARBEITSTISCH MIT 3 FÄCHERN

MASSE



INNENKISTE MESSUNGEN



REF. BESCHREIBUNG

REF. BESCHREIBUNG	Kg	Sub	Q	R	€
15144 2ER-SET GUMMI-ARBEITSTMATTEN REF: 51738	2.50	-	100	100	30,00€



51737 699,00€

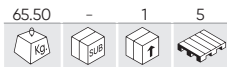

ARBEITSTISCH MIT 2 FÄCHERN



MAASSE



INNENKISTE MESSUNGEN



REF. BESCHREIBUNG

REF.	BESCHREIBUNG	1	2	3	4	5	€
15145	2ER-SET GUMMI-ARBEITSTISCHMATTEN REF: 51737	1.90	-	100	100		20,45€

53674 447,00€

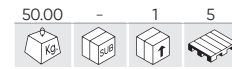

ARBEITSTISCH MIT 1 FACH



MAASSE



INNENKISTE MESSUNGEN



REF. BESCHREIBUNG

REF.	BESCHREIBUNG	1	2	3	4	5	€
15146	GUMMITEPICH FÜR ARBEITSTISCH REF: 53674	1.35	-	100	100		16,20€

51035 799,00€

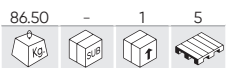

ARBEITSTISCH MIT VORDERTAFEL



MAASSE



QUADRAT LÖCHER FÜR HAKEN

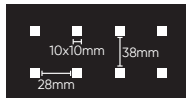

INNENKISTE MESSUNGEN



54328 199,00€



KLAPPBARE WERKBANK MIT RÜCKWAND



N

MAASSE

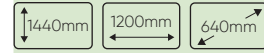

QUADRAT LÖCHER FÜR HAKEN

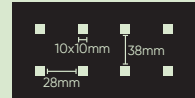

EINGEKLAFFT

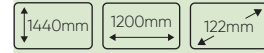

ARBEITSFLÄCHE



WERKZEUG NICHT ENTHALTEN

50957

22,00€

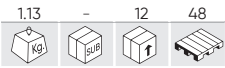

SORTIERBOX 24+2



- 24 Sektionen (8 x 5,5 cm).
- 2 Sektionen (15 x 7,5 cm).
- Zusammenstellbar von 26 bis 5 Sektionen.

50959

14,00€

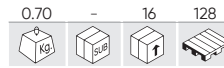

SORTIERBOX 20+1



- 20 Sektionen (6 x 7 cm).
- 1 Sektionen (35 x 7 cm).
- Zusammenstellbar von 19 bis 4 Sektionen.

51051

34,80€

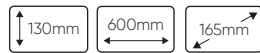
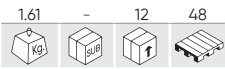

ORGANIZER SET - 5 TEILE



UNTRENNBARE
SEKTIONEN

51050

285,00€

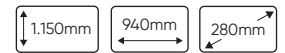
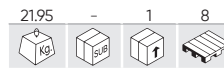

SCHRANK-ORGANIZER - 47 FÄCHER

GROSSE SEKTIONEN

Insgesamt: 15
Abmessungen: 24x14,5x13 cm
Abmessungen des Regals: 84x14x24cm
Insgesamt Regale: 3

KLEINE SEKTIONEN

Insgesamt: 32
Abmessungen: 16 x 10 x 7,5 cm
Abmessungen des Regals: 84x16x8cm
Insgesamt Regale: 4



51574

52,00€

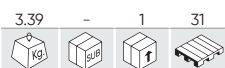

WERKZEUGBOX MIT 5 FÄCHERN



MASSE



OFFEN



ohne MwSt

WERKZEUGBOX

REF.							€
54393	750x200x220mm - 9Kg	7.70	-	1	15	92,00€	
54394	530x200x220mm - 5,2Kg	5.70	-	1	22	64,00€	
54395	450x200x220mm - 4,5Kg	6.20	-	1	24	53,00€	



51575 317,00€

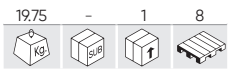

WERKZEUGKISTE MIT 6 SCHUBFÄCHERN UND OBERFACH

MASSE



KLEINE SCHUBLÄDEN (X3)

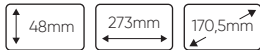

MITTLERE SCHUBLADE (X2)

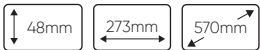

GROSSE SCHUBLADE (X1)

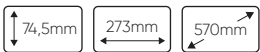

51600 109,00€

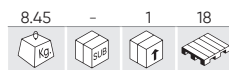

WERKZEUGKISTE MIT 3 SCHUBLÄDEN UND OBERFACH

MASSE



INNENKISTE MESSUNGEN



53782 14,00€

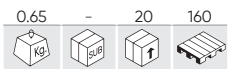

GROSSER SET VON ELEKTRISCHEN WERKZEUGEN



53253 98,00€

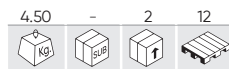

WERKZEUG-ROLLKOFFER MIT ROHR-GRIFF

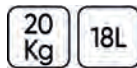

54080 53,50€

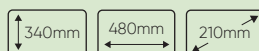

WERKZEUG-TASCHE



54374 75,50€



TOOL RUCKSACK





ELEKTRO-WERKZEUG TASCHEN

REF.	BESCHREIBUNG					€
53702	KLEINER SET VON ELEKTRISCHEN WERKZEUGEN	1.00	-	5	180	28,50€
53703	MITTELSATZ VON ELEKTRISCHEN WERKZEUGEN	1.40	-	5	120	41,00€
53704	GROSSER SET VON ELEKTRISCHEN WERKZEUGEN	1.65	-	5	120	42,00€



300mm 305mm 190mm



300mm 406mm 190mm



330mm 508mm 230mm

53903

59,00€

1.65	-	10	100

FLEXIBLEN ANTI-RUTSCH WERKZEUG-FÄCHERN SET - 3 TEILE

3
PCS



REF.	BESCHREIBUNG					€
15010	285x137x27mm	0.40	-	20	360	16,50€
15011	285x202x27mm	0.45	-	20	320	18,00€
15012	543x300x27mm	1.05	-	10	120	31,50€

FLEXIBLE MAGNET-TABLETT-HALTER

REF.	OBERER DURCHMESSER	FUSSDURCHMESSER	MAX. TIEFE	MIN. TIEFE					€
52516	225mm	88mm	135mm	43mm	0.42	6	24	1152	28,00€
52517	135mm	53mm	90mm	31mm	0.10	12	72	1152	6,00€



50787 8,00€

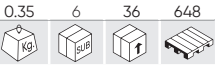

MAGNETISCHES TABLETT-HALTER Ø150MM



50788 14,50€

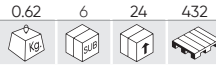

MAGNETISCHES TABLETT-HALTER



52466 11,00€

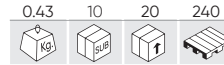

MAGNETISCHES TABLETT-HALTER

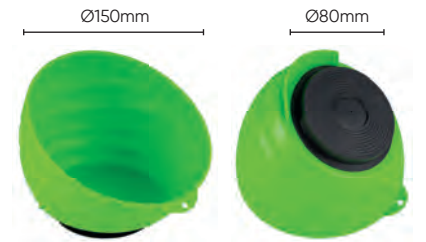

53958 6,50€

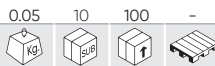

SET VON 5 MAGNETEN



50789 29,00€

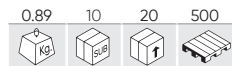

MAGNETLEISTE FÜR WERKZEUGE



53192 52,00€

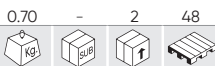

EVA-SCHAUM LIEGE



MASSE



MASSNAHMEN GEFALTET

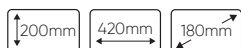

- EVA-SCHAUMSTOFFEINLAGEN.

53191 14,80€



EVA-SCHAUM UNTERLAGE



MASSE



- EVA-SCHAUMSTOFFEINLAGEN.

50843 79,00€

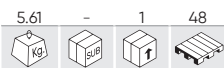

HÖHENVERSTELLBARER STUHL



Ø 295mm

Ø 380mm



50844 65,00€

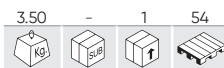

STAHLHOCKER



MASSE

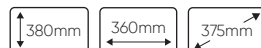

52148 65,00€

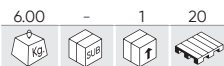

ROLLWAGEN



50808 77,00€



AUSEINANDERNEHMBARER ROLLWAGEN



REF.	BESCHREIBUNG					€
11971	RÄDER FÜR 52148	0.20	5	50	-	3,60€

53211 75,00€

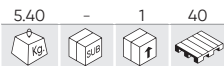

TRANSFORMIERBARER ROLLWAGEN



52542 109,00€

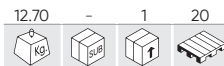

TRANSFORMIERBARER ROLLWAGEN

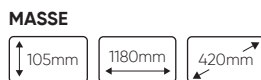

52869

52,00€

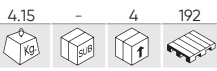

BANKSCHRAUBSTÖCKE 100MM



52870

100,00€

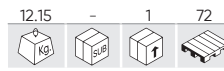

BANKSCHRAUBSTÖCKE 150MM

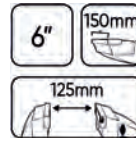

53031

59,00€

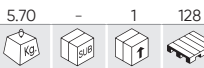

DREHBANK VISE 4 "



53032

126,00€

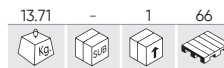

DREHBANK VISE 6 "

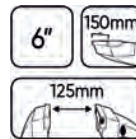

52871

258,00€

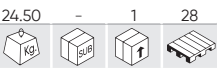

BANKSCHRAUBSTÖCKE



DIREKTE
ÖFFNUNG MIT HEBEL
+ DREHPLATTE

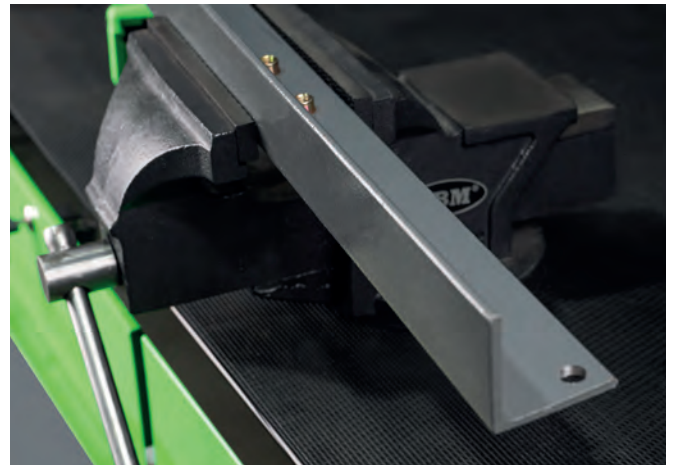

PROFI-AMBOSS

REF.	Kg.	mm					€
52308	50Kg	190x625x140mm	47.00	-	1	24	440,00€
52309	100Kg	245x790x180mm	100.00	-	1	8	941,00€

AUS STAHL



AKKU-WERKZEUGE

- 102 SCHRAUBENDREHEN
- 106 BOHREN
- 108 SCHLEIFEN/POLIEREN
- 110 SÄGEN
- 113 SPEZIALWERKZEUGE
- 118 GARTENGERÄTE
- 122 BATTERIEN / LADEGERÄTE
- 123 ZUBEHÖR / VERBRAUCHSMATERIAL



**VERWENDEN SIE ES MIT JBM-BATTERIEN:
EINE EINZIGE BATTERIE, DIE FÜR ALLE WERKZEUGE GEEIGNET IST**

DREI TYPEN VON BATTERIEN UND ZWEI TYPEN VON LADEGERÄTEN.
WÄHLEN SIE DEN DER AM BESTEN FÜR SIE GEEIGNET IST!



60046C

339,00€



N

1/2" 550NM AKKU-SCHLAGSCHRAUBER MIT KOFFER

BEINHALTET

REF.	BESCHREIBUNG					€
60013	LITHIUM-IONEN-AKKUMULATOR 4.0 AH	0.75	-	5	700	80,00€
60016	LADEGERÄT 20 V - 4A	0.80	-	5	210	49,00€
60046	AKKU BÜRSTENLOSER SCHLAGPISTOLE 1/2" 550NM	1.50	-	4	200	174,00€

Dieses Werkzeug wurde für das Anziehen und Lösen von Muttern und Schrauben entwickelt, die ein hohes Drehmoment erfordern. Es ist mit einer LED-Arbeitsleuchte und einem Drehrichtungswähler ausgestattet, der auch die Arretierung des Auslösers ermöglicht und ein versehentliches Einschalten des Werkzeugs verhindert. Er verfügt über 5 verschiedene Gänge, 3 für das Anziehen und 2 für das Lösen, so dass Sie die Geschwindigkeit je nach dem auszuführenden Vorgang einstellen können. Dank des ergonomischen Griffs wird außerdem eine bessere Griffbarkeit und Präzision erreicht.

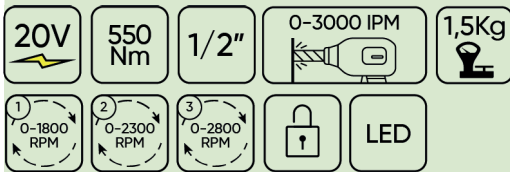

- MOTOR BRUSHLESS
- LED-BELEUCHTUNG
- VOR-/RÜCKWÄRTS-DREHRICHTUNGSSCHALTER
- HANDGRIFF
- 5 VERSCHIEDENE GÄNGE
- GURTHAKEN
- DIE VERGLEICHSGERÄTE IN UNSEREN KÄSTEN SIND KOMPATIBEL MIT 4.0AH UND 6.0AH BATTERIEN.**



60046

174,00€



N

AKKU BÜRSTENLOSER SCHLAGPISTOLE 1/2" 550NM

BATTERIE NICHT ENTHALTEN.



**VERWENDEN SIE ES MIT JBM-BATTERIEN:
EINE EINZIGE BATTERIE, DIE FÜR ALLE WERKZEUGE GEEIGNET IST**

DREI TYPEN VON BATTERIEN UND ZWEI TYPEN VON LADEGERÄTEN.
WÄHLEN SIE DEN DER AM BESTEN FÜR SIE GEEIGNET IST!



60044C

485,00€



1/2" 1300NM AKKU-SCHLAGSCHRAUBER MIT KOFFER

BEINHALTET

REF.	BESCHREIBUNG	kg	L	Stk	€
60013	LITHIUM-IONEN-AKKUMULATOR 4.0 AH	0.75	-	5 700	80,00€
60016	LADEGERÄT 20 V - 4A	0.80	-	5 210	49,00€
60044	AKKU-SCHLAGSCHRAUBER 1/2" 1300NM MIT BÜRSTENLOSER MOTOR	3.25	-	5 90	330,00€

Dieses Werkzeug wurde entwickelt, um Schrauben und Muttern zu spannen und zu lösen, die ein hohes Drehmoment erfordern. Es verfügt über einen bürstenlosen X-TorQ-Motor der neuen Generation, der das Lösen von festgeklemmten oder sehr fest angezogenen Schrauben und Muttern um bis zu 2-mal beschleunigt. Robust und langlebig. Mit einem Aluminiumgehäuse, das an der Vorderseite mit Elastomer geschützt ist.

Es ist mit einer LED-Arbeitsleuchte und einem Drehschalter für die rehrichtung ausgestattet, der auch das Verriegeln des Abzugs ermöglicht, um einen versehentlichen Start des Werkzeugs zu verhindern. Es hat 5 verschiedene Gänge, 3 zum Festziehen und 2 zum Lösen, sodass Sie die Geschwindigkeit je nach der auszuführenden Operation anpassen können.

Sein doppelter Hammer im neuen Design sorgt für mehr IPM und weniger Vibration. Neuer Ring zur Fixierung der Steckdose: schnellerer Wechsel der Steckdosen und sicherere Fixierung. Perfekte Werkzeugbalance und Gewicht für Arbeiten, die große Steckdosen und hohe Drehmomente erfordern. Großer Haken, nützlich zum Aufhängen der Maschine an Metallstrukturen oder am Arbeitsgürtel. Darüber hinaus sorgt der ergonomische Griff für einen besseren Halt und mehr Präzision.

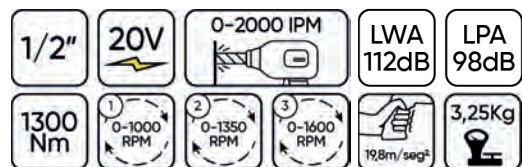

- MOTOR BRUSHLESS
- LED-BELEUCHTUNG
- VOR-/RÜCKWÄRTS-DREHRICHTUNGSSCHALTER
- HANDGRIF
- 5 VERSCHIEDENE GÄNGE
- GURTHAKEN

DIE VERGLEICHSGERÄTE IN UNSEREN KÄSTEN SIND KOMPATIBEL MIT 4.0AH UND 6.0AH BATTERIEN.



60044

330,00€



AKKU-SCHLAGSCHRAUBER 1/2" 1300NM MIT BÜRSTENLOSER MOTOR

BATTERIE NICHT ENHALTEN.



60048C

560,00€

N

7.15	-	4	32

3/4" 1300NM AKKU-SCHLAGSCHRAUBER MIT KOFFER

BEINHALTET

REF.	BESCHREIBUNG					€
60015	LITHIUM-IONEN-AKKUMULATOR 6.0 AH	1.00	-	20	630	138,00€
60016	LADEGERÄT 20 V - 4A	0.80	-	5	210	49,00€
60048	AKKU-SCHLAGSCHRAUBER 3/4" 1300NM MIT BÜRSTENLOSER MOTOR	3.26	-	4	64	366,00€

Dieses Werkzeug dient zum Anziehen und Lösen von Radmutter und Schrauben mit einem hohen Drehmoment. Es ist mit einer Betriebs-LED und einem Drehwahlschalter ausgestattet, mit dem Sie auch den Auslösers verriegeln können, um ein versehentliches Einschalten des Werkzeugs zu verhindern.

Das Werkzeug hat fünf Gänge, drei Gänge zum Anziehen und zwei Gänge zum Lösen. Die Geschwindigkeitsanpassung kann je nach Arbeitsgang angepasst werden. Außerdem hat es einen ergonomischen Griff für einen besseren Halt und hohe Genauigkeit.

- MOTOR BRUSHLESS
- LED-BELEUCHTUNG
- VOR-/RÜCKWÄRTS-DREHRICHTUNGSSCHALTER
- HANDGRIF
- 5 VERSCHIEDENE GÄNGE
- GURTHAKEN

DIE VERGLEICHSGERÄTE IN UNSEREN KÄSTEN SIND KOMPATIBEL MIT 4.0AH UND 6.0AH BATTERIEN.



60048

366,00€

N

3.26	-	4	64

AKKU-SCHLAGSCHRAUBER 3/4" 1300NM MIT BÜRSTENLOSER MOTOR

BATTERIE NICHT ENTHALTEN.



60005

132,00€

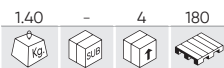

AKKU-SCHLAGSCHRAUBER BRUSHLESS

BATTERIE NICHT ENTHALTEN.

Dieses Werkzeug ist für ein schnelles Anziehen von Schrauben und Muttern vorgesehen und bei der Arbeit mit langen Verbindungselementen und harten Materialien besonders hilfreich. Der Schlagschrauber wird mit einer LED-Beleuchtung des Arbeitsbereichs für eine komfortable und präzise Arbeit, mit einem schnellwechselfähigen 1/4 Zoll-Sechskantspannfutter für eine schnelle Montage und Demontage der Düse, sowie mit einem Abzug mit der Verriegelungsfunktion für die Vorbeugung eines zufälligen Startens des Werkzeugs geliefert.



- A MOTOR BRUSHLESS
- B LED-BELEUCHTUNG
- C VOR-/RÜCKWÄRTS-DREHRICHTUNGSSCHALTER
- D HANDGRIFF
- E 5 VERSCHIEDENE GÄNGE
- F GURTHAKEN
- G BATTERIE NICHT ENTHALTEN



ZUBEHÖR UND ERSATZTEILE

SEITE 126

60024

190,00€



1/2" AKKU-RATSCHEN BRUSHLESS - 12V

BATTERIE NICHT ENTHALTEN.

Dieses Werkzeug ist fürs Anziehen/Lösen von Verbindungselementen an schwer zugänglichen Stellen vorgesehen.

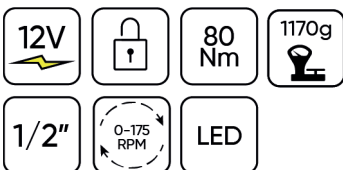

- A 1/2"-VIERKANTSCHAFT
- B VOR-/RÜCKWÄRTSDREHRICHTUNGSSCHALTER
- C LED-BELEUCHTUNG
- D AKKU-ANZEIGE
- E VERRIEGELUNG
- F 1 KIPPSCHALTER
- G ÜBERSPANNUNGSSCHUTZ

BEINHÄLTET

REF.	BESCHREIBUNG	kg	L	Stk	€	
60025	LADEGERÄT 12 V – FÜR REF. 60026	0.30	5	4	700	31,60€
60026	LITHIUM-IONEN-AKKUMULATOR 2.0 AH SAMSUNG – FÜR REF. 60024	0.20	5	40	1400	37,90€



60023

212,00€



AKKU-BOHRHAMMER BRUSHLESS

BATTERIE NICHT ENTHALTEN.

Dieses Werkzeug ist für das Schlagbohren und die Fugenbildung im Beton und Ziegel sowie fürs normale Bohren anderer Materialien wie Stahl, Holz, Metall, Keramik und Kunststoff vorgesehen.



- A MOTOR BRUSHLESS
- B TIEFENMESSER
- C STAUBSCHUTZDECKEL
- D SCHNELLSPANNFUTTER FÜRS WERKZEUG MIT EINEM SDS-SCHAFT
- E BETRIEBSMODUSSCHALTER
- F DREHRICHTUNGSSCHALTER
- G HANDGRIFF
- H LED-BELEUCHTUNG
- I BATTERIE NICHT ENTHALTEN



ZUBEHÖR UND ERSATZTEILE

SEITE 123



- BEINHALTET**
- 1 STÜCK: STAUBSCHUTZABDECKUNG
 - 1 STÜCK: TIEFENMESSER
 - 1 STÜCK: DER ZUSÄTZLICHER GRIFF
 - 1 STÜCK: SPITZMEISSEL
 - 1 STÜCK: FLACHMEISSEL
 - SDS BOHRER: Ø8/10/12 X 150 MM

60006

182,00€



ZWEIGANG AKKU-SCHLAGBOHRSCRAUBER BRUSHLESS

BATTERIE NICHT ENTHALTEN.

Dieses Werkzeug ist für das Bohren von Holz und Metall, für Schlagarbeiten überwiegend in Mauerwerk, Beton, Stein und roten Ziegeln sowie für das Anziehen/Lösen von Schrauben und Muttern vorgesehen.



- A MOTOR BRUSHLESS
- B LED-BELEUCHTUNG
- C VOR-/RÜCKWÄRTS-DREHRICHTUNGSSCHALTER
- D HANDGRIFF
- E GURTHAKEN
- F BATTERIE NICHT ENTHALTEN



ZUSÄTZLICHER HANDGRIFF



ZUBEHÖR UND ERSATZTEILE

SEITE 124

60047C

318,00€



N

AKKU-BOHRHAMMER MIT 2 GÄNGEN MIT KOFFER

BEINHALTET

REF.	BESCHREIBUNG	0.75	-	5	700	€
60013	LITHIUM-IONEN-AKKUMULATOR 4.0 AH	0.75	-	5	700	80,00€
60016	LADEGERÄT 20 V - 4A	0.80	-	5	210	49,00€

Dieses Werkzeug ist für das Bohren von Löchern in verschiedenen Arten von Materialien konzipiert. Es kann sowohl Bohrungen in Holz und Metall als auch Schlagbohrungen in Ziegel, Beton und Stein ausführen, die im Mauerwerk häufiger vorkommen. Er kann auch Schrauben und Muttern anziehen, lösen und abschrauben. Zu diesem Zweck verfügt er über einen Einstellring, mit dem Sie zwischen 20 verschiedenen Drehmomentstufen wählen können.

Er verfügt über einen Drehzahlwähler und einen Schalter zur Einstellung der Drehrichtung nach links oder rechts. Dieser Schalter, der sich in der mittleren Position befindet, ermöglicht es Ihnen, den Abzug zu sperren und ein versehentliches Einschalten des Werkzeugs zu verhindern.

Er ist mit einem LED-Licht ausgestattet, um die Sicht auf den Arbeitsbereich zu verbessern. Zum Zubehör gehören ein Gürtelhaken und ein Zusatzgriff für einen besseren Halt.

20V

150 Nm

1/2"

0-35000 BPM

1 0-550 RPM

2 0-2200 RPM

LED

1,62Kg

- MOTOR BRUSHLESS
- LED-BELEUCHTUNG
- VOR-/RÜCKWÄRTS-DREHRICHTUNGSSCHALTER
- HANDGRIFF
- 5 VERSCHIEDENE GÄNGE
- GURTHAKEN
- ZUSÄTZLICHER HANDGRIFF

DIE VERGLEICHSGERÄTE IN UNSEREN KÄSTEN SIND KOMPATIBEL MIT 4.0AH UND 6.0AH BATTERIEN.



ZUBEHÖR UND ERSATZTEILE

SEITE 124



60009

168,00€

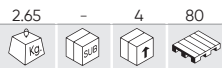

AKKU-POLIERMASCHINE BRUSHLESS

BATTERIE NICHT ENTHALTEN.

Das Werkzeug ist für Schlichtprozesse wie Polieren und Abrunden von Ecken und Kanten sowie für Oberflächenglättung mittels der Scheibe und Schleifunterlage vorgesehen.



- A MOTOR BRUSHLESS
- B 9-GANG-DREHSCHALTER:
800, 1000, 1200, 1400, 1600, 1800, 2000, 2200, 2400 U/MIN
- C SICHERHEITSSCHALTER
- D ERGONOMISCHER HANDGRIFF
- E DER ZUSÄTZLICHE D-FÖRMIGE HANDGRIFF
- F SPINDELHALTEKNOPF
- G SCHLEIFUNTERLAGE
- H BATTERIE NICHT ENTHALTEN



ERSATZTEILE VERFÜGBAR



60033

104,00€

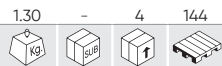

AKKU-EXZENTERSCHLEIFER BRUSHLESS

BATTERIE NICHT ENTHALTEN.

Dieses Werkzeug ist zum Schleifen von Produkten aus Holz, Eisen, Kunststoff und ähnlichen Materialien mit geeignetem Schleifpapier bestimmt. Der Aufbau dieser Schleifmaschine bietet drei Geschwindigkeiten, einen bequemen Griff und einen eingebauten Staubbeutel an.

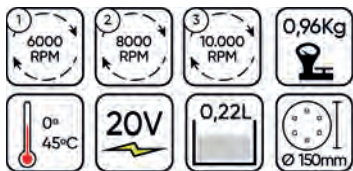

- A MOTOR BRUSHLESS
- B EIN-SCHALTER / TASTE ZUR GESCHWINDIGKEITSREGULUNG
- C AUS-SCHALTER
- D STAUBSAMMLER
- E RAHMEN
- F BATTERIE NICHT ENTHALTEN



ERSATZTEILE VERFÜGBAR

60049C

329,00€

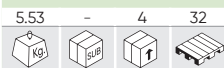

N

AKKU-WINKELSCHLEIFER BRUSHLESS 125MM MIT KOFFER

BEINHALTET

REF.	BESCHREIBUNG					€
60013	LITHIUM-IONEN-AKKUMULATOR 4.0 AH	0.75	-	5	700	80,00€
60016	LADEGERÄT 20 V - 4A	0.80	-	5	210	49,00€

BATTERIE NICHT ENTHALTEN.

Der kabellose Winkelschleifer ist für alle Arten von Schneid-, Polier- und Schleifarbeiten geeignet. Er verfügt über einen Frontalgriff und eine Schutzabdeckung.



SCHUTZMANTEL DER SCHLEIFSCHEIBE

DER ZUSÄTZLICHE HANDGRIFF

BATTERIE NICHT ENTHALTEN

DIE VERGLEICHSGERÄTE IN UNSEREN KÄSTEN SIND KOMPATIBEL MIT 4.0AH UND 6.0AH BATTERIEN.



ZUBEHÖR UND ERSATZTEILE

SEITE 127

ERSATZTEILE VERFÜGBAR

60028

142,00€



AKKU-WINKELSCHLEIFER BRUSHLESS - 125MM

BATTERIE NICHT ENTHALTEN.

Der kabellose Winkelschleifer ist für alle Arten von Schneid-, Polier- und Schleifarbeiten geeignet. Er verfügt über einen Frontalgriff und eine Schutzabdeckung.



SCHLÜSSEL



ZUBEHÖR UND ERSATZTEILE

SEITE 127

ERSATZTEILE VERFÜGBAR

60019

178,00€

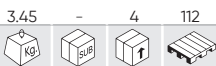

AKKU-SÄBELSÄGE BRUSHLESS

BATTERIE NICHT ENTHALTEN.

Dieses Werkzeug wurde zum Schneiden einer Vielzahl von Materialien entwickelt und ist weit verbreitet. Die Konstruktion ermöglicht durch den Schnellspannhalter ein schnelles und bequemes Auswechseln des Sägeblattes und zeichnet sich durch eine abhängig von der Arbeitsoperation einstellbare Schnittgeschwindigkeit aus.



- A MOTOR BRUSHLESS
- B SÄGEBLATT
- C SCHUH
- D SCHNELLSPANNHALTER
- E KNOPF ZUR VERRIEGELUNG DES STARTKNOPFS
- F ERGONOMISCHER HANDGRIFF
- G BATTERIE NICHT ENTHALTEN



ZUBEHÖR UND ERSATZTEILE

SEITE 128

ERSATZTEILE VERFÜGBAR

BEINHALTET
1 STÜCK: SÄGEBLATT FÜR HOLZ
1 STÜCK: SÄGEBLATT FÜR METALL

60020

175,00€



AKKU-HOBELMASCHINE BRUSHLESS

BATTERIE NICHT ENTHALTEN.

Dieses Werkzeug ist für die Arbeit mit Holz vorgesehen. Es lässt eine glatte Oberfläche des Holzes erhalten und eine Kegelform bei Bedarf geben. Der Hobel ist mit einer Aluminiumlegierung-Basis für die präzise Positionierung, einem Staubsammelsystem für die Staubabsaugung während der Holzbearbeitung und einem Abzugshalteknopf für die Vorbeugung eines zufälligen Startens des Werkzeugs ausgestattet.

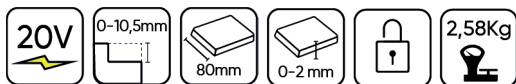

- A MOTOR BRUSHLESS
- B VERRIEGELUNGSKNOPF
- C EINSTELLSCHNITTIEFGRIFF
- D PARALLELE SCHNEIDFÜHRUNG
- E SPUNDTIEFENFÜHRUNG
- F EINSTELLSPUNDFÜHRUNGSGRIFF
- G STAUBENTFERNUNGSANSCHLUSS
- H V-GRABEN
- I BATTERIE NICHT ENTHALTEN



BEINHALTET
1 STÜCK: EINSTELLSCHNITTIEFGRIFF
1 STÜCK: PARALLELFÜHRUNG
3 STÜCKE: EINSTELLSCHNITTIEFGRIFFE
1 STÜCK: SCHLÜSSEL
1 STÜCK: SCHRAUBE

ERSATZTEILE VERFÜGBAR

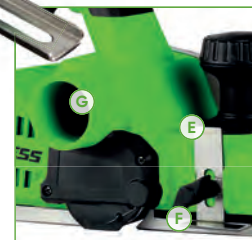

60010

170,00€

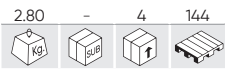

AKKU-STICHSÄGE BRUSHLESS

BATTERIE NICHT ENTHALTEN.

Dieses Werkzeug ist für das Sägen von Materialien wie Holz, Stahl, Kunststoff und Metall vorgesehen. Die Stichsäge ist mit einem 4-Positionen-Pendelmechanismus ausgestattet: 3 Positionen fürs Orbitalschneiden und 1 Position fürs direkte Schneiden, so dass Sie eine optimale Schnittgeschwindigkeit abhängig von der Härte des Materials wählen können.

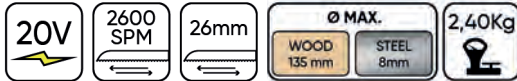

- A MOTOR BRUSHLESS
- B SCHUTZDECKEL DES SÄGEBLATTES
- C SCHNELLSPANNHALTER
- D SÄGEBLATT
- E PENDELHUBREGLER
- F SCHUHVERSTELLHEBEL
- G KNOPF ZUR VERRIEGELUNG DES STARTKNOPFS
- H BATTERIE NICHT ENTHALTEN



ERSATZTEILE VERFÜGBAR

ZUBEHÖR UND ERSATZTEILE

SEITE 128



BEINHALTET

- 1 STÜCK: HOLZ-SÄGEBLATT
- 1 STÜCK: KANTENFÜHRER
- 1 STÜCK: STAUBSAMMELROHR

60007

170,00€

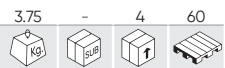

AKKU-KREISSÄGE BRUSHLESS

BATTERIE NICHT ENTHALTEN.

Dieses Werkzeug ist für das Sägen von Holz vorgesehen. Die Sägemaschine, mit einem Durchmesser von 165mm und mit 24 Zähnen, ist sowohl für gerade Längs-/Querschnitte als auch fürs Sägen von Holzbrettern und -platten unter einem Winkel von bis zu 45° ideal geeignet.



- A MOTOR BRUSHLESS
- B HEBEL FÜR DIE UNTERE SCHUTZABDECKUNG
- C SCHUH
- D UNTERE SCHUTZABDECKUNG
- E HANDGRIFF ZUR VERRIEGELUNG DES SCHNITTWINKELS SCHNITTWINKELS
- F VORDERER HANDGRIFF
- G TASTE DER ABZUGSVERRIEGLUNG
- H BATTERIE NICHT ENTHALTEN



ERSATZTEILE VERFÜGBAR

ZUBEHÖR UND ERSATZTEILE

SEITE 128



BEINHALTET

- 1 STÜCK: 165 MM 24T TCT SÄGEBLATT
- 1 STÜCK: KANTENFÜHRER
- 1 STÜCK: SECHSKANTSCHLÜSSEL

60011

175,00€

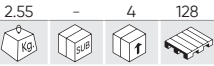

MINI AKKU-KREISSÄGE BRUSHLESS

BATTERIE NICHT ENTHALTEN.

Dieses Werkzeug ist für das Sägen von Holz vorgesehen. Die Kreissäge, mit einem Durchmesser von 115 mm und mit 24 Zähnen, ist sowohl für gerade Längs-/Querschnitte als auch fürs Sägen von Holzbrettern und -platten unter einem Winkel von bis zu 45° ideal geeignet. Diese Sägemaschine ist mit einem Abzugshalteknopf für die Vorbeugung eines unbeabsichtigten Startens des Werkzeugs und mit einem Aluminiumgehäuse versorgt.



- A MOTOR BRUSHLESS
- B UNTERE SCHUTZABDECKUNG DER SCHNEIDSCHLEIBE
- C HEBEL DER UNTEREN SCHUTZABDECKUNG
- D STÜTZPLATTE
- E OBERE SCHUTZABDECKUNG DER SCHNEIDSCHLEIBE
- F SCHNITTFÜHRUNG
- G ARRETIERUNGSKNOPF
- H BATTERIE NICHT ENTHALTEN



- BEINHALTET**
- 1 STÜCK: FÜHRUNG FÜR NUTEN.
 - 1 STÜCK: PARALLELFÜHRUNG
 - 1 STÜCK: SCHLÜSSEL
 - 1 STÜCK: STAUBBEUTEL



ZUBEHÖR UND ERSATZTEILE

ERSATZTEILE VERFÜGBAR SEITE 128

60022

470,00€

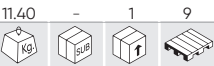

AKKU-KAPPSÄGE BRUSHLESS

BATTERIE NICHT ENTHALTEN.

Dieses Werkzeug ist fürs Sägen von Holz und ähnlichen Materialien vorgesehen. Mit dem Werkzeug können Sie schräge Schnitte machen wenn es an der Werkstückoberfläche erforderlich ist, Schnitte unter dem Winkel, die normalerweise für Verbindungen verwendet werden, die einen 90°-Winkel bilden. Sowie kombinierte Schnitte machen, wenn es gleichzeitig ein schräger Schnitt entlang der Kante und entlang der Vorderseite des Werkstückes erforderlich ist.

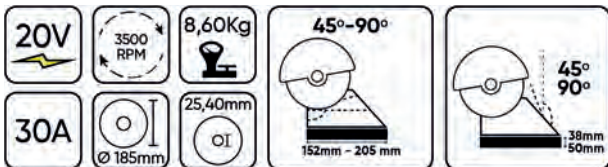

- BEINHALTET**
- 1 STÜCK: SÄGEBLATT MIT 40 ZÄHNEN
 - 1 STÜCK: SPANNVORRICHTUNG
 - 1 STÜCK: SCHLÜSSEL FÜR DIE SCHNITTSCHLEIBE
 - 1 STÜCK: STAUBSAMMELBEUTEL



ZUBEHÖR UND ERSATZTEILE

ERSATZTEILE VERFÜGBAR SEITE 128



60032

123,00€

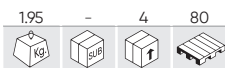

AKKU-KARTUSCHENPRESSE

BATTERIE NICHT ENTHALTEN.

Dieses Werkzeug ist für das Befüllen von beliebigen Spalten oder Rissen in verschiedensten Stoffen, wie Metall, Glas, Holz und Keramik bestimmt.



- A HALTER DER KARTUSCHE
- B KOLBEN
- C KOLBENSTANGE
- D KOLBENSTANGENGRIF
- E HAHN ZUM VERSCHIEBEN DER KOLBENSTANGE
- F GESCHWINDIGKEITSREGLER
- G LED-LEUCHE
- H BATTERIE NICHT ENTHALTEN



ERSATZTEILE VERFÜGBAR

60038

255,00€



BATTERIE-ÖLGERÄT

BATTERIE NICHT ENTHALTEN.

Dieses Werkzeug ist eine Schmierfettpresse. Dank der Batteriespeisung ist das Werkzeug einfach zu bedienen und zu transportieren.



- A SCHMIERFETTDOSIERUNGSRAD
- B SPERRTASTE
- C LED-BELEUCHTUNG
- D ELASTISCHER SCHLAUCH
- E SCHMIERROHR
- F WERKZEUGHALTER
- G BATTERIE NICHT ENTHALTEN



ERSATZTEILE VERFÜGBAR

60041

77,00€



OSZILLIERENDES MULTIFUNKTIONS AKKU-WERKZEUG

BATTERIE NICHT ENTHALTEN.

Zusammen mit dem multifunktionalen oszillierenden Werkzeug kann man verschiedene Vorrichtungen verwenden, um eine Vielzahl von Aufgaben auszuführen. Das Werkzeug eignet sich besonders zum Putzen, Schleifen und Tiefsägen an schwer zugänglichen Stellen.

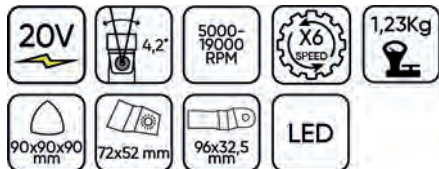

- A MOTOR BRUSHLESS
- B SPANNHEBEL
- C HALTEBÜGEL
- D HANDRAD FÜR DIE GESCHWINDIGKEITSAUSWAHL
- E ARBEITSLAMPE
- F WERKZEUGHALTER
- G BATTERIE NICHT ENTHALTEN



- BEINHALTET**
- 1 STÜCK: TAUCHSÄGEBLATT
 - 1 STÜCK: SCHLEIFBLATT
 - 1 STÜCK: SCHLEIFPLATTE
 - 1 STÜCK: SCHABER
 - 1 STÜCK: SCHEIBE
 - 1 STÜCK: HANDGRIFF

60037

222,00€



AKKU PROFI-TACKER UND NAGELPISTOLE

BATTERIE NICHT ENTHALTEN.

Das Werkzeug dient zum Befestigen von Pappe, Isoliermaterialien, Stoffen, Folien, Leder und ähnlichen Materialien an Holz oder anderen ähnlichen Oberflächen mittels Hochleistungshämmern mit Druckluft.



- A LED-BELEUCHTUNG
- B SICHERUNGSKONTAKTSTIFT
- C MAGAZIN
- D LED-ANZEIGE
- E ANTRIEBSSCHALTHEBEL
- F LED-BELEUCHTUNG AUSSCHALTER
- G BATTERIE NICHT ENTHALTEN



- ZUBEHÖR UND ERSATZTEILE**
- SEITE 127

LEICHTE KLAMMERN MIT SCHMALER DECKELGRÖSSE 18

MAX. KLAMMERLÄNGE	40 mm
MAX. KLAMMERQUERSCHNITTSBREITE	1.2 mm
MAX. KLAMMERQUERSCHNITTSDICKE	1 mm
MAX. QUERSCHNITTSBREITE DES KLAMMERS	6 mm

NÄGEL OHNE NAGELKOPFGRÖSSE 18

MAX. NAGELLÄNGE	50 mm
MAX. NAGELQUERSCHNITTSBREITE	1.25 mm
MAX. NAGELQUERSCHNITTSDICKE	1.05 mm

60042

106,00€



HEIZLUFT-AKKU-PISTOLE

BATTERIE NICHT ENTHALTEN.

Die elektrische Heißluftpistole wird hauptsächlich zum Schrumpfen von PVC, Schweißen, Biegen von Kunststoffteilen und zum normalen Trocknen, Schmelzen und Auftauen verwendet.



ERSATZTEILE VERFÜGBAR

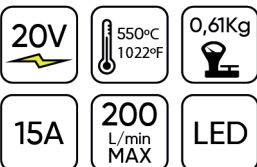

- A FRONTABDECKUNG
- B DÜSE
- C LED-BELEUCHTUNG
- D VERRIEGELUNG POWER-SCHALTER
- E LUFTEINLASSÖFFNUNG
- F BATTERIE NICHT ENTHALTEN

60043

123,00€



AKKU-FARBSPRÜHER

BATTERIE NICHT ENTHALTEN.

Dieses Werkzeug ist zum Sprühen von Farbe auf Oberflächen in geschlossenen oder offene Räumen.



ERSATZTEILE VERFÜGBAR



- A VERBRAUCHREGLER
- B BEHÄLTER
- C BEHÄLTERVERRIEGELUNG
- D LUFTFILTER
- E BATTERIE NICHT ENTHALTEN

VERWENDEN SIE ES MIT JBM-BATTERIEN: EINE EINZIGE BATTERIE, DIE FÜR ALLE WERKZEUGE GEEIGNET IST

DREI TYPEN VON BATTERIEN UND ZWEI TYPEN VON LADegeräten. WÄHLEN SIE DEN DER AM BESTEN FÜR SIE GEEIGNET IST!

**Akkus und Ladegeräte sind NICHT ENTHALTEN in den Werkzeugen.*



60001

88,00€

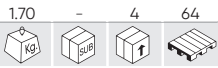

TRAGBARER STAUBSAUGER

BATTERIE NICHT ENTHALTEN.

Dieser kabellose Elektro-Staubsauger dient zur Reinigung von gesundheitlich unbedenklichen Materialien.



- A STAUBBEUTEL
- B TASTE ZUR ENTFERNUNG DES STAUBBEUTELS
- C HAUPTSCHALTER
- D MOTORGEHÄUSE
- E FUGENDÜSE
- F BÜRSTENAUFSATZ
- G BODENDÜSE
- H VERLÄNGERUNGSRÖHR
- I BATTERIE NICHT ENTHALTEN

BEINHALTET

REF.	BESCHREIBUNG					€
14950	VERLÄNGERUNGSRÖHR FÜR REF.60001	0.08	5	10	-	6,50€
14951	FUGENDÜSE FÜR REF.60001	0.01	-	10	-	9,50€
14952	KEHRDÜSE FÜR REF.60001	0.15	-	5	-	19,00€
14953	BÜRSTE FÜR REF. 60001	0.05	-	10	-	8,50€



60003

110,00€

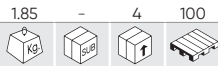

AKKU-LUFTPUMPE

BATTERIE NICHT ENTHALTEN.

Mit dieser Pumpe können Auto- und Fahrradreifen, Bälle, kleine Schlauchbote, Gummimatratzen / Schwimmbäder usw. aufgepumpt werden.



- A LED-ANZEIGE
- B SCHALTER MIT LED-ANZEIGE
- C BETRIEBSMODUSWAHLSCHALTER
- D DRUCKEINSTELLTASTEN
- E USB-ANSCHLUSS
- F HOCHDRUCKSCHLAUCH
- G HOCHLEISTUNGSSCHLAUCH
- H STECKER FÜR ZIGARETTENANZÜNDER IT EINER SPANNUNG VON 12 V/DC
- I BATTERIE NICHT ENTHALTEN

BEINHALTET



60004

79,00€

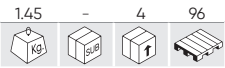

LED-BETRIEBSLEUCHE

BATTERIE NICHT ENHALTEN.

Diese LED-Betriebsleuchte ist zur Schaffung der notwendigen Beleuchtung im Arbeitsbereich und an anderen Stellen vorgesehen. Wenn der Akku leer ist, kann die Leuchte mittels eines Netzkabels an der Rückseite des Geräts an ein Stromnetz mit der 230 V-Spannung angeschlossen werden.



- A SCHALTER (ON/OFF)
- B DREHKOPF DER ARBEITSLAMPE
- C LED-MATRIX
- D SEITENPOSITIONSSPERRE
- E NETZKABEL
- F BATTERIE NICHT ENHALTEN



ERSATZTEILE VERFÜGBAR

REF. BESCHREIBUNG

REF.	BESCHREIBUNG	KG	BOX	UNIT	€	
15049	STATIV FÜR LED-BETRIEBSLEUCHE (REF. 60004)	2,10	-	4	120	37,40€

60035

30,00€



TRAGBARE LED-AKKU-LEUCHE

BATTERIE NICHT ENHALTEN.

Diese LED-Arbeitslampe ist für die Schaffung der notwendigen Beleuchtung im Arbeitsbereich und an anderen Stellen bestimmt. Sie arbeitet von einer tragbaren Lithium-Ionen-Batterie, was das Gerät tragbar und ideal für beliebige Arbeitsplätze und Situationen macht, wenn der Zugang zum Stromversorgungsnetz beschränkt ist.

Die Zerstreuungsscheibe der Leuchtdioden-Lampe gewährleistet einen Lichtstrom in Höhe von 500 und 1000 Lumen, und die Drehvorrichtung der Lampe (90°) ermöglicht die Einstellung des erforderlichen Winkels. Zum Gerät gehören auch ein weicher Griff für komfortablere Steuerung und der Aufhängehaken für die Befestigung an einem anderen Gegenstand.



- A ZERSTREUUNGSSCHEIBE
- B DREHVORRICHTUNG
- C AUFHÄNGEHAKEN
- D EIN/AUS-SCHALTER
- E BATTERIE NICHT ENHALTEN



ERSATZTEILE VERFÜGBAR



60039

265,00€

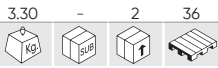

AKKU-HOCHDRUCKREINIGER BRUSHLESS

BATTERIE NICHT ENTHALTEN.

Hochdruckwaschanlage mit bürstenlosem Motor ist für die Reinigung von Fahrzeugen, Geräten, Werkzeugen, Gartenmöbeln uws. bestimmt.

20V	22-25 BAR	1,95Kg
319-517 PSI	2-2.4 L/min.	

- A MOTOR BRUSHLESS
- B 5-POSITIONEN-DREHDÜSE
- C SCHNELLKUPPLUNG DRÜSE
- D ROHR
- E DRUCKANZEIGE
- F DRUCKWÄHLSCHALTER
- G VERRIEGELUNGSSCHALTER
- H SCHNELLKUPPLUNG SCHLAUCH
- I BATTERIE NICHT ENTHALTEN



60027

99,00€

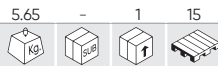

INDUSTRIE AKKU-RÜCKENSPRÜHGERÄT MIT EIN 15L TANK

BATTERIE NICHT ENTHALTEN.

Das Werkzeug eignet sich zur Desinfektion von Privathäuser, öffentliche Plätze, Viehzuchtfarmen, Gärten usw. und ermöglicht es, alle gefährlichen Partikel zu vernichten, ihre Ausbreitung zu verhindern und die Insektenvermehrung und Krankheitsentwicklung gleichzeitig zu vermeiden. Ein enthält Smart-Griff Druckregler auf der Membranpumpe, der beim Stromfehlen die Pumpe automatisch ausschaltet sowie eine Sperre für die Dauerbetrieb vorsieht. 4 Düsen mit dem bestimmten Fluss und der bestimmten Leistung, je nach Anforderungen, sind ebenfalls im Lieferumfang enthalten: 1 Hohlkegeldüse, 1 Doppel-Hohlkegeldüse, 1 verstellbare Düse mit 4 Öffnungen, 1 Fächerdüse.

20V	0,3-0,45 Mpa	15L	40-80 cm	1-1,2m	4,74Kg
-----	--------------	-----	----------	--------	--------

- A EIN HANDGRIFF FÜR DIE EINFACHE BEFÖRDERUNG
- B ATMUNGSFÄHIGES UND ERGONOMISCHES RÜCKENKISSEN,
- C EINE EINFÜLLKLAPPE MIT VERRIEGELUNG
- D TELESKOPSPRÜHSTÜTZE
- E BATTERIE NICHT ENTHALTEN

NIMMT KEINE 6.0AH-BATTERIEN AUF

BEINHÄLTET



60029

240,00€

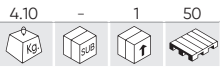

KETTENSÄGE MIT BÜRSTENLOSEM MOTOR

BATTERIE NICHT ENTHALTEN.

Dieses Werkzeug für den Forstdienst wurde entwickelt, um Holzschneidarbeiten wie das Fällen, Entasten, Hacken und Schneiden von Bäumen durchzuführen. Er ist mit einem Drehknopf zum Einstellen der Führungsschiene und der Kettenbremse, einer Kettenbremse, um die Kette bei einem Rückschlag zu stoppen, und einem Kettenfänger, um die Kette aufzufangen, wenn sie abbricht oder abspringt, ausgestattet. Außerdem verfügt es über ein automatisches System zur Kettenschmierung und einen Auslöseschalter-Sperrknopf, um ein versehentliches Starten des Werkzeugs zu verhindern. Es umfasst auch eine Führungsschiene, eine Kette und eine Abdeckung, um sowohl die Schiene als auch die Kette für Lagerung und Transport zu schützen.



- A MOTOR BRUSHLESS
- B SÄGEKETTE
- C FÜHRUNGSSCHIENE
- D KETTENBREMSE/VORDERER HANDSCHUTZ
- E VORDERER GRIFF
- F SPERR-TASTE
- G DECKEL DES ÖLBEHÄLTERS
- H BATTERIE NICHT ENTHALTEN



BEINHALTET



60030

112,00€

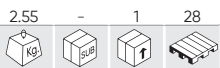

AKKU-LAUBBLÄSER

BATTERIE NICHT ENTHALTEN.

Dieses Werkzeug ist für die Beseitigung vom Laub, Gras, Papier und ähnlichen Stoffen bestimmt. Batteriespeisung und leichte Konstruktion erleichtern den Transport des Werkzeuges von einer Stelle zur anderen. In der Konstruktion sind ein Umschalter des hohen/niedrigen Luftstromes und -Volumens, sowie ein weicher Griff zur Arbeitsbequemlichkeit vorgesehen.



- A MOTOR BRUSHLESS
- B ROHR
- C ROHRENDSTÜCK DES GEBLÄSES
- D GEHÄUSE
- E BATTERIE NICHT ENTHALTEN

NIMMT KEINE 6.0AH-BATTERIEN AUF



60031

142,00€

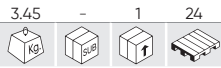

AKKU-HECKENSCHERE

BATTERIE NICHT ENTHALTEN.

Dieses Werkzeug ist für die schnelle und bequeme Erfüllung der Gartenaufgaben, wie Schneiden, Scheren oder Beschneiden von Gartenhecken oder Strüchern bestimmt. Batteriespeisung und leichte Konstruktion erleichtern den Transport des Werkzeuges von einer Stelle zur anderen. Zum Lieferumfang des Gerätes gehören die Schutzhaube, die den Strauchschneider in erforderlicher Position hält, das Schutzgehäuse, das hilft, Schrott oder andere Abfälle von den Armen und den Augen des Bedieners abzuführen, sowie der zusätzliche Griff, die höhere Kontrolle und komfortablere Arbeitsbedingungen ermöglicht. Außerdem sind in der Konstruktion zwei Ausschalter und ein Verriegelungsknopf, der ein unerwartetes Einschalten des Werkzeuges ausschließt, vorgesehen.



- A MOTOR BRUSHLESS
- B SCHNEIDE
- C SCHNEIDENHALTER
- D HAUBE
- E ZUSÄTZLICHER GRIFF
- F ZUSÄTZLICHER AUSSCHALTER
- G VERRIEGELUNGSKNOPF
- H HINTERER GRIFF
- I BATTERIE NICHT ENTHALTEN



BEINHALTET
SCHUTZKAPPE



60040

440,00€



MULTI-PURPOSE BATTERIE-GARTENMASCHINE (4 IN 1)

BATTERIE NICHT ENTHALTEN.

Das multifunktionale elektrische Gartenwerkzeug (4 in 1) ist für Vielzahl von Outdoor-Aufgaben wie Säubern von Grünflächen, Beschneiden von Hecken, Beschneiden von Ästen usw. bestimmt. Ideal für die umfassende Gartenpflege.

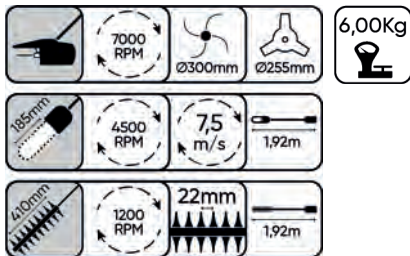

- A MOTOR BRUSHLESS
- B SCHUTZABDECKUNG
- C DREIZACKKLINGE
- D KLINGE
- E SÄGE
- F GRIFFE
- G FREISCHNEIDER
- H MÄHKOPF
- I HECKENBESTOSSMASCHINE
- J STANGENSÄGE
- K BATTERIE NICHT ENTHALTEN



52598

1.080,00€

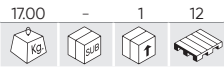

RASENMÄHER-ROBOTER

Moderner und funktioneller Rasenmäherroboter, perfekt für die Pflege und Instandhaltung Ihres Rasens und Ihrer Grünflächen. Er ist mit einem bürstenlosen Motor ausgestattet, der von einem leistungsstarken 5200-Ah-Akku angetrieben wird, der eine Autonomie von ca. 150 Minuten ermöglicht. Die Schneidplatte hat drei Stahlklingen für einen Mulchschnitt. Dieses Schnittsystem zerkleinert das Gras sehr fein und wirft es dann direkt auf den Boden, wodurch der Rasen ein tadelloses Aussehen erhält, ohne dass das Schnittgut entfernt wird. Außerdem zersetzt sich bei diesem Schnitt das auf dem Rasen abgelagerte Gras und wird zu Nährstoffen für den Boden, wodurch ein ganz natürlicher biologischer Kreislauf entsteht. Der mitgelieferte Begrenzungsdraht und die Pflöcke ermöglichen eine einfache, werkzeuglose Installation.

5200 mAh Capacité de la batterie battery capacity	1400m ² Superficie de coupe mowing area	IP X4	DC 15-25.5V tension de sortie tension de sortie	2,5h	22m/min
115,44W consommation de puissance power consumption	AC 100-240V 50/60Hz tension d'alimentation input voltage	7,5Kg	2h	70 dB(A)	50-35,5-24 cm



APP-VERBINDUNG



- A MOTOR BRUSHLESS
- B STOP-TASTE
- C LADESTATION
- D HINTERRAD
- E GRIFF-ABDECKUNG

60045

298,00€

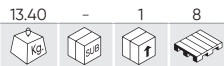

KABELLOSER RASENMÄHER

BATTERIE NICHT ENTHALTEN.

Dieser kabellose Rasenmäher hält Ihren Garten in perfektem Zustand. Er ist mit einem bürstenlosen Motor ausgestattet, der die Effektivität erhöht und den Geräuschpegel verringert. Außerdem ist er sehr leicht und einfach zu bedienen.

40V	800W	35L	11,6 Kg.
3.300 RPM	6x 25-75mm	152 - 203mm Ø	370mm Ø
96 dB(A)	IP X1	4.0A	11,40Kg



- A MOTOR BRUSHLESS
- B RASENMÄHER
- C HANDGRIFF
- D GRASAUFFANGBEUTEL

FUNKTIONIERT MIT 2 4AH-BATTERIEN (NICHT EINGESCHLOSSEN)



VERWENDEN SIE ES MIT JBM-BATTERIEN: EINE EINZIGE BATTERIE, DIE FÜR ALLE WERKZEUGE GEEIGNET IST

DREI TYPEN VON BATTERIEN UND ZWEI TYPEN VON LADEGERÄTEN. WÄHLEN SIE DEN DER AM BESTEN FÜR SIE GEEIGNET IST!

**Akkus und Ladegeräte sind NICHT ENTHALTEN in den Werkzeugen.*



LITHIUM-IONEN-AKKUMULATOR

- POWER-KONTROLL-LEUCHE**
- KURZSCHLUSSSCHUTZ**
- ÜBERHITZUNGSSCHUTZ**
- ÜBERLADESCHUTZ**



60012

0.45 - 5 920

48,00€

20V 2.0Ah 0,41Kg



60013

0.75 - 5 700

80,00€

20V 4.0Ah 0,69Kg



60015

1.00 - 20 630

138,00€

20V 6.0Ah 0,95Kg



FÜR REF. 60024

60026

0.20 5 40 1400

37,90€

12V 2.0Ah 0,18Kg

LADEGERÄT

- 100V / 240V
- 50-60 Hz
- POWER-KONTROLL-LEUCHE**
- KURZSCHLUSSSCHUTZ**
- ÜBERHITZUNGSSCHUTZ**
- ÜBERLADESCHUTZ**



60016

0.80 - 5 210

49,00€

20V 4A 0,57Kg



SCHNELL-LADGERÄT

60017

0.80 - 5 290

64,00€

20V 6A 0,69Kg



FÜR REF. 60026

60025

0.30 5 4 700

31,60€

12V 0,27Kg

2.0AH
30min +/-10min

4.0AH
60min +/-15min

6.0AH
90min +/-15min

2.0AH
30min +/-10min

4.0AH
45min +/-10min

6.0AH
60min +/-15min

2.0AH
60min +/-10min

ZUBEHÖR



REF. BESCHREIBUNG	mm						€
14622 ABLAGEFACH FÜR REF. 60001, 60003, 60004, 60020	320x180	A	0,95	-	10	360	17,00€
14623 HALTER FÜR REF. 60005, 60006, 60018	70x84	B	0,10	-	10	800	8,00€
14624 ABLAGEFACH FÜR REF. 60007, 60010, 60011	290x160	C	0,65	-	10	300	17,00€
14625 ABLAGEFACH FÜR REF. 60008, 60009	40x200x100	D	0,50	-	10	700	14,00€
14626 HALTER FÜR REF. 60023	115x70	E	0,10	-	10	-	7,00€
16364 HAKEN MIT EINEM EINSATZ 280MM	280		0,20	-	200	-	3,50€

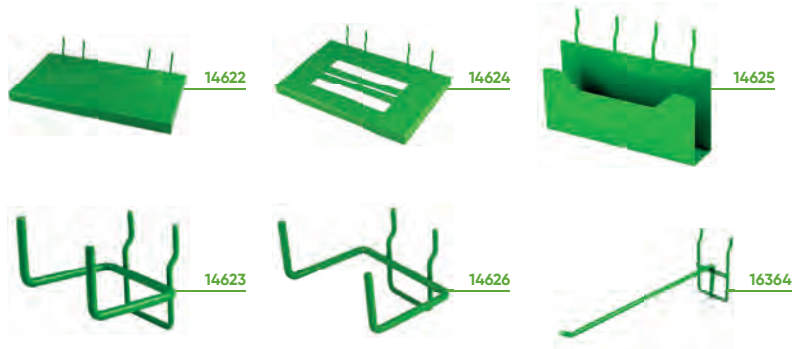

ERSATZTEILE



MEISSEL SDS-PLUS

REF. BESCHREIBUNG				€
14837 SPITZMEISSEL SDS-PLUS 14X250MM	0,25	10	100	3,30€
14838 FLACHMEISSEL SDS-PLUS 20X250MM	0,25	10	100	3,40€
14839 FLACHMEISSEL SDS-PLUS 40X250MM	0,29	10	50	4,70€
14840 NUTENMEISSEL SDS-PLUS 250MM	0,27	10	50	3,35€



53850 14,90€

0,65	5	25	1000

SCHAFTBOHRER-SET FÜR DEN BOHRHAMMER SDS-PLUS



ERSATZTEIL VERFÜGBAR

REF.	mm				€
14826	Ø 5x110mm	0,05	125	500	1,50€
14828	Ø 6x110mm	0,05	25	500	1,50€
14829	Ø 6x160mm	0,04	25	500	1,50€
14830	Ø 8x110mm	0,04	25	500	1,50€
14831	Ø 8x160mm	0,05	25	500	1,50€
14832	Ø 10x160mm	0,05	25	200	2,00€
14920	Ø 12x160mm	0,10	100	200	2,50€

AUCH VERFÜGBAR...

REF.	mm				€
14825	Ø 4x110mm	0,05	100	200	1,50€
14827	Ø 5x160mm	0,04	25	500	2,00€
14833	Ø 10x210mm	0,10	20	200	2,05€
14834	Ø 12x210mm	0,10	100	200	2,50€
14835	Ø 14x210mm	0,10	20	125	3,00€
14836	Ø 16x210mm	0,14	20	120	3,50€



14841

2,58€

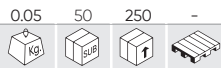

SDS-PLUS-BOHRFUTTER-ADAPTER 1/2"



14842

9,50€

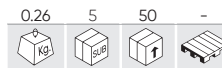

SCHNELLWECHSELBOHRFUTTER 2-13 MM 1/2"-20 UND (STANDARDMÄSSIGES FEINGEWINDE)



60006
60047C

53860

3,65€

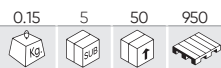

SET BETONBOHRER 4-10 MM



ERSATZTEIL VERFÜGBAR

REF.	mm				€
14908	Ø 4x75mm	0.01	50	100	0,60€
14909	Ø 5x80mm	0.01	50	100	0,80€
14910	Ø 6x100mm	0.01	50	100	1,00€
14912	Ø 8x120mm	0.05	50	100	1,55€
14914	Ø 10x120mm	0.04	20	100	2,10€

AUCH VERFÜGBAR...

REF.	mm				€
14915	Ø 11x150mm	0.05	20	100	2,65€
14916	Ø 12x150mm	0.06	20	100	2,95€
14917	Ø 13x150mm	0.10	20	100	3,45€



53861

5,45€

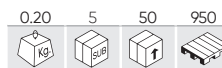

SET BETONBOHRER 3-10 MM



ERSATZTEIL VERFÜGBAR

REF.	mm				€
14907	Ø 3x60mm	0.01	50	100	0,50€
14908	Ø 4x75mm	0.01	50	100	0,60€
14909	Ø 5x80mm	0.01	50	100	0,80€
14910	Ø 6x100mm	0.01	50	100	1,00€
14911	Ø 7x100mm	0.01	50	100	1,30€
14912	Ø 8x120mm	0.05	50	100	1,55€
14913	Ø 9x120mm	0.05	50	100	1,90€
14914	Ø 10x120mm	0.04	20	100	2,10€



53859

67,00€

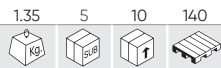

SET VON BIMETALL-LOCHSÄGEN MIT ADAPTERN



- x6 22, 29, 35, 44, 51, 68mm
- x2 14-30mm, 32-152mm



ERSATZTEIL VERFÜGBAR

REF.	mm				€
14901	22mm	0.04	10	50	3,60€
14902	29mm	0.08	10	50	4,65€
14903	35mm	0.10	10	50	5,25€
14904	44mm	0.12	10	50	6,85€
14905	51mm	0.12	10	50	8,50€
14906	68mm	0.19	10	50	10,20€
14934	14-30mm	0.07	10	50	4,25€
14935	32-152mm	0.20	10	50	8,45€

SPIRALBOHRER-SET HSS 4341

53852 207,00€

4.20 - 4 192

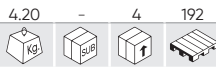

170 PCS HSS-G 4341

METAL 1-10 mm

53856 62,00€

1.32 5 10 550

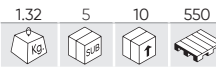

25 PCS HSS-G 4341

METAL 1-13 mm

53854 27,00€

0.63 5 20 192

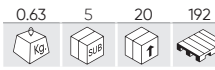

19 PCS HSS-G 4341

METAL 1-10 mm

ERSATZTEIL VERFÜGBAR

REF.	mm				€
14868	Ø 1x34mm	0.01	50	400	0,55€
14869	Ø 1.5x40mm	0.01	50	400	0,60€
14870	Ø 2x49mm	0.01	50	400	1,00€
14871	Ø 2.5x57mm	0.01	50	400	1,00€
14872	Ø 3x61mm	0.01	50	400	1,00€
14873	Ø 3.5x70mm	0.01	50	400	1,00€
14874	Ø 4x75mm	0.01	50	400	1,00€
14875	Ø 4.5x80mm	0.01	50	400	1,50€
14876	Ø 5x86mm	0.01	50	300	1,50€
14877	Ø 5.5x93mm	0.02	50	300	1,50€
14878	Ø 6x93mm	0.02	25	400	2,00€
14879	Ø 6.5x101mm	0.02	25	400	2,00€
14880	Ø 7x109mm	0.03	25	400	2,50€
14881	Ø 7.5x109mm	0.03	25	400	2,50€
14882	Ø 8x117mm	0.04	25	400	3,00€
14883	Ø 8.5x117mm	0.04	25	400	3,50€
14884	Ø 9x125mm	0.05	25	400	3,65€
14885	Ø 9.5x125mm	0.05	25	400	4,00€
14886	Ø 10x133mm	0.06	25	400	4,60€
14887	Ø 10.5x133mm	0.07	25	400	5,00€
14888	Ø 11x142mm	0.08	25	400	6,00€
14889	Ø 11.5x142mm	0.09	25	400	6,50€
14890	Ø 12x151mm	0.10	25	300	7,00€
14891	Ø 12.5x151mm	0.09	25	200	7,50€
14892	Ø 13x151mm	0.09	25	200	8,00€



1x34, 1.5x40, 2x49, 2.5x57, 3x61, 3.5x70, 4x75, 4.5x80, 5x86, 5.5x93, 6x93, 6.5x101, 7x109, 7.5x109, 8x117, 8.5x117, 9x125, 9.5x125, 10x133mm

1x34, 1.5x40, 2x49, 2.5x57, 3x61, 3.5x70, 4x75, 4.5x80, 5x86, 5.5x93, 6x93, 6.5x101, 7x109, 7.5x109, 8x117, 8.5x117, 9x125, 9.5x125, 10x133, 10.5x133, 11x142, 11.5x142, 12x151, 12.5x151, 13x151mm

1x34, 1.5x40, 2x49, 2.5x57, 3x61, 3.5x70, 4x75, 4.5x80, 5x86, 5.5x93, 6x93, 6.5x101, 7x109, 7.5x109, 8x117, 8.5x117, 9x125, 9.5x125, 10x133mm

SPIRALBOHRER-SET HSS 4241 - SCHWARZ

53851 88,00€

3.80 - 4 192

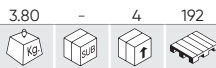

170 PCS HSS-G 4241

METAL 1-10 mm

53855 24,80€

1.19 5 10 192

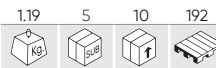

25 PCS HSS-G 4241

METAL 1-13 mm

53853 14,40€

0.58 5 20 192

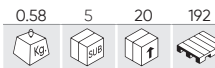

19 PCS HSS-G 4241

METAL 1-10 mm

ERSATZTEIL VERFÜGBAR

REF.	mm				€
14843	Ø 1x34mm	0.01	50	400	0,50€
14844	Ø 1.5x40mm	0.01	50	400	0,50€
14845	Ø 2x49mm	0.01	50	400	0,50€
14846	Ø 2.5x57mm	0.01	50	400	0,50€
14847	Ø 3x61mm	0.01	50	400	0,50€
14848	Ø 3.5x70mm	0.01	50	400	0,50€
14849	Ø 4x75mm	0.01	50	400	1,00€
14850	Ø 4.5x80mm	0.01	50	400	1,00€
14851	Ø 5x86mm	0.01	50	300	1,00€
14852	Ø 5.5x93mm	0.01	50	300	1,00€
14853	Ø 6x93mm	0.02	25	400	1,00€
14854	Ø 6.5x101mm	0.02	25	400	1,00€
14855	Ø 7x109mm	0.02	25	400	1,00€
14856	Ø 7.5x109mm	0.03	25	400	1,00€
14857	Ø 8x117mm	0.03	25	400	1,50€
14858	Ø 8.5x117mm	0.04	25	400	1,50€
14859	Ø 9x125mm	0.04	25	400	1,50€
14860	Ø 9.5x125mm	0.05	25	400	2,00€
14861	Ø 10x133mm	0.05	25	400	2,00€
14862	Ø 10.5x133mm	0.06	25	400	2,00€
14863	Ø 11x142mm	0.07	25	400	2,50€
14864	Ø 11.5x142mm	0.07	25	400	2,50€
14865	Ø 12x151mm	0.08	25	300	2,50€
14866	Ø 12.5x151mm	0.09	25	200	3,00€
14867	Ø 13x151mm	0.09	25	200	3,00€



1x34, 1.5x40, 2x49, 2.5x57, 3x61, 3.5x70, 4x75, 4.5x80, 5x86, 5.5x93, 6x93, 6.5x101, 7x109, 7.5x109, 8x117, 8.5x117, 9x125, 9.5x125, 10x133mm

1x34, 1.5x40, 2x49, 2.5x57, 3x61, 3.5x70, 4x75, 4.5x80, 5x86, 5.5x93, 6x93, 6.5x101, 7x109, 7.5x109, 8x117, 8.5x117, 9x125, 9.5x125, 10x133, 10.5x133, 11x142, 11.5x142, 12x151, 12.5x151, 13x151mm

1x34, 1.5x40, 2x49, 2.5x57, 3x61, 3.5x70, 4x75, 4.5x80, 5x86, 5.5x93, 6x93, 6.5x101, 7x109, 7.5x109, 8x117, 8.5x117, 9x125, 9.5x125, 10x133mm

SATZ SPIRALBOHRER HSS-CO5 KOBALT

N

54348 291,00€



170 PCS HSS CO5

METAL 1-10 mm

54314 82,00€



25 PCS HSS CO5

METAL 1-13 mm

54313 43,00€

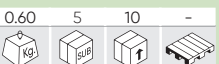

19 PCS HSS CO5

METAL 1-10 mm

ERSATZTEIL VERFÜGBAR

REF.	mm				€
16318	Ø 1x34mm	0.50	25	400	0,50€
16319	Ø 1.5x40mm	0.50	25	400	0,50€
16320	Ø 2x49mm	0.50	25	400	0,50€
16321	Ø 2.5x57mm	0.50	25	400	1,00€
16322	Ø 3x61mm	0.50	25	400	1,00€
16323	Ø 3.5x70mm	0.50	25	400	1,00€
16324	Ø 4x75mm	0.05	25	400	1,50€
16325	Ø 4.5x80mm	0.50	25	400	1,50€
16326	Ø 5x86mm	0.50	25	400	2,00€
16327	Ø 5.5x93mm	0.50	25	400	2,00€
16328	Ø 6x93mm	0.50	25	400	2,50€
16329	Ø 6.5x101mm	0.50	25	400	3,00€
16330	Ø 7x109mm	0.50	25	400	3,50€
16331	Ø 7.5x109mm	0.50	25	400	3,50€
16332	Ø 8x117mm	0.50	25	400	4,00€
16333	Ø 8.5x117mm	0.05	5	200	4,50€
16334	Ø 9x125mm	0.50	25	200	5,50€
16335	Ø 9.5x125mm	0.50	25	200	6,00€
16336	Ø 10x133mm	0.50	25	200	6,50€
16583	Ø 10.5x133mm	0.07	25	200	8,50€
16584	Ø 11x142mm	0.07	25	200	10,50€
16585	Ø 11.5x142mm	0.08	25	200	11,50€
16586	Ø 12x151mm	0.10	25	200	13,00€
16587	Ø 12.5x151mm	0.10	25	200	14,00€
16588	Ø 13x151mm	0.11	25	200	15,00€



1x34, 1.5x40, 2x49, 2.5x57, 3x61, 3.5x70, 4x75, 4.5x80, 5x86, 5.5x93, 6x93, 6.5x101, 7x109, 7.5x109, 8x117, 8.5x117, 9x125, 9.5x125, 10x133mm

1x34, 1.5x40, 2x49, 2.5x57, 3x61, 3.5x70, 4x75, 4.5x80, 5x86, 5.5x93, 6x93, 6.5x101, 7x109, 7.5x109, 8x117, 8.5x117, 9x125, 9.5x125, 10x133, 10.5x133, 11x142, 11.5x142, 12x151, 12.5x151, 13x151mm

1x34, 1.5x40, 2x49, 2.5x57, 3x61, 3.5x70, 4x75, 4.5x80, 5x86, 5.5x93, 6x93, 6.5x101, 7x109, 7.5x109, 8x117, 8.5x117, 9x125, 9.5x125, 10x133mm

53857

27,00€

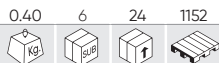

SCHLAGBOHRER-SET MIT SCHNELLWECHSELADAPTER S2

57 PCS S2



AUSSTELLER MIT 6 STÜCK



BEINHALTET

	x9	PH	25mm	1x3, 2x3, 3x3
	x9	PZ	25mm	1x3, 2x3, 3x3
	x4	H	25mm	3, 4, 5, 6
	x6	SL	25mm	4x2, 5x2, 6x2
	x14	TX	25mm	10x2, 15x2, 20x2, 25x2, 27x2, 30x2, 40x2
	x7	T	25mm	10, 15, 20, 25, 27, 30, 40
	x7		65mm	PH2, PH3, PZ1, PZ2, T20, T25, SL6
	x1		60mm	

* AUCH GEEIGNET FÜR REF. 60005

53858

28,80€



SCHLAGBOHRER-SET MIT SCHNELLWECHSELADAPTER S2

33 PCS S2



AUSSTELLER MIT 6 STÜCK



BEINHALTET

	x4	PH	25mm	1, 2x2, 3
	x3	PZ	25mm	1, 2, 3
	x4	H	25mm	3, 4, 5, 6
	x4	SL	25mm	3, 4, 5, 6
	x6	TX	25mm	10, 15, 20, 25, 30, 40
	x6		75mm	T15, T20, T25, PH2, PZ2, SL5
	x4		48mm	6, 7, 8, 10mm
	x1		60mm	
	x1		80mm	

* AUCH GEEIGNET FÜR REF. 60005

54346

11,50€

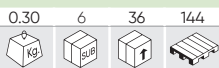

N

3ER SET REINIGUNGSBÜRSTEN FÜR BOHRMASCHINEN

3 PCS PP 1/4"

- A Ø 88mm
- B Ø 100mm
- C Ø 50mm



60037

BRAD STIFTNÄGEL FÜR NAGELPISTOLE

REF.	mm				€
53999	25x1,25mm	0.20	-	50	2,00€
54000	30x1,25mm	0.25	-	50	2,50€
54002	38x1,25mm	0.30	-	50	3,00€

1000 PCS



SATZ VON KLAMMERN MIT 18 KALIBER

REF.	mm				€
54008	25x6mm	0.45	-	40	3,50€
54010	32x6mm	0.55	-	40	4,50€
54011	38x6mm	0.65	-	40	5,00€

1000 PCS



60028
60049C

15014

20,00€



M14 115-230 mm

SCHNELLSICHERUNGSMUTTER M14 FÜR WINKELSCHLEIFER



AKKU-WERKZEUGE

FÜR METALL

REF.	FÜR	BESCHREIBUNG					€
14893	60008	T42 - 115x2,5mm	0.05	50	100	-	2,00€
14894	60028	T42 - 125x2,5mm	0.05	50	200	-	1,20€
14895	60008	T27 - 115x6mm	0.15	25	100	-	1,90€
14896	60028	T27 - 125x6mm	0.78	25	100	-	2,10€

FÜR EDELSTAHL

REF.	FÜR	BESCHREIBUNG					€
14897	60008	T41 - 115x1mm	0.01	50	400	-	0,88€
14898	60028	T41 - 125x1mm	0.03	50	400	-	0,98€
14899	60008	T41 - 115x1,6mm	0.03	50	400	-	0,88€
14900	60028	T41 - 125x1,6mm	0.04	50	400	-	0,98€



14893

T27	80 m/s	13300 RPM
Ø115mm	Ø22,23mm	



14894

T42	80 m/s	12200 RPM
Ø125mm	Ø22,23mm	



14897

T41	80 m/s	13300 RPM
Ø115mm	Ø22,23mm	



14898

T41	80 m/s	12200 RPM
Ø125mm	Ø22,23mm	



14895

T42	80 m/s	13300 RPM
Ø115mm	Ø22,23mm	



14896

T27	80 m/s	12200 RPM
Ø125mm	Ø22,23mm	



14899

T41	80 m/s	13300 RPM
Ø115mm	Ø22,23mm	



14900

T41	80 m/s	12200 RPM
Ø125mm	Ø22,23mm	



- 60007
- 60010
- 60011
- 60019
- 60022

FÜR METALL (EDELSTAHL, ALUMINIUM, KUPFER)

REF.	FÜR	BESCHREIBUNG					€
14988	60007	24T 165mm	0.25	20	40	2400	8,00€
14989	60011	24T 115mm	0.10	20	100	3600	6,00€
14990	60022	40T 185mm	0.30	20	40	2200	10,50€
14993	60010	T118A	0.05	20	200	7200	5,00€
14995	60019	150mm 24TPI	0.05	20	200	8400	8,00€

FÜR HOLZ

REF.	FÜR	BESCHREIBUNG					€
14985	60007	24T 165mm	0.25	20	40	2400	6,00€
14986	60011	24T 115mm	0.10	20	100	3600	4,00€
14987	60022	40T 185mm	0.30	20	40	2200	8,50€
14991	60010	T244D	0.05	20	200	7200	2,00€
14994	60019	150mm 6TPI	0.05	20	200	8400	3,50€



14989

x24	7000 RPM
Ø115mm	Ø10mm



14988

x24	7000 RPM
Ø165mm	Ø20mm



14990

x40	7000 RPM
Ø185mm	Ø25,4mm



14955

24TPI	10mm
150mm	



14994

6TPI	150mm
150mm	



14991

T244D	100mm
100mm	



14993

T118A	8mm
76mm	



14986

x24	7000 RPM
Ø115mm	Ø10mm



14985

x24	7000 RPM
Ø165mm	Ø20mm



14987

x40	7000 RPM
Ø185mm	Ø25,4mm

BELEUCHTUNG

130 TRAGBARE WERKSTATTLAMPEN

132 STIRNLAMPEN

134 TACHENLAMPEN

135 LEUCHTEN

136 HAUBENBELEUCHTUNG

137 RUNDLEUCHTEN

139 ARBEITSSCHEINWERFER

142 SIGNALISIERUNG

144 ZUBEHÖR UND ERSATZTEILE

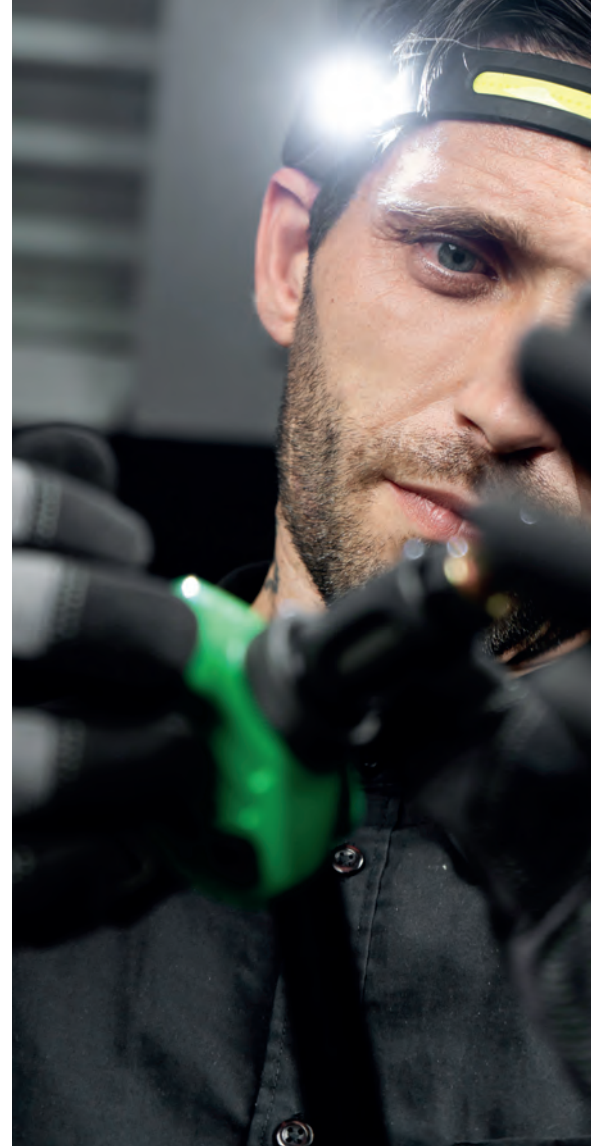

53734

23,70€

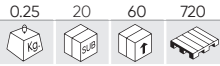

ARBEITSLEUCHE - 400LM



DREHFUSS 360°
MAGNETISIERT



AUSWAHL DER
INTENSITÄT DES
LICHTS



USB-
LADEGERÄT



MIT HÄNGER



AUSSTELLER
MIT 20 STÜCK

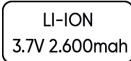
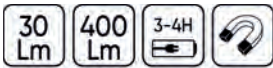

53519

42,00€

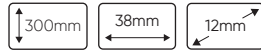
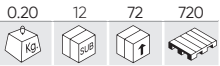

ULTRADÜNNE TRAGBARE COB-
TASCHENLAMPE

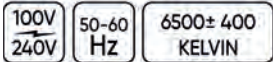
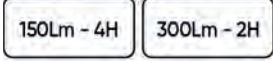
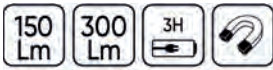

AUSSTELLER
MIT 12 STÜCK

52536

57,00€

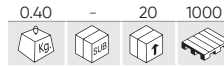

COB-LED-LEUCHE MIT AKKU

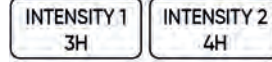

51889

49,00€

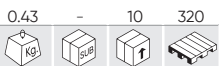

TRAGBARE LEUCHE 24 + 6 LEUCHTIONEN
MIT

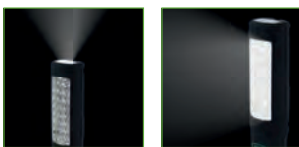

53216

49,00€

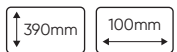
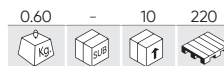

TRAGBARE COB-LED-LEUCHE MIT
FLEXIBLEM SOCKEL



TRAGBARE LED-LAMPE MIT DER FLEXIBLEN MAGNET BASIS

54122 38,00€

0.39 12 24 384

300 Lm	3-4H		
LED 3W - 7H	COB 3W - 2,5H		
LITHIUM 3.7V 2.000mA	6500± 400 KELVIN		
IP 44	68-71 ICR	100V 240V	5V 1A

54123 40,00€

0.39 12 24 384

500 Lm	6-7H		
LED 3W - 14H	COB 5W - 3H		
LITHIUM 3.7V 4.000mA	6500± 400 KELVIN		
IP 44	68-71 ICR	100V 240V	5V 1A

54124 47,00€

0.39 12 24 384

1000 Lm	6-8H		
LED 3W - 14H	COB 10W - 3H		
LM 1000 5min	900 30min	700 145min	
LITHIUM 3.7V 4.000mA	6500± 400 KELVIN		
IP 44	68-71 ICR	100V 240V	5V 1A

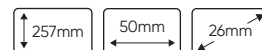

AUSSTELLER MIT 12 STÜCK

REF. BESCHREIBUNG

14031 USB-NETZADAPTER

0.10 10 100 1152 € 7,90€

54379 28,00€

0.23 12 48 1440

140mm 73mm 20mm

N

SOLARBETRIEBENES, WIEDERAUFLADBARES ARBEITSLICHT

80-800 Lm	5,2V	0,5W	
3,5H	4-12H	BANCO DE ENERGIA POWER BANK	
80Lm 3W COB	800Lm 10W COB		
x1 LI-POLI 3.7V - 4000mAh			

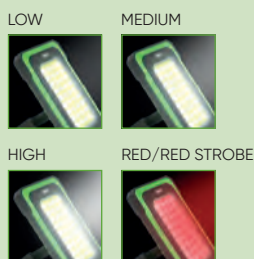

AUSSTELLER MIT 12 STÜCK

53776 19,10€

0.15 12 48 1872

150mm 40mm 23mm

TASCHENLAMPE MIT BATTERIE

90 Lm	300 Lm	2,5H	
300Lm 5W COB - 3H	LI-ION 3.7V 1500mah		
250Lm 3W COB - 3,5H	ABS	TPR	
90Lm 3W LED - 6H			



AUSSTELLER MIT 12 STÜCK



250LM 3W COB

300LM 5W COB

90LM 3W LED

54344

10,50€

0,10	10	100	1200

LED-SCHEINWERFER HUT

120 Lm	60 Lm	25 Lm
--------	-------	-------

LM 120	60	25
40min	6-8h	8-10h

3.7V 250mAh	2H
-------------	----

LUZ DISPERSA SCATTERED LIGHT	1W
---------------------------------	----

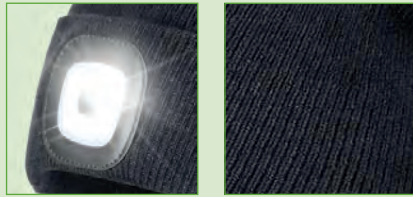

ABNEHMBARE LEUCHTEINHEIT

POLYESTER (65%)
ACRYL (35%)



N

52987

20,00€

0,17	10	40	720

TASCHENLAMPE MIT BATTERIE

120 Lm	2,5H
--------	------

120Lm - 2,5H	
--------------	--

LITHIUM 3.7V 1.000mAh	LED 3W COB
--------------------------	---------------



AUSSTELLER MIT 10 STÜCK



53780

14,50€

0,45	5	20	300

LED-BETRIEBSLEUCHTE 400LM

400 Lm	6W	220V 240V
--------	----	--------------

IP 20	50 Hz
-------	-------

6000± 7000 KELVIN

H05RN-F 2x0.75mm ² - 5m



2,5 M KABEL

52384

29,00€

0,33	-	20	600

EXTRAFLACHE LED-COB-LEUCHTE

- Kabellänge: 5 m
- Kabellänge DC: 0,1 m
- Kabellänge DC bis Zange: 0,3 m

200 Lm	12V 24V
--------	------------

LED 3W COB

75mm	325mm	90mm
------	-------	------



53217

47,00€

0,30	-	20	620

TRAGBARE COB-LED-LEUCHTE

200 Lm	4H
--------	----

LED 2W COB	
---------------	--

LITHIUM 3.7V 2.200mah	LITHIUM 5V 1.000mah
--------------------------	------------------------



45mm	380mm
------	-------

54004

16,00€

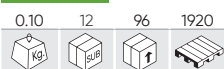

COB-STIRNLAMPE

COB 350Lm -5W COB	LED 90Lm -3W XPE
COB 350Lm - 2,5H 150Lm - 5 H Flash - 8 H	LED XPE 150Lm - 4H 60Lm - 8 H
LI-ION 3.7V 1.200mA	Gel de silice Silica gel
2m	IP X4

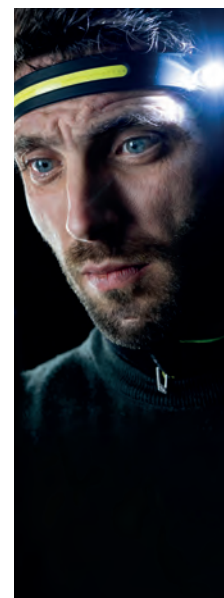

BERÜHRUNGSFAHRTASTE

Betätigen Sie zum Ein-/ Ausschalten. Halten Sie ihre Hand vor der Taste zum Beleuchtungseinschalten oder -ausschalten

- Material: Kiesegel
- Netzanzeige, Induktionsanzeige
- Bewegungsmelder - Aktivierungsmodus
- USB-Ladekabel im Lieferumfang enthalten



AUSSTELLER MIT 12 STÜCK



53569

18,00€



STIRNLEUCHT 800LM (COB + CREE)

- FOKUS REGLER
- 3 HELLIGKEITS MODI
- WIEDERAUFLADBARE BATTERIEN
- BETRIEBSANZEIGE



MAX 800 Lm	2,5H	150m
LED COB + CREE	x2 18650	
High Low Flash	COB	



53568

12,00€



STIRNLEUCHT 350LM

- FOKUS REGLER
- 3 HELLIGKEITS MODI

MAX 350 Lm	2,5H	150m
High Low Flash SOS		
LI-ION 2000mAh		



54267

9,50€

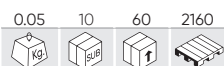

LED-HANDSCHUH

70 Lm	120 mAh	+20H
LED	DERECHA RIGHT	
x2 CR2016	INCLUIDAS / INCLUDED	
x2 LED 3.0V		



BELEUCHTUNG

53974

38,00€

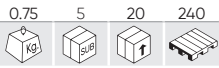

WIEDERAUFLADBARE ARBEITSLEUCHE

1500 Lm

5-6H **100%** **50%**
2.5H 6H

LED 20W COB **ABS**

100% SOS **50% FLASH**

4 BELEUCHTUNG
100% 50% SOS FLASH



MEHRFACH-POSITIONIERUNG

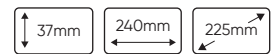

52555

2,38€

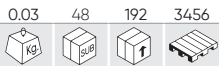

TASCHENLAMPE MIT 9 LEDS



27 Lm **x9 LED** **x3 AAA**

30mm 93mm AUSSTELLER MIT 12 STÜCK

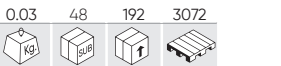

52558

2,38€

ERSATZ BATTERIEN

REF.	BESCHREIBUNG	0.01	60	2400	134400	€
51258	"AAA" R03 1,5V					0,15€

FÜR REF. 51326, 52233, 52555, 52558

51326

4,40€

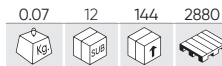

21-LED-LEUCHE



63 Lm **x21 LED** **x3 AAA**

95mm 35mm AUSSTELLER MIT 12 STÜCK

REF.	BESCHREIBUNG	0.05	10	500	€
10923	9V				1,10€

FÜR REF. 52162, 52450, 51929, 50942



53427

5,00€

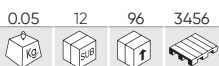

6-LED MINI-TASCHENLAMPE MIT MAGNETEINSATZ



AUSSTELLER MIT 12 STÜCK

45 Lm **x6 LED** **x3 AAA**



51573

2,50€



DYNAMO LEUCHE MIT 2 LEUCHTDIODEN



6 Lm **x2 LED**

LIEFERUMFANG: EINZELVERPACKUNG



53227

28,00€

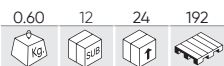

DESKTOP LED-VERGRÖSSERUNGSLEUCHE

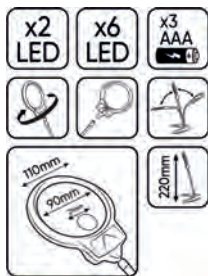

53085

30,00€

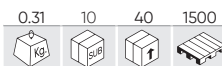

LUPE MIT LED-BELEUCHTUNG

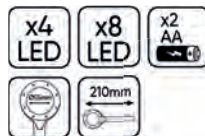

STATIV FÜR LED-LAMPE

REF.	Max.	Min.	kg	sub	sub	€
53506	1830mm	840mm	2.40	-	8	36,00€
52254	2770mm	1290mm	3.51	-	4	64,00€



53505

77,00€



LED-STRAHLER 50W



54039

154,00€

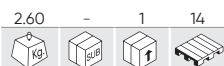

INDUSTRIELLE LED-LAMPE

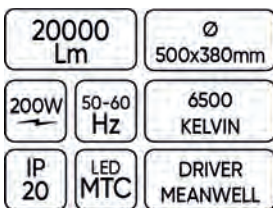

54133

547,00€



SATZ VON 6 INDUSTRIELLEN LED-LAMPEN 54039



REF. BESCHREIBUNG

15385 ERSATZLAMPENSCHIRM FÜR 54039



54088

132,00€



INDUSTRIELLE LED-LAMPE

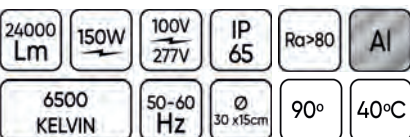

BELEUCHTUNG

54270

42,00€

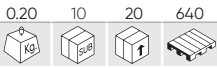

LED-LAMPE MIT MAGNET HALTER

1000 Lm 3-4H

LED 1000Lm- 2H LED 400Lm- 5H

x2 LI-ION 3.7V - 1200mAh USB TYPE-C



54271

54,00€

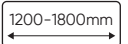
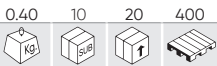

MAGNET-LEDLEISTE MIT HAUBENBAND

1000 Lm 3-4H

LED 1000Lm- 2H LED 400Lm- 5H

x2 LI-ION 3.7V - 1200mAh USB TYPE-C



GELENKTE

53707

153,00€

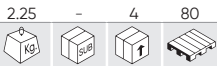

LED-LAMPE MIT MAGNET HALTER - MOTORHAUBE

1000 Lm 7-8H 6H ABS

LED 3x5W COB 350Lm 700Lm 1000Lm

x4 LI-ION 3.7V - 2600mAh



3 HELLGKEITS MODI
WIEDERAUFLADBARE BATTERIE
BATTERIE LADEANZEIGE

VERBESSERT DIE SICHTBARKEIT DES ARBEITSBEREICHS
360 GRAD GERICHTETE BELEUCHTUNG
MIT MAGNETISCHE UNTERSTÜTZUNG ZUR ANPASSUNG AN JEDE SITUATION



53570

154,00€

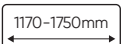
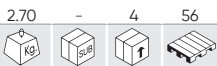

LED-LAMPE - MOTORHAUBE

1000 Lm 7-8H 6H

LED 3x5W COB 400Lm 800Lm 1200Lm

x4 LI-ION 3.7V - 2600mAh



3 HELLGKEITS MODI
WIEDERAUFLADBARE BATTERIE
BATTERIE LADEANZEIGE

VERBESSERT DIE SICHTBARKEIT DES ARBEITSBEREICHS
360 GRAD GERICHTETE BELEUCHTUNG



54173 87,00€

0.75 5 20 240

WIEDERAUFLADBARE LED LEUCHE MAGNETSOCKEL

- FUNKTIONEN:
 FUNKTION 1: BLITZE
 FUNKTION 2: ZWEI BLITZE
 FUNKTION 3: DREHUNG

20W 5V x45 LED

PC ABS 2-3H 2-3H

LI-ION 7.4V - 2200mA -30°C 50°C IP 65



REF. BESCHREIBUNG €

16053 USB-KABEL TYPE A/RUNDER STECKER 5.5MM 0.05 10 100 2,85€

54172 81,00€

0.80 5 20 240

WIEDERAUFLADBARE LED-LEUCHTEFLEXIBLER SOCKEL

- FUNKTIONEN:
 FUNKTION 1: BLITZE
 FUNKTION 2: ZWEI BLITZE
 FUNKTION 3: DREHUNG

20W 5V x45 LED

PC ABS 2-3H 2-3H

LI-ION 7.4V - 2200mA -30°C 50°C IP 65



REF. BESCHREIBUNG €

16052 USB-KABEL TYPE A/RUNDER STECKER 3,5 MM 0.05 10 100 2,09€

53691 36,00€

0.70 - 20 320

LED-RUNDUMLEUCHE MAGNETISCH

- FUNKTIONEN:
 FUNKTION 1: BLITZE
 FUNKTION 2: ZWEI BLITZE
 FUNKTION 3: DREHUNG



x8 LED 18W 12V 24V IP 66

112mm 125cm -30°C 50°C

4m PC ECE R10 ECE R65



53690 34,00€

0.55 - 20 200

LED-RUNDUMLEUCHE 12-24 V MIT FLEXIBLEM SOCKEL

- FUNKTIONEN:
 FUNKTION 1: BLITZE
 FUNKTION 2: ZWEI BLITZE
 FUNKTION 3: DREHUNG



x8 LED 18W 12V 24V IP 66

182mm 125cm -30°C 50°C

PC ECE R10 ECE R65



52375 38,00€

0.70 - 20 240

LED ROTATIONSBLITZLEUCHE 12-24V

- ABS-BAES.
 - STOSSSCHUTZ.
 - KABEL: 2,5 M ANSCHLUSS FÜR ZIGARETTENANZÜNDER.
 - LEISTUNGS-AUFNAHME: 9W.

- FUNKTIONEN:
 FUNKTION 1: DREHUNG
 FUNKTION 2: ZWEI BLITZE
 FUNKTION 3: SECHS BLITZE

12V 24V 9W

170mm 140cm IP 56

2,5m PC/ABS ECE R10



MAGNETISCHER SOCKEL

52456 36,00€

0.60 - 20 160

LED-RUNDUMLEUCHE

- PC.
 - STOSSSCHUTZ.
 - LEISTUNGS-AUFNAHME: 8 W.

- FUNKTIONEN:
 FUNKTION 1: DREHUNG
 FUNKTION 2: ZWEI BLITZE
 FUNKTION 3: SECHS BLITZE

12V 24V 8W PC/ABS

240mm 128cm IP 56



ABS - BAES FLEXIBLEM SOCKEL

BELEUCHTUNG

51964

28,00€

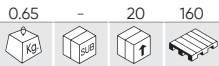

RUNDUMLEUCHTE MIT FLEXIBLEM SOCKEL



Stoßschutz.
Lichtstreuerscheibe: PC
Gewinde des Lichtstreu-ers mit sicherer Dichtung
Drehzahl, U/min: 40
Zahn-/Schneckengetriebe
Lampe H1, 12V 55W
Mit Gewindefuß
Ladestromaufnahme: 3,0 A.

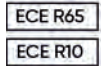

ABS - BAES
FLEXIBLEM SOCKEL

51965

29,50€

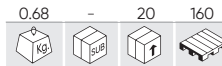

RUNDUMLEUCHTE MIT FLEXIBLEM SOCKEL 24V 70W



Stoßschutz.
Lichtstreuerscheibe: PC
Gewinde des Lichtstreu-ers mit sicherer Dichtung
Drehzahl, U/min: 40
Zahn-/Schneckengetriebe
Lampe H1, 24V 70W
Mit Gewindefuß
Ladestromaufnahme: 3,0 A.

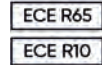

ABS - BAES
FLEXIBLEM SOCKEL

51962

25,00€

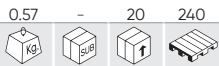

RUNDUMLEUCHTE OHNE KABEL H1 12V 55W



Stoßschutz.
Lichtstreuerscheibe ABS - BAES.
Gewinde des Lichtstreuers mit sicherer Dichtung.
Drehzahl, U/min: 40.
Zahn-/Schneckengetriebe.
Lampe H1, 12V 55W
Ladestromaufnahme: 3,0 A.
Zugelassene Konstruktion.



51963

29,00€

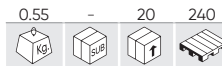

RUNDUMLEUCHTE OHNE KABEL H1 24V 70W



Stoßschutz.
Lichtstreuerscheibe ABS - BAES.
Gewinde des Lichtstreuers mit sicherer Dichtung.
Drehzahl, U/min: 40.
Zahn-/Schneckengetriebe.
Lampe H1, 24V 70W
Ladestromaufnahme: 3,0 A.
Zugelassene Konstruktion.

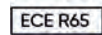

51960

34,00€

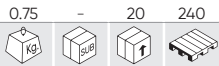

RUNDUMLEUCHTE 12V 55W



Lichtstreuerscheibe ABS - BAES .
Gewinde des Lichtstreuers mit sicherer Dichtung.
Drehzahl, U/min: 40.
Zahn-/Schneckengetriebe.
Lampe: H1, 12V 55W
H1, 24V 35W.
Kabel: 4 m, Spiral mit Anschluss für Zigaretten-anzünder.
Ladestromaufnahme: 3,0 A.



51961

34,00€

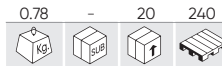

RUNDUMLEUCHTE MIT MAGNETFUSS UND KABEL H1 24V 70W

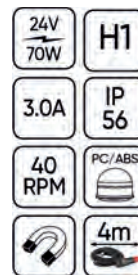

Lichtstreuerscheibe ABS - BAES .
Gewinde des Lichtstreuers mit sicherer Dichtung.
Drehzahl, U/min: 40.
Zahn-/Schneckengetriebe.
Lampe: H1, 24V 70W
H1, 24V 35W.
Kabel: 4 m, Spiral mit Anschluss für Zigaretten-anzünder.
Ladestromaufnahme: 3,0 A.

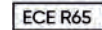

ROTATIONSBLITZLEUCHTE (NIEDRIG)

REF.					€
52827		0.50	-	20	400 46,00€
52828		0.54	-	20	320 43,00€
52910		0.50	-	20	320 39,00€

- UMSCHALTER IN 3 POSITIONEN.
- 3 BETRIEBSARTEN:
DREHEN OHNE BLINKEN
SECHS BLITZE
DUAL FLASH MODUS



51966

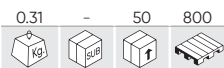

18,00€

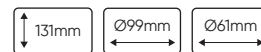

NIEDRIGE RUNDUMLEUCHTE 12 V MIT KABEL



- Lichtstreuweise ABS - BAES.
- XENON.
- Ladestromaufnahme: 3,0 A.



MIT TULPENFORM GEWINDEFÜSS

ZUBEHÖR

REF.	BESCHREIBUNG					€
11103	ERSATZLAMPEN FÜR REF. 51966	0.01	-	100	-	6,00€
10766	LAMPEN FÜR RUNDUMLEUCHTEN 51960, 51962	0.01	-	200	-	1,59€
10750	RUNDUMLEUCHTEN AUFSTECKROHR FÜR 51964, 51965, 52456	0.25	-	50	-	13,00€
10751	RUNDUMLEUCHTEN AUFSTECKROHR MIT AUFSTELLFÜSSEN	0.30	-	50	-	15,00€
52843	AUFKLAPPBARE STANGE FÜR RUNDUMLEUCHTE	0.90	-	20	1500	31,60€
51969	KAPPE FÜR RUNDUMLEUCHTE - ORANGE	0.12	-	50	1000	14,00€
11324	KAPPE FÜR RUNDUMLEUCHTE - BLAU FÜR REF. 51960, 51961, 51964	0.13	-	100	-	17,50€
11325	KAPPE FÜR RUNDUMLEUCHTE - ROT	0.12	-	50	451	17,50€



LED-ARBEITSSCHEINWERFER STREULICHT

53428

18,00€

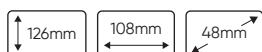
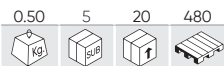

53429

18,00€

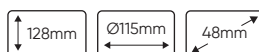
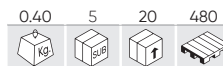

BELEUCHTUNG

52566

28,00€

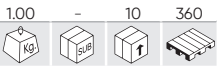

1450 Lm x9 LED 27W 10V/40V
 +30.000H IP 68
 LUZ DISPERSA SCATTERED LIGHT AI

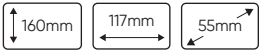

52567

29,00€

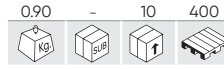

1450 Lm x9 LED 27W 10V/40V
 +30.000H IP 68
 LUZ DISPERSA SCATTERED LIGHT AI

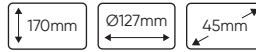

52302

25,40€

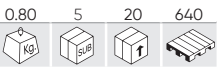

1450 Lm x9 LED 27W 10V/40V
 +30.000H IP 68
 LUZ DISPERSA SCATTERED LIGHT AI

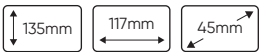

52303

26,40€

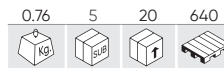

1450 Lm x9 LED 27W 10V/40V
 +30.000H IP 68
 LUZ DISPERSA SCATTERED LIGHT AI

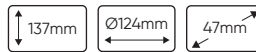

53049

89,00€

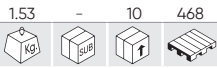

3600 Lm x4 LED 40W 9V/36V
 +30.000H IP 68
 LUZ DISPERSA SCATTERED LIGHT AI



53052

158,00€

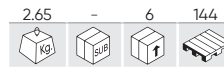

7200 Lm x8 LED 80W 9V/36V
 +30.000H IP 68
 LUZ DISPERSA SCATTERED LIGHT AI

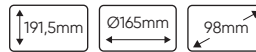

53045

35,00€

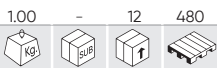

2800 Lm x16 LED 48W 10V/40V
 +20.000H IP 67
 LUZ DISPERSA SCATTERED LIGHT AI

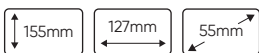

53046

39,00€

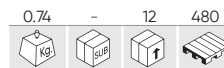

2272 Lm x16 LED 24W 9V/36V
 +20.000H IP 68
 LUZ DISPERSA SCATTERED LIGHT AI



LED-ARBEITSSCHEINWERFER GEBÜNDELTES LICHT

52568 28,00€

0.75 - 10 400



1450 Lm x9 LED 27W 10V/30V

+30.000H IP 68

LUZ CONCENTRADA SPOTLIGHT AI



165mm 117mm 45mm

52569 28,00€

0.70 5 20 320



1450 Lm x9 LED 27W 10V/30V

+30.000H IP 68

LUZ CONCENTRADA SPOTLIGHT AI



170mm Ø127mm 45mm

53048 89,00€

1.50 - 10 1000



3600 Lm x4 LED 40W 9V/36V

+30.000H IP 68

LUZ CONCENTRADA SPOTLIGHT AI



118mm 123mm 87mm

53051 158,00€

2.75 - 6 468



7200 Lm x8 LED 80W 9V/36V

+30.000H IP 68

LUZ CONCENTRADA SPOTLIGHT AI



191,5mm Ø165mm 98mm

52415 19,00€

0.60 5 20 640



1450 Lm x9 LED 27W 10V/40V

+30.000H IP 68

LUZ CONCENTRADA SPOTLIGHT AI



127mm 110mm 50mm

52414 19,00€

0.55 5 20 600



1450 Lm x9 LED 27W 10V/40V

+30.000H IP 68

LUZ CONCENTRADA SPOTLIGHT AI



127mm Ø110mm 55mm

53047 330,00€

3.51 - 4 40



3200 Lm x10 LED 50W 12V/24V

6500 KELVIN 280cm IP 67

LUZ CONCENTRADA SPOTLIGHT AI

DREHBAR

EINSTELLBARE BEWEGUNGS-GESCHWINDIGKEIT

REMOTE KONTROLL 100M



230mm 185mm 150mm

BELEUCHTUNG

54161 90,00€

2.75 - 6 48 2100mm

TELESKOPISCHE ANHÄNGER LICHTLEISTE VON 1,4 BIS 2,1 M

DIYNAMISCHE LICHTER



VERORDNUNG	GENEHMIGUNG
3	E9*3R02/17*23444*00
4	E9*4R00/19*23444*00
6	E9*6R01/29*23444*00
7	E9*7R02/27*23444*00
10	E9*10R06/00*22232*02



54163 80,00€

1.85 - 6 54 140mm 1100mm

1.020X140MM ANHÄNGER LICHTLEIST MIT 2X LEUCHTEN

DIYNAMISCHE LICHTER



VERORDNUNG	GENEHMIGUNG
3	E9*3R02/17*23444*00
4	E9*4R00/19*23444*00
6	E9*6R01/29*23444*00
7	E9*7R02/27*23444*00
10	E9*10R06/00*22232*02

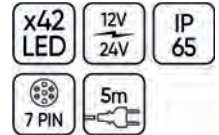

50910 45,00€

1.90 - 6 54 140mm 1100mm

1.020X140MM ANHÄNGER LICHTLEISTE MIT 2X LEUCHTEN + 2 DREIECKIGEN KATZENAUGEN



VERORDNUNG	GENEHMIGUNG
4	E4*4R-0024080
6	E4*6R-0124080
7	E4*7R-0224080
10	E9*10R06/02*23498*00

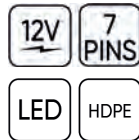

52838 56,00€

1.85 - 6 54 140mm 1100mm

1.020X140MM ANHÄNGER LICHTLEIST MIT 2X LEUCHTEN



GENEHMIGUNG
E4*7R-0218756

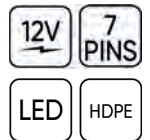

MAGNETISCHER SET MIT ZWEI LED-LEUCHTEN FÜR ANHÄNGER

GLATTES KABEL: 7,5M
SPIRALKABEL: 2,5M

54162 81,00€

1.50 - 6 144 x42 LED, 12V/24V, 7 PINS, IP 65



GENEHMIGUNG
E9*7R02/27*23444*00

DIYNAMISCHE LICHTER



51886 44,00€

1.50 - 8 112 12V, 7 PINS



VERORDNUNG	GENEHMIGUNG
3	E4*3R-023749
4	E4*4R-0024080
6	E4*6R-0124080
7	E4*7R-0224080
10	E9*10R06/02*23498*00

52839 64,00€

1.47 - 8 128 12V, 7 PINS



VERORDNUNG	GENEHMIGUNG
3	E4*3R-0218756
4	E4*4R-0018756
6	E4*6R-0118756
7	E4*7R-0218756
10	E9*10R06/02*23199*01

54044 99,00€

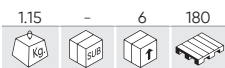

SATZ MIT ZWEI DRAHTLOSEN MAGNET-RÜCKSEINWERFERN



GENEHMIGUNG

E9*10R05/01*16210*02

53151 14,00€

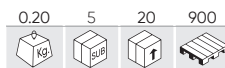

LED-RÜCKLICHT FÜR ANHÄNGER



- 4 Funktionen:
- Blau: Position und Platte.
- Rot: Bremsleuchte.
- Gelb: Richtungsanzeiger des Gleitens.
- Weiß: Masse.

LED-Rücklicht für Anhänger

REF.					€
54160L	Linke	0.20	5	20	17,50€
54160R	Rechts	0.20	5	20	17,50€

- 4 Funktionen:
- Schwarz: Position und Platte.
- Rot: Bremsleuchte.
- Grün: Richtungsanzeiger des Gleitens.
- Weiß: Masse.

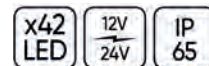

GENEHMIGUNG

E9*7R02/27*23444*00
E9*10R06/01*23199*00

DIYNAMISCHE LICHTER



53536 34,00€



ANHÄNGERLICHTTESTER 7/13-POL



REF. BESCHREIBUNG

REF.	BESCHREIBUNG				€
14753	7-POL ADAPTER FÜR REF. 53536	0.20	-	50	13,00€

51929 22,00€



ANHÄNGERLICHTTESTER 7-POL



ANHÄNGER STECKDOSE

FAHRZEUG STECKDOSE

BELEUCHTUNG

AKUSTISCHE WARNEINRICHTUNG 12-80 V

REF.	DB	IP	V	°C				€
51967	97DB	IP65	12V-80V	-30/70°C	0.20	50	1200	16,00€
51968	107DB	IP65	12V-80V	-30/70°C	0.23	50	1000	16,00€

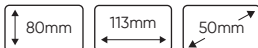

- Beständig gegen verschiedene klimatische Bedingungen.
- Kann mit Wasser unter Druck gewaschen werden.
- Umpolungsschutz.
- Abdichtung mit Epoxydharz.



54078



68,00€



SICHERHEITSLICHT FÜR GABELSTAPLER

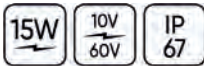

Ovale Sicherheitslaterne mit 2 blauen LEDs. Die Laterne projiziert blaues gerichtetes Licht auf den Boden, um die vorbeigehenden Menschen zu warnen.

Ein solches Warnlicht hilft, Kollisionen und Unfälle zwischen Gabelstaplern und Personen zu vermeiden, und erhöht außerdem die Sicherheit in einer Produktionsumgebung, insbesondere in Toten Winkel Zonen. Ideal für lärmbelastete Umgebungen.



ZIGARETTENANZÜNDER-ANSCHLÜSSE UND SPANNUNGSWANDLER

REF.	BESCHREIBUNG					€
10961	SPANNUNGSWANDLER	0.08	-	50	-	13,00€
11107	ZIGARETTENANZÜNDER-ANSCHLUSS	0.06	-	250	-	4,50€
11989	KFZ-LADEKABEL (ANSCHLUSS DES ZIGARETTENANZÜNDERS)	0.04	-	200	-	2,00€
13839	USB-NETZADAPTER 110V / 60HZ	0.04	-	200	-	8,50€
14031	USB-NETZADAPTER	0.10	10	100	1152	7,90€
14032	USB-ADAPTER - ZIGARETTENANZÜNDER	0.10	10	100	1200	12,00€
14033	USB-KABEL TYPE A/MICRO-B	0.10	10	100	500	4,50€
16052	USB-KABEL TYPE A/RUNDER STECKER 3,5 MM	0.05	10	100	-	2,09€
16053	USB-KABEL TYPE A/RUNDER STECKER 5.5MM	0.05	10	100	-	2,85€



DRUCKLUFTWERKZEUGE

- 147 SCHRAUBENDREHEN
- 151 BOHREN
- 152 SCHNEIDEN/SCHNEIDEN
- 153 SCHLEIFEN/POLIEREN
- 156 LUFTPISTOLEN
- 158 REIFENWARTUNG
- 160 SONSTIGES
- 163 ROLLEN/SCHLÄUCHE
- 165 ANSCHLÜSSE
- 166 ZUBEHÖR UND VERBRAUCHSMATERIAL





JBM EMPFEHLT, EIGENE SCHMIRMITTEL FÜR DIE OPTIMISIERUNG DER ARBEIT UND VERLÄNGERUNG DER LEBENSDAUER DER PNEUMATISCHEN WERKZEUGE EINZUSETZEN
REF.14534 REF.14560

SEITE 161

53520

228,00€

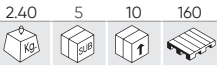

SCHLAGSCHRAUBER 1/2" (1756NM) - KOMPOSITGEHÄUSE



KOMPOSIT GEHÄUSE

1756Nm

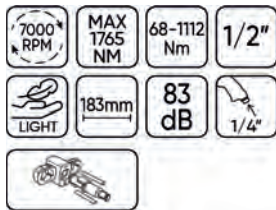

REF. BESCHREIBUNG

14121 REPARATUR SET FÜR 51207 / 53520

0.75 - 20 26,00€

51207

289,00€

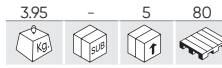

1/2" COMPOSITE-SCHLAGSCHRAUBER-SET + STECKSCHLÜSSEL



KOMPOSIT GEHÄUSE

1756Nm



REF. BESCHREIBUNG

14121 REPARATUR SET FÜR 51207 / 53520

0.75 - 20 26,00€

51206

228,00€

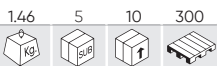

SCHLAGSCHRAUBER 1/2" MINI - KOMPOSITGEHÄUSE



KOMPOSIT GEHÄUSE

1302Nm

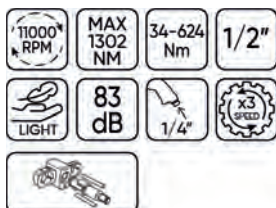

REF. BESCHREIBUNG

14120 REPARATUR SET FÜR 51206

0.15 - 5 22,00€

53588

178,00€

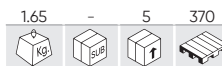

MINI-SCHLAGSCHRAUBER 1/2" (1302NM)



1302Nm

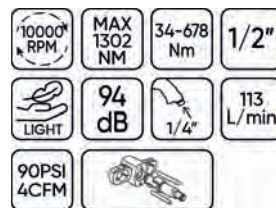

REF. BESCHREIBUNG

14165 REPARATUR SET FÜR 53588

0.05 - 20 26,50€

JBM EMPFEHLT, EIGENE SCHMIRMITTEL FÜR DIE OPTIMISIERUNG DER ARBEIT UND VERLÄNGERUNG DER LEBENSDAUER DER PNEUMATISCHEN WERKZEUGE EINZUSETZEN

REF.14534 REF.14560

SEITE 161



53733 238,00€

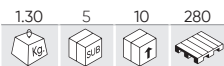

WINKEL-SCHLAGSCHRAUBER 1/2"



650Nm



REF. BESCHREIBUNG 0.03 - 20 22,50€

14633 REPARATUR SET FÜR 53733

54340 296,00€



N

SCHLAGSCHRAUBER MIT KNICKGELENK 1/2"



813 Nm



REF. BESCHREIBUNG 0.07 - 15 32,50€

16341 REPARATUR SET FÜR 54340

54397 249,00€



N

1/2" DRUCKLUFT-SCHLAGSCHRAUBER



1004Nm



REF. BESCHREIBUNG 0.10 - 20 17,00€

16564 REPARATUR SET FÜR - 54397

53689 238,00€

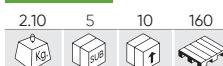

SCHLAGSCHRAUBER 1/2" (1950NM) - COMPOSITE



KOMPOSIT GEHÄUSE

1950Nm

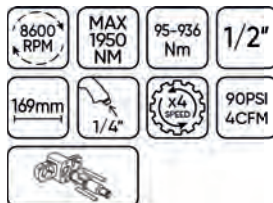

REF. BESCHREIBUNG 0.01 - 20 19,00€

14618 REPARATUR SET FÜR 53689

53608

98,00€

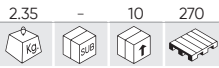

SCHLAGSCHRAUBER 1/2" 1200NM

1200Nm

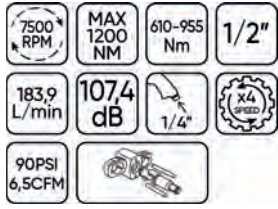

REF. BESCHREIBUNG



14583 REPARATUR SET FÜR 53608 0.01 - 20 6,00€

53726

128,00€

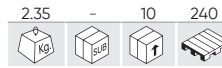

SCHLAGSCHRAUBER 1/2" 1650NM

1650Nm

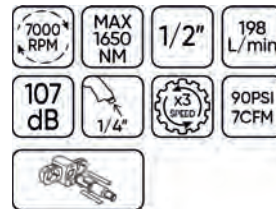

REF. BESCHREIBUNG



15564 REPARATUR-KIT DRUCKLUFTWERKZEUG – 53726 0.05 - - 11,90€

51212

488,00€

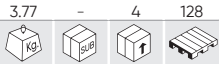

SCHLAGSCHRAUBER 3/4" - KOMPOSITGEHÄUSE

2034Nm

KOMPOSIT GEHÄUSE

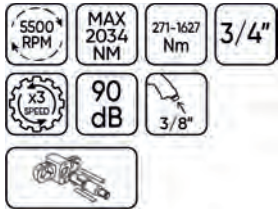

REF. BESCHREIBUNG



14122 REPARATUR SET FÜR 51210 / 51212 1.12 - 50 34,00€

51211

560,00€

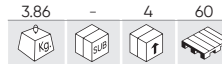

SCHLAGSCHRAUBER 1" - KOMPOSITGEHÄUSE

2034Nm

KOMPOSIT GEHÄUSE

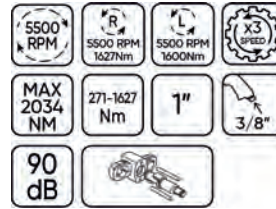

REF. BESCHREIBUNG



14123 REPARATUR SET FÜR 51211 / 51213 1.16 - 20 33,00€

51210

650,00€

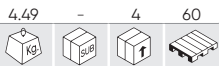

SCHLAGSCHRAUBER 3/4" MIT 15 CM SCHAFT- KOMPOSITGEHÄUSE

2034Nm

KOMPOSIT GEHÄUSE

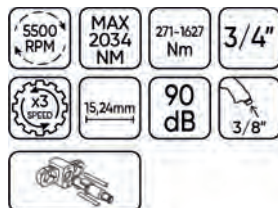

REF. BESCHREIBUNG



14122 REPARATUR SET FÜR 51210 / 51212 1.12 - 50 34,00€

51213

690,00€

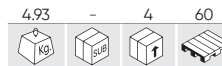

SCHLAGSCHRAUBER 1" 19 CM SCHAFT - KOMPOSITGEHÄUSE

2034Nm

KOMPOSIT GEHÄUSE

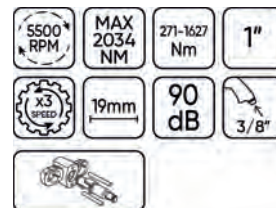

REF. BESCHREIBUNG



14123 REPARATUR SET FÜR 51211 / 51213 1.16 - 20 33,00€

53681 743,00€



LKW SCHLAGSCHRAUBER 1" - ULTRALEICHT



2441Nm



REF. BESCHREIBUNG	kg	Sub	Ein	€
14336 REPARATUR SET FÜR 53681	1.17	10	10	58,00€

52814 528,00€



1" LEICHTER LUFT-SCHLAGSCHRAUBER 3260NM



3260Nm



REF. BESCHREIBUNG	kg	Sub	Ein	€
14153 REPARATUR SET FÜR 52814	0.05	-	15	20,50€

53343 285,00€



SCHLAGSCHRAUBER 3/4"

1600Nm



51222 128,00€



SCHLAGSCHRAUBER 1/2"

101Nm



REF. BESCHREIBUNG	kg	Sub	Ein	€
14131 REPARATUR SET FÜR 51222	0.01	-	10	24,00€

52156 140,00€



KOFFER MIT SCHLAGSCHRAUBER UND RATSCHEN SET, 16 TEILE

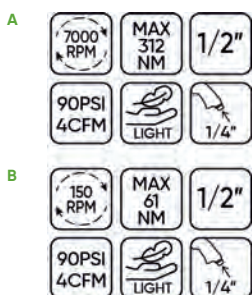

x10 9, 10, 11, 13, 14, 17, 19, 22, 24, 27mm

52165 118,00€



SCHLAGSCHRAUBER 1/2"

680Nm



54336

259,00€



N

1/2" DRUCKLUFT GELENKRATSCH

95Nm



REF. BESCHREIBUNG

16273 REPARATUR SET FÜR 54336

0.15 - 15 12,50€

51214

148,00€

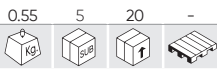

MINI-DRUCKLUFTTRATSCH 1/4" KOMPOSITGEHÄUSE

40,7Nm

KOMPOSIT GEHÄUSE



REF. BESCHREIBUNG

14124 REPARATUR SET FÜR 51214

0.25 - 10 20,50€

51215

119,00€

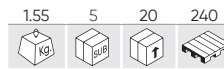

DRUCKLUFTTRATSCH 1/2"

14-68Nm

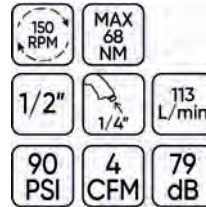

REF. BESCHREIBUNG

14125 REPARATUR SET FÜR 51215

0.03 - 10 19,50€

52167

48,00€

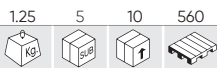

DRUCKLUFTTRATSCH 1/2"

61Nm



REF. BESCHREIBUNG

14778 REPARATUR SET FÜR 52167

0.05 - 10 12,50€

53784

148,00€

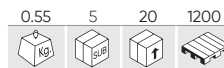

MINI-DRUCKLUFTTRATSCH 1/2" KOMPOSITGEHÄUSE

40,8Nm

KOMPOSIT GEHÄUSE



REF. BESCHREIBUNG

14779 REPARATUR SET FÜR 53784

0.05 - 10 33,00€

51221 199,00€



90° WINKELBOHRER



REF. BESCHREIBUNG €
14130 REPARATUR SET FÜR 51221 0.40 - 10 21,00€

51220 240,00€



UMKEHRBARER BOHRER-KOMPOSITGEHÄUSE

KOMPOSIT GEHÄUSE



REF. BESCHREIBUNG €
14129 REPARATUR SET FÜR 51220 0.01 - 10 12,50€

53573 36,00€



GERADER DRUCKLUFTBOHRER 3/8"



52159 64,00€

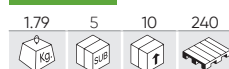

DRUCKLUFT WENDEBOHRMASCHINE 1/2"



52527 82,00€



DRUCKLUFT WENDEBOHRMASCHINE 3/8" IM WINKEL VON 90°



52160 48,00€

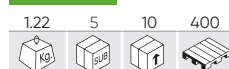

DRUCKLUFT WENDEBOHRMASCHINE 3/8"



DRUCKLUFT SCHWEISSPUNKTBOHRER

52724 381,00€



REF. BESCHREIBUNG €
13817 6.5 MM BOHRER FÜR REF.52725 0.10 - 500 17,00€

52725 349,00€



REF. BESCHREIBUNG €
13818 8 MM BOHRER FÜR REF.52725 0.10 - 500 20,50€

52718

48,00€

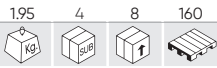

DRUCKLUFTHAMMER SET - 9 TEILEN



- A 21mm
- B 1,8mm
- C 21mm
- D 21mm



52953

38,00€

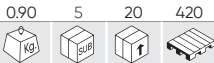

DRUCKLUFTSCHNEIDER 3"



REF. BESCHREIBUNG



12987 TRENNSCHEIBE 3" FÜR REF. 52953 0.02 50 500 1,50€

53140

98,00€

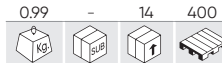

TRENNSCHLEIFER MIT 3" SCHAFT-KOMPOSITGEHÄUSE



REF. BESCHREIBUNG



14013 TRENNSCHEIBE FÜR REF. 53140 0.01 - 1000 3,50€

53541

168,00€

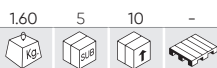

DRUCKLUFT METALLSCHERE



REF. BESCHREIBUNG



14136 REPARATUR SET FÜR REF. 53541 0.01 - 5 12,00€

52574

69,00€



DRUCKLUFT SÄGE



REF. BESCHREIBUNG



11956 SÄGEBLATT 24 ZAHN 0.03 10 300 5,50€

11957 SÄGEBLATT 32 ZAHN 0.01 10 250 5,50€

51216

650,00€

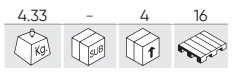

POLIERMASCHINE SET



VORRICHTUNGEN

REF.	BESCHREIBUNG				€
51388	23MM BÜRSTE FÜR REF.51216	0.10	100	800	22,00€
51389	11MM BÜRSTE FÜR REF.51216	0.05	1	800	22,00€
51390	23MM DÜNNE FLACHBÜRSTE FÜR REF.51216	0.05	100	800	22,00€
51391	11MM DÜNNE FLACHBÜRSTE FÜR REF.51216	0.04	1	800	22,00€
51392	BÜRSTE FÜR DIE ENTFERNUNG VON FARBE FÜR REF. 51216	0.20	100	800	34,00€
51393	BÜRSTE FÜR DIE ENTFERNUNG VON FARBE AUF WASSERBASIS FÜR REF. 51216	0.10	50	800	34,00€
51439	ADAPTER FÜR REF. 51216, FÜR DIE 23 MM SCHEIBE	0.10	100	800	26,00€
51440	ADAPTER FÜR REF. 51216, FÜR DIE 11 MM SCHEIBE	0.10	1	800	28,00€
51441	ADAPTER FÜR REF. 51216, FÜR DIE SCHWARZE DOPPEL-SCHEIBE	0.10	1	800	26,00€
51442	ADAPTER FÜR REF 51216, FÜR DIE SCHWARZE EINZEL-SCHEIBE	0.10	50	800	28,00€
REF.	BESCHREIBUNG				€
14126	REPARATUR SET FÜR 51216	0.01	-	10	54,00€

BEINHALTET
 Lieferumfang: Scheiben mit verschiedenen Durchmessern (für Vorbereitung von Metalloberflächen vor Instandsetzungsarbeiten)
 11 mm Drahtbürste (dünn)
 23 mm Drahtbürste (dünn)
 11 mm Drahtbürste (dick)
 23 mm Drahtbürste (dick)
 Scheibe für den Ausbau vom Gummi. Scheibe für die Entfernung wässriger Farben
 23 mm Adapter für die Scheibe für den Ausbau vom Gummi und Drahtbürste
 11 mm Adapter für Drahtbürste
 Schwarze Gummischleifscheibe (bis 6 St.).
 Adapter für einreihige Gummischleifscheibe.
 Adapter für zweireihige Gummischleifscheibe.

53576

189,00€

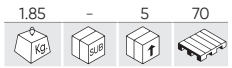

MINI POLIERMASCHINE-SET 3"



REF.	BESCHREIBUNG				€
A	14162 POLIERWOLLKISSEN FÜR REF. 53576	0.05	-	50	25,50€
B	14163 WEICHES SCHWAMMKISSEN FÜR REF. 53576 - WEISS	0.50	5	50	25,50€
C	14164 HARTES SCHWAMMKISSEN FÜR REF. 53576 - GELB	0.50	5	50	25,50€
D	14330 VELCRO-SCHEIBE FÜR REF. 53576	0.01	5	50	3,50€
14154	REPARATUR SET FÜR REF. 53576	0.05	-	10	42,00€

53646

69,00€

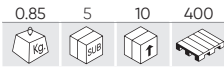

DRUCKLUFT-POLIERMASCHINE SET 3"



REF.	BESCHREIBUNG				€
A	14286 POLYÄTHERSCHWAMM FÜR REF. 53646 - ORANGE	0.01	10	200	2,99€
B	14287 DICHTES SCHWAMMKISSEN FÜR REF. 53646	0.00	10	200	2,99€
C	14288 POLIERWOLLKISSEN FÜR REF. 53646	0.01	10	200	6,00€
D	14289 VELCRO-SCHEIBE FÜR REF. 53646	0.04	-	200	6,10€

53626

18,00€

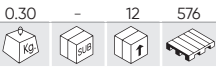

SCHEINWERFER-POLIER SET

14 PCS

BEINHALTET

	x2 P800 schleifscheiben		x1 85 G polierpaste
	x2 P1200 schleifscheiben		x1 Klebeband
	x2 P2000 schleifscheiben		x1 Wollpolierscheibe
	x2 3,0 MI uv-schutzflüssigkeit		x1 Weiße schwammscheibe
	x2 Adapter (3/8" und 1/4")		



AUSSTELLER MIT 12 STÜCK



SERIE262

199,00€

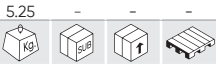

SPEZIAL POLIER KIT: POLIERMASCHINE + 12XSCHLEIFWERFER WIEDERHERSTELLUNG SETS

53626

53646



x12u.

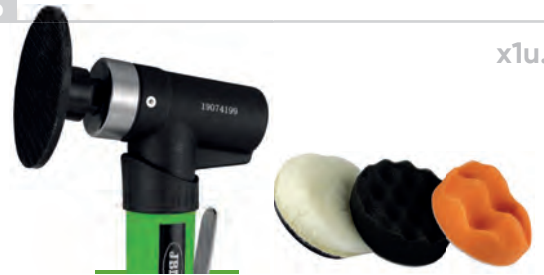

x1u.



52676

98,00€

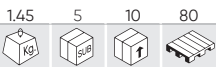

ORBITALSCHLEIFER MIT ABSAUGUNG SET

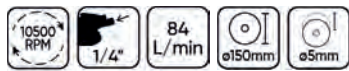

- Alu-Gehäuse mit Gummigriff.
- Mit Schlauch und Staubschutzsack.



52675

84,00€

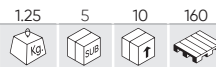

ANPASSUNGSFÄHIGER DRUCKLUFT EXZENTERSCHLEIFER MIT ABSAUGSYSTEM



52758

88,00€

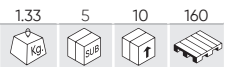

51226

233,00€

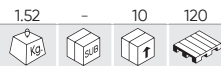

TRENSCHLEIFER SET

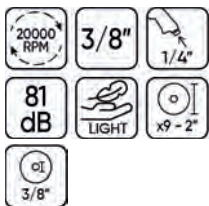

REF. BESCHREIBUNG



14133 REPARATUR SET FÜR 51226

0.01 - 10 16,50€

52157

48,00€

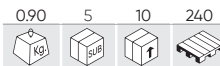

DRUCKLUFTSCHLEIFER SET IM KOFFER - 16 TEILEN



51245

99,00€

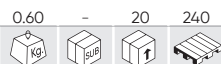

MINI-SCHLEIFER 3/8" 6MM



REF. BESCHREIBUNG



14135 REPARATUR SET FÜR 51245

0.01 - 10 12,50€

52171

39,00€

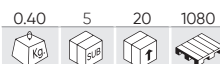

DRUCKLUFT MINI-SCHLEIFER 1/4"



53141

68,00€

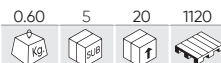

WINKELSCHLEIFER 1/4 " - KOMPOSITGEHÄUSE



52528

49,00€

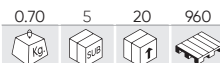

DRUCKLUFT WINKELSCHLEIFER



53137

38,00€

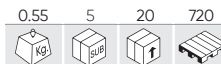

MINI-SCHLEIFER 1/4 " - KOMPOSITGEHÄUSE



51218

288,00€

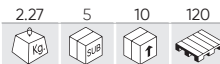

WINKELSCHLEIFER 1/4"- KOMPOSITGEHÄUSE

KOMPOSIT GEHÄUSE



REF. BESCHREIBUNG



14127 REPARATUR SET FÜR 51218

0.01 - 10 32,50€

DRUCKLUFTWERKZEUGE

54255

68,00€

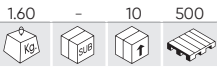

ZUBEHÖRSATZ FÜR FETTPRESSE

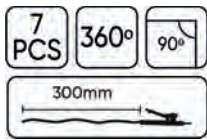

50751

43,00€

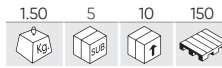

FETTPRESSE DRUCKLUFT

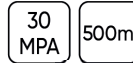

52490

6,65€

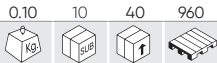

DRUCKLUFT-PISTOLE 100MM

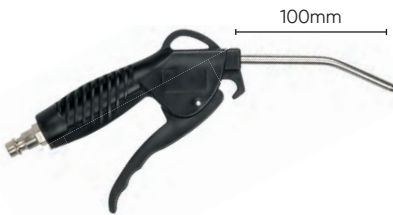

AUSSTELLER MIT 10 STÜCK



52491

10,50€

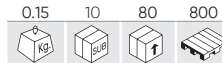

DRUCKLUFT-PISTOLE 300MM



AUSSTELLER MIT 10 STÜCK



53611

27,50€

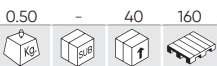

DRUCKLUFT-PISTOLE EXTRALANG



GROSSES LUFTVOLUMEN

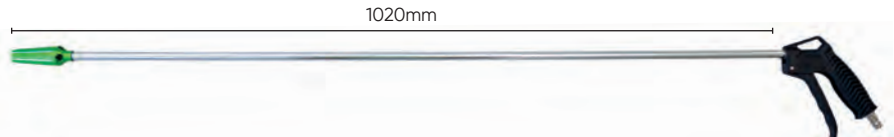

52798

18,00€

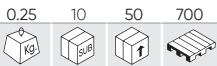

AUSZIEHBAREDRUCKLUFT-PISTOLE



GUMMIERTER EINSATZ ZUR SCHÜTZUNG VON KRATZERN

51980

15,00€

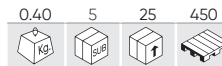

DRUCKLUFT-REIFENFÜLLER MIT MANOMETER



51981 21,50€

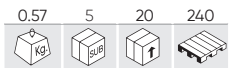

DRUCKLUFT -PISTOLE + REIFENFÜLLER



51277 64,00€

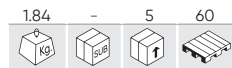

DRUCKLUFT-PISTOLEN-SET AUS 5 TEILEN



52787 9,00€

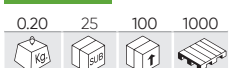

BLASPISTOLE IN BLISTERPACKUNG



51383 11,10€



DRUCKLUFT-PISTOLE IN PRÄSENTIERBOX

- Druckluftzerstäuber.
- Europäische Schnellverschraubung.
- Schlauchverbindung.
- 10 cm Rohrverlängerung.
- 20 cm Rohrverlängerung.



AUSSTELLER MIT 10 STÜCK



54251 43,00€

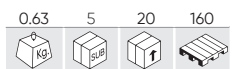

SAUG- UND BLASPISTOLE



53205 19,00€

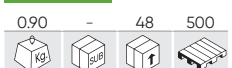

HOCHLEISTUNGS-PISTOLE



- GROSSES LUFTVOLUMEN
- Hochleistungs-Blaspistole.
 - Material: Aluminiumlegierung.
 - Oberfläche: Vernickelt.

52381 20,50€



DRUCKLUFT-PISTOLE 3/8" MIT 5M SPIRALSCHLAUCH



54248

58,00€

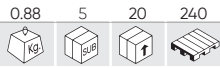

LUFTSPRÜHPISTOLE

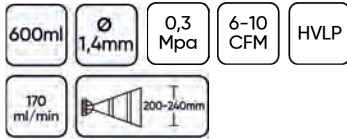

ERSATZTEILE VERFÜGBAR

54249

103,00€

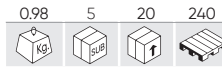

PROFESSIONELLE LUFTSPRÜHPISTOLE

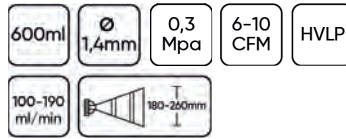

ERSATZTEILE VERFÜGBAR

53606

55,00€

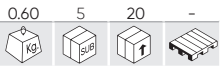

TROCKNUNGS-DRUCKLUFTPISTOLE



LUFTREGELVENTIL



53449

16,40€

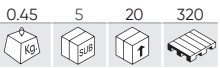

DRUCKLUFT-REIFENFÜLLER MIT MANOMETER

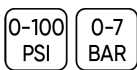

53450

28,30€

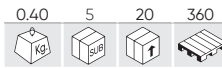

DRUCKLUFT-PISTOLE MIT MANOMETER, DIGITAL



52648

9,00€

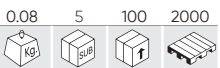

REIFENMANOMETER



4,3 BAR

53416

14,10€

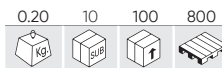

REIFENMANOMETER MIT SCHLAUCH (0-10BAR)



0-10 BAR

53417

26,30€

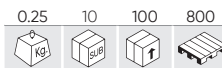

DIGITAL REIFENMANOMETER MIT SCHLAUCH (0-15BAR)

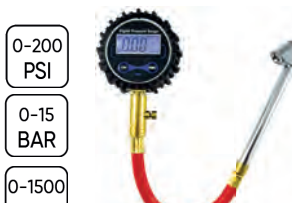

0-200 PSI
0-15 BAR
0-1500 KPA

53418

16,90€

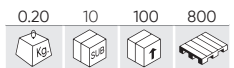

DIGITAL REIFENMANOMETER (0-15 BAR)



0-300 PSI
0-15 BAR
0-1500 KPA

51861

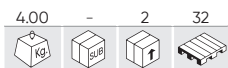

199,00€



DRUCKLUFT MANSCHETTENEXPANDER

- Material: Aluminium.
- Öffnung: von 20 bis 100mm.

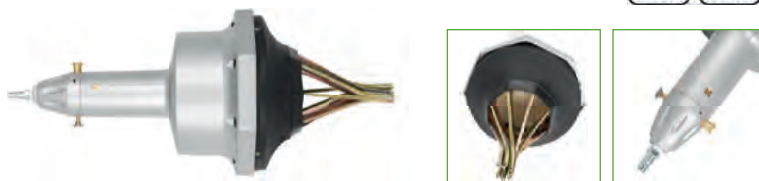

53542



980,00€

DRUCKLUFT REIFENABDRÜCKER



REF. BESCHREIBUNG

14137 REPARATUR SET FÜR REF. 53542

Icon	Quantity	Price (€)
	0.65	
	5	
	5	131,00€

52540



221,00€

AUSBEUL-PISTOLE MIT SAUGNAPP

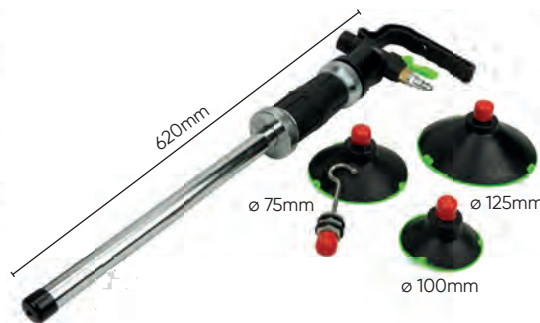
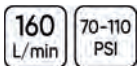

52331



201,00€

DRUCKLUFT WERKZEUGE SET

Schlagschrauber + Bohrhammer + Druckluftratsche + Mini-Schleifer + Luftpistole + Mini-Luftpistole



DRUCKLUFTWERKZEUGE

52543

182,00€

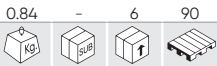

PARTIKELFILTER REINIGER

- Universal.
- Maximale Leistung: 650 cm³.
- Nylonschlauch 4x6x2,7 m.
- Arbeitsdruckbereich: 3-7 bar.
- Langlebiges und sicheres Gehäuse aus Aluminium.



REF. BESCHREIBUNG

REF.	BESCHREIBUNG	Kg	L	Stk	€
90003	ENTCARBONISIERER FLÜSSIGKEIT	1.08	-	12	35,20€
90004	NEUTRALISIERER FLÜSSIGKEIT	0.50	-	12	25,80€

53625

68,00€

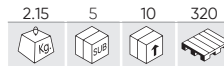

DRUCKLUFT-NADELHAMMER



REF. BESCHREIBUNG

REF.	BESCHREIBUNG	Kg	L	Stk	€
14188	ERSATZ NADELN FÜR REF. 53625	0.01	50	500	0,50€

53593

41,00€

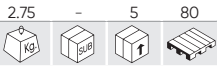

SANDBLAS-PISTOLE



- ENTHALTEN**
- 1x Sandstrahler.
 - 1x Sandfänger.
 - 2x Sandbehälter.

- 4x Düsen
- Zur Spotbearbeitung.
- Zur Oberflächenbehandlung.
- Zur Bearbeitung von Außenwinkeln.
- Zur Bearbeitung von Innenwinkeln.

REF. BESCHREIBUNG

REF.	BESCHREIBUNG	Kg	L	Stk	€
14168	SANDBLASCHEN (FÜR REF. 53593)	0.95	-	20	7,00€

53202

15,70€

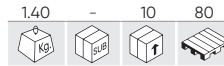

MOTORREINIGUNGSPISTOLE



- Motorreinigungspistole.
- Topfmaterial: Stahl.
- Gehäusewerkstoff: Aluminiumlegierung.
- Oberfläche: Pulverbeschichtet.

53204

81,00€

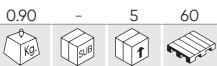

TORNADO REINIGUNGSPISTOLE



- Autoreinigungspistole, Tornado.
- Topfmaterial: PE.
- Gehäusewerkstoff: Aluminiumlegierung.
- Gehäuseoberfläche: Poliert.

52575

119,00€

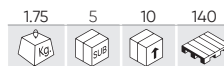

DRUCKLUFT NIET-PISTOLE



53567 43,00€

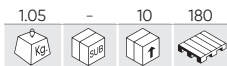

DRUCKLUFT KARTUSCHEN-PISTOLE



- Arbeitsdruck: 2,5-5 bar.
- Lufteinlass: 1/4".
- Kartuschenkapazität: 310ml.

52533 10,00€

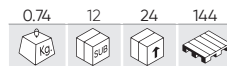

KARTUSCHEN-PISTOLE PROFI



53572 348,00€



DRUCKLUFT VENTILSCHLEIFWERKZEUG - SCHLAG UND ROTATION

ENTHALTEN

- 1x Luftventil für Luftdruckpumpe.
- 5x Sauggreifer (16, 20, 30, 35 und 40 mm).
- 5x Ventilverlängerungen.
- 1x Sechskantschlüssel 3 mm.



54033 49,00€



VENTILSCHLUSSWERKZEUG FÜR BOHREN

- Sauggreiferdurchmesser: 16, 20, 30, 35, 40 mm
- Achsendurchmesser: 8 mm
- Länge: 128 mm
- Maximale Arbeitsdrehzahl: 1 250 U / min



REF.	mm	kg	l	mm	€
14157	16	0.01	-	50	8,30€
14158	20	0.01	-	50	9,95€
14159	30	0.01	-	50	12,60€
14160	35	0.01	-	50	12,80€
14161	40	0.10	-	50	13,70€



REF.	mm	kg	l	mm	€
14157	16	0.01	-	50	8,30€
14158	20	0.01	-	50	9,95€
14159	30	0.01	-	50	12,60€
14160	35	0.01	-	50	12,80€
14161	40	0.10	-	50	13,70€



14534 16,50€



ÖL FÜR DRUCKLUFT-WERKZEUG - 600ML

- Relative Dichte bei 15°C: 0,845.
- Viskosität: 12,1 cSt bei 40°C.
- Farbe: Farblos.



14560 8,80€



ÖL FÜR DRUCKLUFT-WERKZEUG - 100ML

- Relative Dichte bei 15°C: 0,845.
- Viskosität: 12,1 cSt bei 40°C.
- Farbe: Farblos.





TRENNSCHEIBEN

REF.	BESCHREIBUNG					€
51385	4" X 1/32" TRENNSCHEIBE DÜR REF. 51219	0.01	10	300	800	4,55€
51387	TRENNSCHEIBE 3"	0.03	10	300	800	3,25€



SCHLEIFSCHEIBEN

REF.	BESCHREIBUNG					€
51386	5" SCHLEIFSCHEIBE FÜR	0.10	-	25	800	5,95€
51443	SCHLEIFSCHEIBE #60 FÜR 51226	0.50	25	150	800	5,50€
51444	SCHLEIFSCHEIBE #80	0.02	-	25	800	5,05€
51445	SCHLEIFSCHEIBE	0.02	-	25	800	5,05€



SCHEIBEN FÜR EXZENTERSCHLEIFER

REF.	BESCHREIBUNG					€
13499	15-LOCH SCHLEIFBLATT FÜR EXZENTERSCHLEIFER	0.10	-	50	1500	12,50€
13500	66-LOCH SCHLEIFBLATT FÜR EXZENTERSCHLEIFER	0.65	5	50	-	12,90€
12009	6-LOCH SCHLEIFBLATT FÜR EXZENTERSCHLEIFER	0.14	-	50	-	11,00€



DRUCKLUFTREGLER MIT MANOMETER

REF.	"					€
53063	1/4"	0.60	5	50	300	36,70€
53064	3/8"	0.63	5	50	300	37,40€
53065	1/2"	0.60	5	50	300	36,90€

DRUCKLUFTREGLER MIT MANOMETER UND SCHMIERUNG

REF.	"					€
53066	1/4"	1.08	5	25	250	61,00€
53067	3/8"	0.50	5	25	250	61,00€
53068	1/2"	1.00	5	25	250	63,00€



53492

380,00€

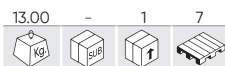

WERKZEUG AUSSTELLUNGSTURM



WERKZEUG NICHT ENTHALTEN



52378

10,00€

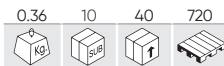

DRUCKLUFT WERKZEUG MAGNETHALTER



53147

41,00€

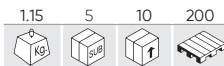

WERKZEUG AHALTER



WERKZEUG NICHT ENTHALTEN

53594

54,00€

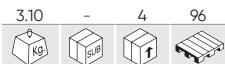

LUFTSCHLAUCH 8MM - 25 M



HYBRID POLYMER
POLÍMERO HÍBRIDO

- Betriebsdruck: 300 PSI / 20 Bar.
- Aufbrechdruck: 950 PSI / 65 Bar.
- Betriebstemperatur: von -40 bis 65 °C

- Hohe Flexibilität.
- Stellt eine Vorform wieder her.
- Glatte Oberfläche, die die Lackierung nicht beschädigt.
- Hohe Beständigkeit.

Innendurchmesser: 8mm
Außendurchmesser: 13mm

Zur Verwendung zusammen mit:
REF. 52736 (M8)



53595

61,00€



LUFTSCHLAUCH 10 MM - 25 M



HYBRID POLYMER
POLÍMERO HÍBRIDO

- Betriebsdruck: 300 PSI / 20 Bar.
- Aufbrechdruck: 950 PSI / 65 Bar.
- Betriebstemperatur: von -40 bis 65 °C

- Hohe Flexibilität.
- Stellt eine Vorform wieder her.
- Glatte Oberfläche, die die Lackierung nicht beschädigt.
- Hohe Beständigkeit.

Innendurchmesser: 10mm
Außendurchmesser: 15mm

Zur Verwendung zusammen mit:
REF. 52737 (M10)



REF. BESCHREIBUNG

14169 10X SCHLAUCHKLEMMEN SET 8-16 MM

0.10 - 125 - 3,00€

LUFT-SPIRALSCHLAUCH

REF.	m			"					€
53629	10m	8mm	5mm	1/4"	0.55	-	6	360	14,30€
53630	15m	8mm	5mm	1/4"	0.65	-	6	240	18,80€
53631	15m	12mm	8mm	1/4"	1.25	-	6	120	33,50€
53632	15m	15mm	10mm	1/4"	2.20	-	6	78	46,00€
53633	15m	15mm	10mm	3/8"	2.10	-	6	78	46,00€
53634	15m	18mm	13mm	1/2"	2.60	-	6	66	63,00€



MIT 360-GRAD SCHWENK-ENDEN FÜR EINFACHE BEWEGUNG UND EINFACHE BEDIENUNG

- MATERIAL DER SCHLANGE: PU.
- GEWINDE-OBERFLÄCHE: MESSING.

LUFTSCHLAUCH AUFROLLER



MIT FÜHRUNGS SYSTEM



MIT WANDHALTERUNG

14772 8,50€

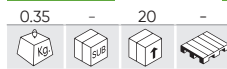

REF. 53582 / REF. 53583



MIT WANDHALTERUNG

14771 10,50€



REF. 53532 / REF. 53581

20+2m

REF.	m	"				€
53582	22m	3/8"	10.85	-	14	174,00€
53583	22m	3/8"	10.75	-	14	174,00€



12+1m

REF.	m	"				€
53532	13m	3/8"	6.60	-	30	119,00€
53581	13m	3/8"	6.70	-	30	119,00€



10+1,5m

REF.	m	"				€
53881	11,5m	1/4"	4.50	-	48	79,00€
53882	11,5m	1/4"	4.50	-	48	79,00€



SCHLAUCHKUPPLUNG

REF.	BESCHREIBUNG					€
14204	EUR - M6 M 1/4"	0.06	50	200	-	1,50€
14205	EUR - M8 M 3/8"	0.06	50	200	-	1,50€
14206	EUR - M10 M 1/2"	0.05	50	200	-	1,50€
14207	US - M6 M 1/4"	0.05	50	200	-	1,50€
14208	US - M8 M 3/8"	0.06	50	200	-	1,50€
14209	US - M10 M 1/2"	0.05	50	200	-	1,50€



UNIVERSAL-SICHERHEITSSCHLAUCHVERBINDER

REF.	BESCHREIBUNG					€
14201	M6	0.10	25	100	-	4,00€
14202	M8	0.10	25	100	-	4,00€
14203	M10	0.10	25	100	-	4,50€



STECKNIPPEL / SCHNELLKUPPLUNG

US

REF.	BESCHREIBUNG				€
13930	USA-STECKNIPPEL - 1/4" AUßENGEWINDE	0.01	50	100	1,50€
13932	USA-STECKNIPPEL - 3/8" AUßENGEWINDE	0.10	50	100	2,50€
14076	USA-STECKNIPPEL - 3/8" INNENGEWINDE	0.10	50	100	1,50€
13933	USA-STECKNIPPEL - 1/2" AUßENGEWINDE	0.10	50	100	2,00€
13935	USA-STECKNIPPEL - 1/4" INNENGEWINDE (2 ST.)	0.05	50	100	2,50€
13936	USA-SCHNELLKUPPLUNG - 1/4" INNENGEWINDE	0.05	50	100	3,50€
13937	USA-SCHNELLKUPPLUNG - 1/4" AUßENGEWINDE	0.05	50	100	4,00€
14078	USA-SCHNELLKUPPLUNG - 3/8" INNENGEWINDE	0.10	50	100	4,00€
14191	USA-STECKNIPPEL - 1/2" INNENGEWINDE	0.05	50	100	2,00€
14193	USA-SCHNELLKUPPLUNG - 1/2" INNENGEWINDE	0.10	50	100	4,00€

EUR

REF.	BESCHREIBUNG				€
13931	EURO-STECKNIPPEL - AUßENGEWINDE 1/4" (2 ST.)	0.05	50	100	2,50€
14075	EURO-STECKNIPPEL - 3/8" INNENGEWINDE	0.10	50	100	2,00€
13934	EURO-STECKNIPPEL - 1/4" INNENGEWINDE (2 ST.)	0.05	50	100	2,50€
13938	EURO-SCHNELLKUPPLUNG - 1/4" INNENGEWINDE	0.10	50	200	3,50€
13939	EURO-SCHNELLKUPPLUNG - 1/4" AUßENGEWINDE	0.10	50	100	4,00€
14077	EURO-SCHNELLKUPPLUNG - 3/8" INNENGEWINDE	0.10	50	100	4,50€
14190	EURO-STECKNIPPEL - 1/2" INNENGEWINDE	0.05	50	100	2,00€
14192	EURO-SCHNELLKUPPLUNG - 1/2" INNENGEWINDE	0.10	50	100	4,00€



UNIVERSAL-SICHERHEITSKUPPLUNG

REF.	BESCHREIBUNG					€
14195	INNENGEWINDE - AUSSENGEWINDE 1/4"	0.50	25	100	-	4,00€
14196	INNENGEWINDE - AUSSENGEWINDE 3/8"	0.10	25	100	-	4,00€
14197	INNENGEWINDE - AUSSENGEWINDE 1/2"	0.10	25	100	-	4,50€
14198	INNENGEWINDE - INNENGEWINDE 1/4"	0.10	25	100	-	4,00€
14199	INNENGEWINDE - INNENGEWINDE 3/8"	0.10	25	100	-	4,00€
14200	INNENGEWINDE - INNENGEWINDE 1/2"	0.10	25	100	-	4,50€



GELENK-KUPPLUNG FÜR DRUCKLUFT

REF.	BESCHREIBUNG					€
14314	EUR 1/4"	0.06	25	100	-	5,00€
14315	US 1/4"	0.06	25	100	-	4,50€



14561

0.05	25	50	-
------	----	----	---

8,80€

SCHMIERSTOFF 1/4"-ADAPTER

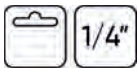

DRUCKLUFT SCHNELLKUPPLUNG-PAAR

REF.	BESCHREIBUNG					€
52735	DRUCKLUFT SCHNELLKUPPLUNG-PAAR M6	0.05	25	200	4000	4,85€
52736	DRUCKLUFT-SCHNELLKUPPLUNGS-PAAR M8	0.10	25	200	4000	5,35€
52737	DRUCKLUFT SCHNELLKUPPLUNGS-PAAR M10	0.10	25	200	4000	5,50€



DRUCKLUFT SCHWENK-KUPPLUNG

REF.	BESCHREIBUNG					€
12988	DRUCKLUFT SCHWENK-KUPPLUNG 1/2"	0.15	62	125	-	12,00€
13809	DRUCKLUFT SCHWENK-KUPPLUNG 1/4"	0.10	62	250	-	18,50€
13810	DRUCKLUFT SCHWENK-KUPPLUNG 3/8"	0.10	62	250	-	20,50€



SCHLAGWERKZEUGE, STECKSCHLÜSSEL UND BITS

168 SCHLAGEINSÄTZE

173 SCHLEIFSCHUHE

174 ADAPTER

176 ERSATZTEILE FÜR SCHLAGEINSÄTZE

177 LASTWAGENSPEZIAL



52694

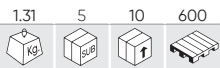

1/2" SCHLAGNUSS SET, XZN - 3 TEILE



ENTHALTEN



49,00€

52337

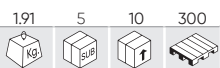

6-KANT SCHLAGNUSS SET, 1/2" - 6 TEILE



ENTHALTEN

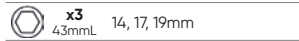

52547



1/2" SCHLAGNUSS SET, XZN - 8 TEILE



ENTHALTEN

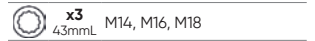

96,00€

52345



6-KANT SCHLAGNUSS SET, 1/2" + ADAPTER - 19 TEILE



10, 11, 12, 13, 14, 15, 16, 17, 18, 19, 21, 22, 24, 27mm



ERSATZTEIL VERFÜGBAR

REF.	mm				€
14728	10	0.10	5	20	3,80€
14729	11	0.05	10	100	3,80€
14730	12	0.05	10	100	3,80€
14731	13	0.10	5	20	3,80€
14732	14	0.10	5	20	3,80€
14970	15	0.08	5	20	2,50€
14971	16	0.07	5	20	2,50€

REF.	mm				€
11195	17	0.10	10	100	3,70€
14972	18	0.12	5	20	3,50€
11121	19	0.10	10	60	4,10€
14733	21	0.10	5	20	4,30€
14734	22	0.15	5	20	5,40€
11122	24	0.14	10	20	5,45€
11123	27	0.20	10	50	6,50€

REF.	BESCHREIBUNG				€
12937	SCHLAG-VERLÄNGERUNGSSTANGE 1/2", 50MM	0.11	10	100	9,50€
14973	SCHLAG-VERLÄNGERUNGSSTANGE 1/2",150MM	0.27	5	20	11,50€
12075	SCHLAG-VERLÄNGERUNGSSTANGE 1/2",250MM	0.45	10	50	15,50€
11962	SCHLAG-ADAPTER 1/2" AUF 3/4"	0.17	10	100	7,50€
11990	SCHLAG-UNIVERSALGELENK 1/2"	0.15	10	100	15,30€

109,00€

53531

109,00€

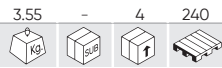

6-KANT SCHLAGNUSS SET, 1/2" + ADAPTER 19 TEILE

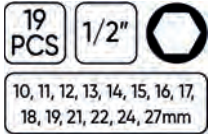

ERSATZTEIL VERFÜGBAR

REF.	BESCHREIBUNG				€
12937	SCHLAG-VERLÄNGERUNGSSTANGE 1/2", 50MM	0.11	10	100	9,50€
14973	SCHLAG-VERLÄNGERUNGSSTANGE 1/2", 150MM	0.27	5	20	11,50€
12075	SCHLAG-VERLÄNGERUNGSSTANGE 1/2", 250MM	0.45	10	50	15,50€

REF.	BESCHREIBUNG				€
11962	SCHLAG-ADAPTER 1/2" AUF 3/4"	0.17	10	100	7,50€
11990	SCHLAG-UNIVERSALGELENK 1/2"	0.15	10	100	15,30€

52341

58,00€

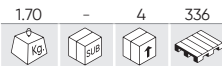

1/2" SCHLAGNUSS SET, + ADAPTER - 13 TEILE

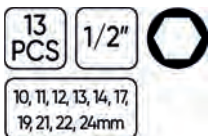

ERSATZTEIL VERFÜGBAR

REF.	mm				€
14728	10	0.10	5	20	3,80€
14729	11	0.05	10	100	3,80€
14730	12	0.05	10	100	3,80€
14731	13	0.10	5	20	3,80€
14732	14	0.10	5	20	3,80€

REF.	mm				€
11195	17	0.10	10	100	3,70€
11121	19	0.10	10	60	4,10€
14733	21	0.10	5	20	4,30€
14734	22	0.15	5	20	5,40€
11122	24	0.14	10	20	5,45€

REF.	BESCHREIBUNG				€
14735	1/2" SCHLAGADAPTER	0.05	5	20	6,50€
12074	SCHLAG-VERLÄNGERUNGSSTANGE 1/2", 125MM	0.23	10	60	11,50€
11990	SCHLAG-UNIVERSALGELENK 1/2"	0.15	10	100	15,30€

52346

103,00€



6-KANT SCHLAGNUSS SET, 1/2" LANG - 15 TEILE



ERSATZTEIL VERFÜGBAR

REF.	mm				€
12061	10	0.14	10	100	9,50€
12062	12	0.15	10	100	9,50€
12063	13	0.15	10	50	9,50€
12064	15	0.17	10	100	9,00€
12065	16	0.30	10	20	9,00€
12066	17	0.20	10	100	9,00€

REF.	mm				€
12067	18	0.22	10	20	9,50€
12068	19	0.21	10	50	9,50€
12069	21	0.25	10	50	9,50€
12070	22	0.27	10	100	10,50€
12071	24	0.30	10	50	11,00€
12072	27	0.36	10	20	12,00€

REF.	BESCHREIBUNG				€
12074	SCHLAG-VERLÄNGERUNGSSTANGE 1/2", 125MM	0.23	10	60	11,50€
12075	SCHLAG-VERLÄNGERUNGSSTANGE 1/2", 250MM	0.45	10	50	15,50€
11990	SCHLAG-UNIVERSALGELENK 1/2"	0.15	10	100	15,30€

53060

34,90€

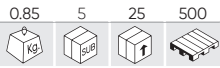

6-KANT SCHLAGNUSS SET, 1/2" KURZ - 12 TEILE

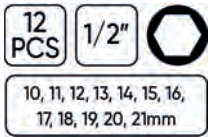

52342

63,00€

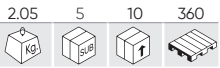

6-KANT SCHLAGNUSS SET, 1/2" - 11 TEILE

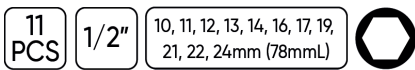

ERSATZTEIL VERFÜGBAR

REF.	mm				€
12061	10	0.14	10	100	9,50€
14736	11	0.15	5	20	5,00€
12062	12	0.15	10	100	9,50€
12063	13	0.15	10	50	9,50€
14737	14	0.15	5	20	5,00€
12065	16	0.30	10	20	9,00€

REF.	mm				€
12066	17	0.20	10	100	9,00€
12068	19	0.21	10	50	9,50€
12069	21	0.25	10	50	9,50€
12070	22	0.27	10	100	10,50€
12071	24	0.30	10	50	11,00€



53744

63,00€

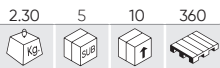

XZN SHLAGNUSS SET, 1/2" LANG - 11 TEILE

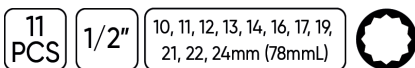

ERSATZTEIL VERFÜGBAR

REF.	mm				€
14738	10	0.15	10	100	5,50€
14739	11	0.15	10	100	5,50€
14740	12	0.16	10	100	5,55€
14741	13	0.15	10	100	5,55€
14742	14	0.15	10	100	5,55€
14743	16	0.14	10	100	5,15€

REF.	mm				€
14744	17	0.18	10	50	5,35€
14745	19	0.22	10	50	6,25€
14746	21	0.24	10	50	6,40€
14747	22	0.27	10	50	7,10€
14748	24	0.30	10	50	8,30€



52810

9,00€

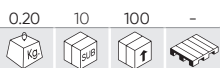

XZN SCHLAGNUSS MANIPULATIONSSICHER 1/2" M16

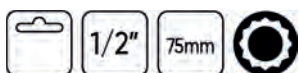

- Schlageinsatzlänge von 75 mm, mit quadratischer 1/2" Vertiefung für das Losdrehen der Ablassschraube mit dem Druckluftschlüssel mit Schlagfunktion in den Treibwerken von VAG, Porsche, Ford usw.

52811

9,90€

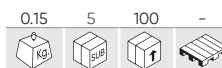

XZN SCHLAGNUSS MANIPULATIONSSICHER 1/2" M18

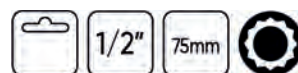

- Für Entfernung des Lenkhebels an den Fahrzeugen der VAG-Gruppe.

52546

39,60€

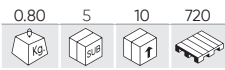

XZN SCHLAGNUSS BITS SET, 1/2" - 6 TEILE



ERSATZTEIL VERFÜGBAR

REF.	43mmL	kg	SUB	QTY	€	REF.	78mmL	kg	SUB	QTY	€
12931	M14	0.08	10	200	7,50€	12934	M14	0.13	10	200	7,50€
12932	M16	0.08	10	200	7,50€	12935	M16	0.14	10	200	8,00€
12933	M18	0.09	10	200	8,00€	12936	M18	0.16	10	200	8,50€

52344

197,00€

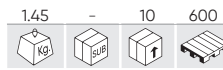

TORX UND 6-KANT SCHLAGNUSS SET 1/2" - 13 TEILE



ENTHALTEN

- x5 45mmL 5, 6, 8, 10, 12mm
- x8 45mmL T30, T40, T45, T50, T55, T60, T70, T80

52339

61,00€

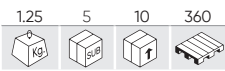

6-KANT SCHLAGNUSS BITS SET 1/2" - 8 TEILE



ERSATZTEIL VERFÜGBAR

REF.	mm	kg	SUB	QTY	€	REF.	mm	kg	SUB	QTY	€
14004	5	0.30	10	240	9,50€	14008	10	0.11	10	240	9,50€
14005	6	0.09	10	120	10,50€	14009	12	0.12	10	240	9,50€
14006	7	0.09	10	240	9,50€	14010	14	0.14	10	120	11,00€
14007	8	0.10	10	240	9,50€	14011	17	0.18	10	60	11,00€

52340

58,00€

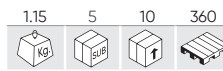

SET AUS 8 TORX-SCHLAGNUSS BITS 1/2"



ERSATZTEIL VERFÜGBAR

REF.	mm	kg	SUB	QTY	€	REF.	mm	kg	SUB	QTY	€
12938	T25	0.08	10	50	10,00€	12942	T50	0.10	10	60	10,00€
12939	T30	0.10	10	50	10,00€	12943	T55	0.10	10	50	10,00€
12940	T40	0.10	10	50	10,00€	12944	T60	0.12	10	50	10,00€
12941	T45	0.09	10	50	10,00€	12945	T70	0.15	10	50	10,50€

53470

176,00€

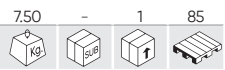

6-KANT SCHLAGNUSS SET, LANG 3/4" - 8 TEILE

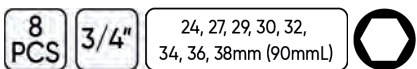

52347

158,00€

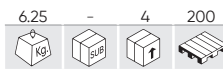

6-KANT SCHLAGNUSS SET 3/4" - 8 TEILE

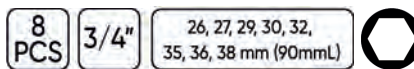

51028

163,00€

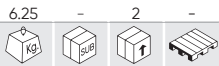

SCHLAGNUSS BITS SET - 16 TEILE

16 PCS 3/4"

ERSATZTEIL VERFÜGBAR

REF.	mm				€
14723	H17	0.35	-	10	18,00€
14724	T60	0.30	-	10	18,50€
14725	T70	0.30	-	10	18,50€
14726	T80	10.80	-	10	17,50€

	3/4"	x4	E18, E20, E22, E24
	3/4"	x5	T60, T70, T80, T90, T100
	3/4"	x4	H17, H19, H22, H24
		x2	1 - 3/4"
		x1	4mm



54316

182,00€



N

SATZ VON 8 1" LANGEN IMPACT-BRILLEN

8 PCS 1"



x6	90mmL	24, 27, 30, 32, 33, 36mm
x2	95mmL	38, 41mm



ERSATZTEIL VERFÜGBAR

REF.	mm				€
16304	24	0.60	6	24	31,00€
16305	27	0.70	6	24	31,00€
16571	30	0.77	6	24	32,00€
16572	32	0.95	6	24	33,50€

REF.	mm				€
16574	33	0.94	-	-	34,00€
16575	36	1.00	6	24	34,50€
16576	38	1.25	6	24	35,50€
16577	41	1.32	6	24	36,00€

52348

179,00€

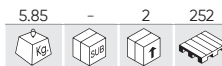

SCHLAGNUSS SET 1" - 8 TEILE

8 PCS 1"



x2	58mmL	24, 27mm
x3	62mmL	30, 32, 33mm
x2	65mmL	36, 38mm
x1	68mmL	41mm



ERSATZTEIL VERFÜGBAR

REF.	mm				€
13859	24	0.50	6	24	16,00€
13874	27	0.60	6	72	17,50€
13875	30	0.50	6	18	18,50€
13876	32	0.60	6	24	18,50€

REF.	mm				€
13877	33	0.60	6	96	18,50€
11153	36	0.70	6	18	23,40€
11155	38	0.90	6	12	24,40€
11158	41	0.95	6	18	28,50€

52969

20,70€



6-KANT SCHLAGNUSS SET, 1/2" - 3 TEILE

3 PCS 1/2"

17, 19, 21mm (78mmL)

ERSATZTEIL VERFÜGBAR

REF.	mm				€
12066	17	0.20	10	100	9,00€
12068	19	0.21	10	50	9,50€
12069	21	0.25	10	50	9,50€



53587 44,00€

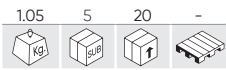

SCHLAGNUSS SET FÜR LEICHTMETALLFELGEN, 1/2" - 4 TEILE



ERSATZTEIL VERFÜGBAR

REF.	mm	mmL	SMART	kg	5L	20cm	€
14172	15mm	85mmL	SMART	0.20	10	50	8,50€
14173	17mm	85mmL	MERCEDES-BENZ	0.20	10	50	9,50€
14177	22mm	85mmL	OPEL	0.25	10	50	9,50€
14178	21mm	85mmL	HYUNDAI / KIA	0.25	10	50	9,50€

52338 41,00€

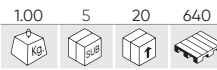

SCHLAGNUSS SET SPEZIAL FÜR RADENTFERNUNG, 1/2" - 4 TEILE

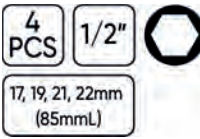

ERSATZTEIL VERFÜGBAR

REF.	mm	kg	5L	20cm	€
11314	17	0.22	10	100	8,50€
11315	19	0.25	10	100	8,50€
11316	21	0.26	10	100	8,50€
11628	22	0.27	10	50	9,50€



51336 29,30€

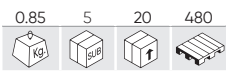

SCHLAGNUSS SET SPEZIAL FÜR RADENTFERNUNG, 1/2" - 3 TEILE



ERSATZTEIL VERFÜGBAR

REF.	mm	kg	5L	20cm	€
11314	17	0.22	10	100	8,50€
11315	19	0.25	10	100	8,50€
11316	21	0.26	10	100	8,50€

52343 52,00€

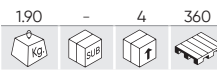

SCHLAGNUSS SET SPEZIAL FÜR RADENTFERNUNG, 1/2" - 12 TEILE



ENTHALTEN

x3	85mmL	17, 19, 21mm
	x1	42mmL 27mm
x8	38mmL	10, 11, 13, 14, 17, 19, 22, 24mm

53988 101,00€

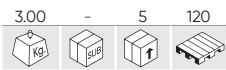

SATZ AUS 10 SCHLAGANSÄTZEN 1/2"



ENTHALTEN

A	1/2"	15mm	F	1/2"	23mm
B	1/2"	17mm	G	1/2"	24mm
C	1/2"	19mm	H	7/8"	TESLA
D	1/2"	21mm	I	17mm	MERCEDES
E	1/2"	22mm	J	21mm	HYUNDAI / KIA



53197

46,00€

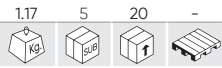

SCHLAGNUSS SET FÜS SICHERHEITS SCHRAUBEN, 1/2" - 4 TEILE



ENTHALTEN



53077

62,00€

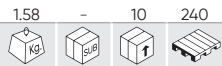

SCHLAG VERLÄNGERUNGSSTANGEN MIT DREHMOMENTBEGRENZUNG - 5 TEILE



ERSATZTEIL VERFÜGBAR

	REF.	Nm					€
A	13688	100	0.22	-	-	1500	15,50€
B	13687	110	0.22	5	50	-	15,50€
C	13686	120	0.23	5	50	1000	15,50€
D	13685	135	0.25	5	50	1500	15,50€
E	13684	150	0.28	-	50	-	15,50€



AUCH VERFÜGBAR...

	REF.	Nm					€
F	13680	200	0.36	50	50	-	15,50€
G	13681	190	0.35	-	50	-	15,50€
H	13682	175	0.32	-	50	-	15,50€
I	13683	160	0.30	-	50	-	15,50€
J	13689	90	0.20	5	50	1500	15,50€



SCHLAG-VERLÄNGERUNGSSTANGE

REF.	mm	"					€
12937	50	1/2"	0.11	10	100	1500	9,50€
12074	125	1/2"	0.23	10	60	-	11,50€
12075	250	1/2"	0.45	10	50	-	15,50€

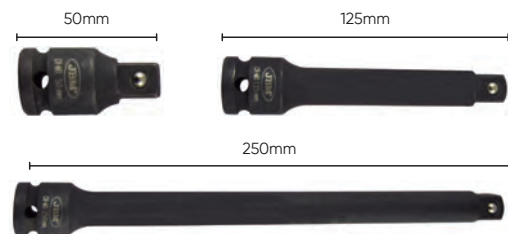

SCHLAG-UNIVERSALGELENK

REF.	"					€
11938	3/4"	0.62	10	50	-	47,00€
11990	1/2"	0.15	10	100	-	15,30€



53043

53,00€

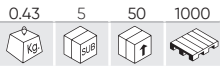

SCHLÄGGELENK SET MIT DOPPEL-POSITION, FEST/GELENKT - 3 TEILE



53044

121,00€



6-KANT SCHLAGNUSS SET 1/2", MIT DOPPEL-POSITION, FEST/GELENKT - 8 TEILE

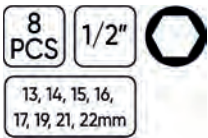

13, 14, 15, 16,
17, 19, 21, 22mm



52545

177,00€

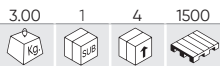

SET AUS 2 1" 1/2" SCHLAG-ADAPTER

1" 1/2" F - 1" M
1" F - 1" 1/2" M



53743

39,70€

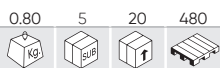

6 ADAPTER IM SET, IN ZOLL FÜR SCHLAGNUSS



ERSATZTEIL VERFÜGBAR

REF.	mm				€
14749	1/4"H - 3/8"M	0.03	20	200	2,00€
14750	3/8"H - 1/4"M	0.05	20	100	2,00€
14751	3/8"H - 1/2"M	0.15	20	100	4,00€
14752	1/2"H - 3/8"M	0.16	10	100	4,00€
11962	1/2"H - 3/4"M	0.17	10	100	7,50€
11964	3/4"H - 1/2"M	0.35	10	100	12,50€

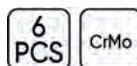

52544

93,00€



SCHLAGADAPTER SET - 6 TEILE



ERSATZTEIL VERFÜGBAR

REF.	mm				€
11962	1/2"H - 3/4"M	0.17	10	100	7,50€
11963	1/2"H - 1"M	0.25	6	54	9,00€
11964	3/4"H - 1/2"M	0.35	10	100	12,50€
11965	3/4"H - 1"M	0.45	6	48	16,00€
11966	1"H - 1/2"M	0.54	6	36	18,00€
11967	1"H - 3/4"M	0.56	4	36	18,00€

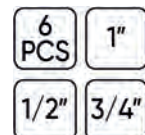

Schlagnüsse



1"				
REF.	mm			€
11153	36	0.70	6 18	23,40€
11154	37	0.73	6 24	21,70€
11155	38	0.90	6 12	24,40€
11156	39	0.74	6 24	28,90€
11157	40	0.78	6 12	26,60€
11158	41	0.95	6 18	28,50€
11159	42	1.00	6 18	30,30€
11160	43	0.95	6 12	27,00€
11161	44	0.90	6 18	32,30€
11162	45	1.10	4 8	29,10€
11163	46	1.00	4 12	32,70€
11164	47	1.05	4 8	30,70€
11165	48	1.00	4 8	34,60€
11166	50	1.21	4 12	30,90€
11167	51	1.18	4 8	38,00€
11168	52	1.18	1 10	41,00€
11169	53	1.27	4 12	39,20€
11170	54	1.33	4 12	40,00€
11171	55	1.44	2 8	51,00€
11172	56	1.47	4 8	48,00€
11173	57	1.44	4 8	47,00€
11174	58	1.58	4 8	47,00€
11175	59	1.58	4 120	49,00€
11176	60	1.75	2 4	56,00€
11177	62	1.63	2 4	55,00€
11178	63	1.75	- 8	53,00€
11179	65	1.87	2 8	65,00€
11180	67	1.93	2 8	59,00€
11181	68	1.93	2 8	65,00€
11182	70	2.05	2 4	73,00€
11183	71	3.10	- 6	70,00€
11184	73	3.27	- 4	87,00€
11185	75	3.34	- 6	97,00€
11186	76	3.35	- 5	91,00€
11187	78	3.47	- 5	98,00€
11188	80	3.60	- 4	103,00€
11189	85	3.80	- 4	121,00€
11190	89	3.80	- 2	138,00€
11191	90	3.90	1 4	149,00€
11192	92	4.85	- 2	152,00€
11193	95	4.90	- 2	183,00€
11194	100	4.43	1 4	176,00€
11621	105	8.50	- 2	290,00€
11622	110	8.13	1 2	399,00€
11623	115	8.62	- 2	489,00€

1" (90mmL)				
REF.	mm			€
13745	28	0.77	6 24	25,20€
13746	30	0.95	6 12	25,40€
13747	32	0.92	6 12	25,40€
13748	33	0.88	6 12	24,90€

EXTRALANGE				
REF.	mm			€
11126	19	0.25	- 10	11,20€
11127	21	0.30	6 24	13,80€
11128	22	0.35	6 24	14,10€
11129	24	0.32	6 54	14,10€
11130	25	0.45	6 24	13,10€
11131	26	0.32	6 36	14,10€
11132	27	0.30	6 54	13,70€
11133	28	0.40	6 12	12,00€
11134	30	0.41	6 24	15,00€
11135	32	0.45	6 48	17,20€
11136	33	0.50	6 12	15,30€
11137	34	0.50	6 24	18,20€
11138	35	0.50	6 12	18,00€
11139	36	0.50	6 24	18,80€
11140	38	0.55	6 24	20,40€
11141	40	0.55	6 12	18,60€
11142	41	0.60	6 12	21,30€
11143	46	0.75	6 18	26,40€
11144	50	1.00	6 24	33,30€
11145	51	1.10	4 12	35,30€
11146	55	1.23	4 12	37,30€
11147	57	1.25	4 12	41,00€
11148	60	1.40	4 12	47,00€
11149	63	1.32	4 12	45,00€
11150	65	1.35	- 8	55,00€
11151	67	1.49	4 12	57,00€
11152	70	1.49	4 12	57,00€

1/2" (78mmL)				
REF.	mm			€
14728	10	0.10	5 20	3,80€
14729	11	0.05	10 100	3,80€
14730	12	0.05	10 100	3,80€
14731	13	0.10	5 20	3,80€
14732	14	0.10	5 20	3,80€
11195	17	0.10	10 100	3,70€
11121	19	0.10	10 60	4,10€
14733	21	0.10	5 20	4,30€
14734	22	0.15	5 20	5,40€
11122	24	0.14	10 20	5,45€
11123	27	0.20	10 50	6,50€
11124	30	0.20	10 50	7,65€
11125	32	0.23	10 50	8,50€

3/4"				
REF.	mm			€
11624	65	2.40	1 2	189,00€
11625	85	5.35	1 2	282,00€
12984	105	5.00	1 2	379,00€

1/2" (78mmL)				
LANGE				
REF.	mm			€
14738	10	0.15	10 100	5,50€
14739	11	0.15	10 100	5,50€
14740	12	0.16	10 100	5,55€
14741	13	0.15	10 100	5,55€
14742	14	0.15	10 100	5,55€
14743	16	0.14	10 100	5,15€
14744	17	0.18	10 50	5,35€
14745	19	0.22	10 50	6,25€
14746	21	0.24	10 50	6,40€
14747	22	0.27	10 50	7,10€
14748	24	0.30	10 50	8,30€
11613	27	0.35	10 20	11,00€
11614	30	0.40	6 24	13,00€
11615	32	0.45	6 24	14,20€
11616	33	0.44	6 12	18,10€
11617	34	0.42	6 24	18,70€
11618	35	0.48	6 18	18,80€
11619	36	0.47	4 48	19,50€

1/2" (78mmL)				
LANGE				
REF.	mm			€
12061	10	0.14	10 100	9,50€
14736	11	0.15	5 20	5,00€
12062	12	0.15	10 100	9,50€
12063	13	0.15	10 50	9,50€
14737	14	0.15	5 20	5,00€
12064	15	0.17	10 100	9,00€
12065	16	0.30	10 20	9,00€
12066	17	0.20	10 100	9,00€
12067	18	0.22	10 20	9,50€
12068	19	0.21	10 50	9,50€
12069	21	0.25	10 50	9,50€
12070	22	0.27	10 100	10,50€
12071	24	0.30	10 50	11,00€
12072	27	0.36	10 20	12,00€

3/4" (90mmL)				
LANGE				
REF.	mm			€
13723	19	0.43	6 12	18,50€
13724	21	0.50	6 12	19,20€
13725	22	0.61	6 18	19,20€
13726	24	0.56	6 24	19,00€
13727	26	0.51	6 18	18,70€
13728	27	0.50	6 18	18,50€
13729	29	0.70	6 12	22,00€
13730	30	0.70	6 24	22,00€
13731	32	0.71	6 24	21,60€
13732	33	0.75	6 24	23,80€
13733	34	0.85	6 18	24,90€
13734	35	0.80	6 18	25,70€
13735	36	0.81	6 12	25,80€
13736	38	0.83	6 18	25,90€

52914 223,00€

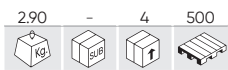

ACHSMUTTERN-SCHLÜSSEL
FÜR BPW, 8-KANT, 120MM



120mm
8 KANTEN
INBUSSCHLÜSSEL 41mm

52915 199,00€

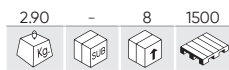

ACHSMUTTERN-SCHLÜSSEL
FÜR BPW, 111 MM



111mm
OVAL
INBUSSCHLÜSSEL 41mm

52916 218,00€

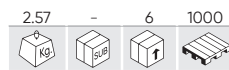

ACHSMUTTERN-SCHLÜSSEL
FÜR BPW, 109 MM - LKW



109mm
8 KANTEN
INBUSSCHLÜSSEL 41mm

52917 122,00€

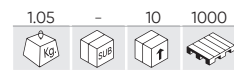

HINTERACHSE MUTTERN-
SCHLÜSSEL FÜR BPW, 65 MM
- LKW



65mm
OVAL
DIAGONALE 36MM

52918 146,00€



HINTERACHSE MUTTERN-
SCHLÜSSEL FÜR BPW, 95 MM
- LKW



95mm
VERTIEFUNG 3/4"

52919 181,00€



3/4 " ACHSMUTTERN-
SCHLÜSSEL FÜR BPW, 110 MM
- LKW



110mm
8 KANTEN
VERTIEFUNG 3/4"

52920 155,00€

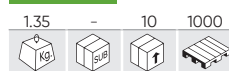

3/4" LAGER-MUTTERN
SCHLÜSSEL FÜR BPW 80MM-
LKW



80mm
VERTIEFUNG 3/4"

52921 117,00€



3/4"HINTERACHSEMUTTERN-
SCHLÜSSEL , FÜR BPW 65MM
6,5 - 9T, 65 MM - LKW



65mm
VERTIEFUNG 3/4"

52922 180,00€



3/4" ROLLENLAGER
HINTERACHSEMUTTERN-
SCHLÜSSEL FÜR BPW 85MM-
LKW



85mm
6 KANTEN
VERTIEFUNG 3/4"

52923 59,00€



3/4" HINTERRAD-
STOSSDÄMPFERFEDER-
DEMONTAGE SCHLÜSSEL
FÜR SCANIA STOSSDÄMPFER
28X37MM - LKW



28x37mm
VERTIEFUNG 3/4"

52924 52,00€



3/4" HINTERRAD-
STOSSDÄMPFERFEDER-
DEMONTAGE SCHLÜSSEL FÜR
SCANIA 34X46MM - LKW



34x46mm
VERTIEFUNG 3/4"

52925 176,00€



SCHLÜSSEL FÜR VORDERRAD
MUTTERN SCANIA 80MM H41
- LKW



80mm
8 KANTEN
INBUSSCHLÜSSEL 41mm

52926 201,00€



3/4" SCHLÜSSEL FÜR
HINTERRAD MUTTERN SCANIA
100MM - LKW



100mm
8 KANTEN
VERTIEFUNG 3/4"

52927 59,00€



3/4" HINTERRAD-
STOSSDÄMPFERFEDER-
DEMONTAGE SCHLÜSSEL FÜR
SCANIA 34X56MM - LKW



34x56mm
VERTIEFUNG 3/4"

52928 172,00€



3/4" VORDERRADMUTTERN
SCHLÜSSEL FÜR SCANIA
80MM - LKW



80mm
8 KANTEN
VERTIEFUNG 3/4"

52929 185,00€



3/4" ACHSMUTTERN
SCHLÜSSEL FÜR SCANIA 95MM
- LKW



95mm
8 KANTEN
VERTIEFUNG 3/4"

SCHLAGWERKZEUGE, STECKSCHLÜSSEL UND BITS

52930 117,00€



EINBAUWERKZEUG FÜR KURBELWELLEN-SIMMERRING FOR SCANIA - LKW



SCANIA 310/320
LIPPEN DICHTUNG 0366303-R

52931 45,00€

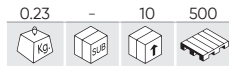

1/2" MOTOR-DURCHDREHVORRICHTUNG FÜR SCANIA - LKW



VERTIEFUNG 1/2"

52932 45,00€

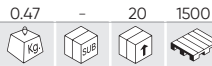

1/2" EINSPRITZDÜSEN-STECKSCHLÜSSEL FÜR SCANIA, 38MM - LKW



Ø38mm
VERTIEFUNG 1/2"

52933 194,00€

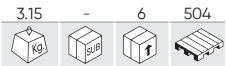

3/4" NUTMUTTERN-SCHLÜSSEL SCANIA 8 ZAPFEN FÜR SCANIA 420 - LKW



Ø11,6mm - Ø10mm
8 ZÄHNE
VERTIEFUNG 3/4"
SCANIA 420

53430 286,00€



12-KANT NABEN-SCHLÜSSEL FÜR IVECO - LKW



Ø134mm - Ø110,5mm
118x134mm
IVECO
12 KANTEN

52935 94,00€

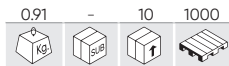

ACHSEN-SPANNMUTTERN-SCHLÜSSEL MAN, MERCEDES-BENZ SW 60 MM - LKW



60mm
VERTIEFUNG 3/4"

52936 199,00€

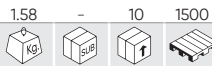

NUTMUTTER SCHLÜSSEL FÜR BENZ-MAN, 80-95MM - LKW



80-95mm
VERTIEFUNG 3/4"
6 ZÄHNE

52937 265,00€

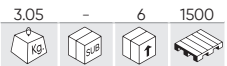

HINTERACHS-NUTMUTTERN SCHLÜSSEL FÜR BENZ-MAN, 95-115MM - LKW



95-115mm
VERTIEFUNG 3/4"
6 ZÄHNE

52938 199,00€



3/4" NUTMUTTERN-SCHLÜSSEL MIT 6 ZAPFEN FÜR BENZ-MAN 100MM - LKW



100mm
VERTIEFUNG 3/4"
6 ZÄHNE

52939 28,00€

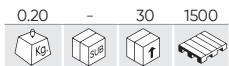

3/4" EINSPRITZDÜSEN-STECKSCHLÜSSEL FÜR BENZ-MAN, 22-28MM - LKW



22-28mm
VERTIEFUNG 1/2"
4 ZÄHNE

52940 235,00€



3/4" NUTMUTTERN-SCHLÜSSEL 6 ZAPFEN AUSGLEICHSGETRIEBE-DIFFERENTIAL FÜR MAN-BENZ 104MM - LKW



101mm
VERTIEFUNG 3/4"
6 ZÄHNE

52941 70,00€



KURBELWELLEN-DREHWERKZEUG, MIT ZWEI ZAHNRÄDER BENZ/MAN - LKW



VERTIEFUNG 1/2"

52942 105,00€

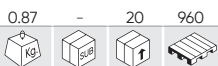

KURBELWELLEN-DREHWERKZEUG, MIT DREI ZAHNRÄDER BENZ/MAN - LKW



VERTIEFUNG 1/2"

52943 75,00€

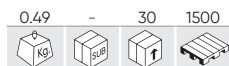

1/2" DREHWERKZEUG FÜR SCHWUNGRAD FÜR BENZ-MAN - LKW



VERTIEFUNG 1/2"

52934 102,00€

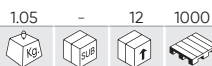

ACHSEN-SPANNMUTTERN-SCHLÜSSEL FÜR MAN, MERCEDES-BENZ SW 56 MM - LKW



56mm
VERTIEFUNG 3/4"

REF.	mm			€
52944	30	1.00	20	110,00€
52945	39	2.74	24	281,00€

KUGELGELENKABZIEHER



52944

52945

INBUSSCHLÜSSEL
19mm

INBUSSCHLÜSSEL
26mm

KAROSSERIEWERKSTATT

- 180 FÜR KAROSSERIE
- 183 RESTAURIERUNG VON SCHEINWERFERN
- 185 GLASERSATZ
- 186 CHASSIS-REPARATUR
- 188 HILFSMÖBEL
- 191 INSTANDHALTUNG DES INNENRAUMS

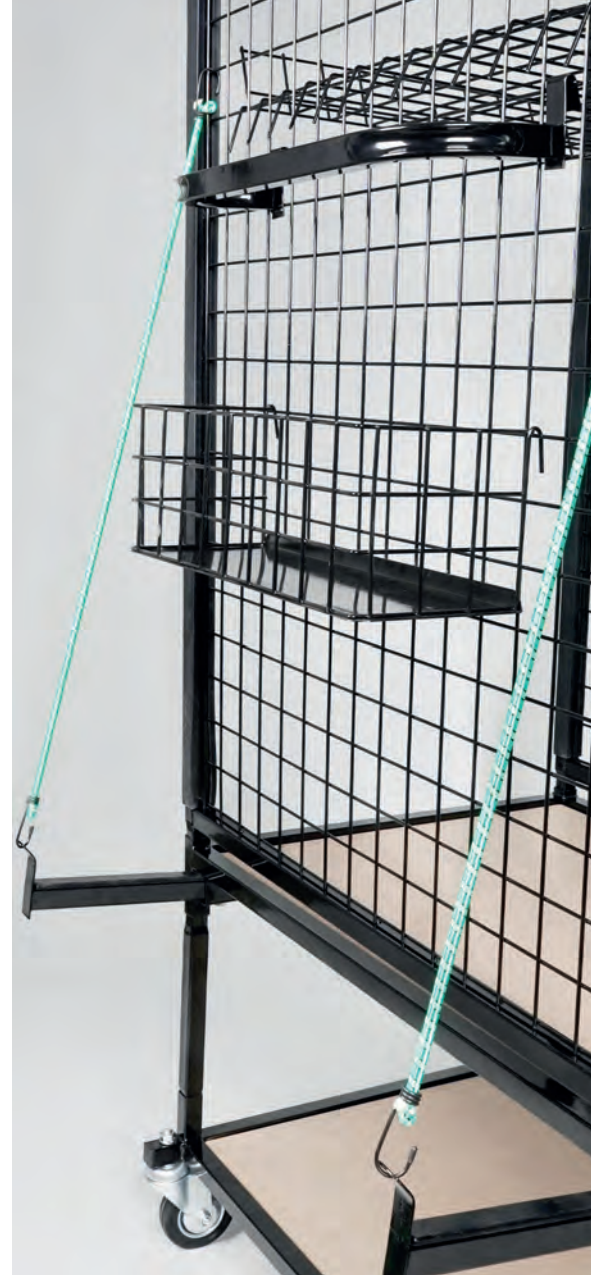

53224

142,00€

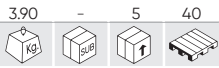

AUSBEUL WERKZEUG SET - 32 TEILE



REF.	BESCHREIBUNG					€
13842	ZUGADAPTER FÜR DELLENLIFTER, 5ER SET - BLAU (IN SET REF. 53224)	0.15	10	100	-	8,50€
13843	ZUGADAPTER FÜR DELLENLIFTER, 5ER SET - GELB (IN SET REF. 53224)	0.01	10	100	-	7,00€
13844	ZUGADAPTER FÜR DELLENLIFTER, 5ER SET - ROT (IN SET REF. 53224)	0.05	10	50	-	9,00€
13845	SET MIT 5 KLEBSTOFF-STANGEN (SET IN REF. 53224)	0.02	10	100	-	8,00€

52876

182,00€

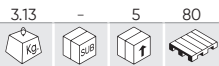

KAROSSERIEWERKZEUG SET - 7 TEILE

REF.	BESCHREIBUNG					€
A 12955	HANDBAUST MIT FLACHE UND OVALE FLÄCHE	0.28	-	25	99	27,80€
B 12956	HANDAMBOSS - KUNSTSTOFFBESCHICHTUNG	0.31	-	25	99	27,80€
C 12957	HANDBAUST MIT OVALE - KUNSTSTOFFBESCHICHTUNG	0.37	5	25	99	27,80€
D 12958	HANDBAUST KEILFORM MIT GRIFF - KUNSTSTOFFBESCHICHTUNG	0.41	-	25	-	27,80€
E 12959	KOMMAFÖRMIGE HANDBAUST - KUNSTSTOFFBESCHICHTUNG	0.30	5	25	99	27,80€
F 12960	ABSATZFORM HANDBAUST - KUNSTSTOFFBESCHICHTUNG	0.18	-	25	1500	27,80€
G 12961	KOMMAFÖRMIGE HANDBAUST MIT GRIFF - KUNSTSTOFFBESCHICHTUNG	0.34	-	25	-	27,80€



51131

61,00€

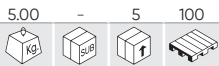

KAROSSERIE-WERKZEUG SET - 7 TEILE

REF.	BESCHREIBUNG					€
A 11541	SPANN-, AUSBEUL- UND SCHLICHTHÄMMER	0.43	5	25	-	11,00€
B 11542	AUSBEUL-PINHAMMER	0.38	5	25	-	11,00€
C 11543	AUSBEUL- UND SCHLICHT- SPITZHAMMER	0.42	5	25	-	11,00€
D 11544	ABSATZFORM HANDBAUST	0.69	5	25	-	7,00€
E 11545	KOMMAFÖRMIGE HANDBAUST	0.79	5	25	-	11,00€
F 11546	HANDBAUST MIT OVALE- UND FLACHFLÄCHE	0.81	5	25	-	12,00€
G 11547	HANDAMBOSS	0.81	5	25	-	12,00€



53545

35,70€



3/8" 6-KANT-SCHLAGNÜSSEN SET, EXTRALANG - 5 TEILE

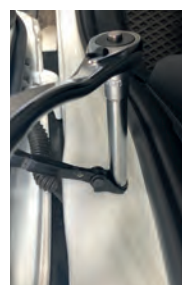

8, 10, 12, 13, 14mm (120mmL)

51832 18,00€

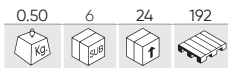

NYLON-HEBELN SET - 4 TEILE



19mm x 273mm
22mm x 273mm
25mm x 273mm
38mm x 273mm



50903 30,80€

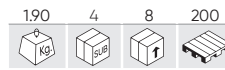

SET METALLHEBEL MIT SCHAFT - 5 TEILE



60, 43, 38,
28, 18cm



52026 31,80€

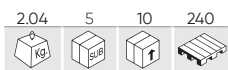

GROSSEN METALLHEBELN SET - 2 TEILE

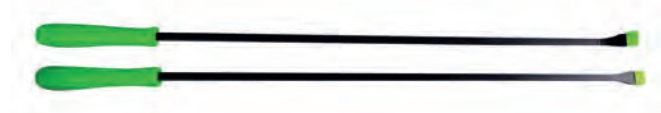

51360 8,05€

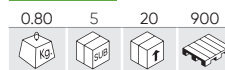

EUOPÄISCHER NAGEL-HEBENEISEN 18"X5/8

18" x 5/8

51361 9,80€

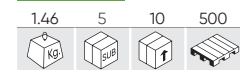

EUOPÄISCHER NAGEL-HEBENEISEN 24"X3/4

24" x 3/4



52851 9,65€

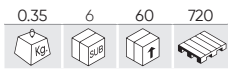

HEBEL FÜR KLAMMERN SET - 2 TEILE

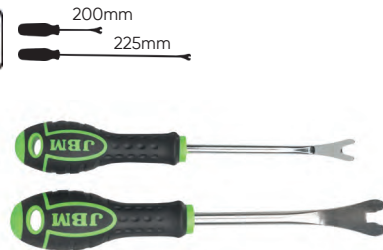

53110 27,30€

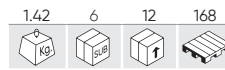

GREIFER SET - 6 TEILE



5"x8.5mm
5"x10.3mm
5"x4.5mm
15"x8.5mm
15"x10.3mm
15"x4.5mm

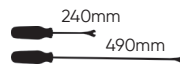

50901 16,00€

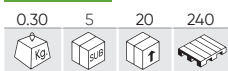

SET AUS 5 NYLON-GRIFFEN



UNIVERSAL
60x160mm
63x175mm
30x200mm
20x180mm
20x215mm



52788 39,00€

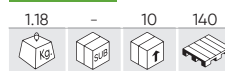

SET AUS 27 NYLON-GRIFFEN



52977

137,00€

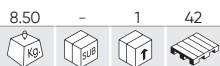

STEMMHEBEL 4ER SET EXTRALANG



52540

221,00€



AUSBEUL-PISTOLE MIT SAUGNAPF

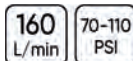

54017

12,00€



SILIKONNAHTABDICHTUNGSWERKZEUG



FÜNF AUSTAUSCHBARE SILIKON-PADS
3R, 6R, 10R, 13R, 17R



52533

10,00€



KARTUSCHEN-PISTOLE PROFI



53525

12,00€



FESTSTELLKRALLE FÜR GASFEDERN



- Maximaler Öffnungsdurchmesser: 10mm.

53655

12,00€



ABZIEHER FÜR TÜRGRIFFE VAG



54246

104,00€

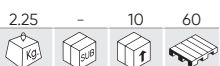

5 KG PRÄZISIONSWAAGE

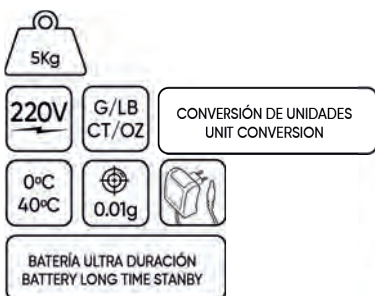

54247

99,00€



2 KG PRÄZISIONSWAAGE

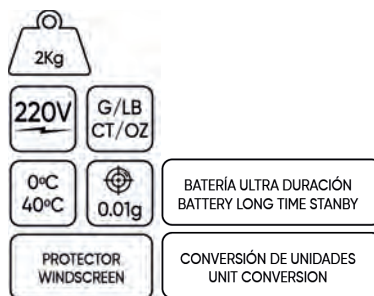

53230

19,70€

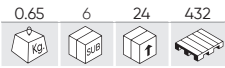

AUFSPERRHILFE SET



52077

29,50€

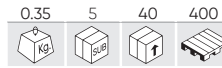

LUFTKISSEN SET - 4 TEILE

40-50mm

ENTHALTEN

Kissen 16 x 16 cm
Kissen 32 x 12 cm
Kissen 19 x 6 cm
Kissen 18 x 4,5 cm
Handpumpe

- Maximale Belastung: 100 kg.



53486

29,30€

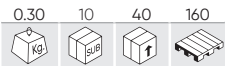

STREIFENSEGEL ZUM ERKENNEN VON DELLEN

Ø 800mm



53673

80,00€

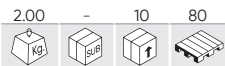

SCHEINWERFER-WIEDERHERSTELLUNG SET

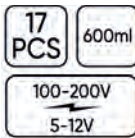

ERSATZTEIL VERFÜGBAR

REF.	BESCHREIBUNG	kg	SUB	cm	€
A	14564 6 SCHMIRGELBLÄTTER FÜR REF.53673	0.10	10	100	9,20€
B	14565 KABELSTROM-ADAPTER FÜR REF.-NR. 53673	0.20	10	50	26,70€
C	14566 ADAPTER 12 V FÜR REF.-NR. 53673	0.05	10	100	16,70€
D	14567 SPRÜHBECHER REF.-NR. 53673	0.15	10	20	38,00€
E	14568 GEBOGENER DECKEL MIT O-RING FÜR REF. 53673	0.01	10	200	9,20€
F	14569 FLACHER DECKEL MIT O-RING FÜR REF. 53673	0.00	10	200	9,20€
G	14570 TRICHTER FÜR REF.-NR. 53673	0.01	10	200	4,05€
H	14571 SCHLEIFPLATTE FÜR REF. 53673	0.05	-	10	9,20€
I	14573 MALER-TAPE FÜR REF. 53673	0.01	10	100	4,05€
J	15375 FLÜSSIGPOLYMER FÜR REF. 53673	0.80	4	24	28,00€

15375

28,00€

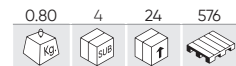

FLÜSSIGPOLYMER FÜR REF. 53673

Ein Flüssigpolymersatz zur Reparatur von Scheinwerfern ist ein innovatives System, mit dem ausgebrannte Scheinwerfer in ihren ursprünglichen Zustand mit einem ursprünglichen glanz und einem perfekten aussehen wiederhergestellt werden können.



GLANZ UND EINEM PERFEKTEN AUSSEHEN

SATZ VON 10 ELEMENTEN SCHLEIFPAPIER

REF.	BESCHREIBUNG	kg	SUB	cm	€	REF.	BESCHREIBUNG	kg	SUB	cm	€
14710	KÖRNRUNG 180	0.25	10	100	3,50€	14713	KÖRNRUNG 600	0.15	10	100	4,25€
14711	KÖRNRUNG 280	0.20	10	100	3,75€	14714	KÖRNRUNG 800	0.15	10	100	4,50€
14712	KÖRNRUNG 360	0.20	10	100	4,00€	14715	KÖRNRUNG 1200	0.10	10	100	4,75€



52740 690,00€

24.00 - 1 11

1520mm 520mm 280mm

SCHEINWERFER EINSTELLGERÄT MIT LUXMETER



HALOGEN / XENON / LED

Meßabstand: 50 cm
Einfache abweichung der optischen achse
Einstellung der abblend- und fernlichtscheinwerfer.
Werden für die einstellung von scheinwerfern mit halogen- und xenonlampen verwendet

52836 1.100,00€

24.85 - 1 10

1560mm 520mm 270mm

SCHEINWERFER EINSTELLGERÄT MIT DOPPEL-LASER UND LUXMETER



HALOGEN / XENON / LED

Auch für LKW.
DOPPEL LASER
DIGITALE LUXMETER
EINSTELLBARES PRÜFUNGS-BILDSCHIRM

53626 18,00€

0.30 - 12 576

SCHEINWERFER-POLIER SET



- BEINHALTET**
- x2 P800 Schleifscheiben**
 - x2 P1200 Schleifscheiben**
 - x2 P2000 Schleifscheiben**
 - x2 3,0 ml UV-Schutzflüssigkeit**
 - x2 Adapter (3/8" und 1/4")**
 - x1 85 g Polierpaste**
 - x1 Klebeband**
 - x1 Wollpolierscheibe**
 - x1 weiße Schwammscheibe**



SERIE262 199,00€

5.25 - - -

SPEZIAL POLIER KIT: POLIERMASCHINE + 12XSCHLEIFGERÄT WIEDERHERSTELLUNG SETS

53626 x12u.

53646 x1u.

53729 19,10€

0.40 10 40 480

H6, H7, T25

300mm

SCHRAUBERZIEHER LANG - EINSTELLUNG VON SCHEINWERFERN



52262

7,50€

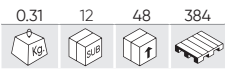

SAUGNAPF Ø 115MM

40Kg
ø 115mm



52263

13,50€

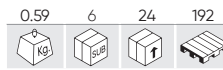

DOPPEL SAUGNAPF Ø 115MM

70Kg
ø 115mm



52264

18,60€

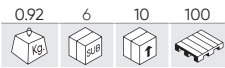

DREIFACHER SAUGNAPF Ø 115MM

100Kg
ø 115mm



52265

30,50€

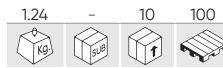

VIERFACHER SAUGNAPF Ø 115MM

120Kg
ø 115mm



52295

6,50€

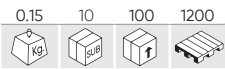

SET AUS 2 MINI- SAUGNÄPFE Ø 60MM

5Kg
ø 60mm



52765

21,70€

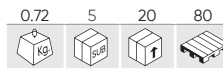

ZWEIFACHER GELENKIGER SAUGNAPF Ø 120MM

80Kg
ø 120mm



52998

48,00€

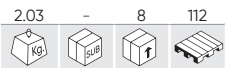

SAUGNAPF-SET MIT RATSCHENGURT 5M X 25MM - SPEZIAL FÜR AUTOSCHEIBEN ABBAU

80Kg
ø 120mm
5x25mm



53232

39,00€

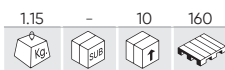

WINDSCHUTZSCHEIBE AUSTAUSCHWERKZEUG

7
PCS



ENTHALTEN

- 1x Werkzeug zum Entfernen der Windschutzscheibe.
- 1x Werkzeug zum Entfernen der Windschutzscheibenleiste.
- 1x Werkzeug zum Entfernen von Verbindungselemente der Polsterbeschläge.
- 1 x 1,8 m Draht.
- 2 Handgriff zum Greifen des Drahtes.
- 1x Drahtvorschubwerkzeug.

ohne MwSt

13813

7,00€

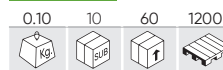

WINDSCHUTZSCHEIBE ENTFERNUNGS-DRAHT

FÜR REF. 53232



13814

11,00€



WINDSCHUTZSCHEIBE ENTFERNUNGSWERKZEUG

FÜR REF. 53232



52321 8,80€

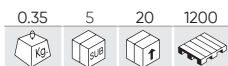

RATSCHENGURT 5M X 25MM

5mx25mm



52327 12,00€



RATSCHENGURT 8M X 25MM

8mx25mm



50577 12,60€



GRIPZANGE

CrV
280mm



52386 23,60€

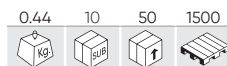

GRIPZANGE MIT PAPAGEI-SCHNABEL FORM - FLACHE SPITZE

CrMo
215mm



52385



GRIPZANGEN SET - 6 TEILE

251,00€

W (195mm)



JJ (195mm)



LL (195mm)



J (210mm)



T (215mm)



L (225mm)



GRIPZANGE

REF.	BESCHREIBUNG							€	
53675	GRIPZANGE - GERADE	10"	250mm	70mm	0.75	10	20	300	50,00€
53676	GRIPZANGE - GEBOGEN	10"	250mm	90mm	0.85	10	20	300	44,00€
53677	GRIPZANGE MIT SCHWENKKISSEN - GEBOGEN	10"	250mm	80mm	0.90	10	20	300	55,00€
53678	LANGE GRIPZANGE - GEBOGEN	10"	300mm	105mm	0.90	10	20	300	52,00€



53675



53676



53677



53678



AUSSTELLER MIT 10 STÜCK

52982







SET GRIPZANGEN EXTRALANG - 3 TEILE

53,00€

3 PCS
37cm 36cm 34cm



GRIPZANGEN

REF.	BESCHREIBUNG	mm	MATERIAL		T					€
52390	SCHWEISS-GRIPZANGE SPEZIAL SCHWENKKISSEN	250mm	CrMo	-	-	0.50	5	40	640	35,20€
52474	ZUGKLEMME - RING 6T	190mm	Aus stahl	0-20mm	5T	3.49	-	5	1500	68,00€
52475	ZUGKLEMME - FLACH 3T	170mm	Aus stahl	0-25mm	3T	3.60	-	10	1500	62,00€
52476	ZUGKLEMME - RECHTECKIG 5T	220mm	Aus stahl	0-25mm	5T	3.10	-	10	1500	50,00€
52477	ZUGKLEMME -SELBSTSPANNEND 2T	200mm	Aus stahl	0-60mm	2T	2.65	-	6	1500	70,00€
52478	ZUGKLEMME - 90° 5T	170mm	Aus stahl	0-20mm	5T	2.90	-	10	1500	49,00€
52479	ZUGKLEMME - 90° MINI 3T	155mm	Aus stahl	0-20mm	3T	1.18	-	30	1500	24,70€
52480	ZUGKLEMME - 90° RECHTECKIG 3T	210mm	Aus stahl	0-25mm	3T	2.00	-	10	1500	44,00€
52481	ZUGKLEMME - RECHTECKIG 3T	220mm	Aus stahl	0-20mm	3T	2.05	-	10	1500	52,00€
52482	ZUGKLEMME - 45° FLACH 5T	210mm	Aus stahl	0-10mm	5T	2.13	-	8	1500	44,00€
52483	ZUGKLEMME - FLACH MINI 3T	210mm	Aus stahl	0-10mm	5T	2.02	-	12	1500	41,00€
52484	KETTENVERBINDER 3T	275mm	Aus stahl	0-110mm	3T	1.19	-	11	1500	66,00€
52485	HAKENVERBINDER 4T	270mm	Aus stahl	0-90mm	4T	1.17	-	30	1000	51,00€
52486	KETTE-HAKEN-VERBINDER 3T	280mm	Aus stahl	0-110mm	3T	1.21	-	11	1500	62,00€
52487	ZUGKLEMME 5T	220mm	Aus stahl	0-20mm	5T	2.27	-	7	1000	63,00€
52502	SCHWEISS-GRIPZANGE	280mm	CrMo	0-110mm	-	0.84	10	30	540	31,40€
52503	SCHWEISS-GRIPZANGE MIT SCHWENKKISSEN	280mm	CrMo	0-105mm	-	0.85	10	30	540	32,50€
52504	DOPPEL-GRIPZANGE	225mm	CrMo	0-50mm	-	1.14	-	30	480	27,60€
52505	VERSCHLUSS-GRIPZANGE	170mm	CrMo	0-40mm	-	0.27	36	72	2160	20,80€
52506	VERSCHLUSS-GRIPZANGE MIT SCHWENKKISSEN	170mm	CrMo	0-50mm	-	0.28	36	72	2160	16,00€
52507	FLACHE-GRIPZANGE	250mm	CrMo	0-80mm	-	0.77	5	30	420	30,10€
52511	SCHWEISS-GRIPZANGE 18"	440mm	CrMo	0-225mm	-	1.31	-	20	280	42,00€
52512	LANGE SCHWEISS-GRIPZANGE MIT SCHWENKKISSEN	440mm	CrMo	0-210mm	-	1.31	-	20	280	50,00€



53983

215,00€

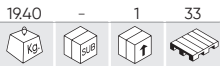

KAROSSE TEILEWAGEN – WINDSCHUTZSCHEIBEN UND MOTORHAUBEN



12 STANGEN VON 630MM MIT PE-SCHAUM-BESCHICHTUNG

BIS 5 GROSSE PLATTEN ODER GLÄSER

POLYURETHAN-ROLLEN (PU-ROLLEN) 4 X 4 ZOLL (ZWEI SCHWENKBAR MIT BREMSE)

53125

477,00€

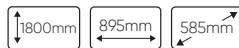
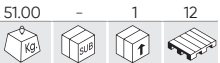

TRANSPORTWAGEN FÜR AUTOTEILE



53124

287,00€



UNIVERSALLER TELESKOP-STATIV



HÖHE
↑ MAX: 1320mm
MIN: 840mm

LÄNGE
↑ MAX: 1380mm
MIN: 225mm



50923

454,00€



SPEZIELLER TRANSPORTWAGEN FÜR KAROSSEARBEITEN - FLACH



- Trennung 0-110cm.



REF.	BESCHREIBUNG	KG	STÜCK	PLATZ	€
12022	ERSATZRAD FÜR REF.50923	194	-	10 1500	33,70€

53080 99,00€



TRAGBARER STATIV FÜR WINDSCHUTZSCHEIBE



70Kg

52749 79,00€

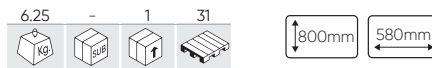

KLAPPBARER STÄNDER FÜR KAROSSERIE



220Kg

REF. BESCHREIBUNG €
 11959 2X SCHAUMAUFLAGEN FÜR REF. 52749 0.08 100 10,50€

53079 89,00€

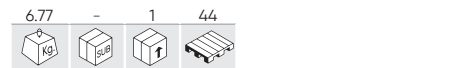

X-STANDER

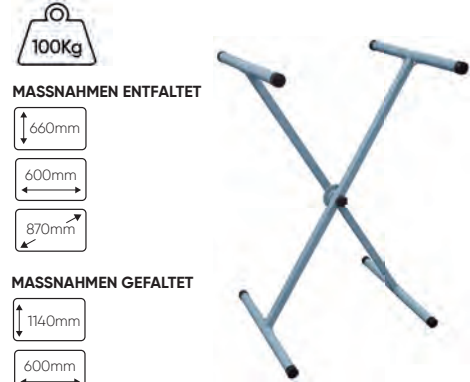

100Kg

MASSNAHMEN ENTFALDET

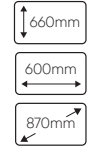

MASSNAHMEN GEFALDET

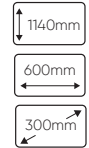

53736 98,00€



KLAPPBARER STOSSFÄNGERSTÄNDER



70mm

DIE EINSTELLBARE STANDBREITE MIT AUSZIEHBARE HEBELN MACHT DAS GERÄT VIELSEITIG UND FÜR STOSSFÄNGER UNTERSCHIEDLICHER TYPEN UND KONSTRUKTIONEN GEEIGNET

VERSTELLBARER STAND: 75 CM -160CM

MAXIMALE HÖHE: 148CM

STAHL

53685 310,00€



VERSTELLBARER STOSSFÄNGER STÄNDER



STÜTZHEBEL EINSTELLUNG IM 134-198CM BEREICH

4 X 4" ROLLEN (ZWEI SCHWENKBARE MIT BREMSVORRICHTUNGEN)

GEPULVERTES STAHL

53134 144,00€



VERSTELLBARER LACKIERSTÄNDER



150Kg



- 6 Haken zu befestigen Stücke oder trocken zu malen.
 - Verstellbaren Rahmen, die von 127cm bis 203cm verlängert.

53126 243,00€



DREHGESTELL ZUM LACKIEREN

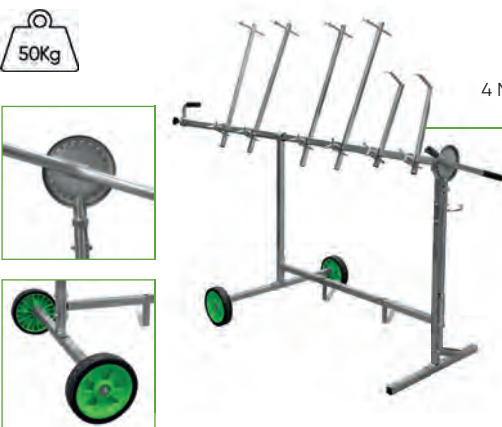

50Kg

6 ARMEN HÄLT: 4 MIT FESTEN HAKEN 2 MIT LOCH

52230

398,00€

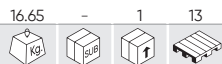

ALUMINIUM STEIGLEITER-BÜHNE, TELESKOPISCH

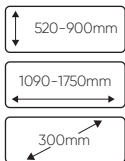

REF. BESCHREIBUNG

REF.	BESCHREIBUNG	KG	SUB	TEILE	€
10964	ERSATZ SEITENSCHUTZ FÜR REF.52230	0.01	-	1	9,00€
10965	ERSATZ OBERSTÜCK REF.52230	0.01	-	1	6,00€
10966	ERSATZ LEITERFUSSGUMMI REF.52230	0.06	-	1	13,50€

ZERTIFIZIERUNG: EN 131

50913

195,00€

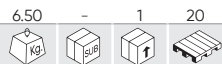

ALUMINIUM STEIGLEITER-BÜHNE



ZERTIFIZIERUNG: EN 131

50656

290,00€



ALUMINIUM STEIGLEITER-BÜHNE SET - 2 TEILE



ZERTIFIZIERUNG: EN 131

REF. BESCHREIBUNG

REF.	BESCHREIBUNG	KG	SUB	TEILE	€
11897	100x30x30cm	4.66	-	1	155,00€
15552	130x30x55cm	6.80	-	1	181,00€

53922

29,00€



PAPIERROLLEN WANDHALTER

- Rostfreier Stahl
- Rolle: max. Breite 38 cm
- Klemme - ABS
- Kunststoff, grau.
- Befestigungsschrauben und Muttern aus rostfreier Stahl.

PAPIER NICHT ENTHALTEN



53921

39,00€



BODENROLLENHALTER

- Material: rostfreier Stahl
- Rolle: max. Breite 38 cm
- Klemme
- ABS-Kunststoff

PAPIER NICHT ENTHALTEN



HALTER + MATERIALIEN ZUR PFLEGE FÜR DAS FAHRZEUG

50400 168,00€

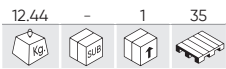

BEINHALTET

- 53705 HALTER
- 51978 SITZSCHONER ROLLE
- 52057 LENKRADSCHUTZ-FOLIE ROLLE
- 52058 LENKRADSCHUTZFOLIE
- 50409 AUTO FUSSMATTE

50403 98,00€

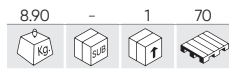

BEINHALTET

- 52065 HALTER
- 51978 SITZSCHONER ROLLE
- 52057 LENKRADSCHUTZ-FOLIE ROLLE
- 52058 LENKRADSCHUTZFOLIE

50410 168,00€

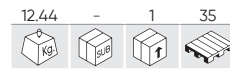

BEINHALTET

- 53705 HALTER
- 52244 SITZSCHONER ROLLE
- 52057 LENKRADSCHUTZ-FOLIE ROLLE
- 52058 LENKRADSCHUTZFOLIE
- 50409 AUTO FUSSMATTE

WANDALTER FÜR SITZDECKEN, LENKRADHÜLLEN, FUSSMATTEN

53705 80,00€

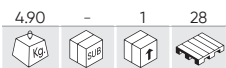

51985 84,00€

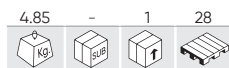

52065 45,00€

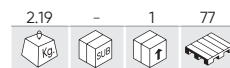

51978 84,00€



SITZSCHONER ROLLE MIT 250 STCK. - 25MC



52244 84,00€



SITZDECKEN WEISSES MODELL 250U. 25MC



52057 6,80€



LENKRADSCHUTZ-FOLIE ROLLE

23 mc - Länge: 200 m
- Breite: 12,5 cm
- Stärke: 23 µm



REF. 52057

52058 4,50€



LENKRADSCHUTZFOLIE FÜR REF.52057

23 mc

REF. 52058

50409

26,00€

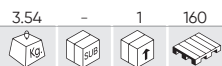

AUTO FUSSMATTE

250 PCS



51824

36,80€



SET AUS 250 LENKRADHÜLLEN

250 PCS



50916

0.05 100 400 3200



WARTUNGS-SET IN EINZEL VERPACKUNG

5 PCS 20 mc



0,88€

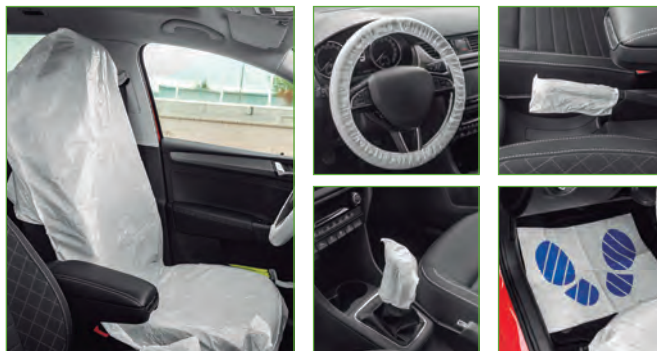

53226

14,90€

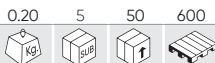

AUTOSITZ ABDECKUNG



- UNIVERSAL.
- NYLON.

51622

25,30€



MAGNETISCHE SCHUTZABDECKUNG
LAMELLEN UND FRONTEN



4 MAGNETBEFESTIGUNGEN

ZWEI SEITEN: SAMT/PLASTIK

AUSZIEHBARER MHRFUNKTIONS-GRIFF

REF.	Max.	Min.					€
52497	1200mm	530mm	0.29	6	48	480	26,80€
53196	1600mm	710mm	0.37	6	48	384	33,00€



BREMSEN

194 AUSTAUSCHER

197 ENTLÜFTER

197 WARTUNG

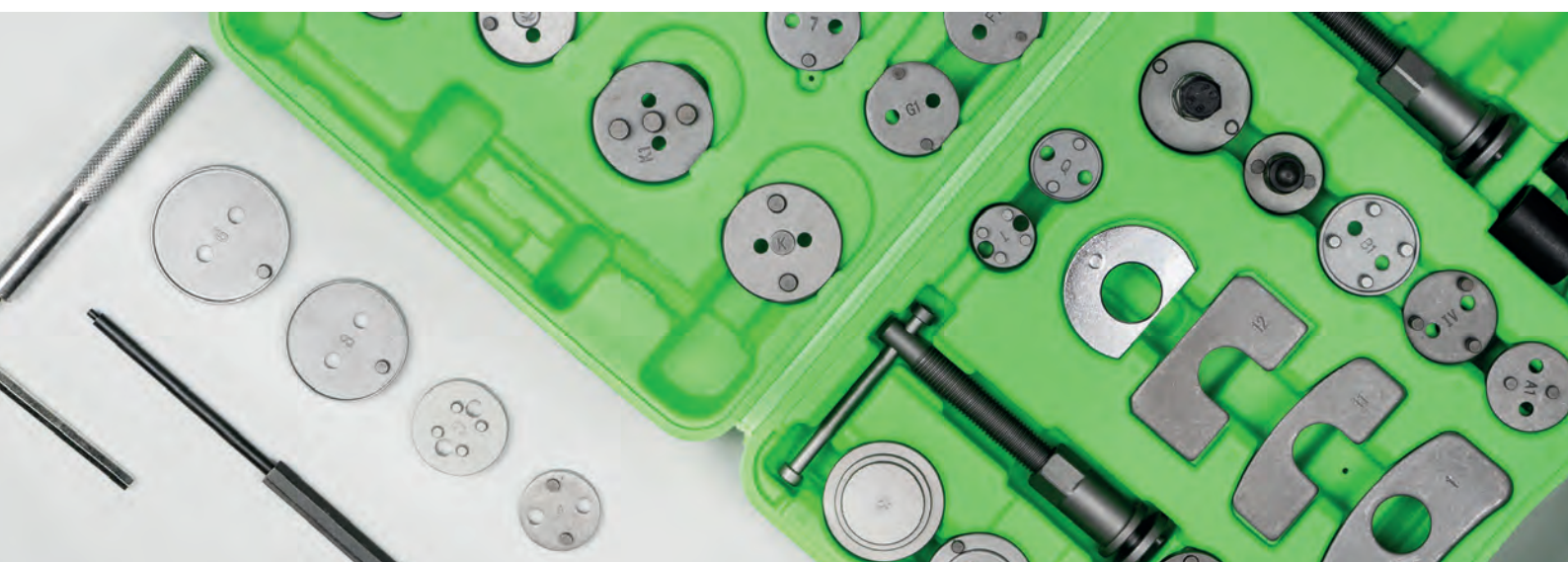

52636

114,00€

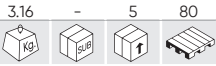

16 PCS

BREMSEN RÜCKSTELLER ADAPTER SET MIT DRUCKLUFTWERKZEUG - 16 TEILE

- 0 General Motors (Kolben Ø 2-1/2 Zoll)
- 2 Citroën XM/Xantia (F/R), HONDA
Audi (F), Fiat, Alfa romeo (F), Ford Fiesta (F), Isuzu (F), Honda Concesto (F), Jaguar XJ6/ XJ40 (F/R), BMW 318is / 320i / 325T / 518i / 525i-1x / 740i / 850ci / M5 (F), Mercedes BENZ 190/200/300/420/560 serie (F), Mitsubishi Colt (F), Nissan Miera/Stanza/Sunny (F), Rover Austin/Metro200-400 series/Maestra/Montego (F), Toyota Camry (F), Volvo (F), VW Passat/Golf GTI (F)
- 3 Audi (F), Fiat, Alfa romeo (F), Ford Fiesta (F), Isuzu (F), Honda Concesto (F), Jaguar XJ6/ XJ40 (F/R), BMW 318is / 320i / 325T / 518i / 525i-1x / 740i / 850ci / M5 (F), Mercedes BENZ 190/200/300/420/560 serie (F), Mitsubishi Colt (F), Nissan Miera/Stanza/Sunny (F), Rover Austin/Metro200-400 series/Maestra/Montego (F), Toyota Camry (F), Volvo (F), VW Passat/Golf GTI (F)
- 4 Ford Australia/NZ Telstar, Mazda (R), Saab 9000 (R)/Lumina, Toyota, Fiat 164 2.0 (R), Alfa Romeo Prelude/CRS 16i, Honda Saturn (R)/Grand Prix, GM
- 5 Adapter 3/8"
- 6 Nissan Primera, VW Golf IV
Audi 80/90/V8+100/Coupe E (R), Rover 800 ABS, Subaru L+Z (R), Ford Sierra ABS/Granada/Scorpio ABS (R), Nissan Bluebird 1.8 Turbo/Silvia Turbo/Primera2.0i LS-GS-GSX (R), Peugeot 405 1.9Gi/Gri/Sri/Gtxi/Mi 16/605 2.0 Sri (R), Toyota Cecilia/Corolla GT/MR2 (R), VW Golf Gti/Jeta Synchron/Jetta Gti 16v, Passat CL, GL, GT, GT 16v, Corrado 16V scirocco GTX 16V(R), Citroën, Alfa romeo, Fiat, Honda, Jaguar, Renault, Saab, Seat, Lancia.
- 7 Audi 80/90/V8+100/Coupe E (R), Rover 800 ABS, Subaru L+Z (R), Ford Sierra ABS/Granada/Scorpio ABS (R), Nissan Bluebird 1.8 Turbo/Silvia Turbo/Primera2.0i LS-GS-GSX (R), Peugeot 405 1.9Gi/Gri/Sri/Gtxi/Mi 16/605 2.0 Sri (R), Toyota Cecilia/Corolla GT/MR2 (R), VW Golf Gti/Jeta Synchron/Jetta Gti 16v, Passat CL, GL, GT, GT 16v, Corrado 16V scirocco GTX 16V(R), Citroën, Alfa romeo, Fiat, Honda, Jaguar, Renault, Saab, Seat, Lancia.
- 8 General Motors (Kolben Ø 1-7/8 Zoll)
- 9 General Motors (Kolben Ø 2-1/8 Zoll)
- A(Z) Renault (R21-Laguna (R))
- E Nissan Maximas/Cefiro
- F(G) Opel (Rear disk)/ Fiat Stilo
- K Citroën C5
- K1 Renault, Citroën C5

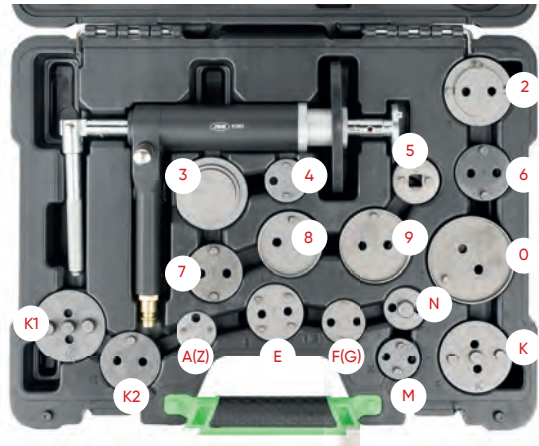

- K2 Renault, Citroën, Audi A8, S8
- M Ford, Mini Cooper, Nissan Primera 03
Saab, Honda, Alfa Romeo 164 2.0 Twin Spark/2.0 Turbo (88-)/3.0 V6, Audi 200 (80-)/Coupe GT SE (82-)/80/90/1QO/200/Quattro (87-)/90/20V (88-), Ford Mondeo 2.0/Ghia, Lancia Themaalte (85-), Volkswagen Golf II GTI (83-87)/Sirocco 16V (84)
- N Ford, Mini Cooper, Nissan Primera 03
Saab, Honda, Alfa Romeo 164 2.0 Twin Spark/2.0 Turbo (88-)/3.0 V6, Audi 200 (80-)/Coupe GT SE (82-)/80/90/1QO/200/Quattro (87-)/90/20V (88-), Ford Mondeo 2.0/Ghia, Lancia Themaalte (85-), Volkswagen Golf II GTI (83-87)/Sirocco 16V (84)

52330

99,00€

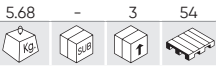

50 PCS OPEL PEUGEOT CITRÖEN RENAULT

BREMSEN RÜCKSTELLER ADAPTER SET - 50 TEILE

- 0 General Motors (Kolben Ø 2-1/2 Zoll)
- 1 Scheibe
- 2 Citroën XM, Xantia u.a.
- 3 Alfa Romeo,Audi, Austin, BMW, Ford, Honda, Jaguar, Mercedes-Benz. Mitsubishi, Nissan Rover, Toyota, VW
- 4 Alfa Romeo 164 2.0.Ford, Mazda, Saab 9000, Subaru
- 5 Adapter 3/8"
- 6 Nissan Primera, VW-Golf IV
Audi 8.0,90,V8 +100, Ford Sierra ABS+ Scorpio ab 85, Honda Prelude, Nissan Silvia 1.8 turbo, Rover 8000, Saab 9000, Subaru L+Z, VW-Golf+ Passat
- 7 Audi 8.0,90,V8 +100, Ford Sierra ABS+ Scorpio ab 85, Honda Prelude, Nissan Silvia 1.8 turbo, Rover 8000, Saab 9000, Subaru L+Z, VW-Golf+ Passat
- 8 General Motors (Kolben Ø 1-7/8 Zoll)
- 9 General Motors (Kolben Ø 2-1/8 Zoll)
- 11 Scheibe für einen Jaguar, S-Klasse
- 12 Scheibe für einen BMW-Mini
- A Nissan Premira 2.0, Bluebird
- A1 Ford Transit 06,Transit Connect 02,Tourneo Connect 02,Mondeo 00-07,C-Max 03, Focus 04
- B Ford, Lincoln, Subaru
- B1 Ford S-max 06,Scorpio 94-06,Mondeo 07,Kuga 08,Galaxy 00-06,Focus RS 03,Fiesta 01-02,Cougar 98-01
- C Nissan Primera (02), Opel Vectra 02-,Toyota Avensis
- D Citroën, Renault
- E Cefiro, Maxima
- F Peugeot 206 CC/Hdi/Gti.A ein 16 mm Schlüssel mit umgestülpten Kolben wird erforderlich sein
- F1 Fiat Ducato
- G Opel
- G1 Volkswagen Golf V / VI
Alfa Romeo 155 1.8-2.0 164 TD(93) 164 3.0 V6(91), Audi 80,90,A3,A4,A6,A8, Citroen ZX 2 Qi 16V, Fiat Tipo TD 16V, Uno Turbo (85) Crama TD, Ford Sierra (ABS bak). Granada (85) Crama TD, Ford Sierra (ABS bak). (Australia& NZ) Thunderbird Turbo, Honda CRX, 1.6i-16V (8-90), Accord 1800 (84-85) 2.0i, Prelude 16V (88), Legend V6, Jaguar XJ 4, Oseries, Lancia Dadra 2.0, Ei Tur (93), Delta 1.6 Gti, Nissan, Peugeot, Renault, Seat, Subaru, Volvo V40 6S40.
- J
- K Citroën C5
- K1 Citroën
- K2 Citroën, Renault.
- M Ford
- N Saab, Honda
- O Scheibe

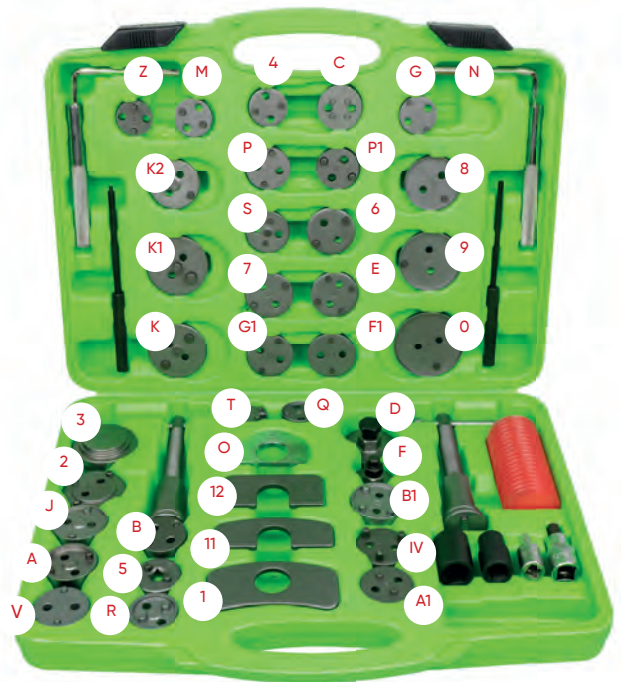

- P Audi, BMW, Ford, Lancia, Piston, Renault, Rover.
- P1 Peugeot 307,308.
Alfa Romeo 164 2.0 1., Fiat Uno, Turbo ie-Barchetta, Ford Escort MK III, IV, Orion, XR31, Focus(98-) push-back pistons, Honda-most models (push-back pistons), Rover-most models(push-back pistons), Subaru Lserie & Serie 2
Ford(Australia& NZ) Teslar, Laser, Mazda 323 Gti, GTXX (86), 929 (82.), RX7(81-), 626
R 16V(87-) 626 GT (86-), 929 V6 (88-), Mitsubishi Galant GL Si, Toyota Celica, Corolla GT, MR2
Audi 100 TQ(91), BMW 740i 8cyl (91), Lancia Delta 1.9 TD (95), Proton 416, Renault-most models, Renault Laguna 2.0 (94), Laguna 2.2 D (95) Safrane 2.0-2.2 TD V6, Rover 623 Si, Volkswagen Golf Gtu Mk I&IV, Passat VR6, Vento GT (92)
- S Audi 100 TQ(91), BMW 740i 8cyl (91), Lancia Delta 1.9 TD (95), Proton 416, Renault-most models, Renault Laguna 2.0 (94), Laguna 2.2 D (95) Safrane 2.0-2.2 TD V6, Rover 623 Si, Volkswagen Golf Gtu Mk I&IV, Passat VR6, Vento GT (92)
- T Rover 220 C Turbo (95)
- V Rover 216 Gti 16V,820 Si 2.0(93),825 SD 2.5 (93)
- Z Renault
- IV Iveco Daily, Volkswagen Passat 2.0 TDI 09-

53978

38,90€

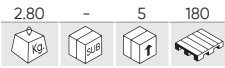

23 PCS

WERKZEUGSATZ ZUM HINEINDRÜCKEN VON KOLBEN - 23TLG

- 0 General Motors (Kolben Ø 2-1/2 Zoll)
 - 1 Scheibe
 - 2 Citroën XM, Xantia
 - 3 Alfa Romeo, Audi, Austin, BMW, Ford, Honda, Jaguar, Mercedes-Benz, Mitsubishi, Nissan, Rover, Toyota, VW
 - 4 Alfa Romeo 164 2.0, Ford, Mazda, Saab 9000, Subaru
 - 5 Adapter 3/8"
 - 6 Nissan Primera, VW.Golf IV
 - 7 Audi 80;90;V8+100, Ford Sierra ABS+Scorpio de 1985, Honda Prelude, Nissan Silvia 1.8 turbo, Rover 8000, Saab 9000, Subaru L+Z, VW Golf + Passat
 - 8 General Motors (Kolben Ø 1-7/8 Zoll)
 - 9 General Motors (Kolben Ø 2-1/8 Zoll)
 - 10 VW K1 Citroën
 - A Renault R21, Laguna K2 Citroën
 - E Nissan Maxima, Cefiro M Ford
 - F Opel N Saab, Honda
 - K Citroën C5 O Scheibe
- J Fiat Tipo TD 16V, Uno Turbo(85) Crama TD, Honda CRX, Alfa Romeo 155 1.8-2.0i, 164 TD (93), 164 3.0 V6 (91); Audi 80, 90, & V8's, A3, A4, A6, A8 (pinza trasera); Citroën ZX 2. Ql 16v; Fiat Tipo TD 16V, Uno Turbo (85-), Crama TD; Ford Sierra (ABS bak), Granada (85-); Ford (Australia & NZ) Thunderbird Turbo; Honda CRX, 1.6i-16V (88-90), Accord 1800 (84-85), 2.0i (86-), Prelude 16V (88-), LegendV6; Jaguar XJ serie 40; Lancia Dedra. 2.0 Ei Tur(93), Delta 1.6 Gti. (92), The. majE 16v(92), Thema. 2000 Turbo. Kappa 2.Q-2.4LS, 2.4TD;

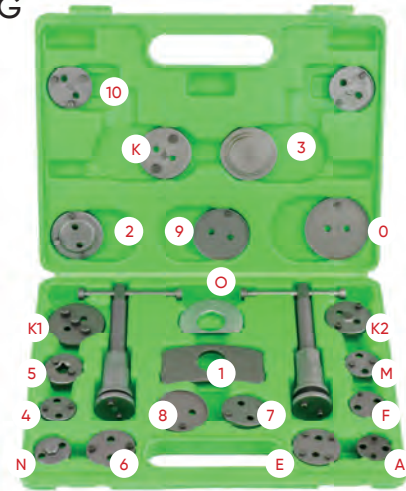

- J Nissan 280 ZX (82-84), 300 ZX Turbo (84-89), Bluebird 16V (89-), Silvia 1.8 Turbo (85-88) 100 NZ 2.0 (93), Primera 2.0 GT (94), 200 SX turbo 16V, Maxima 2.0 GX-3.0 GX (95); Peugeot 306; Peugeot 309 Gtj 16S (91), 405. Srif Q. rj, Gil (87-), 405 M.1 16V; Renault Master Van; Rover 216 Gti 16V, 820 Si 2.0 (93), 825 SD 2.5 (93); Saab 9000 CS 2.0(93), 9000 CSE Turbo(93); Seat Toledo GT. 16V-GT 2.0(93), Ibiza 1.8 Gti 16V(95); Subaru Lserie & Serie 2; Volkswagen Passat 2.0 & 2.2 Litre(84), Golf Rallye (-89), Golf II Gti 16V(89-), Vento GT (92), Transporter T4; Volvo S40 & V40

51059

99,00€

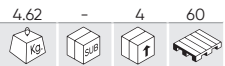

37 PCS

BREMSEN RÜCKSTELLER ADAPTER SET - 37 TEILE

- 0 Scheibe
- 1 Scheibe
- 2 Citroën XM, Xantia (F/R)
- 3 Alfa Romeo, Audi, Austin, BMW, Ford, Honda, Jaguar, Mercedes-Benz, Mitsubishi, Nissan, Rover, Toyota, VW.
- 4 Alfa Romeo 164 2,0,Ford,Mazada,Saab 9000,Subaru.
- 5 Adapter 3/8"
- 6 Nissan Primera,VW-Golf IV.
- 7 Audi 80,90,V8 +100,Ford Sierra ABS+Scorpio ab 85,Honda Prelude Nissan Silvia 1.8 turbo,Rover 8000, Saab 9000, Subaru L+Z, VW-Golf +Passat.
- 8 General Motors (Kolben Ø 1-7/8 Zoll)
- 9 General Motors (Kolben Ø 2-1/8 Zoll)
- 11 Scheibe für einen Jaguar, S-Klasse
- 12 Scheibe für einen BMW-Mini
- A 1-3 / 16" zweiachsige Scheibe für Renault R21, Laguna
- B Ford, Lincoln, Subaru.
- C Mini Austin
- D Citroën, Renault.
- E Cefiro, Maxima
- F Opel Corsa, Astra, Zafiraand Vectra
- G Opel (hintere Scheibe)
- H Alfa Romeo 155 1.8-2.0 164 TD(93) 164 3.0 V6(91) Audi,80,90,A3,A4,A6,A8 Citreon ZX 2 Ql 16V,Fiat Tipo TD 16V,Uno Turbo(85) Crama TD, Ford Sierra(ABS bak),Granada (85),(Australia & NZ) Thunderbird Turbo,Honda CRX,1.6i-16V (8-90),Accord 1800(84-85)2.0i,Prelude 16V(88),Legend V6,Jaguar XJ40series,Lancia Dedra 2.0 Ei Tur(93),Delta 1.6Gti,Nissan,Peugeot, Renault,Seat,Subaru,Volvo V40& S40.
- K Citroën C5
- K1 Citroën, Renault.
- K2 Citroën, Renault.
- M Ford
- N Saab,Honda. Z: Renault
- O GM Motors.
- P Audi, BMW, Ford, Lancia, Proton, Renault, Rover, VW
- R Ford (Australia & NZ) Telstar,Laser, Mazda 323 Gti,GTX(86-),929(82-),RX7(81-),626 16V (87-), 626 GT (86-),929 V6(88-),Mitsubishi Galant GL Si, Toyota Celica,Corolla GT,MR2. Audi 100TQi(91), BMW 740i 8cyl.(91), Lancia Delta 1.9 TD(95), Proton 416, Renault-most models, Renault Laguna 2.0 (94), Laguna 2.2 D(95), Safrane 2.0-2.2 TD V6, Rover 623 Si, Volkswagen Golf Gti Mk 3&4,Passat VR6,Vento GT(92).

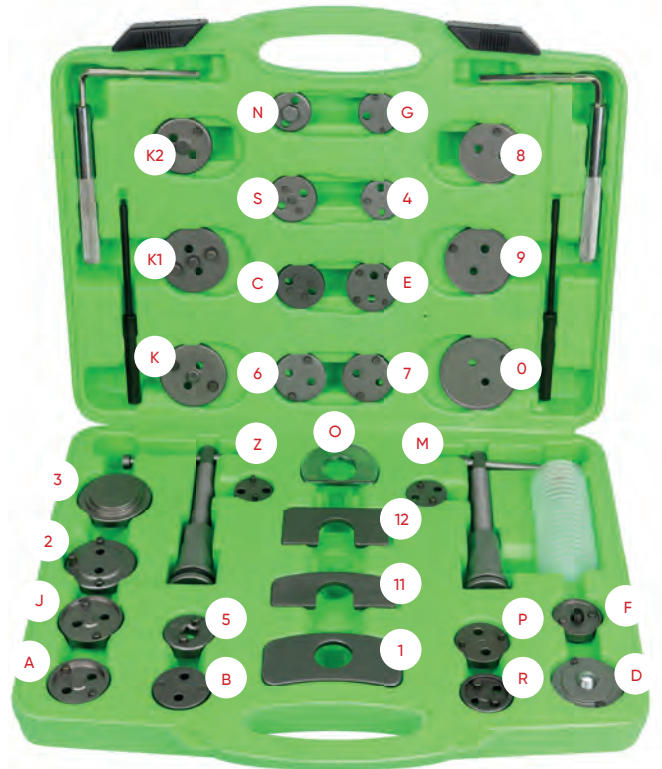

- Z BMW, Mini
- Joch mit Rechtsdrehung (mit Rechtsgewinde)
- Joch mit Linksdrehung (mit Linksgewinde)
- Pin Ø 3.0 / Pin Ø5.5 (100g Fett)

52906

38,00€



UNIVERSALER BREMSEN RÜCKSTELLER ADAPTER SET



REF. BESCHREIBUNG

REF.	BESCHREIBUNG	1.30	5	500	€	
12974	ERSATZ 2-POLIG FÜR REF. 52906	0.50	-	50	1500	21,00€
12975	ERSATZ 3-POLIG FÜR REF. 52906	0.17	-	50	-	23,00€

ALFA ROMEO 164 2.0, FORD, MAZDA, SAAB 9000, SUBARU, NISSAN PRIMERA, VW, AUDI, FORD SIERRA ABS + SCORPIO AB 85, HONDA PRELUDE, NISSAN SILVIA 1.8 TURBO, ROVER 8000, SAAB 9000, FORD, OPEL, BMW, LANCIA, PROTON, RENAULT, ROVER, PEUGEOT 307, 308 A3- IVECO DAILY, VOLKSWAGON PASSAT 2.0 TDI 09, RENAULT LAGUNA.

53683

116,00€

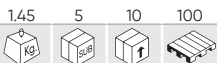

DRUCKLUFT BREMSEN RÜCKSTELLER, OHNE ÜBERSTAND

- Druckluftwerkzeug.
- Arbeitsnennndruck: 5-8 bar.
- Maximaler Arbeitsdruck: 14 bar.



51283

78,00€

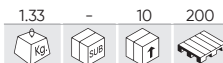

DRUCKLUFT BREMSEN RÜCKSTELLER

- Druckluftwerkzeug.
- Arbeitsnennndruck: 5-8 bar.
- Maximaler Arbeitsdruck: 14 bar.



52191

198,00€

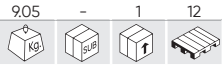

BREMSEN-ENTLÜFTUNGSGERÄT

5L

- Einstellbarer Arbeitsdruck: von 0 bis 4 kg/cm³.
- Eingangs- und Ausgangs-verschlussstück.
- Gewicht: 5 kg.
- Adapterzahl: 11 + 2 Universaladapter.
- Anwendungsgebiet: GM, Chrysler, Nissan.



REF. BESCHREIBUNG

52328 ADAPTER-SET FÜR BREMSENENTLÜFTUNGSGERÄT (REF.52191)

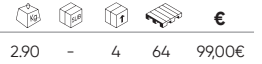

52434

125,00€

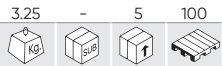

15 PCS

BREMSENWARTUNGS-SET

- x2 Ringschlüssel für bremsleitungen
- x1 Flachzange für brems-stoßdämpfer
- x1 Schlagschraubendreher
- x3 Schraubendreheransatz
- x1 Montagewerkzeug
- x1 Schraubendreherfassung mit universalgelenk
- x1 Spezialwerkzeug für bremsen
- x1 Bürste für bremsgestänge
- x1 Messing-bürste für bremsgestänge
- x1 Flachzange für stoßdämpfer des brems-seils
- x1 Feile für bremsgestänge
- x1 Mit integriertem flachem schaber für die entfernung von resten



54135

82,00€

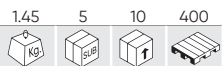

17 PCS

BREMSSATTEL-STECKSCHLÜSSELSATZ

ENTHALTEN

	x2	14x38, 22x38mm
	x3	11,50x38, 15x38, 20x38mm
	x4	10, 12.50, 14, 19mm
	x1	10mm
	x4	H11x100, H7x70, H7x92, H9x50mm
	x2	7x24, 8x24mm
	x1	9x20mm



AUDI (A4, A5, S5, S8, Q5, Q7), PORSCHE (CAYENNE, MACAN, CAYMAN), MERCEDES BENZ, FORD, BMW, ALFA ROMEO

54372

157,00€



N

BREMSPRÜFGERÄTESET MIT UND OHNE ABS

Für die Demontage der Bremssättel beim Austausch der Bremsbeläge.

ANWENDUNGEN

Audi (TT (2007-), A4 (2001-), A6 (2005-), A8 (2003-), Q7, S5, S6, S8), Porsche (Cayenne, Macan, Cayman), Mercedes-Benz (ML320, Classe C), Ford (Mondeo, Fiesta, Focus, Edge), BMW (Series 3 -generación E36 / 5), Alfa Romeo, Jaguar (XF), Vauxhall, Volkswagen, Chrysler, Mini, SAAB

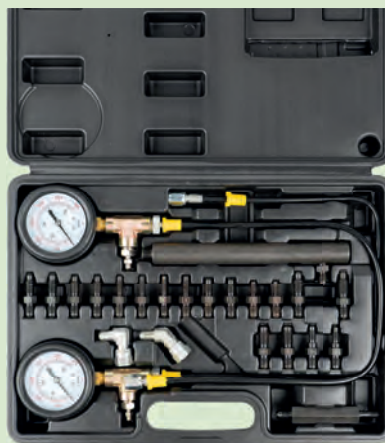

ENTHALTEN

- x1 Teves Adapter
- x1 45°Schwenkverschraubung
- x1 90°Schwenkverschraubung
- x2 7/16-24 Gerade Verschraubung
- x2 1/4-28 Gerade Verschraubung
- x2 3/8-24 Gerade Verschraubung
- x2 5/16-24 Gerade Verschraubung
- x2 M10-1.5 Gerade Verschraubung
- x2 M8-1.25 Gerade Verschraubung
- x2 M10-1.0 Entlüftungsadapter
- x2 7/16-20 Gerade Verschraubung
- x2 M7-1.0 Gerade Verschraubung

52625

9,00€

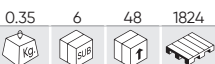

SPEZIALZANGE - TROMMELBREMSE



- Für De- und Montage von Bremsrückzugfedern.

52315

16,00€

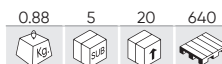

KOLBEN-RÜCKSTELLER



- Maximale Öffnung: 80mm.

51839

24,00€

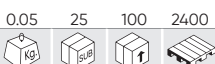

BREMSEFLÜSSIGKEIT-TESTER

- Arbeitet von 1 x AAA und Batterien LR03.
- 4 Niveaus der Qualitätsmessung 0-4%.



52455

16,00€

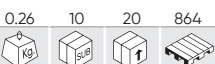

BREMSBELAG FÜHLERLEHREN

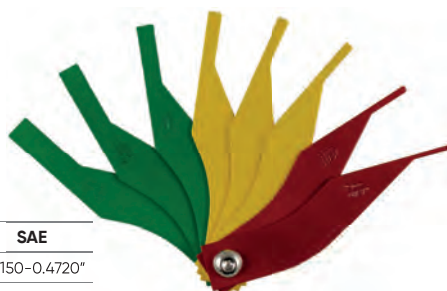

FARBE	METRISCH	SAE
Grün	8-10-12mm	0.3150-0.4720"
Gelb	4-5-6mm	0.1575-0.2382"
Rot	2-3mm	0.0787-0.1181"

52275

38,00€



DRUCKLUFT BREMS-ENTLÜFTUNGSGERÄT



- Arbeitstemperatur: 10°C - 50°C.
- Silikonschlauch: 2m.
- Ausblaspistole am Eingang 1/4".
- Arbeitsdruck: 6-12 bar (87 - 174 PSI).
- Luftverbrauch: 180 l/min.

SPEZIALWERKZEUG

- 200 SCHMIERSYSTEM
- 206 EINSPRITZSYSTEM
- 213 BLOCK/KULAT
- 216 KUPPLUNG
- 217 KÜHLSYSTEM
- 219 KLIMASYSTEM
- 221 GETRIEBE
- 223 FEDERUNG
- 229 ABGASLEITUNG
- 231 ELEKTRISCHE ANLAGE
- 235 SCHRAUBENREPARATUR
- 238 MOTORRAD
- 238 ABZIEHUNGEN



54068

120,00€

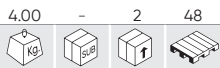

SCHLÜSSELSATZ ALUMINIUMÖLFILTER, 19 ST.

REF. NR.	BESCHREIBUNG	KANTEN x Ø				€
15494	05101 Mazda, Mitsubishi	15 x 100,5mm	0.18	-	50	12,50€
15495	0595 Nissan, Toyota	15 x 94,5mm	0.18	-	50	12,50€
15496	0592 Nissan, Subaru	15 x 92mm	0.18	-	50	11,50€
15497	0579 Toyota, Honda, Mitsubishi, Subaru, Mazda, Lsuzu	15 x 79mm	0.14	-	50	11,00€
15498	915 Volvo	16 x 87mm	0.24	-	50	11,50€
15499	901L Lexus	14 x 79,5mm	0.15	-	50	11,00€
15500	901T Toyota	14 x 70mm	0.13	-	50	10,00€
15501	901-1 Toyota	14 x 63-64mm	0.10	-	50	10,00€
15502	902 Ford, Mazda	14 x 66,5mm	0.89	-	50	10,00€
15503	1284 Dodge Sprinter (2007-), Mercedes Benz E320 (2007-), Jeep Cherokee 3.0L V6 Common Rail (2007-)	14 x 84mm	0.13	-	50	11,00€
15504	903B Mercedes Benz	14 x 74mm	0.13	-	50	10,00€
15505	24mm BMW 5, BMW 7, BMW X5 V8 (N62) (2004-), Saturn (2008), Astra 1.8L ECOTEC, Chrysler 3.6L V6 (2011-), 200, 300, T/C Dodge Jeep	6 x 24mm	0.47	-	50	4,00€
15506	27mm Mercedes Benz Classe A	6 x 27mm	0.45	-	50	4,00€
15507	30mm Audi A2, Vw Polo, Lupo 1.4L/1.6L	6 x 30mm	0.44	-	10	4,50€
15508	32,5mm Opel Astra G, Corsa B, Zafira, Audi, VW 1-36 mm, Opel Omega, Vectra B, Zafira (98-), BMW M43/60	6 x 32,5mm	0.45	-	50	4,50€
15509	36mm Opel Omega, Vectra B, Zafira (98-), BMW M43/60, Mercedes Benz Vito CDI, C, E, VW Lupo 1.2 TDI, MAN	6 x 36mm	0.48	-	50	5,00€
15510	38mm Opel Vectra 2.0D	6 x 38mm	0.50	-	50	5,00€
15511	917 Universal	55-90mm	0.22	-	50	8,00€



51332

98,00€



STECKSCHLÜSSEL-SET FÜR ÖLFILTER - 23 TEILE

REF. NR.	BESCHREIBUNG	KANTEN x Ø				€
11374	901 Toyota, Nissan, Fiat Daihatsu	14 x 65mm	0.05	5	20	5,50€
11375	902 Toyota, Daihatsu	14 x 67mm	0.45	5	20	6,50€
11376	903 VW, Mercedes, BMW, Opel, Audi	14 x 74mm	0.20	5	20	5,50€
11377	903-1 GM/AC, Wix, Ford, Isuzu	15 x 75mm	0.09	5	20	5,50€
11378	903-2 VW, Audi, Seat, BMW, Renault	8 x 74mm	0.09	5	20	6,50€
11379	903-3 Audi, Rover, Chrysler	15 x 74mm	0.11	5	20	6,00€
11380	903-4 Toyota, Lexus	14 x 73mm	0.11	5	20	6,50€
11381	903-6 Schlepper, Baumashinen	12 x 75mm	0.10	-	20	6,50€
11382	918 Rover, Chrysler, Audi	15 x 74mm	0.11	5	20	6,00€
11383	904 Nissan, Ford	15 x 79mm	0.50	5	20	6,00€
11384	905 GM, Chrysler	15 x 73mm	0.12	5	20	6,00€
11385	905-1 BMW, Mercedes, Opel, Audi, VW	14 x 74mm	0.10	5	20	5,50€
11386	906 Baumaschinen, Schlepper	18 x 84mm	0.10	5	20	6,00€
11387	907 Mitsubishi, Toyota	15 x 89mm	0.13	5	20	6,00€
11388	908 Nissan, Toyota	15 x 91mm	0.14	5	20	6,00€
11389	915 Honda Accord, Mitsubishi, Isuzu	15 x 90mm	0.16	5	20	6,00€
11390	910 Toyota, Alfa Romeo, Ford	15 x 95mm	0.12	5	20	6,00€
11391	911 Fiat, Renault, Citroën	12 x 76mm	0.09	5	20	6,50€
11392	911-1 Subaru, Toyota, Honda, Nissan	15 x 80mm	0.09	5	20	6,00€
11393	914 Mazda, Toyota	15 x 101mm	0.18	5	20	6,00€
11394	909 Isuzu, Nissan	15 x 92mm	0.14	5	20	6,00€



REF.	BESCHREIBUNG				€
14992	12-KANTSCHLÜSSEL FÜR REF. NR. 51332/NR. 14141	0.14	-	100	8,50€
10955	1/2 * KLINKE FÜR FILTERAUSZIEHER 51332	0.14	-	50	11,00€

ÖLFILTER SCHLÜSSEL

REF.	KANTEN x Ø	BESCHREIBUNG						€
52311	42mm	GRUPO VAG	0.13	6	72	1728		19,00€
52312	14 x 74mm	VW, OPEL, MERCEDES, BMW, AUDI	0.10	10	100	1000		9,00€
52313	16 x 86mm	VOLVO 540, 560, 570, 580	0.20	6	68	1008		8,00€
52314	16 x 87mm	BMW, VOLVO	0.20	5	50	600		26,60€
52809	14 x 64,5mm	TOYOTA	0.15	10	100	1000		8,50€
53441	14 x 76mm	-	0.20	5	20	800		9,80€



53008

15,50€

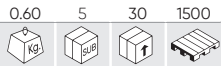

ÖLFILTER ABZIEHER FÜR FORD, CITROËN, PEUGEOT 2.0, 2.2 HDI, TDCI



52518

115,00€

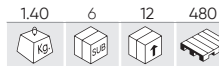

DREIBACKEN-FILTERSCHLÜSSEL LKWS 95-165MM



52615

112,00€



ÖLFILTER STECKSCHLÜSSEL SET - 9 TEILE

9 PCS

- Verstellbarer Doppelmaul Schlüssel.
- Anwendungsgebiet: 60-80 mm.

1/2"	x1	Universal	63 - 83mm
		Mercedes Benz, Smart	27mm
	x3	GM, Opel, Vauxhall, Mercedes Benz	32mm
		Mercedes Diesel, BMW, Mini, Ford	36mm
		Toyota (Allion, Auris, Corolla, Prius, Voxy, etc.)	64,5mm
3/8"	x3	Toyota, Lexus (6 Zyl.).	64,5mm
		Audi, BMW, Ford, Toyota, Volkswagen, Porsche, Mercedes-Benz	74,2mm
	x1	Hunday, Kia.	88,8mm
	x1	BMW 3+5+X, Volvo	86,6mm



DREIBACKEN-ÖLFILTERSCHLÜSSEL, FLACH/RUND

51352

9,80€



1/2" - 3/8"
57-118mm
Ø2-1/4" ~ 5"

51353

11,50€



1/2" - 3/8"
72-136mm
Ø2-1/2" ~ 4"

51923

12,50€



1/2" - 3/8"
72-136mm
Ø2-1/2" ~ 4"

51934

11,50€

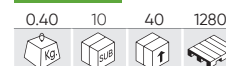

1/2" - 3/8"
57-118mm
Ø2-1/2" ~ 4"

53206

38,20€

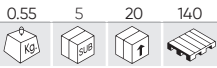

5
PCS

ÖLMESSTAB SET FÜR BENZ/AUDI - 5 TEILE

- Zur Überprüfung des Getriebeöls der Audi 100 Motoren:
- Die Spitze (die ersten 11 mm) ist eine Kaltflüssigkeits Anzeige von 20 ° C.
- Der zweite Wert ist ein Minimum von 80 ° C.
- Der dritte Wert ist ein Maximum von 80 ° C.
- Kontrollieren Sie den Füllstand, während Sie das Öl für Automatikgetriebe prüfen.
- Der Motorölmesstab ist kompatibel mit Mercedes-Modellen von 1988-2005.

	Mercedes-Benz	920mm	- Übertragungscode: 716.5,722.7,722.8.
	Mercedes-Benz	930mm	- Herstellungsjahr: 1988-1997. - Motorkennbuchstaben: 103,104,111,119,120,137,604,605,606,611,612,613,628,642,647,648.
	Mercedes-Benz	930mm	- Herstellungsjahr: 1996-2005. - Motorkennbuchstaben: 103,104,111,112,113,119,120,137,271,272,604,605,606,611,612,613,628,642,646,647,648.
	Mercedes-Benz	1200mm	- Übertragungscode: 722.6.
	Audi	1160mm	- AUDI 100 Motoren.



REF.	BESCHREIBUNG					€
13856	ÖL-STAB MOTOR UND GETRIEBE VON AUDI	0.04	5	100	-	7,80€

51354

13,20€

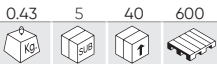

ÖLFILTERZANGE

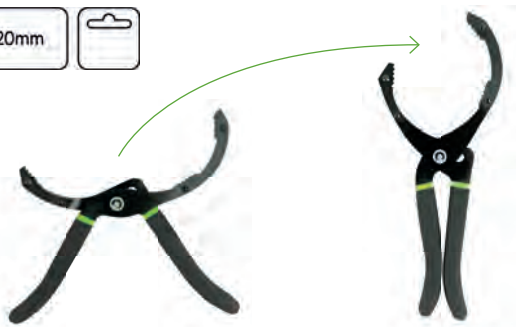

53670

29,50€

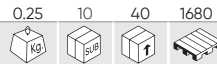

ÖLFILTERSCHLÜSSEL FÜR VAG DSG 1/2" 24 MM



- Spezialwerkzeug für die Montage und Demontage des Ölfilters von DSG-Getrieben.
- Durch seine reduzierte Größe kann der Ölfilter des DSG-Getriebes leicht erreicht werden, ohne dass eine Batterie entfernt werden muss.



52269

7,00€

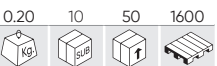

ÖLFILTER-BANDSCHLÜSSEL

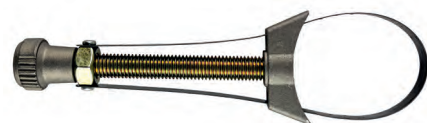

AUSTAUSCHBARES BAND

REF.	mm				€
11106	360mm	0.02	10	50	3,00€

52677

17,00€



ÖLFILTER-BANDSCHLÜSSEL, VERSTELLBAR - Ø65-105MM



AUSTAUSCHBARES BAND

REF.	mm				€
11936	383mm	0.15	5	300	4,00€

52678

18,00€

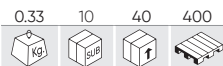

ÖLFILTER-BANDSCHLÜSSEL, VERSTELLBAR - Ø110-155MM

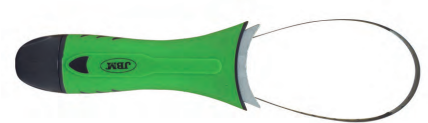

AUSTAUSCHBARES BAND

REF.	mm				€
11937	540mm	0.04	10	100	5,00€

ÖLFILTER-BANDSCHLÜSSEL

<p>52417 28,00€</p> <p>0.90 5 25 800</p> <p></p> <p>Ø160-300mm</p> <p>HOCHFESTE KETTE</p>	<p>52416 14,00€</p> <p>0.37 5 50 900</p> <p></p> <p>Ø150-540mm</p> <p>POLYMERSTREIFEN (HOCHFEST)</p>	<p>52607 49,00€</p> <p>0.85 6 24 576</p> <p></p> <p>Ø60-140mm</p> <p>GELENK-DOPPELKETTE</p>	<p>52608 44,00€</p> <p>0.95 6 24 480</p> <p></p> <p>Ø60-195mm</p> <p>GELENK-DOPPELKETTE</p>
--	---	--	--

53735 44,00€

1.70 - 5 375

STECKSCHLÜSSEL-SET FÜR ÖLABLASSSCHRAUBEN - 23 TEILE

ENTHALTEN

	x2	5/16", 3/8"	
	x7	7, 8, 10, 11, 12, 13, 14mm	
	x1	10mm	
	x1	10mm	
	x7	8, 9, 10, 12, 13, 14, 17mm	
	x1	T45	
	x1	M16	
	x1	200mm	
	x2	75, 150mm	

23 PCS 3/8"

15084 68,00€

1.86 - 5 -

240mm 135mm 32mm

EVA-MODUL NUSS-SET FÜR ÖLABLASSSCHRAUBEN

ENTHALTEN

	x2	5/16", 3/8"	
	x7	7, 8, 10, 11, 12, 13, 14mm	
	x1	10mm	
	x1	10mm	
	x7	8, 9, 10, 12, 13, 14, 17mm	
	x1	T45	
	x1	M16	
	x1	200mm	
	x1	150mm	

GEEIGNET AUCH FÜR ÖLSAMMLER REF. 53873 UND 53874.

REPARATUR-SET FÜR ÖLABLASSSCHRAUBEN-GEWINDE

<p>53235 10,40€</p> <p>0.25 10 40 -</p> <p></p> <p>M13</p>	<p>53236 11,50€</p> <p>0.35 10 40 -</p> <p></p> <p>M15</p>	<p>53237 12,90€</p> <p>0.35 10 40 -</p> <p></p> <p>M17</p>	<p>53238 18,40€</p> <p>0.40 10 40 -</p> <p></p> <p>M20</p>
---	---	---	---

ÖLABLASSSCHRAUBEN AUS KUNSTSTOFF 5 -TEILE

5
PCS

REF.	BESCHREIBUNG					€
13969	VAG	0.02	10	100	-	19,00€
53537	BMW	0.05	10	100	4000	14,50€
53538	Ford	0.10	10	100	4000	14,50€
53741	Ford / PSA	0.05	10	100	4000	14,00€



53472 12,00€

0.10	10	100	1200
------	----	-----	------

SCHLÜSSEL FÜR ÖLABLASSSCHRAUBEN AUS KUNSTSTOFF (VAG)



52617 7,00€

0.23	6	36	1620
------	---	----	------

SCHLÜSSEL FÜR ÖLABLASSSCHRAUBEN

- Für Citroën, Renault, Peugeot.



53473 36,00€

0.40	10	50	800
------	----	----	-----

ABZIEHWERKZEUG-SET FÜR KUNSTSTOFF ÖLABLASSSCHRAUBEN

5
PCS



A	x1	3/8"	80x100mm	Ford	OEM 1830727
B	x1	1/4"	1,5mm	VAG	OEM 06L 103 801
C	x1	1/4"	10mm	BMW	OEM 11137605018
D	x1	3/8"	3mm	Peugeot/Citroën	OEM 9801444780/OEM18711598
E	x1	1/4"	- 3/8"		

52754 54,00€

1.25	-	5	160
------	---	---	-----

ÖLDRUCK PRÜFUNG SET

0-10 BAR 0-140 PSI

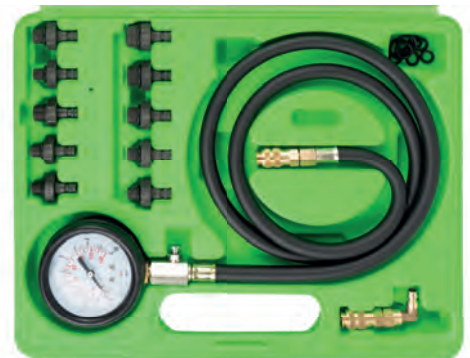

x1	M10x1.0mm	x1	1/8" DIN 2999
x1	M12x1.5mm	x1	1/8" x 27 NPT
x1	M14x1.5mm	x1	1/4" x 18 NPT
x1	M16x1.5mm	x1	3/8" x 20 UNF
x1	M18x1.5mm	x1	1/2" x 20 UNF

51337 50,00€

1.55	-	10	180
------	---	----	-----

ÖLABLASSSCHRAUBEN REPARATUR-SET

24
PCS

- SKS3 Schrauben.
- 1015 Bits.
- Kupferscheiben.

LIEFERUMFANG

- M13x1,5P
- M15x1,5P
- M17x1,5P
- M20x1,5P
- Bits:
- 1 x Messschraube
- 5 x Messschieber
- 10 x Meß...

ERSATZTEILVERFÜGBARKEIT

REF.	BESCHREIBUNG				€
A 51400	M15 x 1.5P	0.15	50	100	17,00€
B 51401	M17 x 1.5P	0.14	50	100	22,00€
C 51402	M20 x 1.5P	0.10	25	50	20,50€
D 51403	M13 x 1.5P	0.15	50	100	17,50€
E 14930	M13 x 1.5P	0.05	10	100	9,50€
F 14931	M15 x 1.5P	0.05	50	100	8,00€
G 14932	M17 x 1.5P	0.07	5	100	9,50€
H 14933	M20 x 1.5P	0.10	5	100	9,50€

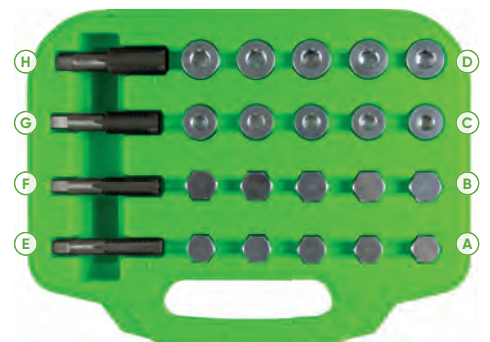

53485

140,00€

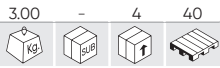

ÖLKANISTER MIT TÜLLER UND KFZ-MARKEN ADAPTERN



- A Gewindeadapter M42 x 4,5 für Subaru
- B Gewindeadapter M37 x 3,0 (kurzer Typ) für Lotus, Pontiac, Scion, Toyota
- C Gewindeadapter M35 x 4,0 für Ford, Jaguar, Land Rover, Mazda
- D Gewindeadapter M32 x 3,5 für Acura, Dodge, Ford, Honda, Jaguar, Jeep, Land Rover, Mazda, Nissan
- E Bajonett-Adapter für Toyota und Lexus 3,0 und 3,3 I V6
- F Bajonett-Adapter für Audi, BMW, Mercedes-Benz, Porsche, Volvo, VW
- G Gewindeadapter M30 x 3,0 für Dodge Cummins
- H Gewindeadapter (1/2 Umdrehung) für Mazda 3/6/ CX-5
- I Gewindeadapter (1/2 Umdrehung) für Cadillac, Chevy, Ford, GMC, Hyundai, Jaguar, Land Rover, Mazda, Saab, Mercury
- J Gewindeadapter (1/4 Umdrehung) für neue Öleinfülldeckel ab 2008 bei Audi, Seat, Skoda, VW mit EA888 Motor
- K Gewindeadapter (1/2 Umdrehung) für Dodge Hemi 6,4 I (2011-) und > 3,6 I (>2014)
- L Gewindeadapter M37 x 3,0 (lange Ausführung) für Lotus, Pontiac, Scion, Toyota

53347

100,00€

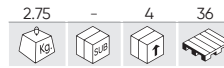

ÖLKANISTER MIT TÜLLER UND KFZ-MARKEN ADAPTERN



- A Gewindeadapter M42 x 4,5 für Subaru
- B Gewindeadapter M37 x 3,0 (kurzer Typ) für Lotus, Pontiac, Scion, Toyota
- C Gewindeadapter M35 x 4,0 für Ford, Jaguar, Land Rover, Mazda
- D Gewindeadapter M32 x 3,5 für Acura, Dodge, Ford, Honda, Jaguar, Jeep, Land Rover, Mazda, Nissan
- E Bajonett-Adapter für Toyota und Lexus 3,0 und 3,3 I V6
- F Bajonett-Adapter für Audi, BMW, Dodge, Mercedes-Benz, Porsche, Volvo, VW

52305

106,00€



AUSBAU UND REPARATUR VON GLÜHKERZEN SET - 16 TEILE

16 PCS



- Der Satz ist besonders nützlich für den Ausbau von gebrochenen oder verschmutzten Glühkerzen.
- Die Flexibilität ermöglicht die Anwendung für Motoren Mercedes Benz CDI.
- Werkzeuge ermöglichen die Entfernung von gebrochenen oder verschmutzten Kerzen mit Gewinde M8, M10.
- Der Satz enthält den Gewindebohrer und 1/4" M8, sowie einen hoch-festen Bit M8 und M10.

51494

107,00€



INJEKTOR-ABZIEHER SET

9 PCS S



	M12 x 1.75	M8 x 1.5		M14 x 1.5	M8 x 1.5
	M14 x 1.5	M17 x 1.5		M14 x 1.5	
	M14 x 1.5	M27 x 1.0		HRC: Hardness 30 -35	
	M14 x 1.5	M12 x 1.75		1.75Kg.	
	M14 x 1.5	M8 x 1.5			

54186

250,00€

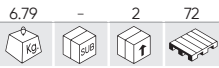

PNEUMATISCHER ABZIEHER FÜR INJEKTOREN

6-8 BAR

S

20-30 Nm

BOSCH, DELPHI, DENSO, SIEMENS

REF.	BESCHREIBUNG	kg	Sub	Ein	€
16366	M20X1,0 10MM	0.13	-	30	11,00€
16367	M10X1,5 14MM	0.08	-	30	10,00€
16368	M14X1,5 15MM	0.10	-	30	12,00€
16369	M14X1,5 33MM	0.12	-	30	12,00€
16370	M16X1,5 18MM	0.10	-	-	12,00€
16371	M17X1,0 10MM	0.11	-	30	11,00€
16372	M18X0,75 10MM	0.10	-	30	11,50€
16373	M18X1,5 18MM	0.10	-	30	12,00€
16374	M22X1,5 15MM	0.10	-	30	12,00€
16375	M25X0,5 9MM	0.10	-	30	15,00€
16376	M25X1,0 13MM	0.10	-	30	15,00€
16377	M26X0,75 15MM	0.10	-	30	16,00€
16378	M27X0,75 10MM	0.10	-	30	15,00€
16379	M29X1,0 11MM	0.10	-	30	15,00€
16380	M31X0,75 15MM	0.12	-	30	16,00€

REF.	BESCHREIBUNG	kg	Sub	Ein	€
16381	M8X1,0 14MM	0.09	-	30	10,00€
16382	M8X1,25 14MM	0.01	-	30	10,00€
16383	M14X1,5 9MM	0.13	-	30	15,00€
16384	M14X1,5 9MM	0.11	-	30	15,00€

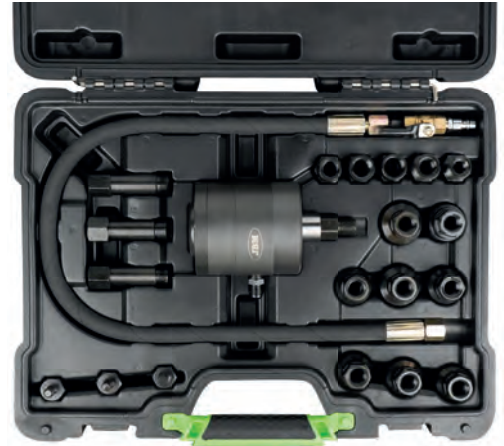

54345

15,00€



N

VEREISUNGSSPRAY

-42° 400ml

UFI: MD82-13A7 G004-V27H

Geeignet für Metalloberflächen. Es erleichtert das Zusammenziehen des Stahls, wodurch er leichter extrahiert werden kann.



16295

30,00€



N

SATZ MIT 3 ADAPTERN FÜR PNEUMATISCHEN INJEKTORABZIEHER (REF.54186)



52858

298,00€

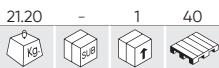

INJEKTOR-ABZIEHER SET

Hammern	1,6Kg (160mm)
	2,7Kg (460mm)
	5,1Kg (600mm)
Füße mit gabelmaul	13,7x18mm (105mm)
	12,7x19mm (130mm)
Schlitz einsätze (6pt)	1/2" - 25, 27, 28, 29, 30mm (100mm)
Abnehmbarer adapter mit außengewinde	M27x1.0
Abnehmbarer adapter mit innengewinde	M25x1.0
	M27x1.0
Injektor-abziehvorrichtung mit spindel	M17x1.0mm
	⊕ ∅ 35mm
	⊖ ∅ 29mm
Schlaghammer-adapter für innen-, außen- und klauenauszieher	



51493

68,00€

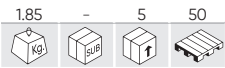

SET FÜR DIE ANALYSE UND MESSUNG DER EINSPRITZEINHEIT

31 PCS BOSCH, SIEMENS, DENSO, DELPHI

Der Satz ist für schnelle und effiziente Prüfung des Kraftstoffverbrauches von jeder Einspritzdüse bestimmt, indem die Funktionstüchtigkeit geprüft wird. Geeignet für Einspritzdüsen von Bosch, Siemens, Denso und Delphi.

- LIEFERUMFANG**
- Aufhängung für 6 graduierte Messflaschen
 - 6 Messröhre (für einen Riss)
 - Weiße Kontrollröhre
 - Case



REF. BESCHREIBUNG 12901 FLASCHE + DECKEL + SCHLAUCH FÜR REF. 514930.03 10 60 - 5,20€

54391

221,00€

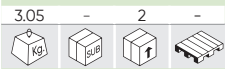

DIESEL-EINSPRITZDÜSENPRÜFGERÄT

0-60 MPA 5-8 BAR 0-600 BAR 0-8700 PSI M12 M14

Mit diesem Werkzeug können Sie den Zustand der Einspritzdüsen überprüfen, während Sie Druck auf sie ausüben. Es ist speziell für die Überprüfung des Zerstäubungsmusters und des Öffnungsdrucks der Einspritzdüsen geeignet.

- x1 M12
- x2 M14



54392

1.855,00€

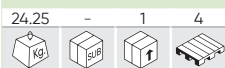

510mm 545mm 480mm

GDI / EFI EINSPRITZDÜSENREINIGER UND -TESTER

220V 60W 50-60 Hz
 0,1-10 BAR 5-8 BAR
 <85% -10°C 40°C

Mit dieser Maschine können Sie GDI- und EFI-Einspritzdüsen reinigen und auf ihre korrekte Funktion überprüfen. Dank ihres Mikrocontrollers kann das Gerät reale Betriebsbedingungen des Motors simulieren, so dass das Verhalten der einzelnen Einspritzdüsen beobachtet und mögliche Fehler erkannt werden können.

Für die Reinigung der Einspritzdüsen wird eine Ultraschallreinigung verwendet, die die vollständige Beseitigung von Rückständen in Benzin- und Dieseleinspritzdüsen garantiert. Bei EFI-Systemen umfasst sie auch einen Reinigungsmodus im Fahrzeug.

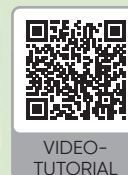

VIDEO-TUTORIAL

54220

197,00€

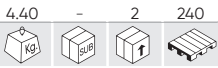

DEMONTAGE- UND INSTALLATIONSWERKZEUG FÜR BMW MERCEDES BENZ EINSPRITZDÜSEN

MODELLE	<p>BMW: 135iS (2008-), 335 (2007-), 335xi (2007-), 535i (2008-), 535xi (2008-), 550i GT (2010-), 750Li (2009-), 750i (2009-), X3 3.0i (2007-), X5 (2011-), X5 3.0i (2008-), X6 (2008-)</p> <p>MERCEDES-BENZ: C-CLASS (2007-), CLK / SLK (2007-), E-CLASS (2007-), A / CLA / GLA 45 AMG (2013-), CL / CLS 63 AMG (2010-), E / G / GL 63 AMG (2011-), GLE 63 AMG (2015-), S / SL 63 AMG (2010-), SLK 55 AMG (2012-)</p>
OEM WERKZEUG	<p>BMW: 130180(1), 130195(2), 130270(3), 130320(4), 2249115(5)</p> <p>MERCEDES-BENZ: 271589023300(6), 278589003300(7)</p>
MOTORCODES	<p>BMW: N14 / N18 / N20 / N47 / N54 / N57 / N55 / N63</p> <p>MERCEDES-BENZ: M133 / M152 / M157 / M270 / M271 / M274 / M276 / M278</p>

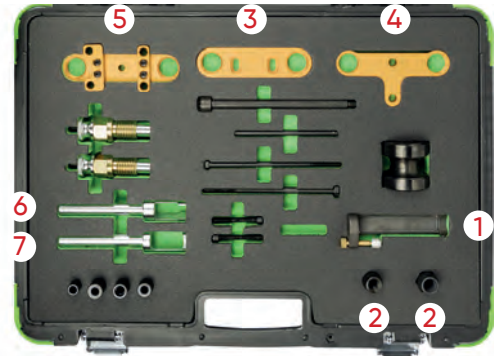

52815

110,00€

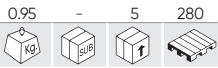

GLÜHKERZEN-ELEKTRODENSPIZTE AUSBAU SET

22 PCS



53250

85,00€



SATZ INNEN- UND AUSSENLAGERABZIEHER

5 PCS



53069

98,00€

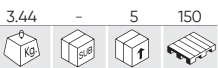







DIESEL-INJEKTOR ABZIEHER SET FÜR CITROËN, PEUGEOT

9 PCS

CITROËN, PEUGEOT



-  x1
-  x3
-  x2 Ø 17mm
-  x2 Ø 25mm
-  x2 25mm
-  x1 29mm
-  x1 21mm

52629

99,00€

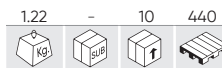

INJEKTOR-ABZIEHER SET MERCEDES

3 PCS

MERCEDES



M16x1.5

52639 123,00€

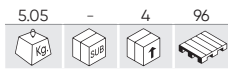

**SPURSTANGENGELLENK ABZIEHER-
WERKZEUG SET**



- Ø 30-35mm
- Ø 35-40mm
- Ø 40-45mm

53464 153,00€

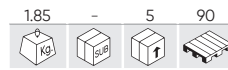

**INJECTOR-KUPFERRINGE,
ZUSAMMENSTELLUNG 551 STK**



**551
PCS**

**FÜR WEITERE
INFORMATIONEN**

SEITE 387

53501 24,00€

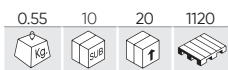

**DIESEL-EINSPRITZPUMPEN
ABZIEHER FÜR BMW**



OEM 1 13 5 191 | 13 5 192 | 13 5 190 BMW.
BWM: M47 / M47T2 / M47TU / M57 / M57TU.
SERIES: E46 (318D-320D) (1988 - 2005) and E60,
E61 (318TD-320TD-525D-530D-530-535) (2000 -
2006).

53009 42,00€

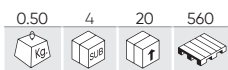

**DIESEL-
EINSPRITZLEITUNGS
ABZIEHER**



**3
PCS** **1/2"**
14, 17, 19mm

53522 24,00€

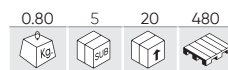

**ABZIEHER FÜR
EINSPRITZDÜSENSCHEIBEN**



350mm **Ø 4,5-15mm**

53696 22,00€



SCHELLENLÖSER HENN



VOLKSWAGEN, AUDI, SEAT,
ŠKODA, BMW, PEUGEOT, CITROËN,
DACIA, FIAT, FORD, KIA, LEXUS,
MAZDA, MERCEDES, NISSAN,
OPEL/VAUXHALL, PORSCHE,
RENAULT, TOYOTA, VOLVO.

52757 16,00€

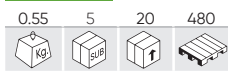

TANKGEBER ABZIEHER, UNIVERSAL



53490 275,00€

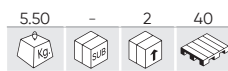

**DIESEL UND BENZIN
KOMPRESSIÖNSPRÜFUNGS-SET**

- M24
- M20
- M24
- M20
- Ø 10, 12, 14, 18mm



53096 28,80€



TANKGEBER SCHLÜSSEL

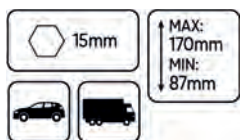

ALFA ROMEO, BMW,
CHRYSLER, CITROËN,
DAEWOO, FIAT, FORD,
HONDA, HYUNDAI, ISUZU,
JEEP, KIA, LADA, LANCIA,
LAND ROVER, LDV,
MAZDA, MERCEDES,
MG, MITSUBISHI,
NISSAN, PEUGEOT,
RENAULT, ROVER,
SAAB, SSANGYONG,
SUZUKI, TOYOTA, VAG,
VAUXHALL/OPEL,
VOLVO

54373

395,00€

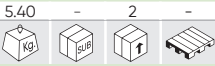

COMMON-RAIL-HOCHDRUCKMANOMETER



x2	M12x1,25	x6	M12x1,50
x2	M14x1,25	x6	M14x1,50

Ein unverzichtbares Werkzeug zur Messung des hohen Drucks, der durch den Kompressionshub im Luftzylinder eines Dieselmotors erzeugt wird. Es verfügt über eine Vielzahl von Adaptern für unterschiedliche Spezifikationen und Anschlüsse, mit denen verschiedene Typen von Dieselmotoren gemessen werden können.



N

54312

191,50€



DIESEL KOMPRESSIONS-MESSGERÄT SET



INNENDURCHMESSER
10, 12, 14, 18mm
INNENDURCHMESSER
M20, M22, M24

ALFA, BMW, FIAT, FORD, LDV, PSA, RENAULT, SUZUKI, SAAB, CHRYSLER, DAEWOO, HYUNDAI, MERCEDES, MITSUBISHI, NISSAN, LANDROVER, MAZDA, ISUZU, OPEL.



N

52599

230,00€

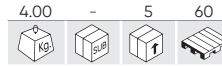

KRAFTSTOFFDRUCKTESTER

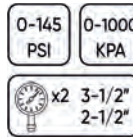

52489

58,00€

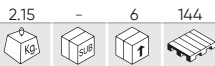

DIESEL KOMPRESSIONSPRÜFUNGS-SET

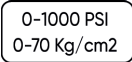

M18x1.5mm
M24x1.5mm
M24x2.0mm
M10x1.0x68mm
M10x1.25x45mm
M10x1.25x54mm
M10x1.25x68mm

FORD, BMW, MERCEDES BENZ, VW, CITROËN, MITSUBISHI, TOYOTA, PEUGEOT, RENAULT, VOLVO, MAZDA.

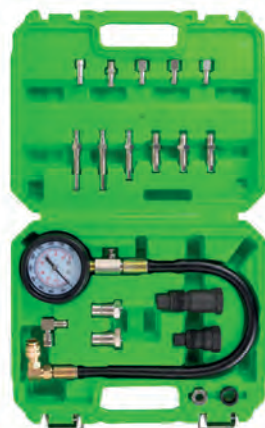

52685

88,00€

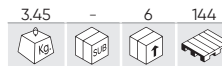

DIESEL DRUCKPRÜFUNGS-SET FÜR LKW



M18
M24

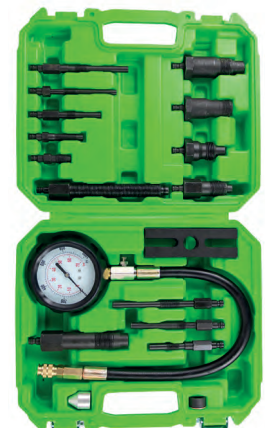

53997

48,00€

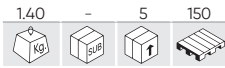

SATZ FÜR DRUCKPRÜFUNG DER EINSPRITZUNG DES BENZINKRAFTSTOFFS

0-10 BAR 0-140 BAR

LÄNGE	25,5cm (1), 29,5cm (2), 110cm (3)
AUSSENDURCHMESSER	1,2cm (1), 1,2cm (2)
INNENDURCHMESSER	0,6cm (1), 0,6cm (2)



54016

76,00€

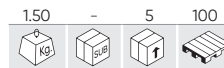

VAKUUMFÖRDERPUMPE

MAXIMALER DRUCK

40 PSI (3 BAR)

MINIMALER DRUCK

-20 PSI (-0,75 BAR)



52488

28,00€

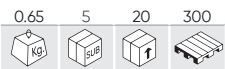

BENZIN KOMPRESSIONSPRÜFUNGS-SET

0-300 BAR
0-21 Kg/cm2



53489

68,00€

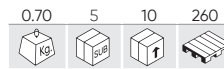

TURBO-DRUCK PRÜFER

-1~3 BAR 2m



52076

111,00€

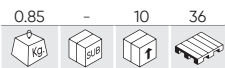

ZÜNDKERZEN-REPARATUR SET

- 1 Werkzeuge für Gewindebohrer * 2 St.
- 2 Griff für 8- 1 St.
- 3 Gewindeschneider M8 x 1.0- 5 St.
- 4 Gewindeschneider M10 x 1.0-5 St.
- 5 Gewindeschneider M10 x 1.25- 5 St.
- 6 Gewindeschneider M12 x 1.25-5 St.
- 7 Applikationsköpfe * 3 St.
- 8 Stab für Gewindeschneider * 1 St.
- A Gewindebohrer M14 x 1.25 (für Gewinde M12 x 1.25) * 1 St.
- B Gewindebohrer M12 x 1.25 * 1 St.
- C Gewindebohrer M12 x 1.0 (für Gewinde M10 x 1.25) * 1 St.
- D Gewindebohrer M10 x 1.25 * 1 St.
- E Gewindebohrer M10 x 1.0 (für Gewinde M8 x 1.0) * 1 St.
- F Gewindebohrer M8 x 1.0 * 1 St.



REF.	Icon	€
11893	M8x1.0 0.01 5	7,00€
11894	M10x1.0 0.01 5	7,00€
11895	M10x1.25 0.02 5	8,65€
11896	M12x1.25 0.02 5	8,80€

SPEZIALWERKZEUG

52813

79,00€

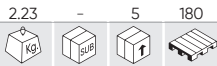

INJEKTOREN-DICHTFLÄCHEN-FRÄSER SET - 17 TEILE

17 PCS



x8	14x14, 15x19, 15.5x15.5, 17x17x, 17x17.5, 17x19, 17x19.5, 17x20mm	x1	19x225mm
x4	15.5x15.5, 17x17, 17.5x20.5, 17x21mm	x1	19x170mm
x1	19x21.5mm	x1	19mm
		x1	2.5mm

52273

44,00€

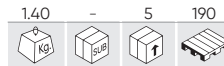

INJEKTOREN-DICHTFLÄCHEN-FRÄSER SET - 8 TEILE

8 PCS



x3	15x19mm, 17x17mm BMW, PSA, Renault, Ford, 17x19mm Mercedes CRD	x1	12mm
x2	17x17mm Mercedes, 17x21mm Fiat/Iveco	x1	19mm
		x1	

53650

47,00€

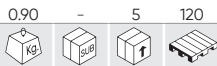

INJEKTORBODEN REINIGUNGS-SET

19 PCS

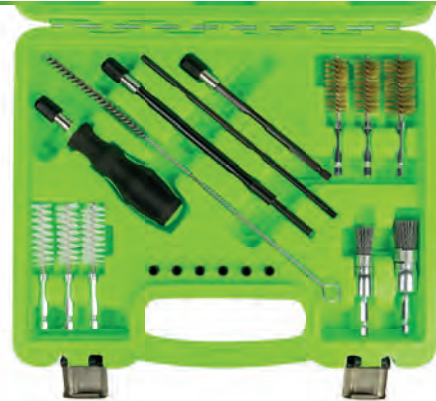

REF.	BESCHREIBUNG					€
14348	MESSING-REINIGUNGSBÜRSTEN SET (IN SET REF. 53650) - 3 TEILE	0.05	-	50	-	12,50€
14349	SILIKON-REINIGUNGSBÜRSTEN SET (IN SET REF.53650) - 2 TEILE	0.07	-	100	-	20,50€

53330

38,00€



STECKSCHLÜSSEL-SET FÜR EINSPRITZPUMPE - 5 TEILE

5 PCS **1/2"** **1/4"** **Cr-V**



52801

26,00€



HAND-UMFÜLLPUMPE FÜR KRAFTSTOFFLEITUNG



17mm

52821

28,80€



DOPPEL-RINGSCHLÜSSEL OFFEN, FÜR DIESEL-INJEKTOREN



17mm

STAHLSTEMPEL SET

Ermöglichen eine numerische oder Buchstabenmarkierung auf jede Metalloberfläche durch Drücken oder Aufprall. Der abgerundete Arbeitsbereich verhindert Risse oder Knicke auf der zu bearbeitenden Oberfläche.

52422 24,70€

0.82 3 6 540

A-Z & 0-9

36 PCS 3/16"

5mm



53119 52,00€

1.94 3 6 504

A-Z & 0-9

36 PCS 5/16"

8mm



52882 14,00€

0.30 10 60 1500

9 PCS 1/4"

6mm 0-8



51120 41,00€

2.10 - 5 120

UNIVERSAL VENTILFEDER SPANNER

- Geeignet für Fahrzeuge und Motorräder.
- 5 Adapter ermöglichen es, richtig und ohne besondere Anstrengungen die Ventilsfeder zusammenzudrücken.

LIEFERUMFANG
Kompressor.
Adapter: 30, 25, 23, 19, 16mm.



52734 51,00€

2.61 - 5 175

VENTILFEDER SPANNER 45-145 MM



Ø 30mm Ø 25mm
45-145mm

52693 24,50€

0.65 5 20 450

KOMPRESSOR FÜR VENTILE



53251 88,00€

2.80 - 4 60

KOLBENRINGE WERKZEUG-SET

H:3" Ø 53-125mm
H:4" Ø 60-175mm
H:6" Ø 60-175mm



52697 16,00€

0.50 5 40 720

KOLBENRING SPANNBAND 6"

6" Ø 60-175mm

150mm



52696 12,00€

0.28 5 40 1200

KOLBENRING SPANNBAND 3"

3" Ø 53-175mm

77mm



KOLBENRINGZANGE

REF.	BESCHREIBUNG					€
54273	40-100mm	0.30	6	30	-	10,10€
54274	80-120mm	0.35	6	30	-	11,00€
54275	100-160mm	0.40	6	30	-	13,20€



52591 12,00€

0.10	12	72	1728

ZYLINDER-HONGERÄT 2-ARMIG, 1-1/8"

1-18"
28,60mm
MAX: Ø 55mm
MIN: Ø 19mm



52592 22,00€

0.20	-	20	480

ZYLINDER-HONGERÄT 3-ARMIG, 2"

2"
50,80mm
MAX: Ø 85mm
MIN: Ø 35mm



52593 34,00€

0.47	6	36	648

ZYLINDER-HONGERÄT 3-ARMIG, 4"

4"
101,60mm
MAX: Ø 170mm
MIN: Ø 55mm



REF.	BESCHREIBUNG					€
11878	2ER SATZ POLIERSCHWAMM 1-1/8" FÜR REF. 52591	0.10	25	100	-	4,10€
11879	3ER SATZ POLIERSCHWAMM 2" FÜR REF. 52592	0.04	25	100	-	5,10€
11880	3ER SATZ POLIERSCHWAMM 4" FÜR REF. 52593	0.09	25	100	-	10,50€

53662 89,00€

1.78	5	10	80

ZYLINDERKOPF DICHTPRÜFER-SET



LIEFERUMFANG

200 ml runde Flasche.
250 ml Vierkantflasche.

ADAPTER

Portable: Suzuki, Toyota, Mitsubishi.
Mittelgroße: Suzuki, Toyota, Mitsubishi, Subaru, Peugeot, Nissan, Lexus, Mazda.
Großräumige: Ford, GM, Benz, JEEP.

REF.	BESCHREIBUNG					€
14563	ZYLINDERKOPF DICHTPRÜFER FLÜSSIGKEIT	0.23	5	50	-	18,00€

54347 46,00€

2.00	-	5	100

ZYLINDER-DICHTHEITSPRÜFGERÄT

7 BAR 100 PSI



Dient zur Überprüfung der Dichtheit eines Zylinders.

M12x1.25
M14x1.2

52832

75,00€

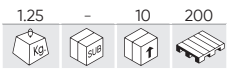

GEBOGENE SCHLÜSSEL 12-KANT ZUM LÖSEN VON RIEMENSCHLEIBEN MIT AUSTAUSCHBARER KOPF SET



AUSTAUSCHBARE NUSS

x8		12, 13, 14, 15, 16, 17, 18, 19mm	x1	
x1				

52690

54,00€

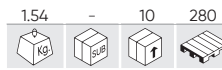

HEBEL ZUM LÖSEN VON RIEMENSCHLEIBEN SET

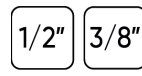

	x4	3/8" - 13, 15, 16, 18mm		x1	1/2" - 230mm
	x3	3/8" - 13, 14, 15mm		x1	3/8" - 585mm

53669

45,00€

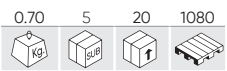

STECKSCHLÜSSEL SET 1/2" SPEZIELL KFZ



- 10S** für Zwischenzahnrad Toyota
- 6S** für Kupplungen, Zylinderkopf und Ausgleichwelle Nissan und Renault
- 8S** für Kupplungen, Zylinderkopf und Ausgleichwelle Nissan und Renault
- 12S** für Kupplungen, Zylinderkopf und Ausgleichwelle Nissan und Renault
- 8TS** für Ausgleichwelle Nissan
- 14mm** für Bremssattel Opel Astra G, Opel Zafira und Smart
- 10mm** für Bremssystem und Kraftstoffpumpe Nissan
- 12,5mm** für Bremssystem und Kraftstoffpumpe Nissan
- 19mm** für Bremssattel Peugeot, Renault und Citroen
- 20mm** für Niederlenker Honda Civic

53053

12,00€

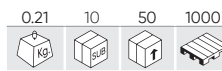

DEMONTAGEHAKEN FÜR DICHTUNGEN

1x15,5cm/1x16,5cm/1x12cm



53637

85,00€



ORGANIZER FÜR ZYLINDERKOPFTEILE

- Bestimmt für den Zylinderkopf.
- Erhält die Sauberkeit und den ordnungsgemäßen Zustand aller Komponenten beim Verlassen des Zylinderkopfs.
- Spart Zeit und hilft, täuschungen zu vermeiden.



52850

7,80€



VENTILEINSCHLEIFER SET - 2 TEILE

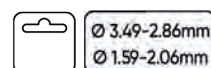

SPEZIALWERKZEUG

51989

49,00€

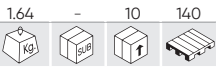

KUNSTSTOFF- UND DRAHTBÜRSTEN SET - 38 TEILE

38 PCS

Ø 8, 9, 10, 11, 12, 13, 14, 15, 16, 17, 18, 19mm



- 1 1/4" Griff.
- 1 Verlängerung.
- 36 Bürsten.

52760

4,10€

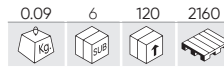

DRAHTBÜRSTE



52515

9,10€

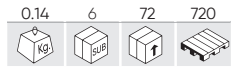

SET AUS 3 DRAHTBÜRSTEN

- 1 x aus Messing.
- 1 x aus Nylon.
- 1 x aus Stahl.



52819

22,00€

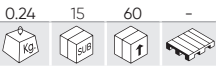

STECKSCHLÜSSEL 1/2" DER HALTEMUTTER VORKAMMER VERBRENNUNG

58 ZÄHNE



53129

84,00€

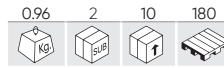

MONTAGWERKZEUG DICHTUNGEN



53875

134,00€

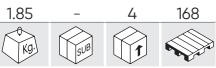

ABZIEHHILFE KURBELWELLENABDICHTUNG (VAG-GRUPPE)

MODELLE

VW: GOLF, TOURAN
AUDI: A3, A4

OEM WERKZEUG

T10134

MOTORCODES

1.4I TURBO
1.4 UND 1.6 DIREKTE KRAFTSTOFFEINSPRITZUNG
1.9/2.0 SDI
2.0 DIESELEN DES COMMON RAIL-SYSTEMS



52190

8,00€

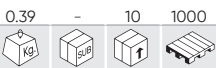

KUPLUNGS-WERKZEUG SPEZIAL FIAT

220x110mm



52495

14,50€

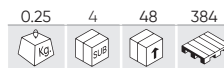

UNIVERSAL KUPLUNGSZENTRIERDORN AUS KUNSTSTOFF

- Für die Mehrheit der Modelle.
- Mit 3 Adaptern von verschiedenem Diameter.



53001

242,00€

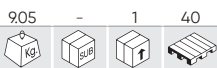

KUPPLUNGSZENTRIERDORN SET S.A.C.

VW, AUDI, BMV, MERCEDES, VOLVO, RENAULT, OPEL

- Verhindert die Deformierungen der Kupplung dank der Nutzung des Vorspanners.
 - Verstellbarer Ring der Druckscheibe bei Montage des neuen Ventils wird die Kupplung in die neue Position dank dem Rückstellungswerkzeug gebracht.
 - Der Satz ist ideal für praktisch alle Typen der APC -Kupplung (mit automatischer Einstellung) geeignet, z.B.

VORTEILE
 Spannen der Druckscheibe der Kupplung bei Montage und Demontage.
 Umstellung der Stellfeder durch Rückstellungswerkzeug in die Ausgangsstellung.
 Zentrierung des Ventils gegenüber Paßlager.

LIEFERUMFANG
 Vorspanner der Kupplung.
 Zapfen mit 3 Löchern.
 Rückstellungswerkzeug.
 Satz von Zentrierbolzen.
 Zapfen MIT 4 Löchern.



53410

92,00€

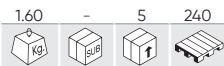

KUPPLUNGSZENTRIERDORN S.A.C.

ZENTRIERDURCHMESSER

x3 15-19, 20-26,6, 23-36mm

ZUBEHÖR DURCHMESSER

x8 12, 14, 15, 16, 17, 18, 19, 20mm



53057

149,00€

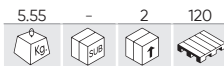

KUPPLUNGSREPARATUR SET FÜR VAG DSG GETRIEBE

- Für den Service bei DSG-Änderungen in Golf (2004-), Golf Plus (2005-), AUDI A3 (2004-) mit 7-Gang Getriebe Code OAM, und in Touareg (2003-) mit 6- Gang Getriebe Code 08D).
 - Referenzen von Werkzeugen nach OEM: T10323, T10373, T10374.



50731

68,00€

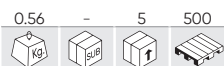

ALKOHOL-REFRAKTOMETER



52963

49,00€

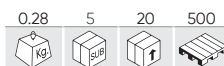

UNIVERSAL REFRAKTOMETER

- Äthylenglykol: -50°C ~ -0°C.
 - PropyleneGlycol: -50°C ~ -0°C.
 - Reinigungsflüssigkeit: -40°C ~ -0°C.
 - UREA AUS32: - 30% ~ 35%.
 - Batterieflüssigkeit: - 1.100 - 1.400 sg/l.



UREA AUS32

53477

36,10€



LEITUNGS-STOPPER-ZANGEN SET - 8 TEILE

8 PCS

NYLON

8mm
 10mm
 13mm



53426

39,80€



VAKUUM- UND DRUCK-PRÜFER

PRESIÓN 0-0,7Kg/cm² (0-10 PSIG)
 PRESSURE
 VACÍO 0-28 inHg (0-70 cmHg)
 VACUUM



SPEZIALWERKZEUG

52066

12,00€

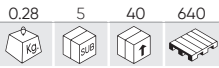

SCHLAUCH ABKLEMM-ZANGEN SET - 3 TEILE



0-20mm
0-35mm
0-70mm

53395

16,00€

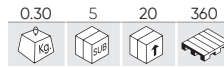

SCHLAUCH ABKLEMM-ZANGEN SET, ABGEWINKELTE SPITZEN - 3 TEILE



Ø13mm
Ø20mm
Ø35mm

52687

168,00€

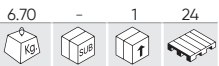

DRUCKDICHTHEITSPRÜFGERÄT FÜR KÜHLSYSTEME



- 1 Pumpe Überdruckventil
- 2A Verbinder 1: für No.3(R123) und No.4 (R124)
- 2B Verbinder 2: für No. 3(R123) und No. 5(R125)
- 3 Mercedes (W123, W126, W124, W201), GM(Buick), Jeep
- 4 Peugeot, Subaru, Chrysler, Acura, GM (Nova, Spectrum, Sprint), Mitsubishi, Nissan, Mazda, Toyota, Infiniti, GEO, Suzuki, Isuzu, Mercedes
- 5 Honda, Toyota, Suzuki, Mitsubishi, Chrysler, Acura
- 6 Mercedes Benz (ML, W163, W164), GM (Achiva, Skylark, Grand Am 1992~2002)
- 7 Volvo, Saab, Sterling, Citroën, Renault, Fiat, Alfa, Jeep
- 8 VW(Vento, T4, Passat-1996, Golf, Beetle, Sharan)
- 9 Audi(A4, A5, A6), BMW 345, VW (Passat - 1997-2002), Porsche(Cayenne)
- 10 BMW (E46, E36, E34, E39, E38, E32, E90)
- 11 Audi, VW
- 12 Internacional, Land Rover, Jaguar
- 13 Mercedes (C, E, S, W140, W220, W124, W210, W211, W215, W216, W221, R230)
- 14 Ford Focus
- 15 Mazda(M3)
- 16 Mercedes classe A (W168)
- 17 BMW E60, E63, E64, E65
- 18 VW SHARAN 1.8T 2.8
- 19 TOYOTA-RAV4, PREVIA Universal-Gummiadapter zum Spülen und Befüllen Heizkörper



- 20 SAAB
- 21 LAND ROVER
- 22 Kia
- 23 Hunday

54139

147,00€

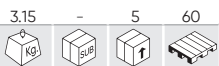

UNIVERSAL-DRUCKDICHTIGKEITSPRÜFGERÄT FÜR KÜHLSYSTEME (5 STÜCK)



x1 17-24mm
x1 28-31.5mm
x1 37-39.5mm
x1 47-48.5mm



53453

7,00€

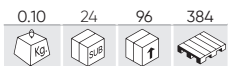

FROSTSCHUTZTESTER

-43°C
131°C



54368

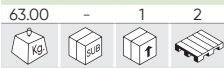

2.329,00€

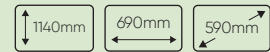

N

REINIGUNGSMASCHINE FÜR DAS KÜHLSYSTEM

Acest aparat vă permite să curățați și să reumpleți întregul sistem de răcire al vehiculului într-un mod rapid și eficient. Prin generarea presiunii, acesta pompează lichidul de răcire în tot sistemul și îl curăță de diverse depuneri. Este compatibil cu diferite tipuri de lichide de răcire.

Aparatul este conectat la bateria vehiculului la 12 V și are o interfață intuitivă care, împreună cu ecranul tactil, două manometre și două ecrane pentru observarea stării fluidului, îl face foarte ușor de utilizat. Pentru o montare ușoară pe marea majoritate a vehiculelor, sunt disponibili conectori rapizi, țevi și adaptori. Aparatul conține două rezervoare de 20 de litri, unul pentru lichidul de răcire nou și celălalt pentru lichidul de răcire uzat, ambele fiind golite prin aparatul însuși. În cazul circuitelor care prezintă rugină sau ulei, se recomandă utilizarea de aditivi pentru o mai mare putere de curățare.

ERSATZTEILE
VERFÜGBARVIDEO-
TUTORIAL

53539



66,00€

AC LECKAGEDETEKTIONS-SET

ER ENTHÄLT

- 1 x UV-Lampe.
- 1 x UV-Sichtbrille.
- 1 x wiederaufladbare Batterie.
- 1 x Spritze zum Einfügen der Flüssigkeit.
- 1 x Schnelladapter.
- 1 x Verlängerungsadapter.
- 1 x Ladegerät.



REF. BESCHREIBUNG

				€
15052 AKKU, IN SET REF. 53539	0.05	5	10	3,00€
15053 LADEGERÄT, IN SET REF. 53539	0.08	-	10	10,50€
15054 LEUCHE, IN SET REF. 53539	0.12	-	50	34,00€
14187 UV-BRILLEN, IN SET REF. 53539	0.05	10	120	6,00€
12200 LECKERKENNUNGSSATZ FÜR DIE KLIMAAANLAGE (REF. 52844)	1.10	-	50	14,50€

54291

5.054,00€

116.00	-	1	1

N

KLIMAAANLAGEN-LADEMASCHINE

200V ±10%	R134A R1234YF	3/8 HP	>2 Kg/min	100 L/min
450g/min	800g/min	12,12 cm ³	LCD 360x128mm	50-60 Hz
99%	<85%	180W	-10° 50°	

Diese Maschine wurde für die Reinigung, die Rückgewinnung des Kältemittels, das Vakuum, die Öleinspritzung und das Auffüllen des Kältemittels in der Fahrzeugklimaanlage entwickelt. Sie ist vollautomatisch. Sobald die Parameter für jede Funktion eingestellt sind, führt die Maschine alle Vorgänge aus, ohne dass der Bediener ständig aufmerksam sein muss.

DIE WICHTIGSTEN MERKMALE DES PRODUKTS SIND:
 VOLLAUTOMATISCH.
 EINFACH ZU BEDIENEN
 MIT GROSSEM SICHTFENSTER UND LED-HINTERGRUNDBELEUCHTUNG
 MANOMETER ERLEICHTERN DIE BEOBACHTUNG DER
 DRUCKWERTEHOHE RÜCKGEWINNUNGSRATE VON GAS UND ÖL
 MIT GROSSER LCD-ANZEIGE
 MIT DATENBANK UND DRUCKER
 SOFTWARE UND DATENBANK KÖNNEN AUFGERÜSTET WERDEN



ERSATZTEILE
VERFÜGBAR



VIDEO-
TUTORIAL

16309

149,00€

1.40	-	1	-

N

SATZ MIT 2 HOCH- UND NIEDERDRUCKSCHLÄUCHEN VON 5 METERN LÄNGE (REF. 54291)



Gas-Adapter 1234YF

R1234YF Schnell abnehmbarer Adapter für Kältemittel in der Klimaanlage. Das schnell abnehmbare Design ist mit einem internen Anhalter ausgestattet. Eine Hülse, die beim Trennen der Kupplung unter Druck vor Verletzungen und Kältemittelundichtigkeiten schützt. Zweck: Klimaanlage und Kühlung.



53499

29,00€

0.20	15	60	2400

GAS-ADAPTER 1234YF (HOCHDRUCK)

- Rot (hoher Druck)
- Material: Messing und Metall
- Gewicht: 194g



53500

29,00€

0.20	15	60	2400

GAS-ADAPTER 1234YF (NIEDERDRUCK)

- Blau (niedriger Druck)
- Material: Messing und Metall
- Gewicht: 175g



53456

98,00€

2.90	-	5	75

KFZ-KLIMAAANLAGE DIAGNOSE SET

BAR	LOW: 0-24BAR HIGH: 0-34BAR
PSI	LOW: 0-350PSI HIGH: 0-500PSI



REF.	BESCHREIBUNG					€
14300	HOCHDRUCK-SCHNELLKUPPLUNG (REF. 53456)	0.15	-	100	-	19,00€
14301	NIEDERDRUCK-SCHNELLKUPPLUNG (REF. 53456)	0.15	-	100	-	19,00€

16316 18,50€

0.30 - 12 -

PAG UNIVERSALÖL FÜR KLIMAAANLAGEN 250ML

N

12977 36,50€

0.33 3 12 480

INDIKATORFLÜSSIGKEIT FÜR AC - 250 ML

- Für jede 1,4 l der Kühlflüssigkeit wird 7,5 ml des Gemischs zugegeben.

50807 38,00€

0.16 6 24 744

O-RING SORTIMENT FÜR AC

Ø	PCS	Ø	PCS
5.29x1.78	20	8.80x1.90	20
6.07x1.78	20	10.82x1.78	15
6.8x1.9	20	10.77x2.62	15
7.65x1.78	20	11.0x2.0	15
7.80x1.90	20	12.0x2.0	15
8.0x2.0	20	13.9x1.80	10
Ø	PCS		
13.95x2.62	10		
14.0x2.0	10		
15.0x2.0	10		
17.0x2.0	10		
17.17x1.78	10		
17.04x3.53	10		

53599 30,30€

0.16 10 100 -

VENTILKERNE SORTIMENT AC

ERSATZTEILVERFÜGBARKEIT

REF	mm	PCS	€
14594	5x19mm R12	50	2,00€
14595	5x19mm	30	1,50€
14596	5x19mm R12	30	2,00€
14597	6x19mm	3	7,60€
14598	6x26mm	1	17,80€
14599	7x20mm R134A	10	4,50€
14600	6x22mm	5	9,50€
14601	8x22mm	1	11,00€
14602	9x22mm	4	11,00€

53459 66,00€

1.05 - 10 150

AC ABTRENN-SET

KLEMMEN DURCHMESSER

x6 8mm (5/16"), 9.5mm (3/8"), 13mm (1/2"), 16mm (5/8"), 19mm (3/4"), 22mm (7/8")

BLOCKER DURCHMESSER

x4 9.5 mm (3/8"), 16mm (5/8"), 13mm (1/2"), 19mm (3/4")

54069 29,50€

0.20 10 40 360

RADNABEN REINIGUNGS SET 14 -TEILE

x1 Düse 8 mm mit 1/2 "" adapter

x1 Schleifscheibe mit rundachse und sechskantkopf 8 mm

x2 Austauschbare unterlegscheibe mit selbstklebender unterlage

x5 Grobkörniger putzring, außendurchmesser 40 mm

x5 Feinkörniger putzring, außendurchmesser 40 mm, innendurchmesser 14 mm

51364 26,00€

2.00 - 5 315

ABZIEHER FÜR CV-GELENKE

Ø 31mm 140-240mm

53638

243,00€

13.35	-	1	32

NABEN-ABZIEHER HYDRAULISCH

- Dieses Set enthält 3 Abzieher/Hammer um das Entfernen der Radnabe und Antriebswelle ohne Beschädigung zu erleichtern:

- Hydraulischer Spindel
- Schraube
- Schlaghammer
- Zum manuellen und hydraulischen Entfernen.
- Hydraulisches Spindel mit einer maximalen Kapazität von 10 Tonnen.
- Hammer mit einem Gewicht von 4 kg.
- Stange-Länge: 57 cm.
- Geeignet für Naben mit: 3, 4, 5 und 6 Öffnungen.



REF. BESCHREIBUNG

				€
1.35	1	10	62,00€	

15253 HYDRAULISCHE SPINDEL FÜR NR. 53384/53638

54384

32,50€

0.60	12	24	-

HÜLSENREINIGER

Sie hilft Ihnen, Oxid und Korrosion an der Radnabe zu entfernen. Sie hat einen Klettverschluss, um die Schleifscheibe einfach zu installieren.

Außendurchmesser: 150mm
 Innendurchmesser: 90mm
 Maximalgeschwindigkeit: 500 U/min

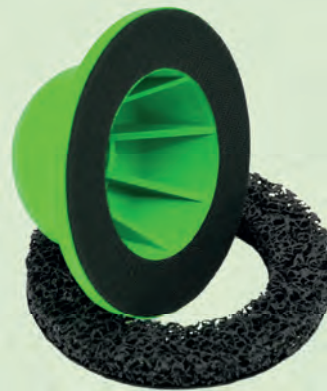

N

REF. BESCHREIBUNG

				€
--	--	--	--	---

16448 REINIGUNGSSCHEIBE FÜR BUCHSEN (REF.54384) 0.11 16 64 16,50€

52829

19,00€

0.45	-	10	140

DRUCKLUFT ACHSMANSCHETTEN PREIZER

ÄUSSERE

Ø 10cm

INNERE

Ø 9,5cm

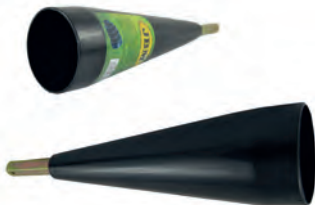

52541

45,00€

2.10	-	10	110

ACHS-/GELENKSPIELTESTER



- Anwendbarkeit:
 Kegellager, Kugellager, Lagerung,
 Einsatz der Lenkverbindungsstange,
 Verbindungsstange, Radlager,
 Axialdrehgelenk,
 Lenkmechanismus, Stabilisator usw.



51121

27,30€

1.80	-	5	440

STOSSDÄMPFER-FEDER SPANNER

- Füße und Gewindestange sind aus der geschmiedeten Eisen-Kohlenstoff-Legierung mit nachfolgender thermischer Behandlung hergestellt.
- Werkzeug ermöglicht außer der Bequemlichkeit bei der Arbeit in schwer zugänglichen Stellen (unter den Radbögen) einen hohen Schutzgrad.
- Maximales Maul: 250 mm.

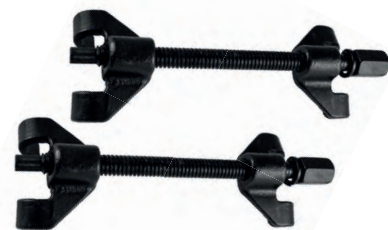

270mm

50827

387,00€

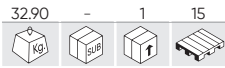

STAND-FEDERSPANNER FÜR STOSSDÄMPFER



- Fassungsvermögen: 1T (2200 lbs)
- Durchmesser der komprimierten Feder: 200mm
- Komprimierte Länge: 200-500mm

53742

1.325,00€

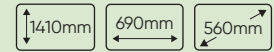

FEDERSPANNER 1T



- Tragfähigkeit: 1000 kg
- Maximale Betriebslänge: 450 mm
- Zylinderhub: 420 mm
- Federdurchmesser: Ø102-165 mm
- Windungsrichtung: im Uhrzeigersinn
- Funktionsweise: pneumatisch
- Luftdruck: 6,5-9 Bar (94,27-130,53 PSI/0,65-0,9 MPa)
- Betriebsmodus: Fußhebel

53394

598,00€

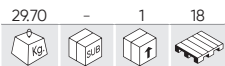

FEDERSPANNER KIT

- Teleskophebel und rutschhemmende Oberflächen sorgen für einen zuverlässigen Halt der Stoßdämpfer.
- Die Konstruktion der Zapfen sieht die Installation einer entfernbaren Kunststoffspitze vor, die eine Beschädigung der Oberfläche ausschließt.
- Schützt die Stoßdämpfer vor dem Biegen während der Kompression.
- Universelle Anwendung, geeignet für mehr als 90% aller bekannten Fahrzeuge.

ENTHALTEN

Der Mechanismus / Kolben.
Drei Paare von Zapfen mit Kunststoffspitzen.



GEEIGNET FÜR DIE ANWENDUNG MIT PNEUMATISCHEN WERKZEUGEN

52227

247,00€



MACPHERSON-FEDERN SPANNER

- Technische Daten:
Maximale Kraft: 2500 H.
Hauptteil.
Verstellbare Lagerung.
3 Backenpaare.
- 1. Paar: ANWENDUNGSGEBIET: 80-115 mm. GEWICHT: 1,45 kg.
- 2. Paar: ANWENDUNGSGEBIET: 110-195 mm. GEWICHT: 2,2 kg.
- 3. Paar: ANWENDUNGSGEBIET: 140-195 mm. GEWICHT: 2,3 kg.

BMW, TOYOTA, FORD, MITSUBISHI, VW, AUDI, SAAB, NISSAN,
HONDA ACCORD, SUBARU, VOLVO, OPEL, PORSCHE.



NICHT ZUR VERWENDUNG MIT DRUCKLUFTWERKZEUG

SPEZIALWERKZEUG

52270

109,00€

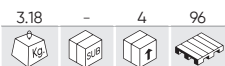

SILENTBLOCK-ABZIEHER FÜR VAG

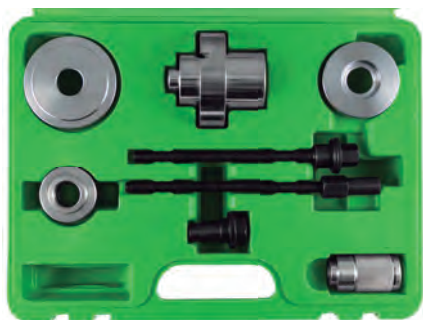

Welle, Wellenende, Druckmutter M10x1,25

Adapterkopf aus Kohlenstoffstahl

Separator

Druckstück

Zentrierdorn aus Aluminiumlegierung.

52432

35,00€



VORDER-SILENTBLOCK ABZIEHER FÜR VAG

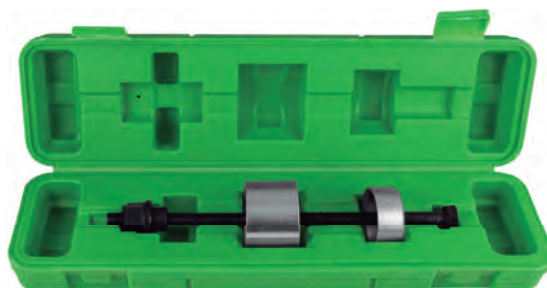

- Werkzeuge für Volkswagen Polo 2000.

AXIALER

REF.	BESCHREIBUNG	MAX	MIN					€
51368	AXIALER ACHSSCHENKELABZIEHER	42mm	33mm	0.41	5	50	2700	19,00€
51369	AXIALMÜTTERN-ABZIEHER	42mm	35mm	0.55	6	36	756	28,00€
51414	GEWINDESTIFT-ABZIEHER	20mm	15mm	0.59	5	40	1440	14,00€



51368



51369



51414

52834

195,00€



NUTMÜTTERN STECKSCHLÜSSEL-SET MIT AUSSENZAPFEN

11 PCS 1/2" Cr-Mo

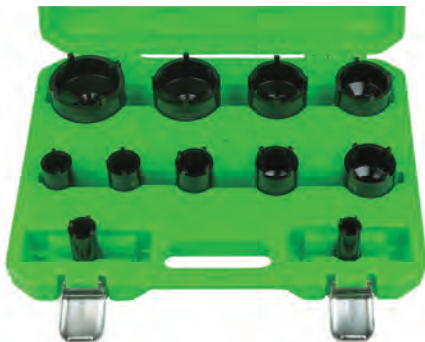

x11 22x3.3mm, 26x3.8mm, 30x4.3mm, 33x4.0mm, 37x4.8mm, 44x5.3mm, 50x5.8mm, 56x5.8mm, 63x6.3mm, 69x6.8mm, 75x6.8mm

52835

272,00€



NUTMÜTTERN STECKSCHLÜSSEL-SET MIT INNENZAPFEN

10 PCS 1/2"



x10 26x5.3mm, 1,2x6.25mm, 34.2x6.3mm, 38.2x6.65mm, 42.2x7.3mm, 50.1x8.25mm, 58.2x9.8mm, 74.6x11.9mm, 82.2x13.25mm, 87.7x13mm

SPURSTANGENGELN ABZIEHER WERKZEUG

REF.	BESCHREIBUNG					€
52640	Ø 28-35mm	1.80	-	4	256	52,00€
52641	Ø 35-45mm	2.20	-	4	140	55,00€



SPURSTANGENGELN ABZIEHER

REF.	BESCHREIBUNG					€
52874	Ø 9-20mm	1.20	4	20	1500	82,00€
52875	Ø 14-23mm	1.25	5	20	1500	79,00€



53635

6.50	-	2	80

RADLAGER-ABZIEHER MIT SCHLÄGEL

- Gleitnabe: 4 Kilogramm.
- Durchmesser: 100-115mm.
- Für M12-Schrauben.

85,00€

440-630mm



51490

36,00€

1.88	-	5	360

KUGELGELENK GABELABZIEHER SET - 5 TEILE



GRIF FÜR ARBEIT MIT HAMMER
 JOCHE: 11/16, 15/16 UND 1-1/8"

53384

165,00€

7.30	-	2	62

KUGELGELENK-ABZIEHER HYDRAULISCH

- Öffnung: 100mm.
- Breite: 35mm.



REF. BESCHREIBUNG

15253	HYDRAULISCHE SPINDEL FÜR NR. 53384/53638				€
		1.35	1	10	62,00€

53208

126,00€

0.95	5	20	-

STECKSCHLÜSSEL-SET FÜR BMW-FELGENSCHLOSS

22 PCS BMW 41-60



ANWENDUNGEN

BMW Serie 1 F20/F21
 BMW Serie 3 F30/F31
 BMW Serie 4 F32/F34/F36
 BMW Serie 5 F10/F11
 BMW Serie 6 F12/F13
 BMW Serie 7 F01/F02/F04

x20 41, 42, 43, 44, 45, 46, 47, 48, 49, 50, 51, 52, 53, 54, 55, 56, 57, 58, 59, 60

53207

118,00€

1.55	5	10	330

STECKSCHLÜSSEL-SET FÜR BMW-FELGENSCHLOSS

23 PCS VW



x1 B51 / 6PT		
x1 B52 / 7PT		
x1 B53 / 8PT		
x1 B54 / 9PT		
x1 B55 / 10PT		
x1 B56 / 11PT		
x1 B57 / 12PT		
x1 B58 / 13PT		
x1 B59 / 14PT		
x1 B60 / 15PT		
x1 B61 / 16PT		
x1 B62 / 17PT	x1 ABC3 / 14PT	
	x1 ABC4 / 15PT	x1 ABC7 / 19PT
	x1 ABC5 / 16PT	x1 ABC8 / 20PT
	x1 ABC2 / 13PT	x1 ABC9 / 21PT

SPEZIALWERKZEUG

52802

54,00€

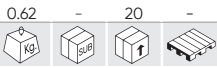

STECKSCHLÜSSEL-SET FÜR BMW-FELGENSCHLOSS

10 PCS **BMW**



x1	30/13 PT
x1	31/15 PT
x1	32/16 PT
x1	33/17 PT
x1	34/18 PT

x1	35/19 PT
x1	36/20 PT
x1	37/21 PT
x1	38/22 PT
x1	40/23 PT

53328

76,00€

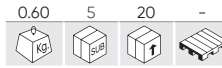

STECKSCHLÜSSEL-SET FÜR MERCEDES-FELGENSCHLOSS

12 PCS

MERCEDES



ANWENDUNGEN

A, B, C, GLK, CLC, CLS, CLK, E, SL, SLK, M, C300, C250, C350, E320, 204, 211, 212, R

51998

38,00€

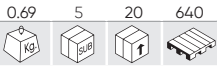

SPIRAL-PROFIL-STECKSCHLÜSSEL SATZ FÜR SICHERHEITS-SCHRAUBEN UND -MUTTERN, 3/8" - 10 TEILE

10 PCS **3/8"** **Cr-Mo**

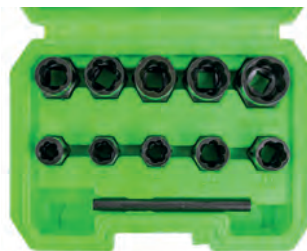

ERSATZTEILVERFÜGBARKEIT

REF.	mm				€
16737	9mm	0.07	-	100	12,00€
11434	10mm	0.04	-	100	12,00€
11435	11mm	0.04	-	100	12,00€
11436	12mm	0.04	-	100	12,00€
11437	13mm	0.04	-	100	12,00€

REF.	mm				€
11438	14mm	0.06	-	100	12,00€
11439	15mm	0.06	-	100	12,00€
11440	16mm	0.06	-	100	12,00€
11441	17mm	0.08	-	100	12,00€
11442	19mm	0.09	-	100	12,00€

52962

42,00€

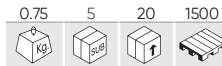

SPIRAL-PROFIL-STECKSCHLÜSSEL SATZ FÜR SICHERHEITS-SCHRAUBEN UND -MUTTERN, 3/8", - 11 TEILE

11 PCS **3/8"** **Cr-Mo**



ERSATZTEILVERFÜGBARKEIT

REF.	mm				€
11450	6mm	0.07	-	100	12,00€
12093	8mm	0.07	-	100	12,00€
11434	10mm	0.04	-	100	12,00€
11435	11mm	0.04	-	100	12,00€
11436	12mm	0.04	-	100	12,00€
11437	13mm	0.04	-	100	12,00€

REF.	mm				€
11438	14mm	0.06	-	100	12,00€
11439	15mm	0.06	-	100	12,00€
11440	16mm	0.06	-	100	12,00€
11441	17mm	0.08	-	100	12,00€
11442	19mm	0.09	-	100	12,00€

52823

124,00€

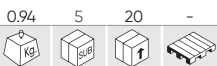

STECKSCHLÜSSEL-SET FÜR AUDI-FELGENSCHLOSS

22 PCS **VAG**

A, B, C, E, F, G, H, I, J, L, M, N, P, Q, R, S, T, V, W, X



x20 A, B, C, E, F, G, H, I, J, L, M, N, P, Q, R, S, T, V, W, X

54317

124,00€



STECKSCHLÜSSEL-SET FÜR VAG-FELGENSCHLOSS

22 PCS **VAG** **CR-MO**

521,522,523,524, 525,526,527,528, 529,530,531,532, 533,534,535,536, 537,538,539,540



x20 521,522,523,524,525,526,527,528,529,530,531,532,533,534,535,536,537,538,539,540

52153

46,00€

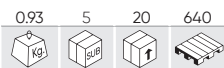

SPIRAL-PROFIL-STECKSCHLÜSSEL SATZ FÜR SICHERHEIT-SCHRAUBEN UND -MUTTERN, 1/2"



ERSATZTEILVERFÜGBARKEIT

REF.	mm				€	REF.	mm				€
11443	17mm	0.02	25	100	14,00€	11446	23mm	0.03	25	100	15,00€
11444	19mm	0.02	25	100	14,00€	11447	27mm	0.03	25	100	15,50€
11445	21mm	0.02	25	100	15,00€						



54253

166,00€



SATZ ZUM ENTFERNEN DER RAD-SICHERHEITSBOLZEN

Einfach zu verwendendes Master-Kit, mit dem praktisch alle Radmuttersicherungen entfernt werden können. Das Kit enthält Schutzkappen, die das Rad vor Beschädigungen schützen. Sehr effektiv und ein unentbehrliches Werkzeug für die Werkstatt. Das Kit enthält zwei Größen von Schlagschneideklingen für die meisten gängigen Radmutter, die in die äußere Felge geschnitten werden. Außerdem sind drei doppelseitige Klingen enthalten, die sich direkt in die Form der Buchse einarbeiten lassen.

UNIVERSELL EINSETZBAR: Entfernt eine Vielzahl von Größen, Typen und Profilen, einschließlich solcher mit drehenden Kragen. Inklusive Schlagschrauber und Stempel.

ERSATZTEILVERFÜGBARKEIT

REF.	BESCHREIBUNG				€
16300	FRÄSER UND DORN (REF. 54253)	0.15	-	100	7,60€
16301	FRÄSER B UND DORN (REF. 54253)	0.15	-	100	7,60€
16302	FRÄSER C (REF. 54253)	0.05	-	100	7,60€



54299

227,00€



DEMONTAGE- UND INSTALLATIONSSATZ FÜR RADNABEN UND LAGER



	5,3cm		8,6x10,9cm
	5,8cm	B	8,2x10cm
	6,5cm		7,1x9,45cm
	6,6cm		8,9x17,6cm
A	Ø 2,3mm	C	9,9x17,6cm
	7,1cm		12x17,8cm
	7,3cm	D	Ø 2,3mm 9,5cm
	7,8cm	E	Ø 8,6mm 9,55cm
	8,3cm	F	2,4x28cm

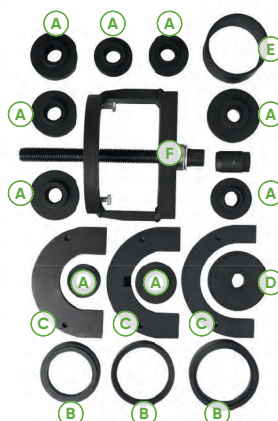

SPEZIALWERKZEUG

51919

89,00€



DREHMOMENTVERVIELFÄLTIGER

4
PCS



- Material: 40 CR.
- Maximale Leistung: 5800Nm.
- Arbeitskraft: 3800Nm.
- Koeffizient der Drehmomentumwandlung: 1: 56.
- Lieferumfang: 1" Einsätze 32mm und 33mm.

52796

98,00€

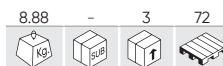

LKW DREHMOMENTVERVIELFÄLTIGER

5
PCS 6000
Nm



- Anwendung an LKWs mit Radkappen und Radschutz.
- Verhindert Felgenschaden.
- Einzigartige Konstruktion.
- Flexibilität für jedes Fahrzeug.
- Zum einfachen Einziehen und Lösen.

LIEFERUMFANG

- 1 x Ansatz 1" 32mm.
- 1 x Ansatz 1" 33mm.

51958

422,00€



DREHMOMENTVERVIELFÄLTIGER SET 1/2" + 3/4" ZOLL ANTRIEB

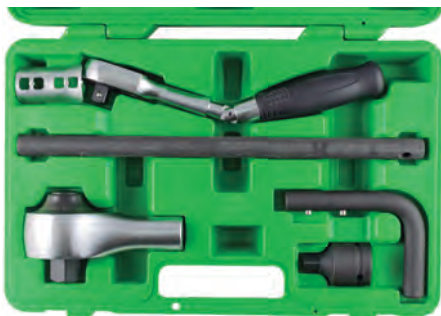

LIEFERUMFANG

- 1x Multiplikator.
- 1x Handsratsche.
- 1x 1/2" M x 3/4" F Adapter.
- 1x abnehmbarer Satz.
- 1x 90° flexible Verlängerung.
- 1x 350mm Verlängerung.

EIGENSCHAFTEN

- Übersetzungsverhältnis 1:4.
- Koeffizient der Drehmomentumwandlung: 1:3,3.
- Maximales Moment am Eingang: 303 Nm.
- Maximales Moment am Ausgang: 1000 Nm.

52012

68,00€



DREHMOMENTVERVIELFÄLTIGER JUNIOR

1/2"

FÜR AUTOS



LIEFERUMFANG

- 1x Drehmomentmultiplikator.
- 1x 90° Verlängerung.
- Einsätze 17, 19 und 21mm.

- Koeffizient der Drehmomentumwandlung: 1:18.
- Maximales Moment am Ausgang: 360 Nm.
- Maximales Anzugsmoment: 800 Nm.

AXIALER

REF.	BESCHREIBUNG	mm	Max.	Min.					€
52642	UNIVERSAL KUGELGELENKABZIEHER	17-22mm	60mm	20mm	1.32	5	10	660	32,00€
52699	KUGELGELENKABZIEHER	18-22mm	50mm	15mm	0.80	5	30	1140	22,00€



52642



52699

51123 91,00€

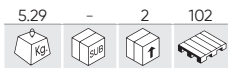

KUGELGELENK-ABZIEHER SET - 5 TEILE



- Satz von universalen Abziehvorrichtungen.
- Einfaches Abbauen von verbreitetsten Typen von Kugelgelenke und anderen Gelenken.
- Gelenkkäfig ermöglicht den Abbau von Kugelmuffen, ohne Beschädigung des Aufgebers und anderer Elemente von anderen Typen der Abziehvorrichtungen.

53488 61,00€

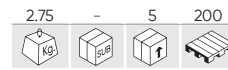

WERKZEUG ZUR STURZEINSTELLUNG (VAG)



x1	75mm	Seat - Toledo VW - Jeta / Golf
x1	85mm	Seat - Cordoba VW - Polo / 95>
x1	115mm	Chrysler - Voyager
x1	22mm	

51902 84,00€

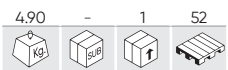

HEBEL ZUM HERAUSZIEHEN DES KUGELGELENKS DES QUERLENKERS

- Länge: 118cm.
- Durchmesserrohr: 3,5cm.
- Abstand der Spreizung: 50, 45, 40, 35, 30cm.
- Befestigung: 15x13cm.



REF. BESCHREIBUNG

10953 ERSATZHAKEN FÜR REF.51902

				€
0.83	-	25	-	12,50€

51119 62,00€

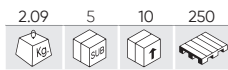

STECKSCHLÜSSEL SET FÜR LAMBDA-SONDE - 7 TEILE



x1	1/2"	29x9 ~ 90mm
x1	1/2" ~ 7/8"	50mm
x1	1/2"	27x12 ~ 78mm
x1	3/8" ~ 7/8"	6 ~ 90mm
x1	3/8" ~ 7/8"	6 ~ 80mm
x1	3/8" ~ 7/8"	30mm
x1	3/8" ~ 1"	74mm
x1	1" ~ 1/16"	74mm



52637 48,00€

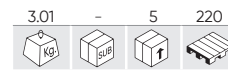

EXPANDER SATZ FÜR AUBGASANLAGEN

x1	1-1/8" - 1-3/4"
x1	1-1/2" - 2-1/2"
x1	2-1/8" - 3-1/2"

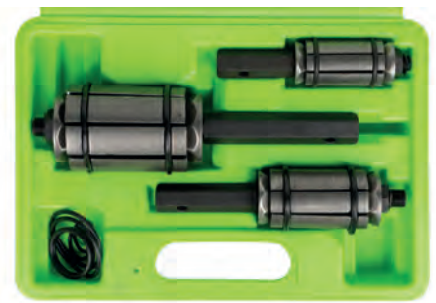

51491

154,00€

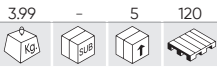

STECKSCHLÜSSEL SET FÜR LAMBDA-SONDE - 14 TEILE

14 PCS

17x78mm	12PT	Renault
19x78mm	12PT	VW, Polo, Audi, Seat, Mazda
20x78mm	6PT	Deschis, Japon
27x78mm	6PT	Deschis, Japon
21x90mm	12PT	Seat, Audi, VW, Skoda, Alfa Romeo, Mitsubishi
22x78mm	12PT	Seat, Audi, VW, Skoda, Opel
22x110mm	12PT	Mercedes, Citroën, Peugeot, Ford, Nissan, Mazda, Mitsubishi, Seat, Audi, VW...



51991

54,00€

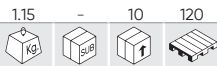

LENK-JUSTIERER

- Offene Gesamtlänge: 1950mm.
- Geschlossene Gesamtlänge: 1100mm.
- Abmessungen der Schraube: M6 x15mm.
- Alu-Außenrohr 20x20.
- Innenrohr aus verzinktem Eisen 16x16.



53118

231,00€

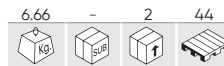

STOSSDÄMPFER DEMONTAGE-SET

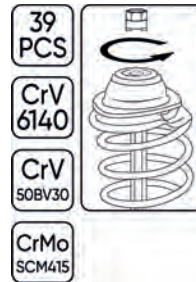

52822

32,00€

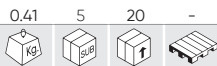

GELENKSCHLÜSSEL FÜR LAMBA-SONDEN 22MM - GEBOGEN



22mm



52849

8,50€

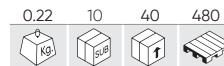

HAKEN FÜR DIE ENTFERNUNG VON GUMMIRINGE AN ABGASANLAGEN

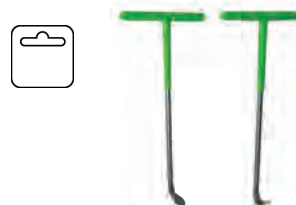

52852

6,80€

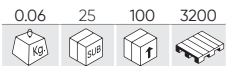

SET AUS GREIFERN UND HAKEN



51347

9,90€

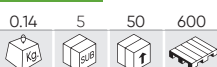

STETHOSKOP

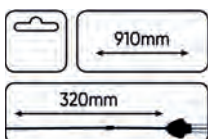

- Erkennt und verstärkt äußere mechanische Geräusche und Geräusche der fließenden Flüssigkeit.
- Hilft bei der schnellen Fest-stellung der Geräuschquelle im Motor.
- Analysiert die Ströme von Wasser, Kraftstoff, Gase oder Dampf.
- Schlagsicherer Griff.



53249

192,00€

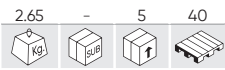

ELEKTRONISCHES STETHOSKOP

Geeignetes Kit zur Fehlererkennung an Ansaug-/Auslasskrümmern, Einspritzdüsen, Kühlern usw. Es ermöglicht die gleichzeitige Auskultation mehrerer Punkte des Fahrzeugs und erleichtert dem Bediener die Suche und Diagnose von Fehlern. Farblich markierte Sonden erleichtern dem Bediener die Arbeit.

EIGENSCHAFTEN

Sensorkabellänge: 4,8 m
 Länge der Audiosonde: 14 cm
 9V-Batterien (im Lieferumfang enthalten)
 Anzahl der Sensoren: 6
 Geeignet für 3,5-mm-Klinkenstecker
 Einstellbare Mikrofonlänge: 21 cm

x1	Audiotester	x6	Snare-Mikrofonkanäle
x1	Helme	x1	Befestigungsklettverschluss für Sensoren
x6	Mikrofonklammern	x1	Quadratische Batterien



52293

98,00€

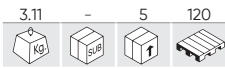

ABZIEH-SET ZUM LÖSEN VON RIEMENSCHLEIBEN - 30 TEILE

A	x1	H38x3 Pins - 20mmL
B	x1	H17x4 Pins - 30mmL
C	x1	3/8" Dr. x H10
D	x1	1/2" Dr. x H10
E	x9	M10xH12 (64mmL), T50xH12 (64mmL), H10xFH10 (68mmL), H8xH10 (75mmL), M8xH10 (75mmL), M10xH10 (75mmL), H10xH10 (75mmL), T40xH10 (75mmL), T50xH19 (75mmL)
F	x3	1/2" Dr. T50 - 17mm x T33 - 100mmL, 1/2" Dr. M10 - 17mm x T33 - 100mmL, 3/8" Dr. M10 - 12mm x T31 - 85mmL,
G	x4	1/2" Dr. T50 - 140mmL, 1/2" Dr. M10 - 140mmL, 1/2" Dr. T50 - 200mmL, 1/2" Dr. M10 - 200mmL
H	x5	H17xH21 (30mmL), H15xH28 (30mmL), H19xH28 (30mmL), H21xH28 (30mmL), H22xH28 (30mmL)
I	x2	H22 (30mmL), H17 (35mmL)
J	x3	H22x22mm x T33 (300mmL), H15x15mm x T33 (30mmL), 15mm x T33 (30mmL)

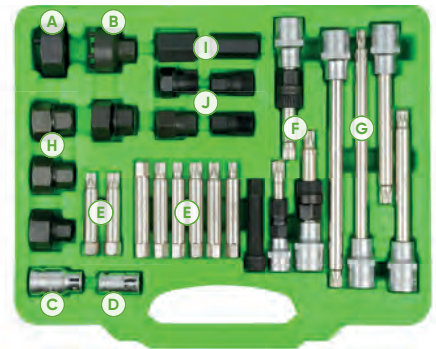

51259

58,00€

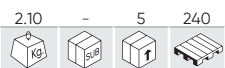

RIEMENSCHLEIBEN ABZIEHER 18ER SET

ERSATZTEILVERFÜGBARKEIT

REF.	BESCHREIBUNG	kg	Stk	€	
10485	XZN STECKSCHLÜSSEL-BIT 1/2" M10 FÜR REF. 51259	0.10	5	100	8,10€
10486	STECKSCHLÜSSEL-BIT T50 FÜR REF. 51259	0.15	5	50	8,00€
10494	14CM STECKSCHLÜSSEL-BIT, EXTRALANG FÜR REF. 51259	0.16	-	-	6,50€
10495	H10 STECKSCHLÜSSEL-BIT FÜR REF. 51259	0.06	-	-	3,00€
10496	H8 STECKSCHLÜSSEL-BIT FÜR REF. 51259	0.06	5	50	3,00€
10497	M10 STECKSCHLÜSSEL-BIT FÜR REF. 51259	0.06	5	100	3,00€
10498	M8 STECKSCHLÜSSEL-BIT FÜR REF. 51259	0.06	5	50	3,00€
10499	T40 STECKSCHLÜSSEL-BIT FÜR REF. 51259	0.05	5	60	3,00€
10500	T50 STECKSCHLÜSSEL-BIT FÜR REF. 51259	0.06	5	100	3,00€
10501	XZN STECKSCHLÜSSEL-BIT 3/8" M10 FÜR REF. 51259	0.08	5	100	8,10€
10502	STECKSCHLÜSSEL-BIT M10 75MML FÜR REF. 51259	0.06	-	20	3,50€

ENTHALTEN

A	x3	T50x110mm (1/2"), M10x110 (1/2"), M10x90mm (3/8")	E	x1	1/2"x10mm
B	x1	M10x140mm	F	x1	M10x65mm
C	x2	19, 22mm	G	x6	T40, T50, M8, M10, H8, H10 (10x75mm)
D	x3	22x28, 19x28, 21x28mm	H	x1	H22

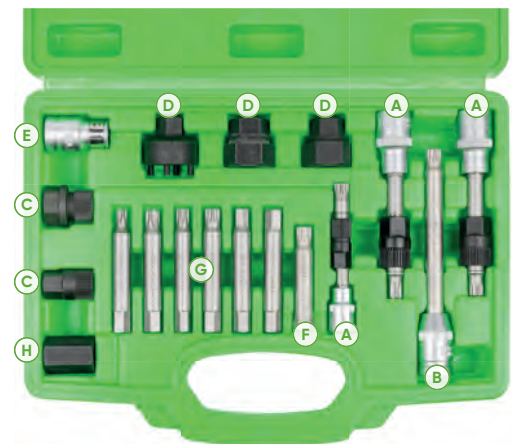

51495

59,00€

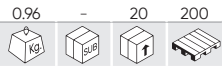

ZÜNDSPULEN-ABBAU SET FÜR VW



- Zum Abbauen von Zündspulen ohne Beschädigungen. Für Motoren VW CYL 8 und 12 UND für 5 und 6 CYL für Golf, Bora in 4 und 5 CY.
 - Sowie für PASSAT MIT 6CYL Sharan, Touareg und Phaeton.
 - Zum Abbauen von Zündspulen mit der Stromversorgungs-einheit, z.B. VW Polo, Golf 1.4, 1.6i, 1.4i, Caddy, Bora 1.4, 1.6 UND Phaeton, Passat, Touran 1.6i und Transporter T4.



GLÜHKERZENSTECKER ZANGE

REF.	BESCHREIBUNG				€
52816	GLÜHKERZENSTECKER ZANGE MIT WINKEL - 235MM	0.27	6	36	28,10€
52817	GLÜHKERZENSTECKER ZANGE 250MM	0.28	6	36	23,50€



52621

11,00€

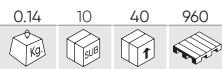

BATTERIEKLEMMEN REINIGER



52319

8,80€

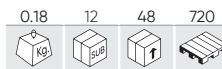

BATTERIEKLEMMEN REINIGER



ZÜNDKERZEN STECKNUSS MAGNETISCH

REF.	"	mm					€
52316	3/8"	250mm - Ø14mm	0.20	12	48	2880	18,90€
52317	3/8"	250mm - Ø16mm	0.30	12	48	2880	19,90€



6-KANT ZÜNDKERZEN STECKNUSS 1/2"

REF.	"	mm					€
10054	1/2"	16mm	0.08	10	100	-	2,90€
10055	1/2"	21mm	0.14	10	100	-	3,90€



52691

54,00€



ZÜNDKERZEN GELENKSTECKNUSS SET

MIT MECHANISCHE KLEMMVORRICHTUNG

3/8"	8mm (82mm)	3/8"	12mm (82mm)
3/8"	9mm (82mm)	3/8"	14mm (82mm)
3/8"	10mm (82mm)	3/8"	16mm (82mm)



ZÜNDKERZENSCHLÜSSEL MIT GELENKSCHLÜSSEL

REF.	BESCHREIBUNG					€
54381	14MM ZÜNDKERZENSCHLÜSSEL MIT GELENKSCHLÜSSEL	0.35	10	40	-	5,00€
54382	16MM ZÜNDKERZENSCHLÜSSEL MIT GELENKSCHLÜSSEL	0.35	10	40	-	5,00€
54383	21MM ZÜNDKERZENSCHLÜSSEL MIT GELENKSCHLÜSSEL	0.39	10	40	-	5,00€



N

54380

0.00	10	50	-

119,00€

SATZ MIT 9 STECKSCHLÜSSELN MIT T-GRIFF (7-19MM)

ERSATZTEIL VERFÜGBAR

REF.	mm				€	REF.	mm				€
16430	7	0.17	10	50	20,50€	16565	14	0.17	10	50	19,50€
16431	8	0.17	10	50	20,50€	16566	19	0.17	10	50	22,50€
16432	10	0.17	10	50	20,50€						
16433	11	0.17	10	50	20,50€						
16434	13	0.17	10	50	20,50€						
16435	15	0.17	10	50	21,50€						
16436	17	0.17	10	50	21,50€						

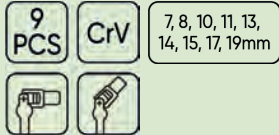

N

51501

0.88	5	20	240

38,00€

AIRBAG DEMONTAGE-SET

12
PCS

- 0,5 PC 1/4" x 87 mm Einsätze (L):
2x Torx: T25 (für BMW), T30 (für Audi, Opel, Renault, VW).
2x Torx (geschützt): T25H (für BMW), T30H (für AUDI, BMW, Mercedes, Opel).
1x sechskantig: 5 mm (für AUDI).

- 0,7 PC Abziehvorrichtung:
1x für Airbag an der Fahrerseite. 1999-2004 neue Karosserie VW Passat, JETTA, GOLF.
2x für VW Passat B5, POLO, LUPO; AUDI A4, A6, Skoda Superb.
2x für VW GOLF 4, New Beetle, SEAT, SKODA FABIA, AB Oktavia BJ.99.
1x für VW GOLF 4 (BJ, 1998-2004), VW PASSAT BJ.1997 AB, AB BORA BJ.1999.
1x für U.A VW MODELL: AB PASSAT BJ.2000.

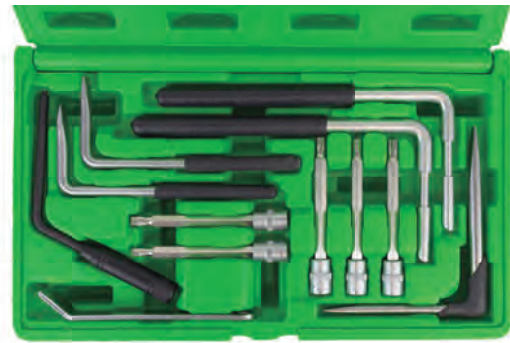

53388

1.50	-	5	120

90,00€

AUDIOEINHEITEN RADIO AUSBAU-SET - 52 TEILE

52
PCS

BLAUPUNKT, CLARION, SKODA, BMW, AUDI, GFUNDIG, JVC, PIONEER, VOLKSWAGEN, MERCEDES, OPEL DOPPEL-KUGEL-INBUS, PORSCHE, BECKER, KENWOOD, SONY, PANASONIC, FIAT BRAVA, FORD.



18,00€

51126

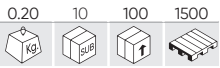

AUTORADIO AUSBAUZUBEHÖR

10 PCS

BLAUPUNKT, PEUGEOT, CLARION, SKODA, ALPINE, BMW, OPEL, AUDI, GFUNDIG VDO, JVC, PIONEER, VOLKSWAGEN, MERCEDES, PORSCHE, RENAULT, BECKER.



53393

118,00€

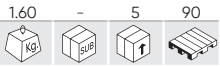

WERKZEUG ZUM ENTFERNEN VON KABELSCHUHEN - 23 TEILE

23 PCS



BMW, AUDI, VOLKSWAGEN, MERCEDES, OPEL, PORSCHE, JAGUAR, SAAB, SEAT, FORD, SKODA, RENAULT, CITROËN, CHRYSLER, FIAT, HONDA, MAZDA, MITSUBISHI, TOYOTA.

53391

86,00€

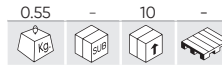

WERKZEUG ZUM ENTFERNEN VON KABELSCHUHEN - 19 TEILE

19 PCS

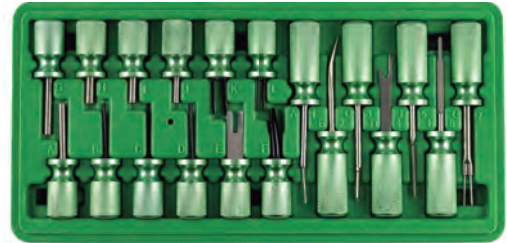

x19 A, B, C, D, E, F, G, H, I, J, K, L, A1, B2, C3, D4, E5, F6, G7

51986

11,90€

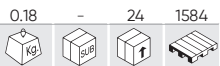

ERSATZGAS 200ML

200ml



51920

18,00€

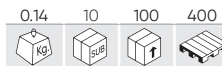

GASBRENNER



53474

94,00€

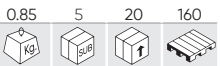

DIGITAL ZÜNDLICHTPISTOLE STROBOSKOPLAMPE

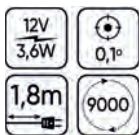

53240

58,00€

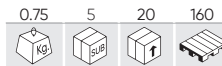

ZÜNDLICHTPISTOLE STROBOSKOPLAMPE



53663

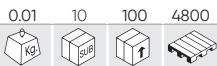

8,00€

DEMONTAGE-WERKZEUG FÜR VAG-ANSCHLÜSSE



- Werkzeug zur Entfernung von Steckverbinder in Fahrzeugen der VAG-Gruppe, ohne diese zu beschädigen.



GEWINDE REPARATUR SET

53041

37,60€

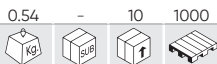

M14 x 1,25

SPEZIAL ZÜNDKERZEN



51898

139,00€

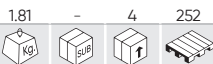

M18 x 2,5



51899

137,00€



M20 x 2,5



51896

82,00€



115 PCS

GEWINDE REPARATUR SET - 115 TEILE



LIEFERUMFANG

Bit.
Fertigschneider.
Drahteinlage.
Fehleranzeiger.
Satz von Spiralen aus rostfreier Stahl.

BAUGRÖSSEN

25 x M5x0.8
25 x M6x1
25 x M8x1.25
25 x M10x1.5
10 x M12x1.75

51897

122,00€



39 PCS

GEWINDE REPARATUR SET - 39 TEILE



LIEFERUMFANG

Bit.
Fertigschneider.
Drahteinlage.
Fehleranzeiger.
Satz von Spiralen aus rostfreier Stahl.

BAUGRÖSSEN

9 x M12x1.75
9 x M14x2
9 x M16x 2.0

AUSTAUSCHBARE STOSSDÄMPFER

REF.	BESCHREIBUNG					€
52016	HELICOIL M5X0,8	0.01	10	300	72000	2,10€
52017	HELICOIL M6X1,0	0.01	500	1000	21000	2,40€
52018	HELICOIL M8X1.25	0.01	10	500	21000	2,60€
52019	HELICOIL M10X1,5	0.01	10	500	21000	3,20€
52021	HELICOIL M12X1.75	0.05	100	500	21000	3,40€
52022	HELICOIL M14X2.0	0.03	100	300	12600	4,50€
52023	HELICOIL M16X2.0	0.05	60	300	12600	6,60€
52024	HELICOIL M18X2.5	0.08	-	10	21000	10,60€
52025	HELICOIL M20X2.5	0.10	-	60	21000	13,00€

SPEZIALWERKZEUG

50793

94,00€

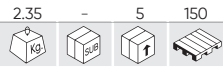

**60
PCS**

GEWINDE-BOHRER UND -SCHNEIDER SET, METRISCH UND ZOLL - 60 TEILE

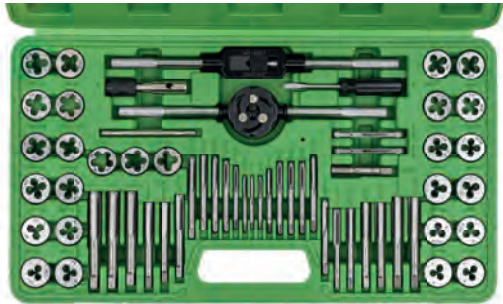

- x1 Außenteil NPT: 1/8-27
- x1 Kluppe NPT: 1/8-27
- x1 Außenteil, kombiniert M3-M12 und 3/16" - 1/2".
- x1 Außenteil, vom gemischten Typ 1: M3-M6 und 4-40 6-32.
- x1 Schneideisenhalter: ø25mm
- x1 Durchmesser.
- x1 Metrischer Satz von gewindelehren.
- x1 Metrischer Satz von gewindelehren (zoll).
- x10 Außenteile (metrisch): M3X0,5, M4X0,7, M5X0,8, M6X1,0, M7X1,0, M8X1,25, M9X1,25, M10X1,0, M10X1,5, M12X1,75.
- x10 Gewindebohrer unc (in Zoll): 4-40, 6-32, 8-32, 10-24, 12-24, 1/4-20, 5/16-18, 3/8-16, 7/16-14, 1/2-13.
- x6 Gewindeschneider unf (in Zoll): 10-32, 1/4-28, 5/16-24, 3/8-24, 7/16-201/2-20.
- x10 Gewindeschneider (metrisch) M3X0,5, M4X0,7, M5X0,8, M6X1, M7X1, M8X1,25, M9X1,25, M10X1, M10X1,5, M12X1,75.
- x10 Außenteile unc gewindeschneider (in Zoll): 4-40, 6-32, 8-32, 10-24, 12-24, 1/4-2, 5/16-18, 3/8-16/7/16-14, 1/2-13.
- x6 Gewindeschneider unf (in Zoll): 10-32, 1/4-28, 5/16-24, 3/8-24, 7/16-20, 1/2-20.

50792

105,00€

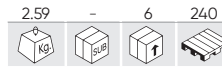

**58
PCS**

GEWINDE-BOHRER UND -SCHNEIDER SET, TITANBESCHICHTET - 58 TEILE



- x1 Npt gewindebohrer: 1/8-27.
- x1 Npt gewindeschneider: 1/8-27.
- x1 Gewindebohrerhalter: M4-M12.
- x1 Gewindebohrerhalter vom T-Typ: M3-M6.
- x1 Schneideisenhalter: 25mm.
- x1 Außendurchmesser.
- x1 Satz von gewindelehren.
- Gewindebohrer: M2X0.4 (x2), M3X0.6 (x2), M3X0.5 (x2), M3.5X0.6 (x2), M4X0.75 (x2), M4X0.7 (x2), M5X0.8 (x2), M6X0.75 (x2), M6X1.0 (x2), M7X0.75 (x2), M7X1.0 (x2), M8X1.0 (x2), M8X1.25 (x2), M10X1.25 (x2), M10X1.5 (x2), M12X1.25 (x2), M12X1.75 (x2)
- x17 Gewindeschneider: M2X0.4, M3X0.6, M3X0.5, M3.5X0.6, M4X0.75, M4X0.7, M5X0.8, M6X0.75, M6X1.0, M7X0.75, M7X1.0, M8X1.0, M8X1.25, M10X1.25, M10X1.5, M12X1.25, M12X1.75

51496

8,00€

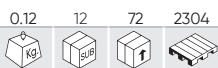

STELLSCHRAUBEN AUSBAU-SET

- N°1 1/8" - 1/4" (M 3-6)
- N°2 1/4" - 5/16" (M 6-8)
- N°3 5/16" - 7/16" (M 8-11)
- N°4 7/16" - 9/16" (M 11-14)
- N°5 9/16" - 3/4" (M 14-18)



53502

38,70€

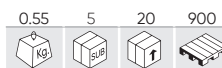

KAPUTTE SCHRAUBENGWINDE AUSBAU-SET

- #2 M5
- #3 M6
- #4 M8
- #5 M10
- #6 M12
- #7 M14
- #8 M16
- #9 M20
- #10 M22



53055

33,00€

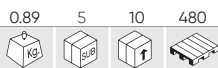

NIETER UND ABBAU WERKZEUG FÜR MOTORRADKETTEN

- BRECHSPITZEN 2.2mm, 2.9mm, 3.8mm



54280

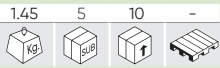

156,50€



ZÜNDKERZENGEWINDE-REPARATURSET

ERSATZTEILVERFÜGBARKEIT

REF.	BESCHREIBUNG				€
16237	M8X1,0 115MM	0.10	10	40	23,00€
16238	M10X1,0 115MM	0.10	10	40	23,00€
16239	M12X1,25 140MM	0.15	10	40	23,00€
16240	M12X1,25 270MM	0.30	10	40	26,00€
16241	M14X1,25 140MM	0.15	10	40	23,00€
16242	M14X1,25 270MM	0.35	10	40	26,00€
16243	M18X1,5 90MM	0.10	10	40	23,00€

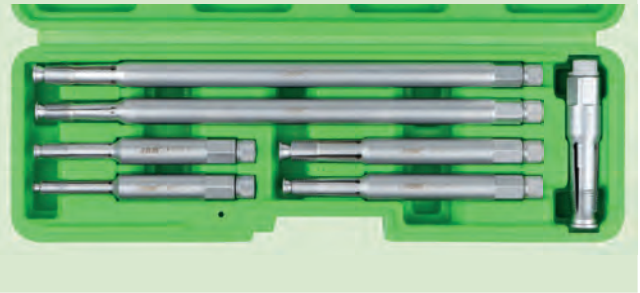

52833

39,30€

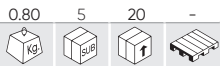

RADBOLZEN STECKSCHLÜSSEL SET 1/2"



ERSATZTEILVERFÜGBARKEIT

REF.	mm				€
14211	6mm	0.10	20	100	11,00€
14212	8mm	0.10	20	100	12,00€
14213	10mm	0.20	20	100	12,00€
14214	12mm	0.20	20	100	14,00€

53524

51,00€

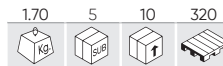

SET AUS 4 MUTTERNSPRENGER



ERSATZTEIL VERFÜGBAR

REF.	mm					€
14049	9-12 mm (1/8"- 1/2")	0.10	-	50	-	8,00€
14050	12-16 mm (1/2"- 5/8")	0.20	-	50	-	10,50€
14051	16-22 mm (5/8"- 7/8")	0.44	25	50	-	18,00€
14052	22-36 mm (7/8"- 1- 1/16")	0.65	-	20	-	19,50€

53652

53,00€



REPARATUR-SET FÜR GEWINDE VON RADBOLZEN

ERSATZTEILVERFÜGBARKEIT

REF.	BESCHREIBUNG				€
14340	ERSATZ GEWINDESCHNEIDER M12X1.25 - PSA (REF. 53652)	0.05	-	20	10,50€
14341	ERSATZ GEWINDESCHNEIDER M12X1.5 - MERCEDES BENZ / BMW (REF. 53652)	1.14	-	20	10,50€
14342	ERSATZ GEWINDESCHNEIDER M12X1.75 - VOLVO (REF. 53652)	1.12	-	20	10,50€
14343	ERSATZ GEWINDESCHNEIDER M14X1.5 - VAG (REF. 53652)	1.29	-	20	10,50€
14344	REPARATUR-SCHEIBEM12X1.25 (REF. 53652)	0.49	-	20	11,00€
14345	REPARATUR-SCHEIBE M12X1.5 (REF. 53652)	0.50	-	20	11,00€
14346	REPARATUR-SCHEIBE M14X1.5 (REF. 53652)	0.46	-	20	11,00€



SPEZIALWERKZEUG

54003

104,00€

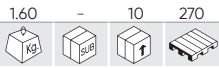

REPARATUR-KIT FÜR INNEN-UND AUßENGEWINDE



- x1 M14x1.5
- x1 M16x1.5
- x1 M18x1.5
- x1 M20x1.5
- x1 M22x1.5
- x1 M24x1.5
- x1 M27x2.0
- x1 M28x1.5



53665

19,00€

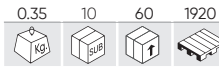

MOTORRAD-KETTENSCHNEIDER (25-60)



53666

28,00€

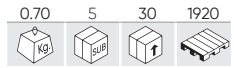

MOTORRAD-KETTENSCHNEIDER (60-100)



53054

6,00€

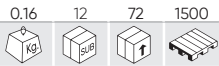

MOTORRAD SPEZIAL-STECKSCHLÜSSEL



53086

9,00€

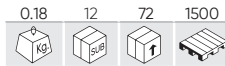

SCHLÜSSEL FÜR MOTORRÄDER



YAMAHA, KAWASAKI,
BMW, SUZUKI, HONDA

52454

12,90€

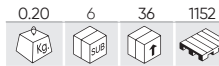

ABZIEHER FÜR WINDSCHUTZ-CHEIBENWISCHER



53664

38,00€

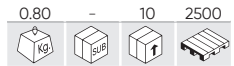

ABZIEHER FÜR RIEMENSCHLEIBEN - UNIVERSSELL



Schaft mit 16 mm Durchmesser,
Zentrierkugel und 24 mm
Sechskantschraubenkopf.

51125

88,00€

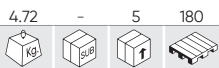

KUGELLAGER TRENNMESSER SET

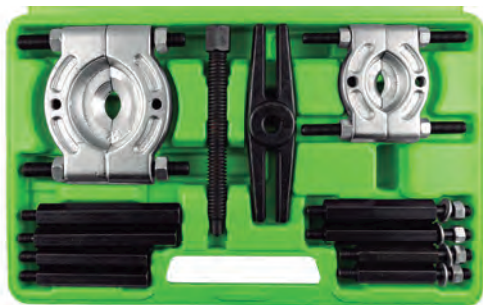

ZOLLSATZ:

- x2 1/4", mit 30 mm und 50 mm.
- x1 3/8" Schraube 9,5 x 125 - 24 UNF.
- x1 Nuss 3/8" x 16 UNC.

2 ZOLLSATZ:

- x1 1/4"-3-1/2", 50 x 75 mm.
- x1 1/2" Schraube 12,7 x 135 - 20 UNF.
- x1 Nuss 3/8" x 16 UNC.

KUGELLAGER TRENNMESSER

REF.	BESCHREIBUNG	Kg	Vol	H	P	€
52626	75-105mm	3.65	-	5	800	46,00€
52627	105-150mm	6.50	-	2	231	120,00€



2-ARM ABZIEHER

REF.	BESCHREIBUNG	—	I					€
52727	2-ARM ABZIEHER - 25-70MM	25-70mm	50mm	0.20	10	60	1200	34,60€
52728	2-ARM ABZIEHER 25-130MM	25-130mm	110mm	1.20	5	10	500	68,00€
52729	2-ARM ABZIEHER 60-200MM	60-200mm	160mm	3.26	-	3	240	128,00€
52730	2-ARM ABZIEHER 80-350MM	80-350mm	225mm	8.55	-	2	108	288,00€

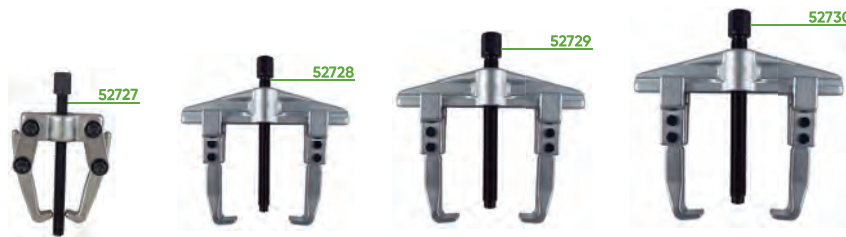

REF.	BESCHREIBUNG					€
53146	PRÄSENTIERSTÄNDER FÜR ABZIEHER	0.70	5	10	140	30,50€

3-ARM ABZIEHER

REF.	BESCHREIBUNG	—					€
52731	3-ARM ABZIEHER 50-100MM	50-100mm	0.90	4	24	504	38,00€
52732	3-ARM ABZIEHER 70-150MM	70-150mm	2.54	5	20	200	58,00€
52733	3-ARM ABZIEHER 95-200MM	95-200mm	5.20	-	4	112	98,00€



2-3 ARM ABZIEHER AUSWECHSELBAR

REF.	BESCHREIBUNG	T					€
52010	2-3 ARM ABZIEHER 2T	2T	0.50	4	40	360	80,00€
52296	2-3 ARM ABZIEHER 5T	5T	1.57	4	8	120	119,00€
52297	2-3 ARM ABZIEHER 7T	7T	3.33	-	6	36	172,00€
52298	2-3 ARM ABZIEHER SET, LANG UND KURZ	2T	2.65	3	6	396	177,00€



53701

188,00€

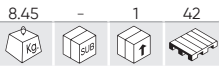

LAGER-ABZIEHER MIT 2-3 AUSTAUCHBAREN GREIFERN

- Betriebsbereich 2 Füße: 45-120mm.
- Betriebsbereich 3 Füße: 50-130mm.
- Spanntiefe: 100, 200, 250 mm.

LIEFERUMFANG

Zentrale Führung für 3 Füße.
 Zentrale Führung für 2 Füße.
 Stift: 275mm.
 Stift: 165mm.
 Lange Füße mit Mitnahmen: 250mm.
 Mittlere Füße mit Mitnahmen: 200mm.
 Kurze Füße mit Mitnahmen: 100mm.

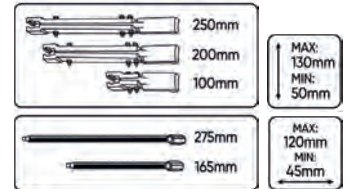

REF. BESCHREIBUNG

REF.	BESCHREIBUNG	Kg	SUB	↑	€
14611	GREIFERENDE FÜR REF.53701	0.10	-	50	12,00€
14612	SPINDEL 165 MM FÜR REF.53701	0.15	-	20	11,00€
14613	SPINDEL 275 MM FÜR REF.53701	0.30	-	20	13,50€

53062

99,00€

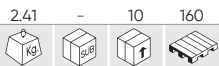

LAGER-ABZIEHER MIT KUGELENDEN

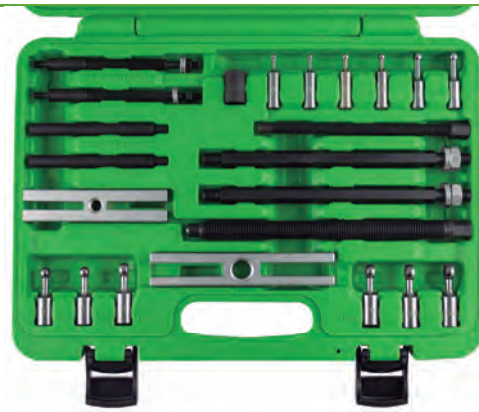

51140

64,00€



ABZIEHER MIT GEWINDE FÜR KURBELWELLENRIEMENSCHLEIBE

- Vorbestimmt zum Fixieren der Scheibe der Kurbelwelle beim Abbauen.
- Ermöglicht die Einstellung der Mittelwelle während der Koppelung.
- Der in der Mitte liegende Schraubenstab wird für die Verriegelung der Scheibe verwendet.
- Klemmschrauben: M6, M8.



51500

29,00€



ABZIEHER FÜR RIEMENSCHLEIBEN

- Geeignet für die Nutzung in Kurbelgehäusen, Stromerzeugermaschinen, Klimaanlage-Modulen und Wasserpumpe.
- Niederprofilhebel gewähren den ungehinderten Zugang zu den schwer zugänglichen Stellen des Motors.
- Ist bestimmt zum Abbauen von gerippten, verstopften Kurbelgehäusen und zusätzlichen Scheiben.



40-168mm

52494

227,00€

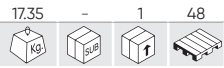

MONTAGE/DEMONTAGE-SET FÜR LAGER, NABE, SILENTLOCK

- Satz aus 30 Teilen für Demontage und Montage von Radnaben, Lagern und Silentblock usw.
- Universale Anwendung sowohl für PKWs, als für LKWs.
- Baugrößen: M10, M12, M14, M16, M18.

ADAPTER (AUSSEN-/INNENDURCHMESSER):

90/80, 85/75, 82/72, 80/70, 78/68, 76/66, 74/64, 72/62, 70/60, 68/58, 66/56, 64/54, 62/52, 60/50, 58/48, 56/46, 54/44, 52/42, 50/40, 48/38, 46/36, 44/34

REF. BESCHREIBUNG	Kg	Stk	Paletten	€
12926 M10 ERSATZSCHRAUBE FÜR REF. 52494	0.46	- 20	1500	21,50€
12927 M12 ERSATZSCHRAUBE FÜR REF. 52494	0.52	- 20	-	21,50€
12928 M14 ERSATZSCHRAUBE FÜR REF. 52494	0.60	- 30	1500	22,00€
12929 M16 ERSATZSCHRAUBE FÜR REF. 52494	0.66	- 20	-	23,00€
12930 M18 ERSATZSCHRAUBE FÜR REF. 52494	0.89	- 30	-	23,50€



51124

88,00€

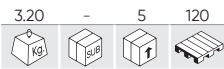

LAGER-ABZIEHER

5 PCS

UNIVERSAL



LIEFERUMFANG

- Universale Abziehvorrichtung (38,5mm).
- 3/8"-1/2" Adapter (10-14 mm).
- 9/16"-11/16" Adapter (15-19 mm).
- 5/8"-1" Adapter (18-25 mm).
- 1"-1-1/4" Adapter (25-32 mm).

52624

28,00€

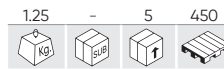

ABZIEHER FÜR RIEMENSCHLEIBEN - LENKRAD

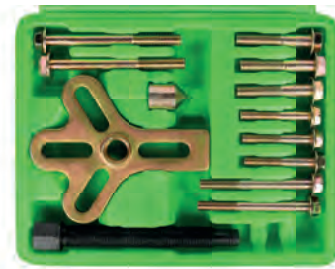

- x2 Schraube 5/16", 4"
- x2 Schraube 1/4", 3"
- x3 Schraube 5/16", 2"
- x3 Schraube 1/4", 2"
- x1 5" Anschlagsschraube aus aluminiumre-gierung
- x1 3/4 Drehbare spitze

53058

193,00€

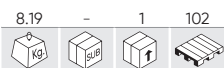

MONTAGESCHLEIBEN SET FÜR LAGER



- x49 Ø 18, 19, 20, 21, 22, 23, 24, 25, 26, 27, 28, 29, 30, 31, 32, 33, 34, 35, 36, 37, 38, 39, 40, 41, 42, 43, 44, 45, 46, 47, 48, 49, 50, 51, 52, 53, 54, 55, 56, 57, 58, 59, 60, 61, 62, 63, 64, 65, 74mm
- x1 Metallgriff mit einem Durchmesser von Ø12mm

53056

127,00€



MONTAGE/DEMONTAGE-SET FÜR LAGER



- x9 Ø 55.5, 59, 62, 65, 66, 71.5, 73, 78, 84mm
- x2 Ø 75.5, 83mm
- x1 Ø 69mm
- x1 295mm

SPEZIALWERKZEUG

52551

151,00€

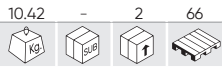

MONTAGE-/DEMONTAGE-SET FÜR LAGER

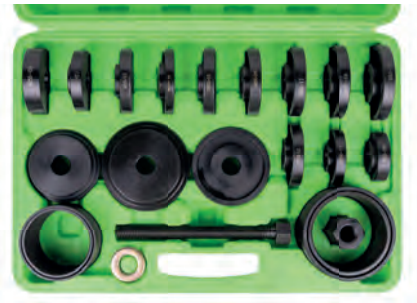

- x13** Scheibengrößen: 50, 55, 60, 64, 67, 70, 72, 74, 75, 78, 82, 84, 88 mm
- x4** Zylinder: 76, 82, 92, 101 mm
- x1** Bolzen: 32 mm
- x1** Mutter: 38 mm
- x1** Verstärkte Schraube zur Verwendung mit Schlagwerkzeug.
- x1** Welle aus Stahlphosphat zum Schutz vor Korrosion.

53463

98,00€

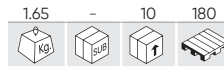

DEMONTAGE-SET FÜR WINDSCHUTZSCHEIBENWISCHER



- VW: Polo, Lupo, Touareg , Porsche Cayenne.
- Opel: Astra G, Zaphira B, Corsa C, Vectra C.
- Honda: Jazz, CRV, FRV, Accord, Turnier.
- BMW: 5er Modell ab E 39 bis Baujahr 2005. 7er Modell ab E 38 bis Baujahr 2005
- Audi: A3, A4, A5, A6. Audi Q7.
- Ford: Galaxy, Alhambra.
- Mercedes: A-Class, B-Class.

51349

37,30€

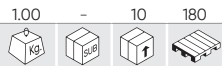

MONTAGE-SET FÜR LAGER

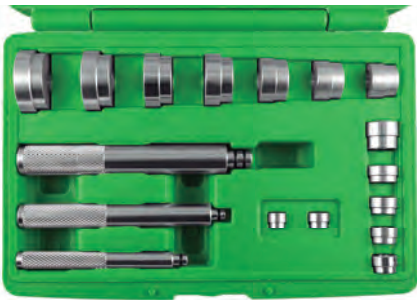

- x13** 42 - 38mm, 40 - 35mm, 36 - 32mm, 30 - 28mm, 24 - 22mm, 27 - 25mm, 18 - 16mm, 20 - 18mm, 22 - 20mm, 12 - 10mm, 14 - 12mm, 16 - 14mm, 17 - 15mm

53059

52,00€

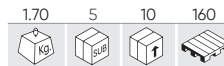

MONTAGE-SET FÜR LAGER UND DICHTUNGEN



- x9** Ø 39,5, 44,5, 50, 59, 63, 65, 72, 76, 81mm

52056

66,00€



1" STECKSCHLÜSSEL SET FÜR DREHMOMENTVERVIELFÄLTIGER - 8 TEILE

ERSATZTEILVERFÜGBARKEIT

REF.	BESCHREIBUNG	Kg	Boxen	Stück	€
16385	1" STECKSCHLÜSSEL FÜR DREHMOMENTVERVIELFÄLTIGER, 22MM IN SET REF. 52056	0.50	-	50	10,00€
16386	1" STECKSCHLÜSSEL FÜR DREHMOMENTVERVIELFÄLTIGER, 24MM IN SET REF. 52056	0.45	-	50	11,50€
10674	1" STECKSCHLÜSSEL FÜR DREHMOMENTVERVIELFÄLTIGER, 27MM IN SET REF. 52056	0.59	-	50	9,50€
10675	1" STECKSCHLÜSSEL FÜR DREHMOMENTVERVIELFÄLTIGER, 30MM IN SET REF. 52056	0.55	-	50	9,50€
10672	1" STECKSCHLÜSSEL FÜR DREHMOMENTVERVIELFÄLTIGER, 32MM IN SET REF. 52056	0.66	-	50	9,50€
10673	1" STECKSCHLÜSSEL FÜR DREHMOMENTVERVIELFÄLTIGER, 33MM IN SET REF. 52056	0.67	-	50	9,50€
16388	1" STECKSCHLÜSSEL FÜR DREHMOMENTVERVIELFÄLTIGER, 38MM IN SET REF. 52056	0.70	-	50	11,50€
16389	1" STECKSCHLÜSSEL FÜR DREHMOMENTVERVIELFÄLTIGER, 41MM IN SET REF. 52056	0.75	-	-	11,50€



TIMING TOOLS-KITS

- 244 FIAT/ALFA ROMEO
- 249 BMW/MINI
- 258 PSA
- 261 FORD
- 267 JAGUAR/LAND ROVER
- 269 JEEP/CHRYSLER
- 270 MERCEDES-BENZ
- 273 RENAULT/DACIA/NISSAN
- 278 OPEL/VAUXHALL
- 283 VAG
- 295 SONSTIGES
- 297 HILFSWERKZEUGE



53303

89,00€

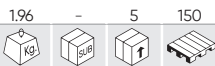

MOTOREINSTELLUNG WERKZEUG SET FIAT / OPEL

MODELLE	FIAT: 1.9D/JTD (MOTOR PEUGEOT), 2.4D. ALFA ROMEO: 145, 146, 156 JTD. GM: GM 1.3, 1.6, 1.9, 2.0, 2.4 CDTI (2004 -).
OEM WERKZEUG	EN-46789 (1), EN-46789-100 (2), EN-46785 (3), EN-46788 (4), EN-46781 (5), EN-46789 (6)
MOTORCODES	GM: K1.3 CDTI Z13DT COMMON RAIL ENGINE. 1.9 CDTI / 04-12 - Z19DT Z19DTH Z19DTJ Z19DTL 2.0 CDTI / 08-12 - A20DT LBS / LBX / LBY / LCD.V SAAB: 1.9 TID.

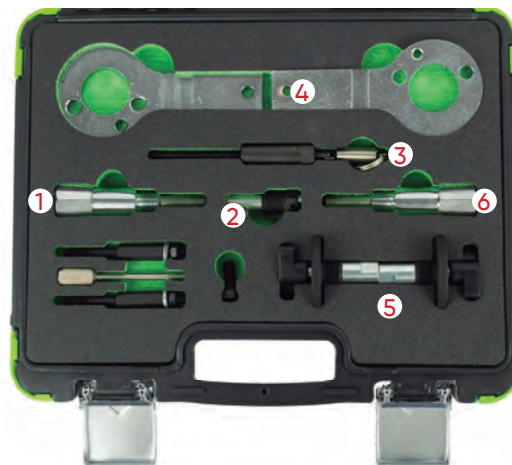

53304

279,00€

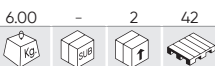

MOTOREINSTELLUNG WERKZEUG SET FIAT

MODELLE	FIAT
OEM WERKZEUG	1 860 874 000 (1), 1 860 895 000 (2), 1 860 898 000 (3), 1 860 905 000 (4), 1 860 845 000 (5)
MOTORCODES	PETROL: FIAT BRAVA , BRAVO, BARCHETTA, CARGO, COUPE, MAREA, PALIO, WEEKEND, PUNTO, MULTILA, STILO, IDEA, DO- BLO TWIN CAM ENGINES - 1.2, 1.4, 1.6, 1.8, 16V GASOIL: FIAT BRAVA, BRAVO, MAREA, WEEKEND, PALIO, PUNTO, MULTIPLA, DOBLO, ULYSSE, DUCATO, STILO JTD DIESEL ENGI- NES - 1.9D/TD . 1.9JTD . 2.4TD/JTD.

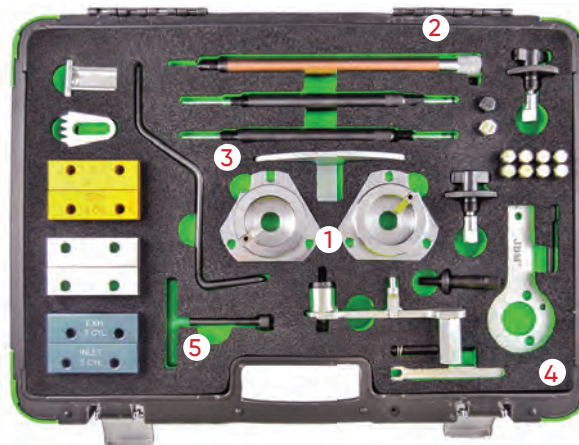

53306

53,00€

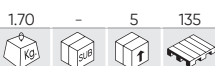

MOTOREINSTELLUNG WERKZEUG SET FIAT 1.2 16V

MODELLE	FIAT: FIAT 1.2L 16V, FIAT PUNTO / BRAVA / BRAVO / STILO
OEM WERKZEUG	1860992000 (1) (2), 1871000900 (3), 1860987000 (4), 186985000 (5)
MOTORCODES	176 B9.000, 182 B2.000, 188 A5.000

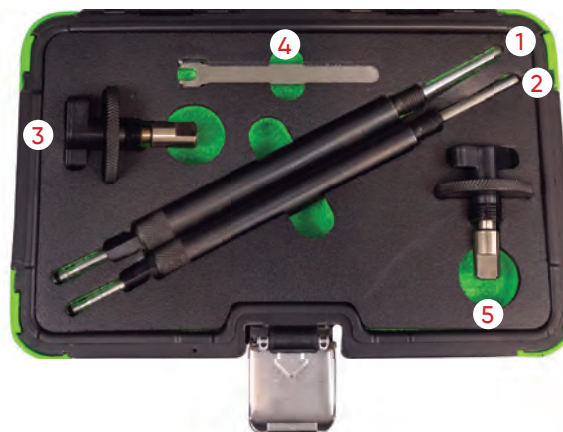

53308

55,00€

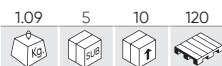
**MOTOREINSTELLUNG WERKZEUG SET ALFA ROMEO**

MODELLE	ALFA ROMEO: 145,146,147,155,156, 1.4 1.6 1.8 2.0 TS, 1.4/1.6 16V; 145/146/147/155/156 (96-10), 1.8 16V; 145/146, (96-01), 155/156 (96-06), SPIDER/GTV (98-05), 2.0 16V; 145/146 (96-01), 147 (01-10), 155/156 (95-02), 166 (98-07), SPIDER/GTV (96-05), PÚRPURA / PURPLE: 1.4, 1.6 // AZUL / BLUE: 1.8, 2.0
OEM WERKZEUG	1822149000 (1), 1822154000 (2), 1825041000 (3), 1825042000 (4)
MOTORCODES	Z1.4/1.6-321.02, 321.03, 321.04, 335.03, 676.01 1.8/2.0-323.01, 672.04, 162.01, 323.10, 671.06, 322.01, 671.02, 322.05, 341.03, 363.01.

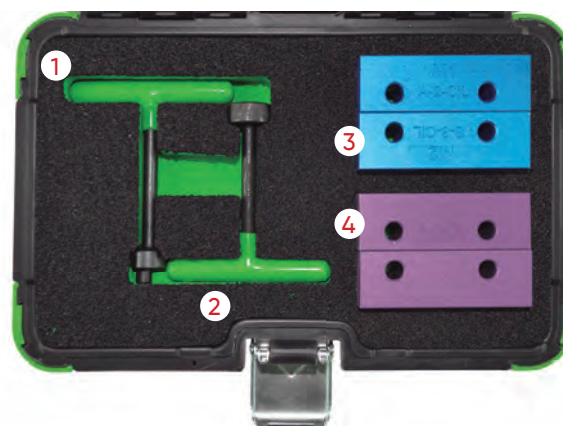
**53309**

285,00€

**MOTOREINSTELLUNG WERKZEUG SET ALFA / FIAT / LANCIA 1.4, 1.6, 1.8, 2.0 16V**

MODELLE	ALFA ROMEO: 145,146,147,155,156, 1.4 1.6 1.8 2.0 TS, 1.4/1.6 16V; 145/146/147/155/156 (96-10), 1.8 16V; 145/146, (96-01), 155/156 (96-06), SPIDER/GTV (98-05), 2.0 16V; 145/146 (96-01), 147 (01-10), 155/156 (95-02), 166 (98-07), SPIDER/GTV (96-05), PURPUR: 1.4, 1.6 // BLAU: 1.8, 2.0 FIAT: BARCHETTA (96-00), BRAVA (95-00), BRAVO (95-0 0), COUPE (96-01), MAREA (96-00), MAREA WEEKEND (96-00), PUNTO/PUNTO CLASSIC (99-06), STILO (01-08) LANCIA: DEDRA (95-99), DELTA (96-99), KAPPA (98-02), LYBRA (99-06).
OEM WERKZEUG	1.4 16V: 335.03 1.6 16V: 321.02, 321.03, 321.04, 372.03, 676.01 1.8 16V: 322.01, 322.05, 671.06, 182A2.000, 183A1.000, 183A6.000, 188A6.000, 192A4.000 2.0 16V: 162.01, 323.01, 323.1, 341.03, 363.01, 672.04 2.0 20V: 175A3.000, 182A1.000, 182B7.000, 185A8.000.

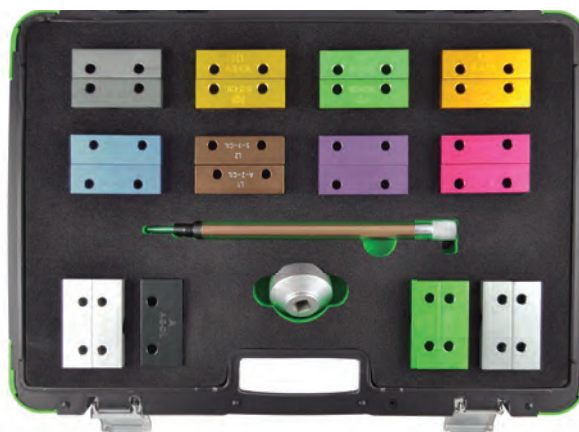
**53310**

498,00€

**MOTOREINSTELLUNG WERKZEUG SET FIAT / ALFA / LANCIA**

MODELLE	ALFA FIAT LANCIA	ALLA, BARCHETTA, BRAVO, BRAVA, COUPE, DELTA, DEDRA, PUNTO, SPIDER, GT
OEM WERKZEUG	1860845000 (1), 1822154000 (2), 1860905000 (3), 1860992000 (4), 1860895000 (5), 1860874000 (6), 1860985000 (7), KM571A (8), 1860896000 (9), 0153A (10)	
MOTORCODES	1.2 / 16V, 1.4 / 12V, 1.6 / 16V, 1.6 ECO. 1.8, 2.0 / 16V, 2.0 / 20V, 2.4 / 20V, 3.0 / V6.	



53312

127,00€

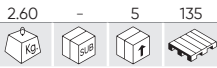

MOTOREINSTELLUNG WERKZEUG SET FIAT / ALFA / FORD

MODELLE	FIAT: NEW 500 (07-09), IDEA (04-09), LINEA (07-09), GRANDE PUNTO (07-09), DOBLO 1 CARGO (05-09), PANDA EV02 (05) FORD: KA 1.2 DURATEC (09) ALFA ROMEO
OEM WERKZEUG	1 860 987 000 (1), 2 000 004 400 (2), 2 000 015 800 (3), 2 000 004 300 (4), 2 000 004 500 (5)
MOTORCODES	1.2: 169A4.000 / 199A4.000 . 1.4: 350A 1.000 / 188A4.000-EV02.

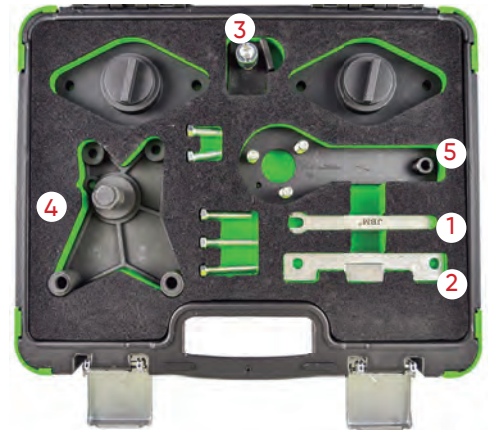

53319

18,00€

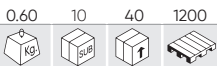

MOTOREINSTELLUNG WERKZEUG SET FIAT PEUGEOT / CITROËN 2.3JTD, 3.0JTD HDI

MODELLE	FIAT: 2.3 / 3.0 JTD. IVECO: DAILY.
OEM WERKZEUG	99360614, 1860 617 000, 99360615, 2 000 018 200.
MOTORCODES	F1AE0481C, F1AE0481D, F1AE0481N, F1CE0481A/D.

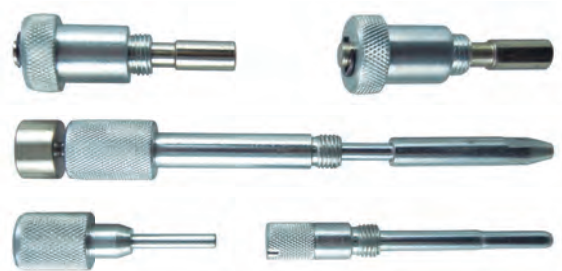

54202

68,00€



WERKZEUGSATZ FÜR MOTORSTEUERUNG FÜR FIAT/ALFA ROMEO/LANCIA

MODELLE	ALFA ROMEO: GIULIETTA (10-14), MITO (08-17). FIAT: 500 (07-19), 500L (12-19), 500C (07-19), 500 ABARTH (08-17), BRAVO (07-14), BRAVA/BRAVO (98-02), DOBLO/DOBLO CARGO (10-19), EGEA (15-20), GRANDE PUNTO (07-10), GRANDE PUNTO ABARTH (07-10), IDEA (04-12), LINEA (07-10), MAREA/WEEKEND (98-00), PALIO WEEKEND (01-06), PANDA (07-11), PUNTO (97-08), STILO (01-08), TIPO (15-20). LANCIA: DELTA (08-12), MUSA (04-13), YPSILON (96-11).
OEM WERKZEUG	2.000.004.500 (1), 1.860.985.000 (2), 1.860.992.000 (3), 1.860.987.000 (4), 2.000.015.800 (5)
MOTORCODES	1.2 16V:176B9.000, 182B2.000, 188A5.000. 1.4 16V / T-JET: 169A3.000, 192B2.000, 198A1.000, 198A4.000, 199A6.000, 198A8.000, , 312A1.000, 312A3.000, 843A1.000, 955A1.000.

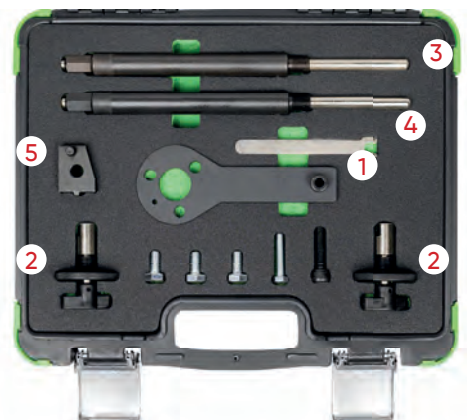

54203

91,00€

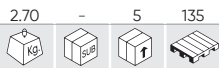

WERKZEUGSATZ FÜR MOTORSTEUERUNG FÜR ALFA ROMEO/LANCIA 1.8 TBI

MODELLE	ALFA ROMEO: 159(09-12), BRERA(09-11), GIULIETTA(10-19), SPIDER(09-11), 4C(13-19). LANCIA: DELTA(09-14).
OEM WERKZEUG	2 000033500 (1), 2000 003000 (2), 1860898 000 (3).
MOTORCODES	ALFA ROMEO 1,75 TBI: 939B1.000, 940A1.000, 940B2.000, 960A1.000 LANCIA 1,75 DI TURBO JET: 939B1.000

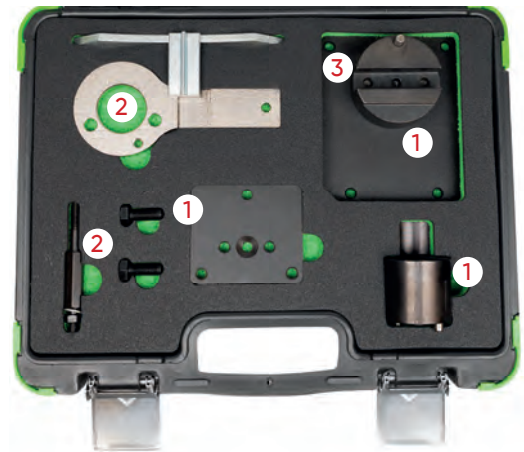

54211

74,00€

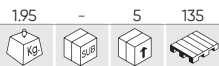

WERKZEUGSATZ FÜR MOTORSTEUERUNG FÜR FIAT/FORD/OPEL/SUZUKI 1.3L

MODELLE	FIAT: PUNTO (2003-2007) / PANDA (2003-2009) / IDEA (2004-2006) / DOBLO (2004-2006). FORD: KA. VAUXHALL / OPEL: AGILA (2003-2008) / CORSA C (2003-2007) / CORSA D (2006-2009) / COMBO C (2003-2009) / ASTRA H (2004-2009) TIGRA B (2004-2009) / MERIVA (2004-2009). SUZUKI: IGNIS (2003-2009) / WAGON R (2003-2009) / SWIFT (2003-2010).
OEM WERKZEUG	1871000200 / 303-1469 / KM-662-C (1), EN 46785 / KM 955 / 09912-38300 (2), 1871000900 / 1860985000 / 303-1472 / EN 46781 / 09917-68610 (3), 1870900400 (4), 1870900300 / 303-1468 (5)
MOTORCODES	FIAT: 1.3 JTD 188A9.000 / 169A.000 / 188A8.000 / 199A3.000. FORD: 1.3 TDCI. VAUXHALL / OPEL: 1.3 CDTI Z13DT / Z13DTH / Z13DTJ. SUZUKI: 1.3 CDTI Z13DT.



54212

39,40€

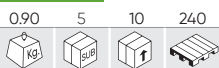

WERKZEUGSATZ FÜR MOTORSTEUERUNG FÜR FIAT/LANCIA 1,4 12V

MODELLE	MAREA/MAREA_WEEKEND(96-20), BRAVA(95-98), BRAVO(95-98). LANCIA: YPSILON(96-20)
OEM WERKZEUG	1860899000 (1), 1860901000 (2)
MOTORCODES	1.4 12V : 182A3.000, 182A5.000.



54215

57,00€

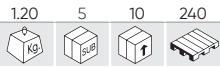

WERKZEUGSATZ FÜR MOTORSTEUERUNG FÜR ALFA ROMEO/FIAT 1.4 MULTI AIR

MODELLE	ALFA ROMEO GIULIETTA, MITO / FIAT PUNTO, PUNTO EVO 1.4 (TURBO) MULTI AIR (105/135/163/170PS)
OEM WERKZEUG	ALFA ROMEO / FIAT: 1860987000 (1), 2000034400 (2), 2000004500 (3)
MOTORCODES	940A2.000 / 940A2.000 / 955A8.000 / 955A8.000 / 940A2.000 / 955A8.000 / 955A2.000 / 955A7.000 / 955A6.000 / 955A8.000



54216

49,00€



WERKZEUGSATZ FÜR MOTORSTEUERUNG FÜR FIAT/OPEL/ALFA 1.9, 2.4L 16V

MODELLE	OPEL 1.9, ALFA-ROMEO 1.9-2.4 L DIESEL, FIAT 1.9- 2.4 L DIESEL
OEM WERKZEUG	OPEL EN-46788 / FIAT 1.860.905.000 / 1.860.905.010 (1) FIAT 1.860.898.000 (2) OPEL EN-46789 / FIAT 1.870.896.900 (3) OPEL KM 6130 / KM 6349 (4)
MOTORCODES	OPEL 1.9 CDTI Z19DT, Z19DTH, Z19DTJ ALFA-ROMEO 1.9 Y 2.4 L : 323.02, 371.01, 342.02, 325.01, 362.02, 182B9.000, 937A2.000, 937A3.000, 192A5.000, 192B1.000, 937A4.000, 937A5.000, 939A2.000, 939A1.000, 939A7.000, 939A8.000, 839A6.000, 841C.000 FIAT 1.9 Y 2.4 L : 182B4.000, 182B9.000, 185A6.000, 186A6.000, 186A8.000, 186A9.000, 188A2.000, 188A7.000, 188B2.000, 192A1.000, 192A3.000, 192A5.000, 192A8.000, 192A9.000, 192B4.000, 192B5.000, 198A2.000, 198A3.000, 198A6.000, 199A5.000, 223A7.000, 937A5.000, 939A1.000, 939A2.000, 939A3.000, 939A7.000



54430

34,00€

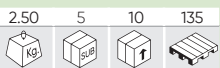

MOTOR-EINSTELLWERKZEUG SATZ FÜR ALFA ROMEO/FIAT/LANCIA 0.9 TWIN AIR

MODELLE	ALFA ROMEO: MITO (2001-2018) CHRYSLER: YPSILON (2011-2015) FIAT: 500/500C (2010-2020), 500L/500L LIVING/500L MPW (2012-2018), PUNTO (2012-2018), PANDA (2012-)) LANCIA: YPSILON (2011-2018)
OEM WERKZEUG	2 000 035 100 (1) 2 000 035 200 (2) 2 000 035 300 (3)
MOTORCODES	Q.9: 199B6.000, 199B7.000, 312A2.000, 312A4.000, 312A5.000, 312A6.000, 312A7.000

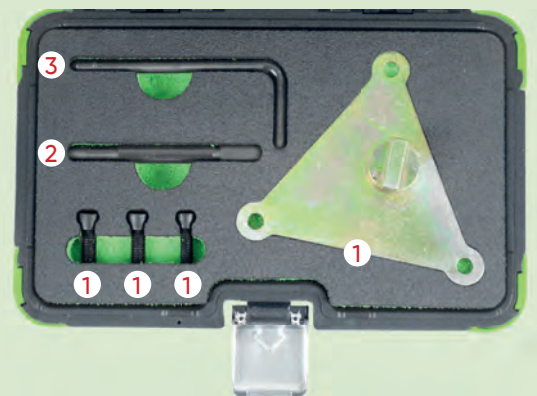

53259

97,00€

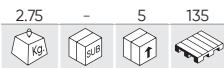

MOTOREINSTELLUNG WERKZEUG SET FÜR BMW N42, N46 1.8, 2.0 MIT DEM KETTENGETRIEBE

MODELLE	<p>BMW 1 SERIES: 118i E81/82/87/88 (04-14), 120i E81/82/87/88 (04-14).</p> <p>BMW 3 SERIES: 316i/TI COMPACT E46 (01-07), 318i/TI COMPACT E46 (01-07), 318i, E90/91/92/93 (05-12), 320i E90/91/92/93 (05-12).</p> <p>BMW 5 SERIES: 520i E60/61 (07-10), Z4 2.0 E85/86 (04-09).</p> <p>BMW X SERIES: X1 SDRIVE 18i E84 (10-12), X1 XDRIVE 18i E84 (10-12), X3 2.0 E83 (05-10).</p>
OEM WERKZEUG	119350 (1), 119340 (2), 119291 (3), 119292 (4), 119270 (5), 115120 (6), 119190 (7), 119293 (8)
MOTORCODES	1.8: N42; B18A, N46; B18. / 2.0: N42; B20A, N46; B20, B20B, N46T; B20, B20B, B20BD, B20BZ, B20O2, B2O2.



53260

168,00€

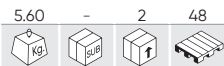

MOTOREINSTELLUNG WERKZEUG SET BMW N43 1,6/2,0 MIT DEM KETTENGETRIEB

MODELLE	<p>BMW 1 SERIES: 116i E81/82/87/88 (07-12), 118i E81/82/87/88 (06-14), 120i E81/82/87/88 (06-14).</p> <p>BMW 3 SERIES: 316i E90/91/92/93 (07-11), 318i E90/91/92/93 (07-13), 320i E90/91/92/93 (07-14).</p> <p>BMW 5 SERIES: 520i E60/61 (07-10).</p>
OEM WERKZEUG	118690 (118691/118692/118693) (1), 118710 (118711/118712) (2), 113340 (3) (4), 118700 (5), 119340 (119341/119342) (6), 115120 (7).
MOTORCODES	1.6: N43 B16A/AA, B16AA, B16AA/OO. 2.0: N43 B20A, B20A/AA, B20AA, B20AY, B20KO, B20UO.

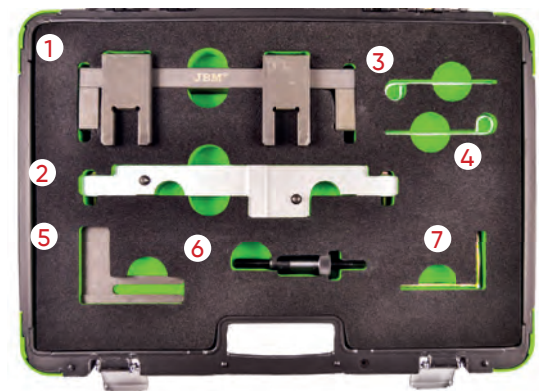

53261

214,00€

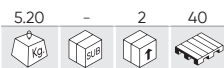

MOTOREINSTELLUNG WERKZEUG SET BMW N42, N46 1.8, 2.0

MODELLE	<p>BMW 1 SERIES: 118i E81/82/87/88 (04-14), 120i E81/82/87/88 (04-14).</p> <p>BMW 3 SERIES: 316i/TI COMPACT E46 (01-07), 318i/TI COMPACT E46 (01-07), 318i E90/91/92/93 (05-12), 320i E90/91/92/93 (05-14).</p> <p>BMW 5 SERIES: 520i E60/61 (07-10).</p> <p>BMW X SERIES: X1 E84 SDRIVE 18i (10-12), X1 E84 XDRIVE 18i (10-12), X3 E83 2.0 (05-10).</p> <p>BMW Z SERIES: Z4 2.0 E85/86 (04-09).</p>
OEM WERKZEUG	119190 (1), 119310 (2), 119302 (3)
MOTORCODES	2.0: N42 B18A, N42 B20A, N46 B18, N46 B20, N46 B20B, N46T B20, N46T B20B, N46T B20BD, N46T B20BZ, N46T B20O2, N46T B2O2

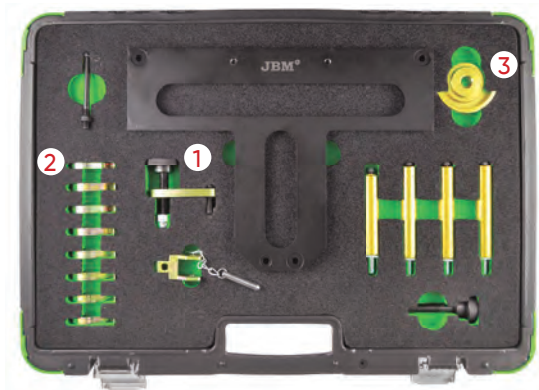

53262

251,00€

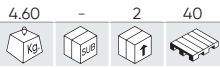

NOCKENWELLENEINSTELLUNGS SET BMW M52TU, M54, M56 MIT DEM SYSTEM DOUBLE VANOS

MODELLE	<p>M52TUB25: 1997-2001 E46 323i/323Ci/323Ti (M52T); 1998-2001 E39 523i (M52TU); 1998-2001 E36/7 Z3 (M52TU). M52TUB28: 1997-2001 E46 328i/328Ci (M52TU); 1997-2001 E36/7 Z3 2.8 (M52B28/Z3); 1998-2001 E39 528i (M52TU); 1998-2001 E38 728i (M52TU). M54B22: 2001-2003 E46 320i/320Ci; 2001-2003 E39 520i; 2001-2002 E36 Z3 2.2i; 2003-2005 E85 Z4 2.2i; 2003-2005 E60/E61 520i. M54B25: 2001-2002 E36/7 Z3 2.5i; 2001-2005 E46 325i/325Xi; 2001-2006 E46 325Ci; 2001-2004 E46 325Ti; 2001-2004 E39 525i; 2003-2004 E60/E61 525i/525Xi; 2004-2006 E83 X3 2.5i; 2004-2006 E85 Z4 2.5i. M54B30: 2001-2005 E46 330i/330Xi; 2001-2006 E46 330Ci; 2001-2003 E39 530i/2001-2002 E36 Z3 3.0i; 2003-2005 BMW E60 530i; 2003-2006 E85 Z4 3.0i; 2001-2006 E53 X5 3.0i.</p>
OEM WERKZEUG	116150 (1), 113450 (2), 113292 (3), 116180 (4), 114220(5)



53263

57,00€

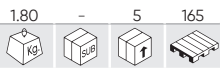

NOCKENWELLEN-BLOCKIERER SET BMW M47 LAND ROVER TD4,TD6

MODELLE	<p>BMW 1 SERIES: 118D E87 (04-07), 120D E87 (04-07). BMW 3 SERIES: 318D/TD COMPACT E46 (01-05), 318D/TD E90/91 (05-08), 320D/TD COMPACT E46 (98-05), 320D/CD E90/91 (05-08), 325D E90/91/92/93 (02-10), 330D/CD E46/90/91/92/93 (99-07), 335D E90/91/92 (06-11). BMW 5 SERIES: 520D E39/60/61 (00-09), 525D/XD E39/60/61 (00-10), 530D/XD E46/60/61 (98-10), 535D E60/61 (04-10). BMW 6 SERIES: 635D E63/64 (07-11). BMW 7 SERIES: 730D/LD E38/65/66 (98-08). BMW X SERIES: X3 2.0D E83 (04-07), X3 3.0D/SD E83 (03-10), X5 3.0D E53/E70 (00-10), X6 3.0D E71/72 (08-10), X6 3.5D E71/72 (08-10). LAND ROVER: FREELANDER TD4 (00-06), RANGE ROVER TD6 (02-06). MG/ROVER: MG-ZT/T (01-05), ROVER 75 CDT/CDTI (99-05). VAUXHALL/OPEL: OMEGA-B (01-03).</p>
OEM WERKZEUG	112300/12-108, 12-171/KM-813 (1), 113340/12-172/KM-823 (2) (3), 116322/12-174/KM-6267 (4) 116320 (5)
MOTORCODES	<p>BM - 2.0D: M47, M47T2, M47TU / 2.5D: M57, M57T2, M57TU / 3.0D: M57, M57T2, M57TU LAND ROVER - 2.0D: 204D3 (TD4) / 3.0D: 306D1 (TD6) MG/ROVER- 2.0D: M47R / 2.0D CDT: M47R VAUXHALL/OPEL- 2.5D: Y25DT</p>



53264

143,00€

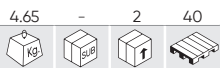

MOTOREINSTELLUNG WERKZEUG SET BMW N62, N73

MODELLE	<p>BMW 5 SERIES: 540i E60/61 (05-10), 545i E60/61 (03-06), 550i E60/61 (05-10). BMW 6 SERIES: 645i E63/64 (03-06), 650i E63/64 (05-11). BMW 7 SERIES: 735i E65/66 (02-05), 740i E65/66 (05-10), 745i E65/66 (02-05), 750i E65/66 (05-08), 760i E65/66 (02-08). BMW X SERIES: X5 4.4 E53 (03-07), X5 4.8 E53/E70 (04-10).</p>
OEM WERKZEUG	119463 (1), 119462 (2), 119340 (3), 119461 (4), 119190 (5)
MOTORCODES	<p>3.6 V8: N62 B36A 4.4 V8: N62 B44A 4.0 V8: N62 B40A 4.8 V8: N62 B48B 6.0 V12: N73 B60A</p>

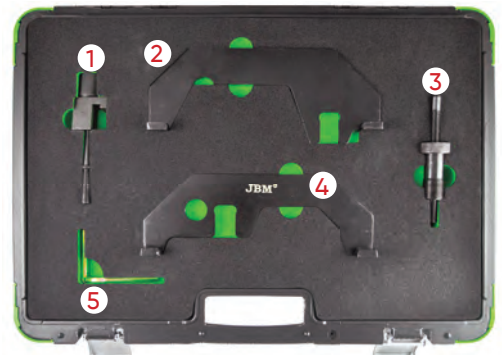

53265

195,00€

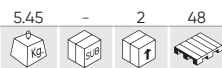

MOTOREINSTELLUNG WERKZEUG SET BMW DIESEL M47, M57, M41, M51

MODELLE	BMW
OEM WERKZEUG	113360 (1), 116321 (2), 135190 (3), 135191 (4), 135192 (5), 116322 (6), 112300 (7), 113340 (8)
MOTORCODES	M41 / M51 / M47TU / M47TU T2. M57TU T2 3.01 1998 - 2008.

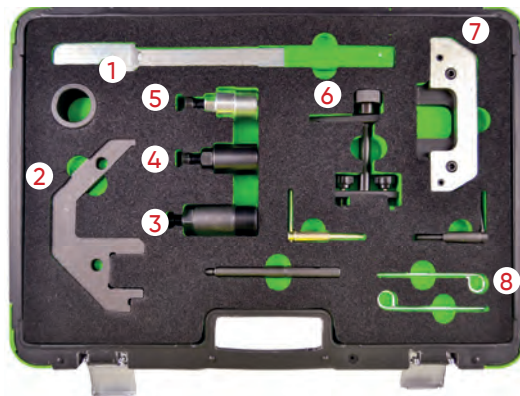
**53266**

224,00€



MOTOREINSTELLUNG WERKZEUG SET BMW M42, M43, M50, M51, M52

MODELLE	BMW
OEM WERKZEUG	113240 (1), 115490 (2), 113190 (3), 112300 (4) (5), 113292 (6), 113320 (7)
MOTORCODES	PETROL: M42, M43, M50, M52, M60. DIESEL: M51

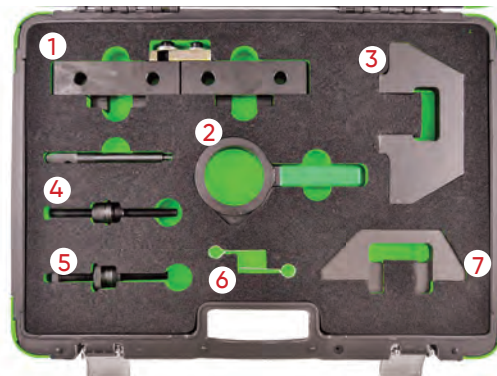
**53267**

277,00€



MOTOREINSTELLUNG WERKZEUG SET BMW M40, M43, M42, M44, M52, M54, M56

MODELLE	BMW SERIES: 3, 5, 7, X, Z
OEM WERKZEUG	114220 (1), 112300 (2), 113240 (3), 115490 (4), 113292 (5), 113450 (6)
MOTORCODES	M40. M44. M50. M52. M54. M56.

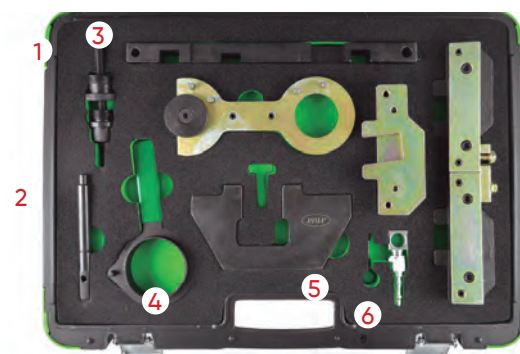

53269

50,00€

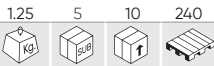

MOTOREINSTELLUNG WERKZEUG SET BMW N47, N47S, N57

MODELLE	<p>BMW 1 SERIES: 116D E81/82/87/88 (08-12), 118D E81/82/87/88 (07-14), 120D E81/82/87/88 (07-14), 123D E81/82/87/88 (07-14).</p> <p>BMW 2 SERIES: 218D (11-14), 220D (11-14), 225D (11-14).</p> <p>BMW 3 SERIES: 316D E90/91/92/93 (09-12), 318D E90/91/92/93 (07-12), 320D E90/91/92/93 (07-12), 325D E90/91/92/93 (10-14), 330D/XD E90/91/92/93 (08-14).</p> <p>BMW 5 SERIES: 520D E60/61 (07-10), 525D F10/11 (10-12), 530D F10/11 (10-13), 530DGT F07 (09-12), 535D F10/11 (10-17), 535DGT F07 (10-12).</p> <p>BMW 7 SERIES: 730D/LD F01/02/04 (08-12), 740D F01/02/04 (09-12), 740D XDRIVE F01/02/04 (09-12), 750D XDRIVE F01/02/04 (12-15).</p> <p>BMW X SERIES: X1 SDRIVE 18D E84 (09-15), X1 SDRIVE 20D E84 (09-12), X1 XDRIVE 18D E84 (09-15), X1 XDRIVE 20D E84 (09-15), X1 XDRIVE 23D E84 (09-12), X3 2.0D E83 (07-10), X3 XDRIVE 18D E83 (08-10), X3 XDRIVE 30D E83 (11-12), X3 XDRIVE35D F25 (11-17), X5 3.0D E70 (10-13), X5 XDRIVE 40D X5 F15 M50D (13-17), E70 (10-13), X6 XDRIVE 30D E71/72 (10-14), X6 XDRIVE 40D E71/72 (10-14), X6 F16 M50D (14-17).</p> <p>BMW MINI: PACEMAN (13-17), COUNTRYMAN (10-17), MINI (10-15), ROADSTER (12-14), CLUBMAN (10-14), CLUBVAN (12-14).</p>
OEM WERKZEUG	118760 (1), 118740 (2), 116480 (3), 115320 (4)
MOTORCODES	<p>1,6 D: N47; C16K1, C16U1.</p> <p>2,0 D: N47; C20K1, C20U1N47; D20, D20A, D20B, D20D, D20K1, D20O0, D20O1, D20T1, D20U0, D20U1, N47S D20T0, N47T; D20, D20O1, D20U1.</p> <p>3,0 D: N57; B30B, B30B/T0, B30C, D30BT0, D30O0, D30O1, D30T0, D30T1, D30U0.</p>



54206

113,00€

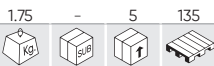

WERKZEUGSATZ FÜR MOTORSTEUERUNG FÜR BMW/MINI 1.5, 2.0L

MODELLE	<p>BMW</p> <ul style="list-style-type: none"> - 1 SERIES - 114D, 116D, 214D - (F20/ 21) - (2015- 2017) - 2 SERIES - 216D, 118D, 125D - (F22/ 23/ 45/ 46) - (2014-2017) - 3 SERIES - 218D, 220D, 225D - (F30/31/34) - (2015-2017) - 4 SERIES - 316D/320D/325D - (F32, 33, 36) - (2015-2017) - 5 SERIES - 420D, 425D, 418D - (F10, 11) - (2014-2017) - X1 SERIES - 518D - (F48) - (2015-2017) - X3 SERIES - (F25) - (2014-2017) - EFFICIENT DYNAMICS - X4 SERIES - (F26) - (2014-2017) - XDRIVE - X5 SERIES - (F15) - (2015-2017) - SDRIVE <p>MINI</p> <ul style="list-style-type: none"> - CLUBMAN - (F54) - (2015-2017) - ONE D CONVERTIBLE - (F57) - (2016-2017) - COOPER D/ SD MINI HATCH (F55, 56) - (2014-2017)
OEM WERKZEUG	114120 (1), 2347904 (2), 2365488 (3), 2288380 (4), 118760 (5), 118740, 118030 (6)
MOTORCODES	<p>1.5: B37 D15A, B37 C15A</p> <p>2.0: B47 D20A, B47 D20B, B47 C20A, B47, B47 C20B</p>

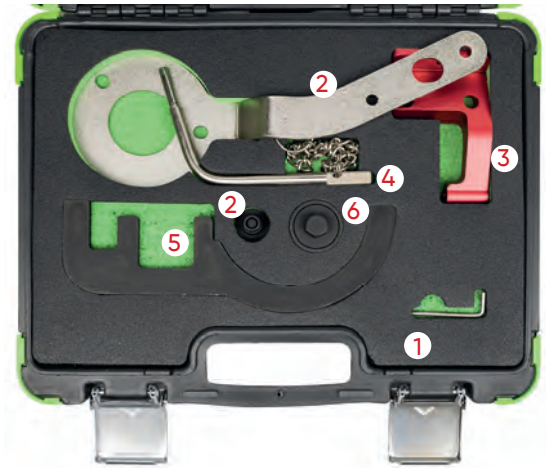

IHR TIMING TOOL SET NOCH NÄHER

GEBEN SIE DEN CODE DES ORIGINALWERKZEUGS ODER DEN MOTORCODE IHRES FAHRZEUGS IN IHREN WEBBROWSER EIN UND FINDEN SIE IHR KOMPATIBLES STEUERGERÄT

54219

60,00€

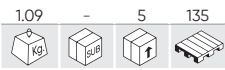

WERKZEUGSATZ FÜR MOTORSTEUERUNG FÜR BMW/MINI/CITROËN/PEUGEOT

MODELLE	BMW MINI PSA
OEM WERKZEUG	115140 (1), 119280 (2), 119330 (3), 113340 (4), 114360 (5)
MOTORCODES	BMW 1.6 (N40 / N45 / N45T, B16, B16A, B16AC) 1.8 / 2.0 (N42 / N46 / N46T) 2.0 / 3.0 (N51 / N52 / N52-COMPONENTE / N53 / N54) PSA 1.4 / 1.6 16V (EP3 / EP6 / EP6DT / EP6DTS) MINI 1.4 / 1.6 (N12 / N14)



54222

59,00€

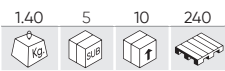

WERKZEUGSATZ FÜR MOTORSTEUERUNG FÜR MINI 1.6

MODELLE	BMW: MINI COOPER S(07-10) PEUGEOT: 207(06-10), 307(06-10), GT(06-10), THP(06-10), GTI(06-10) CITROËN: DS3(06-10), C4(06-10), GRANDE PICASSO TPH(06-10)
OEM WERKZEUG	119550(1), 119551(2), 119552(3), 119590(4)
MOTORCODES	N14 B16A , N14 B16CD , N14 B16TO

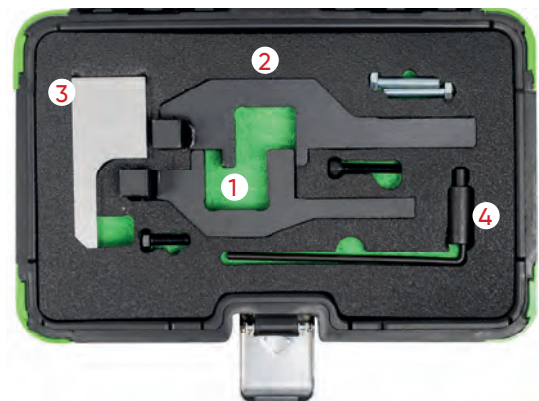

54227

122,00€

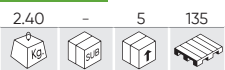

WERKZEUGSATZ FÜR MOTORSTEUERUNG FÜR BMW/MINI N13, N18, PSA

OEM WERKZEUG	EN-52127-2, EN-52588, E1 100, G 1376A, T10550/2, T10550/3, 0 496 709, 0109 2B, 0197 A11, 0197 A3, 0197 A31, 0197-A1, 0197-A1Z, 0197-A11, 0197A2, 0197-A31, 0197-A32, 0197-A33, 0197-BZ, 0197-M, 0197-N, 11 7 440 (1), 11 9 340 (2), 11 9 540, 11 9 551, 11 9 590, 1376-A, 2 299 362 (3)
MOTORCODES	N12 B14A, N13 B16A, N14 B16A, N14 B16C, N16 B16A, N18 B16A, N18 B16C, 5FA (EP6CDT), 5FD (EP6DTS), 5FE (EP6CDT), 5FE (EP6CDTM), 5FF (EP6DTS), 5FG (EP6CDTR), 5FH (EP6C), 5FK (EP6C), 5FK (EP6CB), 5FL (EP6C), 5FM (EP6CDTM), 5FN (EP6CDT), 5FP (EP6), 5FR (EP6DTE), 5FS (EP6C), 5FT (EP6DT), 5FU (EP6CDTX), 5FV (EP6CDT), 5FW (EP6), 5FX (EP6DT), 5FY (EP6DTS), 5GF (EP6FADTX), 5GF (EP6FADTXD), 5GG (EP6FADTX), 5GM (EP6FDTX), 5GN (EP6FDTR), 5GP (EP6FDTR), 5GR (EP6FDTX), 5GT (EP6FDTX), 5GW (EP6FDT), 5GY (EP6FADTXD), 5GY (EP6FDT), 5GY (EP6FDTM), 5GZ (EP6FDT), 8FN (EP3C), 8FP (EP3C), 8FR (EP3C), 8FS (EP3)



54228

187,00€

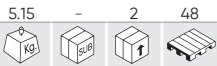

WERKZEUGSATZ FÜR MOTORSTEUERUNG FÜR BMW/MINI 1.2, 1.5, 2.0, 3.0

MODELLE	BMW: 1 SERIES (2015 - 2019), 2 SERIES (DESDE 2014), 3 SERIES (DESDE 2015), 4 SERIES (DESDE 2015), 5 SERIES (DESDE 2017), 6 SERIES (DESDE 2017), 7 SERIES (DESDE 2015), i8 (DESDE 2014), X1 (DESDE 2015), X2 (DESDE 2018), X3 (DESDE 2017), X4 (DESDE 2018) AND Z4 (DESDE 2019); MINI: CLUBMAN (DESDE 2015), HATCH (DESDE 2014), CONVERTIBLE (DESDE 2016) AND COUNTRYMAN (DESDE 2017)
OEM WERKZEUG	2 358 122 (1), 2 357 904 (2), 2 365 488 (3), 2 288 380 (4), 11 4 120 (5).
MOTORCODES	BMW: 1,5 B38 A15A, B38 B15A, B38 K15A ,1,6 B48 B16A, 2,0 B48 A20A, B48 A20B, B48 A20E, B48 B20A, B48 B20B , 3,0 B58 B30A, B58 B30B, B58 B30C MINI: 1,2 B38 A12A , 1,5 B36 A15A, B38 A15A , 2,0 B46 B20A, B48 A20A, B48 A20B

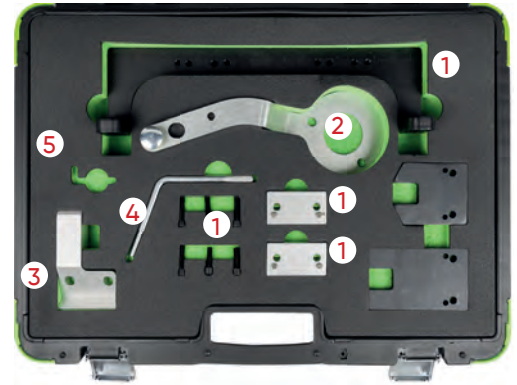

54293

17,50€

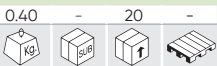

KURBELWELLENHALTER FÜR BMW

MODELLE	BMW 1 SERIES E81/82/87/88: 116D (2008-2012),118D (2007-2012),120D (2007-2014), 123D (2007-2014) BMW 1 SERIES E22: 218D (2011-2014), 220D (2011-2014), 225D (2011-2014) BMW 3 SERIES E90/91/92/93: 316D (2007-2012), 318D (2007-2014),320D (2007-2012), 325D (2010-2012), 330D (2008-2014) BMW 5 SERIES E60/61: 520D (2007-2010) BMW 5 SERIES F10/11: 525D (2010-2013), 530D (2010-2013),530D XDRIVE (2011-2015), 535D (2010-2013), 535D XDRIVE (2011-2015),M550D XDRIVE (2012-2015) BMW 5 SERIES F07: 535D GT (2009-2015) BMW 7 SERIES F01/02/04: 730D (2008-2012), 740D (2009-2012),750D XDRIVE (2012-2015) BMW X1 E84: 18D SDRIVE (2009-2015), 20D SDRIVE (2009-2015), 18D XDRIVE (2009-2015), 20D XDRIVE (2009-2015), 23D XDRIVE (2009-2012) BMW X3 E83: 2.0D (2007-2008), 18D XDRIVE (2008-2010) BMW X5 E70: 3.0D XDRIVE (2010-2013), 40D (2010-2013) BMW X6 E71/71: 30D XDRIVE (2010-2014), 40D XDRIVE (2010-2014)
OEM WERKZEUG	T10016
MOTORCODES	2,0: N47D20C, N47D20D 2,0D: N47, D20A, D20A/KO, D20B, D20B/TO, D20C,D20O0, D20O1, D20U0, D20U1 D20K1 3,0D: N57, D30U0, D30O0, D30O1, D30T0, D20T0,D30A, D30A/O0, D30B , D30B/T1, D30C, D30C/S1,D30A0/O0, D30A0/O1



54398

41,00€

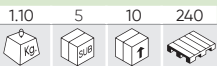

SCHWUNGRAD-/KURBELWELLENRIEMENSCHLEIBEN-VERRIEGELUNGSSATZ FÜR BMW/MINI

MODELLE	MINI HATCH (14-21), CABRIOLET (16-19), CLUBMAN (15-19), COUNTRYMAN (17-19)
OEM WERKZEUG	11 6 480 (1) 11 9265 (2) 11 4 180 (3) 11 9 810 (4) 11 9 811 (4)
MOTORCODES	BMW: 116i (15-19), 116d (15-19), 118d (15-19), 120d (15-19), 125d (15-19), M140i (16-19), 214d (15-19), 216i (18-19), 216d (14-20), 218d (17-19), 218i (15-21), 220d, (14-20), 225d (15-20), M240i (16-19), 316d (15-19), 318i (15-19), 320d (15-19), X1 (15-20),X2 (18-19), X3 (14-18), X4 (17-20), X5 (15-18), i8 (14-18) 325d (16-20),330i (15-20), 340i (15-19), 418i (15-20), 420d (15-20), 425d (16-18), 430i (16-20),440i (16-19), 518d (14-17), 525d (17-20), 530i (17-18), 540i (17-19), 620d (18-20), 630i (17-19), 640i (17-19), 725d (16-19), 730i, (15-19), 740i (15-19)

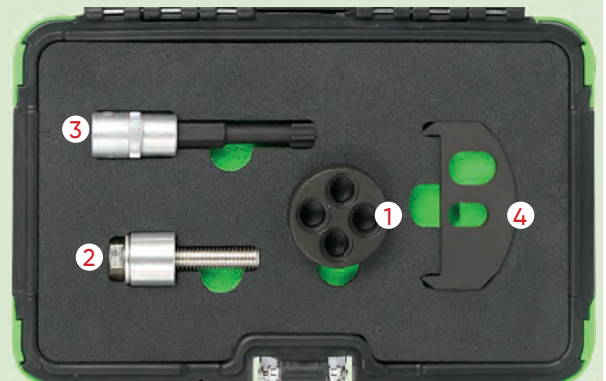

54399

56,50€

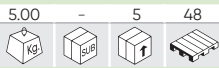

N

MOTOR-EINSTELLWERKZEUG SATZ FÜR BMW/ROVER/OPEL 2.5D

MODELLE	BMW: 318TDS (94-00), 325TD (91-99), 325TDS (91-99), 525TD (90-03), 525TDS (90-03), 725TDS (95-02) RANGE ROVER: P38 (94-02) VAUXHALL/OPEL: OMEGA-B (94-01)
OEM WERKZEUG	KM811 (1), 113320 (1), 12112 (1) KM822 (2), 113360 (2), 12115 (2) KM813 (3), 115120 (3), 112300 (3), 12108 (3) KM823 (4), 113340 (4), 12172 (4)
MOTORCODES	256T, 25DT, M41/174T1, M51/256T1, M51/256T1L, X25DT

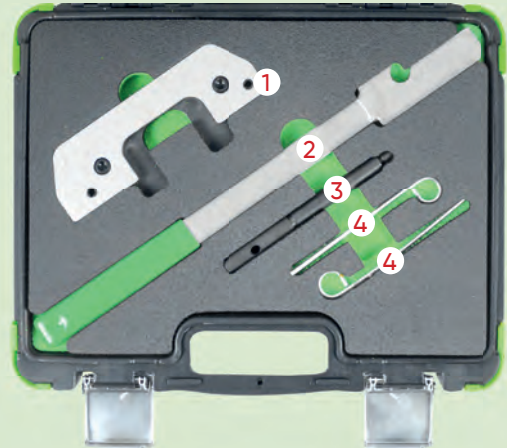

54400

141,00€

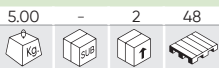

N

MOTOR-EINSTELLWERKZEUG SATZ FÜR BMW N20, N26

MODELLE	BMW: 1 SERIES 125I - F20/21 (2012-2016) 2 SERIES COUPE 220I, 228I - F22 (2014-2016) 2 SERIES CABRIOLET 220I 228I - F23 (2015-2016) 3 SERIES 320I 328I XDRIVE - F30/31 (2012-2015) 3 SERIES GRAN TURISMO 320I, 328I/XDRIVE - F34 (2013-2016) X4 XDRIVE 20I, 28I (F26) 2014 - 2018, X5 XDRIVE40E (F15) 2015 - 2018, Z4 SDRIVE18I, 20I, 28I (E89) 2011 - 2017 4 SERIES COUPE 420I, 428I/XDRIVE - F32(2013-2016), 4 SERIES CABRIOLET 420I, 428I/XDRIVE-F33 (2014-2016) 4 SERIES GRAN COUPE 420I, 428I/XDRIVE F36 (2014-2016) 5 SERIES 520I, 528I/XDRIVE(F10/11) 2010 - 2017, 5 SERIES GRAN TURISMO 528I-(F07) 2013 - 2016, X1 SDRIVE16I, 18I, 20I, XDRIVE20I, 28I-(E84) 2011 - 2015, X3 SDRIVE18I, 20I, XDRIVE20I, 28I (F25) 2011 - 2017
OEM WERKZEUG	11 9 340/341 (1), 11 9 340A (1), 11 9 341 (1), 119340 (1) 2 212 830 (2) 2 212 831 (3) 2 219 548 (4)
MOTORCODES	1,6 N20 B16A 2,0 N20 B20 N20 B20A N20 B20A N20 B20B N20 N20B/UO N20 B2000 N20 B2000 N26 B20 B26 B20A

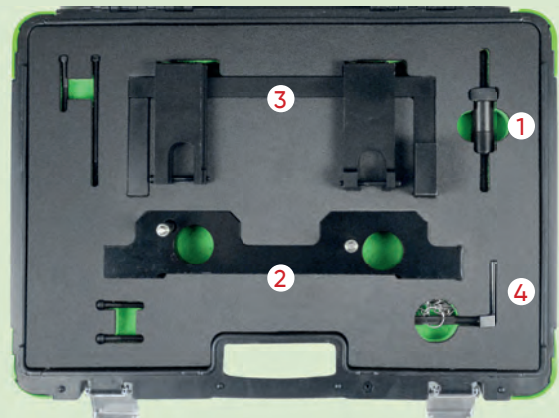

54401

57,00€



N

MOTOR-EINSTELLWERKZEUG SATZ FÜR BMW/MINI N13, N18

MODELLE	BMW 114i (2012-2015) BMW 116i (2012-2015) BMW 118i (2011-2015) BMW 316i (2012-2015) MINI CLUBMAN (R55) (2011-2014) MINI COOPER S (R56/57) (2010-2015) MINI COUNTRYMAN (R60) (2012-2016) MINI COUPE COOPER S (R58) (2012-2015) MINI PACEMAN (R61) (2013-2017) MINI ROADSTER (R59) (2012-2015)
OEM WERKZEUG	11 7 440 (1), 117440 (2), 11 9 340 (3), 11 9 590 (4), 49 6 709 (5)
MOTORCODES	N13 B16A N18 B16A N18 B16/MO N18B16A/MO N18B16C N18B16C/TO N18B16MO

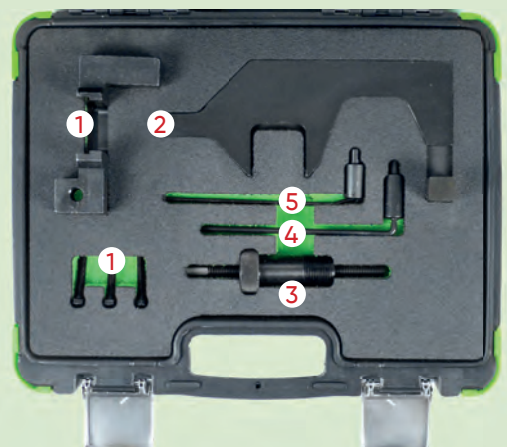

54402

201,00€

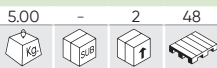

N

MOTOR-EINSTELLWERKZEUG SATZ FÜR BMW N51, N52, N53, N54, N55

MODELLE	E60: 523I, 523LI, 525I, 525LI, 525XI, 528I, 528XI, 530I, 530LI, 530XI, 535I, 535XI E61/E63: 523I, 525I, 525XI, 530I, 530XI, 535XI, 630I E64/E65: 630I, 730I E66/E70: 730LI, X5 3.0SI E81/E82: 130I, 135IS E83: X3 2.5I, 2.5SI, 3.0I, 3.0SI E85/E86: Z4 2.5I, 2.5SI, 3.0I, 3.0SI, Z4 3.0SI E87/E90: 130I, 323I, 325I, 325XI, 328I, 328XI, 330I, 330XI, 335I, 335XI E91: 323I, 325I, 325XI, 328I, 328XI, 330I, 330XI, 335I, 335XI E92: 323I, 325I, 325XI, 328I, 328XI, 330I, 330XI, 335I E93: 325I, 328I, 330I, 335I
OEM WERKZEUG	110300 (1) 114280 (2) 114285 (3) 114290 (4) 114390 (5) 118520 (6) 119190 (7) 119340 (8)
MOTORCODES	N51/N52/N53/N54/N55

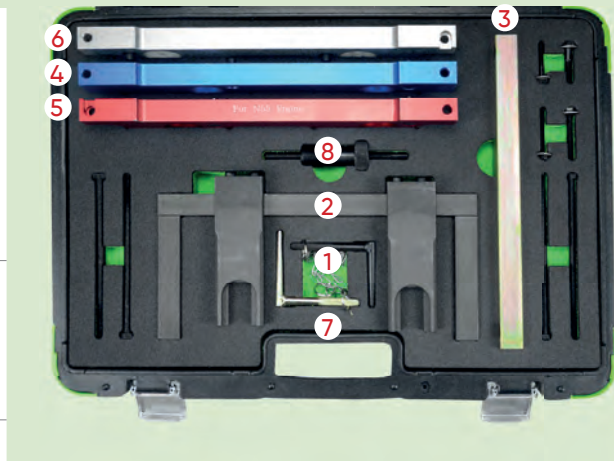

54403

225,00€



N

MOTOR-EINSTELLWERKZEUG SATZ FÜR BMW M60

MODELLE	BMW 5 SERIES: 530I, 540I (E34) (1992 – 1996), 535I, 540I (E39) (1996 – 2003) BMW 7 SERIES: 730I, 735I, 740I (E38) (1994 – 2002), 730I, 740I (E32) (1992 – 1994) BMW 8 SERIES: 840I (E31) (1993 – 1999) LAND ROVER/RANGE ROVER: (L322) (2002 – 2005) X5: 4.4, 4.6 (E53) (1999 – 2004)
OEM WERKZEUG	11 2 445 (1), 11 2 441/445 (1), LRT -12 223/2 (1) 11 2 441 (2), 12 223/1 (2), LRT 12-223/1 (2) 11 2 442 (3), 11 2 442/446 (3), 12 223/3 (3), LRT 12 223/3 (3) 11 2 446 (4), 12 223/4 (4), LRT 12 223/4 (4), LRT 12 224 (4) 11 3 390 (5), 113390/117380 (5), 12 222 (5), LRT 12 222 (5) 11 5 180 (6), 12 227 (6), LRT 12 227 (6) 11 2 300 (7), 11 5 120 (7), 12 108 (7), 12 171 (7), KM 813 (7), LRT 12 108 (7), LRT 12 171 (7) 11 6 420 (8), 12 226 (8), LRT 12 226 (8) 11 6 452 (9), 12 228/1 (9), LRT 12 228/1 (9) 11 6 451 (10), 12 228/2 (10), LRT 12 228/2 (10) 11 3 310 (11), 12 220 (11), LRT 12 220 (11) 11 6 440 (12), 12 224 (12), LRT 12 2214 (12) 11 7 380 (13), 12 221 (13), LRT 12 221 (13)
MOTORCODES	BMW 3.0: 30 8S 1 BMW 3.5: 35 8S 1, 35 8S 2 BMW 4.0: 40 8S 1 BMW 4.4: 44 8S 1, 44 8S 2 BMW 4.6: 46 8S 1 RANGE ROVER: V8/44 8S 2



54404

131,00€



N

MOTOR-EINSTELLWERKZEUG SATZ FÜR BMW N62, N73

MODELLE	SERIES 5, SERIES 6, SERIES 7, X5
OEM WERKZEUG	119461 (1), 119462 (2), 119463 (3), 119190 (4), 119340 (5), 119451 (6), 119452 (7), 119453 (8), 119454 (9), 113460 (10), B117207 (11)
MOTORCODES	N62 B36A, N62 B40A, N62 B44A, N62 B48A, N62 B48B, N73 B60A

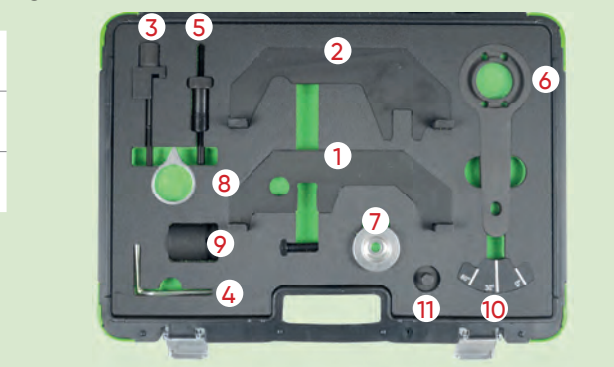

54405

111,00€

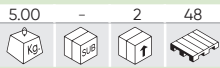

N

MOTOR-EINSTELLWERKZEUG SATZ FÜR BMW N63, N74

MODELLE	SERIES 5, SERIES 6, SERIES 7, X5, X6
OEM WERKZEUG	11 9 891 (1) 11 9 892 (1) 11 9 893 (2) 11 9 190 (3) 11 8 090 (4)
MOTORCODES	N63, N74

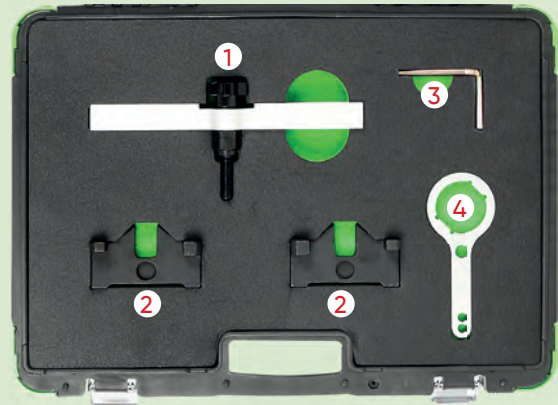

54406

73,00€



N

MOTOR SCHWUNGRAD BLOCKER BMW/MINI

MODELLE	<p>BMW 1 SERIES: F20/21 (12-15), 116i (04-12), 118i (04-14), 120i (04-14), 130i (05-07), 135i (07-11), 116D (08-12), 118D (04-14), 120D (04-14), 123D (07-14), M COUPE (11-12)</p> <p>BMW 3 SERIES: F30/31 (12-15), 316Ti (04-14), 316i (04-11), 316D (09-12), 318i (04-07), 318Ti/COMPACT (04-04)</p> <p>BMW 3 SERIES: 318D (03-12), 318TD (03-07), 320D (01-07), 320D COMPACT (01-05), 318i (05-13), 320D (07-14), 320i (05-14), (05-14), 320Si (05-06)</p> <p>BMW 3 SERIES: 323i (05-11), 325i (05-14), 325D (06-10), 330D (05-08), 330i (06-13), 335D (05-13), 335i (05-11)</p> <p>BMW 4 SERIES: 420i F32 (13-15), 428i F32 (13-15), 420i F33 CABRIOLET (14-15), 428i F33 CABRIOLET (14-15), 420i F36 (14-15), 428i F36 GRAN COUPE (14-15)</p> <p>BMW 5 SERIES: F10/11 (10-15), 520D (05-10), 520i (07-10) 523i (03-10), 525D (05-10), 525i (05-10), 525i (07-10), 530D (03-10), 530i (05-10), 535D (04-10)</p> <p>BMW 6 SERIES: 630i (04-11), 635D (07-11)</p> <p>BMW 7 SERIES: 730D (05-08), 730i (02-08) BMW X SERIES: X1 E84 (09-15), X3 E83 (03-14), X5 E53 (03-14), X3 F25 (11-15), X6 E71/72 (08-10)</p> <p>BMW Z SERIES: Z4 E85/86 (04-09), Z4 (E89) (11-15)</p> <p>MINI: MINI (03-06)</p>
OEM WERKZEUG	11 8 180 (1), 11 8 181 (2), 11 8 182 (3), 11 8 183 (4), 11 8 184 (5), 11 8 185 (6)
MOTORCODES	BMW: M47T2, M57T2, M67, N43, N45, N45T, N46, N46T, N47, N51, N52, N53, N54 MINI: W17 DIESEL



54324

11,00€

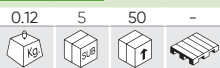

N

STEUERKETTENVERSCHLEISSANZEIGE MINI

MODELLE	MINI: CLUBMAN (2007-2014), CLUBVAN (2012-2014), COUNTRYMAN (2010-2017), COUPÉ (2011-2015), MINI (2006-2015), PACEMAN (2013-2017), ROADSTAR (2012-2015)
OEM WERKZEUG	2353281 (1)
MOTORCODES	1,4: N12 B14AB, N12 B14 1,6: N12 B16A, N16 B16A, N16 B16M0, N16 B16U0, N16 B16A/MO, N16 B16KO, N16 B16A/MO, N18 B16A, N18 B16A/MO, N18 B16C, N18 B16A/MO, N18, N18 B16M0, N18 B16C/T0



53268

92,00€

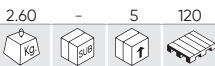

MOTOREINSTELLUNG WERKZEUG SET BMW/MINI/PSA 1.4, 1.6

MODELLE	<p>BMW/MINI: MINI CLUBVAN R55 (12-14), MINI CLUBMAN R55 (08-14), MINI COUNTRYMAN R55 (07-10), MINI CLUBMAN R56/R57 (07-15), MINI R56/R57 (08-15), MINI COUPE R58 (11-15), MINI ROADSTER R59 (08-15), MINI CLUBMAN R60 (10-14), MINI CLUBVAN R60 (12-14), MINI ROADSTER R61 (13-15), MINI PACEMAN R61 (14-15), MINI COUNTRYMAN R60 (10-17).</p> <p>CITROËN: C4 (08-11), C4 PICASSO (08-13) C4 GRAND PICASSO (13-15).</p> <p>PEUGEOT: 207 (06-14), 207CC (07-15), 308 (07-15), 3008 (09-15), 5008 (09-15).</p>
OEM WERKZEUG	<p>BMW/MINI: 115590 (1), 119340 (2), 119551 (3)</p> <p>CITROËN: 0197-A1, 0197-A3, 0197-B.</p> <p>PEUGEOT: 0197-A1, 0197-A3, 0197-BZ.</p>
MOTORCODES	<p>1.4: N12B14, N14B14AB.</p> <p>1.6: EP3(8FS), EP3C(8FR), EP6(5FW), EP6C(5FS), EP6CDT(5FV), EP6DT(5FT), EP6DT(5FX), EP6DTS(5FY), N14B16A, N14B16CD, N14B16TO, N14B16CD/TO, N16B16A, N16B16KO, N16B16A/MO, N16B16A/MO, N16B16MO, N16B16UO.</p>



53313

139,00€



MOTOREINSTELLUNG WERKZEUG SET CITROEN/PEUGEOT

MODELLE	<p>CITROËN: AX, BX, BOXER, BERLINGO, C25, DISPATCH, EVASION, J5, JUMPY, JUMPER, RELAY, SAXO, SYNERGIE, VISA, XM, XSARA, XANTIA, XZ, ZX.</p> <p>PEUGEOT: 106, 205, 206, 305, 306, 307, 309, 405, 406, 605, 607, 806, EXPERT, PARTNER, SOLARA, TALBOT.</p>
OEM WERKZEUG	<p>7099TM (1), 0188X (2), 0188P (3), 0189AZ (4), 0188H (5), 0132AJ1 (6), 0189A (7), 0188PM (8), 21-260 (9), 4527-TS1 (10), M8X70 (11), 0188K (12), 0188J (13), 0132Q (14), 4507-TL (15), 4507-TJ (16), 9044-T (17), 4507-TJ (18), 5711-TA (19), 7014-TJ (20), 7017-TR (21), 0188X (22), 7017-TW (23), 7014-TM (24), 0189L (25)</p>

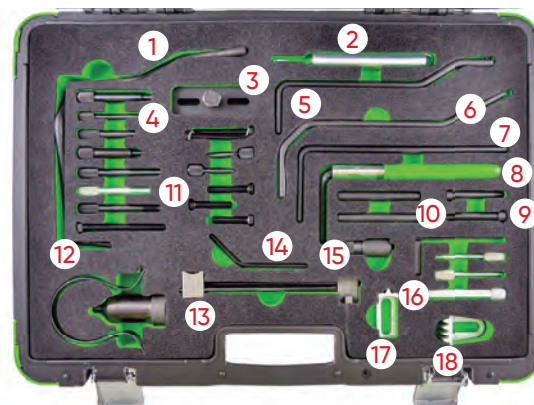

53314

98,00€



MOTOREINSTELLUNG WERKZEUG SET CITROEN/PEUGEOT 1.8, 2.0

MODELLE	<p>CITROËN: C4 PICASSO/GRAND PICASSO (06-10), C5 II (04-08), C8 (05-10), DISPATCH/JUMPY (07-11), XSARA 2.0 16V, C5 1.8/2.0/HPI, XSARA PICASSO 1.8/2.0 16V (02-05).</p> <p>PEUGEOT: 406 1.8 16V (00-04), 407 (06-10), 807 2.0 16V (02-05).</p>
OEM WERKZEUG	<p>0189S2 (1), 0188J (2), 0188J2 (2), 0189S1 (3), 21-260 (4), 0189B (5), 0188M (6), 0188AH (7), 0189R (8)</p>
MOTORCODES	<p>1.8 16V: EW7A(6FY).</p> <p>2.0 16V: EW10A(RFJ), EW10ABE4(RFH), EW10J4S (RFK).</p>



53876

64,00€

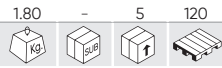

MOTOREINSTELLUNG WERKZEUG SET CITROËN/PEUGEOT 1.0, 1.2 VTI

MODELLE	CITROËN: C3 (III) PEUGEOT: 208, 308, 2008 SUV (2012-2014)
OEM WERKZEUG	0109-2A (1) 0109-2B (2)
MOTORCODES	1.0/1.2 VTI. EBO, (ZMZ), EB2, (HMZ)



54288

72,50€

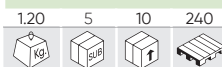

MOTOR-EINSTELLWERKZEUG SATZ FÜR PSA 1.2 GDI PURETECH

MODELLE	CITROËN: BERLINGO IV (18-20), C1 II (14-18), C3 III (12-17), C3 IV (16-18), C4 CACTUS (14-20), C4 AIRCROSS (18-20), C-ELYSEE (12-18), DS3 (12-18) PEUGEOT: 108 (14-18), 208 (12-21), 2008 (13-21), 301 (12-20), 308 (13-21), 3008 (16-21), 508 (19-21), 5008 (14-21), PARTNER III (15-18) PARTNER IV (18-21) RIFTER (19-21) TOYOTA: AYGO (14-18) GM: CROSSLAND X (17-20), COMBO E (18-20), GRANDLAND X (17-20)
OEM WERKZEUG	CITROËN: G-0109-6 (2), 0109-2B (1), 0109-2C (3), 0109-2D (4), 0197-N (1) PEUGEOT: G-0109-6 (2), 0109-2B (1), 0109-2C (1), 0109-2D (4), 0197-N (1) VAUXHALL: EN-52127-2 (1), EN-52809 (2)
MOTORCODES	1.2 VTI: 1PP(HM01), EB2 (HMZ), EB2DTS(HNY), EB2 (HMW), EB2M (HMY), EB2 (HMZ), EB-2DTS(HNY), HMP (EB2FB), HMT(EB2D), HMU(EB2D),HMV (EB2M), HMY (EB2M), HMZ (EB2), HMZ (EB2D), HMZ (EB2F),HMZ (EB2F) 1.2 E-VTI: HMZ (EB2F), EB2F (HMZ) 1.2 PURETECH THP: HNZ (EB2DT) 1.2 PURETECH VTI: EB2ADS (HNS), EB2D(HMT), EB2ADJ (HNP),EB2ADT (HNK), EB2ADTX (HNN), EB2DTS (HNW), EB2DTM (HNW),EB2DTSM (HNW), EB2FA (HMR), EB2FAD (HMH), EB-2FAD (HMM),EB2DT (HNZ), EB2F (HMX), EB2F (HMT), EB2F(HMZ), EB2DTS(HNY),EB2M(HMY)



REF. BESCHREIBUNG

16400 ZAHNRIEMEN-PRÜFLEHRE PSA (REF.54288)

54323

119,00€



MOTOREINSTELLUNG WERKZEUG SET PSA 1.0, 1.2 VTI, 1.2 GDI PURETECH

MODELLE	CITROËN: C1 II (2014-2018), C3 III (2012-2017), C3 IV (2016-2018), C4 CACTUS (2014-2020), C4 AIRCROSS (2018-2020), C-ELYSEE (2012-2018), DS3 (2012-2018), BERLINGO IV (2018-2020), GM: CROSSLAND X (2017-2020), COMBO E (2018-2020), GRANDLAND X (2017-2020) PEUGEOT: 108 (2014-2018), 208 (2012-2021), 2008 (2013-2021), 301 (2012-2020), 308 (2013-2021), 3008 (2016-2021), 508 (2019-2021), 5008 (2014-2021), PARTNER III (2015-2018), PARTNER IV (2018-2021), RIFTER (2019-2021) TOYOTA: AYGO (2014-2018).
OEM WERKZEUG	EN-52127-2 (1), 0109-2B (1) J-0109-2C (2) J-0109-2D (3) EN-52127-1 (4), 0109-2A21 (4) G-0109-6 (5)
MOTORCODES	B12XHL (EB2DT), B12XHT (EB2DTS), D12XHL (EB2ADT), D12XHL (HNP/EB2ADT), D12XHT (EB2ADTS), EBO (ZMZ), EBOF (ZMZ), EB2ADT (HNK), EB2ADT (HNP), EB2ADTD (HNK), EB2ADTS (HNS), EB2ADTX (HNN), EB2DT (HNZ), EB2DTM (HNW), EB2DTS (HNW), EB2DTS (HNY), EB2DTSM (HNW), EB2FA, EB2FAD, F12XHT (EB2ADTS), F12XHT (HNS/EB2ADTS), HMM (EB2FAD), HMM (EB2FAD), HMP (EB2FB), HMR (EB2FA), HMT (EB2), HMT (EB2F), HMU (EB2D), HMU (EB2FD), HMV (EB2M), HMW (EB2), HMX (EB2F), HMY (EB2M), HMZ (EB2), HMZ (EB2F), HNJ (EB2ADTXM), HNK (EB2ADT), HNK (EB2ADTD), HNK/EB2ADTD, HNL (EB2ADTSM), HNN (EB2ADTX), HNP (EB2ADT), HNS (EB2ADTS), HNS/EB2ADTS, HNT (EB2ADTS), HNW (EB2DT), HNW (EB2DTM), HNW (EB2DTS), HNW (EB2DTSM), HNX (EB2DT), HNX (EB2DTS), HNY (EB2DTS), HNZ (EB2DT), HNO2, ZMZ (EBO), ZMZ (EBOF), 1PP (HM01)

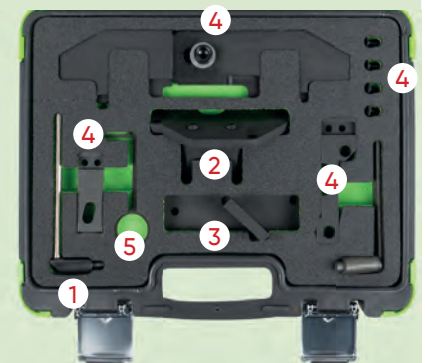

54213

19,80€

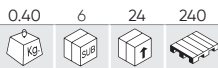

WERKZEUGSATZ FÜR MOTORSTEUERUNG FÜR ROVER/PEUGEOT/FORD/VOLVO 2.0, 2.2L D

MODELLE	PEUGEOT: 807 (05-11), 407 (05-11), 607 (05-09). CITROËN: C4 (04-10), C5 II (04-10). LAND ROVER: FREELANDER (06-10). VOLVO: S40 (03-10), V50 (06-10), C70 (06-10), S80 (07-10), C30 (06-10), V70 (07-10). FORD: S MAX 2.2 (08-10), GALAXY 2.2 (08-10), MONDEO 2.2, 2.0 (07-10).
OEM WERKZEUG	PSA 0188.M, FORD 303-735, 303-1277, VOLVO 999-7122 (1) PSA 0188.X, FORD 303-1059, 303-1270, VOLVO 999-7121 (2) PSA 0188.F, FORD 303-393A, 303-393-01, 303-1272, VOLVO 999-7119/7120 (3)
MOTORCODES	PEUGEOT: DW10UTED4 (RHK), DW10BTED4 (RHR) DW12B-TED4 (4HS), (4HP), (4HT), (4HR). CITROËN: DW10BTED4 (RHR). LAND ROVER: DW12BTED4, 224DT. VOLVO: D420T 2.0D. FORD: QXBA(2.2), QXWA(2.0), QXBB(2.0), Q4BA(2.2), QXWA(2.0), QXWB(2.0), AZBA(2.0), AZBC(2.0), AZWA(2.0)

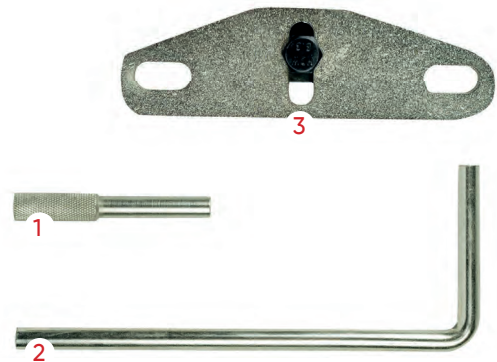

54432

43,00€



MOTOR-EINSTELLWERKZEUG SATZ FÜR PSA 2.7, 3.0 HDI

MODELLE	CITROËN C6 JAGUAR S-TYPE (X200) 2004 - 2008, XF S (X250) 2008 - 2015, XF S (X260) 2015 - 2020, XJ6 TDV1 (X350/358) 2005 - 2010, XJ (X351) 2010 - 2020, F-PACE S 30D (X761) 2016 - 2020 LAND ROVER: DISCOVERY 3 TDV6 (L319) 2004 - 2009, DISCOVERY 4/DISCOVERY SDV6, TDV6 (L319) 2009 - 2017, DISCOVERY SD6, TD6 (L462) 2017 - 2021, RANGE ROVER SDV6, SDV6 HYBRID, TDV6 (L405) 2012 - 2021, RANGE ROVER SPORT SDV6, TDV6 (L320) 2005 - 2013 PEUGEOT 407, 607 COUPE RANGE ROVER VELAR D275, D300 (L560) 2017 - 2021, RANGE ROVER SPORT SDV6, SDV6 HYBRID, TDV6 (L494) 2013 - 2021
OEM WERKZEUG	303 11117 (1), 303 11116 (2), 303 1132 (3), 303 1126 (4), 0195H (4), 0195C (5), 0195K (6), 0188-K (7)
MOTORCODES	2.7: DT17 TED4 (UHZ), DT17BTED4 (UHZ) 3.0: DT20C (X8C/X8Z), DT20CTED4 (X8Z)

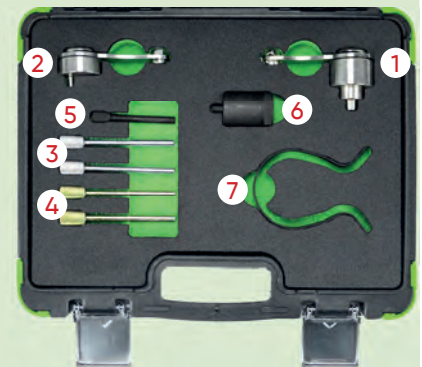

54433

18,00€



MOTOR-EINSTELLWERKZEUG SATZ FÜR PSA 1.0, 1.1, 1.2, 1.4, 1.6, 2.0

MODELLE	CITROËN BERLINGO 2008 - 2011, C2 2003 - 2010, C-ELYSEE 2012 - 2016, C3 PLURIEL 2003 - 2010, C4 2004 - 2011, NEMO 2008 - 2015, XSARA 2000 - 2005 PEUGEOT 106 1998 - 2003, 206 1998 - 2009, 207 2006 - 2013, 306 1998 - 2003, 307 2000 - 2008, 1007 2005 - 2010, PARTNER 1998 - 2011, BIPPER 2008 - 2015
OEM WERKZEUG	0132QY (1), 4507 TA (1), 0132AK (2), 0153AK (2), 0188K (2), 0189K (2), 1870 900 100 (2), 4533 TAD (2), MOT 1436 (2) 3MM PIN (3), 0132AB (4), 0178D (4), 0194A (4), 77440010400 (4), 1860.617000 (4), 11 9 790 (4), 21-260 (4), 303-732 (4), 4527 TS2 (4), 49 JEO2 018 (4), 5711 TD (4), 99360608 (4), 999 7169 (4), KM-6349 (4), 0132AJ1 (5), 0187B (5), 0189B (5), 0194B (5), 09919 58120 (5), 21 263 (5), 303 735 (5), 3031277 (5), 49 JEO2 021 (5), 607589011500 (5), 8MM DRILL BIT (5), 8MM PIN (5), 999 7122 (5), EN-52137 (5), MOT. 1430 (5), MOT 1430 (5), 0123-RZ (6), 0132R (6), 0153AA (6), 0153AB (6), 0153G (6), 0153ZY (6), 10MM PIN (6), 4507 TB (6), 7014 TN, 9767 27 (6), M10 X 70MM (6), 0132Q (7), 0132QZ (7), 132Z (7), 4507 TA (7)
MOTORCODES	1.0: TU9 (C1A), TU9/K (C1A), TU9M (CDY/CDZ), TU9MZ (CDY/CDZ), TU9M/L (CDZ), TU9M/L3 (CDY) 1.1: TU1A (HFV/HFX), TU1JP (HFV/HFY/HFZ), TU1JP/L4 (HFV), TU1/K (H1A), TU1M (HDZ), TU1M/L (HDZ), TU1M/L3 (HDY/HDZ), TU1M/Z (HDZ), TU1M+ (HDY/HDZ) 1.4: ET3J4 (KFU), ET3JP4 (KFU), TU3A (KFT/KFV/KFW), TU3FJ2 (K6B/KFZ), TU3FM (KDY), TU3JP (KFW/KFV/KFX), TU3JP/IFL4 (KFX) TU3JP/L3 (KFX), TU3JP/L4 (KFX), TU3JP/IFL4 (KFX), ET3J4 (KFU), TU3M (KDX), TU3M/Z (KDY) 1.6: EC5 (NFP), EC5F (NFP), TU5J2 (NFY/NFW), TU5J4 (NFU), TU5JP (NFT/NFZ), TU5JP/L3 (NFZ), TU5JP/L4 (NFT/NFV), TU5JP4 (NFU), TU5JP4B (NFR), TU5JP4S (NFS), TU5JP4/L3 (NFX), TU5JP4/L4 (NFU/NFX), XU5JP (BFZ) 1.8: XU7JB (LFX), XU7JP (LFW), XU7JP/L3 (LFZ), XU7JP4 (LFY), XU7JP4/L3 (LFY) 2.0: XU10JC/Z (RFU), (RGX), XU10J2E/V (RGX), XU10J2U (RFL), XU10J4R (RFR/RFV), XU10J4R/L3 (RFV), XU10J4RS/L3 (RFS)

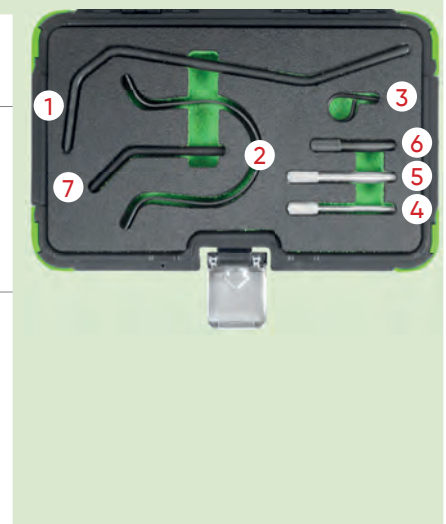

53293

134,00€

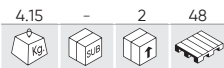

MOTOREINSTELLUNG WERKZEUG SET FORD

MODELLE	B-MAX (12-17), C-MAX (07-17), COUGAR (98-01), COURIER (00-02), ESCORT (94-98), FIESTA (95-17), FOCUS (98-17), FOCUS C-MAX (03-07), FUSION (02-12), GALAXY (06-15), GRAND C-MAX (10-17), KUGA (08-15), MAVERICK (01-07), MONDEO (93-15), ORION (94-94), PUMA (97-02), S-MAX (06-15), TOURNEO CONNECT (02-15), TRANSIT (06-11), TRANSIT CONNECT (02-16), ECOSPORT (13-15), TOURNEO COURIER (14-15), GRAND TOURNEO COURIER (13-15).
OEM WERKZEUG	303-376 (21-162B) (1), 303-1059 (2), 303-193 (21-104) (3), 303-393-01 (4), 303-1054 (5), 303-1097 (6), 303-748 (7), 303-734 (21-262) (8), 303-651 (21-229) (9), 303-393A (21-168) / 303-393-02 / 303-507 (21-210) / 303-620 (21-163)/ 303-732 (21-260) / 303-735 (21-263).
MOTORCODES	PETROL: AODA/B, ASDA, ASDB, CFBA, CGBA/B, CHBA/B, CJBA/B, CSDA/B, DHA, DHB, DHC, DHD, DHE, DHF, DHG, EDBB, EDBD, EDDB, EDDC, EDDD, EDDF, EYDB, EYDC, EYDD, EYDE, EYDF, EYDG, EYDI, EYDJ, EYPA, EYPC, F8JA, F8JB, FHA, FHD, FHE, FHF, FUJA, FUJB, FXDA/C, FXDB/D, FXJA, FXJB, FYDA/C, FYDB/D, FYJA, FYJB, HWDA, HWDB, L1F, L1J, L1L, L1N, L1Q, L1T, L1W, M7JA, M7JB, MHA, MHB, NGA, NGB, NGC, NGD, QQDA/B/C, QQDB, RKA, RKB, RKF, RKH, RKJ, RKK, HXDA. GASOIL: F6JA, F6JB, F6JC, HHJA, HHJB, G8DA, HHDA, HHDB, RTN, RTQ, RTP, C9DC, BHDA/B, BHPA, C9DA/B, F9DA/B, FFBA, FFDA, HCPA, HCPB, KKDA, P7PA, P9PA, QYWA, R2PA, R3PA, RWPA, G6DA, G6DB, G6DC, AZWA, QXWA.

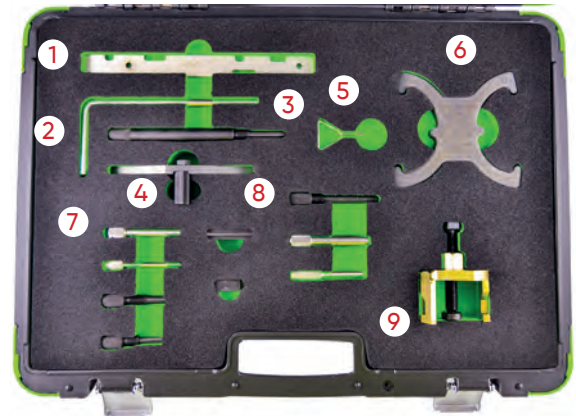

53294

119,00€

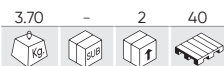

MOTOREINSTELLUNG WERKZEUG SET FORD MAZDA

MODELLE	FORD: COURIER (00-02), C-MAX (03-10), FIESTA (02-11), FOCUS (98-11), FUSION (02-11), GALAXY (06-10), KUGA (06-10), MONDEO (07-10), S-MAX (06-10), TOURNEO CONNECT (02-13), TRANSIT CONNECT (02-13) PEUGEOT: BIPPER (08-10) DISPATCH/JUMPY III (07-12) EXPERT III (07-12) NEMO (08-10) PARTNER I/II (05-11) PARTNER III (08-16) 107 (05-10) 1007 (05-10) 206 (01-12) 206+ (09-13) 206 CC (05-07) 207 (06-13) 207 CC (07-15) 208 (11-15) 307 (01-08) 308 (07-15) 308 CC (09-15) 407 (05-11) 508 (04-15) 2008 (13-15) 3008 (09-15) 4008 (12-15) 5008 (09-15). MAZDA: 2 (02-15), 3 (09-14) CITROËN: C1 (05-10), C2 (03-10), C3 I/II (02-10), C3 III (10-15), C3 PLURIEL (04-10), C3 PICASSO (09-12), C4 (04-11), C4 II (11-15), C4 PICASSO (06-12), C4 GRAND PICASSO (10-12), DS3 (09-12), DS4 (11-12), DS5 (12-15), C5 II (04-08), C5 III (04-12), XSARA II (02-04), XSARA PICASSO (04-10)
OEM WERKZEUG	FORD: 303-376B (1), 303-193 (2), 303-393 (3), 303-732 (4), 303-651 (5), 303-393/01, 303-1059, 303-734, 303-735, MAZDA: 303-732, 303-734, 303-735. PSA: 0194-A, 0194-C, 0194B.
MOTORCODES	1.4D TDCi/Hdi: DV4TD(8HT), DV4TD(8HX), DV4TD(8HZ), DV4TD(8HW), DV4TED4(8HX), DV4TED4(8HV), DV4TED4(8HY), DV4C(8HP), DV4C(8HR), DV4TED(8HS), F6JA, F6JB, F6JC. 1.6D TDCi/HDi: DV6TED4(9HZ), DV6ATED4(9HX), DV6TED4(9HY), DV6DTE(9HP), DV6C(9HR), DV6CATED(9HX), DV6C(9HL), DV6TED(9HP), DV6ATED(9HY), DV6TED4(9HV), DV6TED4(9HX), DV6C(9HD), DV6C(BHX), DV6C(BHZ), DV6(9HR), DV6BTED4(9HW), DV6DTE(9HJ), DV6ETED(9HN), DV6ATED4BU(9HS), DV6BTED4(9HT), DV6BUTED4(9HT), DV6TED4B(9HV), DV6UTED4(9HX), DV6TED(9HD), DV6UTED4(9HU), DV6D(9HP), DV6TED4(9HV), DV6C(9HD), DV6TED4(9HW), DV6AT(9HX), DV6ATED(9HX), DV6CTED(9HC), DV6AUTED4(9HX), DV6TED4B, DV6DTE(9HF), HHJA, HHJB, G8DA, G8DB, HHDA, HHDB, MZ-CD, Y6. 1.8D TDCi/HDi: BHPA, C9DA/B, FFBA, G6DA, G6DB, G6DC, HCPA, HCPB, KKDA, P7PA, P9PA, R2PA, R3PA, RWPA. 1.8d: C9DC, RTN, RTQ. 1.8D Td: C9DA/B, C9DC. 2.0D TDCi/HDi: AZWA, G6DA, G6DB, G6DC, RHE(DW10CTED4), QXWA, QXWB.

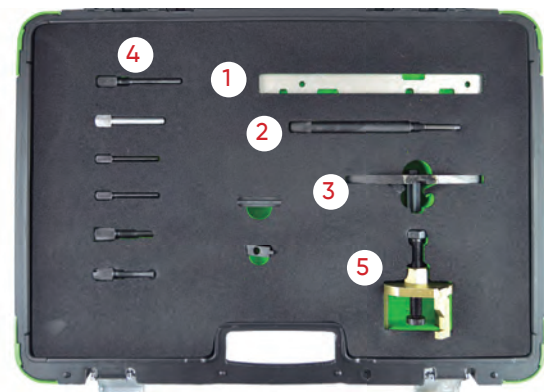

53318

24,00€



RIEMENSCHLEIBEN-ABZIEHER NOCKENWELLE FORD

MODELLE	FORD
OEM WERKZEUG	F8M, F8Q, S8U, S9U.



53295

77,00€

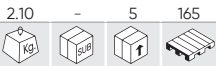

MOTOREINSTELLUNG WERKZEUG SET FORD 1,8TDDI, TDCI

MODELLE	C-MAX (07-10), COURIER (00-02), FIESTA (00-02), FOCUS (98-11), FOCUS C-MAX (03-07), GALAXY (06-10), MONDEO (07-10), S-MAX (06-14), TOURNEO CONNECT (02-13), TRANSIT CONNECT (02-13).
OEM WERKZEUG	303-193 (21-104) (1), 303-393 (21-168) (2), 303-376 (21-162B) (3), 303-652 (21-230) (4), 310-095 (23-067) (5)
MOTORCODES	1.8D TDCI: BHFA, F9DA, F9DB, FFBA, FFDA, FFWA, HCPA, HCPB, KHBA, KKDA, KKDB, P7PA, P9PA, P9PB, QYBA, QYWA, R2PA, R3PA, RWPA, RWPC. 1.8D TDCI ECONETIC: KHBA. 1.8D TDI: BHDA, BHDB, BHFA, C9DA, C9DB, C9DC. 1.8D TURBO: C9DC, RTN, RTP, RTQ.



53296

60,00€



EINSPRITZPUMPENEINSTELLUNGS SET FORD/JAGUAR DURATORQ

MODELLE	FORD: MONDEO (00-07), TRANSIT (00-14). CITROËN: RELAY, JUMPER III (06-13). FIAT: DUCATO (06-11).	JAGUAR: X-TYPE (03-10). PEUGEOT: BOXER III (06-12). LAND ROVER: DEFENDER TD4 (06-11). LDV: CONVOY (02-06).
OEM WERKZEUG	303-1151 (1), 303-679A/21-238 (2), 303-732 (3), 303-675/21-234 (4), 303-698/21-251 (5)	
MOTORCODES	1.2D DI/TDDI/TDCI: ABFA, D3FA, F3FA, D5BA, D6BA, F1FA, FMBA, FMBB, HJBA, HJBB, HJBC, HJBE, N7BA, N7BB. 2.2D TDCI/ECONETIC: BG, CYFA, CYFB, CYFC, DRFA, DRFB, DRFC, P8FA, P8FB, PGFA, PGFB, QJBA, QJBA (BG), QJBB, QJBC, QJBD, QVFA, QWFA, SRFA, SRFB, SRFC, SRFD, SRFE, UHFA. 2.2D HDI/JTD: P22DTE (4HM), P22DTE (4HU), P22DTE (4HV). 2.4D DI/TDCI: DOFA, D2FA, D2FB, D4FA, F4FA, FXFA, H9FA, H9FB, H9FD, JXFA, JXFC, PHFA, PHFC. 2.4D TD/TDI: ZSD 424. 2.4D TD4: 244DT.	



54419

57,00€



VORDERER KURBELLENDICHTUNGSABZIEHER/-INSTALLER FORD DURATORQ 2.0, 2.2, 2.4, 3.2

MODELLE	FORD MONDEO 2000 - 2007 RANGER 2011 - ON TRANSIT 2000 - 2006 TRANSIT 2006 - 2014 TRANSIT 2014 - 2019 TRANSIT/TOURNEO CUSTOM 2012 - 2016
OEM WERKZEUG	21 238 (1), 303-679A (1), 303-682 (2)
MOTORCODES	2.0 Di ABFA D3FA F3FA 2.0 TDCI FMBA FMBB HJBA HJBB HJBC N7BA N7BB SDBA F1FA 2.0 TDDi D5BA D6BA 2.2 TDCI QJBA QJBB QJBC QJBD GBVAJQJ GBVAJQJ GBVAJQJ JQW CVRA CVRB CYFA CYFB CYFC CYRA CYRB DRFA DRFB DRFC DRFE DRRB DRRB P8FA P8FB PGFA PGFB QVFA QWFA SRFA SRFB SRFC SRFD SRFE UHFA UHFB 2.4 Di D2FA D2FB D4FA DOFA F4FA FXFA 2.4 TDCI H9FA H9FB H9FD JXFA JXFC 3.2 TDCI SAFA SA2R SA2S SA2W SAFA SAFB



54420

102,00€



N

KRAFTSTOFFEINSTELLUNGSSATZ - FORD / VOLVO 2.5 (EURO 4)

MODELLE	FORD: FOCUS 2.5 RS / ST, MONDEO 2.5, S-MAX 2.5, GALAXY 2.5 ST (2005-) VOLVO: C30 (06-10), C70 (98-10), S40 (96-10), S60 (00-09), S70 (97-07), S80 (98-06), V40 (96-10), V50 (04-10), V70 (97-07), XC70 (02-07), XC90 (02-10)
OEM WERKZEUG	303-1178 (1), 999 5452 (1), MOT 1337 (1) 303-1182 (2), 999 5451 (2), MOT 1340 (2) 303-1179 (3), 999 5433 (3) 303-1183 (4)
MOTORCODES	FORD: 2.5 Turbo (Euro 4), HUBA / HUWA / HYDA / JZDA VOLVO: 1.6 (B4164S), 1.8 (B4184S), 1.9T (B4194T), 2.0 (B4204S / B4204T), 2.0T (B5204T3 / B5204T4 / B5204T5), 2.3 (B5234FS), 2.3T (B5234T3 / B5234T7 / B5234T9) VOLVO: 2.4 (B5244S / B5244S2 / B5244S4 / B5244S5 / B5244S7), 2.4T (B5244T / B5244T3 / B5244T4 / B5244T5 / B5244T7), 2.5R (B5254FS), 2.4D (D5244T9 / D5244T8 / D5244T13)

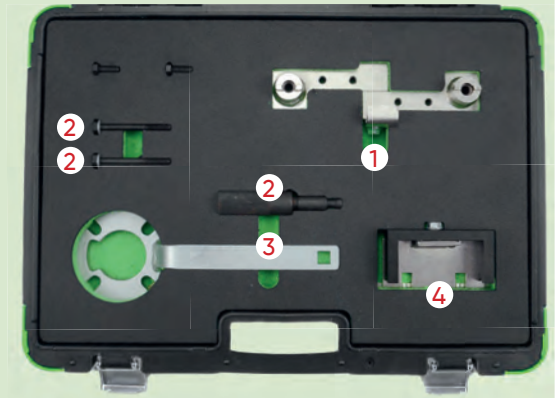

54421

52,00€



N

HILFSGURT-INSTALLER FORD/VOLVO 1.4 1.6

MODELLE	FORD 1.4, 1.6 (FOCUS, C-MAX, MONDEO) VOLVO 1.6 (S40, C30, V50)
OEM WERKZEUG	303-1179
MOTORCODES	B4164S3, FUJA, FXJA, FYJA C12HM7AD, C12LM7AA, ZH12FUJA, ZH12FUJB, ZH12M7JB C14HDEZ, C14HHADB, ZH14ASDA, ZH14FXDA, ZH14FXDB, ZH14FXDC, ZH14FXDD, ZH14FXJA, ZH14FXJB 16HDEZ, CH16HDEZ, C16HHDEY, ZH16FYDA, ZH16FYDB, ZH16FYDC, ZH16FYDD, ZH16FYDH, ZH16FYJA, ZH16FYJB, ZH16HWDA, ZH16HXDA



54424

64,50€



N

MOTOR-EINSTELLWERKZEUG SATZ FÜR FORD 2.0 ECOBOOST

MODELLE	FOCUS, GALAXY, MONDEO, S-MAX
OEM WERKZEUG	303-1504 (1) 303-1600 (2), 300-1565 (2) 303-1521 (3) 303-748 (4) 303-1595 (5) 2MM TENSIONER (6)
MOTORCODES	MGDA, R9CB, R9CD, R9CF, R9CH, R9DA, R9DB, R9DC, R9DD, TNBA, TNBB, TNCC, TNCD, TNCF, TNWA, TNWB, TPBA, TPWA, TVDA, XQDA

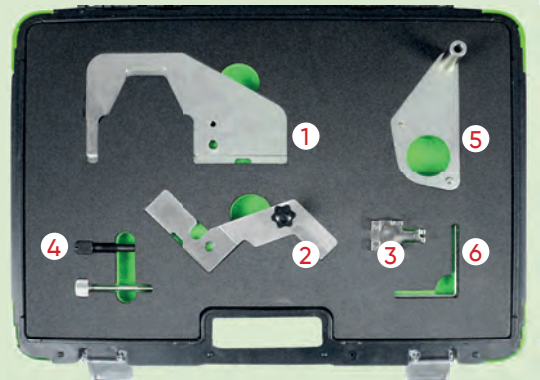

53324

12,50€

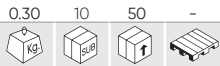

MOTOREINSTELLUNG WERKZEUG SET FORD

MODELLE	FORD: B-MAX (15-17), C-MAX (07-10), COUGAR (98-01), FIESTA (95-17), FOCUS (98-11), FOCUS C-MAX (03-07), FUSION (02-12), GALAXY (06-15), MAVERICK (01-07), MONDEO (93-15), PUMA (97-02), S-MAX (06-15), TOURNEO CONNECT (02-06), TRANSIT (06-12), TRANSIT CONNECT (02-06). MAZDA: 121 ZG (95-00), 2 DY (02-07), 3 BK (03-09), 3 BL (09-15), 5 CR (05-10), 5 CW (10-12), 6 GG/GY (02-07), 6 GH (07-15), MPV LW (02-05), MX-5 NC (05-16), TRIBUTE EP (04-06). VOLVO: C30 (06-13), S40 (06-12), S80 (07-11), V50 (04-12).
OEM WERKZEUG	FORD: 303-1054, 303-507 (21-210), 303-620 (21-163), 303-574, 303-748, 303-376 (21-162B), 303-376B MAZDA: 49 JE01 061, 303-574, 49 JE02 061, 303-465, 49 JE01 054 VOLVO: 999 7152, 999 7151.
MOTORCODES	1.4 / 1.6

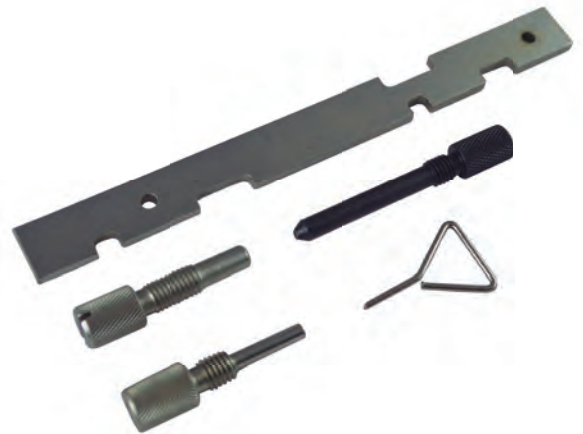

53653

207,00€

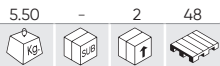

MOTOREINSTELLUNG WERKZEUG SET FORD

MODELLE	FORD: FIESTA, FOCUS, B-MAX, ECOSPORT.
OEM WERKZEUG	303-1605 (1), 303-1606 (2), 303-1604 (3), 303-1602 / 503-393A / (21-168) (4), 303-1054 (5), 303-732 (6)
MOTORCODES	M1DD, M1JA, M1JC, M1JE, M1JHM1JJ, M1DA, M2DA, M2DB, M2DC, SFDBSFJA, SFJB, SFJC, SFJD

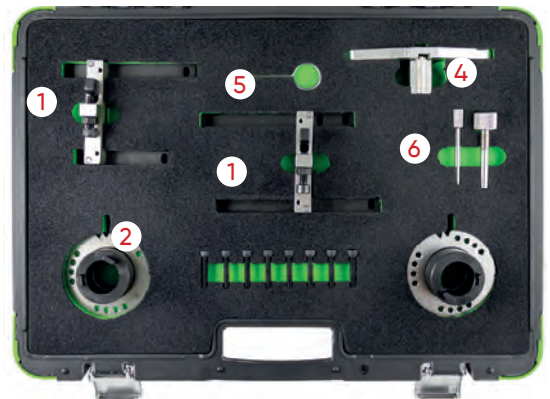

54201

37,60€

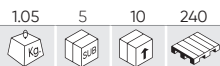

WERKZEUGSATZ FÜR MOTORSTEUERUNG FORD

MODELLE	FORD: C-MAX(07 - 10), C-MAX/GRAND C-MAX(10-18), FIESTA(08-18), FOCUS/FOCUS C-MAX(04-11), FOCUS(11-18), MONDEO(07-15)
OEM WERKZEUG	303-1097 (1), OEM 303-1054 (2), OEM 303-1059, 303-1270, 0188X, 999-7121 (3), OEM 303-748, 999-7152, 21-259 (4), OEM 303-735, 999 7122, 0187B, 0189B, 0132AJ1, 21-263, 0188M, MOT 1430, 303-1277, 0194B (5)
MOTORCODES	11.6 TI-VCT HXDA (2003-2007), 2.0 TDCI, G6DA, G6DB, G6DC 2003-2007



54204

124,00€

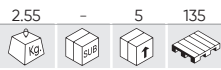

WERKZEUGSATZ FÜR MOTORSTEUERUNG FÜR FORD 2.0 ECOBLUE

MODELLE	FORD EDGE, FOCUS, GALAXY, S-MAX (FROM 2018); KUGA, MONDEO, RANGER (DESDE 2019); TRANSIT, TRANSIT CUSTOM AND TOURNEO CUSTOM (DESDE 2016); TODOS CON MOTOR ECOBLUE TDCI ; AWD, FWD Y RWD.
OEM WERKZEUG	303-1637 (1), 303-1650 (2), 303-1643 (3).
MOTORCODES	BCCC,YLCB,YLDA,YLF6,YLFA,YLFB,YLFS,YLR6,YLRA,YMCB,YM-F6,YMFA,YMFB,YMFS,YMHA,YMRA,YNCA,YNF6,YNFA,YNFB,YNFS,Y-NR6,YNRA

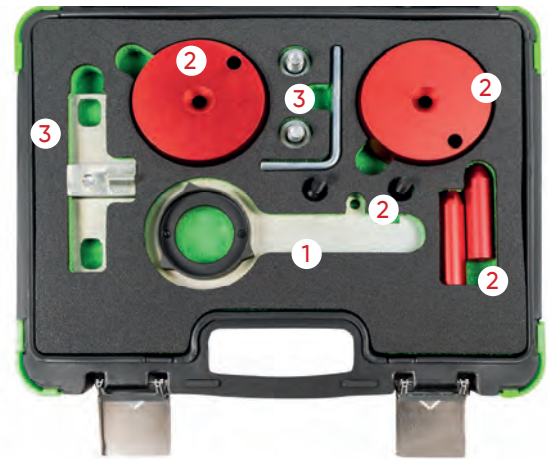

54208

76,00€

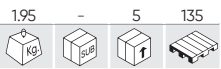

WERKZEUGSATZ FÜR MOTORSTEUERUNG FÜR FORD 2.0 ECO BOOST SCTI, TI-VCT

MODELLE	<u>FORD</u> : GALAXY(2010)MONDEO (2010) S MAX (2010) FOCUS(2011)
OEM WERKZEUG	303-748 (1), 303-1504 (2), 303-1565 (3), 303-1521 (4)
MOTORCODES	TNWA, TNWB, TPWA, TNBA, TPBA, MGDA, XQDA



54209

29,70€



WERKZEUGSATZ FÜR MOTORSTEUERUNG FÜR FORD/MAZDA 2.2, 3.2 TDCI

MODELLE	FORD_RANGER 3.2L (2011-2016) FORD_RANGER 2.2L (2011-2015) FORD_TRANSIT 2.2L (2006-2016) FORD_EVEREST 3.2L (2015) FORD_RANGER 3.2L (2011) MAZDA BT-50 (2011) MAZDA BT-50 3.2L (2011-2016)
OEM WERKZEUG	303-675/21-234,303-698/21-251 (1), 303-1587 (2)
MOTORCODES	CYFA,CYFB,DRFA,DRFB,P8FA,P8FB,PGFA,PGFB,QVFA,QWFA,SR-FA,SRFB,SRFC,SRFD,SEFE,UHFA,CYFC,DRFC,USRA

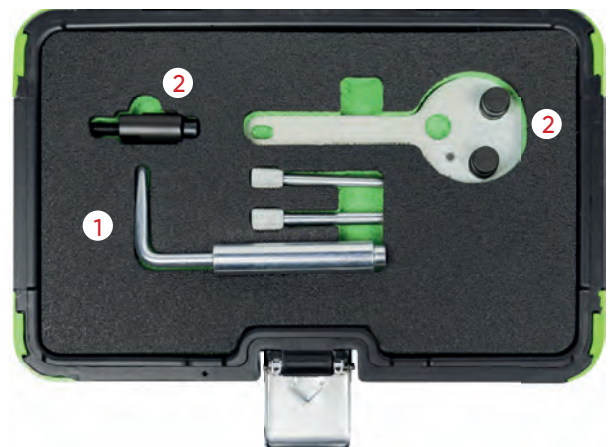

54223

149,00€

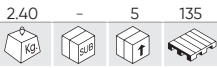

VERRIEGELUNGSWERKZEUG FÜR MOTOR-NOCKENWELLENRAD FÜR FORD 1.5T

MODELLE	FORD_1,5L DURATEC, ECOSPORT, FIESTA, FOCUS
OEM WERKZEUG	303-1639 (1), 303-1643 (2), 303-1647 (3), 303-1648 (4)
MOTORCODES	2.2 / 2.5

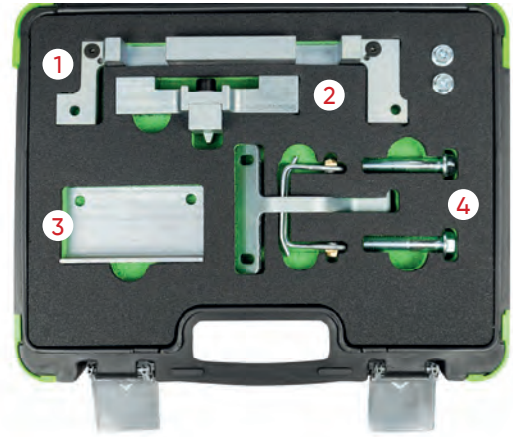

54224

64,50€

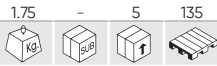

DEMONTAGE- UND INSTALLATIONSWERKZEUG FÜR FORD 2.0 EINSPRITZPUMPEN

MODELLE	FORD: TRANSIT (17-18), TOURNEO CUSTOM (16-18), TRANSIT CUSTOM (16-18)
OEM WERKZEUG	303-1635 (1)/3, 3.3--1635 (2)/1, 303-1635 (3)/2, 303-1635/6 (4)
MOTORCODES	YLFS, YMFS, YNFS, YLF6, YMF6, YNF6, YLR6, YMR6 AND YNRS.

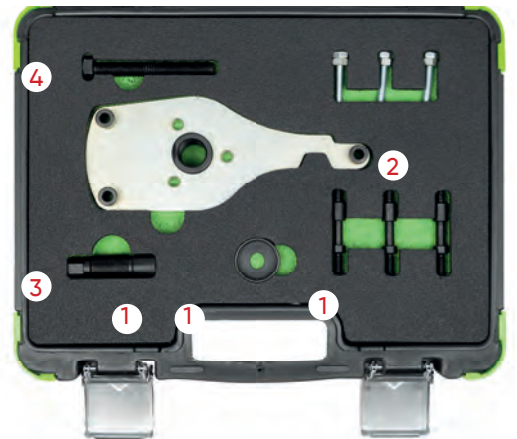

54260

277,00€

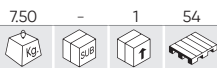

DREHMOMENT-MULTIPLIKATOR-SET 5:1 FÜR FORD ECOBOOST-MOTOREN



1.0 Ecoboost 2.0 Durator-TDCi
 1.0 Duratec 2.0 EcoBlue Diesel
 2.0 Duratec



53297

45,00€

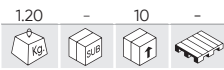

MOTOREINSTELLUNG WERKZEUG SET JAGUAR / LAND ROVER

MODELLE	JAGUAR: MS TYPETDVI. LAND ROVER: DISCOVERY 2.7 TDV6. RANGE ROVER: SPORT 2.7 TDV6.
OEM WERKZEUG	303-1117 (1), 303-1116 (2), 303-1132 (3), 303-1126 (4) (5)
MOTORCODES	276DT, 306DT.

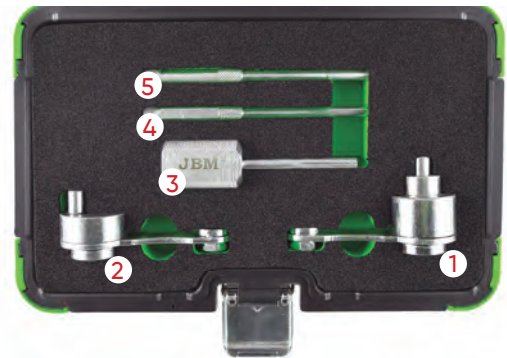

53298

91,00€

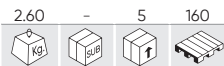

MOTOREINSTELLUNG WERKZEUG SET LAND ROVER

MODELLE	Diesel: 200 TDI. 300 TDI. 2.5
---------	-------------------------------

- Neue Stange zum Einstellen des Einspritzzeitpunktes, mechanisches Getriebe EDC 200 TDI. 300 TDI. 2.5 auf Diesel
- Kurbelwellen-Entferner.
- Vorrichtung zum Verriegeln des Zahnrad der Kraftstoffpumpe.
- Stange zum Einstellen des Einspritzzeitpunktes der Kraftstoffpumpe 200/300 TDI.
- Vorrichtung zum Einstellen des Schwungrades 200/300 TDI.
- Vorrichtung zum Einstellen der Zündung der Kraftstoffpumpe DPS, 2.5.
- Vorrichtung zum Einstellen des Schwungrades 2.5.
- Stange zum Einstellen des Einspritzzeitpunktes EDC-30Q, mechanisches Getriebe.



54422

140,00€



KIT ZUR AUSGLEICHSACHSENEINSTELLUNG JAGUAR/LAND ROVER 2.0D

MODELLE	JAGUAR: E-PACE D150, D180, D240 (X540) (2017-), F-PACE 20D, 25D, E-PERFORMANCE (X761) (2016-), XE 20D, 25D, E-PERFORMANCE (X760) (2015-), XF 20D, 25D, E-PERFORMANCE (X260) (2015-) LAND ROVER: DEFENDER SD4 D200, SD4 D240 (L663) (2019-2021), DISCOVERY SPORT ED4, SD4, TD4, D150, D180, D240 MHEV (L550) (2015-), DISCOVERY SD4, TD4 (L462) (2017-2021) RANGE ROVER: EVOQUE ED4, SD4, TD4 (L538) (2015-2019), EVOQUE D150, D180, D240 MHEV (L551) (2019-), SPORT SD4 (L494) (2016-2018), VELAR D180, D240 (L560) (2017-)
OEM WERKZEUG	JLR-303-1662 (1) JLR303-1663-1 (2) JLR303-1663-2 (3) JLR303-1663-3 (4) JLR-303-1664 (5) JLR-303-1665 (6)
MOTORCODES	2.0: AJ200D,AJ200/204DTA,AJ200/2004DTD 2.0: AJ-200D/204DT, AJ-200D/204DTA



54423

108,00€

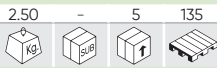

N

MOTOR-EINSTELLWERKZEUG SATZ FÜR LAND ROVER 3.6D

MODELLE	RANGE ROVER SPORT; 3.6 (TDV8) DIESEL (2006-2011) RANGE ROVER; 3.6 (TDV8) DIESEL (2006-2011)
OEM WERKZEUG	303-1236 (1) 303-1243 (2) 303-1239 (3) 303-1238 (4)
MOTORCODES	368DT

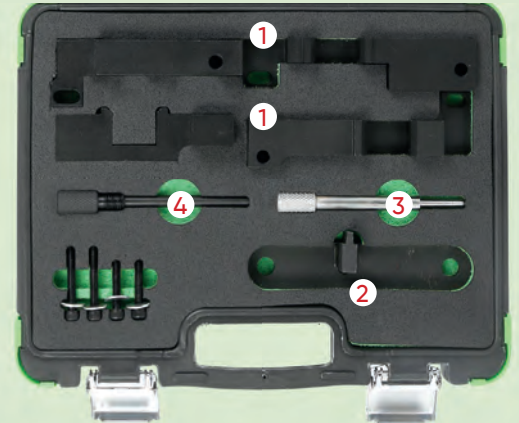

54425

124,00€

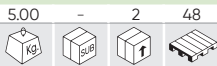

N

MOTOR-EINSTELLWERKZEUG SATZ FÜR LAND ROVER FREELANDER V6/ROVER KV6 2.0L, 2.5L

MODELLE	LAND ROVER: FREELANDER (2000-2006) MG: ZR (2004-2005), ZS (2001-2005), ZT (2001-2005) ROVER: 45 (1999-2005), 75 (1999-2005), 825 (1996-1999)
OEM WERKZEUG	LRT 12-175 (1) LRT 12-187 (2) LRT 12-195 (3) LRT 12-196 (4) LRT 12-198 (5) LRT 12-232 (6)
MOTORCODES	LAND ROVER: 2,5 KV6 MG: 2,0 KV6, 2,5 KV6 ROVER: 2,0 KV6 2,5 KV6

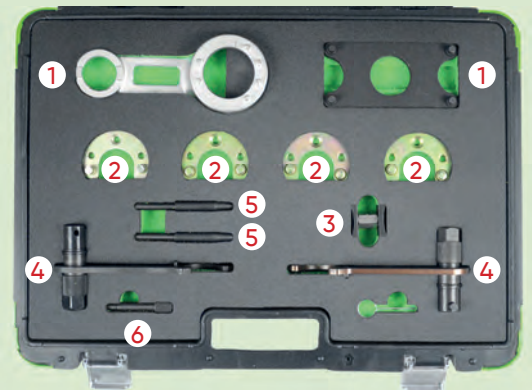

54426

69,00€



N

MOTOR-EINSTELLWERKZEUG SATZ FÜR JAGUAR/LAND ROVER 3.2, 3.5, 4.0, 4.2, 4.4

MODELLE	DAIMLER: V8 (97-03), SUPER V8 (97-03), SUPER EIGHT (05-10). JAGUAR: S-TYPE (99-08), XF (08-09), XJR (97-10), XJ8 (97-10), XKR (98-09), XK8 (96-09) LAND ROVER: DISCOVERY III (04-09) RANGE ROVER (05-09), RANGE ROVER SPORT (05-09)
OEM WERKZEUG	303530 (1) 303531 (2) 303532 (3) 303533 (4) 303645 (5) 303654 (6) T40011 (7)
MOTORCODES	3.2: AC,KB,KC 3.5: RB 4.0: BC, CC,CE,DC,EC,GB,GC,LB,LC,MA,MB,NB,NC,PA,PB 4.2: 1B,2B,3B,1G,5G,9G,HB,HG,SB,TB,PC,428PS 4.4: 448PN



54427

113,00€

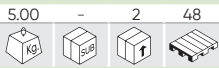

N

KURBELWELLENRIEMENSCHLEIBEN-SICHERUNGSWERKZEUG JAGUAR/LAND ROVER 4.0, 4.2, 4.4

MODELLE	DAIMLER: V8; 4.0 (97-98) JAGUAR: S-TYPE; 3.2, 3.5, 4.2 V8 (99-08), XF; 3.2, 3.5, 4.2 V8 (08-09), XJ; 3.2, 3.5, 4.2 V8 (97-08), XJ8; 4.0 (97-98), XK; 3.2, 3.5, 4.2 V8 (97-08), XK8; 4.0 (97-98) LAND ROVER: DISCOVERY3; 4.2, 4.4 LA V8 (05-09) RANGE ROVER; 4.2, 4.4 SPORT LS V8 (05-09), RANGE ROVER; 4.2, 4.4 LM V8 (06-08)
OEM WERKZEUG	LRT 12 080 18G 1437 18G 1437 2 303 191 303 191 03 303 191 04 303 588 303 893
MOTORCODES	AJ26, AJ27, AJ28, AJ34 30G,36D,42D,56D,58D,94D,428PS,448PN



54428

31,00€

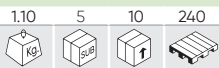

N

MOTOR-EINSTELLWERKZEUG SATZ FÜR CHRYSLER/JEEP 2.8 CRD

MODELLE	CHRYSLER GRAND VOYAGER 2008 - 2015 DODGE NITRO 2007 - 2011 JEEP CHEROKEE 2008 - 2013, WRANGLER 2007 - 2018
OEM WERKZEUG	VM 9991 (1) VM 9992 (2)
MOTORCODES	VM64C, ENS, ENS (51C), 49C, 50C, ENS VM10D, ENS VM11D



54429

55,00€



N

MOTOR-EINSTELLWERKZEUG SATZ FÜR CHRYSLER/JEEP 3.0D

MODELLE	CHRYSLER 300 C 2012 - 2015 JEEP GRAND CHEROKEE 2011 - ON
OEM WERKZEUG	VM 10338 1 (1) VM 10338 2 (2) VM 10359A (3), VM 10359 (3) VM 10339 (4), VM 10359 (4)
MOTORCODES	3.0 CRD: EXF 3.0 CRD/MULTIJET: EXF VM23D, EXF VM44D, EXF VM44D, EXF VM63D

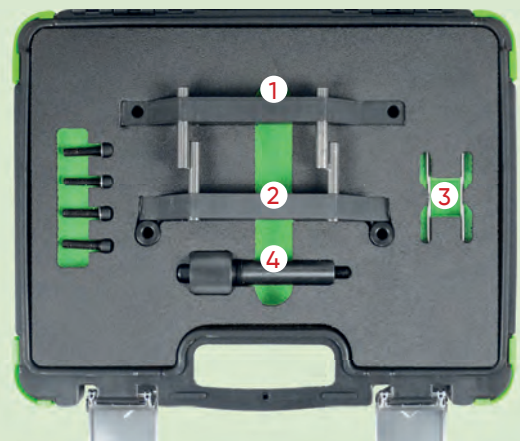

54207

38,90€

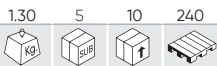

WERKZEUGSATZ FÜR MOTORSTEUERUNG FÜR CHRYSLER/JEEP LDV 2.5 CRD

MODELLE	CHRYSLER: VOYAGER (01-08), GRAND VOYAGER (01-08) JEEP: CHEROKEE (01-08) LDV: MAXUS (05-09)	
OEM WERKZEUG	VM 9660 (1), VM1052 (2), VM1053 (3), VM1068 / VM1089 (4), VM1080 (5), VM8873 (6)	
MOTORCODES	2.5D CRD: R2516C, R2516K, R2516LVM39/40B.	2.8D CRD: R2816C5.05A, R2816K4.

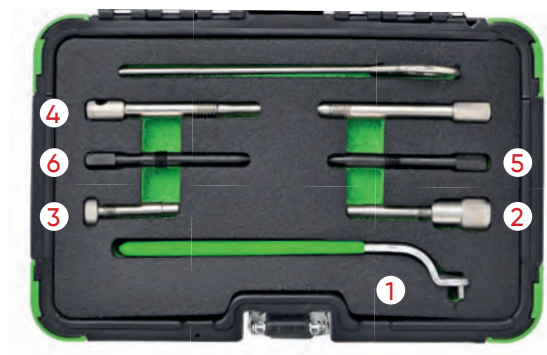

53270

70,00€

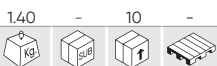

MOTOREINSTELLUNG WERKZEUG SET MERCEDES/CHRYSLER/JEEP

MODELLE	MERCEDES CHRYSLER JEEP
OEM WERKZEUG	112589034000 (1), 601589024000 (2), 111589031500 (3)
MOTORCODES	HERR.: 112 589 03 40 00; 112, 113, 137, 155, 156, 272/979, 273, 629, 642/992. HERR.: 601 589 02 40 00: 102, 103, 104, 111, 601, 602.91/93/94/96/983, 603.91/93/96/97, 604, 605, 606, 611, 612/965/966, 613. HERR.: 111 589 03 15 00: 111, 119, 604, 605, 606, 611/980, 612, 613, 628, 629, 640, 642/922, 612.965/966, 646, 647, 648 .

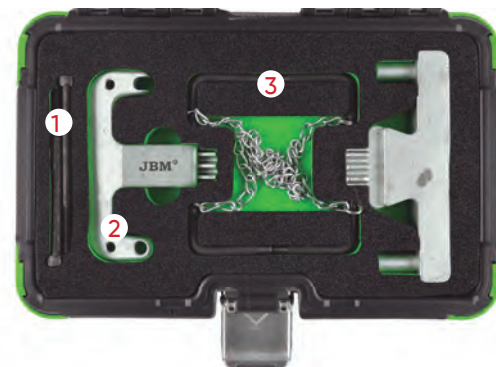

53271

227,00€



MOTOREINSTELLUNG WERKZEUG SET MERCEDES BENZ M271

MODELLE	MERCEDES
OEM WERKZEUG	271 589 003100 (1), 271589014000 (2), 271589001500 (3), 156589006100 (4)
MOTORCODES	M271. E18ML 2002. DE18ML 2003 - 2005. E16ML 2008. DE18LA 2009.

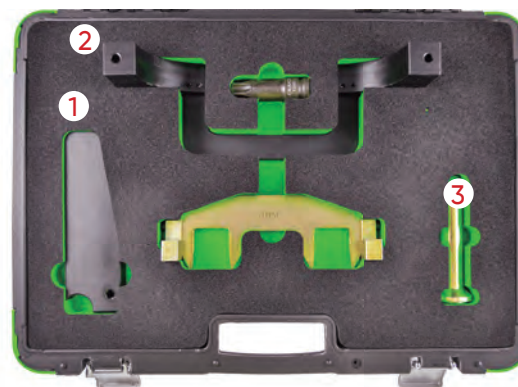

53272

195,00€

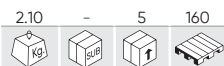

MOTOREINSTELLUNG WERKZEUG SET MERCEDES BENZ AMG 156

MODELLE	MERCEDES
OEM WERKZEUG	156589006100 (1), 156589003200 (2), 156589016300 (3), 156589006900 (4)
MOTORCODES	BENZ AMG 156.ML 63 AMG.S 63L AMG.S 63. AMG. R 63 AMG L 4MATIC. R63 AMG 4MATIC. E 63 AMG. CLS 63 AMG. CLK 63 AMG BLACK SERIES. CLK 63 AMG CABRIO. CL 63 AMG.

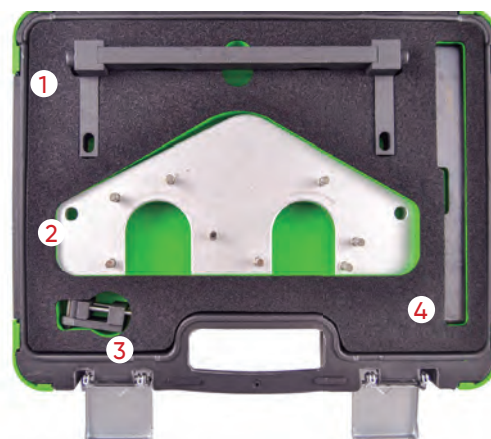

53273

75,00€



MOTOREINSTELLUNG WERKZEUG SET MERCEDES M276, M157, M278

MODELLE	MERCEDES		
OEM WERKZEUG	27658901400		
MOTORCODES	<table border="0"> <tr> <td>CL 500 / 63 AMG (C 216) 2010–2013. S 500 / 63 AMG (C 217) 2014. CLS 300 (C 218) 2012. E 300 / 350 / 400 (C/A 207) 2011. CLS 350 / 400 / 500 / 63 AMG (C/X 218) 2011–2014. SLK 350 (R 172) 2011. SL 350 / 400 / 500 / 63 AMG (R 231) 2012. S 500 PLUG-IN HYBRID (V 222) 2014. ML 300 / 350 / 500 / 63 AMG (W 166) 2011.</td> <td>C 400 (W 205) 2014. E 400 HYBRID (W 212) 2012. G 63 AMG (W 463) 2012. E 300 / 350 / 400 / 500 / 63 AMG (W/S 212) 2011. C 350 (W/S/C 204) 2011. S 350 / 500 / 63 AMG (W/V 221) 2010. S 400 / 63 AMG (W/V 222) 2013. R 350 BlueEFFICIENCY (W/V 251) 2012. GL 450 / 500 (X 166) 2012. GLK 350 (X 204) 2011.</td> </tr> </table>	CL 500 / 63 AMG (C 216) 2010–2013. S 500 / 63 AMG (C 217) 2014. CLS 300 (C 218) 2012. E 300 / 350 / 400 (C/A 207) 2011. CLS 350 / 400 / 500 / 63 AMG (C/X 218) 2011–2014. SLK 350 (R 172) 2011. SL 350 / 400 / 500 / 63 AMG (R 231) 2012. S 500 PLUG-IN HYBRID (V 222) 2014. ML 300 / 350 / 500 / 63 AMG (W 166) 2011.	C 400 (W 205) 2014. E 400 HYBRID (W 212) 2012. G 63 AMG (W 463) 2012. E 300 / 350 / 400 / 500 / 63 AMG (W/S 212) 2011. C 350 (W/S/C 204) 2011. S 350 / 500 / 63 AMG (W/V 221) 2010. S 400 / 63 AMG (W/V 222) 2013. R 350 BlueEFFICIENCY (W/V 251) 2012. GL 450 / 500 (X 166) 2012. GLK 350 (X 204) 2011.
CL 500 / 63 AMG (C 216) 2010–2013. S 500 / 63 AMG (C 217) 2014. CLS 300 (C 218) 2012. E 300 / 350 / 400 (C/A 207) 2011. CLS 350 / 400 / 500 / 63 AMG (C/X 218) 2011–2014. SLK 350 (R 172) 2011. SL 350 / 400 / 500 / 63 AMG (R 231) 2012. S 500 PLUG-IN HYBRID (V 222) 2014. ML 300 / 350 / 500 / 63 AMG (W 166) 2011.	C 400 (W 205) 2014. E 400 HYBRID (W 212) 2012. G 63 AMG (W 463) 2012. E 300 / 350 / 400 / 500 / 63 AMG (W/S 212) 2011. C 350 (W/S/C 204) 2011. S 350 / 500 / 63 AMG (W/V 221) 2010. S 400 / 63 AMG (W/V 222) 2013. R 350 BlueEFFICIENCY (W/V 251) 2012. GL 450 / 500 (X 166) 2012. GLK 350 (X 204) 2011.		



54318

105,00€

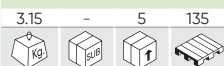

STEUERKETTENNIETMASCHINE

MODELLE	CHRYSLER JEEP MERCEDES
OEM WERKZEUG	112 589 026 300 (1) 103 589 016 300 (2) 602 589 026 300 (3) 602589023300 (4) 602589003900 (5) 602589046301 (6)
MOTORCODES	CHRYSLER/JEEP: 2.2D, 2.7D, 3.0D CRD (DIESEL). MERCEDES: 1.7D, 2.1D, 2.2D, 2.7D, 3.0D, 3.2D, 3.9D, 4.0D CDI (DIESEL)

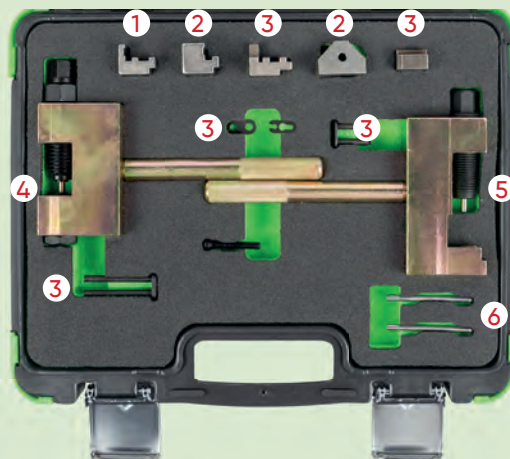

54414

97,50€

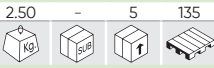

N

MOTOR-EINSTELLWERKZEUG SATZ FÜR MERCEDES M651

MODELLE	A CLASS (2012-2018), B CLASS (2012-2019), C CLASS (2009-2015), C CLASS (2014-2018), CLA COUPE (2013-2019), CLS (2011-2018), E CLASS (2009-2016), GLA (2014-2020), GLC (2015-2019), GLE (2015-2019), GLK (2008-2015), M CLASS (2011-2015), S CLASS (2010-2013), S CLASS (2013-2017), SLC (2016-2017), SLK (2012-2016), SPRINTER (2009-2018), SPRINTER (2018-), V CLASS (2014-), VIANO (2010-2015), VITO (2010-2015), VITO (2014-) MERCEDES-BENZ
OEM WERKZEUG	608 31 800 (1) 608 31 830 (2) 608 31 810 (3) 608 31 820 (4) 651 589 00 40 00 (5)
MOTORCODES	1.8: 651.901 2.1: 651.900, 651.910, 651.911, 651.912, 651.913, 651.916, 651.921, 651.922, 651.924, 651.930, 651.940, 651.950, 651.955, 651.956, 651.957, 651.958, 651.960, 651.961, 651.980 2.2: 651.925

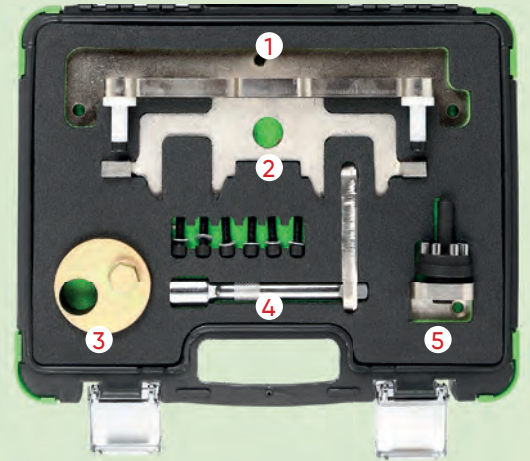

54415

60,00€

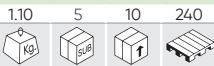

N

MOTOR-EINSTELLWERKZEUG SATZ FÜR MERCEDES M651

MODELLE	GLA X156 200/220 CDI, GLK X 204 200/220/250 CDI, ML W166 250, SLK R172 250 CDI, SPRINTER W906 210/310/510/213/313 CDI, SPRINTER W906 513/216/316/416/516 CDI, V-CLASS W/V 639 2.0/2.2 CDI, VITO W/V 639 110/113/116 CDI MERCEDES-BENZ: A-CLASS W176 180/200/220 CDI, B-CLASS W246 200/220 CDI, C-CLASS W/S/C 204 180/200/220/250 CDI, CLA C117 200/220 CDI, CLD C/X 218 220/250, E-CLASS W/S 212 200/220/250 CDI E-CLASS C/A 207 220/250 CDI, E-CLASS W212 250/300 BLUETEC
OEM WERKZEUG	651589004000 (1) 651589014000 (2)
MOTORCODES	1,8 651.901 2,1 651.900 651.910 651.911 651.912 651.913 651.916 651.921 651.922 651.924 651.925 651.930 651.940 651.950 651.955 651.956 651.957 651.958 651.960 651.961 651.980



54416

31,00€



N

MOTOR-EINSTELLWERKZEUG SATZ FÜR MERCEDES M642

MODELLE	G-CLASS (461/463) 2007-2015, GL-CLASS (164/166) 2006-2016, GLE/GLE COUPE (166/292) 2020 GLK (204) 2008-2015, GLS (166) 2016-2019, M-CLASS (164/166) 2005-2015, R-CLASS (251) 2005-2013, S-CLASS (221/222) 2005-2017, SPRINTER (906) 2006-2018, VIANO (639) 2005-2015, VITO (639) 2006-2015 MERCEDES-BENZ: C-CLASS (203/204) 2004-2014, CLK (209) 2005-2009, CLS (219/218) 2005-2018, E-CLASS (211/212/213) 2005-2018, E-CLASS COUPE/CABRIOLET (207) 2009-2017
OEM WERKZEUG	642589003100 (1)
MOTORCODES	642.820 642.822 642.826 642.830 642.832 642.834 642.835 642.836 642.838 642.850 642.852 642.853 642.854 642.855 642.856 642.858 642.861 642.862 642.867 642.868 642.870 642.872 642.884 642.886 642.890 642.896 642.910 642.920 642.921 642.922 642.930 642.932 642.940 642.950 642.960 642.961 642.970 642.975 642.990 642.992 642.993

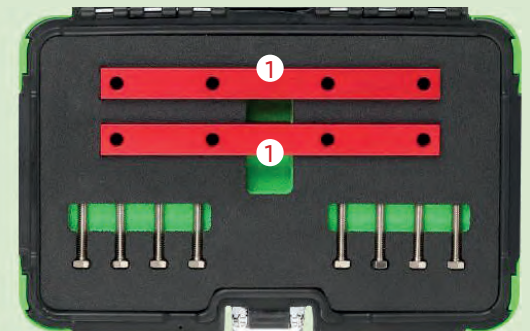

54417

153,00€



N

MOTOR-EINSTELLWERKZEUG SATZ FÜR MERCEDES M133, M270, M274

MODELLE	MERCEDES.BENZ A -CLASS (W176) (2012), MODEL A180/A200 MERCEDES.BENZ B CLASS (W246) AS OF 2011, MODEL B180/ B200
OEM WERKZEUG	270589006100 (1)
MOTORCODES	M133 M270 M274

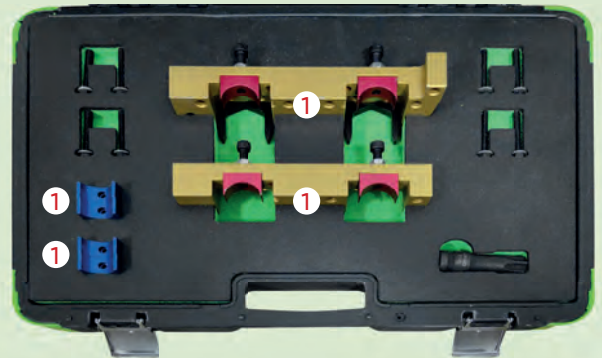

54418

37,00€



N

MOTOR-EINSTELLWERKZEUG SATZ FÜR MERCEDES M112, M113

MODELLE	C-CLASS (202) 2.4/2.6/2.8/3.2/4.3 - 1998-00, CLK (208) 3.2/4.3/5.4 - 1997-03, E-CLASS (210) 2.4/3
OEM WERKZEUG	112589003200 (1) 112589013200 (2) 112589000100 (3)
MOTORCODES	MERCEDES.BENZ: M112, M113

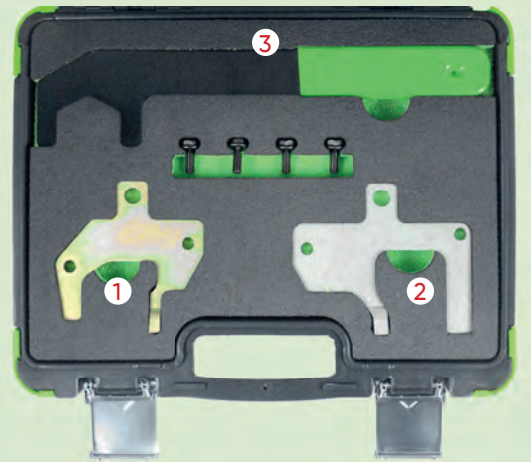

51488

16,00€

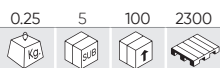

KURBEL-/NOCKENWELLENBLOCKIERER RENAULT/NISSAN/DACIA/SUZUKI

MODELLE	RENAULT: CAPTUR, CLIO II,III,IV, ESPACE/GRAND ESPACE III,IV, FLUENCE, KADJAR, KANGOO, LAGUNA I,II,III, LOGAN/ LOGAN MCV, MEGANE I,II,III,IV, MODUS/GRAND MODUS, SCENIC/ GRAND SCENIC I,II,III,IV, TWING II, TRAFIC II, MASTER II 1.5DCI & 1.9 DCI. DACIA: DOKKER, DUSTER, LODGY, LOGAN, SANDERO 1.5DCI NISSAN: ALMERA, CUBE, JUKE, KUBISTAR, MICRA, NOTE, NV200/EVALIA, PRIMERA, TIIDA, INTERSTAR, PRIMASTAR 1.5DCI & 1.9 DCI SUZUKI: GRAND VITARA, JIMNY 1.5DDIS & 1.9DDIS
OEM WERKZEUG	MOT1489, MOT1430, MOT1054.
MOTORCODES	K9K, F8Q, F9Q - Benzin, Clio, R19, Laguna 1.8/2.0 Codes der Motoren: F3R F3P



53289

45,00€

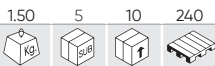

MOTOREINSTELLUNG WERKZEUG SET RENAULT 1.4, 1.6, 1.8, 2.0 16V

MODELLE	<p>RENAULT: ESPACE/GRAND ESPACE (98-02), ESPACE/GRAND ESPACE IV (02-10), KANGOO/TREKKA (01-09), LAGUNA (98-01), LAGUNA II (01-07), LAGUNA III (07-13), MEGANE (99-03), MEGANE II (02-10), MEGANE III/SPORT (08-13), MEGANE/SCENIC (99-00), SCENIC/RX4 (99-03), SCENIC/GRAND SCENIC II (03-09), TRAFIC II (01-11), TWINGO II (08-14), VEL SATIS (00-10), WIND (10-14)</p> <p>DACIA: LOGAN/MCV (05-11).</p> <p>NISSAN: KUBISTAR X76 (03-09), PRIMASTAR (02-11).</p> <p>VAUXHALL/OPEL: JETTA, TOURAN, GOLF, GOLF PLUS, POLO, PASSAT, TIGUAN, SCIROCCO.</p>
OEM WERKZEUG	MOT1489 (1), MOT1054 (2), MOT1496 (3)
MOTORCODES	<p>1.4 16V K4J: 730, 732, 740.</p> <p>1.6 16V K4M: 752, 753, 760, 761, 764, 788, 812, 813, 854, 856.</p> <p>1.8 16V F4P: 720, 722, 760, 770, 771, 772, 773, 774, 775.</p> <p>2.0 16V F4R: 700, 701, 712, 713, 714, 715, 720, 722, 730, 732, 736, 738, 740, 741, 744, 746, 747, 762, 763, 764, 765, 766, 767, 770, 771, 780, 790, 791, 792, 820, 830, 832, 867.</p> <p>2.0 16V F4R(11): 720, 722, 764, 765, 774, 776, 784, 786, 787, 794, 795, 796, 797, 800, 802, 810, 811, 870, 872, 874, 886, 887, 896, 897.</p>

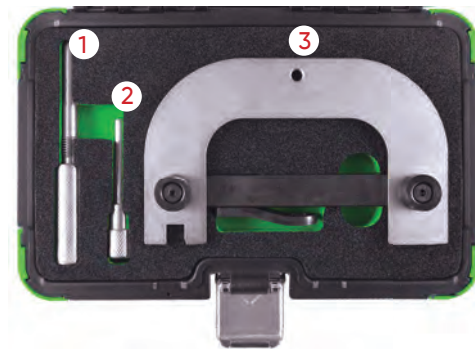

53290

51,00€

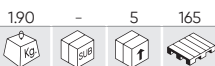

MOTOREINSTELLUNG WERKZEUG SET RENAULT/VOLVO 16V, 20V

MODELLE	<p>RENAULT: LAGUNA 2.0 16V / 2.5 20V (1996-1999), SAFRANE 2.0 16V / 2.5 20V (1996-2001)</p> <p>VOLVO: 850 (1992-1997), C70 (1998-2002), S40 (1996-2004), V40 (1996-2004), S60 (2001-2005), S70 (1997-2000), S80 (1999-2005).</p>
OEM WERKZEUG	MOT1348 (1), MOT1337 (2), MOT1340 (3)
MOTORCODES	<p>RENAULT: N7Q 704/710/711(2.0 16V), N7U 700/701(2.5 20V).</p> <p>VOLVO: B4164S, B4164S2, B4184S, B4184S2, B4184S3, B4184S9, B4184S10, B4194T, BS194T2, B420S4, B4204S2, B4204T, B4204T2, B4204T3, B4204T5, B5202FS, B5204FT, B5204T2, B5204T3, B5204T4, B5204T5, B5234FS, B5204FT, B5234T3, B5234T4, B5234T5, B5234T6, B5234T7, B5234T8, B5234T9, B5244S, B5244S2, B5244SG, B5244SG2, B5244T, B5244T3, B5244T4, B5244T5, B5244T7.</p>

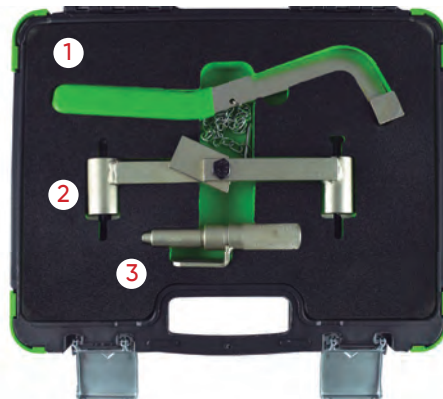

53291

68,00€



MOTOREINSTELLUNG WERKZEUG SET RENAULT

MODELLE	RENAULT: CLIO, LAGUNA, MEGANE
OEM WERKZEUG	MOT1496 (1), MOT1489 (2), MOT861/1863 (3), MOT1490(4)
MOTORCODES	K4J, K4M, F4P, F4R.

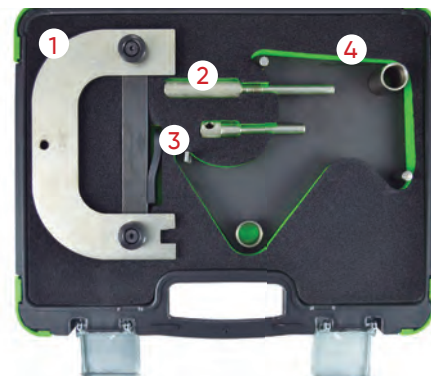

53292

116,00€

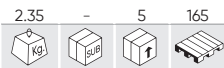

MOTOREINSTELLUNG WERKZEUG SET RENAULT/OPEL 2.2, 2.5 TDI DCI

MODELLE	RENAULT: LAGUNA II, ESPACE, MASTER, TRAFIC, 2.2 / 2.5 DCI OPEL: VIVARO, MOVANO, DIESEL: 2.2 / 2.5 DTI, ASTRA B, VECTRA B, SIGNUM, ZAFIRA, 2.2 16V
OEM WERKZEUG	KM6205 (1), KM6204 (2), KM6077 (3)
MOTORCODES	2.2 / 2.5

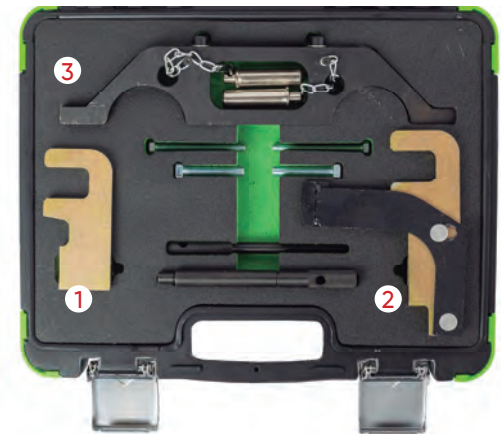

53311

97,00€

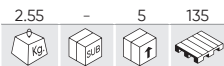

MOTOREINSTELLUNG WERKZEUG SET RENAULT/NISSAN/OPEL/VAUXHALL 2.0, 2.3 DCI, CDTI, M9R, M9T

MODELLE	NISSAN: PRIMASTAR X83 (06-15), QASHQAI/QASHQAI+2 J10 (07-14), X-TRAIL T31 (07-14). VAUXHALL/OPEL: MOVANO-B (10-17), VIVARO (06-15). RENAULT: ESPACE/GRAND ESPACE IV (06-10), KOLEOS (08-15), LAGUNA LL (05-07), LAGUNA LLL (07-14), MASTER LLL (10-15), MEGANE LL (06-10), SCENIC/GRAND SCENIC LL (06-09), SCENIC/GRAND SCENIC LLL (09-15), TRAFIC LL (06-14), VEL SATIS (05-10)
OEM WERKZEUG	MOT1769 (1), EN-48334 (2), MOT1766 (3), EN-48330 (3), KM-6130 (4), EN-48332 (5), MOT1773 (6), EN-48831 (6)
MOTORCODES	2.0D DCI M9R: 630, 780, 782, 784, 786, 788, 830, 832, 833, 834, 835, 836, 838, 855, 856. 2.0D CDTI M9R: 630, 780, 782, 784, 786. 2.3 BI-CDTI: LP6/M9T706, LW7/M9T706. 2.3D DCI M9T: 670, 672, 676, 678, 680, 686, 690, 692, 694, 698.



53523

91,00€



MOTOREINSTELLUNG WERKZEUG SET RENAULT/NISSAN/OPEL 1.6 DCI

MODELLE	RENAULT: ESPACE/GRAND ESPACE IV (06-10), KALEOS (08-11), LAGUNA LL (05-07), LAGUNA LLL (07-12), MASTER LLL (10-12), MAGANE LL (06-10), SCENIC/GRAND SCENIC LL (06-09), SCENIC/GRAND SCENIC LLL (09-12), TRAFIC LL (06-12), VEL SATIS (05-10) NISSAN: PRIMASTAR X83 (06-10), QASHQAI/QASHQAI+2 J10 (07-10), X-TRAIL T31 (07-12). VAUXHALL / OPEL: MOVANO-B (10-12), VIVARO (06-12).
OEM WERKZEUG	MOT1969 (1), MOT1970 (2), MOT1770, MOT1773, EN-48330, EN-48332, EN-48334, EN-48831, KM-6130
MOTORCODES	M9R 2.0DCI: 610, 615, 630, 700, 721, 740, 742, 760, 761, 762, 763, 780, 782, 784, 786, 788, 800, 802, 803, 805, 808, 816, 830, 832, 833. M9T 2.3DCI: 670, 672, 676, 678, 680, 686, 690, 692, 694, 698.



54210

84,00€

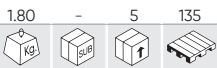

VERRIEGELUNGSWERKZEUG FÜR MOTOR-NOCKENWELLENRAD FÜR RENAULT 1.8, 2.0 16V

MODELLE	RENAULT LAGUNA II (2001 - 2009), MEGANE II (2002 - 2009), Scenic (2002 - 2009)
OEM WERKZEUG	MOT 1509-01 (1), 1509 (2)
MOTORCODES	700, 701, 712, 713, 714, 715, 720, 721, 722, 722, 730, 732, 736, 738, 740, 741, 744, 746, 747, 760, 761, 762, 763, 764, 765, 766, 767, 770, 771, 773, 774, 774, 775, 776, 784, 786, 787, 790, 792, 794, 797, 830, F4P, F4R



54225

133,00€

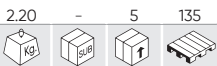

SCHWUNGRAD-/KURBELWELLENRIEMENSCHLEIBEN-VERRIEGLUNGSSATZ FÜR RENAULT/NISSAN

MODELLE	NISSAN: PRIMASTAR (06-15), QASHQAI/QASHQAI+2 (07-14), X-TRAIL (07-14), NAVARA (15-16), NV400 (11-16) RENAULT: ESPACE V (15-16), CLIO (06-16), FLUENCE (09-15), LAGUNA (05-15), LATITUDE (10-15), MEGANE (06-15), SCENIC/ GRAND SCENIC (06-15), ESPACE/GRAND ESPACE IV (02-15), KOLEOS (08-16), TRAFIC II (07-15), VEL SATIS (00-10), MASTER III (10-16)
OEM WERKZEUG	MOT 1431(1), MOT 1716(2), MOT 2019(2), MOT 1789(3), MOT 919-02(4)
MOTORCODES	1.4:H4JT700 1.6:M5M400, M5M450 2.0:M4R700, M4R701, M4R704, M4R711, M4R713, M4R714, 2.0D:M9R726, M9R730, M9R735, M4R737, M9R740, M4R746, M9R742, M9R744, M9R746, M9R748, M4R750, M4R751, M4R752, M4R753, M4R754, M9R610, M9R613, M95615, M9R630, M9R750, M9R760, M9R761, M9R762, M9R762, M9R763, M9R700, M9R721, M9R722, M9R724, M9R756, M9R780, M9R782, M9R800, M9R802, M9R803, M9R804, M9R805, M9R806, M9R808, M9R809, M9R811, M9R812, M9R814, M9R815, M9R816, M9R817, M9R820, M9R824, M9R828, M9R830, M9R832, M9R833, M9R834, M9R835, M9R836, M9R838, M9R839, M9R844, M9R845, M9R846, M9R849, M9R854, M9R855, M9R856, M9R857, M9R858, M9R859, M9R865, M9R866, M9R784, M9R786, M9R788 2.3D:M9T670, M9T672, M9T676, M9T678, M9T680, M9T686, M9T690, M9T692, M9T694, M9T696, M9T698, M9T700, M9T702, M9T706, M9T708, M9T870, M9T880, M9T890, M9T896, M9T898, M9T899, YS23DDT, YS23DDTT 2.5:2TR700, 2TR702, 2TR703, 2TR704, 2TR705, 2ZV604, V4U604, VQ25 3.5:V4Y701, V4Y711, V4Y713, V4Y715



IHR TIMING TOOL SET NOCH NÄHER

GEBEN SIE DEN CODE DES ORIGINALWERKZEUGS ODER DEN MOTORCODE IHRES FAHRZEUGS IN IHREN WEBBROWSER EIN UND FINDEN SIE IHR KOMPATIBLES STEUERGERÄT

54289

38,00€

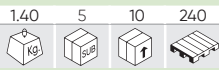

N

SCHWUNGRADSPERRE KIT FÜR MERCEDES/RENAULT/DACIA/NISSAN

MODELLE	DACIA DOKER 2015 + DACIA DUSTER 2015+ DACIA LODGY 2015+ DACIA LOGAN 2013/-2020 DACIA SANDERO 2013+ MERCEDES-BENZ A-CLASS 2018+ MERCEDES-BENZ B-CLASS 2019+ MERCEDES-BENZ CLA 2019+ MERCEDES-BENZ GLA 2019+ MERCEDES-BENZ GLB 2019+ RENAULT ARKANA 2019+ RENAULT CAPTUR 2018+ RENAULT CLIO V 2019 + RENAULT KADJAR 2018+ RENAULT MEGANE IV 2017+ RENAULT SCENIC/GRAND SCENIC IV 2018+ RENAULT TALISMAN 2018+
OEM WERKZEUG	MOT.2188 (1)
MOTORCODES	HR13DDT, H4Bt 400, H4Bt 408, H4Bt 410, H4Bt 411, H4M 730, H4M 738, H4M 740, H5H 450, H5H 470, H5H 480, 282.914



54438

40,00€



N

MOTOR-EINSTELLWERKZEUG SATZ FÜR RENAULT/NISSAN 3.0DCI

MODELLE	NISSAN: NAVARA PICK UP, PATHFINDER, INFITI RENAULT: LAGUNA, LATITUDE
OEM WERKZEUG	MOT 1880 (1) MOT 1970 (2) MOT 1874 (3)
MOTORCODES	V9X, V9X 791, 891

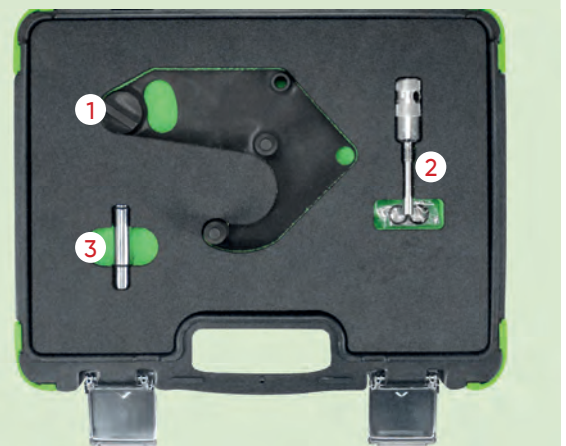

54439

32,50€

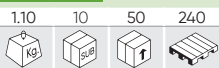

N

KURBELWELLEN RIEMENSCHLEIBENSPERRE RENAULT/DACIA 0.9, 1.0, 1.2, 1.6 TCE

MODELLE	DACIA DOKKER 2012 - 2019, PLUMERO 2013 - 2018, LOGIA 2012 - 2018 RENAULT CAPTURAR 2013 - 2019, CLIO IV 2012 - 2019, KADJAR 2015 - 2018, KANGOO II 2013 - EN, MEGANE III 2012 - 2017, MEGANE IV 2016 - 2020, ESCENICO/GRAN ESCENICO III 2012 - 2017, ESCENICO/GRAN ESCENICO IV 2016 - 2018, TWIN-GO III 2014 - EN
OEM WERKZEUG	MOT. 2006 (1) MOT. 2054 (1) 281589004000 (1)
MOTORCODES	0.9TCE: H4B 453, H4Bt 400, 401, 408, 410, 411, 451. 1.0TCE: H4D, H4D 400, 450, 460, 470 1.2TCE: H5Ft 400, 403, 404, 405, 408, 410, 412. 1.6TCE: H4M 429, 438, 440, 729, 730, 738, 740, 748, 749

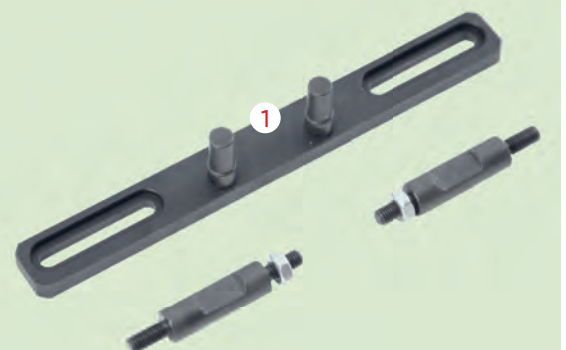

53299

291,00€

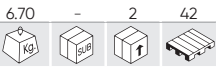

MOTOREINSTELLUNG WERKZEUG SET OPEL / VAUXHALL

MODELLE	OPEL / VAUXHALL
OEM WERKZEUG	EN-46788 (1), KM927 (2), EN-46789 (3), KM929 (4), EN-46785 (5), EN-46788 (6), 1 860 985 000 (7), KM932 (8), KM933 (9), EN-49978 (10), KM933 (11)
MOTORCODES	1.3 CDTI 16V, 1.9 CDTI, 2.0 DTI, 2.2 DTI.



53300

41,00€

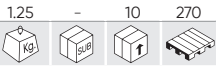

MOTOREINSTELLUNG WERKZEUG SET OPEL / VAUXHALL / CHEVROLET 2,0CDI

MODELLE	OPEL VAUXHALL CHEVROLET
OEM WERKZEUG	EN-48245 (1), EN-48246 (2), 205083060 (3) (4) (5) (6)
MOTORCODES	OPEL / VAUXHALL: Z20DM, Z20DMH CHEVROLET: LLWZ20DMH, RA 420 , Z20SI, Z 20S3, Z 20S4, Z 20S5

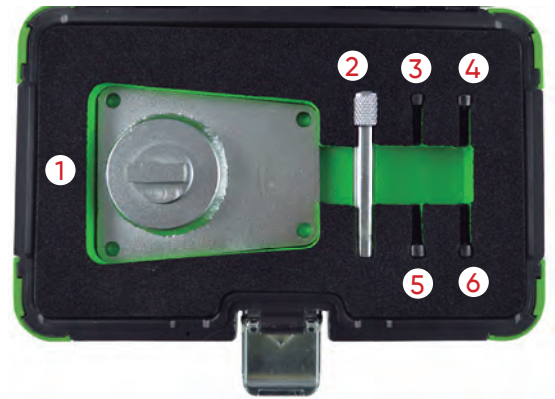

53301

44,00€

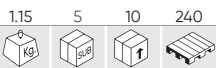

MOTOREINSTELLUNG WERKZEUG SET SUZUKI/OPEL 1.0, 1.2, 1.4

MODELLE	SUZUKI: WAGON R (05-08). VAUXHALL / OPEL: AGILA (00-08), ASTRA-G (98-06), ASTRA G CLASSIC II (03-10), ASTRA-H (04-11), COMBO (04-12), CORSA-B (97-00), CORSA-C (00-07), CORSA-D (06-12), MERIVA-A (04-10), TIGRA-B (04-10).
OEM WERKZEUG	KM-953/09919-58310 (1), KM-952/09912-38310 (2), KM-954/09919-08310 (3), KM-6130 (4), KM-955/09919-58320 (5)
MOTORCODES	1.0 12V: X10XE, Z10XE, Z10XEP. 1.2 16V: X12XE, Z12XE, Z12XEP. 1.4 16V/ECOFLEX: Z14XEL, Z14XEP.

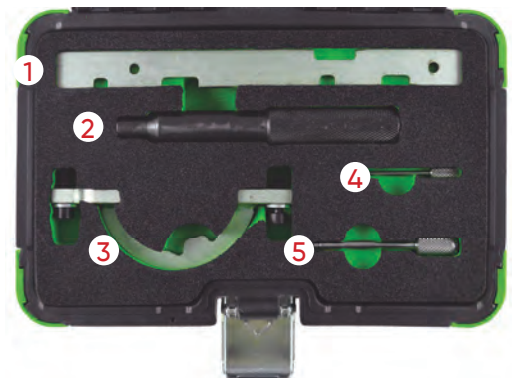

53302

44,00€

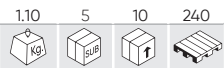

MOTOREINSTELLUNG WERKZEUG SET FIAT/ALFA ROMEO/VAUXHALL/OPEL/SAAB JTD

MODELLE	SAAB: 9-3 (04-08), 9-5 (05-08). VAUXHALL / OPEL: ASTRA-H, VECTRA-C, SIGNUM (04-07), ZAFIRA-B (05-07).
OEM WERKZEUG	EN46789/32 025 008 (1) (3), EN46788/32 025 009 (2), KM6349 (4)
MOTORCODES	Z19DT, Z19DTH, Z19DTL.



53305

136,00€

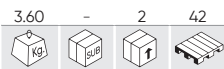

MOTOREINSTELLUNG WERKZEUG SET SAAB / OPEL / VAUXHALL

MODELLE	VAUXHALL / OPEL: ANTARA (06-10), CALIBRA (93-98), CAVALIER/VECTRA-A (93-95), OMEGA-B (94-03), SIGNUM (03-05), SINTRA (96-99), VECTRA-B (95-02), VECTRA-C (02-05). SAAB: 900 (93-98), 9000 (95-97), 9-5 (98-03)
OEM WERKZEUG	KM-800-1 (1), KM-800-2 (2), KM-800-20 (3), KM-800-10 (4), 83 95 006 (5), KM-800-30 (6), MKM-6038, 83 95 006 (7)
MOTORCODES	2.5 V6: SAAB: B2581, VAUXHALL/OPEL: C25XE, X25XE. 2.6 V6: VAUXHALL/OPEL: Y26SE. 3.0 V6: SAAB: B308E, B308I, VAUXHALL / OPEL: X30XE. 3.2 V6: VAUXHALL/OPEL: Y32SE, .



53307

38,50€



MOTOREINSTELLUNG WERKZEUG SET ALFA/OPEL/VAUXHALL 1.6, 1.8 16V

MODELLE	OPEL / VAUXHALL: CORSA-D, AGILA, ASTRA-G-H, MERIVA, ZAFIRA-B, VECTRA-C, SIGNUM, INSIGNA	1.6, 1.8
	CHEVROLET: AVEO, CRUZE, ORLANDO	1.4, 1.6, 1.8
	ALFA ROMEO: 159 FIAT: CROMA	1.8
OEM WERKZEUG	E10290 (1), 23056-06 (2) (3), E10230 (4), 23164-04 (5), 23174-01 (6), 23056-05 (7)	
MOTORCODES	OPEL / VAUXHALL: Z16LEL, Z16LER, Z16LET, Z16XE1, Z16XEP, Z16XER, A16XER, 18XER, A18XER, 2HO/A18XEL. CHEVROLET: G14D, LDD, LXV (F16D4), 2HO(Z18XER). ALFA / FIAT: 939A4.000.	

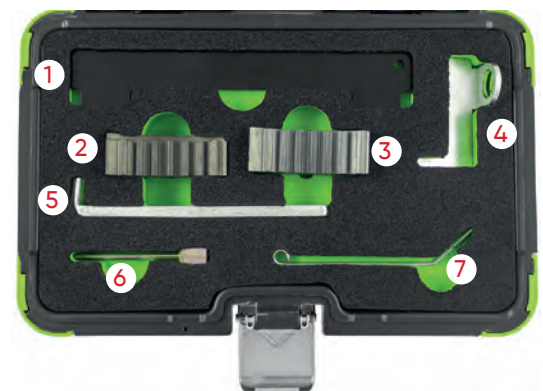

53316

34,00€

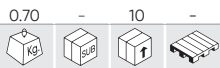
**MOTOREINSTELLUNG WERKZEUG SET FIAT/OPEL/VAUXHALL 2.2 16V KETTEN**

MODELLE	OPEL: ASTRA-G (2000-2006), ASTRA-H (2006-2011), SIGNUM (2003-2008), VECTRA-B (2000-2002, VECTRA-C (2002-2008), ZAFIRA-A (2000-2005), ZAFIRA-B (2005-2012), SPEEDSTER (2000-2006). VAUXHALL: VX220 (2000-2006). FIAT: CROMA (2005-2009).
OEM WERKZEUG	VAUXHALL / OPEL: Z22SE, Z22YH FIAT: 194A1.000.

**53317**

34,00€

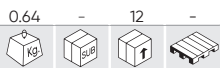
**OPEL/VAUXHALL 2.2 FROSTSCHUTZPUMPENBLOCKER**

MODELLE	OPEL 2.2 Gürtel VAUXHALL 2.2 Gürtel
---------	--

**53452**

26,50€

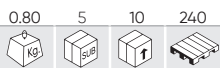
**MOTOREINSTELLUNG WERKZEUG SET OPEL/FORD/FIAT/ ALFA ROMEO/LANCIA/SUZUKI**

MODELLE	VAUXHALL/OPEL 1.3 CDTI: AGILA, CORSA, COMBO (03-08), ASTRA-H(05-08), MERIVA, TIGRA-B(04-08) SUZUKI 1.3 DDIS: IGNIS, WAGON R(03-08), SWIFT(04-08) FORD: 1.3 TDCI FIAT/ALFA ROMEO/LANCIA: 1.3 JTD MULTIJET
OEM WERKZEUG	104-A EN 46781 (1) , EN 46785 (2)

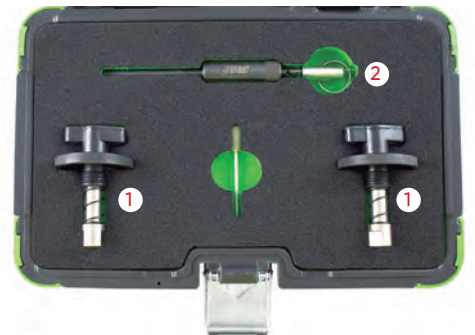
**53651**

91,00€

**MOTOREINSTELLUNG WERKZEUG SET OPEL/VAUXHALL 1.0, 1.2, 1.4 TURBO**

MODELLE	OPEL: ADAM, AMPERA, ASTRA-J, AVEO, CORSA-D, INSIGNIA, MERIVA-B, MOKKA, ZAFIRA-C TOURER
OEM WERKZEUG	EN 49977-100 (1), EN 49977-200 (2), EN 49978 (3), KM 952 (4), KM 953-A (5), KM 955-1 (6), KM 955-2 (7).
MOTORCODES	1.0: A10XEP (LDB) 1.2: A12XEL (LWD), A12XER (LDC) 1.4: A14XEL (L2Z), A14XER (LDD), LDU A14NEL (LUH), A14NET (LUJ), TWINPORT / ECOFLEX ENGINES A14XFL (LUU), A14NEL (LDD), A14NEL (LUJ), A12XEL (L2Q)



54205

49,00€

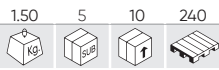

WERKZEUGSATZ FÜR MOTORSTEUERUNG FÜR VAUXHALL/OPEL 1.6 CDTI

MODELLE	VAUXHALL/OPEL: Astra J (13-18), Astra K, (15-19), GTC (15-18), Insignia A (15-17), Insignia- B (17-20), Meriva B (13-17), Mokka (14-16), Mokka X (16-20), Zafira C Tourer (13-19).
OEM WERKZEUG	EN-6349, EN-6130 (1), EN-51143 (2), EN-51140 (3), EN-50513 (4), EN-51188 (5)
MOTORCODES	B16DTC, B16DTE, B16DTH, B16DTJ, B16DTL, B16DTN, B16DTR and B16DTU. D16DTH, D16DTI, D16DTJ, D16DTN, D16DTR, D16DTU

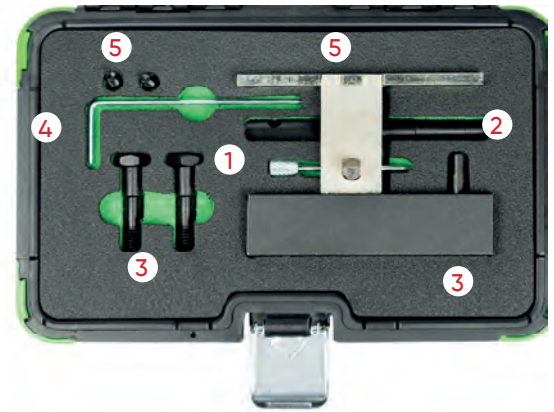

54214

96,00€

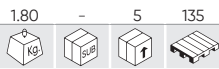

WERKZEUGSATZ FÜR MOTORSTEUERUNG FÜR OPEL/ISUZU 1.6D, 1.7D

MODELLE	ASTRA, CAVALIES, VECTRA-A(87-00), ISUZU, NOVA, CORSA / COMBO, STRA, CAVALIER, VECTRA, FRONTERA, MONTEREY, MIDI, BRAVA (88-04)
OEM WERKZEUG	VAS 6079 (1), KM 951 (2), KM 851 (3), 23-029 (4), KM 661-2 (5), KM 661 (6)
MOTORCODES	OPEL : 16DA, 17D, 17DR, X17DTL ISUZU : 4EC1, 4EE1, 4JB1, 4XJ1, 4JA1, 4JG1, 4FC1, 4FD1, 4FG1, Z17DT, Y17DT/DTL

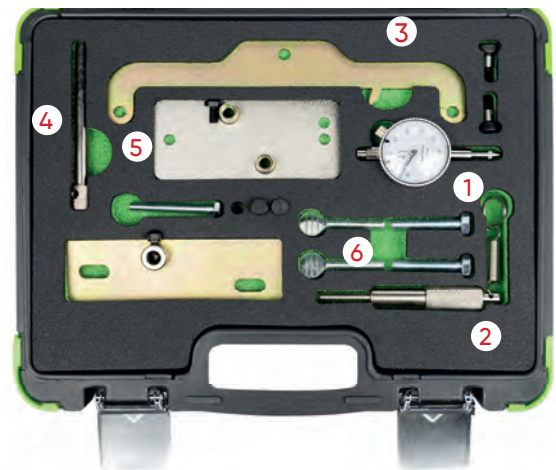

54217

104,00€



WERKZEUGSATZ FÜR MOTORSTEUERUNG FÜR VAUXHALL/OPEL/SAAB 2.0, 2.2 DTI

MODELLE	VAUXHALL/OPEL: ASTRA-G (98-06), FRONTERA-B (98-04), OMEGA-B, (98-03), SIGNUM (03-05), SINTRA (98-99), VECTRA-B (97-02), VECTRA-C (02-05), ZAFIRA-A (99-05), SAAB: 9-3 (98-04), 9-5 (02-06)
OEM WERKZEUG	SAAB: 83 95 394 (1), 83 95 337 (2), 83 95 352 (3), 83 95 386 (4) VAUXHALL/OPEL/SAAB: KM-927 (2), KM-929 (3), KM-932 (4), KM-933 (1)
MOTORCODES	OPEL: X20DTH, X20DTL, Y20DTH, Y20DTL, X22DYH, Y22DTH, Y22DTR SAAB: D223L



54221

111,00€

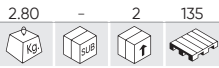

WERKZEUGSATZ FÜR MOTORSTEUERUNG FÜR VAUXHALL/OPEL 1.3 CDTI

MODELLE	VAUXHALL/ OPEL 1.3 CDTI Corsa E Diesel Engine From 2015
OEM WERKZEUG	KM-662-C (1), EN-50515 (2), EN-51500 (3), EN-46775 (4), KM-955-1 (5), EN-46785 (6)
MOTORCODES	LKU B13DTE, LKU B13DTR



54434

48,50€

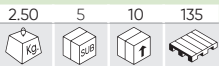

MOTOR-EINSTELLWERKZEUG SATZ FÜR OPEL 1.0, 1.4

MODELLE	VAUXHALL/OPEL ADAM 2014 - 2019, ASTRA-K 2015 - 2019, CORSA-E 2015 - 2019, INSIGNIA-B 2017 - 2020, MOKKA X 2016 - 2019, VIVA (KARL) 2015 - 2020
OEM WERKZEUG	EN-51367 (1) EN-51298 (2) EN-51632 (3)
MOTORCODES	1.0 L5Q/B10XE, L5Q/D10XE, LE1/B10XFL, LE1/B10XFT, LE1/B10XFL, LE1/D10XFL, LE1/D10XFT, LE1/F10XFL, LE1/F10XFT, LWT/B10XL 1.4 LE2/B14XFL, LE2/B14XFT, LE2/D14XFL, LE2/D14XFT, LFE/B14XNT, LFE/D14XNT, LV7/B14XE 1.5 Lfv/B15XHT, Lfv/D15XHL, Lfv/D15XHT

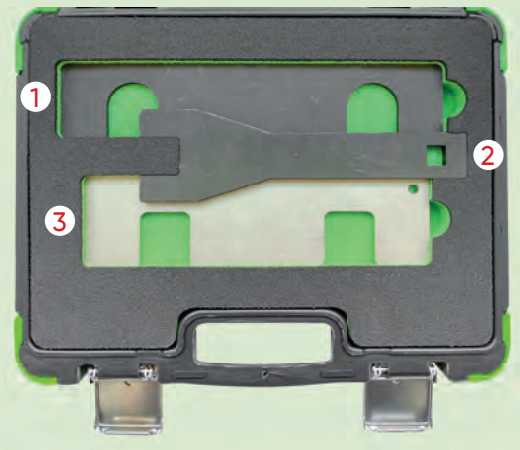

54435

14,50€

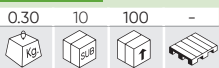

MOTOR-EINSTELLWERKZEUG SATZ FÜR OPEL/CHEVROLET/SAAB 1.4, 1.6, 1.8 ECOTEC

MODELLE	CHEVROLET: LACETTI (2005-2010), NUBIRA (2005-2010) OPEL/VAUXHALL: ASTRA-G (1998-2004), ASTRA-H (2004-2007), COMBO-C (2005-2012), CORSA-C (2000-2007), MERIVA-A (2003-2010), SIGNUM (2003-2007), TIGRA-B (2004-2010) VECTRA-B (1995-2002), VECTRA-C (2002-2008), ZAFIRA-A (1999-2005), ZAFIRA-B (2006-2013) SAAB: 9-3 (2003-2010)
OEM WERKZEUG	KM-911 (1) KM-6130 (2) KM-852 (3), EN-852 (3)
MOTORCODES	1.4: X14XE, Z14XE 1.6: X16SEJ, X16XEL, Y16XE, Z16XE, Z16YNG 1.8: F18D3 1.8: X18XE1, Z18XE, Z18XEL, X18E1 1.8: Z18XE

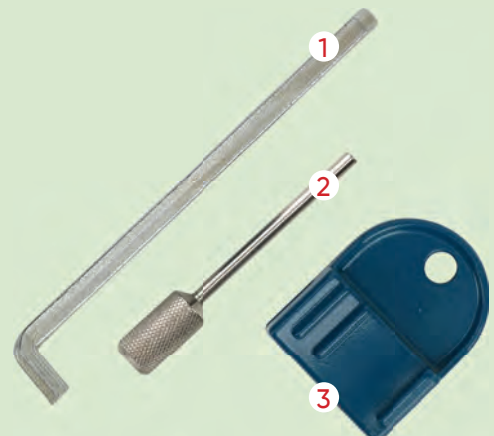

54436

124,00€



N

MOTOR-EINSTELLWERKZEUG SATZ FÜR OPEL 1.6 SIDI

MODELLE	VAUXHALL ASTRA-J 2013 - 2017,ASTRA-K 2015 - 2019,CASCADA 2013 - 2019,GTC 2015 - 2019,INSIGNIA 2013 - 2017,INSIGNIA-B 2018 - 2020,ZAFIRA-C TOURER 2014 - 2019
OEM WERKZEUG	EN 51153 (1) EN 50513 (2) EN 51148 (3) EN 51147 (4)
MOTORCODES	1,6 LWC/A16SHT LVP/A16XHT LWC/B16SHL LWC/B16SHT LVP/B16XHT LWC/D16SHJ LWC/D16SHL LWC/D16SHT

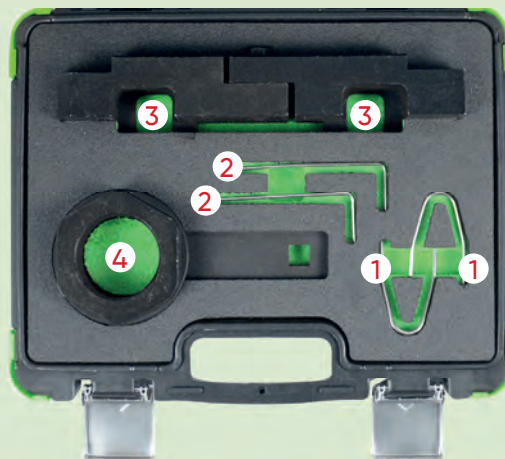

54437

110,00€



N

MOTOR-EINSTELLWERKZEUG SATZ FÜR OPEL/CHEVROLET/SAAB 2.0, 2.4

MODELLE	CHEVROLET CAPTIVA 2011 - 2015,HHR 2008 - 2009, MALIBU 2012 - 2015 SAAB 9-3 (02-12) 2010 - 2012,9-5 (10-12) 2010 - 2012 VAUXHALL/OPEL ANTARA 2011 - 2016,ASTRA-J 2012 - 2017,GTC (15-19) 2015 - 2019,INSIGNIA-A (08-17) 2008 - 2013
OEM WERKZEUG	EN-48585 (1) EN 43653 (2), J 43653 (2) EN 955 10 (3), KM 955 (3) EN-955-20 (4), KM 955-20 (4) EN 45027 1 (5), J 45027 1 (5) EN 45027 (6), EN45027 2 (6), J 45027 2 (6) EN 49212 (7), EN 49212 1 (7) EN 49212 (8), EN 49212 2 (8) EN 48953 (9)
MOTORCODES	LHU/A20NFT 2,0: LDK/A20NHT 2,0: LDK/A20NHT, LHU/A20NET, LHU/A20NFT, LHU/B20NFT 2,4: A24XE (LE5), A24XF (LE9) 2,4: LE5,LE9

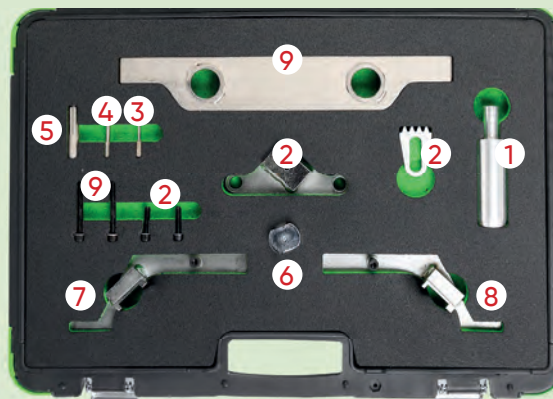

52271

18,00€

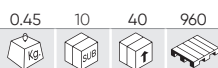

ZAHNRIEMEN MONTAGEHILFE VAG

MODELLE	AUDI: A2 1.4TDI (02-06), A3 1.9, 2.0TDI (02-08), A4 1.6TDI (02-05), A4 1.9, 2.0TDI (04-08), A6 1.9TDI (02-05). SEAT: ALTEA 1.9SDI/TDI (05-08), LEON 1.9,2.0TDI (05-08), TOLEDO 1.9SDI/TDI (05-08). SKODA: FABIA 1.4TDI (03-06), OCTAVIA II 2.0TDI (03-06) VW: BEETLE 1.9TDI (02-08), BORA 1.9TDI (02-08), FOX 1.4TDI (02-08), GOLF 1.9, 2.0TDI (02-08), LUPO 1.4TDI (02-08), POLO 1.4, 1.9TDI (02-08), SHARAN 1.9TDI (02-08).
OEM WERKZEUG	AUDI: AMF, ASZ, ATD, AVB, AVF, AWX, AXR, AZV, BHC, BKC, BKD, BKE, BLB, BMN, BNA, BPW, BRB, BR, BRD, BRE, BRF, BUY, BVA, BVF, BVG. SEAT: BJB, BKC, BLS, BMM, BXE SKODA: AMF, AZV, BKD VW: AJM, AMF, ANU, ARL, ASZ, ATD, AUJ, AVB, AVF, AWX, AXR, BAY, BMS, BNM, BNV, BWB



51489

12,00€

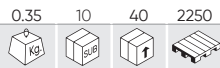

NOCKENWELLEN-BLOCKIER-SET VAG 1.4, 1.6

MODELLE	VW: LUPO 99, POLO 95, CADDY 96, POLO CLASSIC, VARIANT 96, BEETLE 1.4L 99, GOLF 1.4L, 1.6L 98 Y 1.4L, BORA, 1.6L 99. AUDI: A2.
OEM WERKZEUG	T10016
MOTORCODES	1.4 / 1.6 16V



53274

30,50€

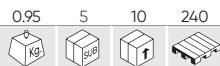

MOTOREINSTELLUNG WERKZEUG SET VOLKSWAGEN/SEAT/SKODA 1,2L

MODELLE	VOLKSWAGEN 1.2: LUPO / POLO / EOS / FOX. SEAT 1.2: IBIZA / CORDOBA SKODA 1.2: FABIA
OEM WERKZEUG	T10123 (1) (2), T10120 (3), T10121 (4)
MOTORCODES	AWY / BMD / AZQ / BME.



53275

35,50€



MOTOREINSTELLUNG WERKZEUG SET DIESEL

MODELLE	DODGE: CALIBER (06-11) FORD: GALAXY (02-06) MITSUBISHI: GRANDIS (05-10), LANCER (05-10), OUTLANDER (07-10). SEAT: ALHAMBRA (00-15), ALTEA/ALTEA XL (04-15), CORDOBA (02-09), IBIZA (02-15), LEON (00-13), TOLEDO (04-11). SKODA: FABIA (00-14), FABIA II (07-15), OCTAVIA (00-10), OCTAVIA II (04-15), PRACTIK (10-15), RAPID (11-15), ROOMSTER (07-15), SUPERB (02-08), SUPERB II (08-15), YETI (09-14). AUDI: A1 (10-15), A2 (00-06), A3 (01-13), A4/ALLROAD (01-16), A5 (08-15), A6 (11-14), TT (08-14), Q3 (11-15), Q5 (08-15), A6 (10-14). VOLKSWAGEN: AMAROK (10-16), BEETLE (02-15), BORA (02-08), CADDY/MAXI (03-15), EOS (06-15), FOX (05-11), GOLF (02-15), GOLF PLUS (05-14), JETTA (05-15), LUPO (02-05), PASSAT/CC (02-15), POLO (99-14), SCIROCCO (08-14), SHARAN (02-15), TIGUAN (07-15), TOURAN (03-15), TRANSPORTER (03-17).
OEM WERKZEUG	DODGE: 9882, 9883. FORD: 310-085/23-059, 303-1054. MITSUBISHI: MB995206, MB995208, MB995209. VAG: T10100 (4), T10050 (1), 3359 (3/6)/T20102, T10115 (3), T10060A (2)/T40098, T20167.
MOTORCODES	1.2D TDi CR: CFWA. 1.4D TDi PD: AMF, BAY, BMS, BNM, BNV, BWB. 1.6D TDi CR: CAYA, CAYB, CAYC, CAYD, CAYE, CLNA. 1.9D TDi PD: AJM, ANU, ARL, ASZ, ATD, AUY, AVB, AVF, AVQ, AWX, AXB, AXC, AXR, BJB, BKC, BLS, BLT, BMT, BPZ, BRM, BRR, BRS, BRU, BSU, BSV, BSW, BTB, BVK, BXE, BXF, BXJ. 2.0D TDi CR/TDi PD: AZV, BDJ, BDK, BEW, BGW, BHW, BKD, BKP, BKQ, BLB, BMA, BMM, BMN, BMP, BMR, BNA, BPW, BRA, BRC, BRD, BRE, BRF, BRT, BSS, BST, BSY, BUJ, BUZ, BVA, BVE, BVF, BVG, BVH, BWC, BWV, CAAA, CAAB, CAAC, CAAD, CAE, CAG, CAGB, CAGC, CAHA, CAHB, CBAA, CBAB, CBAC, CBBA, CBDB, CBDA, CBDC, CBEA, CCHA, CCHB, CDBA, CDCA, CEGA, CFCA, CFFA, CFFB, CFFD, CFFE, CFGB, CFGC, CFHA, CFHB, CFHC, CFHD, CFHE, CFHF, CFJA, CGLA, CGLB, CGLC, CGLD, CJAA, CJCA, CJCB, CJCC, CLCA, CLCB, CLJA, CLLA, CNEA, ECD, ECD/BSY, ECD/BYL, ECE/BWD.

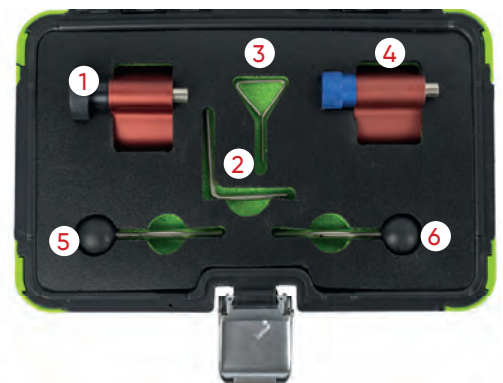

53276

160,00€

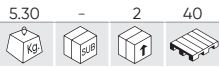

MOTOREINSTELLUNG WERKZEUG SET AUDI / SKODA

MODELLE	MOTOR AUDI, VW: V6 2.0, 2.8, 3.0T FSI. AUDI QS: 2.0, A6L 2.8, 3.0T.
OEM WERKZEUG	3418 (1), 3458 (2), T10100 (3), T10123 (4), T10121 (5), 3242 (6), 3551 (8), T10020 (9), T10098 (10), 3078 (12), 2064 (13), 3369 (14), T10092 (15), T40011 (17), 2065A (18), T10016 (19), 3359 (20), T10008 (21), T10050 (22) T10265 (23), T10264 (24), T10060A (25), T10120 (27), 3366 (28)
MOTORCODES	2.0, 2.8, 3.0



53277

45,00€

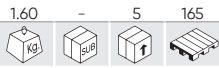

ZAHNRIEMENSEINSTELLUNGS SET VW/ AUDI

MODELLE	BENZIN	AUDI: 80, 100, A3, A4, A6 1.6, 1.8/TURBO, 2.0, 2.0 16V, A3, A4 1.6 (96-). SEAT: IBIZA/CORDOBA, TOLEDO, ALHAMBRA, INCA 1.6, 1.8, 1.8 16V, 2.0, 2.0 16V, IBIZA/ CORDOBA, LEON, TOLEDO 1.6 (99-), ALHAMBRA 2.0 (00-). VOLKSWAGEN: POLO CLASSIC, SCIROCCO, CORRADO, GOLF, JETTA, VENTO, PASSAT, SHARAN, TRANSPORTER 1.6, 1.8/TURBO, 1.8 16V, 2.0, 2.0 16V, POLO CLASSIC, GOLF, BORA, BEETLE 1.6 (97-), 2.0 (99-). SKODA: OCTAVIA 1.6 (97-), 2.0 (99-).
	DIESEL-MOTOR	AUDI: 80, 100, A3, A4, A6 1.9 TURBO D, 1.9TDI, 2.5TDI, A3, A4, A6 2.0TDI, A2, A3, A4, A6 1.2TDI, 1.4TDI, 1.9TDI (99-). SEAT: IBIZA/CORDOBA, LEON, TOLEDO, ALHAMBRA, INCA 1.7SDI, 1.9D/TD /SDI/TDI. EQRD: GALAXY (02-06). SKODA: FELICIA, OCTAVIA 1.9D/TDI. VW: POLO, POLO CLASSIC, GOLF, JETTA, VENTO, BORA, BEETLE, PASSAT, SHARAN, CADDY, TRANSPORTER 1.5D, 1.6D/ TURBO, 1.7D/SDI, 1.9SDI/TDI, GOLF, PASSAT 2.0TDI.
OEM WERKZEUG	T10020 (1), 3387 (2), V159 (3), T10060/T100604 (4), T10115 (5), T40011 (6)	
MOTORCODES	2.0, 2.8, 3.0	



53278

143,00€



MOTOREINSTELLUNG WERKZEUG SET AUDI 2.8, 3.2 FSI, 3.0 TFSI

MODELLE	A2, A4, A4 QUATTRO, A6 (2004-2007) A2, A3, A4, A3 FSI (2004-2007) A4, A6, A8 3.2 FSI A6 L QUATTRO 2.4 A6 2.4, A6 2.4 QUATTRO (2004-2007) A4 3.2 FSI (2004-2007) A6 3.2 FSI (2004-2007) A8 3.2 FSI (2005-2007)
OEM WERKZEUG	T10172 (1), 3212 (2), T40070 (3), T40069 (4), T40071 (5), T10172/2 (6)
MOTORCODES	AUK / BDW / BDX / BKH / CAJA / CALA

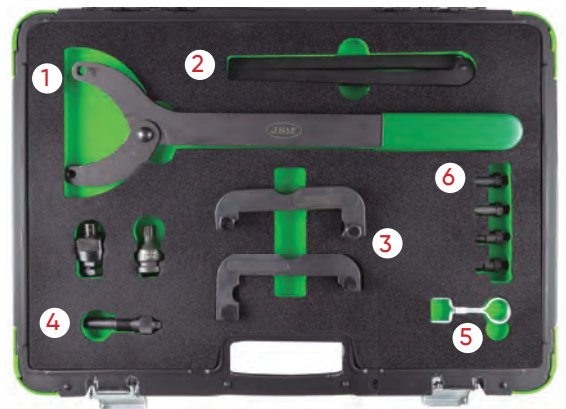

53279

97,00€

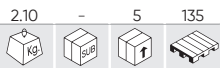
**MOTOREINSTELLUNG WERKZEUG SET VW/AUDI 1.8, 2.0, TSI, TFSI**

MODELLE	AUDI: A3 (96-09), A4 (94-09), A6 (95-11), S3 (99-13), TT (98-14). SEAT: ALHAMBRA (97-10), ALTEA/ALTEA XL (06-09), CORDOBA (99-02), EXEO (09-10), IBIZA (99-02), LEON (99-13), TOLEDO (99-09). SKODA: OCTAVIA/OCTAVIA TOUR (98-10), OCTAVIA II (04-09). VOLKSWAGEN: BEETLE (99-11), BORA (97-04), EOS (06-10), GOLF (97-12), GOLF PLUS (05-09), JETTA (05-09), PASSAT (96-10), SCIROCCO (09-14), SHARAN (97-10), TOURAN (03-09).
OEM WERKZEUG	T10020 (1), T10252 (2), T10092 (3), T10115 (4), T40011 (4), 3366 (5), T10060 (6)
MOTORCODES	1.8: ADR, AFY, AGN, AJP, APG, APT, AQE, ARG, ARH, AVV. 1.8T: AEB, AGU, AJH, AJL, AJQ, AMK, AMU, ANB, APP, APU, APX, APY, AQA, AQX, ARX, ARY, ARZ, AUM, AUQ, AVC, AWC, AWV, AWU, AYP, BAM, BFV, BVP, BVR. 2.0 TSI: AXW, BHD, BLR, BLX, BLY, BMB, BVX, BVY, BVZ. 2.0 TFSI/S/R/TSI: AXV, BPY, BWA, BGB, BPG, BPJ, BUL, BWE, BWT, BYK, BHZ, BZC, BWJ, BYD, CDLA, CDLB, CDLC, CDLD, CDLF, CDMA.

**53280**

112,00€

**NOCKENWELLENEINSTELLUNGS SET VW/AUDI 3.0 V6**

MODELLE	AUDI: A4 (01-08), A6 (01-08), A8 (03-10).
OEM WERKZEUG	3387 (1), T40030 (2) (4), T40026 (3), T40028 (5)
MOTORCODES	3.0 V6 30V: ASN, AVK, BBJ, BGN.

**53281**

55,00€

**NOCKENWELLENEINSTELLUNGS SET VW/AUDI**

MODELLE	VOLKSWAGEN: 2.5 TDi V6 AUDI: A4, A6, A8
OEM WERKZEUG	3369 (1), 3242 (2), 3458 (3)
MOTORCODES	AFB/AKN



53282

48,00€

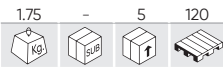

LAUBSÄGEWERKZEUG VAG GRUPPE 1.2, 1.4, 1.6

MODELLE	SEAT: ALHAMBRA (10-15), ALTEA/ALTEA XL (08-15), IBIZA/CORDOBA (08-12), LEON (07-13), TOLEDO (07-15). VOLKSWAGEN: BEETLE (11-15), CADDY/CADDY MAXI (10-15), EOS (06-12), GOLF (03-12), GOLF PLUS (03-14), GOLF V ESTATE (07-13), GOLF VI CABRIOLET (10-15), JETTA (06-14), PASSAT (05-11), POLO (02-14), SCIROCCO (08-12), TIGUAN (07-12), TOURAN (03-15). SKODA: FABIA II (07-15), OCTAVIA II (04-15), PRAKTIK (10-15), RAPID (12-15), ROOMSTER (06-15), SUPERB II (09-14), YETI (09-14). AUDI: A1 (10-15), A3 (03-13).
OEM WERKZEUG	T10171 (1), T10170 (2), T40011 (3)
MOTORCODES	1.2 TFSI: CBZA, CBZB, CBZC. 1.4 FSI: AXU, BKG, BLN. 1.4 TFSI: BLG, BMY, BWK, CAVA, CAVB, CAVC, CAVD, CAVE, CAVF, CAXA, CAXC, CDGA, CSMA. 1.6 FSI: BAG, BLF, BLP, BTS.



53283

92,00€



AUSGLEICHSSATZ GRUPPE VAG 2.7, 3.0 TDI

MODELLE	VOLKSWAGEN: TOUAREG, PHATEON VAG: DIESEL 2.7 / 3.0 V6 AUDI: A4, A5, A6
OEM WERKZEUG	3242 (1), T40060 (2) (3), 3359 (4), T40058 (5), T40061 (6), T40062 (7), T40049 (8)
MOTORCODES	ASB, BKN, BKS, BWZ, BNG, BPP, BSG, BUG, BUN, CAWA, CAMB, CANA, CANB, CANC, CAND, CAPA, CARA, CARS, CASA, CASE, CASC, CAM, CC/HA, CCWA, CCWB, CDYA, CDVB, CDVC, CEXA, CGKA, CGKB.

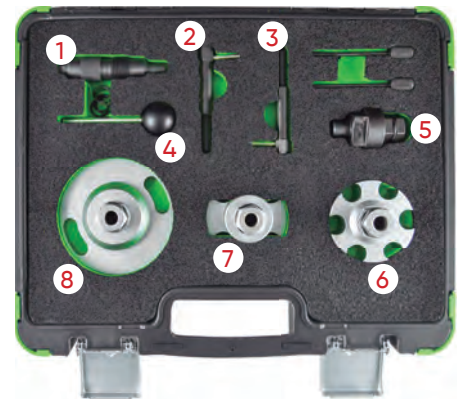

53284

306,00€



LAUBSÄGEARBEITSKIT GRUPPE VAG 2.5 TDI

MODELLE	VOLKSWAGEN: TOUAREG (03-10), TRANSPORTER (03-09).
OEM WERKZEUG	T10225 (1), T10199 (2), T10234 (3), T10226 (4), T10193 (5), T10194 (6), T10199/01 (7), T10226 (8)
MOTORCODES	2.5D TDI PD: AXD, AXE, BAC, BLJ, BLK, BNZ, BPC, BPD, BPE.

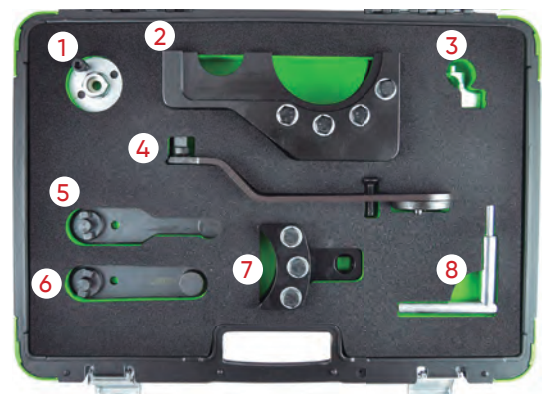

53285

56,00€

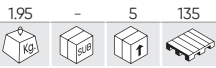

MOTOREINSTELLUNG WERKZEUG SET VAG 2.4, 2.5, SDI, TDI

MODELLE	VOLKSWAGEN: CRAFTER (06-13), LT (96-06), TRANSPORTER (90-03).
OEM WERKZEUG	2065A (1), T50009 (2), T10025 (3), 3248/3419 (4), 2064 (5), 3355 (6)
MOTORCODES	2.4D: AAB, AJA. 2.5D SDI: AGX. 2.5D TDI: ACV, AHD, AHY, AJT, ANJ, APA, AUF, AVR, AXG, AXL, AYC, AYY, BBE, BBF. 2.5D TDI CR: BJJ, BJK, BJL, BJM.



53286

87,00€

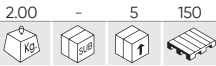

MOTOREINSTELLUNG WERKZEUG SET VAG 1.8, 2.0 TSI, TFSI

MODELLE	VOLKSWAGEN: 1.8 / 2.0 TSI / TFSI.
OEM WERKZEUG	T10368 (2), T10354 (3), T40271 (1)(4), T10352/2 (5), T10352/1 (6), T10352 (7), T40196 (8) (9) (10) (11), T40267(12) (13), T40098 (14), T10060A (15), T40011 (15)
MOTORCODES	BYT, BZB, CABA, CABB, CABD, CADA, CAEA, CAEB, CAWA, CAWB, CBFA, CCTA, CCZA, CCZB, CCZC, CDA, CDAB, CDHA, CDHB, CDNB, CDNC, CDND, CESA, CETA, CFKA, CGYA, CJEB, CJBA, CJSB.



53287

245,00€

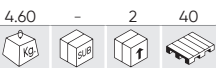

MOTOREINSTELLUNG WERKZEUG SET VW/AUDI 1.8, 2.0 TURBO

MODELLE	VOLKSWAGEN AUDI	1.8 / 2.0 TURBO
OEM WERKZEUG	T10355 (1), T40196 (2), T40271 (3) (4), T10352 (5), T10352/1 (6), T10352/2 (7), T10368 (7), T40267 (8), T10354 (9), T40265 (10), T40011 (11) (14), T40098 (12), T10060A (13)	
MOTORCODES	BYT, BZB, CABB, CABD, CADA, CAEA, CAEB, CAWA, CAWB, CBFA, CCTA, CCZA, CCZB, CCZC, CDA, CDAB, CDHB, CDNB, CDNC, CDND, CESA, CETA, CFKA, CGYA, CJEB, CJA, CJSB.	

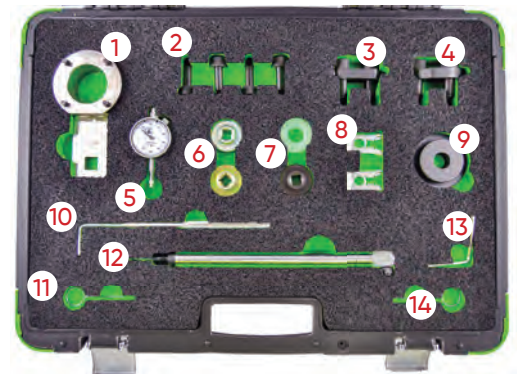

53288

72,00€

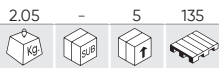

MOTOREINSTELLUNG WERKZEUG SET VAG 1.6, 2.0 TDI COMMON RAIL

MODELLE	SEAT: EXEO, LEON, ALTEA, TOLEDO, IBIZA. VOLKSWAGEN: JETTA, TOURAN, GOLF, GOLF PLUS, POLO, PASSAT, TIGUAN, SCIROCCO. SKODA: ROOMSTER, FABIA, PRAKTIK, OCTAVIA, YETI, SUPERB. AUDI: A1, A3, A4, A5, Q5, A6, TT.
OEM WERKZEUG	T10264 (1), T10265 (2), T20102 (3), T10052 (4), T10051 (5), T10255 (6), T10050 (7), T10100 (8), T40098 (9)
MOTORCODES	1.2 TDI CR, 1.6 D TDI CR, 2.0 D TDI CR CAGA, CAGB, CAGC, CAHA, CAHB, CFHC, CBAA, CBAB, CFFB, CGLA, CGLB, CJCA, CJCB, CAAA, CBAA, CBAB, CBAC, CBBA, CBBB, CBDA, CBDB, CBDG, CCHA, CEGA, CJAA, CAAB, CAAC, CFJA, CFWA, CAYB, CAYC, CAYA.



53320

12,00€

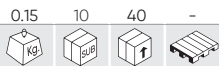

NOCKENWELLEN-BLOCKIER-WERKZEUG VAG

MODELLE	SEAT: ALHAMBRA, ALTEA, AROSA, CORDOBA, IBIZA, LEON, TOLEDO 1.4/1.9/2.0 TDI. VW: PASSAT 1.9. AUDI: A4/A6 1.9.
OEM WERKZEUG	T10008, T20102, T10100.



53321

10,50€

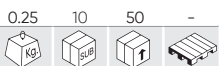

EINSTELLWERKZEUG RIEMENSPIANNUNG VAG

MODELLE	AUDI: A4/1.8T, 2.0 1999-2004 A6/1.8T 2002-2004 A4/3.0 (2002 -), A6/3.0 (2002 -), A8/7.0 (2003 -). VW: GOLF PASSAT 2.0 TDI DIESEL, GOLF 88-97, PASSAT 92-97, VW T4/2.0 1992-2004.
OEM WERKZEUG	T10020



53325

7,50€

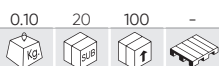

SCHLÜSSEL FÜR RIEMENSCHLEIBE VW AUDI 35MM

MODELLE	AUDI: 100 ('91-), A6 (2.5 TDI) 2.3, 2.4, 2.5, 2.8, 2.9D TDI (1991-2003) VW: LT, TRANSPORTER
OEM WERKZEUG	3355
MOTORCODES	AAB, AAT, ACU, ACV, AEL, AET, AGX, AHG, AHY, AJA, AJT, ANJ, APA, APL, AUF, AVT, AXG, AXL, AYC.



53326

16,00€

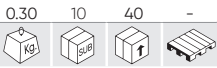

MOTOREINSTELLUNG WERKZEUG SET VW / AUDI

MODELLE	VW: V6 2.5TDi. AUDI: V6 2.5TDi, V8 3.3TDi.
OEM WERKZEUG	3458 (1), 3242 (2)



53327

11,00€

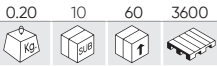

MOTOREINSTELLUNG WERKZEUG SET VAG1.2

MODELLE	SEAT: IBIZA1.2 6V/3CYL (2002-09), CORDOBA 1.2 12V/3CYL (2002-13). VW: POLO 1.2 6V-12V/3CYL (2002-14). SKODA: FABIA 1.2 6V-12V/3CYL (2002, 2003-), FABIA II 1.2 6V/3CYL (2007-13), ROOMSTER 1.2 12V/3CYL (2006-13), PRAKTIK 1.2 6V/3CYL (2007-13).
OEM WERKZEUG	T10123
MOTORCODES	1.2 6V: AWY, BMD, BBM, CHFA, CHFB 1.2 12V: AZQ, BME, BVX, BZG, CEVA, CGPA, CGPB, CGPC.



53648

107,00€

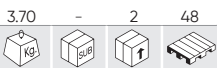

ZAHNRIEMENSEINSTELLUNGS SET VWAG 1.0, 1.2, 1.4 TSI

MODELLE	AUDI: A1 (12-15), A1 SPORTBACK (12-15), A3 (13-15), A3 SPORTBACK (12-15). SEAT: IBIZA (12-15), LEON (12-15), TOLEDO (12-15). SKODA: FABIA (10-13), OCTAVIA II (10-13), OCTAVIA III (10-15).
OEM WERKZEUG	T10060A (1), T10340 (2), T10476 (3), T10494 (4), T10499 (5), T10504/1 (6), T10504 (7), T10504/2 (8).
MOTORCODES	1.2 TSI: CJZA, CJZB. 1.4 TSI: CGGA, CHPA, CMBA, CPVA, CRJA, CXSA. 1.4 TSI ACT: CPTA.

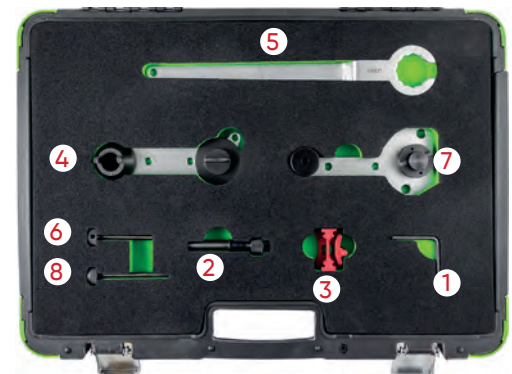

53649

89,00€

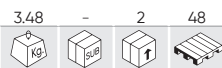

VAG GROUP WERKZEUGSATZ FÜR MOTORSTEUERUNG

MODELLE	AUDI SEAT	SKODA VW
OEM WERKZEUG	T10340 (1), T10476 (2), T10477 (3), T10487 (4), T10494 (5), T10499 (6)	
MOTORCODES	1.0 MPI: CHYA. 1.0 TSI: CHZE, CHZC, CHZA, CHZB, CHZC, CHZD, CHZJ. 1.2 TSI: CJZB, CJZC, CYVA, CJZA, CJZD, CYVB. 1.4 TSI: CZCC, CMBA, CZCA, CHPA, CPTA (ACT), CZDA, CVNA, CZEA (ACT).	

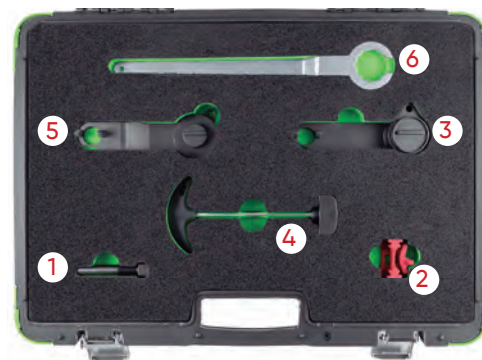

53706

98,00€

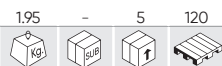

NOCKENWELLENEINSTELLUNGS SET VAG 1.4, 1.6, 2.0 TDI COMMON RAIL

MODELLE	VOLKSWAGEN: GOLF ALLTRACK, GOLF SPORTSVAN, GOLF VII, GOLF VII KOMBI, PASSAT, POLO. AUDI: A1, A1 SPORTBACK, A3, A3 CABRIOLET, A3 LIMOUSINE, A3 SPORTBACK, TT, TT ROADSTER. SEAT: IBIZA, IBIZA V SPORTCOUPE, IBIZA V ST, LEON, LEON SC, LEON ST, TOLEDO IV. SKODA: FABIA, FABIA KOMBI, OCTAVIA, OCTAVIA COMBI, RAPID, RAPID SPACEBACK.
OEM WERKZEUG	OEM 3204 (1), OEM 3359 (2), OEM T10490 (3), OEM T10051 (4), OEM T10060A (5), OEM T10264 (6), OEM T10265 (7), OEM T10492 (8), OEM T40098 (9).
MOTORCODES	1.4, 1.6, 2.0 TDI CR CXXB, DBKA, DCXA, CGLE, CKFB, CKFC, CLHA, CLHB, CNHA, CNHC, CRBD, CRFA, CRFC, CRKA, CRKB, CRLB, CRLC, CRMB, CRUA, CRVA, CRVC, CSUA, CSUB, CUNA, CUPA, CUSA, CUSB, CUTA, CUUD, CXEB, DBKA, DCXA, DCZA, DFSD.

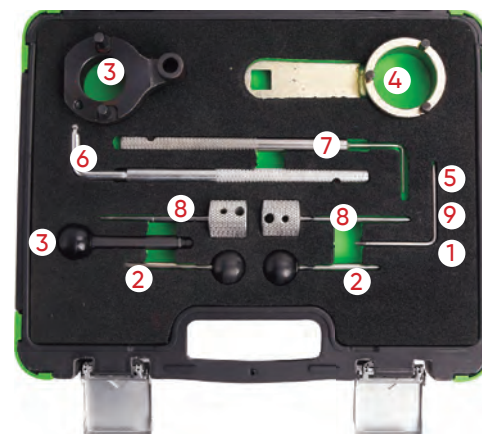

54092

24,00€



KIT DE CONTROL DE FASE DEL MOTOR VAG (VOLKSWAGEN)

MODELLE	AUDI: A1, A3, A3 SPORTBACK, A3 CABRIO SEAT: ALTEA, ALTEA XL, IBIZA, LEON, TOLEDO SKODA: FABIA II, OKTAVIA II, PRAKTIK, RAPID, RAPID SPACEBACK, ROMMSTER, YETI VW: BEETLE, CADDY, CADDY MAXI, GOLF PLUS, GOLF VI, GOLF VI CABRIO, GOLF VI ESTATA, JETTA, POLO, TOURAN
OEM WERKZEUG	T10340(1), T10414(2), T10341(3)
MOTORCODES	CBZA, CBZB, CBZC

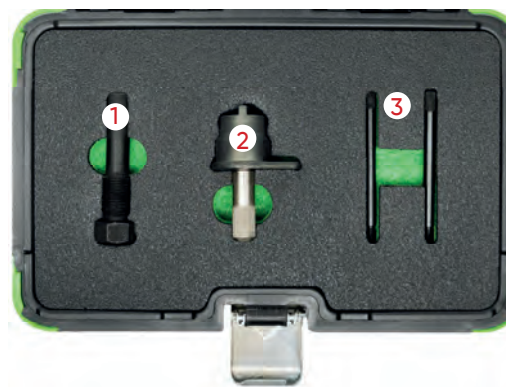

54199

94,00€

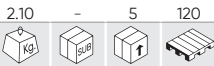

WERKZEUGSATZ FÜR MOTORSTEUERUNG FÜR VAG TFSI, FSI

MODELLE	AUDI: A1 (10-15), A1 SPORTBACK (10-15), A3 CABRIOLET (10-13), A3 (10-15), A3 SPORTBACK (03-13) SEAT: ALTEA/ALTEA XL (10-15), IBIZA (10-15), LEON (10-13), TOLEDO (12-15) SKODA: FABIA II (10-15), PRAKTIK (10-15), RAPID (12-15), RAPID SPORTBACK (12-15), OCTAVIA II (04-13), YETI (09-15), YETI OUT-DOOR (13-15) VW: BEETLE (11-15), CADDY/CADDY MAXI (10-15), EOS (07-15), GOLF V (03-13), GOLF V ESTATE (07-09), GOLF VI (10-13), GOLF VI ESTATE (10-13), GOLF VI CABRIOLET (11-15), GOLF PLUS (05-14), JETTA (05-14), PASSAT (05-15), POLO (09-14), SCIROCCO (08-14), TIGUAN (07-15), TOURAN (03-15)
OEM WERKZEUG	T10414 (1), VAS 6079 (2), T10170 (3), T10171/ T10171A (4), T40011 (5), T10340 (6), T10341 (7)
MOTORCODES	1.2 TFSI: CBZA, CBZB, CBZC 1.4 FSI/TFSI: BLG, BMY, BWK, CAVA, CAVB, CAVC, CAVD, CAVE, CAVF, CAXA, CAXC, CDGA, CSMA 1.6 FSI: BAG, BLF, BLP

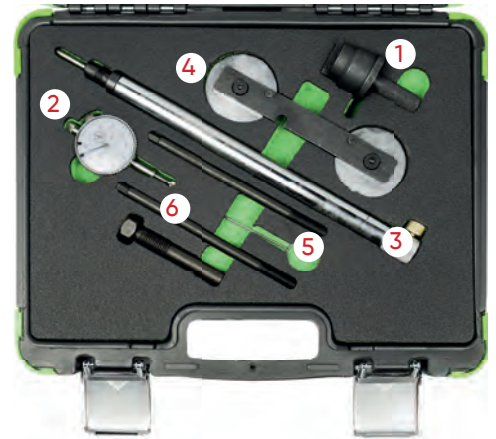

54218

142,00€



WERKZEUG ZUR MONTAGE VON VAG SCHWINGUNGSDÄMPFERN

MODELLE	AUDI, SEAT, SKODA, VOLKSWAGEN
OEM WERKZEUG	T10531/1 (1), T10531/2 (2), T10531/3 (3), T10531/4 (4)
MOTORCODES	1.8L TFSI: BZB, CDAA, BPU, BYT, CABA, CABB, CDHA, CDHB, CABD, DAJB, CJSJA, CJSB, CJEB, CJEE, CJED, CYGA, CDAC, CJSC, CGYA, DAJA 2.0L TFSI: CAWB, CCZA, CBFA, CCTA, CDNB, CDNC, CDND, CJXA, CJXE, CJXH, CHHB, CHHA, CULA, CFKA, DEDA, CHJA, CAWA, CCZC, CCZD, CPSA, CJK, CJKB, CESA, CETA, CFPA, CNCD, CPLA, CYRB, CYRC; CNCE, CYNB, CYP, CULB, CULC, CNCB, CWZA, CJXF, CJXC, CJXB, CJXG, CHHC, CCZB



54407

397,00€



NOCKENWELLENMONTAGESATZ FÜR VAG/PORSCHE

MODELLE	AUDI, PORSCHE, SEAT, SKODA, VOLKSWAGEN 1.2 - 1.6 - 2.0 - 2.7 - 3.0 - 4.0 - 4.2 COMMON RAIL
OEM WERKZEUG	T40094, T40094/1 (1), T40094/2 (2), T40094/3 (3), T40094/4 (4), T40094/5 (5), T40094/6 (6), T40094/7 (7), T40094/8 (8), T40094/9 (9), T40094/10 (10), T40094/11 (11), T40094/12 (12), T40095 (13), T40096 (14), T40096/1 (15)
MOTORCODES	ASB, ASE, BKN, BKS, BMK, BNG, BPP, BSG, BTR, BUG, BUN, BVN, CAAA, CAAB, CAAC, CAAD, CAAE, CAGA, CAGB, CAGC, CAHA, CAHB, CAMA, CAMB, CANA, CANB, CANC, CAND, CAPA, CARA, CASA, CASB, CASC, CASD, CATA, CAYA, CAYB, CAYC, CAYD, CAYE, CBAA, CBAB, CBAC, CBBA, CBBB, CBDA, CBDB, CBDC, CCFA, CCFC, CCHA, CCHB, CCLA, CCMA, CCWA, CCWB, CDBA, CDCA, CDSB, CDTA, CDTB, CDUC, CDUD, CDYA, CDYB, CDYC, CEGA, CEXA, CFCA, CFFA, CFFB, CFFD, CFFE, CFGB, CFGC, CFGD, CFHA, CFHB, CFHC, CFHD, CFHE, CFHF, CFJA, CFWA, CGKA, CGKB, CGLA, CGLB, CGLC, CGLD, CGLF, CGQB, CJAA, CJCA, CJCB, CJCC, CJCD, CJGA, CJGC, CJGD, CJMA, CKDA, CKTB, CKTC, CKUB, CKUC, CKVB, CKVC, CLAA, CLAB, CLCA, CLCB, CLJA, CLLA, CLNA, CLZB, CMEA, CMFA, CMFB, CMGB, CMHA, CNEA, CNFA, CNRB, CRCA, CSHA, M05/9D(CAS), M05/9E, M05/9E(CRCA), M05/9E(CRCB)

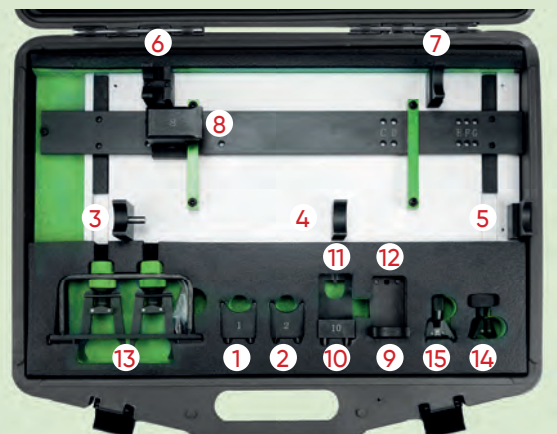

54408

46,00€

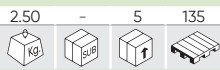

N

MOTORSTEUERUNGSWERKZEUGSATZ VAG DIESEL 1.7, 1.9, SDI, TDI

MODELLE	AUDI: A3, A4, A6, CABRIOLET, SEAT: ALHAMBRA, AROSA, CORDOBA, IBIZA, INCA, LEON, TOLEDO, SKODA: FELICIA, OCTAVIA VW: BORA, CADDY, FOX, GOLF, LT, LUPO, PASSAT, POLO, SHARAN, TRANSPORTER, VENTO
OEM WERKZEUG	T1020 (1), 2587 (2), 2065A (3), T20044 (4), T10098 (5), T40011 (6), 2064 (7), T3359 (8), T10092 (9), M5x60M (10)
MOTORCODES	1.7TDi/SDi: AHB, AHG, AKU, AKW 1.9TDi/SDi: 1X, 1Y, 1Z, ABL, AAZ, AEF, AEY, AFF, AFN, AGD, AHF, AHH, AHU, AGP, AGR, ALE, ALH, AQM, ASV, ASY, ASX, AVG, AYQ 2.4D: 1G, 1S, DW, DV, ACL, ACT

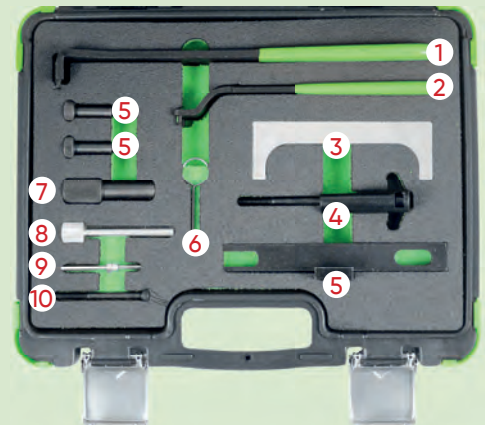

54409

32,00€

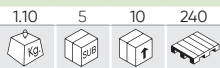

N

MOTOR-EINSTELLWERKZEUG SATZ FÜR VAG 1.4 TSI

MODELLE	ATECA (2016-) A3 (2012-) SUPERB (2015-) A1 SPORTBACK (2012-2018) LEON/LEON ST (2012-2020) MK5 (2012-2018) Q2 (2016-) Q3 (2015-2018)
OEM WERKZEUG	T10340 (1) T10504 (2) T10504/1 (3) T10504/2 (4)
MOTORCODES	1.4 TFSI (CoD)-CPTA, CZEA 1.4 TSI (ACT)-CPTA, CZEA

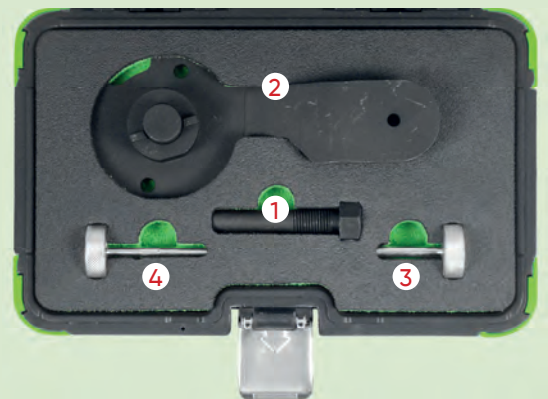

54410

33,50€



N

MOTOR-EINSTELLWERKZEUG SATZ FÜR VAG 2.4, 3.2 FSI

MODELLE	AUDI: A4, A5, A6, A7, A8, Q5, Q7, R8, RS4, RS5, RS6, S4, S5, S6, S8 VW: TOUAREG
OEM WERKZEUG	T40058 (1) T40069 (2) T40071 (3) T40133 (3) T40133/1 (3) T40133/1/2 (3) T40133/2 (3) 40071 (4)
MOTORCODES	2.4: BDW 3.2: AUK, BKH, BPK 4.2: BAR, BNS, BVJ, CAUA, CDRA, CFSA, BYH, CNDA 5.0: BUH 5.2: BSM, BUJ, BXA, CMPA, CTPA, CTYA

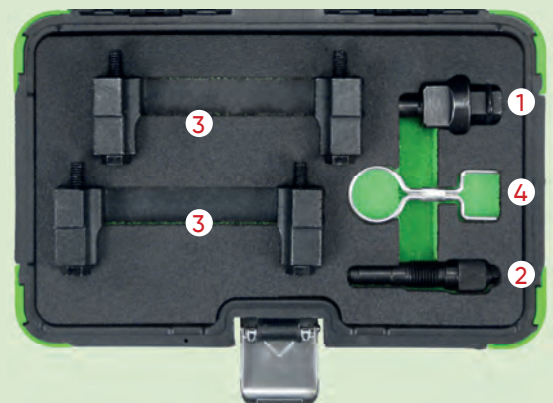

54411

36,00€

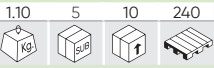

N

MOTOR-EINSTELLWERKZEUG SATZ FÜR VAG/PORSCHE 2.4, 2.8, 3.0 TFSI

MODELLE	AUDI: A4 (2011-2015) A5 (2007-2017) A6 (2007-2018) A7 (2010-2018) A8 (2010-2018) A8 (2010-2018) Q7 (2010-2018) S4 (2009-2017) S5 (2010-2017) S5 (2010-2017) Q5 (2008-2017) SQ5 (2013-2018) PORSCHE: CAYENNE (2010-2014) PANAMERA 2011-2013 VAG: TOUAREG (2010-2014)
OEM WERKZEUG	T40133/1 (1) T40133/2 (2) T40058 (3) T40069 (4) T40071 (5)
MOTORCODES	AUDI: 2,5 CLXB, CPAA 2,8 BDX, CCDA, CCEA, CHVA, CJBA, CNYA 3,0 CAJA, CAKA, CCAA, CGEA, CGWA, CGWB, CGWC, CGWD, CGXB, CGXC, CHMA, CHMB, CJTB, CJTC, CJWC, CMDA, CMUA, CNA, CREA, CREC, CRED, CTTA, CTUA, CTUD, CTVA, CTWA, CTXA 3,2 CALA, CALB PORSCHE: 3,0 M06/EC VAG: 3,0 CJTA, CGFA

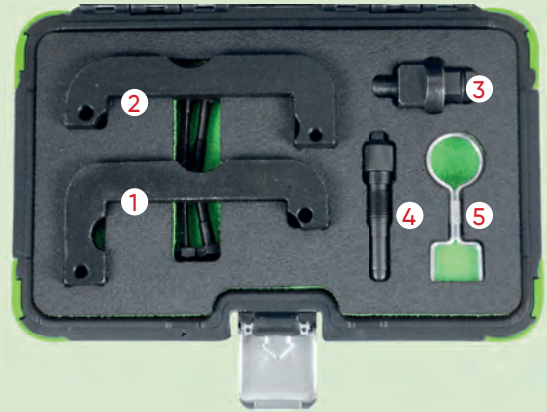

54412

57,00€

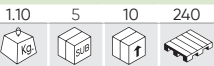

N

MOTOR-EINSTELLWERKZEUG SATZ FÜR AUDI 2.5 TFSI

MODELLE	AUDI: RSQ3 (2013-2015), RSQ3 (2015-2018), RS3 (2010-2013), RS3 (2015-2017), TT (2009,2014)
OEM WERKZEUG	T03003 (1) T40264/1/2 (2), T40264/2A (2) T40069 (3) T40011 (4) T40297 (5)
MOTORCODES	2,5 TFSI/RS CEPA, CEPB, CTSA, CZGA, CZGB

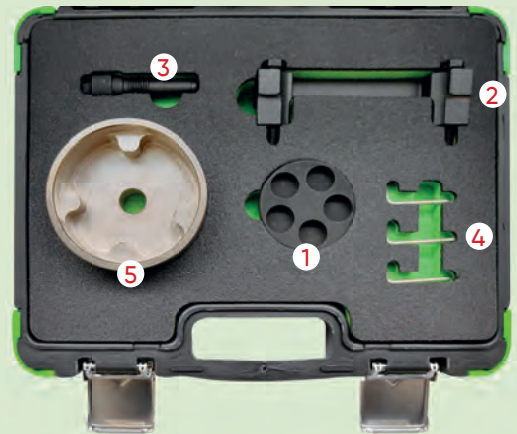

54413

115,00€



N

MOTOR-EINSTELLWERKZEUG SATZ FÜR AUDI 4.0 FSI, TFSI

MODELLE	AUDI: A8, RS6, RS7, S6, S7, S8 (2012-2018)
OEM WERKZEUG	T40071 (1) T40257 (2) T40264/1 (3) T40264/2 (4) T40264/3 (5) T40269 (6) T40272 (7)
MOTORCODES	CEUA CEUC CGTA CRDB CTFA CTGA CTGE CWUB CWUC DDTA

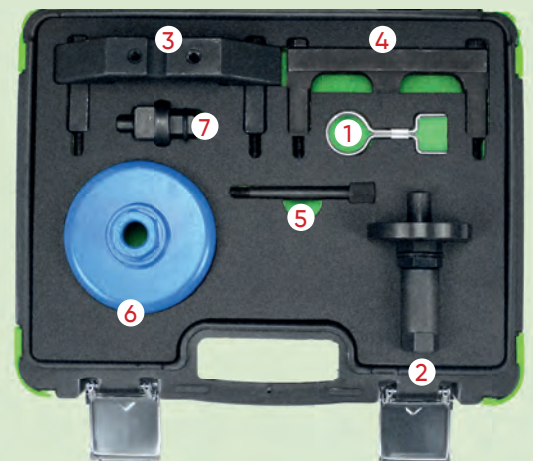

54431

184,00€



N

MOTOR-EINSTELLWERKZEUG SATZ FÜR ALFA ROMEO/MASERATI 2.9

MODELLE	ALFA ROMEO: GIULIA, STELVIO MASERATI: 3,8T
OEM WERKZEUG	1860815000 (1) 2024000090 (2) 2024100000 (3)
MOTORCODES	2.9: 670050436,670051007 ,670052721 ,670052722

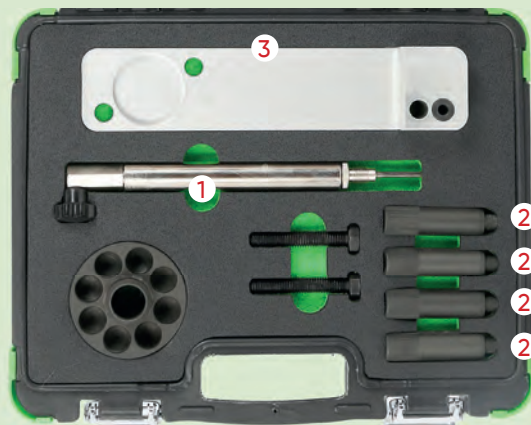

53315

285,00€



MOTOREINSTELLUNG WERKZEUG SET VOLVO 3.0, 3.2T6 / LAND ROVER 3.2

MODELLE	VOLVO: S60 (10-16), S80 (07-15), XC60 (08-15), XC70 (06-15), XC90 (10-14), V60 (10-15), V70 (10-15). LAND ROVER: FREELANDER II (11-14).
OEM WERKZEUG	VOLVO: 999-7263 (3), 999-7264 (1), 999-7272 (5), 999-7257 (2), 999-7261 (4). LAND ROVER: 303-1225 (3), 303-1226 (1), 303-1219 (2), 303-1223 (4).
MOTORCODES	3.0 TURBO: B6304T2, B6304T4. 3.2: B6324S, B6324S5. 3.2i6: B6324S.

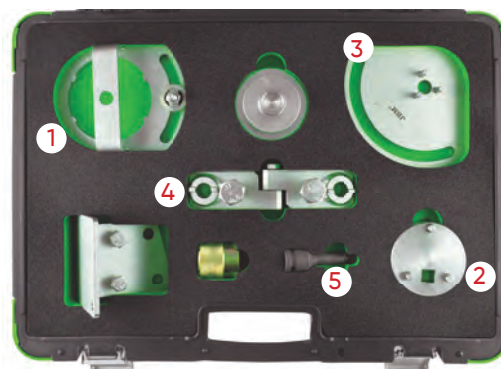

54226

71,00€



ABZIEHVORRICHTUNG FÜR HOCHDRUCKPUMPENRIEMENSCHLEIBE FÜR HYUNDAI/KIA

MODELLE	HYUNDAI: ACCENT (11-15), ELANTRA (07-10), I20 (09-18), I20 (10-18), I20 COUPE (15-17), I30 (07-19), IX35 (10-16), I40 (11-18) KIA: CARENS (13-18), CEED (07-18), OPTIMA (11-15), PRO-CEED (08-19), RIO (09-17), CERATO (05-07), SOUL (09-14), SPORTAGE (10-18), VENGA (09-18)
OEM WERKZEUG	09331-2A000/2A010 (1), 09331-2A010 (1)
MOTORCODES	1.1D CRDI: D3FF 1.4D CRDI: D4FC(U1), D4FC(U2) 1.6D CRDI: D4FB(U1), D4FB(U2), D4FB-H(U1), D4FB-H(U2), D4FB-L(U1) 1.7D CRDI: D4FD(U2), D4FD-H(U2), D4FD-L, D4FD-L(U2)



54200

56,00€

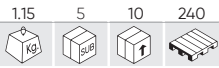

WERKZEUGSATZ FÜR MOTORSTEUERUNG FÜR PORSCHE

MODELLE	911 (2001 - 2008), BOXSTER (2002 - 2011), CAYMAN (2006 - 2009)
OEM WERKZEUG	9685 (1), 9686 (2), 9595 (3), 9595/1 (4)
MOTORCODES	M96/03, M96/05, M96/23, M96/25, M97/20, M96/24, M96/26, M97/01, M97/21, M97/22.



51927

25,00€

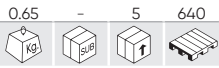

MONTAGHILFE UND SPANNER FÜR RIEMEN

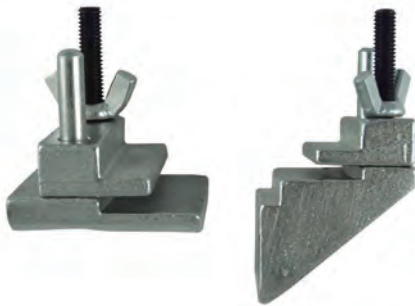

51340

39,30€

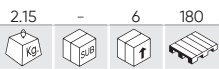

NOCKENWELLEN UNIVERSALSCHLÜSSEL + ADAPTER



52616

44,00€

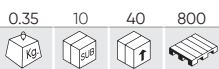

SPANNUNGSMESSER STEUERRIEMEN

- Anzeiger der Spannung des Zahnriemens bestimmt genau die Spannung an jedem Steuer- oder Zusatz-riemen jedes Fahrzeuges.

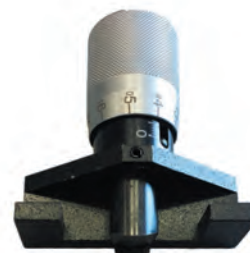

53769

178,00€

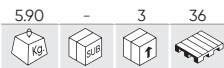

MOTOREINSTELLUNG WERKZEUG SET RENAULT/NISSAN/OPEL/VOLVO

MODELLE	<p>RENAULT: AVANTIME, CLIO, ESPACE, KANGOO, LAGUNA, MASTER, MEGANE, MODUS, SCENIC, TWINGO, TRAFFIC. OPEL/VAUXHALL: MOVANO, VIVARO. DACIA: DOKKER, DUSTER, LOGAN, SANDERO. NISSAN: ALMERA, INTERSTAR, KUBISTAR, MICRA, NOTE, PRIMERA, QASHQAI. VOLVO: S40, V40</p>	
OEM WERKZEUG	<p>MOT 1312 (1), MOT 1135-01 (2), MOT 1384 (3), MOT 1340 (4), MOT 1543 / KM-6234 / KV113 B0360 (5), MOT 1489 / KV113 B0130 (6), MOT 1536 / KM-6203 (7), MOT 1489 (8), MOT 1054 / KM-6031 / KV113 / B0280 (10), MOT 1318 (11), MOT 910 (12), MOT 910 (14), MOT 1386 (15), MOT 1534 / KM-6205 (16), MOT 1543 / KM-6234 / KV113 B0360 (17), MOT 1543 / KM-6234 / KV113 B0360 (18), MOT 1543 / KM-6234 / KV113 B0360 (19), MOT 1543 / KM-6234 / KV113 B0360 (20), MOT 1386 (22), MOT 1537 / KM-6204 (23), MOT 1348 (24), MOT 1538 (25), MOT 1337 (26), MOT 1496 / MOT 1750 (27), MOT 1490-01 (28), MOT 1200-01 (29)</p>	
MOTORCODES	<p>PEROL: 2.0 16V, 2.5 20V, 1.4, 1.6 16V, 1.8, 2.0 16V, 1.2, 1.7, 1.8, 2.0 16V, 2.2 GASOIL: 1.9, 2.5, 2.8</p> <p>D4F702/706/708/712/714/716/722/728/730/740/764, D7F700/701/710/720/722/726/730/744/746/764/766, E7F700/704/706/750, E7J601/624/626/634/635/680/700/706/710/711/716/718/719/720/724/726/728/740/742/745/754/756/757/764/770/771/773/780, F3P670/682/700/704/706/708/710/712/714/720/724/755/758/760, F7P704/722, F3R611/722/723/728/729/750/751/752/791/796/797/798, F5R700/701/740, J7R732/733/734/735/768, F7R710/714, J7T600/760/761/762/766/772/780/782, N7Q704/710/711, N7U700/701, K4J700/710/711/712/713/714/715/730/732/740/750/770/780, K4M700/701/704/706/707/708/709/710/711/712/714/716/718/720/724/730/732/734/736/740/742/743/744/745/746/748/750/752/753/754/760/761/762/764/765/766/768/776/782/788/790/791/794/800/801/802/804/812/813/830, K9K700/702/704/706/710/712/714/716/718/722/724/728/729/732/734/740/750/752/760/762/764/766/768/802/804/806, F9Q610/650/664/670/674/71/716/717/718/720/722/730/731/732/733/734/736/738/740/744/748/750/752/754/758/759/760/768/762/770/772/774/780/782/784/786/788/790/796/800/803/804/808/812/816/818/820, G9T600/605/700/702/703/706/707/710/712/720/722/742/743/750, G9U720/724/726/730/750/754, F8M736/760, F8Q600/610/606/620/622/624/630/632/640/644/646/648/662/672/678/680/682/684/692/696/706/714/720/722/730/732/740/742/744/764/768/706/776/784/786/788, J8S620/621/622/758/760/776/778, G8T714/716/740/752/760/790/792/794, S8U720/722/730/731/742/748/750/752/770/772/780/782, S9U700/702/704/714/740, S9W700/702/206/208/212, E5F, E6J, K7M, F4P/F4R, FIN, F2N, F3N, F2R, F3P, F4P, F3R, J5T, J6R, J7R</p>	

53773

298,00€



MOTOREINSTELLUNG WERKZEUG SET FIAT/ALFA/LANCIA/OPEL/SUZUKI/FORD

MODELLE	<p>ALFA: ROMEO 145, 146, 147, 155, 156, 159, 166, SPIDER, GTV, TS, GT, CROSSWAGON Q4 FIAT: PUNTO, GRANDE PUNTO, BRAVA, BRAVO, MAREA, WEEKEND, STILO, DOBLO, CARGO, IDEA, PANDA, MULTIPLA, PALIO, STILO, 500 LANCIA: LYBRA, YPSILON, THESIS, MUSA OPEL: CORSA, AGILA, MERIVA, COMBO, VECTRA, ZARA, ASTRA, INSIGNA, SIGNUM 19 CDTI SUZUKI: IGNIS, SWIFT, WAGON R+ FORD: KA</p>	
OEM WERKZEUG	<p>1860874000 (1), 1860874000 (2), 2000004400 / 2190754400 (3), 1860863000 (4), 1860898000 (5), 2190754500 (6), 2000004300 (7), 1870900400 (8), 1860703000 (9), 1860933000 (10), 1860845000 (11), 1870900300 (12), 1860905000 / EN-46788 (13), 1895443000 (14), 1860992000 (15), 1870896900 (16), 1860987000 (17), 1860905000 (18), 1860771000 (19), 1860161000 (20), 1860876000 (21), 1860876000 (22), 1871000900 (23), 1860985000 (24), 2000004200 / 2190754200 (25), 1860965000 (29)</p>	
MOTORCODES	<p>176B9.000, 182B2.000, 188A5.000, 843A1.000, 323.02, 371.01, 182B4.000, 182B9.000, 186A6.000, 188A2.000, 188A7.000, 188B2.000, 192A1.000, 192A3.000, 937A2.000, 939A1.000, 192A5.000, 192B1.000, 198A5.000, 937A5.000, 939A2.000, 325.01, 342.02, 362.02, 185A6.000, 841C.000, 841G.000, 939A3.000, 940A3.000, 940A4.000, 940A5.000, Z19DT/DTH/DTR/DTJ/DTL, 169A1.000, 955A4.000, 350A3.000, 192B4.000, 198A2.000, 350A2.000, 955A3.000, 192A8.000, 198A6.000, 198A3.000, 199B1.000, 199B2.000, 199A2.000, 199A3.000, 199A9.000, 188A3.000, 188A8.000, 188A9.000, 192A9.000, 186A8.000, 186A9.000, 199A5.000, 223A7.000, 223A9.000, 841H.000, 841P.000, 185A2.000, Z13DT, Z13DTJ, Z13DTH, 182A4.000, 182A6.000, 182B6.000, 178B3.000, 186A3.000, 186A4.000, 350A1.000, 169A4.000, 188A4.000, 199A4.000, 199A7.000</p>	

53770

198,00€

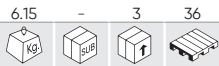

MOTOREINSTELLUNG WERKZEUG SET FORD/SEAT/VOLKSWAGEN/MAZDA/VOLVO

MODELLE	FORD: FIESTA, FUSION, COURIER, ESCORT, FOCUS, FOCUS C MAX, PUMA, MONDEO, SIERRA, COUGAR, GALAXY, C-MAX, ORION, TOURNEO CONNECT, TRANSIT, TRANSIT CONNECT. VW: SHARAN. SEAT: ALHAMBRA. MAZDA: 121. VOLVO: S40, V50.
OEM WERKZEUG	303-1061 (1), 303-1054 (2), 23-059 / 310-085 (3), 21-105 (4), 323-029 (6), 0194-B / 21-263 / 303-735 / 49 JE 02 021 (7), 0132-AB / 0178-D / 21-151 (9), 0194-C, 21-262, 303-734, 49 JE 02 020 (10), 21-238 / 303-679A / 303-1151 (11), 21-238 / 303-679A / 303-1151 (12), 303-1054 (13), 303-1151 (14), 21-238 / 303-679A (15), 303-393 / 303-393-02 (16), 303-1097 (17), 21-168 / 303-393 (18), 303-0985 (20), 2064 / 23-047 / 310-055 / U20003 (21), 303-652 (22), 21-229, 303-651 (23), 303-748 (24), 21-210 (25), 21-260, 303-732 (26), 21-163, 303-620 (27), 21-234 / 21-251 (28), 303-675 / 303-698 (29), 21-104 / 303-193 (30) / 21-162B / 303-367 / 303-376 (31), 21-162B / 303-376 / 303-376B (32), 23-019 (33), 23-058 / 310-084 (34), 0153-M / 0178-C / 0178-D (35), 0178-B / 5711-TB (36), 21-123 (37), 23-020 (38), 21-234 / 21-251 (39), 303-1059 (40), 23-019 (41), 303-1060 (42), 303-393 / 303-393-01 (43)
MOTORCODES	FUJA, FUJB, FXJA, FXJB, FYJA, FYJB, F8JA, F8JB, M7JA, M7JB, DHA, DHB, DHC, DHD, DHE, DHF, DHG, FHA, FHE, LIT, LIV, LIE, LIG, LIH, LIK, RDA, RDB, RKC, RQB, RQC, FXDA/C, FXDB/D, FYDA/C, FYDB/D, FYDH, HWDA1Z, AHU, AVG, AFN, D24, D24T, D24TIC, RFN, RTJ, RTK, RVA, RFK, RKD, B4164S3, DV4TD (8HW/8HX/8HZ), DV4TED4(8HV/8HY), DV6ATED4 (9HX/9HY/9HZ) F6JA, F6JB, F6JC, G8DA, G8DB, KKDA, SNJA, SNJB, STJA, STJB, ASDA, ASDB, FXJC, SPJA, SPJC, FYJC, HWDA, HWDB, SHDA, SHDB, SHDC, JQDA, LQDB, JTDA, JTDB, HXDA, HXJA, HXJB, IQDA/B, IQDB, PNBA, PNDA, RHBA, SIDA, F6JD, TZJA, TZJB, HHDA, HHDB, HHJA, HHJC, HHJD, HHJE, HHJF, RTA, RTB, RTC, RTD, RTE, RTF, RTH, RTJ, RTK, RFN, BHPA, HCPA, HCPB, KKDA, P7PA, P9PA, P9PB, R2PA, R3PA, RWPB, RWPB, F9DA/B, FFBA, FFWA, KHBA, QYBA, QYWA, KKDB, C9DC, RVA, 1Z, AFN, AHU, ANU, AUY, G6DA, G6DB, G6DC, G6DD, G6DE, G6DF, G6DG, UFDB, TXDB, TYDA, UKDB, QXBA, AZBA, KLBA, QXBB, LPBA, AZBC, TYBA, UKBA, UFBA, TXBA, IXDA, QXWA, QXWB, AZWA, KLWA, AZWC, TYWA, UKWA, TXWA, UFWA, UFDA, TXDA, UKDA, Q4BA, KNBA, 4BA, 4BB, 4BC, 4CC, 4FA, 4CA, 4CB, 4DA, 4EA, 4FA, 4FB, 4FC, 4FD, 4GA, 4HB, 4HC, 4EB, 4EC, 4ED, 4GA, 4GB, 4GC, 4GD, 4GE, 4GF, 4HA, 4HD, FMBA/B, D5BA, ABFA, D3FA, D6BA, HJBA/B, F3FA, D2FA, D4FA, F4FA, F5FA, DOFA, QJBA, QJBB, QJBC, QJBD, FXFA, H9FA, H9FB, N7BA, N7BB, MZ-CD 1.6, Y6

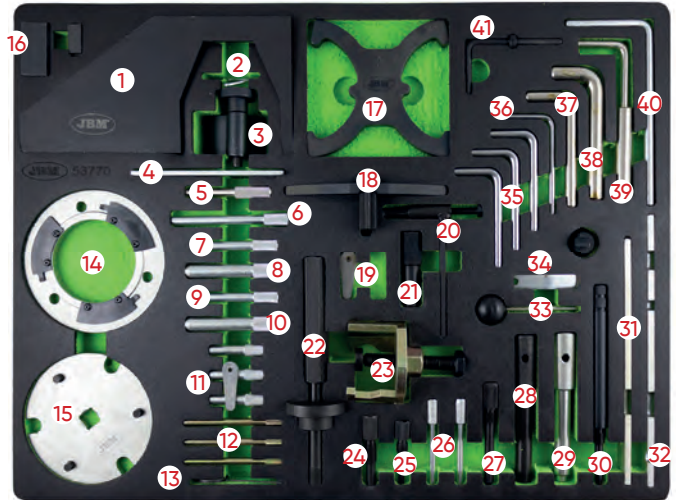

53774

190,00€

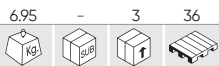

MOTOREINSTELLUNG WERKZEUG SET OPEL/CHEVROLET/SAAB/FIAT/LANCIA/SUZUKI/FORD

MODELLE	ALFA: 145, 146, 147, 156, 159, 166, GT, CROSSWAGON Q4 FIAT: PUNTO, GRANDE PUNTO, BRAVO, BRAVA, MAREA WEEKEND, STILO, DOBLO, CARGO, MULTIPLA IDEA, PANDA LANCIA: YPSILON, MUSA, LYBRA, THESIS OPEL: CORSA B/C, COMBO, TIGRA, AGILA, TIGRA B, MERIVA, ASTRA F/G/H, ASTRAVAN, SPEEDSTER VX220, ZAFIRA A/B, VECTRA B/C, SIGNUM, OMEGA B, SINTRA, FRONTERA A/B, ASTRAVAN, KADETT, ASCONA, OMEGA, MONTEREY, ANTARA, CROMA, SPEEDSTER VX220 SUZUKI: IGNIS, SWIFT, WAGON R+ FORD: KA CHEVROLET & DAEWOO: EPICA, CAPTIVA, NUBIRA, LACETTI, EVANDA SAAB: 9-3, 9-5 (98-04)
OEM WERKZEUG	1860905000 / 1860905010 / EN-46788 (1), KM-6148 (2), KM-6148 (3), 1870900400 / 1871000200 (4), KM-954 (5), KM-J-43651 (6), 1860905000 / 1860905010 / EN-46788 (7), KM-852 (8), KM-853 (9), 1870900300 / 303-1468 (10), EN-46785 / KM-951 (11), KM-932 (12), 1860703000 (13), KM-955 (14), KM-6130 / KM-6349 / KM-6349 (15), KM-927 (16), EN-48245 (17), KM-933 (18), EN-46785 (19), 1860985000 / 1871000900 / EN-46781 (20), 1860985000 / 1871000900 / EN-46781 (21), EN-48246 (22), KM-929 (23), 1870896900 / EN-46789 (24), KM-952 (25), 21-162B / 303-376 / 303-376B (26), KM-933 (27)
MOTORCODES	X14XE, Z14XE, X16SEJ, X16XE, X16XEL, Y16XE, Z16XE, Z16YNG, C18XEL, X18XE, X18XE1, Z18XE, Z18XEL, C20SEL, C20XE, X20XEV, Z20LEH, Z20LEL, Z20LER, Z20LET, X22SE, Y22SE, Y22XE, Z22XE, D223L, X10XE, Z10XE, Z10XEP, X12XE, Z12XE, Z14XEP, X20DTL, X20DTH, X22DTH, Y20DTL, Y20DTH, Y22DTR, 169A1.000, 955A4.000, 350A3.000, 192B4.000, 198A2.000, 198A2.000, 350A2.000, 955A3.000, 192A8.000, 198A6.000, 198A3.000, 199B1.000, 199B2.000, 199A2.000, 199A3.000, 199A9.000, 940A3.000, 188A3.000, 939A2.000, 188B2.000, 188A8.000, 188A9.000, 323.02, 371.01, 937A2.000, 182B4.000, 182B9.000, 188A2.000, 188A7.000, 192A9.000, 186A6.000, 186A8.000, 192A1.000, 192A3.000, 192B1.000, 192A5.000, 186A9.000, 939A1.000, 199A5.000, 223A7.000, 223A9.000, 342.02, 362.02, 84TG.000, 84TH.000, 84IP.000, 939A3.000, 185A2.000, 185A6.000, Z13DT, Z13DTJ, Z13DTH, Z19DT, Z19DTH, Z19DTJ, Z19DTL, X10XE, Z10XE, Z10XEP, Z12XE, Z14XEP, X16S2R, Z16SE, 4EC1/T, 4EC1, 4EE1/T, 4EE1, X17DT, Y17DT, Y17DTI, Y17DTL, 16DA, 17D, 17DR/X, 7DTL, X17DTL, 4JX1/4, JG2T, 4FC1/T, 4FD1, X20DTL, Y20DTL, D223L Z20DMH, Z20DM, RA420, Z20S1, 194A1.000, Z22SE, Z22YH

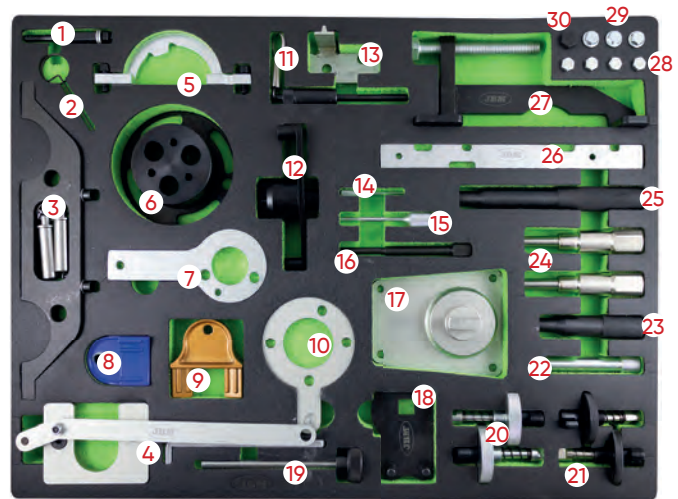

53771

158,00€

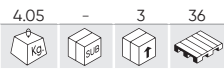

MOTOREINSTELLUNG WERKZEUG SET FIAT/FORD/CITROËN/PEUGEOT

MODELLE	<p>FIAT: ULYSSE, SCUDO, DUCATO LANCIA: ZETA, PHEDRA FORD: FIESTA, FUSION, FOCUS, FOCUS C-MAX CITROËN: C15, C1, C2, C3 PLURIEL, C4, C4 PICASSO, C5, C6, C8, DS3, DS4, DS5, XANTIA, XSARA, XSARA PICASSO, EVASION, BERLINGO, JUMPY, JUMPER, SAXO, ZX, XM, EVASION, AX PEUGEOT: 107, 1007, 206 CC, 207, 208, 306, 307 CC, 308, 406, 407, 508, 607, 806, 807, PARTNER, EXPERT, BOXER, 206, 106, 605, 205, 405</p>	
OEM WERKZEUG	<p>4200-TH (1), 0117-AR (2), 0188-X (3), 0606-A1.A2 (4), 0188-Q2 (5), 0189-S1 (6), 7017-TR (7), 0132-P / 4507-TL (8), 0189-C (9), 0188-J1 (10), 0188-J2 (11), 0178-E (12), 0189-R (13), 0132-AK / 0188-AK / 0189-K / 0153-AK / 4533-TAD / MOT 1436 (14), 0188-AH (15), 0189-S2 (16), 0153-AB / 9041-TZ (17), 0153-M / 0178-C / 0178-D / 7014-TM / 9767-94 (18), 0189-A (19), 4527-TS1 (20), 0153-AB / 9041-TZ (21), 0189-B / 21-163 (22), 0132-AJ1 / 0153-G / 0188-M / 0189-J / 4533-TAC1 / 5711-TA (24), 0189-L (25), 0188-D / 7017-TM (26), 0132-X / 0188-Q1 / 4507-TJ / 9767-89 (27), 0194-B (28), 0132-AB / 0194-A (29), 0194-C / 21-262 / 303-734 (30), 4527-TS2 (31), 0188-E (32), 0153-A / 6012-T / 9765-54 (33), 0134-AF / 0134-Q / 0188-F / 9004-T (34), 0188-P2 / 0188-P / 174 / 7015-T (35), 0153-U 7019-T (36), 0153-N / 0188-Y / 7014-TJ / 7099-TM / 9797-34 (37)</p>	
MOTORCODES	<p>F6JA, F6JB, F6JC, G8DA, G8DB, HHDA, HHDB, HHJA, HHJB CITROËN, PEUGEOT: 1.0 / 1.1 / 1.4 / 1.6 / 1.6 16V, 1.4 / 1.6HDI / 1.8 / 1.8 16V / 2.0 / 2.0 TURBO, 1.9D / 2.0HDI / 2.2HDI / 1.8 16V / 2.0 16V TU9 (CDY/CDZ), TU1 (HDY/HDZ/HFX/HFY/HFZ), TU3 (KDX/KDY/KDZ/KFX/KFZ), TU5JP4 (NFU/NFX), TU5 (BDY/BFZ/NFT/NFV/NFW/NFY/NFZ), XU7 (LFW/LFX/LFZ), EW7J4 (RLZ), XU7JP4 (LGY), XU10 (RFL/RFU/RFW/RFX/RGX/RGY), XU10JP4 (RGX/RGY), EW10A (RFJ), EW10J4S (RFK), EW10D (RLZ), EW12J4 (3FZ), ET3JE (KFU), TU3A/JP (KFV/KFW), DV4TD (8HW/8HX/8HZ), DV4TED4 (8HV/8HY), DV6ATED4 (9HX/9HY/9HZ), EW10-CVI (RLZ), EW12 (3FZ), DW8 (WJZ/WJY), DW10 (RHY/RHV/RHZ/RHS/RHM/RHW/RHT/RHR/RHX), DW12 (4HX/4HZ/4HW/4HY), EW7J4 (6FZ), EW10J4 (RFR), EW10J4D (RLZ), DW12TED4 (4HW), DW10ATED (RHT/RHV/RHW/RHX/RHZ) FORD 1.4 / 1.6 DURATORQ TDCI</p>	

53772

229,00€

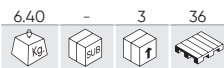

MOTOREINSTELLUNG WERKZEUG SET FORD/VAG/MAZDA/VOLVO

MODELLE	<p>AUDI: 80, A1, A2, A3, S3, A4, A5, A6, TT, Q5 SEAT: AROSA, IBIZA, CORDOBA, LEON, TOLEDO, ALHAMBRA, ALTEA, INCA (99-04) SKODA: FABIA, OCTAVIA, SUPERB VW: LUPO, POLO, FOX, GOLF, BORA, JETTA, GOLF PLUS, PASSAT, BEETLE, TOURAN, SHARAN, CADDY, CADDY MAXI, TRANSPORTER, GOLF VI CABRIO, TIGUAN FORD: GALAXY</p>	
OEM WERKZEUG	<p>T10252 (1), VAS6079 (2), T10121 (3), MP1-1312 / T10098 / T20038 / T20038 (4), T10123 (5), 23-058 / 310-084 / T10008 (6), 2065A / T10008 / U40021 (7), 3418 (8), T10171 (9), 23-059 / 23-059 / 310-085 / T10050 / T10050 (10), 3458 / T30094 (11), T10016 / T10074 / T10074 (12), T10100 (14), T10414 (15), 3366 / T20018 / T20044 (16), 3411 (17), 3369 / T30092 (18), T10341 (19), 3242 / T40069 / T30052 (20), T 40026 (21), 3359 / MP1-301 / T20102 (22), 2064 / U20003 (23), T10120 (24), MP1-1312 / T10098 / T20038 (25), T10170 (26), T00115 / T10264 / T40098 (27), T10092 (28), T00115 / T10264 / T40098 (29), 303-1054 / T10115 (30), T10060 / T10060A (31), 3359 / MP1-301 / T20102 (32), T10340 (33), 2587 (34), 3387 / U30009A (35), 3387 / T10020 (36)</p>	
MOTORCODES	<p>ARC, ATN, AUS, AVY, AZD, AFH, BCA, AJV, AKQ, AUA, AUB, AXP, AFH, AFN, AFK, AHW, AHU, APE, AQQ, AUS, AXP, AZD, BBY, BBZ, BCB, ANY, AYZ, AMF, ATL, BAY, BHC, BMS, BNM, BNV, BWB, AJM, AMG, ANU, ARL, ASZ, ATD, ATJ, AUY, AVB, AVF, AVQ, AWX, AXB, AXC, AXR, BEW, BJB, BKC, BKE, BLS, BLT, BMT, BPX, BRB, BRM, BRR, BRU, BU, BSV, BTB, BUK, BVK, BXE, BXF, AZV, BDJ, BDK, BGW, BHW, BKD, BKP, BLB, BMA, BMM, BMN, BMP, BMR, BNA, BPW, BRC, BRE, BRF, BRT, BUZ, BE, BVF, BVG, BVH, BWK, BTS, BMY, BLF, BWV, AZV, BKD, AWY, AZQ (55 - 64 PF), AXU, BAG, BKG, BLF, BLN, BLP, BVF, BKF, BNU, BVP, BVR, TZ, CBZA, CBZC, CBZB, CAXA, CAGA, CAGB, CAGC, CAHA, CAYA, CAYB, CAYC, CBAA, CBAB, CBAC, CBBA, CBBB, CBDA, CBDB, CBDC, CBEA, CECA, CKUB, AZV, BDJ, BHP, BKD, BLB, BMA, BMM, BMN, BMP, BMR, BNA, BPW, BRC, BRE, BRF, BRT, BSS, BUJ, BUZ, BVA, BVE, BVF, BVG, BVH, BWV, ACV, AFB, AGX, AHD, AHY, AHY, AJT, AKE, ANJ, APA, AUF, AXG, AXG, AXL, AYC, AYM, AYY, BAU, BBE, BBF, BCZ, BDG, BDH, BFC, BJJ, BJK, BJL, BJM</p>	

WERKZEUGWAGEN MIT 7 FÄCHER SPEZIAL AUSSTATTUNG MOTOREINSTELLUNG

53951 1.794,00€

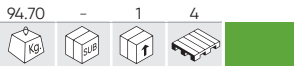

EVA-WERKZEUGEN

53952 1.794,00€

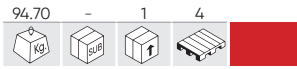

EVA-WERKZEUGEN

54501 1.794,00€

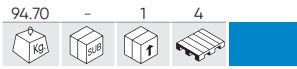

EVA-WERKZEUGEN

54502 1.794,00€

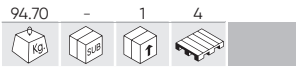

EVA-WERKZEUGEN

INNENMASSE

KLEINE SCHUBLADEN (X5)

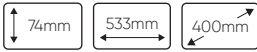

GROSSE SCHUBLADEN (X2)



SCHUBLADENLADEKAPAZITÄT: 30KG.
GESAMTLADEKAPAZITÄT: 70KG.

INNENMASSE

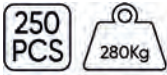

SORTIERTE EVA-WERKZEUGSÄTZE:

**6 MODULE
MOTOREINSTELLUNG
WERKZEUG SET**

53775 1.109,00€

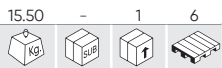

GASOLINA/PETROL DIESEL/GASOIL

ENTHALTEN

REF.	Box	Tray	€
53769	5.90	3	178,00€
53770	6.15	3	198,00€
53771	4.05	3	158,00€
53772	6.40	3	229,00€
53773	6.60	3	298,00€
53774	6.95	3	190,00€

53769



RENAULT / NISSAN / OPEL / VOLVO

53770



FORD / SEAT / VOLKSWAGEN / MAZDA / VOLVO

53771



FIAT / FORD / CITROËN / PEUGEOT

53772



FORD / VAG / MAZDA / VOLVO

53773



FIAT / ALFA / LANCIA / OPEL / SUZUKI / FORD

53774



OPEL / CHEVROLET / SAAB / FIAT / LANCIA / SUZUKI / FORD

**FÜR WEITERE
INFORMATIONEN**

SEITE 297

**ZUBEHÖR UND
ERSATZTEILE**

SEITE 90

300 ohne MwSt



www.jbmcamp.com

SCHMIERZUBEHÖR

302 DIESELKRAFTSTOFF-FÖRDERPUMPEN

303 HARNSTOFF-VERSORGUNGSPUMPEN

304 ABSAUG-/ABFÜLLPUMPEN

307 ÖLSAMMLER

308 SAUGPISTOLEN

309 ÖLAUFFANGBEHÄLTER

310 SONSTIGES



53697

398,00€

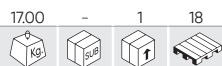

DIESELKRAFTSTOFFPUMPE MIT ZAPFPISTOLE UND ANZEIGE (200-240 V)



- Nominalspannung: 200-240V.
- Nominalleistung: 550 Watt.
- Maximalfluss: 60 L/Min.
- Länge des Saugschlauchs: 2m.
- Länge des Druckschlauchs: 4m.

MIT AUTOMATISCHEM STOPP



ERSATZTEILE VERFÜGBAR

53610

294,00€



DIESELKRAFTSTOFFPUMPE MIT ZAPFPISTOLE



- Länge des Eingangsschlauchs: 2m.
- Länge des Ausgangsschlauchs: 4m.
- Elektrische Pumpe.
- Schläuche und Düse enthalten.

MIT AUTOMATISCHEM STOPP



ERSATZTEILE VERFÜGBAR

53609

182,50€



DIESELKRAFTSTOFFPUMPE MIT ZAPFPISTOLE



- Länge des Eingangsschlauchs: 2m.
- Länge des Ausgangsschlauchs: 4m.

MIT AUTOMATISCHEM STOPP



ERSATZTEILE VERFÜGBAR

54100

265,00€



DIESELELEKTRISCHE PUMPE



- Durchflussmenge: 18,4LPM (4,86GPM)
- Länge des Ansaugrohrs: 850-1245mm (850-1245mm)
- Schlauchlänge: 2m
- Arbeitstemperatur: 5°- 40°C (41° bis 104°F)
- Spannung Gleichstrom: 12V
- Wechselstrom: 100-240V
- Kabellänge: 4m



53645

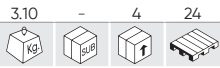

ELEKTRISCHE PUMPE FÜR UREA AUS32



- Die elektrische Rotationspumpe ist für den Betrieb mit Wasser und Urea AUS32 DEF ausgelegt und ermöglicht das Pumpen von Inhalten aus IBC-Fässern mit einem Volumen von 205 oder 1000-1250l.
- Kompaktes und leichtes Design.
- Eingebaute Sicherung für Überlastschutz und geräuschloser Motor.
- Eingebauter Filter in dem Saugrohr aus rostfreier Stahl, der den Eintritt von Verunreinigungen verhindert und als Ergebnis Schäden ausschließt.



268,00€



53644

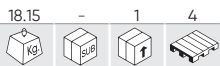

UREA AUS32-TANK, 75 L



- Autonomes und voll mobiles Design mit einem Volumen von 75 Liter und einer Pumpe mit einer Spannung von 12 V, die mit einem Schlauch und einem automatischen Absperrventil ausgestattet ist.
- Der Behälter aus Polyethylen ist kompakt, korrosions- und UV-beständig.
- Räder mit großem Durchmesser bieten eine hohe Wendigkeit auch auf unebenem Boden.



1.238,00€



15631

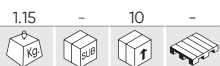

KARBAMIDSELBSTLADEPISTOLE AUS 32 (REF. NR. 53645)



98,00€

52329



HANDPUMPE AUS KUNSTSTOFF



- Für Fässer 25, 50, 200 l.
- Eigenvolumen 350 ml.
- Gehäuse und Kolben aus Polypropylen.
- Griff aus ABC.
- Anwendbarkeit: Alkohol, Öl, Schmierstoffe, Benzin/Diesel, Kerosin usw.
- Saugleitung:
Minimale Breite: 320 mm.
Maximale Länge: 900 mm.



36,40€



13982

4,00€



GEWINDEADAPTER PUMPE/ KUNSTSTOFF FASS

- Sieht eine Einstellung und Ausgleichung verschiedener Gewinde von Tanks, Fässern und Pumpen vor.



52601

397,00€

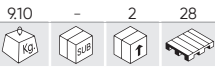

200L

ÖLPUMPE FÜR FÄSSE + SCHLAUCH MIT PISTOLE

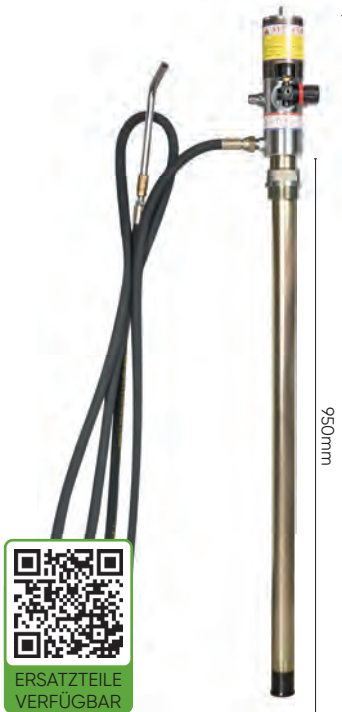

- Druckverhältnis: 5:1.
- Luftanschluss: 1/4".
- Luftablass: 1/4".
- Arbeitsdruck: 6-8 bar.
- Max. Druck: 8 bar.
- Luftverbrauch: 250 l/min.
- Leistungsverhältnis bei 6 bar: 18 l/min.
- Öltemperaturbereich: -10-50 °C.
- Maximale Viskosität: 240 SAE.
- Rohrlänge: 950 mm.

50918

341,00€

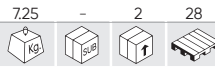

200L

ÖLPUMPE FÜR ÖLFÄSSE

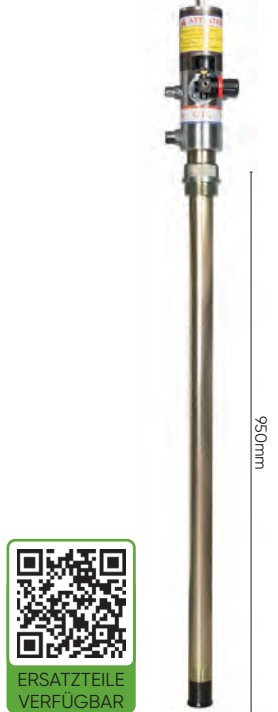

- Druckverhältnis: 5:1.
- Luftanschluss: 1/4".
- Luftablass: 1/2".
- Arbeitsdruck: 6-8 bar.
- Max. Druck: 8 bar.
- Luftverbrauch: 250 l/min.
- Leistungsverhältnis bei 6 bar: 18 l/min.
- Öltemperaturbereich: -10-50 °C.
- Maximale Viskosität: 240 SAE.
- Rohrlänge: 950 mm.

50935

595,00€

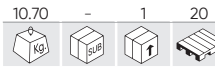

200L

ÖLPUMPE + SCHLAUCH MIT DIGITAL-PISTOLE



- Leistungsverhältnis bei 6 bar: 18 l/min.
- Öltemperaturbereich: -10-50 °C.
- Maximale Viskosität: 240 SAE.
- Druckverhältnis: 5:1.
- Luftanschluss: 1/4".
- Luftablass: 1/2".
- Arbeitsdruck: 6-8 bar.
- Max. Druck: 8 bar.
- Luftverbrauch: 250l/min.
- Schlauchlänge: 2 m.
- Rohrlänge: 950 mm.

53566

32,00€

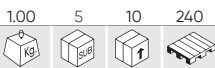

ÖLABSAUGPUMPE AN 12V AUTOBATTERIE



- Die Ölabsaugpumpe (Extraktor) ist ein ideales Gerät für ein schnelles und sauberes Ölwechsel.
- Es funktioniert, indem die Klemmen an eine 12-Volt-Autobatterie angeschlossen werden.
- Das Öl wird aus dem Motor durch das Ölmesstab-Loch abgesaugt.
- Verwenden Sie den Extraktor nur zum Abpumpen von Motoröl, Öl für Dieselmotoren und Heizölsöl.



51253 41,00€

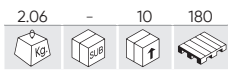

HANDPUMPE FÜR ÖLFASS

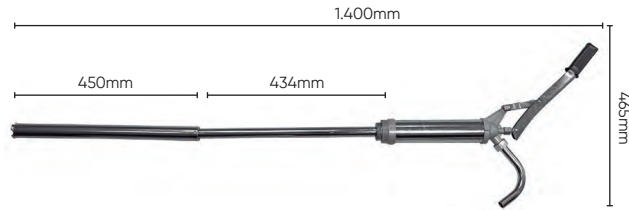

52428 40,00€

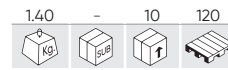

HANDPUMPE FÜR ÖLFASS

- Für 50 und 200 l Fässer.
- Eigenvolumen 400 ml.
- Komplett mit Adapter 2".
- 101 cm Saugröhre mit 1 1/4" Einlauf und 1" Auslauf.
- Anwendungen: Öle, Schmierstoffe, Diesel, Flüssigkeiten auf Ölbasis.
- Empfohlen für: Bremsflüssigkeit, Reinigungsmittel, Glycerin, schwache Säuren, ölhaltige Flüssigkeiten.
- Nicht geeignet: starke Säuren, Bleichmittel, Benzin.



50917 271,00€

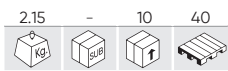

DIGITALE MESS-PISTOLE

- Luftanschluss: 1/2" BSPF
- Leistungsbereich: 1-35 L/min
- Arbeitsdruck: 6-8 bar
- Max. Arbeitsdruck: 100 bar
- Öltemperaturbereich: -10-60 °C
- Maximale Viskosität: 240 SAE
- Batterie: 2x1,5V (Batterie enthalten)
- Genauigkeit des Durchflussmessers: ±0,5%
- Wiederholbarkeit des Durchflussmessers: 0,2%
- Entladerate pro Umdrehung: 25ml/R



53627 22,50€

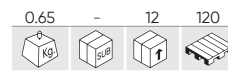

ÖL- UND KRAFTSTOFFABSAUG-SET

Das Gerät ist für die schnelle Entfernung von Öl, Kraftstoff, sowie Getriebeöl/Differentialöl aus Generator tanks, Hochdruckreinigern, Druckluft Kompressoren, Rasentraktor oder Geländefahrzeugen bestimmt und hergestellt.

1,6L



REF. BESCHREIBUNG	Icon	Icon	€
10000 ERSATZBATTERIE FÜR REF. 50917	2.10	-	7,00€

52797 198,00€

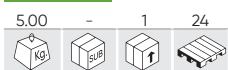

FÜLLPUMPE GETRIEBE SET MIT ADAPTERN

- Volumen: 7,5 l.
- Schlauch: 80 cc ciclo.
- Viskosität SAE 140.
- Unterstützt Befüllen und Entleeren



REF. BESCHREIBUNG	Icon	Icon	€
13234 GETRIEBEÖL-FÜLLSYSTEM OHNE ZUBEHÖR (IN SET REF. 52797)	3.75	24	224,50€

12044 147,00€

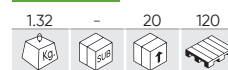

ADAPTER-SET FÜR FÜLLPUMPEN GETRIEBE

- ATF101: FORD 1/8 - 27 (NPT).
- ATF102: Universal BMW, Honda, Nissan, etc.
- ATF103: VW/Audi. Skoda.
- ATF104: VW/Audi. Porsche.
- ATF105: VW/Audi, Mini cooper M10x1.0
- ATF106: VW/Audi DSG M24 x 1.5
- ATF107: VW/Audi CVT M22x1.5
- ATF108: Mercedes M12 x 1.5
- ATF109: V/W. Skoda M18x1.5
- ATF110: Audi/VW, Skoda M30x1.5
- ATF111: Universal flexible 300mm. Honda. Hyundai. KIA...
- ATF112: Volvo 5/16 - 24 (UNF)
- ATF113: Toyota, Lexus M18 x 1.5
- ATF114: Nissan, Infinity M8 x 1.0
- ATF115: ATF-Adapter VW Passat



54290

4.307,00€

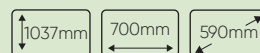

N

AUTOMATIKGETRIEBE-ÖLWECHSELMASCHINE

220V 50hz	150V	-10°C 50°C	40L	2 L/min	Error de intercambio equivalente Equivalent exchange error ±100ml
<90%	0-150 PSI	5µm	<70dB	70kg	

- Mehrsprachige Menüs
- Automatische Erkennung der Flüssigkeitsrichtung
- Automatische Spülung
- Automatischer Wechsel von neuer/verwendeter Flüssigkeit.
- Anzeige der Flüssigkeitsdruckwerte
- Genaue Anzeige der Temperatur der Übertragungsflüssigkeit
- Intelligente elektronische Steuerung, die sicherstellt
- Aktualisierbare Datenbank
- Inklusive Adapter für verschiedene Marken
- Verbessert die Leistung des automatischen Getriebesystems



VIDEO-TUTORIAL



ERSATZTEILE VERFÜGBAR

54367

729,00€



N

ADAPTERSATZ FÜR REF.54290 (105 STÜCK)

ENTHALTEN



TECHNISCHE INFORMATIONEN

54050

895,00€



ÖLWECHSELGERÄT AUTOMATIKGETRIEBE

- Stromversorgung: 12 V (Autobatterie)
- Pumpenleistung: 70 Watt
- Durchmesser des Ölmanometers: 70 mm (beide Ölmanometer)
- Messbereich der Ölmanometer: 0-10 Bar (0-150 psi)
- Volumen des Frischöltanks: 30 L
- Volumen des Altöltanks: 30 L



VIDEO-TUTORIAL



ERSATZTEILE VERFÜGBAR

53874

398,00€

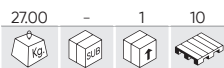

ÖLAUFFANGBEHÄLTER MIT ABSAUGERÄT

90L 8-10 BAR



ERSATZTEILE VERFÜGBAR



FÜR LASTKRAFTWAGEN/FAHRZEUGE

- Luft- Arbeitsdruck 8 ~ 10 Bar
- Vakuumniveau: negativ 0 ~ 0,8 Bar
- Behältervolumen: 70 L
- Volumen des Sammelschutzsiebs: 10L
- Volumen des Meßbechers: 10L
- Ansauggeschwindigkeit entsprechend dem Messstab-Durchmesser: 0,8 L/Min (Ø5x3,5 mm); 1 L/Min (Ø6x4,5 mm); 1,6 L/Min (Ø8x6,5 mm)
- Abmessungen: 343x49x163 cm
- Mittel: Maschinenöl und Achsöl
- Vorgeschriebene Ölarbeitstemperatur: 40 ~ 60°C
- Mit Vakuum Extraktion.
- Übersichtliches Meßsystem.
- Großvolumiger Behälter.
- Griff zur Erleichterung der Manipulation.
- Rollen zur Erleichterung des Transports.

53873

285,00€

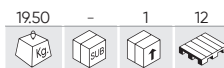

ÖLAUFFANGBEHÄLTER

80L 1-3 BAR



ERSATZTEILE VERFÜGBAR



FÜR LASTKRAFTWAGEN/FAHRZEUGE

- Luft- Arbeitsdruck: 1-3 Bar
- Behältervolumen: 70 L
- Volumen des Sammelschutzsiebs: 10L
- Gewicht: 18 kg
- Abmessungen: 35x48x163 cm
- Mittel: Maschinenöl und Achsöl
- Großvolumiger Behälter.
- Griff zur Erleichterung der Manipulation.
- Rollen zur Erleichterung des Transports.
- Kann für Öle mit hoher Temperatur verwendet werden (ohne Beschränkung).

15084

68,00€

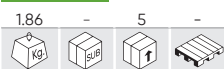

EVA-MODUL NUSS-SET FÜR ÖLABLASSSCHRAUBEN

	x2 5/16", 3/8"		x7 8, 9, 10, 12, 13, 14, 17mm
	x7 7, 8, 10, 11, 12, 13, 14mm		x1 T45
	x1 10mm		x1 M16
	x1 10mm		x1 200mm
			x1 150mm



53215

19,00€

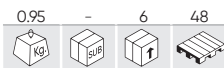

185mm Ø380mm

FROSTSCHUTZMITTEL AUFFANG-BEHÄLTER PVC

18L



53144

18,00€

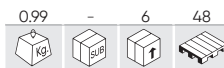

185mm Ø380mm

ÖL AUFFANG-BEHÄLTER PVC

18L



54051

39,00€

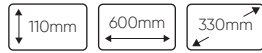
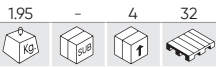

ÖLPFANNE 8 L

8L PE



51356

48,00€

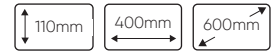
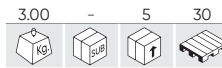

STAHLWANNE FÜR FLÜSSIGKEITEN

23L



52498

58,00€

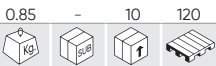

ABSAUGSPRITZE TRANSPARENT



- Transparentes Gehäuse aus Polypropylen.
- Geeignet für Triebwerke und Ausgleichsgetriebe.
- Beständig gegen Bremsflüssigkeit und Frostschutzmittel.



52628

26,50€

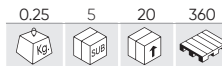

DURCHSICHTIGE ABSAUGSPRITZE



- Wird für die Bremsflüssigkeit verwendet.
- Außenanschluss.



REF. BESCHREIBUNG

11867 ERSATZ-O-RING FÜR REF. 52498

Icon	Value	€
Box	0.02	
Sub-unit	-	
Unit	100	
Pallet	-	
Price		9,00€

51928

14,00€

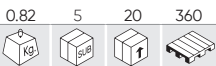

ÖL-ABSAUG-PISTOLE

500 ml Cr

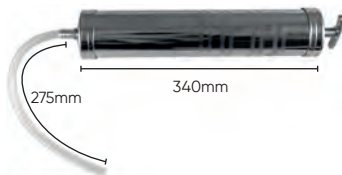

52789

15,20€

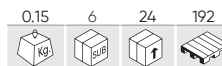

MANUELLER ÖLABSAUGER



- Schlauchlänge von 90 cm von jeder Seite.

50924

342,00€

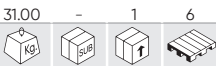

TRANSPORTWAGEN FÜR ÖLFÄSSER

200L



AUFFANGWANNEN

52804 343,00€

14.50 - 1 5

230L 400Kg

GENEHMIGT DIBT
1 VERTIKALES FASS



52805 426,00€

13.35 - 1 6

250L 650Kg

GENEHMIGT DIBT
2 VERTIKALE FÄSSER



52806 742,00€

17.50 - 1 5

250L 1250Kg

GENEHMIGT DIBT
4 VERTIKALE FÄSSER



53214 285,00€

16.50 - 1 12

230L 650Kg

380mm 1310mm 910mm

AUFFANGWANNE SPEZIAL FÜR FÄSSER
DIREKT AUF EUROPALETTE

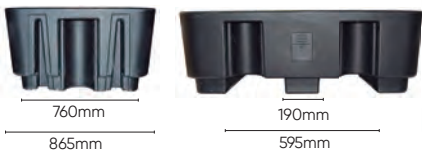

52807 1.714,00€

30.00 - 1 7

1000L 2500Kg

700mm 1680mm 1680mm

AUFFANGWANNE FÜR 1 IBC FASS 1000 L



GENEHMIGT DIBT



54498 6.090,00€

221.00 - 1 -

2500Kg 2500mm 1775mm 1770mm

IBC HARDCOVER

Ermöglicht die Lagerung von IBC-Containern. Bietet maximalen Wetterschutz für den Container. Mit Flüssigkeitsauffangwanne mit 2 Litern Fassungsvermögen, integrierter Auffangwanne und Lüftungsschlitzen.

- 1000 LITER FASSUNGSVERMÖGEN: 1 STÜCK
- FASSUNGSVERMÖGEN VON 200 LITERN: 4 EINHEITEN
- GESAMTBELASTBARKEIT: 2500KG



IBC-CONTAINER NICHT ENTHALTEN

53612

96,00€

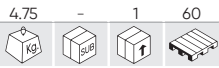

FASSKRALLE - TRAGFÄHIGKEIT 500 KG



- Für den Transport von Ölfässern.
- Tragfähigkeit: 500 kg.
- Vertikaler Greifer.
- Spezialfässer 200 l.



BENZINKANISTER

REF.	L/mm				€
54181	5L - 550x260x350mm	1.45	4	72	25,10€
54182	10L - 570x350x425mm	2.55	4	48	34,70€
54184	20L - 760x370x500mm	4.10	4	24	44,00€



54183

38,20€

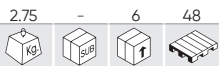

10 L KANISTER MIT KIPPSCHUTZ



REF. BESCHREIBUNG

15874 FLEXIBLER FÜLLSCHLAUCH FÜR KANISTER (REF.54181, 54182, 54183, 54184)

				€
0.30	-	50	800	6,50€

52452

8,00€

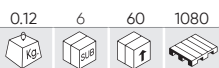

NYLONSCHLÜSSEL FÜR FÄSSER



- Material: Nylon.
- Funken- und staubgeschützt.
- Baugrößen: 3/4" und 2".
- Geeignet für Fässer 200 l.

53078

18,00€



FASSHAHN FÜR 200 L FÄSSER



- Sieht eine schnelle Entleerung von 200 L-Fässern vor.
- Geeignet für Wasser, alle Typen von Ölen, Alkohol, sowie schwach konzentrierten Säuren und schwache Basisflüssigkeit.
- Material: PE.
- EPDM-Einlage.
- Edelstahlfeder.

53518

3,50€



FASS HAHN 3/4" AUS KUNSTSTOFF FÜR 200L-ÖLFASS



- Geeignet für Flüssigkeiten aller Typen.
- 3/4"-Schraubengewinde.

52453

21,00€

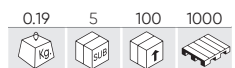

MESSINGHAHN 3/4" FÜR 200L-FÄSSER



- Festes Messing.
- Baugrößen: 3/4".
- Zentrierung des Körpers.
- Nylon.
- Anwendbarkeit: Öl, Schmierstoffe, Benzin/Diesel, Kerosin usw.
- Geeignet für Urea AUS32-Reaktiv.

52242

12,00€

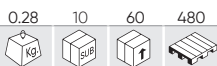

ÖLER 500 ML

500ml



52243

8,50€



ÖLER 250 ML

250ml



52991

10,50€



KANNE MIT FLEXIBLER TÜLLE

2L



52992

18,00€



KANNE MIT FLEXIBLER TÜLLE

5L



53187

39,00€



TRICHTER FÜR 200L FASS MIT DECKEL UND FILTER

4,5L



- Ø Innere: 245mm.
- Ø Äußere: 255mm.

53188

7,00€



TRICHTER SET - 3 TEILE

Ø 90,130,180mm



52391

5,00€

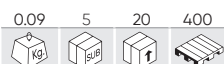

TRICHTER MIT FILTER

950ml



140x15mm



53198

9,50€

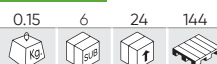

TRICHTER MIT FLEXIBLEM SCHLAUCH

1,8L



Ø 180mm



53849

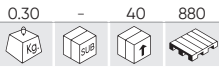

MINI-FETTPRESSE



16,10€

50852

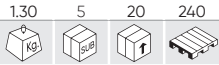

FETTPRESSE MIT FLEXIBLEM SCHLAUCH



24,50€

50751

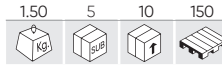

FETTPRESSE DRUCKLUFT

- Hartes Rohr
- Flexibles Rohr
- Druck: 30 Mpa.



43,00€

53592

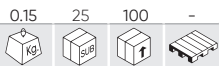

SCHNELLKUPPLUNG FÜR SCHMIERFETT



25,00€

54255

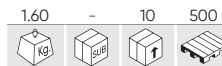

ZUBEHÖRSATZ FÜR FETTPRESSE



68,00€

Der Adapter ist zur Anwendung mit den Spritzpistolen Ref. 50751 und Ref. 50852 empfohlen, er kann dabei auch mit manuellen, pneumatischen oder Akku-Spritzpistolen und Schmierfettpumpen angewendet werden.

60038

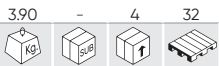

BATTERIE-ÖLGERÄT

BATTERIE NICHT ENTHALTEN.

Dieses Werkzeug ist eine Schmierfettpresse. Dank der Batteriespeisung ist das Werkzeug einfach zu bedienen und zu transportieren.

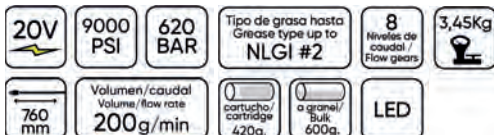

255,00€

HYDRAULISCHE WERKZEUGE

- 314 RANGIERWAGENHEBER
- 316 STEMPELHEBER
- 317 ATV-HEBER
- 317 GETRIEBEHEBER
- 318 UNTERSTELLBÖCKE
- 318 SONSTIGES
- 320 HUBWAGEN
- 321 PRESSEN
- 322 KRANE
- 323 HUBTISCHEN
- 325 GUMMI-STOPFEN FÜR HEBEBÜHNEN



53725

248,00€

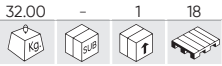

WAGENHEBER MIT SCHNELLST-HUB



MAX: 465mm
MIN: 133mm



ERSATZTEILE VERFÜGBAR

ÜBEREINSTIMMUNG MIT: EN 1494:2001

50818

198,00€

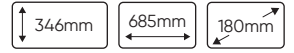
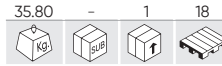

WAGENHEBER



MAX: 495mm
MIN: 133mm



ERSATZTEILE VERFÜGBAR

ÜBEREINSTIMMUNG MIT: EN 1494:2001

53422

368,00€

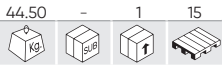

WAGENHEBER MIT 2-FACH HUBKOLBEN UND FUSSPEDAL



MAX: 533mm
MIN: 100mm



ERSATZTEILE VERFÜGBAR

50815

88,00€

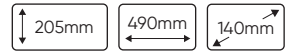
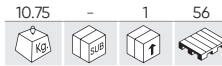

WAGENHEBER MIT FUSSPEDAL



MAX: 355mm
MIN: 130mm



ERSATZTEILE VERFÜGBAR

53112

298,00€

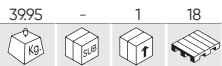

WAGENHEBER MIT FUSSPEDAL



MAX: 520mm
MIN: 140mm



ERSATZTEILE VERFÜGBAR

53968

49,00€

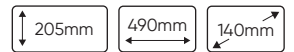
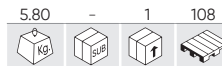

HANDWAGEN HYDRAULISCHE KRIK 2T



MAX: 300mm
MIN: 130mm



ERSATZTEILE VERFÜGBAR

ÜBEREINSTIMMUNG MIT: EN 1494:2001

51895

99,00€

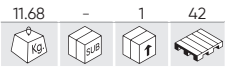

WAGENHEBER MIT KUNSTSTOFFKOFFER



↑ MAX: 355mm
↓ MIN: 130mm



50816

88,00€

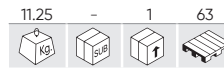

WAGENHEBER FÜR NIEDRIGE FAHRZEUGE



↑ MAX: 340mm
↓ MIN: 90mm



53421

298,00€

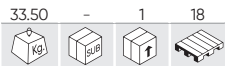

WAGENHEBER FÜR NIEDRIGE FAHRZEUGE MIT 2-FACH HUBKOLBEN



↑ MAX: 505mm
↓ MIN: 75mm



54137

288,00€

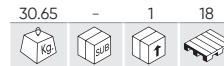

WAGENHEBER FÜR NIEDRIGE FAHRZEUGE MIT 2,5-FACH HUBKOLBEN



↑ MAX: 505mm
↓ MIN: 78mm

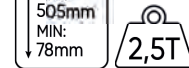

DOPPELKOLBEN

WARTUNG



HYDRAULISCHE WAGENHEBER FÜR TIEFLIEGENDE FAHRZEUGE

AUFGRUND IHRER GERINGEREN HÖHE UND IHRES ABGERUNDETEN DESIGNS EIGNEN SIE SICH OPTIMAL FÜR FAHRZEUGE MIT GERINGEM PROFIL.

FLASCHEN-WAGENHEBER

50819 28,00€

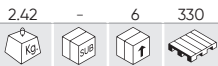

MAX: 345mm
MIN: 181mm
2T



50820 34,50€

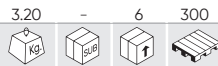

MAX: 372mm
MIN: 194mm
3T



50821 47,00€

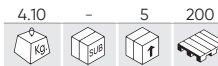

MAX: 413mm
MIN: 216mm
5T



50822 59,00€

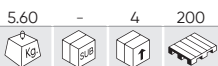

MAX: 460mm
MIN: 230mm
10T



52304 84,00€



MAX: 365mm
MIN: 225mm
15T



50823 94,00€

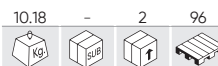

MAX: 452mm
MIN: 242mm
20T



50824 88,00€

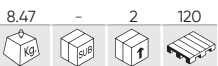

MAX: 355mm
MIN: 190mm
20T

FÜR NIEDRIGE FAHRZEUGE



50825 154,00€

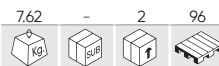

MAX: 465mm
MIN: 285mm
30T



FLASCHEN-WAGENHEBER MIT KUNSTSTOFFKOFFER

51905 34,50€



MAX: 340mm
MIN: 185mm
2T



51906 39,00€



MAX: 385mm
MIN: 195mm
3T



51907 48,00€



MAX: 450mm
MIN: 215mm
5T



ATV/QUAD-WAGENHEBER

REF.	Min.	Max.	mm				€
53895	130mm	330mm	510x265x140	9.15	1	42	107,00€
53896	130mm	645mm	840x265x140	11.60	1	28	127,00€
53897	130mm	1045mm	1220x265x140	13.85	1	21	140,00€
53898	130mm	1320mm	1520x265x140	15.65	1	21	148,00€



ZUBEHÖR

REF.	BESCHREIBUNG				€
15093	RADSTÜTZENHALTER	3.65	1	50	38,00€
15094	WAGENHEBERSTÜTZE	1.35	5	140	39,50€
15095	GRIFFVERRIEGELUNG	0.10	50	-	13,00€
15096	VORRICHTUNG ZUM HEBEN AM RAD	2.00	10	560	40,00€



54001

285,00€



TELESKOPISCHER HYDRAULIKHEBER 0,5T

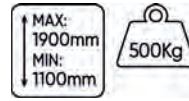

- SAE 40 Öl.
- Pedal für einfachen und schnellen Gebrauch.
- Robuste Konstruktion und hochwertiges Hydrauliksystem.



ERSATZTEILE VERFÜGBAR



50830

560,00€

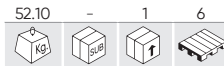

DOPPELHUB GETRIEBEHEBER



- Mit Griff.
- Schnelle Einstellung.
- Doppelkolben.



ERSATZTEILE VERFÜGBAR

UNTERSTELLBOCK SET

REF.	BESCHREIBUNG					€
53779	3T 290-430mm	5.05	-	1	72	36,00€
53845	6T 370-610mm	9.35	-	1	30	64,00€
54143	12T 500-770mm	35.50	-	1	12	249,00€



SATZ MIT 2 WAGENHEBERN 10 TONNEN

REF.	BESCHREIBUNG					€
54145	10T 482-775mm	37.90	-	1	4	377,00€
54146	10T 736-1212mm	2.00	-	1	4	492,00€



54147

198,00€



HEBEBÜHNE 1,8 TONNEN (1220-2146 MM)



54144

298,00€



SATZ MIT 2 WAGENHEBERN 22 TONNEN (338-500 MM)



53200

69,00€

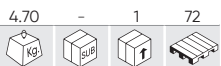

ALU-UNTERSTELLBOCK SET 3T - 2 TEILE

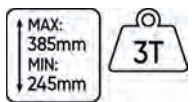

53218

26,00€

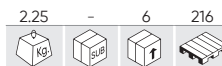

SCHEREN-WAGENHEBER



51901

999,00€

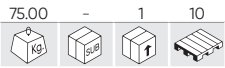

MONTAGEWAGEN HYDRAULISCH - REIFEN



- Länge: 1040 mm
- Breite: 1090 mm
- Höhe: 890 mm
- Hebebereich: 50-100 mm
- Maximaler Raddurchmesser: 1320 mm

LASTWAGENSPEZIAL



52241

1.690,00€



MONTAGEWAGEN FÜR TRAKTORRÄDER HYDRAULISCH



- Kapazität: 1,5 T
- Hebebereich: 0-770 mm
- Gesamtlänge: 1270 mm
- Gesamtbreite: 990 mm
- Gesamthöhe: 1340 mm
- Der maximale Raddurchmesser: 2200 mm (86")
- Der minimale Raddurchmesser: 1000 mm (39")
- Die maximale Radbreite: 800 mm



54257

318,00€

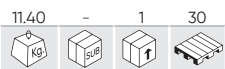

HYDRAULISCHE HANDPUMPE

10000 PSI
3/8" NPT

ARBEITSDRUCK:

- Stufe 1: 0 - 20 kg/ cm³
- Stufe 2: 20 - 700 kg/ cm³

1,8m

DURCHFLUSS:

- Stufe 1: 13 cc
- Stufe 2: 2,3 cc



50835

290,00€

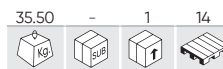

HYDRAULISCHER ROHRBIEGER



- Luftdruck: 0,75 - 0,75 mpa.
- Zum Biegen von Röhren 2" (50 mm).
- Abmessungen: 1/2", 3/4", 1", 1-1/4", 1-1/2", 2".
- Wird für die Installation und Herstellung von Röhren verwendet.

53880

598,00€

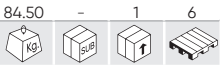

HUBWAGEN

- Tragfähigkeit: 2500kg
- Länge der Stoßvorrichtung: 1150mm
- Griff: Quadratisch, gummiert
- (Schwenkbares) Lenkrad: PU(200x50mm)
- Nichtschwenkbares Rad: Gedoppelt, PU (80x70 mm)
- Die minimale Gabelhöhe: 85mm
- Die maximale Gabelhöhe: 200mm
- Pumpenkolbenspielzahl: 8

SCHNELL HUBSYSTEM
(GUSSEISEN)



ERSATZTEILE
VERFÜGBAR

54396

2.250,00€

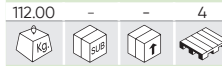

N

ELEKTRO-GABELHUBWAGEN



ERSATZTEILE
VERFÜGBAR



TECHNISCHE
INFORMATIONEN

50839

180,00€

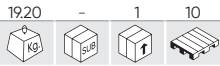

RANGIERHEBER TRAGFÄHIGKEIT 680 KG



ERSATZTEILE
VERFÜGBAR



50923

454,00€

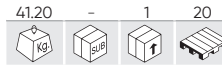

SPEZIELLER TRANSPORTWAGEN FÜR
KAROSSEARBEITEN - FLACH



ERSATZTEILE
VERFÜGBAR

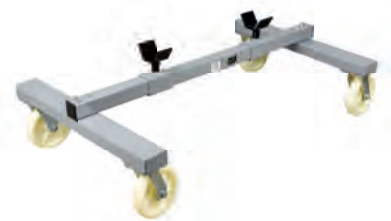

52514

84,00€

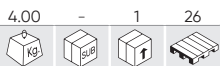

MOTORRAD VORDERRADSTÄNDER



ERSATZTEILE
VERFÜGBAR



51751

99,00€



MOTORRAD HECKSTÄNDER



ERSATZTEILE
VERFÜGBAR



53684

1.880,00€

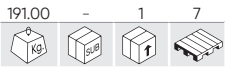

30T HYDRAULIC-PRESSE

- Ladekapazität (T): 30.
- Hub (mm): 160.
- Arbeitsbereich (mm): 166-1126.
- Bettbreite (mm): 540.
- Seitenhub (mm): 200.
- Stroke: 150mm.



53590

1.190,00€

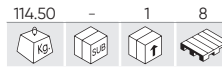

20T HYDRAULIK-PRESSE

- Ladekapazität (T): 20.
- Hub (mm): 145.
- Arbeitsbereich (mm): 58-1018.
- Bettbreite (mm): 540.
- Seitenhub (mm): 180.
- Stroke: 142mm.



ERSATZTEILE VERFÜGBAR



ERSATZTEILE VERFÜGBAR

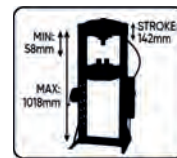

REF. BESCHREIBUNG

14616 GITTERSCHUTZ FÜR HYDRAULISCHE PRESSE 20T/30T FÜR REF. 53590/53684



6.30 - 1 - 96,00€



52999

178,00€

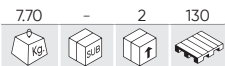

UNTERLAGE FÜR WERKSTATT-PRESSE

GROSSER BLOCK



KLEINER BLOCK



50827

387,00€

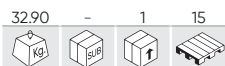

STAND-FEDERSPANNER FÜR STOSSDÄMPFER

- Fassungsvermögen: 1T (2200 lbs)
- Durchmesser der komprimierten Feder: 200mm
- Komprimierte Länge: 200-500mm



50831

460,00€

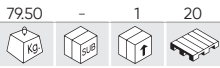

WERKSTATTKRAN - ZUSAMMENKLAPPBAR



ERSATZTEILE VERFÜGBAR

52985

598,00€

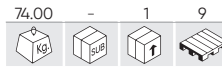

HYDRAULISCHER WERKSTATTKRAN 1T - ZUSAMMENKLAPPBAR



ERSATZTEILE VERFÜGBAR

50631

68,00€

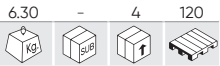

MOTOR-POSITIONIERER FÜR MOTORKRAN 750KG



50840

138,00€

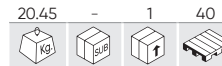

MOTORBRÜCKE 500KG (1750MM)



REF.	BESCHREIBUNG	3.43	1	50	€
51452	ERSATZAUFHÄNGUNG FÜR REF. 50840	-	-	-	69,00€

53682

98,00€

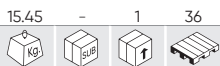

MOTORBRÜCKE - (1480MM)



52055

139,00€

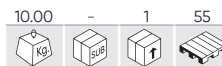

UNIVERSAL MOTOR-STÜTZTRAVERSEN-SATZ



50836 148,00€

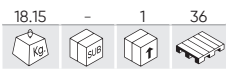

MOTORSTÄNDER 340KG



50838 299,00€

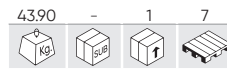

MOTORSTÄNDER 900KG



- Abmessungen gefaltet:
1000x500x440mm.



Manuelle Hebevorrichtung

54262 88,00€

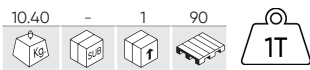

54263 130,00€

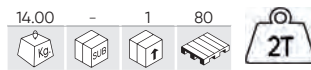

54264 240,00€

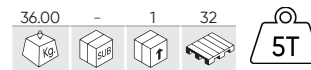

	54262	54263	54264
HUBHÖHE	2,8m	2,8m	2,8m
KETTENZUG	1	2	2
ABMESSUNGEN DER KETTE		Lastkette: 6x30mm Handkette: 4,5x25mm	
LÄNGE		Lastkette: 3m Handkette: 2,5m	
KRAFTAUFWAND BEI MAXIMALER LAST	304N	310N	361N
MATERIAL		Lastkette: Stahl 20Mn2 Handkette: Stahl Q235	



52845 170,00€

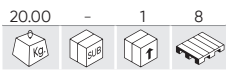

AUFFAHRRAMPEN SET - 2 TEILE (1 TONNE)

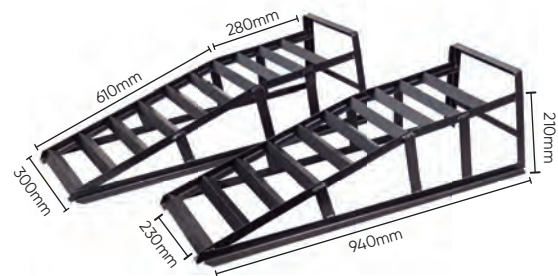

53423 199,00€

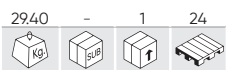

HYDRAULISCHER QUAD-HEBER

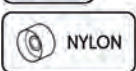

53969 96,00€

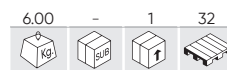

MOTORRADHEBER



54386

5.839,00€

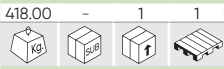

N

HYDRAULIKTISCH FÜR AUTOBATTERIEN

Dieses elektrische Scherenfahrzeug hat die Vorteile des freien Hebens, des flexiblen Laufens, der bequemen Bedienung, des schönen Stils und der Umweltfreundlichkeit. Es kann als temporäre Arbeitsbühne für den Warenumschlag in Werkstätten, Lagern, Güterbahnhöfen und anderen kleinen Standorten eingesetzt werden. Es ist ein ideales Werkzeug, um die Ermüdungsfestigkeit zu reduzieren, die Produktionseffizienz zu verbessern und ein sicheres Be- und Entladen zu realisieren.

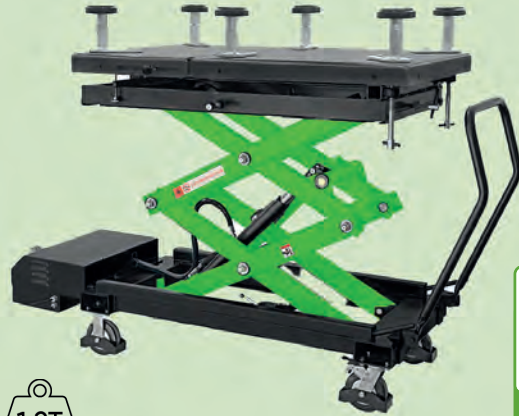

ERSATZTEILE VERFÜGBAR

Ladeeigenschaften	Verteilte Last
Hubzeit (ohne Last)	60"
Absenzeit (ohne Last)	45"
Plattform	1290 - 1400x768mm

MAX: 1840mm
MIN: 650mm



52692

129,00€

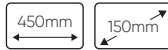
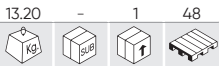

MOTORRAD SCHERENHEBER



50911

788,00€

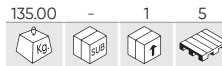

MOTORRAD HEBEBÜHNE



ERSATZTEILE VERFÜGBAR

53246

1.144,00€

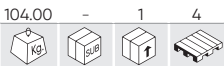

HYDRAULIK HUBTISCH 360KG



50630

590,00€

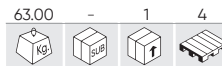

HYDRAULIK HUBTISCH 400KG



ERSATZTEILE VERFÜGBAR

GUMMI-HEBEKISSEN FÜR AUFZUG

<p>54349 8,00€</p> <p>0.48 - 68 -</p> <p>A 160mm B 120mm C 20mm</p>	<p>54350 12,50€</p> <p>0.67 - 48 -</p> <p>A 160mm B 120mm C 30mm</p>	<p>54351 14,00€</p> <p>0.97 - 32 -</p> <p>A 160mm B 120mm C 40mm</p>	<p>54352 18,00€</p> <p>1.43 - 20 -</p> <p>A 160mm B 120mm C 60mm</p>
<p>54353 23,50€</p> <p>1.85 4 12 -</p> <p>A 160mm B 120mm C 80mm</p>	<p>54354 34,50€</p> <p>2.91 - 8 270</p> <p>A 160mm B 120mm C 120mm</p>	<p>54483 14,00€</p> <p>0.70 - 40 -</p> <p>A 160mm B 120mm C 35mm</p>	<p>54484 26,00€</p> <p>1.75 - 20 -</p> <p>A 160mm B 120mm C 70mm</p>
<p>54485 36,00€</p> <p>2.40 - 8 -</p> <p>A 160mm B 120mm C 100mm</p>	<p>54355 12,00€</p> <p>0.20 - 60 -</p> <p>RAVAGLIOLI/SIRIO/SPACE A 123mm D 108mm B 26mm E 10mm C 104mm</p>	<p>54360 14,00€</p> <p>0.19 - 72 -</p> <p>RAVAGLIOLI/SIRIO/SPACE A 130mm D 125mm B 23mm E 10mm C 121mm</p>	<p>54486 9,50€</p> <p>0.10 - 120 -</p> <p>RAVAGLIOLI/SIRIO/SPACE A 100mm D 85mm B 22mm E 8,5mm C 81mm</p>
<p>54488 15,00€</p> <p>0.25 - 40 -</p> <p>RAVAGLIOLI A 150mm D 135mm B 25mm E 10mm C 128mm</p>	<p>54493 13,50€</p> <p>0.20 - 60 -</p> <p>RAVAGLIOLI A 120mm B 110mm C 27mm</p>	<p>54494 14,00€</p> <p>0.30 - 48 1152</p> <p>RAVAGLIOLI A 145mm B 135mm C 26mm</p>	<p>54357 15,00€</p> <p>0.29 - 60 -</p> <p>TWIN BUSCH A 120mm D 105mm B 30mm E 8,5mm C 100mm F 66mm</p>
<p>54358 18,50€</p> <p>0.36 - 44 -</p> <p>TWIN BUSCH A 140mm D 125mm B 25mm E 10mm C 116mm F 66mm</p>	<p>54361 14,00€</p> <p>0.25 - 52 -</p> <p>TWIN BUSCH A 140mm D 125mm B 28mm E 8mm C 120mm</p>	<p>54363 14,00€</p> <p>0.30 - 44 -</p> <p>ISTOBAL/VELYEN A 155mm D 147mm B 24mm E 6mm C 140mm</p>	<p>54365 12,50€</p> <p>0.20 - 108 -</p> <p>ISTOBAL/VELYEN A 145mm B 10mm C 60mm</p>

GUMMI-HEBEKISSEN FÜR AUFZUG

54359 14,00€

0.31 - 48 1440

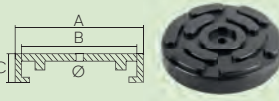

OMCN

A 140mm
B 133mm
C 27mm

54491 17,50€

0.30 - 44 -

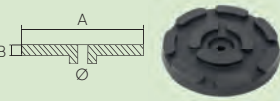

OMCN

A 145mm
B 25mm

54366 18,50€

0.30 - 80 -



NASSBAUM/AMI

A 125mm D 120mm
B 24mm
C 90mm

54362 14,00€

0.25 - 48 -

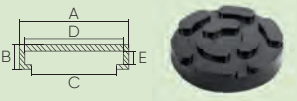

CASCOS

A 138mm D 130mm
B 25mm E 9mm
C 120mm

54487 15,00€

0.15 - 80 -

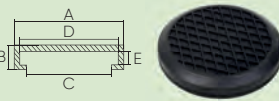

ROTARY

A 123mm D 112mm
B 22mm E 8mm
C 90,5mm

54495 18,00€

0.25 - 108 3240

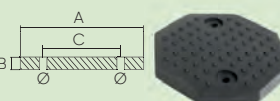

ROTARY

A 125mm
B 15mm
C 90mm

54496 16,50€

0.10 - 400 2400

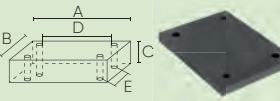

ROTARY

A 104mm D 80mm
B 82mm E 56mm
C 8mm

54497 12,50€

0.15 - 88 2700

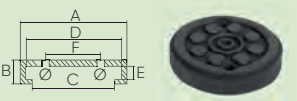

MAHA

A 120mm D 113mm
B 22mm E 8mm
C 102mm F 83mm

54492 19,50€

0.35 - 60 -

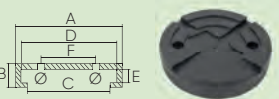

SLIFT/IME

A 125mm D 110mm
B 25mm E 9mm
C 120mm F 83mm

54356 19,50€

0.44 - 48 1152



500E/500X/JEEP RENEGADE

A 55mm
B 100mm

54364 14,00€

0.29 - 52 -

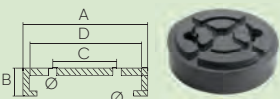

LAUNCH/TWIN BUSCH/RP TOOLS

A 120mm D 108mm
B 32mm
C 70mm

54489 19,50€

0.35 - 28 -

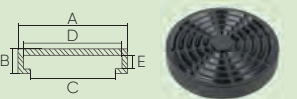

KONI/ROMERICO/CAR-O-LINER

A 160mm D 153mm
B 29mm E 10mm
C 140mm

54490 15,00€

0.20 - 88 -

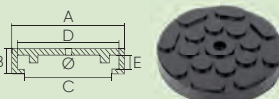

ATH/HOFMANN/
HERMANN/J.A.B. BECKER

A 120mm D 110mm
B 19mm E 4mm
C 130mm

54175

0.80 5 20 360



4-TEILIGER SATZ TESLA
HEBEPADS

NR TESLA 3/X/S/Y

34,00€



ELEKTROWERKZEUGE

- 328 BOOSTER
- 329 BATTERIEWARTUNG
- 330 STROMMESSUNG
- 332 SICHTPRÜFUNG
- 332 SCHWEISSEN
- 334 WERKSTATT AUSRÜSTUNG
- 337 KLIMATISIERUNG
- 338 THERMOMETER
- 338 SONSTIGES



STARTERKABELSATZ

SOLIDEN MESSINGKLAMMERN

REF.	Ø KABEL	LARGE	A	QUER-SCHNITT					€
51238	17mm	5m	700	70mm ²	4,95	-	2	84	138,00€
51239	15mm	7m	700	70mm ²	5,90	-	2	72	159,00€

MESSINGKLAMMERN

REF.	Ø KABEL	LARGE	A	QUER-SCHNITT					€
52069	11mm	2,5m	250	25mm ²	1,55	-	10	240	29,50€
52070	12mm	3m	350	35mm ²	1,95	-	5	160	40,00€
52071	13mm	3m	500	50mm ²	2,35	-	5	90	47,00€

SOLIDEN MESSINGKLAMMERN MIT ÜBERLASTSICHERUNG

REF.	Ø KABEL	LARGE	A	QUER-SCHNITT					€
51363	12mm	3m	350	35mm ²	2,63	-	5	120	114,00€
51365	12mm	3m	600	50mm ²	3,10	-	5	90	118,00€



REF. BESCHREIBUNG

REF.	BESCHREIBUNG					€
14145	KUPFERKLEMME FÜR STARTERKABEL - ROT	0,20	-	30	-	8,50€
14146	KUPFERKLEMME FÜR STARTERKABEL - SCHWARZ	0,20	-	30	1920	8,00€
14147	MESSINGKLEMME FÜR STARTERKABEL - ROT	0,35	-	15	-	25,00€
14148	MESSINGKLEMME FÜR STARTERKABEL - SCHWARZ	0,35	-	15	-	25,00€

53687

298,00€

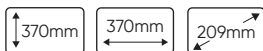
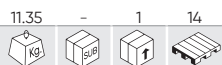

AUTOBATTERIE START- /LADEGERÄT 12V

- Spannung: 12V.
- Batterie: 22Ah, Blei-Säure-Batterie (1 Stck.)
- Einschaltstrom: 750A.
- Spitzenstrom: 1500A.

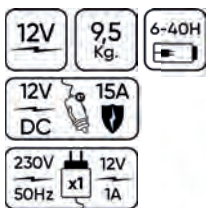

ERSATZTEILE VERFÜGBAR

- A ANZEIGE DER INTERNEN BATTERIESPANNUNG
- B PRÜFTASTE ZUR PRÜFUNG DER INTERNEN BATTERIE-SPANNUNG
- C SCHALTER (ON/OFF)
- D LED-NOTFALL-LAMPE

53688

495,00€



AUTOBATTERIE START- /LADEGERÄT 12/24V

- Spannung: 12V/24V.
- Batterie: 22 A*4, Blei-Säure-Batterie AGM (2 St.).
- Einschaltstrom: 12V: 1500A/3000A.
- Spitzenstrom: 24V: 750A/1500A.
- Ladezeit der Batterie: Vollladung: 40 Stunden
- Ladung 10-20 %: 6 Stunden

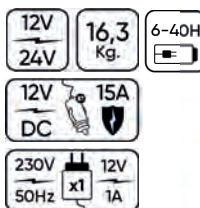

ERSATZTEILE VERFÜGBAR

- A ANZEIGE DER INTERNEN BATTERIESPANNUNG
- B PRÜFTASTE ZUR PRÜFUNG DER INTERNEN BATTERIE-SPANNUNG
- C SCHALTER (ON/OFF)
- D LED-NOTFALL-LAMPE

51816 58,00€



DIGITALER TESTER FÜR AUTO BATTERIEN

- 150Ah.
- Für Akkumulatoren 12V.
- Messung nach SAE (CCA), EN, IEC, DIN, CA.
- Bereich: 200~1 200 CAA (SAE).
- Meßspannung: 7V~15 V.
- Display 4 + 3 Leuchtdioden (grün, rot, gelb).



51235 49,00€



BATTERIE-TESTER ANALOG

- Für Akkumulatoren 6V und 12V.
- Kapazität bis 100AH.
- Kontrolle des Ladungszustandes.
- Verbrauchskontrolle beim Start.
- Kontrolle der Ladungsspannung.
- Zustandkontrolle der Akkumulatorenatterie.



52884 73,00€



VERSORGUNGSSTROMERHALT WÄHREND BATTERIE WECHSEL



- Ist für die Unterhaltung des Stroms im System des Fahrzeuges während der Ladung der KFZ-batterie bestimmt.
- Anschluss über OBDII-Anschluss mit Klemmen oder Zigarettenanzünder.



53209 8,50€



AKKU-HYDROMETER

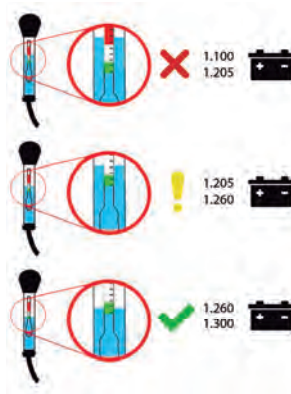

LADEGERÄT FÜR BATTERIEN

Kompatibilität mit Blei-Säure-Batterien: Flüssigkeits-, Gel-, MF- und AGM- Batterien

53927 66,00€

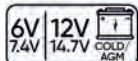

53929 95,00€



52233

328,00€

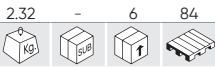

DIGITALER TESTER FÜR AUTOBATTERIEN MIT DRUCKER

- Für Akkumulatoren 6 V und 12 V.
- Ladung und Betrieb mit Systeme 12V und 24V.
- Arbeitsbereich: 40 - 2000 CCA (SAE).
- Meßspannung: 1,5-30 V.
- Kabelsatz 180 cm.
- Lieferumfang: 1 Rolle Thermopapier.



54040

240,00€

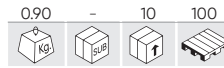

TESTGERÄT MIT DRUCKFUNKTION

- Anwendbar auf 12 V Batterien, AGM (absorbierende Glasmatte), GEL (Gel), VRLA (versiegelte Bleigelakku), SLI (mit flüssigem Elektrolyt).
- Betriebsbereich: 100-2 000 Kaltstartstrom CCA (SAE)
- Vorhandene Systemsprachen:
 - Deutsch (DE)
 - Spanisch (ES)
 - Englisch (EN)
 - Französisch (FR)
 - Italienisch (IT)
 - Portugiesisch (PT)
 - Rumänisch (RO)
- Anwendbar auf Startsysteme 12/24 V.
- Prüfgerät für Anlasser und Generatoren.
- Eine CR2032-Batterie ist im Lieferumfang enthalten



REF.	BESCHREIBUNG	0.10	6	72	€
51842	THERMOPAPIER 57MM X 60M				6,90€

54256

48,00€



AUTOMATISCHER ÜBERSPANNUNGSSCHUTZ 12/24V

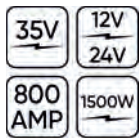

52231

49,00€

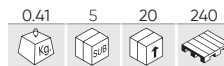

ZUBEHÖR-SET FÜR MULTIMETER

- Geeignet für die Mehrheit von Multimetern.

- LIEFERUMFANG**
- 2 Taster.
 - 2 kleine Klammern.
 - 2 große Klammern.
 - Verlängerungen.



54114

248,00€

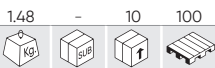

ISOLATIONSWIDERSTANDSMESSGERÄT



Installationskategorie:	2	Betriebstemperatur:	00C - 40 0C (320F - 104 0F), relative Luftfeuchtigkeit unter 80 %
Messkategorie:	CAT III	Lagertemperatur:	-10 0C - 60 0C (140F - 140 0F), relative Luftfeuchtigkeit unter 70 %
Höhenmessung:	Bis zu 2000 Meter	Stromquelle:	DC 9 V (6x1,5 V Größe "AA" Batterien)
Display	LCD mit Doppelanzeige	Abmessungen (Länge x Breite x Höhe):	200 x 92 x 50 mm
Spannung AC:	0 - 750 V		
Spannung DC:	0 - 1000 V		
Widerstand:	0 - 200 Ω / 200 - 2000 Ω		
Isolationswiderstand:	0 - 200 MΩ / 200 - 2000 MΩ		
Abtastrate:	2,5 Mal pro Sekunde		
Nullabgleich:	Automatische Einstellung		



50942

28,00€

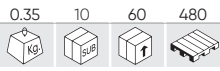

DIGITALES MULTIMETER

- Stellen: 3 1/2.
- Messung: 2000.
- Veränderliche Daten.
- Automatisches Abschalten.



AC	AC
200mV, 2V, 20V, 200V, 1000V	20mA, 200mA, 20A
DC	DC
200mV, 2V, 20V, 200V, 750V	20mA, 200mA, 20A
Ω	F
200Ω, 2KΩ, 20KΩ, 200KΩ, 2MΩ, 20MΩ, 2000MΩ	2nF, 20nF, 200nF, 2μF, 20μF, 200μF

52439

227,00€

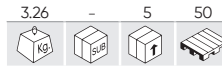

KABELSATZ UND ACC. FÜR MULTIMETER

- 2 einstellbare Ohmmeter.
- 2 LED-Prüfstift.
- 2 austauschbare SRS-Einsätze.
- 2 Flachzange-Krokodilklemmen.
- 2 selbstfixierende Einsätze.
- 4 Taster.
- 24 runde Anschlüsse.
- 48 flache Anschlüsse.



52382

19,50€

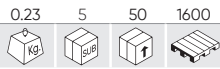

ZANGENSTROMMESSER

- AC/DC - Spannung, elektrischer Widerstand, die Diodenprüfung usw.
- Betriebsbedingungen: 0°C - 40°C, rel. Feuchte. <80 %.
- Lagerbedingungen: -10°C - 40°C, rel. Feuchte. <85 %.
- 2 AAA-Batterien.
- Anzeiger der niedrigen Batterieladung.
- Bildschirm 3,5" 4-Stellig.
- Funktion DC.
- Vermesser AC/DC.



DCB	600V
ACB	600V
DCA	-
ACA	20A, 200A, 600A
OHM	2KΩ, 200KΩ, 2MΩ

- FUNKTIONEN:
Prüfung unter Spannung.

52952

74,00€

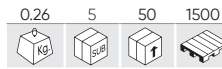

PROFI ZANGENSTROMMESSER

- AC/DC - Spannung, elektrischer Widerstand, die Diodenprüfung usw.
- Betriebsbedingungen: 0°C - 40°C, rel. Feuchte. <80 %.
- Lagerbedingungen: -10°C - 40°C, rel. Feuchte. <85 %.
- 2 AAA-Batterien.
- Anzeiger der niedrigen Batterieladung.
- Bildschirm 3,5" 4-Stellig.
- Funktion DC.
- Vermesser AC/DC.



DCB	20V, 600V
ACB	600V
DCA	200A
ACA	200A
OHM	2000Ω

- FUNKTIONEN:
Prüfung unter Spannung.
Diodenprüfung.
Abbruchprüfung.
ADP-Funktion.
Phasensuchfunktion.
Reset-Taste.

53028

5,80€

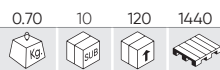

KFZ-SPANNUNGSPRÜFER - 1,8X190MM

6-12-24V
1,8 x 190mm



- Geeignet für Polungsprüfung.

53029

6,80€

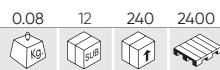

KFZ-PANNUNGSPRÜFER - 2X115MM

6-12-24V
2 x 115mm



53030

12,00€

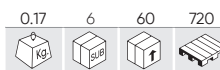

KFZ-SPANNUNGSPRÜFER - 3X142MM

6-12-24V
3 x 142mm
LED



53724

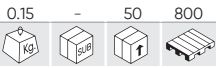

46,00€

WIFI ENDOSKOP

- Endoskop mit Wifi-Bildübertragungsfunktion. Anschlussmöglichkeit zu jedem Smartphone. Unterstützung für die Arbeit mit einem Tablet oder einem Computer.

- Die Lieferung erfolgt mit:
Endoskopische Kamera.
Wi-Fi-Sender.
Hakenansatz.
Magnetansatz.
Seitensichtspiegelansatz.

1 METER HALBSTARRES KABEL



Funktioniert mit der JBM APP:



53484

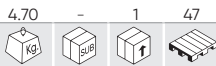

615,00€

RAUCH LECK-DETEKTOR

- ÖL IST NICHT IM LIEFERUMFANG ENTHALTEN.

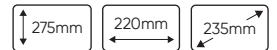

ENTHALTEN



53977

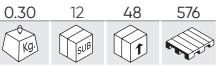

17,50€



LÖTKOLBEN 40 W

- Arbeitsbeanspruchung 220-240 V
- 40 W
- Frequenz: 50Hz
- Länge: 240 mm
- Kabel: 1,3 m
- Max. Arbeitstemperatur: 450°+/-10%



53111

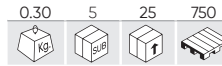

19,00€



LÖTKOLBEN 100 W

- Spannung: 220-240V.
- Temperatur: 420°C +/- 10%.
- Länge: 250mm.
- Kabel: 1,5m.



53145

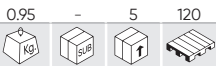

39,20€

HEISSLUFTPISTOLE 2000W

- 220V-240V.
- 50Hz-60HZ.
- 2000W.
- Ausgangstemperatur: 50-600 °C.
- Luftstrom: 220-480 l / min.
- 2 Temperaturmodi: 300 und 600°C.



53162

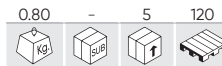

60,00€

DIGITAL HEISSLUFTPISTOLE 2000W

- 220V-240V.
- 50Hz-60HZ.
- 2000W.
- Ausgangstemperatur: 100-600°C.
- Luftstrom: 280-480L/min.



53981

143,00€

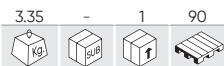

DC INVERTER MMA WELDER 100A

ENTHALTEN

Elektrodenhalter mit 2m Kabel.
Erdungsklemme mit 1,5m Kabel.
Hammerbürste.
Manueller Gesichtsschutz.



- ✓ INVERTER MIT IGBT-TECHNOLOGIE
- ✓ DC- HANDLICHT-BOGENSCHWEISSEN
- ✓ BRENNSCHUTZ
- ✓ BOGENLEISTUNG
- ✓ LICHTBOGENZÜNDUNG



53982

219,00€

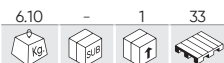

DC INVERTER MMA WELDER 160A

ENTHALTEN

Elektrodenhalter mit 2m Kabel.
Erdungsklemme mit 1,5m Kabel.
Hammerbürste.
Manueller Gesichtsschutz.



- ✓ INVERTER MIT IGBT-TECHNOLOGIE
- ✓ DC- HANDLICHT-BOGENSCHWEISSEN
- ✓ BRENNSCHUTZ
- ✓ BOGENLEISTUNG
- ✓ LICHTBOGENZÜNDUNG



53414

49,00€



SCHWEISSMASKE MIT MANUELLEM REGLER



ANALOGREGLER ZUR EINSTELLUNG DER SENSIBILITÄT UND VERDUNKELUNG

53415

188,00€



SCHWEISSMASKE MIT DIGITALER REGLER



DIGITALE REGULUNGSVORRICHTUNG ZUR EINSTELLUNG VON EMPFINDLICHKEIT, DIMMUNG UND TAKTSIGNAL

MAGNETVIERKANT 45°, 90°, 135°

REF.	↔	📦	📦	📦	📦	€
54111	75mm	0.35	10	40	1680	4,75€
54113	100mm	0.60	10	20	1100	7,65€



54482

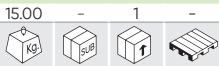

677,00€

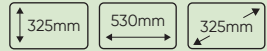

N

ULTRASCHALLREINIGER 30L

Mit diesem Gerät können Sie Teile durch die Aussendung von Ultraschall reinigen. Sie ist besonders für die Reinigung von Teilen mit komplexen Formen geeignet.



ULTRASCHALLLEISTUNG: 600W	STROMVERSORUNG: 200~240V (50HZ)
HEIZLEISTUNG: 500W	ANZAHL DER TRANSDUKTOREN: 10
TANKKAPAZITÄT: 30L	HEIZUNG: 0~80°C
ULTRASCHALLFREQUENZ: 40KHZ	MATERIAL: EDELSTAHL SUS304
TIMER: 1~30 MIN.	TANKABMESSUNGEN: 500x300x200mm

53220

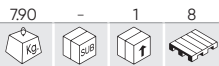

260,00€

TRANSPORTABLER TEILEWASCHGERÄT

- Tragbar.
- Es bietet Dichtheit während des Transports, um Verluste zu vermeiden.
- Trennung von Arbeitszonen, Reinigungszone und Trocknungszone, um gleichzeitig mit mehreren Elementen arbeiten zu können.
- Es wird mit einem wasserbasierten Lösungsmittel verwendet.
- Zündschalter an der Seite.
- Komplett mit Flüssigreinigungsfilter.
- Werkzeug mit einem Schlauch.
- Ablagefach.
- Max. Volumen 27,5 L.
- Pumpenkapazität: 1000 L / h.
- Arbeitsvolumen: 20 Liter.
- Verbindung zum 220 V-Netzwerk.
- Schlauchlänge von 1,10 m.



SCHLEIFBOCK

REF.	W	V/W	RPM	HZ	Ø I	Ø II	Ø III	Icon 1	Icon 2	Icon 3	Icon 4	€
53656	450W	230V/450W	2950RPM	50Hz	ø 150mm	ø 20mm	ø 12,7mm	11.05	-	1	50	198,00€
53657	600W	230V/600W	2950RPM	50Hz	ø 200mm	ø 25mm	ø 15,88mm	16.35	-	1	24	248,00€
53658	250W	230V/250W	2950RPM	50Hz	ø 150mm	ø 20mm	ø 12,7mm	6.95	-	1	60	99,00€
53659	250W	230V/250W	2950RPM	50Hz	ø 150mm ø 200mm	ø 20mm ø 40mm	ø 12,7mm ø 20mm	9.70	-	1	15	121,00€



53656
53657



53658



53659

52195

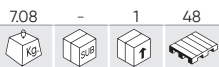

170,00€

SCHLEIFBOCK 150 MM

- Leistung 250 W.
- Spannung 230 V / 50 Hz.
- Drehzahl ohne Last 2950 U/min.
- Scheibenabmessungen 150x20x12,7 mm.



53660

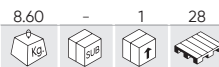

146,00€

STAHLFUSS FÜR SCHLEIFBOCK

- Höhe: 790mm.
- Abmessungen der Befestigungsplatte: 250x280mm.



54342 858,00€ N

49.50 - 1 4

TEILEREINIGUNGSMASCHINE MIT THERMOSTAT

70-120 PSI 0,8 L/min
 MAX 50°C 8-14L
 5 CFM 740mm 560mm 452mm



1710mm
790mm
610mm

Die Maschine ist für das perfekte Waschen verschmutzter Teile konzipiert. Es enthält eine pneumatische Pistole zum Reinigen mit Lösungsmittel und kann auch zum Trocknen der Teile mit Druckluft verwendet werden. Dank der geschlossenen Kabine ist der Bediener vollständig vor Spritzern und Gerüchen des Lösungsmittels geschützt. Es verfügt über einen Thermostat, mit dem Sie das Temperaturniveau der Reinigungsflüssigkeit und des Lichts im Tank regulieren können, um eine bessere Sicht zu gewährleisten.

ERSATZTEILE VERFÜGBAR

54341 643,00€ N

51.00 - 1 7

SANDSTRAHLER 220L

100V 40-120 PSI
240V
15-25 PSI 33L
860mm 560mm 560mm



390mm
905mm
632mm

Diese Sandstrahlmaschine ist einfach zu bedienen, tragbar und bietet eine sichere Umgebung, bereit für den Einsatz mit dem Strahlmittel Ihrer Wahl mit der Fähigkeit, verrostete Teile, Flecken usw. zu reinigen.

ERSATZTEILE VERFÜGBAR

52980 480,00€ 150L

45.00 - 1 4

TEILEWASCHGERÄT - 150L

GESAMTMASS MASCHINE 890mm 1.090mm 520mm
INNENMASSE TANK 270mm 1.060mm 490mm



ERSATZTEILE VERFÜGBAR

50632 298,00€ 100L

24.20 - 1 6

TEILEWASCHGERÄT - 100L

GESAMTMASS MASCHINE 890mm 780mm 540mm
INNENMASSE TANK 260mm 725mm 490mm



ERSATZTEILE VERFÜGBAR

- Volumen: 25 L.
 - Das Gerät ist für die Arbeit mit wasserlöslichen Waschölen geeignet.

- Volumen: 25 L.
 - Das Gerät ist für die Arbeit mit wasserlöslichen Waschölen geeignet.

51837

195,00€

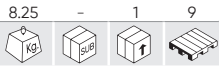

INDUSTRIE-STAUBSAUGER 30L - TROCKEN

30L

Volumen (l)	30
Ansaugvolumen pro sekunde (l/s)	26
Leistung	1x1.200W
Spannung	230V
Frequenz	50Hz
Absaugung	> 17Kpa
Schlauchdurchmesser	32mm
Schlauchlänge	1,5m
Kabellänge	4,5m
Dichtung	IPx4



ERSATZTEILE VERFÜGBAR

ENTHALTEN



* Dieser Staubsauger verfügt über ein System, das ein automatisches Einschalten ermöglicht, wenn er an eine Schleifmaschine angeschlossen ist.

51838

667,00€

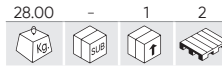

INDUSTRIE STAUBSAUGER 80L - TROCKEN/ NASS

80L

Volumen (l)	80
Ansaugvolumen pro sekunde (l/s)	50
Leistung	3x1.000W
Spannung	230V
Frequenz	50Hz
Absaugung	> 20Kpa
Schlauchdurchmesser	48mm
Schlauchlänge	2m
Kabellänge	4,5m
Dichtung	IPx4



ERSATZTEILE VERFÜGBAR

ENTHALTEN



53947

145,00€

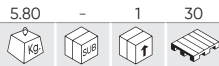

WASSERSTRAHL HOCHDRUCKREINIGUNG 1400 W

230V	1400W	MAX 105 Bar	MAX AQUA WASSER 50°C	5,0Kg
MAX 6,8L/min	5m	3m	50 Hz	IP X5

ENTHALTEN



ERSATZTEILE VERFÜGBAR

- A SPRITZPISTOLE
- B NETZKABEL
- C WASSERAUSLAUF
- D HOCHDRUCKSCHLAUCH

53948

324,00€

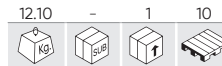

WASSERSTRAHL HOCHDRUCKREINIGUNG 2400 W

230V	2400W	MAX 180 Bar	MAX AQUA WASSER 50°C	10,0Kg
MAX 8L/min	5m	8m	50 Hz	IP X5

ENTHALTEN



ERSATZTEILE VERFÜGBAR

- A HOCHDRUCKSCHLAUCH
- B SPRITZPISTOLE
- C WASSERAUSLAUF
- D NETZKABEL

53189 128,00€

7.10 - 1 12

1325mm 480mm Ø565mm

STANDVENTILATOR

230V 50 Hz
120V

X3 SPEED RPM 1050/1150/1300 CFM 2700/3000/3400



54125 152,00€

8.25 - 1 14

1250mm 400mm Ø430mm

WASSERSPRÜHVENTILATOR

3,2L 75W
220V 50 Hz
240V
0.5-7.5H motor de cobre/ copper engine
mando/remote

QR code and text: ERSATZTEILE VERFÜGBAR



53543 13,80€

0.75 5 20 160

KFZ-VENTILATOR 12 V

Icons for car, bus, truck, and fan. 12V 15,20cm

GESCHWINDIGKEIT X2



53190 98,00€

6.10 - 1 16

575mm 230mm Ø620mm

TISCHVENTILATOR

230V 50 Hz
120V
X3 SPEED RPM 1050/1150/1300 CFM 2700/3000/3400



54229 48,00€

1.76 - 4 80

2 KW HEIZUNG

2Kw 220V 240V 1000-3000 RPM 20m²
SPCC PTC 197m³/h 210-160 -217mm



54229
54230

54230 68,00€

3.10 - 1 56

3 KW HEIZUNG

3Kw 220V 240V 1000-3000 RPM 30m²
SPCC PTC 197m³/h 210-160 -217mm

54231 138,00€

4.80 - 1 27

5 KW HEIZUNG

5Kw 380V 400V 1000-3000 RPM 48m²
SPCC PTC 588m³/h 300-235 -345mm
1,4m

54231
54232

54232 248,00€

7.90 - 1 12

9 KW HEIZUNG

9Kw 380V 400V 1000-3000 RPM 80m²
SPCC PTC 1180m³/h 395-307 -455mm
1,4m



52162 38,00€

0,17 6 72 576

145mm 90mm 37mm

LASERTHERMOMETER -50°C BIS +550°C



52450 105,00€

0,72 5 20 200

175mm 105mm 48mm

LASERTHERMOMETER -50°C BIS +1000°C



53503

0,05 20 100 2400

KONTAKT-DIGITALTHERMOMETER



12,00€

1.5V x1 BATTERY INCLUDED

-50°C to +330°C
-58°F to +572°F
±1°C (0.2°F)
(-20°C to 60°C)

53585 168,00€

8,35 - 2 36

KABEL-AUFROLLER 21M - BLAU



53586 168,00€

8,35 - 2 30

KABEL-AUFROLLER 21M - GRÜN



REF.	BESCHREIBUNG	KG	CB	CB	CB	€
14771	WANDHALTERUNG FÜR REF. 53532, 53581, 53585, 53586	0,35	-	30	-	10,50€

53584 119,00€

5,10 - 4 48

KABEL-AUFROLLER 12M - GRÜN



53526 119,00€

5,15 - 4 48

KABEL-AUFROLLER 12M - BLAU



REF.	BESCHREIBUNG	KG	CB	CB	CB	€
14774	WANDHALTERUNG FÜR REF. 53526, 53584	0,40	-	10	-	10,50€

51831 24,00€

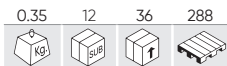

HEISSKLEBE-PISTOLE

- Spannung: 100-230 V.
- Temperatur: 190-230°C.
- Leistungsaufnahme: 60-150 W.
- Düsendurchmesser: 2,0-2,3 mm.
- Zuführung: 8-16 g Stoff/min.



REF.	BESCHREIBUNG					€
51859	BLASE 10U - KLEBEPATRONEN	0.12	8	32	1520	3,80€

51033 98,00€



KABELTROMMEL - 25M



- Überlastschutz.
- Kindersicherung.



KABELVERLÄNGERUNG

REF.	m					€
53166	3m	0.45	5	30	600	10,50€
53167	5m	0.65	5	20	600	12,50€
53168	10m	1.20	-	10	300	19,00€



52643 596,00€



REIFEN PROFILSCHNIEDER

DIGITAL EINSTELLBAR

REF.	BESCHREIBUNG				€
11974	R1-ERSATZ FÜR REF. 52643	0.01	20	500	1,80€
11975	R2-ERSATZ FÜR REF. 52643	0.01	20	500	1,80€
11976	R3-ERSATZ FÜR REF. 52643	0.01	20	500	1,80€
11977	R4-ERSATZ FÜR REF. 52643	0.01	20	500	1,80€
11978	R5-ERSATZ FÜR REF. 52643	0.04	20	100	1,80€
11979	W1-ERSATZ FÜR REF. 52643	0.04	20	500	1,80€
11980	W2-ERSATZ FÜR REF. 52643	0.04	20	500	1,80€
11981	W3-ERSATZ FÜR REF. 52643	0.01	20	500	1,80€
11982	W4-ERSATZ FÜR REF. 52643	0.01	20	200	1,80€
11983	W5-ERSATZ FÜR REF. 52643	0.04	20	500	1,80€



ERSATZTEILE

REF.	11974	11975	11976	11977	11978
MESSER VOM TYP	R1	R2	R3	R4	R5
ABGERUNDEDE MESSER	mm	mm	mm	mm	mm
	A 3	5	6	8	10
	B 7	7	10	12	12
	C 5	8	15	16	18
	D 21	21	23	25	24

REF.	11979	11980	11981	11982	11983
MESSER VOM TYP	W1	W2	W3	W4	W5
QUADRAT-MESSER	mm	mm	mm	mm	mm
	A 3	5	7	9	11
	B 7	7	10	12	12
	C 5	6	10	13	15
	D 21	21	22	24	23

52598

1.080,00€

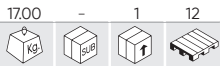

RASENMÄHER-ROBOTER



Moderner und funktioneller Rasenmäherroboter, perfekt für die Pflege und Instandhaltung Ihres Rasens und Ihrer Grünflächen. Er ist mit einem bürstenlosen Motor ausgestattet, der von einem leistungsstarken 5200-Ah-Akku angetrieben wird, der eine Autonomie von ca. 150 Minuten ermöglicht. Die Schneidplatte hat drei Stahlklingen für einen Mulchschnitt. Dieses Schnittsystem zerkleinert das Gras sehr fein und wirft es dann direkt auf den Boden, wodurch der Rasen ein tadelloses Aussehen erhält, ohne dass das Schnittgut entfernt wird. Außerdem zersetzt sich bei diesem Schnitt das auf dem Rasen abgelagerte Gras und wird zu Nährstoffen für den Boden, wodurch ein ganz natürlicher biologischer Kreislauf entsteht. Der mitgelieferte Begrenzungsdraht und die Pflöcke ermöglichen eine einfache, werkzeuglose Installation.



APP-VERBINDUNG



- A MOTOR BRUSHLESS
- B STOP-TASTE
- C LADESTATION
- D HINTERRAD
- E GRIFF-ABDECKUNG

54252

199,00€

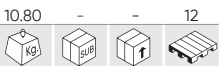

MANUELLE KEHRMASCHINE

- A SCHMUTZSAMMELBEHÄLTER
- B HAUPTTEIL
- C LINKE TELLERBÜRSTE
- D TELLERBÜRSTE RECHTS
- E OBERE ABDECKUNG
- F OBERER SCHIEBEGRIFF
- G UNTERER SCHIEBEGRIFF
- H TRAGEGRIFF

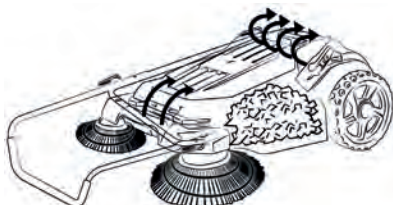
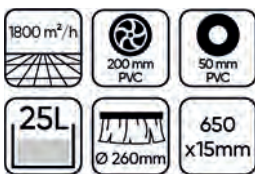

ERNEUERBARE ENERGIEN UND MOBILITÄT DER ZUKUNFT

- 342 LADEKABEL FÜR ELEKTROAUTOS
- 342 LADEGERÄTE FÜR ELEKTROAUTOS
- 343 STROMERZEUGER
- 344 ISOLIERTE WERKZEUGE



LADEKABEL

TIPO 1-2 TYPE 1-2

REF.	BESCHREIBUNG					€
54053	ELEKTRISCHES KFZ-LADEKABEL, 3,6KW, 16 A, TYP 1 FÜR DEN TYP 2 (SINGLE-PHASE)	2.15	-	5	-	248,00€
54054	ELEKTRISCHES KFZ-LADEKABEL, 7,5KW, 32 A, TYP 1 FÜR DEN TYP 2 (SINGLE-PHASE)	2.90	-	5	100	268,00€

-25°
+55°

Tipo
1-2

IP66

5m



TIPO 2-2 TYPE 2-2

REF.	BESCHREIBUNG					€
54055	ELEKTRISCHES KFZ-LADEKABEL, 3,6KW, 16 A, TYP 2 FÜR DEN TYP 2 (SINGLE-PHASE)	2.15	-	5	100	220,00€
54056	LADEKABEL FÜR ELEKTROMOBILE, 11KW, 16 A, TYP 2 FÜR DEN TYP 2 (DREIPHASIG)	2.85	-	5	102	260,00€
54057	ELEKTRISCHES KFZ-LADEKABEL, 7,5KW, 32 A, TYP 2 FÜR DEN TYP 2 (SINGLE-PHASE)	2.95	-	5	102	248,00€
54058	ELEKTRISCHES KFZ-LADEKABEL, 22KW, 32 A, TYP 2 FÜR DEN TYP 2 (DREIPHASIG)	3.85	-	5	100	348,00€

-25°
+55°

Tipo
2-2

IP66

5m



NETZLADEGERÄT

REF.	BESCHREIBUNG					€
52600	NETZLADEGERÄT 3,6 KW, 16 A, FÜR ELEKTROMOBILE (SINGLE-PHASE)	4.65	-	4	80	884,00€
52902	NETZLADEGERÄT 7,5 KW, 32 A, FÜR ELEKTROMOBILE (SINGLE-PHASE)	4.90	-	4	40	970,00€
52903	NETZLADEGERÄT 11 KW, 16 A, FÜR ELEKTROMOBILE (DREIPHASIG)	5.25	-	1	40	1.100,00€

↑ 295mm

← 195mm

↙ 65mm

IP66

-25°
+55°

Tipo
2



54265

1.290,00€

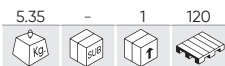

NETZLADEGERÄT 22 KW, 32 A, FÜR ELEKTROMOBILE (DREIPHASIG)



Trifásico
Three-Phase



Kommen Sie in die Zukunft mit unserem Schnelladesystem für Ihr Elektroauto. Modernes und minimalistisches Design. Mit dem JBM Wandladegerät können Sie heute Ihre Garage, Ihren Garten oder Ihren Büro-Parkplatz in einen benutzerfreundlichen Ort für Ihr EV/PHEV verwandeln.

REF.	BESCHREIBUNG	kg	box	unit	€
16130	STROMMESSGERÄT FÜR LADEGERÄT REF. 54265	0.40	-	15	290,00€
16198	CARTE D'IDENTIFICATION RADIO FRÉQUENCE (CARTE RFID) - 54265	0.01	-	-	5,00€

54059

428,00€



TRAGBARE LADESTATION 16 A, MIT DEM TYP 2-LADEKABEL



Mit diesem mobilen Ladegerät können Sie Ihr Fahrzeug aufladen, wo immer Sie sich befinden, mit einer normalen Steckdose. Auch eine schnelle und wirtschaftliche Lösung für das Aufladen von Elektroautos in Ihrer Werkstatt. LCD-Display mit Zugriff auf die wichtigsten Parameter, integriertes Typ-2-Kabel, kompakte Bauweise, extrem robustes Gehäuse und 5 m Gesamtkabellänge garantieren Bedienkomfort und Zuverlässigkeit.

REF.	BESCHREIBUNG	kg	box	unit	€
15460	RADIOFREQUENZIDENTIFIKATIONSKARTE (RFID-KARTE)	0.01	-	250	5,00€

53970

3.790,00€

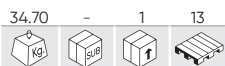

TRAGBARE ELEKTROSTATION 1920WH/48V 40AH

MPPT	CC-CA	2W(x2) LED	200VAC ±10%	Carga rápida Fast Charging 54V/10A 3-4H	Carga solar Solar Charging 54V/7.5A 4-5H
50-60 Hz	UNIVERSAL	12V 10A			
3000W	Salida nominal de CA Rated AC output	1920Wh LiFePO4			
5000W	Pico de salida de CA Peak AC output	x2000	Ciclos de carga Battery life cycles		
USB-QC 5V 9V/12V/3A	DC(x2) 12V/10A	Temperatura de descarga Discharging Temperature -10°C/60°C	Temperatura de carga Temperature 0°C/45°C		
USB-Type-C 5V/3A - 9V/2A 12V/1.5A	USB 5V 2.4A*2				

Die mobile Kraftstation ist ein leistungsstarker tragbarer elektrischer Generator, der mit Solarenergie aufgeladen wird. Bei fehlendem Sonnenlicht kann sie auch von jeder Energiequelle aufgeladen werden.

ENTHALTEN

- BATTERIE LADEGERÄT
- SOLARLADEGERÄT
- KABELVERBINDUNG

KOMPATIBEL MIT **54321**



54321

898,00€



SOLAR PANEEL 200 W

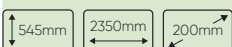

REF.	BESCHREIBUNG	kg	box	unit	€
15448	SATZ MIT 2 STECKERN MC4 1000 V 30 A	0.01	-	186	5,50€

53940

13,20€



SCHUTZGELÄNDERPFOSTEN FÜR PVC - GELB/SCHWARZ

- Werkstoff: PVC.
- Die Basis kann zur besseren Fixierung mit Wasser oder Sand gefüllt werden.

KETTE NICHT INBEGRIFFEN.



SPEZIAL SIGNALISIERUNG HOCHSPANNUNG



54326

7,30€



N

PVC-KETTE - GELB/SCHWARZ
7m



53987

9,50€

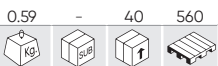

SIGNALBAND GELB / SCHWARZ - 200M



53942

0,50€

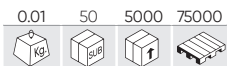

KUNSTSTOFFKETTENGLIED SCHWARZ



54322

19,00€

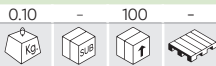

N

SATZ MIT 2 HOCHSPANNUNGSWARNSCHILDERN



52382

19,50€

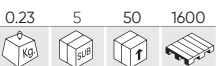

ZANGENSTROMMESSER

DCB	600V
ACB	600V
DCA	-
ACA	20A, 200A, 600A
OHM	2KΩ, 200KΩ, 2MΩ



52952

74,00€



ZANGENSTROMMESSER

DCB	20V, 600V
ACB	600V
DCA	200A
ACA	200A
OHM	2000Ω



50942

28,00€

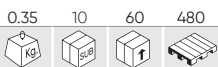

DIGITALES MULTIMETER

- Stellen: 3 1/2.
- Messung: 2000.
- Veränderliche Daten.
- Automatisches Abschalten.



54091

441,00€



ISOLIERTER WERKZEUGSATZ NACH VDE – 26 STÜCK

26PCS
3/8"
CrV
VDE
GS: Geprüfte Sicherheit
1000V
IEC 60900C



54093

441,00€



VDE ISOLIERTES WERKZEUGMODUL EVA (ETHYLENVINYLACETAT) – 26 STÜCK

26PCS
3/8"
CrV
VDE
GS: Geprüfte Sicherheit
1000V
IEC 60900C



53154

462,00€



WERKZEUG-SET 3/8" ISOLIERT, 20 TEILE

20PCS
3/8"
CrV
VDE
GS: Geprüfte Sicherheit
1000V
IEC 60900C



15162

30,20€

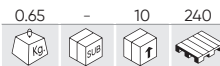

8 ST. SCHRAUBENZIEHERSÄTZE VDE MIT KOHLENFASERBESCHICHTUNG, RINNE AUS EVAC

8PCS
VDE
GS: Geprüfte Sicherheit
1000V
IEC 60900C

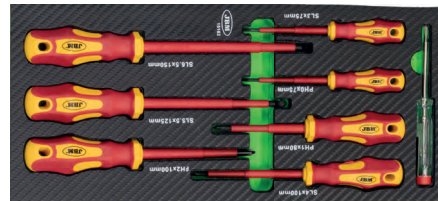

52519

25,50€

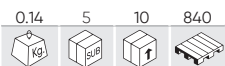

SCHRAUBENDREHER-SET ISOLIERT, 7 STÜCK

7PCS
CrV
VDE
GS: Geprüfte Sicherheit
1000V
IEC 60900:2004

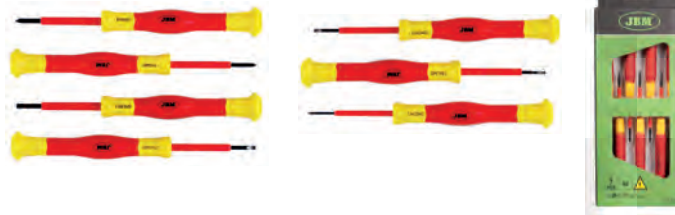

ISOLIERENDE HANDSCHUHE FÜR SPANNUNGSARBEITEN

REF.	BESCHREIBUNG					€
54130	T.9	0.35	-	1	100	58,00€
54131	T.10	0.40	-	1	100	58,00€

AZC
LATEX
CAT III
CLASS 0
1000V AC / 1500V DC
IEC ELECTRICAL SAFETY
GLOVES 60903-2014 CLASS 0



ISOLIERTER KABELMESSER

REF.	BESCHREIBUNG					€
53164	Gerade	0.10	6	36	1152	16,50€
53165	Gebogen	0.10	6	36	1152	19,60€

CrV
VDE
GS: Geprüfte Sicherheit
1000V
IEC 60900C



WERKZEUGWAGEN MIT 7 FÄCHER, SPEZIAL ELEKTRO

54236 1.856,00€

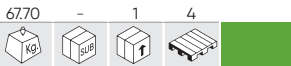

54233 1.856,00€

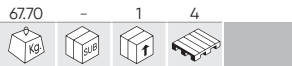

54234 1.856,00€

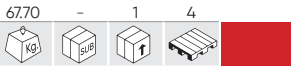

54235 1.856,00€

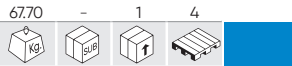

ENTHALTEN

REF.	UNI.	€	REF.	UNI.	€	REF.	UNI.	€
A	52162	1 38,00€	E	54093	1 441,00€	I	54132	1 190,00€
B	53940	4 13,20€	F	54114	1 248,00€	J	54241	1 120,00€
C	54326	1 7,30€	G	54129	1 110,00€			
D	53942	8 0,50€	H	54130	1 58,00€			



54386

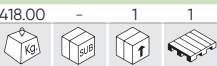

HYDRAULIKTISCH FÜR AUTOBATTERIEN

Ladeeigenschaften	Verteilte Last
Hubzeit (ohne Last)	60"
Absenzeit (ohne Last)	45"
Plattform	1290 - 1400x768mm

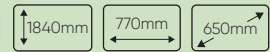

5.839,00€

N



54241

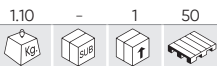

120,00€



ISOLIERTER RETTUNGSMAST - 45KV



54129



110,00€



ISOLIERMATTE KLASSE 0

- CLASS 0
- ENROLLABLE ROLLS
- SLIP RESISTANT
- OIL RESISTANT
- RECYCLABLE
- 1000V AC / 1500V DC
- IEC ELECTRICAL SAFETY
- MATTING 60903-2024 CLASS 0

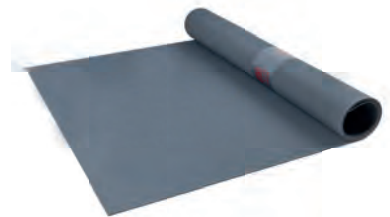

54132

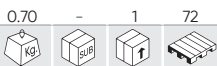

190,00€

ISOLIERENDER GESICHTSSCHUTZ FÜR SPANNUNGSARBEITEN

- ANTI-RALLADURAS / SCRACHING PROOF
- ANTI-VAHO / ANTI FOG
- EN 170:2022
- EN 166:2001
- ANSI Z87.1
- CLASS 1



54114



248,00€

ISOLATIONSWIDERSTANDSMESSGERÄT

- 2000MΩ
- 1000V
- 750V
- CAT III



WERKSTATT-ZUBEHÖR

348 AUFROLLER

349 LEITERN

350 WAGEN UND PLATTFORMEN



LUFT-SCHLAUCHAUFROLLER

REF.	m					€
53582	22m	10.85	-	1	14	174,00€
53583	22m	10.75	-	1	14	174,00€
53532	13m	6.60	-	2	30	119,00€
53581	13m	6.70	-	2	30	119,00€
53881	11m	4.50	-	4	48	79,00€
53882	11m	4.50	-	4	48	79,00€

300 PSI
20 BAR

3/8"

Ø 9.5mm



MIT FÜHRUNGS SYSTEM

WASSERSCHLAUCH AUFROLLER

REF.	m					€
53872	16,5m	7.50	-	1	21	118,00€

15m + 1,5m

120 PSI
8 BAR

3/4"

Ø 15.8mm
Ø 11.5mm

PVC



ERSATZTEILE
VERFÜGBAR



KABEL-AUFROLLER

REF.	m					€
53586	21m	8.35	-	2	30	168,00€
53585	21m	8.35	-	2	36	168,00€
53584	12m	5.10	-	4	48	119,00€
53526	12m	5.15	-	4	48	119,00€

230V

1000W
3000W

IP44

H07RN-F
3G1.5mm²



MIT FÜHRUNGS SYSTEM

ÖLSCHLAUCH-AUFROLLER 1/2"

REF.	m					€
50797	16m	26.60	-	1	14	490,00€

- Mit Schmierölbasis/Spule
- Schlauchlänge: 15+1 m
- Max. Betriebsdruck: 2 450 psi
- Lufteinlass: 1/2", BSPT (Britisches konisches Rohrgewinde)
- Luftauslass: 1/2", (Britisches konisches Rohrgewinde)
- Material: Stahl



160
BAR



TELESKOPLEITER

REF.	BESCHREIBUNG					€
51982	TELESKOPLEITER 6 STUFEN	5.51	-	1	34	120,00€
51983	TELESKOPLEITER 10 STUFEN	9.41	-	1	34	185,00€
51984	TELESKOPLEITER 12 STUFEN	9.78	-	1	22	190,00€

ZERTIFIZIERUNG: EN 131

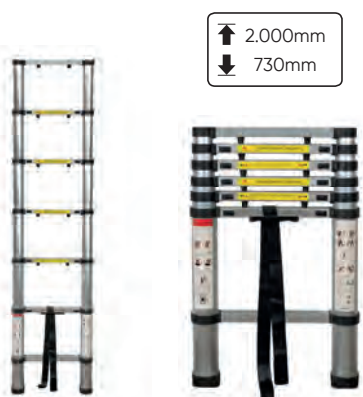

↑ 2.000mm
↓ 730mm

51982

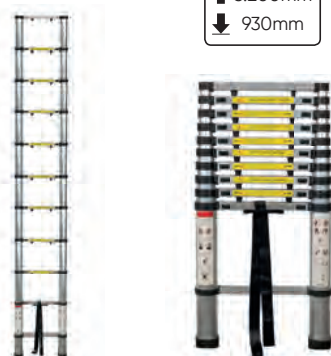

↑ 3.200mm
↓ 930mm

51983

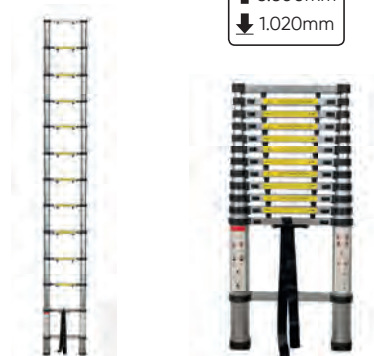

↑ 3.800mm
↓ 1.020mm

51984

52149

14.00	-	1	14

V-FÖRMIGE TELESKOP-KLAPPLEITER

- Leichte Mehrfunktions-Steigleiter.
- System der Verriegelung.
- Konstruktion aus Aluminium und Kunststoff.
- Höhe im montierten Zustand: 835 mm.
- Höhe im zerlegten Zustand: 3800 mm.
- Gesamthöhe: 1900 mm.



230,00€

ZERTIFIZIERUNG: EN 131

54176

188,00€

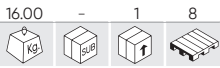

ZERTIFIZIERUNG: EN 131

MEHRZWECKLEITER

- Maximale Länge 3,7 m
- Kapazität: 150 kg
- Material: Aluminium
- Dicke des Aluminiums: 1,2 mm.
- Abstand zwischen zwei Sprossen: 28 cm

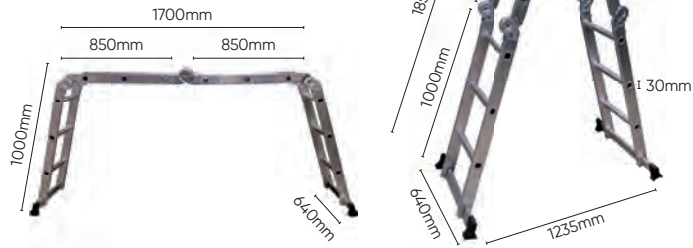

ENTHALTEN

REF. BESCHREIBUNG

15866 2ER SATZ PLATTFORMEN FÜR REF. 54176

5.00	-	1	-	€
				32,00€

50517

129,00€

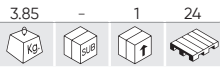

ALU-STEIGLEITER MIT 4 STUFEN

- 4 STUFEN
- Gesamthöhe: 1.47m.
 - Max. Arbeitshöhe: 0.87m.



50518

169,00€

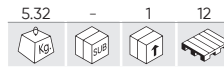

ALU-STEIGLEITER MIT 6 STUFEN

- 6 STUFEN
- Gesamthöhe: 1,91m.
 - Max. Arbeitshöhe: 1,31m.



52230

398,00€

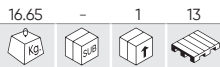

ZERTIFIZIERUNG: EN 131

ALUMINIUM STEIGLEITER-BÜHNE, TELESKOPISCH



MIN			MAX		
↓ 520mm	↔ 1090mm	↘ 300mm	↓ 900mm	↔ 1750mm	↘ 300mm

REF. BESCHREIBUNG

10964 ERSATZ SEITENSCHUTZ FÜR REF.52230

10965 ERSATZ OBERSTÜCK REF.52230

10966 ERSATZ LEITERFUSSGUMMI REF.52230

0.01	-	1	-	€
				9,00€
0.01	-	1	-	€
				6,00€
0.06	-	1	-	€
				13,50€

50656

290,00€

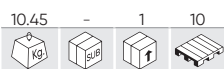

ZERTIFIZIERUNG: EN 131

ALUMINIUM STEIGLEITER-BÜHNE SET - 2 TEILE



REF.	cm					€
11897	100x30x30cm	4.66	-	1	16	155,00€
15552	130x30x55cm	6.80	-	1	18	181,00€

50913

195,00€

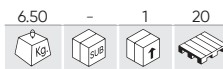

ZERTIFIZIERUNG: EN 131

ALUMINIUM STEIGLEITER-BÜHNE



52202

88,00€

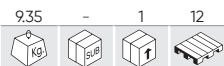

STAHLKARRE



REF.	BESCHREIBUNG					€
12055	KUNSTSTOFFFRAD	1.11	10	160	20,00€	

50924

342,00€



TRANSPORTWAGEN FÜR ÖLFÄSSER

200L



52200

88,00€

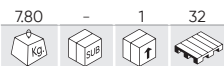

STAHL-PLATTFORMWAGEN 130KG



AUFGEBAUT EINGEKlapPT



54305

232,50€



N

AUFKLAPPBARE PLATTFORM 300 KG WAGEN

AUFGEBAUT EINGEKlapPT



54308

89,00€

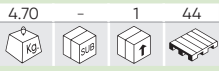

N

AUFKLAPPBARER ALUMINIUMWAGEN 90 KG



AUFGEBAUT



EINGEKLAFFT

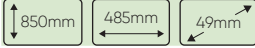

54310

57,00€

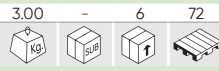

N

AUFKLAPPBARER ALUMINIUMWAGEN 75 KG



AUFGEBAUT



EINGEKLAFFT

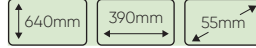

54306

219,50€

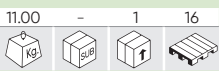

N

AUFKLAPPBARER ALUMINIUMWAGEN 250 KG



AUFGEBAUT



EINGEKLAFFT



54309

71,00€

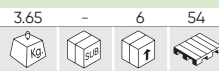

N

TREPPENLIFT KARRE



AUFGEBAUT



EINGEKLAFFT



ZUBEHÖR FÜR FAHRZEUGE

- 354 SIGNALISIERUNG
- 355 NOTAUSRÜSTUNGEN
- 357 GLÜHBIRNEN
- 358 FLÜSSIGKEITEN
- 359 SICHERHEIT
- 359 MANSCHETTEN SÄTZE/KLAMMERN
- 361 AUTOMATTEN
- 362 WISCHERBLÄTTER
- 363 FAHRRAD
- 364 SONSTIGES
- 366 PARKSENSOREN
- 366 FLEXIBLE RÖHREN



ZUBEHÖR FÜR FAHRZEUGE

53778

4,50€

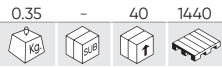

WARNDREIECK - GENEHMIGUNG 27R032736



ÜBEREINSTIMMUNG MIT: E4 27R-032736

52795

5,80€

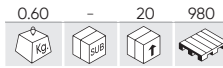

WARNDREIECK - GENEHMIGUNG 27R032738



ÜBEREINSTIMMUNG MIT: E4 27R-032738

54298

7,50€



2 WARNDREIECK - GENEHMIGUNG 27R032736



ÜBEREINSTIMMUNG MIT: E4 27R-032736

N

WARNWESTE - GENEHMIGT

ÜBEREINSTIMMUNG MIT: EN ISO20471:2013

+A1:2016

51817

4,50€

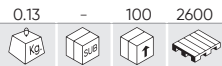

Markierte Band

50654

4,00€



50966

4,00€

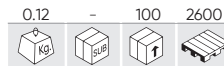

50966C

3,00€

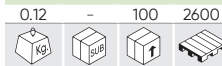

N

REFLEKTOR-BAND FÜR LKW

REF.					€
51935		1.04	10	280	135,00€
51936		1.04	10	140	135,00€
51937		1.02	10	280	135,00€

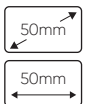
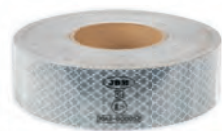

Bestätigt: Verordnung CEPE/ONU 104R

- Gemäß Stand am 10. Juli 2011 in Übereinstimmung mit Änderungen zu der Verordnung für Fahrzeuge für allgemeine Nutzung, die durch den spanischen königlichen Erlass 2822/1998 vom 23. Dezember 2010 bestätigt ist.
- Breite: 50 mm

WARNTAFEL TYP A "ÜBERLANGE LADUNG"

REF.					€
53636	AUS POLYPROPYLEN HERGESTELLT, UM DIE ELASTIZITÄT ZU ERHÖHEN	0.87	25	700	22,00€
53507	VORDERSEITE AUS POLYMETHYLMETACRYLAT (PMMA) UND RÜCKSEITE AUS ALUMINIUM	0.75	25	800	27,00€

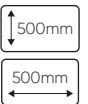

KFZ-NOTFALLSET

TASCHE FÜR AUTO-NOTFALLSET

REF.						€
51692	550x90x130mm	0.11	-	100	1600	3,55€
51693	550x90x130mm	0.12	-	100	1200	3,55€
51694	550x90x130mm	0.14	-	100	1200	3,55€
51696	550x90x130mm	0.12	-	80	1200	3,55€



KFZ-SACK

REF.						€
11328	557x110x70mm	0.12	-	100	1200	4,00€



53721 18,80€

0.16	20	80	1440

LED-NOT-RUNDUMLEUCHTE

x24 LED
12W
24H

x9 LED
1.8W
5H

V16 360°

AUSSTELLER MIT 20 STÜCK

FLACHE TASCHE

REF.						€
53621	550x150mm	0.05	-	100	3200	2,50€
53622	550x150mm	0.05	-	100	3200	2,50€
53623	550x150mm	0.05	-	100	3200	2,50€
53624	550x150mm	0.05	-	100	3200	2,50€



GRÜNFARBENE NYLON SPEZIAL-TASCHE

REF.						€
15619	330x100x80mm	0.09	-	100	1500	4,00€



KFZ-NOTFALLSET

REF.						€
54534	330x100x80mm	0.37	-	10	200	24,00€

Setzen Sie Ihr LOGO

KFZ-NOTFALLSET MIT PVC TASCHE

REF.							€
53185	x1	0.69	-	10	200	13,20€	
53186	x2	1.04	-	10	200	13,20€	

* Doppelter Dreieckreflektor, nur in Spanien verpflichtet.

Setzen Sie Ihr LOGO

KFZ-NOTFALLSET MIT TASCHE

REF.		△					€
52768	■	x2	MK H1	1.81	-	10 200	13,80€
52772	■	x2	MK H1	1.88	-	10 200	13,90€
52776	■	x2	MK H1	1.81	-	10 200	13,80€
52780	■	x2	MK H1	1.94	-	10 200	13,90€
52769	■	x2	MK H4	1.01	-	10 200	14,50€
52773	■	x2	MK H4	1.01	-	10 200	14,60€
52777	■	x2	MK H4	1.07	-	10 200	15,50€
52781	■	x2	MK H4	1.14	-	10 200	14,60€
52770	■	x2	MK H7	2.55	-	10 200	23,00€
52774	■	x2	MK H7	0.99	-	10 200	14,80€
52778	■	x2	MK H7	0.99	-	10 200	14,60€
52782	■	x2	MK H7	1.11	-	10 200	14,80€
52771	■	x2	MK H7+H1	2.75	-	10 200	23,40€
52775	■	x2	MK H7+H1	1.01	-	10 200	15,20€
52779	■	x2	MK H7+H1	1.13	-	10 200	17,10€
52783	■	x2	MK H7+H1	1.01	-	10 200	15,20€



H1 (12V)
H4 (12V)
H7 (12V)

* Doppelter Dreieckreflektor, nur in Spanien verpflichtet.

KFZ-NOTFALLSET MIT PASPELIERTE TASCHE

REF.		△				€
53177	■	x1	0.63	-	10 200	11,90€
53178	■	x1	0.64	-	10 200	12,20€
53179	■	x1	0.65	-	10 200	12,20€
53180	■	x1	0.63	-	10 200	12,20€
53181	■	x2	0.98	-	10 200	11,90€
53182	■	x2	0.99	-	10 200	12,20€
53183	■	x2	0.99	-	10 200	12,70€
53184	■	x2	0.98	-	10 200	12,20€



Setzen Sie Ihr LOGO

* Doppelter Dreieckreflektor, nur in Spanien verpflichtet.

KFZ-NOTFALLSET MIT PASPELIERTE TASCHE

REF.		△				€
53087	■	x1	0.58	-	10 200	11,20€
53088	■	x1	0.59	-	10 200	11,50€
53089	■	x1	0.61	-	10 200	11,50€
53090	■	x1	0.59	-	10 200	11,50€



Setzen Sie Ihr LOGO

KFZ-NOTFALLSET MIT FLACHE TASCHE

REF.		△				€
53091	■	x1	0.52	-	10 200	10,20€
53092	■	x1	0.52	-	10 200	10,20€
53093	■	x1	0.52	-	10 200	10,20€
53094	■	x1	0.52	-	10 200	10,20€



Setzen Sie Ihr LOGO

MINI-SET KFZ-LAMPEN

REF.							€
51613	12V	H1	0,90	10	100	1500	2,90€
51615	12V	H9	0,09	10	100	1500	5,95€
51612	12V	H11	0,09	10	100	1500	5,95€
50523	12V	HB3	0,09	10	100	1500	4,70€
50524	12V	HB4	0,09	10	100	1500	4,70€
50915	12V	H7+H1	0,10	10	100	1800	4,20€
51614	12V	H4	0,10	10	100	1800	3,60€
50431	12V	H7	0,08	10	100	1800	3,80€
52047	24V	H4	0,09	10	100	1500	3,30€
52048	24V	H7	0,10	10	100	1500	3,95€



50551 350,00€

KOMPLETTER LAMPENSCHRANK FÜR KFZ-LAMPEN

1 SCHLUSSLEUCHE
 P21 (W) 21 (W) BA15S 30 ST.
 P21WA 21 (W) BA15S GELB 10 ST.
 PY21 (W) 21 (W) BAU15S
 AMBO DESC. 10 ST.

2 SCHLUSSLEUCHE
 R21/5 (W) 21/5 (W) BAY15D 40 ST.
 INNENBELEUCHTUNG
 C5 (W) 5 (W) SV8,5 11 X 38 22 ST

WARNLEUCHTEN
 R5 (W) 5 (W) BA15S 30 ST.
 R10 (W) 10 (W) BA15S 30 ST.

ANZEIGELAMPEN
 T4 (W) 4 (W) BA9S 22 ST.

HALOGENLAMPEN
 H1 55 (W) P14,5S 10 ST.
 H2 55 (W) X511 4 ST.
 H3 55 (W) PK22S 4 ST.
 H4 60/55 (W) P43T 10 ST.
 H7 55 (W) PX26D 10 ST.
 HB3 65 (W) P20D 4 ST.
 HB4 55 (W) P20D 4 ST.
 H9 65 (W) PGJ19-5 4 ST.
 H11 65 (W) PGJ19-2 4 ST

EUROPÄISCHE LAMPEN
 T5 1,2 (W) W2.1X 4.6D 20 ST.
 T10 5 (W) W2.1X9,6D 12 ST.
 T10 3 (W) W2.1X9,6D 12 ST.
 T13 10 (W) W2.1X9,6D 10 ST.
 T15 18 (W) W2.1X9,6D 10 ST.
 T20 21 (W) W5X16D 10 ST.
 T20A 21 (W) W5X16D GELB 10 ST.
 T20 21/5 (W) W5X16D 10 ST.



OBN KFZ-LAMPEN

REF.	BESCHREIBUNG					€
52365	H7 KFZ-LAMPE 55W	0,02	10	200	9000	2,46€
52364	H1 KFZ-LAMPE 12V 55W	0,02	10	200	4400	2,86€
52362	H1 KFZ-LAMPE 12V 55W	0,01	10	200	14400	1,23€
10766	LAMPEN FÜR RUNDUMLEUCHTEN 51960, 51962	0,01	-	200	-	1,59€
52363	H3 KFZ-LAMPE 12V 55W	0,02	10	200	14400	1,23€
53203	KFZ-LAMPE BERNSTEIN 12V 21W BA15S	0,01	10	200	-	0,46€
52369	KFZ-LAMPE (2P)	0,01	10	1000	18000	1,19€
52368	KFZ-LAMPE, SOCKELLOS 12V T20A	0,01	10	1000	18000	1,14€
53007	KFZ-LAMPE R5W 12W 5V	0,05	10	200	1500	0,42€
52862	KFZ-LAMPE 21W 12V T20	0,01	10	1000	1500	1,15€
52370	KFZ-LAMPE BERNSTEIN, SOCKELLOS 12V T20	0,01	10	1000	18000	1,17€
52864	KFZ-LAMPE WEDGE 21/5W 12V T20	0,01	10	500	1500	1,20€
52865	KFZ-LAMPE WEDGE 10W 12V T13	0,01	10	2000	-	0,50€
52866	KFZ-LAMPE WEDGE 18W 12V T15	0,01	10	2000	256000	0,25€



54042

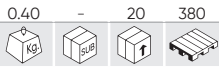

VERBANDKASTEN DIN13164:2022

- x1 Heftpflaster DIN13019-A 5X2, 5
- x4 Heftpflaster DIN 13019-E 10X6
- x2 Elastische fingerpflaster 4x7 cm
- x2 Elastische fingerpflaster 12x2 cm
- x2 Wasserdichte streifenpflaster 1,9x7,2 cm
- x4 Wasserdichte streifenpflaster 2,5x7,2 cm
- x1 Sterile binde DIN 13151-K 6x8 cm
- x2 Sterile binden DIN 13151-M 8x10 cm
- x1 Sterile binde DIN 13151-G 10x12 cm
- x1 Erste-hilfe-verband DIN 13152-BR 60x40 cm
- x1 Erste-hilfe-verband DIN 13152-A 60x80 cm
- x2 Sterile binden DIN 61634FB6 6 cm x 400 cm
- x3 Sterile binden DIN 61634FB6 8 cm x 400 cm
- x1 Rettungsdecke 160x210 cm

13,00€

44 PCS



- x6 Sterile kompressen für wunden 10x10 cm
- x2 Dreieckige binden DIN 13168-D
- x1 Schere DIN 58279-A145 145 cm
- x4 Einmalhandschuhe DIN EN 455-1
- x2 Feuchttücher zur reinigung der haut
- x1 Inhaltsübersicht
- x1 Erste-hilfe-anleitung

51246

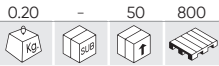

ERSTEHILFE SET

- x1 Erste-Hilfe-Satz
- x1 Schere
- x1 Paar handschuhe
- x2 Alkoholtücher
- x2 Heftpflaster
- x1 Baumwollstreifen, 25 g
- x1 Gazeelemente
- x1 Rollbinde
- x1 Pflasterrolle

6,40€

11 PCS



54072

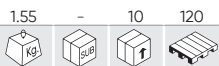

VERBANDKASTEN DIN13157

- x1 Pflaster 5 x 25 - DIN13019-A
- x1 Satz von Klebebinden 10 x 6 cm (8 Stücke) - DIN13019-E
- x6 Fingerpflaster 4 x 6,5 cm
- x6 Fingerpflaster 120 x 20 mm
- x6 Fingerpflaster 7,2 x 1,9 cm
- x12 Fingerpflaster 25 x 72 mm
- x1 Satz von Erste-Hilfe-Binden, sterile Komresse 6 x 8 cm - DIN13151-K
- x3 Sätze von Erste-Hilfe-Binden, sterile Komresse 8 x 10 cm - DIN13151-M
- x1 Satz von Erste-Hilfe-Binden, sterile Komresse 10 x 12 cm - DIN13151-G
- x1 Sterile Komresse (Verband für Brandwunden) 60 x 80 cm - DIN13152-A
- x3 Sterile Wundverbände (Kompressen) 100 x 100 mm, 2 Stücke/Beutel - DIN58953-2
- x2 Augenverbände - 55 mm x 75 mm 1,5 g
- x1 kalte Komresse für die Notfallhilfe, min. 200 cm2
- x1 Erste-Hilfe-Decke, 160 x 210 cm, 12 µm
- x2 elastische Binden gemäß (Gaze), 6 cm x 400 cm - DIN61634 FB6
- x2 elastische Binden gemäß (Gaze), 8 cm x 400 cm - DIN61634 FB8
- x2 Dreieckige Binden 96x96x136 cm - DIN13168-D
- x1 Metallschere 190 mm - DIN58279-B190
- x2 Plastikmüllbeutel, 300 x 400 mm, 45 µm
- x5 Vliesstoffe 20 x 30 cm, min. 15 g/m2
- x1 Einweghandschuhe aus PVC L-AQL1.5 (Satz von 4 Stücken) - DIN EN 455-1

38,50€

67 PCS



- x1 Infobroschüre
- x2 OP-Masken DIN EN 14683
- x4 Reinigungstücher für gesunde Haut

50644 11,60€

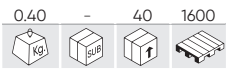

SICHERHEITSGURTE FÜR BUSSE MIT 2 BEFESTIGUNGSPUNKTEN



ÜBEREINSTIMMUNG MIT: E4-16R-0436213

50717 21,90€

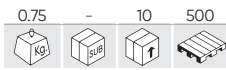

SICHERHEITSGURTE FÜR BUSSE MIT 2 BEFESTIGUNGSPUNKTEN, EINROLLBAR



ÜBEREINSTIMMUNG MIT: E4-16R-0436232

51266 28,00€

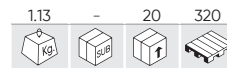

SICHERHEITSGURTE FÜR BUSSE MIT 3 BEFESTIGUNGSPUNKTEN, EINROLLBAR



ÜBEREINSTIMMUNG MIT: E4-16R-0436232

52259 3,75€

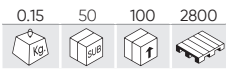

FENSTERBRECHERHAMMER MIT HALTERUNG UND GURTSCHNEIDER



51861 199,00€

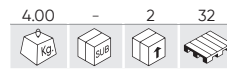

DRUCKLUFT MANSCHETTENEXPANDER



- Material: Aluminium.
- Öffnung: von 20 bis 100mm.

SCHLAUCHSCHELLE

REF.	BESCHREIBUNG					€
11890	SCHLAUCHSCHELLE 50-125MM	0.01	100	1000	18000	0,55€
11891	SCHLAUCHSCHELLE 15-45MM	0.01	100	5000	90000	0,50€
52633	SCHLAUCHSCHELLEN SET - 2 TEILE	0.02	100	800	14400	1,00€



ACHSMANSCHETTEN-KIT

REF.	BESCHREIBUNG				€
51703	ACHSMANSCHETTEN-KIT FÜR TRANSPORTER	0.28	20	320	10,50€
51705	NEOPREN ACHSMANSCHETTEN-KIT FÜR PKW	0.23	20	400	8,45€



52644

8,80€

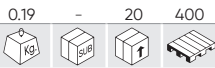

UNIVERSAL LENKMANSCHETTE-KIT



53693

521,00€

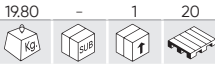

BOX MIT 100X MANSCHETTEN KITS



x100 52633

x100 13738

x100 13879

53698

717,00€

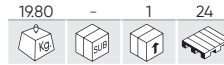

ACHSMANSCHETTEN-KIT BOX FÜR TRANSPORTER - 100 TEILE



x100 52633

x100 13739

x100 13880

53695

504,00€

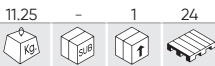

LENKMANSCHETTEN-KIT BOX - 80 TEILE



x80 52633

x80 13740

x80 13880

SERIE124

710,00€



PROMOTION SPEZIAL-SET ACHSMANSCHETTEN PREIZER



x1 51861

x100 52633

x100 13738

x100 13879

ERSATZTEILE

REF.	BESCHREIBUNG	Kg				€
13738	ERSATZTEIL FÜR REF. 51705	0.08	-	150	1800	3,50€
13739	ERSATZTEIL FÜR REF. 51703	0.15	-	100	1600	5,50€
13740	ERSATZTEIL FÜR REF. 52644	0.10	-	72	-	5,50€
13879	ERSATZFETT FÜR REF. 13879	0.09	-	150	5250	1,38€
13880	ERSATZFETT FÜR REF. 52644	0.01	-	600	21000	1,50€

50585

14,70€

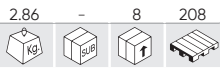

UNIVERSAL WENDBARE GUMMI AUTO-MATTE

- Hochqualitativer Gummi.
- Hochfest.
- Passend für die meisten Fahrzeuge.

UMKEHRBAR!

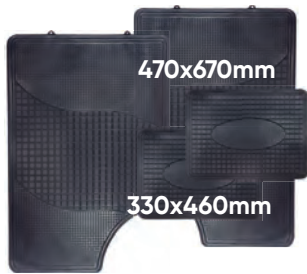

53241

9,00€

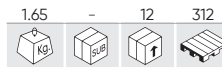

UNIVERSAL GUMMI AUTO-MATTE SET - 4 TEILE

- Hochqualitativer Gummi.
- Hochfest.
- Passend für die meisten Fahrzeuge.



52534

15,00€

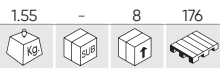

TEPPICHMATTEN SET MIT KUNSTSTOFF-FERSENPOLSTER

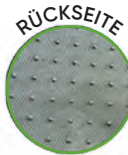

- 2 Vordere (425x660 mm).
- 2 Hintere (2595x425 mm).
- Auf anfrage wird der stand zum aufhängen zur verfügung gestellt.
- Komfortabel und modern.
- Rückseite gummiert.



52535

16,50€



TEPPICHMATTEN SET MIT TEPPICH-FERSENPOLSTER



- 2 Vordere (425x660 mm).
- 2 Hintere (2595x425 mm).
- Auf anfrage wird der stand zum aufhängen zur verfügung gestellt.
- Komfortabel und modern.
- Rückseite gummiert.



52530

14,00€



TEPPICHMATTEN SET

- 2 Vordere (390 mm) + 2 hintere (365x480 mm).
- Auf anfrage wird der stand zum aufhängen zur Verfügung gestellt.
- Komfortabel und modern.

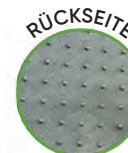

METEXP

62,00€



ROLLGARDEROBE



UNIVERSAL-SCHEIBENWISCHER



99%

Der einfach zu installierende Adapter sind für 99 % der Fahrzeuge geeignet und durch eine hohe Leistung gekennzeichnet.

38dB

Eine Ergonomie und die Leichtigkeit des Aufbaus ermöglichen es, den Geräuschpegel auf 38 dB zu reduzieren.

30%

Gleichmäßiger Druck entlang des Wischerblatts durch die Stahlfeder für eine bessere Sichtbarkeit im Vergleich zu Originalblättern und eine um 30% höhere Leistung.

100%

100% Naturkautschuk beständig gegen alle extremen klimatischen Bedingungen.

160km/h

Aerodynamisches Design, das einem Benutzer bis zu 160 km/h ermöglicht.

45°

Der 45° -Winkel und das präzise geschnittene Wischen von Kante zu Kante entfernen die kleinsten Tröpfchen.

REF.	"	mm					€
53745	11"	280mm	0.20	10	50	800	6,40€
53746	12"	310mm	0.20	10	50	800	6,40€
53747	13"	330mm	0.20	10	50	900	6,40€
53748	14"	350mm	0.20	10	50	800	6,60€
53749	15"	380mm	0.20	10	50	900	6,70€
53750	16"	410mm	0.20	10	50	900	6,70€
53751	17"	430mm	0.20	10	50	900	6,80€
53752	18"	460mm	0.25	10	50	800	6,95€
53753	19"	480mm	0.25	10	50	700	7,10€
53754	20"	510mm	0.25	10	50	900	7,40€
53755	21"	530mm	0.25	10	50	600	7,50€
53756	22"	560mm	0.25	10	50	600	7,90€
53757	24"	610mm	0.25	10	50	600	7,90€
53758	26"	650mm	0.30	10	50	600	8,20€
53759	28"	700mm	0.30	10	50	550	8,50€
53760	30"	750mm	0.30	10	50	500	9,60€

**11 ADAPTERN:
DIE FÜR VERSCHIEDENE
MODELLE GEEIGNET SIND**



**12
PCS**

JBMWBEXP

24,50€

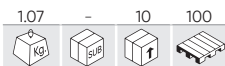

OBN SCHEIBENWISCHER-DISPLAY



53919

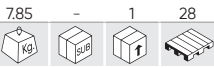

81,00€



REPARATURSTAND FÜR FAHRRÄDER

- Werkstoff: Stahl Q195, ABS, Nylon
- Größe im eingeklappten Zustand: 198x104 cm
- Verstellbare Höhe: 107-188 cm
- Länge des schwenkbaren Querrohrs: 37 cm
- Länge der Stütze: 69 cm
- Durchmesser des schwenkbaren Querrohrs: 35 mm
- Durchmesser des Teleskoprohrs: 35 mm
- Durchmesser des Hauptrohrs: 38 mm
- Durchmesser des Stützrohrs: 25 mm
- Die maximale Tragfähigkeit: 30 kg

AUS VERSTÄRKTEM WERKSSTOFF ABS UND NYLON, UM DAS FAHRRAD UNTER JEDEM WINKEL UND OHNE LACK-BESCHÄDIGUNG ZU DREHEN.

MULTIFUNKTIONS ABLAGEFACH 25X13CM

ANTI-RUTSCH-DESIGN 4 FÜSSE



Für alle Arten von Fahrrädern
Stadt / Straße / Mountainbike



Verstellbare
befestigungsstange: 50-90cm

54166

32,40€

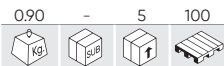

FAHRRAD-STANDPUMPE



54170

16,50€

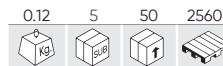

TRAGBARE FAHRRAD-HANDPUMPE



54073

70,00€

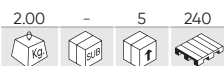

SATZ VON FAHRRADWERKZEUGEN – 20 ST.



54074

18,50€



FAHRRAD-MULTIFUNKTIONSWERKZEUG



54169

13,80€



FAHRRAD-KOMBISCHRANK



ZUBEHÖR FÜR FAHRZEUGE

51858

15,00€



KLAPPBARE SCHAUFEL

- Hergestellt aus festem Metall.
- Im geklappten Zustand: 240 mm.
- Im montierten Zustand: 580 mm.



53033

21,50€



AUSZIEHBARE ALU-SCHAUFEL

- Hergestellt aus Kunststoff und Aluminium.
- Im geklappten Zustand: 85 mm.
- Im montierten Zustand: 119 mm.



52187

21,80€



SCHAUFEL MIT HOLZSCHAFT



52251

21,80€



SCHAUFEL MIT HOLZSCHAFT



53964

9,65€

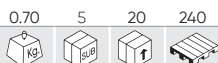

1/4" 30M MULTIFUNKTIONSSSEIL

ø 1/4"
550Kg



53965

25,80€

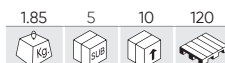

1/2" 30M MULTIFUNKTIONSSSEIL

ø 1/2"
1200Kg



51412

2,10€

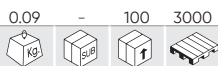

KENNZEICHENHALTER (BESCHREIBBAR AUF ANFRAGE)

- Abmessungen: 53,20cm x 13,70cm.
- Arbeitsbereich: 52cm x 1,60cm.

Beschriftung ist im Preis nicht enthalten



51697

0,80€



EISKRATZER



50526 4,80€

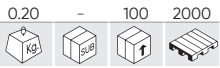

REGENSCHIRM



50525 1,00€

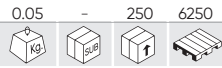

WASSERDICHTER PONCHO



51925 1,00€

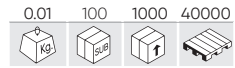

MINISCHERE 9 CM



52618 29,00€



KOFFERRAUMORGANIZER

- Das Set besteht aus 4 Teilen:
- 37L flexible Truhe mit Deckel (300mm x 490mm).
- Rundes Fass mit Deckel Ø 180mm (230mm hoch).
- Aufhänger ohne Deckel (90mm hoch x 260mm lang).
- Starres Tablett (175 mm hoch x 300 mm lang).



53221 4,75€

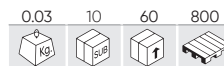

MIKROFASERTÜCHER SET - 3 TEILE

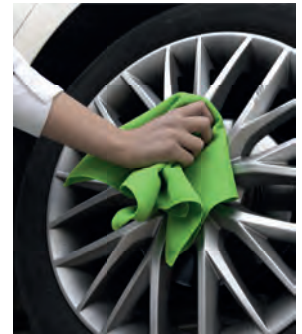

53561 28,00€

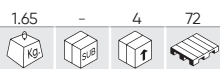

UNTERLEGKEIL



53508 14,00€

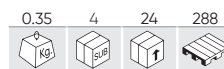

UNTERLEGKEILE SET - 2 TEILE

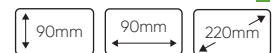

REF. BESCHREIBUNG	Kg	Box	Tray	€
14118 UNTERLEGKEIL HALTERUNG	1.25	4	80	26,00€

51863

54,00€

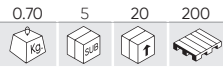

RÜCKFAHRWARNER MIT AKUSTIK- UND VISUALANZEIGE

- Spannung: 12 V DC.
- Leistungsaufnahme: 3,6 W.
- Arbeitstemperatur: - 20-70°.
- 4 nächste Meter.
- Feststellabstand: 0,3-2,0 m.
- Feststellwinkel: T>60°, H>60°.
- Arbeitsfrequenz: 315 mHz/433 mHz.
- Enthält eine 2-Farben-Anzeige, die die Annäherungsmarkierung anzeigt
- Schwarze Geber: dürfen nicht angestrichen werden.



51973

45,00€

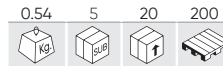

AKUSTISCHER RÜCKFAHRWARNER

- Spannung: 12 V DC.
- Leistungsaufnahme: 3,6W.
- Arbeitstemperatur: -20-70°.
- 4 Annäherungsmelder
- Feststellabstand: 0,3-2,0m.
- Feststellwinkel: T>60°, H>60°.
- Arbeitsfrequenz: 315 mHz/433 mHz.
- Ohne visuellen Anzeiger.
- Der Satz enthält Hörmelder mit Durchmesser von 4 cm.
- Schwarze Geber: dürfen nicht angestrichen werden.



INNERBRAID FLEXROHR

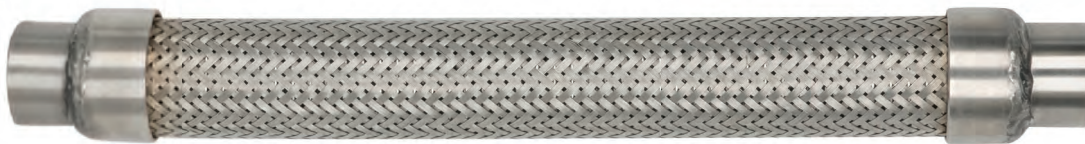

REF.	BESCHREIBUNG					€
51706	Ø 25mmL x 300mmL	0.35	-	25	1500	22,80€
51707	Ø 45mmL x 100mmL	0.27	-	25	1200	9,05€
51708	Ø 45mmL x 150mmL	0.38	-	25	-	14,20€
51709	Ø 45mmL x 200mmL	0.50	-	25	-	14,70€
51710	Ø 45mmL x 250mmL	0.65	-	25	600	17,80€
51711	Ø 45mmL x 300mmL	0.71	-	25	-	21,20€
51712	Ø 50mmL x 100mmL	0.30	-	25	-	8,65€
51713	Ø 50mmL x 150mmL	0.45	-	25	-	13,10€
51714	Ø 50mmL x 200mmL	0.56	-	25	-	15,80€
51715	Ø 50mmL x 250mmL	0.70	-	25	-	20,30€
51716	Ø 50mmL x 300mmL	0.83	-	25	450	23,60€

REF.	BESCHREIBUNG					€
51717	Ø 55mmL x 100mmL	0.35	-	25	-	11,20€
51718	Ø 55mmL x 150mmL	0.50	-	25	-	14,80€
51719	Ø 55mmL x 200mmL	0.65	-	25	-	22,00€
51720	Ø 55mmL x 250mmL	0.85	-	25	350	23,50€
51721	Ø 55mmL x 300mmL	1.00	-	25	375	25,00€
51722	Ø 60mmL x 100mmL	0.36	-	25	750	13,10€
51723	Ø 60mmL x 150mmL	0.50	-	25	450	18,70€
51724	Ø 60mmL x 200mmL	0.66	-	25	400	24,40€
51725	Ø 60mmL x 250mmL	0.83	-	25	-	28,30€
51726	Ø 60mmL x 300mmL	0.96	-	25	250	31,40€
51727	Ø 60mmL x 400mmL	1.62	-	25	200	49,00€

IM EINZELKARTON VERFÜGBAR

REIFENZUBEHÖR

368 AUSWUCHTGEWICHTE

369 PANNENHILFE

370 REIFENVENTILE

371 AUSBAU UND MONTAGE



REIFENZUBEHÖR

51908

44,00€



5G AUSWUCHTGEWICHTE SPENDER

- 1000 x 5 g selbstklebende Eisenstreifen von Gewichten.
- Mit 4 mm dicke.
- Abmessungen des Spenders: 29,5 cm x 29,5 cm.



Mit Rückhalte magnet

53256

34,00€



5G AUSWUCHTGEWICHTE SPENDER

- 1000 x 5 g selbstklebende Eisenstreifen von Gewichten.
- Mit 4 mm dicke.
- Abmessungen des Spenders: 29,5 cm x 29,5 cm.



SELBSTKLEBENDE AUSWUCHTGEWICHTE

REF.	g					€
50600	45g: 3x5g/3x10g	0.05	100	400	36000	0,60€
50601	45g: 3x5g/3x10g	0.05	100	400	48000	0,29€



50600
ZINK



50601
STAHL

SELBSTKLEBENDE AUSWUCHTGEWICHTE

REF.	g					€
52665	60g: 12x5g	0.06	100	400	20000	0,37€
52666	60g: 4x10g/4x5g	0.06	100	400	20000	0,36€



52665



52666

ZINK-AUSWUCHTGEWICHT

FELGEN - UNIVERSAL

REF.	g					€
50760	5g	0.01	100	1600	80000	0,10€
50761	10g	0.01	100	1600	102400	0,19€
50762	15g	0.02	100	800	76800	0,29€
50763	20g	0.02	100	800	64000	0,38€
50764	25g	0.03	100	800	48000	0,49€
50765	30g	0.03	100	600	50400	0,58€
50766	35g	0.04	100	400	32000	0,68€
50767	40g	0.04	100	400	25600	0,78€
50768	45g	0.05	100	400	32000	0,88€
51055	50g	0.05	100	400	2000	0,98€



SPEZIAL FÜR LEICHTMETALLFELGEN

REF.	g					€
50778	5g	0.01	100	1600	80000	0,10€
50779	10g	0.01	100	800	76800	0,19€
50780	15g	0.02	100	1200	60000	0,29€
50781	20g	0.02	100	800	80000	0,38€
50782	25g	0.03	100	600	48000	0,49€
50783	30g	0.03	100	600	30000	0,58€
50784	35g	0.04	100	400	32000	0,68€
50785	40g	0.04	100	400	32000	0,78€
50786	45g	0.05	100	400	32000	0,88€
51604	50g	0.05	100	400	25600	0,98€



UNIVERSAL AUSWUCHTGEWICHT SPEZIAL FÜR LKWS

REF.	g					€
52667	50g	0.05	50	400	25600	0,76€
52668	100g	0.10	25	200	12800	1,49€
52669	150g	0.15	20	160	10240	2,22€
52670	200g	0.20	10	80	5120	2,95€
52671	250g	0.25	10	80	5120	3,70€
52672	300g	0.30	10	80	5120	4,45€



52667



52668



52669



52670



52671



52672

53864

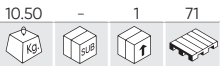

138,00€



AUSWUCHTGEWICHTE SET

ZINGGEWICHTE MIT KLAMMER

UNIVERSAL

- 5g - 20 uds (ref. 50760)
- 10g - 20 uds (ref. 50761)
- 15g - 20 uds (ref. 50762)
- 20g - 20 uds (ref. 50763)
- 25g - 20 uds (ref. 50764)
- 30g - 10 uds (ref. 50765)
- 35g - 10 uds (ref. 50766)
- 40g - 10 uds (ref. 50767)

LEICHMETALLFELGEN

- 5g - 20 uds (ref. 50778)
- 10g - 20 uds (ref. 50779)
- 15g - 20 uds (ref. 50780)
- 20g - 20 uds (ref. 50781)
- 25g - 20 uds (ref. 50782)
- 30g - 10 uds (ref. 50783)
- 35g - 10 uds (ref. 50784)
- 40g - 10 uds (ref. 50785)

SELBSTKLEBENDE AUSWUCHTSTÜCKE IN STREIFEN

60gr: 4x10gr 4x5gr - 70u. (ref. 52666)



51355

19,00€



SPEZIALZANGE - AUSWUCHTGEWICHTE



- Einfaches Abbauen und Austausch von Auswuchtgewichten.
- Einfaches abschneiden und Biegen.
- Hergestellt aus ewehrungs-stahl thermisch behandelt.
- Ergonomischer Griff.



53150

24,00€

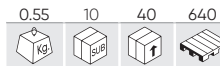

TRAGBARER LUFTKOMPRESSOR 12V 100W



54013

35,00€



EINSTICHREPARATUR - KIT-FLÜSSIGKEIT- UND LUFTKOMPRESSOR

REF.	BESCHREIBUNG	Kg	SUB	1	160	€
A 15317	TASCHE FÜR SET 54013 (53150)	0.10	-	220	-	4,50€
B 15300	REIFENDICHTUNGSMITTEL-500 ML	0.50	-	12	936	5,00€
C 11960	ABZIEHVORRICHTUNG FÜR VENTILKERNE	0.01	10	500	-	1,50€
D 53150	TRAGBARER LUFTKOMPRESSOR 12V 100W	0.55	10	40	640	24,00€

- Versiegelt Einstiche bis zu 6 mm Durchmesser.
- Das Material verursacht keine Korrosion von Metall und Gummi.
- Nicht brennbare und frostsichere Flüssigkeit mit langer Lebensdauer.



51814

8,00€

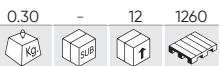

REIFENPANNEN SPRAY 300ML

300ml



52653

3,00€

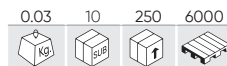

VENTIL WERKZEUG

- Zum ein- und ausschrauben von Nippelkernen.



52652

2,80€

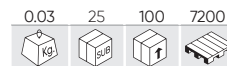

MULTIFUNKTIONS VENTILSCHLÜSSEL



52662

36,50€

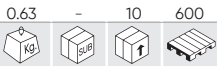

REIFEN-REPARATUR SET



- A 1 x Bohrer mit Lochung
- B 1 x Bohrer zum Einsetzen von Schiebern
- C 1 x Adapter zum Aufpumpen von Reifen
- D 4 x Kolben mit Druckluft 16 g
- E 1 x Messer
- F 10 x Schieber
- G 1 x Multifunktionsventilschlüssel

52663

30,00€

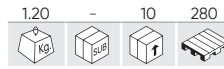

REIFEN-REPARATUR SET

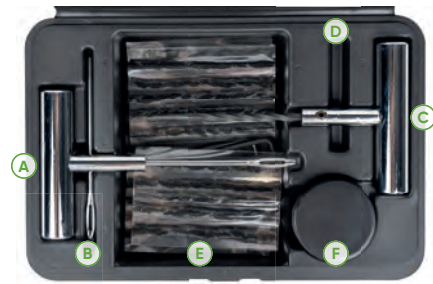

- A 1 x Bohrer zum Einsetzen von Schiebern
- B Bohrer-Einsatz einsetzen von Schiebern
- C 1 x Bohrer mit Lochung
- D 1 x Messer
- E 20 x Schieber
- F 1 x Schmierstoff

REF.	BESCHREIBUNG						€
12973	ERSATZ DOCHT FÜR REF. 52662/52663	0.01	10	500	13500		1,00€
13805	DOCHT-SCHNECKEN EINSATZ (REF. 52663)	0.50	10	50	-		10,50€
13806	BOHRSCHNECKE (REF. 52663)	0.35	5	50	-		10,50€

52673

18,00€

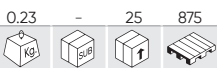

VENTILEN UND VENTILKAPPEN SET



ERSATZTEIL VERFÜGBAR

REF.	BESCHREIBUNG					€
11903	ALU-VENTILKAPPEN BEUTEL - 16 TEILE	0.01	1	100		5,00€
11904	BEUTEL MIT GRÜNE KUNSTSTOFF-VENTILKAPPEN - 50 TEILE	0.10	10	500		2,00€
11905	BEUTEL MIT SCHWARZE KUNSTSTOFF-VENTILKAPPEN - 50 TEILE	0.01	-	10		1,50€
11906	BEUTEL MIT STANDARD VENTILEN - 50 TEILE	0.04	-	100		8,50€
11907	HOCHDRUCK VENTILKERNE BEUTEL - 50 TEILE	0.05	-	100		11,00€
11960	ABZIEHVORRICHTUNG FÜR VENTILKERNE	0.01	10	500		1,50€

AUCH VORHANDEN

REF.	BESCHREIBUNG					€
11900	ALU-VENTILKAPPEN SET - 4 TEILE	0.01	4	25	250	3,50€
11901	GRÜNE KUNSTSTOFF-VENTILKAPPEN SET - 4 TEILE	0.01	4	25	500	2,50€
11902	SCHWARZE KUNSTSTOFF-VENTILKAPPEN SET - 4 TEILE	0.01	4	25	300	3,50€

REIFENVENTIL

REF.	BESCHREIBUNG						€
51741	TR413 45mm	0.01	100	1000	48000		0,50€
51742	TR414 51mm	0.01	100	1000	48000		0,50€
51743	TR418 64mm	0.02	100	1000	48000		0,55€



MONTAGEHILFE WERKZEUG FÜR VENTILE

REF.	BESCHREIBUNG						€
52649	METAL	0.32	10	50	2250		5,00€
52650	KUNSTSTOFF	0.15	10	100	2400		5,00€



52657 37,50€

0.18 5 20 800

MONTAGEKOPF FÜR REIFENMONTIERMASCHINE



52658 39,70€

0.17 - 20 800

MONTAGEKOPF FÜR REIFENMONTIERMASCHINE



52659 39,70€

0.26 - 20 1920

MONTAGEKOPF FÜR REIFENMONTIERMASCHINE



54329 37,50€

0.20 10 100 -

MONTAGEKOPF FÜR REIFENMONTIERMASCHINE

N

EUR - MADE IN SPAIN

52655 39,70€

0.39 - 25 1500

MANUELLE WULSTKLEMME

↑155-180mm

←95mm

52656 39,50€

0.40 5 20 1920

MANUELLE WULSTKLEMME

↑160mm

←170mm

↙55mm

MONTAGEHEBEL

REF.	"					€
51362	12" (30,48cm)	0.15	5	60	500	3,00€
51358	16" (40,64cm)	0.47	6	24	1008	7,50€
51359	24" (60,96cm)	0.90	6	30	1440	9,00€



ZENTRIERRINGE

REF.	mm					€
52645	25x22x2,5mm	0.01	50	1000	38000	0,55€
52646	25x12x2,0mm	0.00	50	1000	80000	0,50€
53037	23x12x2,5mm	0.01	50	1000	35000	0,50€
53038	21x12x2,5mm	0.01	50	1000	35000	0,50€
53039	25x19x2,5mm	0.02	50	1000	35000	0,50€
53040	25x9x2,5mm	0.01	50	1000	35000	0,50€



52664

168,00€

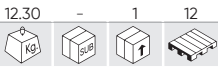

REIFEN DEMONTAGE-HEBEL FÜR LKWS



53605

141,00€

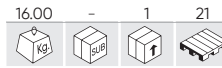

950mm

MANUELLE REIFENMONTIERMASCHINE

- Anwendbarkeit:
Alle Reifen von 8 Zoll bis Leicht-Lkw-Reifen (7-1/2 Zoll x 16 Zoll)
- Schwimmreifen:
Bis zu 12.5L 16
- Lieferumfang:
1 Griff zum Brechen der Reifenwulst mit einer Länge von 37 Zoll
Montage- / Demontagewerkzeug



52660

126,00€

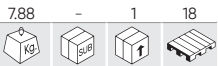

TRANSPORTWAGEN FÜR REIFEN, TRFG. 200KG



52552

128,00€

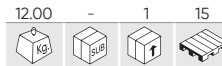

REIFENSHOCKFÜLLER

- 87-116 PSI
6-8 BAR
- MAX
10 BAR
145 PSI
- 18L
- 20°C
40°C



REF. BESCHREIBUNG

13741 ERSATZTEIL FÜR REF. 52552

					€
	0.35	-	32	-	21,00€

53542

980,00€

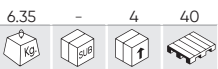

DRUCKLUFT REIFENABDRÜCKER



54198

59,00€

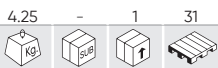

REIFENWAGEN MIT ROLLEN

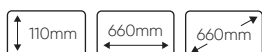

54136

107,00€

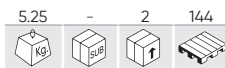

MANUELLE REIFENMONTIERMASCHINE



52842

11,00€

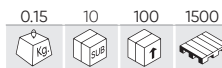

ANROLLER FÜR REIFENREPARATUR



53419

9,70€

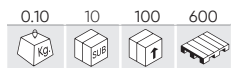

RADFELGEN SCHUTZ-SET 3 STÜCK



SICHERHEIT UND PSA

374 HANDSCHUHE / PSA

377 ATEMSCHUTZMASKEN / SPENDER

379 DELIMITIERUNG

380 OZON-MESSGERÄT

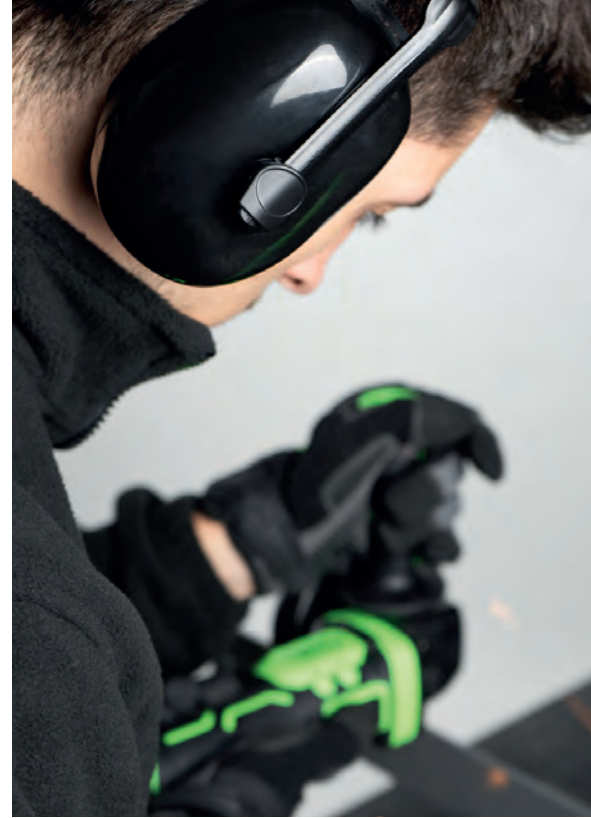



100% NITRIL
EINWEG-HANDSCHUHE

NITRIL EINWEG-HANDSCHUHE

3.5MIL
4.2g

REF.	UDS.				€
54294	S 100	0.40	10	500	8,00€
53984	M 100	0.45	10	500	8,00€
53985	L 100	0.50	10	500	8,00€
53986	XL 100	0.55	10	500	8,00€



3.5MIL
4.2g

REF.	UDS.				€
54155	M 100	0.46	10	570	8,00€
54156	L 100	0.50	10	570	8,00€
54157	XL 100	0.55	10	570	8,00€



5MIL
5.5g

REF.	UDS.				€
54151	M 100	0.60	10	500	9,00€
54152	L 100	0.60	10	500	9,00€
54153	XL 100	0.60	10	500	9,00€



NITRIL EINWEG-HANDSCHUHE - DIAMANTTEXTUR

7MIL
8.4g

REF.	UDS.				€
53551	M 100	0.90	10	300	16,00€
53552	L 100	1.00	10	300	16,00€
53553	XL 90	1.00	10	300	16,00€

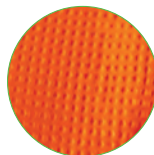

7MIL
8.4g

REF.	UDS.				€
54177	M 100	0.92	10	300	16,00€
54178	L 100	0.96	10	300	16,00€
54179	XL 90	0.97	10	300	16,00€

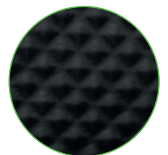

7MIL
8.4g

REF.	UDS.				€
54369	M 100	0.90	10	300	16,00€
54370	L 100	0.88	10	300	16,00€
54371	XL 100	1.05	10	300	16,00€

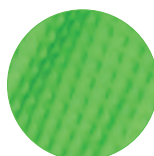

HANDSCHUHE MIT POLYURETHAN BESCHICHTUNG IN DER INNENFLÄCHE

REF.						€	
51640N	T.8		0.05	12	144	3456	1,54€
51642N	T.9		0.01	12	144	3456	1,54€
51636N	T.10		0.05	12	144	3456	1,54€
51638N	T.11		0.05	12	144	3456	1,54€



HANDSCHUHE MIT NITRIL BESCHICHTUNG IN DER INNENFLÄCHE

REF.						€	
51633	T.8		0.04	12	144	3456	1,54€
51634	T.9		0.05	12	144	2592	1,54€
51632N	T.10		0.05	12	144	3456	1,54€
51398N	T.11		0.05	12	144	2592	1,54€



WINTER-ARBEITSHANDSCHUHE

REF.						€	
54192	T.8		0.15	12	144	3456	8,90€
54193	T.9		0.10	12	144	3456	8,90€
54194	T.10		0.15	12	144	3456	8,90€
54195	T.11		0.10	12	144	3456	8,90€



SCHNITTSCHUTZ-HANDSCHUHE TOUCH-SCREEN

REF.						€	
52570	T.8		0.03	12	144	3456	2,60€
52571	T.9		0.03	12	144	2592	2,60€
52572	T.10		0.03	12	144	2592	2,60€
52573	T.11		0.04	12	144	2592	2,60€



LEDERHANDSCHUHE

REF.						€	
52738	T.9		0.10	12	144	2304	5,00€
52739	T.10		0.12	12	144	2304	5,00€



LEDER- UND TEXTILHANDSCHUHE

REF.						€
52310	0.20	12	120	1920		3,65€



SICHERHEIT UND PSA

BAUMWOLLHANDSCHUHE

REF.						€
51745	0.05	12	144	4320		0,70€



BAUMWOLLHANDSCHUHE MIT VERSTÄRKTE OBERFLÄCHE

REF.						€
51785	0.04	12	300	3600		1,00€



ARBEITSHANDSCHUHE

REF.						€
54188	T.8	0.15	12	60	2040	19,00€
54189	T.9	0.15	12	60	720	19,00€
54190	T.10	0.15	12	60	720	19,00€
54191	T.11	0.15	12	60	720	19,00€



FÜR TOUCHSCREEN



52430

10,90€

0.34	6	24	288

KOPFHÖRER



ÜBEREINSTIMMUNG MIT:
EN352 - 1:2003

53785

4,80€

0.05	14	112	896

SCHUTZBRILLE MIT ANTI-FOG-BESCHICHTUNG



ÜBEREINSTIMMUNG MIT:
EN166: 2002-04

SCHUTZBRILLE SPORT MIT ANTIFOG-BESCHICHTUNG

REF.					€
53596	0.01	12	144	2016	3,65€
53597	0.01	12	144	2016	3,70€
53598	0.01	12	144	2016	3,95€



AUSSTELLER MIT
12 SÜCK



ÜBEREINSTIMMUNG MIT: EN166:2002-04 / EN166:2003-01



53596



53597



53598

53794

28,00€

0.15	80	1280	

PROFESSIONELLES INFRAROT-THERMOMETER

- Körpertemperatur in 1 Sekunde und berührungslos messen.
- Automatische Abschaltung nach 1 Minute.

KÖRPERTEMPERATUR	32.0°C - 42.2°C (89.6°F - 108°F)
PRÄZISION	±0.2°C (35°C - 42°C)



CE 0123
2 A BATTERIEN

53862 6,00€

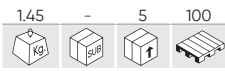

TEPPICH MIT BEHÄLTER FÜR DESINFEKTIONSFLÜSSIGKEIT

- Abmessungen: 85x55x10 cm
- Material: TPE
- Max. empfohlenes Volumen: 3 l
- Max. Volumen: 8 l



53863 3,00€



TROCKENDER TARPET

- Abmessungen: 76 x 48 cm
- Material: Polyester



53781 18,00€

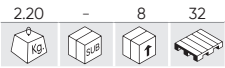

AUTOMATISCHER SCHUHÜBERZUG SPENDER



REF.	BESCHREIBUNG	kg	l	Stk	€
14781	100 TLG SCHUHÜBERZUG	0.25	84	336	990€



53797 0,10€

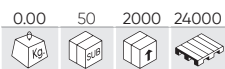

HYGIENISCHE INDIVIDUELLE SCHUTZMASKE



Präsentation in Box mit 5 Beuteln zu je 10 Stück.

NICHT MEDIZINISCHE VERWENDUNG

BAKTERIENFILTRATIONSEFFIZIENZ (BFE)	>98%
ATEMWIDERSTAND	35-50 Pa

Dieses Gerät ist kein Medizinprodukt im Sinne der Richtlinie 93/42 oder der Verordnung EU/2017/745 und keine persönliche Schutzausrüstung im Sinne der Verordnung EU/2016/425. FÜR DEN PERSÖNLICHEN GEBRAUCH, NICHT WIEDERVERWENDBAR.

53957 0,26€

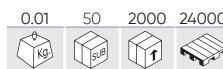

SCHWARZ HYGIENISCHE INDIVIDUELLE SCHUTZMASKE



Präsentation in Box mit 5 Beuteln zu je 10 Stück.

NICHT MEDIZINISCHE VERWENDUNG

BAKTERIENFILTRATIONSEFFIZIENZ (BFE)	>90%
ATEMWIDERSTAND	63-69 Pa

53946 0,83€

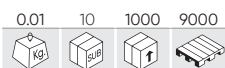

ATEMSCHUTZGERÄT FFP2 - SCHWARZ



Entspricht den Bestimmungen von EN149:2001+A1:2009
Genehmigt gemäß EU-Verordnung 2016/425

53826

16,00€



AUTOMATISCHES GEL-DOSIERGERÄT - 400 ML

- Geeignet für flüssige Seife, Alkohol, Gel und Händedesinfektionsmittel.
- Infrarot-Bewegungssensor mit LED-Licht.
- Dosierung: 1 ml.
- Spannung: 6 V (4 Batterien).
- Batterien nicht enthalten.



14793

12,00€

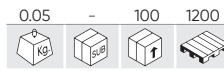

SPENDERPUMPE FÜR 5L-FLASCHE



53902

25,00€

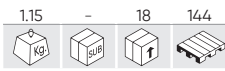

AUTOMATISCHER DOSATOR - 1200 ML

- Dosierung: 0,7 ml/1,4 ml
- Schalteraktivierungsabstand: 80-120 mm
- Spannung: 6 B, 1,5 A
- (4 x 1,5 V Batteriebaugröße C - nicht im Lieferumfang)
- Abmessungen: 160 x 120 x 295 mm
- Material: ABS



53827

32,00€



HALTER FÜR'S AUTOMATISCHE GEL-DOSIERGERÄT

- Gewicht: 4,3 kg
- Material: Stahl
- Farbe: schwarz
- Bordlänge: 417x67 mm
- Stützfußmaße für Dosator: 480x133 mm
- Sockeldurchmesser: 395 mm



REF. BESCHREIBUNG

REF.	BESCHREIBUNG	Kg	Stk	Stk	€
15059	AC/DC-ADAPTER 6V 1.5A	0.10	-	200	10,00€
15062	R14 C1.5V BATTERIE	0.05	24	480	1,00€

VERSTELLBARE LÄNGE
1.25m - 1.58m

53832

1,81€

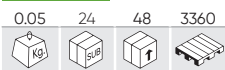

HYDROALKOHOLISCHES GEL 60ML



IM AUSSTELLER MIT 24 STÜCK

53791

4,80€



500ML HYDROALKOHOLISCHES HANDGEL



52493

4,50€

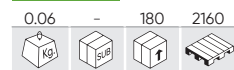

PISTOLE FÜR SPRAYDOSEN



53940 13,20€

0,55 - 6 90

Kg SUB f

↑ 850mm

SCHUTZGELÄNDERPFOSTEN FÜR PVC - GELB/SCHWARZ

- Werkstoff: PVC.
- Die Basis kann zur besseren Fixierung mit Wasser oder Sand gefüllt werden.

KETTE NICHT INBEGRIFFEN.



54322 19,00€

0,10 - 100 -

Kg SUB f

N

SATZ MIT 2 HOCHSPANNUNGSWARNSCHILDERN



53987 9,50€

0,59 - 40 560

Kg SUB f

SIGNALBAND GELB / SCHWARZ - 200M

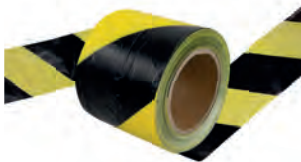

53942 0,50€

0,01 50 5000 75000

Kg SUB f

KUNSTSTOFFKETTENGLIED SCHWARZ



54326 7,30€

0,30 - 20 720

Kg SUB f

N

PVC-KETTE - 7M - GELB/SCHWARZ

7m



53808 16,50€

0,55 - 6 114

Kg SUB f

↑ 850mm

PLASTIK-TRENNPFOSTEN FÜR KETTEN

- Werkstoff: PVC.
- Die Basis kann zur besseren Fixierung mit Wasser oder Sand gefüllt werden.



53914 75,00€

8,50 - 5 90

Kg SUB f

TRENNPFOSTEN MIT EINROLLBARES BAND

- Material: Stahl
- Rohrdurchmesser: 63 mm
- Fußdurchmesser: 320 mm
- Höhe: 910 mm

- Band in 4 Seiten
- Bandlänge: 3 m
- Bandbreite: 48 mm



53811 8,90€

0,45 - 40 560

Kg SUB f

ROT-WEISSES SIGNALBAND



53839 0,25€

0,01 10 2000 16000

Kg SUB f

KUNSTSTOFF KETTENGLIED - 6MM



53809 8,00€

0,30 - 40 960

Kg SUB f

KUNSTSTOFF KETTE 5M - ROT/WEISS

- Länge: 5 m
- Verbindung: 8 mm
- Farbe: rot und weiß

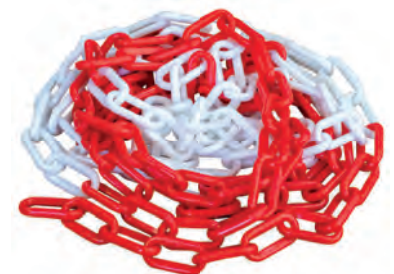

53796

76,00€

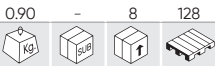

TRAGBARER OZONGENERATOR 600 MG/H (12V/220V)

TEMPORIZADOR
TIMER

15W

15m³/h

O₃
600mg/h

12V

220V

3x10⁶
Ions/cm³



600mg/h

Temporizador/Timer	30/30min	60min	HOLD
--------------------	----------	-------	------

53786

98,00€

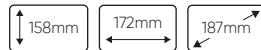

TRAGBARER OZONGENERATOR 5000 MG/H (220V)

67W

80 CFM

2 Amp

5x20mm

TEMPORIZADOR
TIMER

O₃
5000mg/h



5.000mg/h

50m ³	20 min
100m ³	40 min
150m ³	60 min
200m ³	80 min
300m ³	100 min

REF. DESCRIPCION



€

14775	ERSATZPLATTE FÜR DEN TRAGBAREN OZONGENERATOR (REF. 53786)	0.02	-	1	-	30,50€
-------	---	------	---	---	---	--------

53806

250,00€

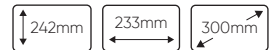
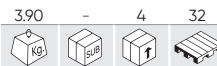

TRAGBARER OZONGENERATOR 20000 MG/H (220V)

TEMPORIZADOR
TIMER

190W

50 dB

O₃
L:1000mg/h
H:20000mg/h

220V

240V

120 CFM

O₃
2000mg/h



10.000mg/h

50m ³	8 min
100m ³	16 min
150m ³	24 min
200m ³	32 min
300m ³	48 min
500m ³	65 min

20.000mg/h

500m ³	30 min
600m ³	40 min
700m ³	50 min
800m ³	60 min
900m ³	70 min
1.000m ³	80 min

REF. DESCRIPCION



€

14803	ERSATZPLATTE FÜR DEN TRAGBAREN OZONGENERATOR	0.03	-	50	-	43,00€
-------	--	------	---	----	---	--------

53838

38,00€

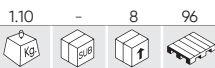

OZONBEHANDLUNGSBOX

12V

Amp
0.38
0.42

5V

2W

UV
1550
µW/cm²

O₃
1.5-2.0mg/h

3 MIN



- UV-Wellenlänge: 254 Nm
- Stromversorgung: Micro-USB-Slot
- Die Box lässt sich leicht zusammen- und auseinanderbauen, was für den Transport günstig ist.

EINGEKLAFFT



AUFGEBAUT



53802

120,00€

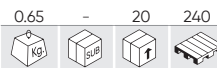

OZONMESSGERÄT

- Genauigkeit: ≤ ±5 % F.S.
- Messbereich: 0-50 ppm (0-98 mg/m³)
- Untere Schwelle: 5 ppm (9,8 mg/m³)
- Obere Schwelle: 10 ppm (19,6 mg/m³)
- Reaktionszeit: < 30 Sekunden
- Betriebstemperatur: -10 °C - 55 °C
- Schutzgrad IP65.



ZWEI EINSTELLBARE ALARMPEGEL FÜR VERSCHIEDENE KONZENTRATIONEN

BETRIEBSDAUER: >8H
LADEZEIT: 4-6H



ERFÜLLT: EN61326-1, EN61000-4-2, EN61000-4-3

VERBRAUCHSMATERIALIEN

- 383** STIFTE UND SPRENGRINGE
- 384** NIETEN
- 384** SCHRAUBEN MUTTERN UNTERLEGSCHLEIBEN
- 388** UNTERLEGSCHLEIBEN FÜR KURBELGEHÄUSE UND MOTOR
- 391** SONSTIGE
- 391** DICHTUNGEN UND O-RINGE
- 392** SCHLAUCHANSCHLÜSSE
- 393** ELEKTRISCH
- 396** KUNSTSTOFFKLAMMERN UND HEFTKLAMMERN



52044

19,00€

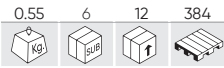

SATZ AUS 150 KLIPSEN



REF.		PCS	€
10793	2,3x43	25	0,25€
10794	3,2x52	20	0,40€
10795	3,8x75	8	0,60€
10882	2x32	42	0,25€
10883	1,6x36	30	0,25€
10884	1,6x42	25	0,25€

52027

14,00€

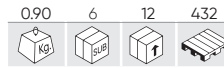

SATZ AUS 365 SPLINTEN



REF.		PCS	€
10796	1,2x25	50	0,07€
10797	1,6x32	50	0,09€
10798	2x40	50	0,12€
10799	2,5x40	50	0,13€
10800	3,2x40	50	0,15€
10801	3,2x50	50	0,17€
10802	4x50	40	0,19€
10803	5x63	10	0,05€
10804	6,3x63	15	0,22€

53348

14,00€

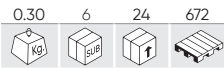

SATZ VON E-KLEMMEN



	PCS
M1.5 - 1/16"	15
M3 - 1/8"	15
M5 - 3/16"	20
M6 - 1/4"	25
M9 - 3/8"	25
M12 - 1/2"	20
M15 - 5/8"	10
M19 - 3/4"	10
M22 - 7/8"	10

53350

14,00€

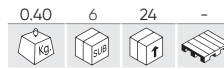

SATZ VON ZYLINDRISCHEN STIFTEN



1/16" x 3/16"	4	3/16" x 5/8"	5
1/16" x 5/16"	4	3/16" x 1"	5
1/16" x 3/4"	4	3/16" x 1-1/4"	5
5/64" x 1/4"	4	7/32" x 5/8"	4
5/64" x 1/2"	4	7/32" x 1-1/4"	4
5/64" x 1"	4	7/32" x 1-3/4"	4
3/32" x 5/8"	4	1/4" x 5/8"	4
3/32" x 1"	4	1/4" x 1-1/4"	4
3/32" x 1-1/4"	4	1/4" x 1-3/4"	4
1/8" x 5/8"	5	5/16" x 3/4"	4
1/8" x 1"	5	5/16" x 1-1/2"	4
1/8" x 1-1/4"	5	5/16" x 2"	4
5/32" x 5/8"	4	3/8" x 3/4"	2
5/32" x 1"	4	3/8" x 1-1/2"	2
5/32" x 1-1/2"	4	3/8" x 2"	2

53363

34,00€

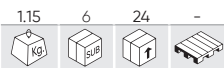

SATZ VON STIFTEN MIT EINEM KOPF UND EINER ÖFFNUNG FÜR DEN SPLINT



	PCS
3.5x44	6
2.5x42	20
2.5x58	7
2x3	7

	PCS
8x50	5
9.5x50	18
11x63	5
12.5x50	3

53364

16,00€

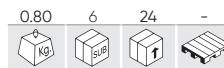

SATZ VON SCHLÜSSELN



	PCS
3x3x25	4
3x3x20	4
5x5x30	5
5x5x25	5
5x5x20	5
6x6x40	5
6x6x30	5
6x6x20	5
8x8x40	5
8x8x30	5
10x10x40	5
10x10x30	5
12x12x40	2

53371

29,00€

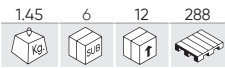

SATZ VON STIFTEN MIT EINEM RING

50 PCS



	PCS
5x36	16
6x45	18
8x45	6
11x45	10

53372

26,00€

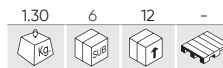

SATZ VON STIFTEN MIT EINEM RING

144 PCS



	PCS
M3x50	50
M4x60	30
M5x75	20
M6x50	20
M6x75	16
M8x60	8

53373

14,50€

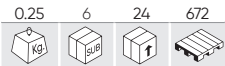

SATZ VON WELLENSCHEIBE

260 PCS



	PCS
M3x10	30
M4x12	30
M5x14	40
M6x14	50
M8x18	50
M10x20	40
M12x25	20

53383

11,50€

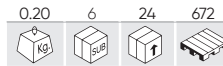

ÄUSERER FEDERRING

300 PCS



	PCS
M4	50
M6	40
M8	45
M10	30
M12	30
M14	25
M16	25
M18	25
M20	15
M22	15

53382

11,00€

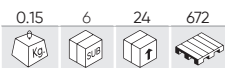

INNERER FEDERRING

300 PCS



	PCS
M4	50
M6	40
M8	45
M10	30
M12	30
M14	25
M16	25
M18	25
M20	15
M22	15

52711

27,50€



SATZ AUS 150 KUNSTSTOFFNIETEN

150 PCS



REF.		PCS	€
13674	6x19,3mm	25	0,50€
13675	6x17,8mm	25	0,50€
13676	6x25,5mm	25	0,50€
13677	6x24,5mm	25	0,50€
13678	6x24mm	50	0,50€

52703

22,00€

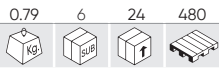

SATZ AUS 235 NIETMUTTERN



REF.		PCS	€
13235	M3	50	0,15€
13236	M4	50	0,15€
13237	M5	50	0,15€
13238	M6	40	0,20€
13239	M8	20	0,20€
13240	M10	15	0,40€
13241	M12	10	0,55€

53360

18,00€

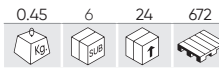

SATZ VON RÄNDEL-NIETMUTTERN AUS ZINK



	PCS
3x9	40
4x11	35
5x13	25
6x15	25
8x18	15
10x21	10

53361

24,00€

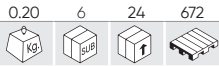

SATZ VON RÄNDEL-NIETMUTTERN AUS ALUMINIUM



	PCS
3x9	40
4x11	35
5x13	25
6x15	25
8x18	15
10x21	10

52043

16,50€

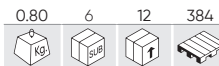

SATZ AUS 300 NIETEN



REF.		PCS	€
10877	4,8x16,90mm	50	0,25€
10878	4,8x24,80mm	40	0,30€
10879	3,2x9,70mm	90	0,20€
10880	4,8x12,70mm	70	0,20€
10881	4,80x20mm	50	0,25€

53351

12,50€

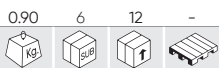

SATZ VON METRISCHEN SECHSKANTSCHRAUBEN



	PCS		PCS
M4x12	10	M4	20
M4x20	10	M5	20
M5x16	10	M6	20
M5x25	10	M8	10
M6x20	10	M10	10
M6x30	10		
M8x25	5		PCS
M8x40	5	M4	20
M10x16	5	M5	20
M10x40	5	M6	20
		M8	10
		M10	10

53354

14,00€

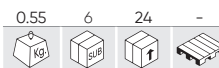

SATZ VON SCHRAUBEN MIT EINEM BOHRER AM ENDE UND EINEM HEX-KOPF



	PCS
#8x12.5	30
#8x16	30
#8x19	30
#8x25	30
#10x12.5	20
#10x16	20
#10x19	20
#10x25	20

53362

14,00€

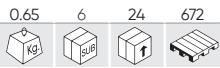

SATZ VON SCHRAUBEN MIT DEM KOPF FÜR DEN INBUSSCHLÜSSEL



	PCS
4x12	25
5x12	25
5x25	20
10x40	3
6x25	10
8x40	5
10x25	3
6x12	10
8x25	5

53365

14,00€

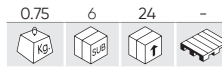

SATZ VON METRISCHEN FLÜGELMUTTERN



	PCS
M4	40
M5	40
M6	25
M8	25
M10	20

53366

14,00€

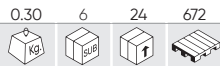

SATZ VON U-KLEMMEN



	PCS
M3.5x8	40
M4.2x16	20
M5x12	15
M6.35x19	10

	PCS
M3.5	20
M3.5 Con muesca/with notch	20
M4	20
M5	15
M6.35	10

53369

14,00€

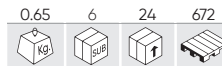

SATZ VON SELBSTBANDSCHRAUBEN MIT DEM FLACHEN KOPF



	PCS
2.8x13mm	65
2.8x16mm	55
3.5x10mm	60
3.5x13mm	65
3.5x16mm	60
3.5x19mm	45
4.2x13mm	50
4.2x16mm	40
4.2x25mm	30
4.2x31mm	20
4.8x19mm	25
4.8x25mm	20
4.8x32mm	15

52029

14,00€

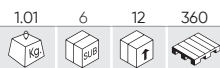

SATZ AUS 228 VON SELBSTKONTERNDEN MUTTERN



	PCS
M3	50
M4	50
M5	40
M6	30
M8	20
M10	15
M12	10
M14	8
M16	5

52028

15,20€

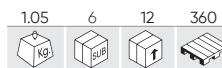

SATZ AUS 243 MUTTERN



REF.		PCS	€
10805	M3	50	0,10€
10779	M4	50	0,05€
10780	M5	50	0,05€
10781	M6	30	0,05€
10784	M8	20	0,05€
10785	M10	20	0,10€
10786	M12	10	0,15€
10812	M14	8	0,30€
10813	M16	5	0,30€

52032

28,00€

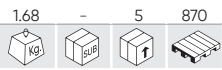

SATZ AUS 1735 FEDERUNGEN



	PCS
3mm	600
4mm	400
5mm	220
6mm	220
8mm	110
10mm	65
12mm	50
14mm	40
16mm	30



53377

20,00€

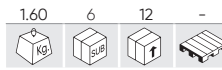

SATZ VON SCHEIBEN



	PCS
20x6x1.5	20
20x8x1.5	20
20x10x1.5	20
25x6x1.5	20
25x8x1.5	20
25x10x1.5	20
32x2x1.5	20
32x4x1.5	20
32x6x1.5	20
32x8x1.5	20
32x10x1.5	20
32x10x1.5	20



52158

38,50€

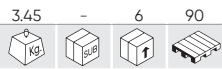

SATZ AUS 475 SCHEIBEN AUS VERZINKTEM EISEN

**475
PCS**

	PCS		PCS
5x20x1.5	50	6x30x2	25
6x20x1.5	50	7x30x2	25
7x20x1.5	50	8x30x2	25
8x20x1.5	50	4x11x0.98	50
8x25x1.75	50	12x40x3	25
10x30x2.5	25	4x20x1.5	50



51804

58,00€



SATZ VON SCHRAUBEN, MUTTERN UND SCHEIBEN

**828
PCS**

REF.	BESCHREIBUNG	PCS	€
10772	VERZINKTE SCHRAUBEN DIN 933 8.8 M4X25	25	0,05€
10773	VERZINKTE SCHRAUBE DIN 933 8.8 M5X50	25	0,10€
10774	VERZINKTE SCHRAUBE DIN 933 8.8 M6X50	25	0,10€
10775	VERZINKTE SCHRAUBE DIN 933 8.8 M7X50	15	0,15€
10776	VERZINKTE SCHRAUBE DIN 933 8.8 M8X50	15	0,20€
10777	VERZINKTE SCHRAUBE DIN 933 8.8 M10X50	12	0,20€
10778	VERZINKTE SCHRAUBE DIN 933 8.8 M12X50	20	0,35€
10779	VERZINKTE MUTTER DIN 934 M4	50	0,05€
10780	VERZINKTE MUTTER DIN 934 M5	50	0,05€
10781	VERZINKTE MUTTER DIN 934 M6	50	0,05€
10782	VERZINKTE MUTTER DIN 934 M7	50	0,05€
10783	VERZINKTE UNTERLEGSCHEIBE DIN 125 M12	50	0,05€
10784	VERZINKTE MUTTER DIN 934 M8	50	0,05€
10785	VERZINKTE MUTTER DIN 934 M10	50	0,10€
10786	VERZINKTE MUTTER DIN 934 M12	40	0,15€
10787	VERZINKTE UNTERLEGSCHEIBE DIN 125 M14	50	0,05€
10788	VERZINKTE UNTERLEGSCHEIBE DIN 125 M5	50	0,05€
10789	VERZINKTE UNTERLEGSCHEIBE DIN 125 M6	50	0,05€
10790	VERZINKTE UNTERLEGSCHEIBE DIN 125 M7	50	0,05€
10791	VERZINKTE UNTERLEGSCHEIBE DIN 125 M8	50	0,05€
10792	VERZINKTE UNTERLEGSCHEIBE DIN 125 M10	50	0,05€

REF.	BESCHREIBUNG	PCS	€
50959	SORTIERBOX 20+1	1	14,00€



53464

153,00€

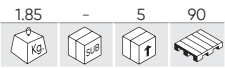

551 PCS

INJECTOR-KUPFERRINGE, ZUSAMMENSTELLUNG 551 STK

ERSATZTEILVERFÜGBARKEIT

REF.	BESCHREIBUNG	PCS	€
13945	Ø15.0x8.0x1.5 - UNIVERSAL	30	7,40€
13946	Ø15.0x7.0x1.5 - MERCEDES	12	6,70€
13947	Ø13.0x7.5x2.5 - RENAULT	30	5,85€
13948	Ø15.0x7.5x1.5 - IVECO, FORD, BMW, MAN	30	5,00€
13949	Ø15.0x7.5x2.0 - IVECO, FORD, BMW, MAN	30	6,50€
13950	Ø15.45x8.0x2.0 - UNIVERSAL	30	7,80€
13951	Ø13.5x10x2.0 - MAZDA (REF.. 53464)	12	5,15€
13952	Ø15.5x7.5x2.5 - FORD	30	10,90€
13953	Ø15.5x7.5x1.5 - LAND ROVER	12	8,00€
13954	Ø15.0x7.5x3.0 - RENAULT	30	12,70€
13955	Ø13.0x7.0x1.5 - DEUTZ	12	4,95€
13956	Ø13.5x7.5x1.5 - FORD	30	4,30€
13957	Ø15.0x7.5x1.5 - FIAT	12	9,70€
13958	Ø15.5x7.5x1 - MAN ROVER	12	5,45€
13959	Ø16.5x7.5x2 - MERCEDES	30	10,10€
13960	Ø13.7x7.3x3 - KIA	12	9,65€
13961	Ø13.7x7.3x2 - KIA	12	9,25€
13962	Ø10x6.0x1.0	50	1,76€
13963	Ø15.8x7.5x3.0	30	12,40€
13964	KUNSTSTOFFDÜSE VON T-TYPE	20	15,00€
13965	Ø8x5.8x1	30	1,50€
13966	KUNSTSTOFFDÜSE VON L-TYPE	30	12,90€
13967	BEUTEL MIT 30 HALTEFEDERN	25	4,65€



52031

44,00€

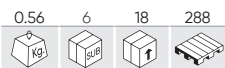

SATZ AUS 900 ALUMINIUMSCHEIBEN



Ø	PCS
3x7x1.5	50
4x8x1.5	50
5x6x1.5	50
16x22x1.5	50
14x22x1.5	50
14x20x1.5	50
6x10x1.5	50
6x11x1.5	50
7x11x1.5	50
7x12x1.5	50
8x12x1.5	50
8x14x1.5	50
9x12x1.5	50
10x14x1.5	50
11x16x1.5	50
11x17x1.5	50
12x16x1.5	50
12x18x1.5	50



53353

18,00€

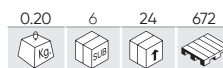

SATZ VON KUPFERSCHEIBEN



Ø	PCS
M6	30
M8	25
M10	20
M12	15
M14	10
M16	10



52163

95,00€

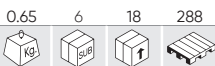

SATZ VON KUPFERSCHEIBEN FÜR ÖLABLAßSCHRAUBEN



ERSATZTEILVERFÜGBARKEIT

REF.	mm	PCS	€
51538	∅ 10mm	100	0,15€
51539	∅ 12mm	100	0,15€
51540	∅ 14mm	100	0,15€
51541	∅ 16mm	100	0,25€
51542	∅ 18mm	100	0,20€
51543	∅ 20mm	25	0,25€

AUCH VERFÜGBAR...

REF.	mm	PCS	€
51544	∅ 22mm	100	0,25€
51545	∅ 26mm	100	0,30€



52030

98,00€



SATZ AUS 900 KUPFERSCHEIBEN



ERSATZTEILVERFÜGBARKEIT

REF.	mm	PCS	€
10823	3x7x1,5mm	50	0,20€
10824	4x8x1,5mm	50	0,20€
10825	5x6x1,5mm	50	0,20€
10826	16x22x1,5mm	50	0,40€
10827	14x22x1,5mm	50	0,60€
10828	14x20x1,5mm	50	0,45€
10829	6x10x1,5mm	50	0,20€
10830	6x11x1,5mm	50	0,20€
10831	7x11x1,5mm	50	0,20€

REF.	mm	PCS	€
10832	7x12x1,5mm	50	0,20€
10833	8x12x1,5mm	50	0,20€
10834	8x14x1,5mm	50	0,25€
10835	9x12x1,5mm	50	0,25€
10836	10x14x1,5mm	50	0,30€
10837	11x16x1,5mm	50	0,30€
10838	11x17x1,5mm	50	0,30€
10839	12x16x1,5mm	50	0,40€
10840	12x18x1,5mm	50	0,35€



KUPFERSCHEIBEN SORTIMENT FÜR INJEKTOREN

53229

38,70€



PCS	PCS
13,8 x 7,3 x 1,4mm 10	15,0 x 7,5 x 3,0mm 10
14,6 x 7,5 x 1,3mm 10	15,5 x 7,5 x 2,0mm 10
14,6 x 7,5 x 3,0mm 10	16,0 x 7,5 x 1,5mm 10
15,0 x 7,0 x 2,0mm 10	16,0 x 7,5 x 1,7mm 10
15,0 x 7,5 x 1,0mm 10	16,0 x 7,5 x 2,0mm 10
15,0 x 7,5 x 1,5mm 10	16,4 x 7,5 x 2,0mm 10
15,0 x 7,5 x 2,0mm 10	20,0 x 9,4 x 0,9mm 10
15,0 x 7,5 x 2,5mm 10	



53340

86,00€



PCS	PCS
13,8 x 7,3 x 1,4mm 25	15,0 x 7,5 x 3,0mm 25
14,6 x 7,5 x 1,3mm 25	15,5 x 7,5 x 2,0mm 25
14,6 x 7,5 x 3,0mm 25	16,0 x 7,5 x 1,5mm 25
15,0 x 7,0 x 2,0mm 25	16,0 x 7,5 x 1,7mm 25
15,0 x 7,5 x 1,0mm 25	16,0 x 7,5 x 2,0mm 25
15,0 x 7,5 x 1,5mm 25	16,4 x 7,5 x 2,0mm 25
15,0 x 7,5 x 2,0mm 25	20,0 x 9,4 x 0,9mm 25
15,0 x 7,5 x 2,5mm 25	



53229 - 53340 ERSATZTEILVERFÜGBARKEIT

REF.	mm	PCS	€
13819	13,8 x 7,3 x 1,4mm	50	6,50€
13820	14,6 x 7,5 x 1,3mm	50	7,00€
13821	14,6 x 7,5 x 3,0mm	50	14,00€
13822	15,0 x 7,0 x 2,0mm	50	11,00€

REF.	mm	PCS	€
13823	15,0 x 7,5 x 1,0mm	50	6,00€
13824	15,0 x 7,5 x 1,5mm	50	8,00€
13825	15,0 x 7,5 x 2,0mm	50	11,50€
13826	15,0 x 7,5 x 2,5mm	50	13,00€

REF.	mm	PCS	€
13827	15,0 x 7,5 x 3,0mm	50	15,00€
13828	15,5 x 7,5 x 2,0mm	50	11,50€
13829	16,0 x 7,5 x 1,5mm	50	10,50€
13830	16,0 x 7,5 x 1,7mm	50	10,50€

REF.	mm	PCS	€
13831	16,0 x 7,5 x 2,0mm	50	12,60€
13832	16,4 x 7,5 x 2,0mm	50	13,00€
13833	20,0 x 9,4 x 0,9mm	50	9,00€

54390

199,00€

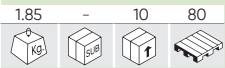

N

SATZ KRAFTSTOFFANSCHLÜSSE UND SCHLÄUCHE (95 STÜCK)

ERSATZTEILVERFÜGBARKEIT

REF.	mm	PCS	€	REF.	mm	PCS	€
16462	6,3x6mm	3	36,50€	16538	7,5x200mm	3	19,50€
16463	7,89x8mm	3	36,50€	16539	12x200mm	1	18,00€
16464	9,49x8 mm	3	36,50€	16540		1	13,00€
16465	9,89x8 mm	3	39,50€	16541	6x340mm	2	13,00€
16466	11,80x10mm	3	50,00€	16542	8x340mm	6	23,50€
16467	6,3x6 mm	3	36,50€	16543	9,5x340mm	2	13,00€
16468	7,89x8 mm	3	36,50€				
16469	9,49x8 mm	3	36,50€				
16470	9,89x8 mm	3	39,50€				
16471	11,8x10mm	3	50,00€				
16472	6,3x6 mm	5	17,50€				
16473	7,89x8mm	5	17,50€				
16474	9,49x8 mm	5	17,50€				
16475	9,89x8mm	5	17,50€				
16476	11,8x10 mm	5	24,00€				
16477	6x7,5mm	3	24,50€				
16478	8x7,5mm	6	24,50€				
16479	15 - 18mm	12	7,50€				
16480	17-20mm	4	7,50€				

95 PCS



METALL-KUNSTSTOFFSCHEIBE FÜR ÖLABLASSSCHRAUBE

REF.	BESCHREIBUNG					€
52719	ÖLABLASSSCHRAUBEN	0.00	100	5000	150000	0,19€
51843	ÖLABLASSSCHRAUBEN	0.01	100	5000	200000	0,19€
51554	ÖLABLASSSCHRAUBEN	0.00	100	5000	180000	0,28€
51546	ÖLABLASSSCHRAUBEN	0.00	100	5000	150000	0,19€
51799	ÖLABLASSSCHRAUBEN	0.01	100	120000	120000	0,20€



53599

30,30€

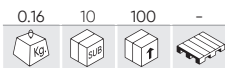

VENTILKERNE SORTIMENT AC

134 PCS

ERSATZTEILVERFÜGBARKEIT

REF.	mm	PCS	€	REF.	mm	PCS	€
14594	5x19mm R12	50	2,00€	14599	7x20mm R134A	10	4,50€
14595	5x19mm	30	1,50€	14600	6x22mm	5	9,50€
14596	5x19mm R12	30	2,00€	14601	8x22mm	1	11,00€
14597	6x19mm	3	7,60€	14602	9x22mm	4	11,00€
14598	6x26mm	1	17,80€				



53358

11,50€

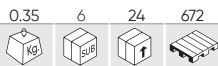

SATZ VON FEDERN



	PCS	mm	PCS
5/16x1-3/4	12	13/64x13/16	10
		7/32x1	10
		1/4x7/8	10
9/32x1/2	10	5/16x1-1/8	8
1/4x13/32	10	5/16x1-1/4	10
7/32x11/16	10	3/16x1-3/4	8
7/32x1-1/2	10	9/32x1-1/2	10
3/8x5/8	6	11/32x1-7/16	10
3/8x3/4	12	11/32x1-27/32	12
23/64x1-3/8	8	9/32x2	12
9/32x3/4	10	5/32x3-1/8	12



53352

12,00€

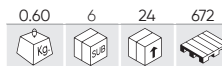

SATZ VON RINGSCHRAUBEN



	PCS
2.4x41	50
4x64	12
4.2x85	5

	PCS
2.4x25	60
4x45	12
4x50	12



52033

43,00€

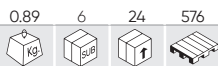

SATZ AUS 135 ÖLERN



REF.	90°	PCS	€
10874	6x1	20	0,30€
10875	8x1	15	0,40€
10876	10x1	10	0,45€

REF.	RECHTER WINKEL	PCS	€
10868	6x1	20	0,30€
10869	8x1	15	0,30€
10870	10x1	10	0,45€

REF.	45°	PCS	€
10871	6x1	20	0,30€
10872	8x1	15	0,40€
10873	10x1	10	0,45€



53359

16,00€

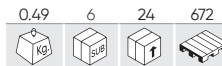

SATZ VON SCHMIERBUCHSEN MIT METRISCHEM GEWINDE



90°	PCS
6x1	60
8x1.25	10
10x1.5	10

RECHTER WINKEL	PCS
6x1	5
8x1.25	5
10x1.5	5

45°	PCS
6x1	5
8x1.25	5
10x1.5	5



53378

13,00€

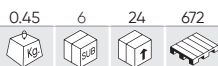

SATZ VON SCHLAUCHSCHELLEN 20 STK



	PCS
1"	4
2-1/2"	2
1-1/4"	2
3"	2
1-3/4"	2
3-1/2"	2
2"	4
4"	2



53381

14,50€

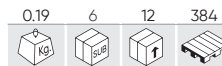

SATZ VON FIBER-SCHEIBEN 600 STK



	PCS
10x5.5x1	160
16x10x1	80
19x12x1	40
22x16x1	30
22.5x14x1	20
32x22x1	20
12x6.5x1	100
16x8x1	60
20x12.5x1	40
27x20x1	20
25.4x17.5x1	15
32x24x1	15



50651

18,00€

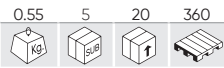

SÄTZE VON DICHRINGEN

386 PCS



	OBERTEIL						UNTERTEIL					
POSITION IM CASE	006	007	008	009	010	011	211	212	213	214	215	216
BREITE (MM)	2	2	2	2	2	2	3	3	3	3	3	3
INNENDURCHMESSER (MM)	A 3	4	5	6	7	8	D 20	22	24	25	27	28
MENGE	16	16	16	16	16	16	12	12	12	12	12	12
POSITION IM CASE	113	112	111	110	012	221	220	219	218	217		
BREITE (MM)	B 2.5	2.5	2.5	2.5	2	E 3	3	3	3	3		
INNENDURCHMESSER (MM)	14	12	11	10	10	36	35	33	32	30		
MENGE	13	13	13	13	17	12	12	12	12	12		
POSITION IM CASE	114	115	116	210	222	325	326	327				
BREITE (MM)	C 2.5	2.5	2.5	3	F 3	4	4	4				
INNENDURCHMESSER (MM)	16	17	19	19	38	38	41	44				
	13	13	13	10	12	10	9	9				



50652

16,50€

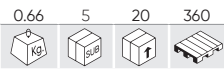

SÄTZE VON DICHRINGEN

382 PCS



	OBERTEIL						UNTERTEIL					
POSITION IM CASE	006	007	008	009	010	011	211	212	213	214	215	216
BREITE (MM)	1/16	1/16	1/16	1/16	1/16	1/16	D 1/8	1/8	1/8	1/8	1/8	1/8
INNENDURCHMESSER (MM)	A 1/8	5/32	3/16	7/32	1/4	5/16	13/16	7/8	15/16	1	11/16	11/18
MENGE	20	20	20	20	20	20	10	10	10	10	10	10
POSITION IM CASE	113	112	111	110	012	221	220	219	218	217		
BREITE (MM)	B 3/32	3/32	3/32	3/32	1/16	E 1/8	1/8	1/8	1/8	1/8		
INNENDURCHMESSER (MM)	9/16	1/2	7/16	3/8	3/8	17/16	13/8	15/16	11/4	13/16		
MENGE	13	13	13	13	13	10	10	10	10	10		
POSITION IM CASE	114	115	116	210	222	325	326	327				
BREITE (MM)	C 3/32	3/32	3/32	1/8	F 1/8	3/16	3/16	3/16				
INNENDURCHMESSER (MM)	5/8	11/16	3/4	3/4	11/2	11/2	15/8	13/4				
MENGE	13	13	13	10	10	7	7	7				
MENGE												

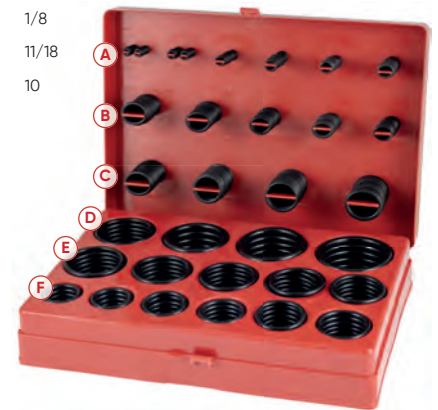

50807

38,00€



O-RING SORTIMENT FÜR AC

270 PCS



PCS	PCS	PCS
5.29x1.78 20	8.80x1.90 20	13.95x2.62 10
6.07x1.78 20	10.82x1.78 15	14.0x2.0 10
6.8x1.9 20	10.77x2.62 15	15.0x2.0 10
7.65x1.78 20	11.0x2.0 15	17.0x2.0 10
7.80x1.90 20	12.0x2.0 15	17.17x1.78 10
8.0x2.0 20	13.9x1.80 10	17.04x3.53 10



VERBRAUCHSMATERIALIEN

53910

19,00€

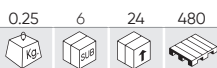

SET VON 113 STCK. AUTOMATISCHEN VAKUUMANSCHLÜSSEN



GERADE

4.8x4.8	10
6.3x6.3	8
7.9x7.9	6
9.5x9.5	6
3.17x3.17	30

T-STÜCK

3.9x3.9x3.9	8
4.8x4.8x4.8	8
6.3x6.3x6.3	6
9.5x9.5x9.5	3
3.17x3.17x3.17	12

REDUZIERUNG

9.5x6.3	6
6.3x4.8	10



53434

18,00€



SET VON 65 STCK. AUTOMATISCHEN VAKUUMANSCHLÜSSEN



PCS

4x28.7	10
3.9x30.8	5
10.4x4.4	10
5.6x4.71	5
7.9x3.8	10
4.7x3.8.9	5
5.2x3.3.9	10
7x3.0	10



53992

18,00€

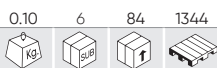

WÄRMESCHRUMPFENDE LÖTMUFFE SATZ 100ST.



Ø1.7mm / 0.25-0.34mm ² / 26-24 AWG	25
Ø2.7mm / 0.5-1.0mm ² / 22-18 AWG	35
Ø4.7mm / 1.5-2.5mm ² / 16-14 AWG	30
Ø6.0mm / 4.0-6.0mm ² / 12-10 AWG	10

53349

14,00€

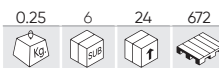

SATZ VON GUMMIBUCHSEN



OFFEN	PCS	VERSCHLOSSEN	PCS
M19,5x23	2	M25	2
M16x24	3	M22	3
M13x15	3	M19	4
M11,5x19	4	M15	5
M10x20	3	M12	10
M10x12	5	M9	20
M9,8x11,5	6	M7	20
M8x14	3		
M7,5x13	7		
M6x7,5	10		
M3,5x6	15		



53374

10,00€

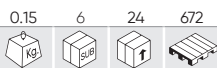

SATZ VON HEIZRÖHREN



	PCS
M2x40	30
M2.5x40	25
M3.5x40	20
M5x40	20
M7x80	16
M10x80	8
M13x85	8



53376

10,50€



SATZ VON VERPACKUNGEN



	PCS
M2x40	30
M2.5x40	25
M3.5x40	20
M5x40	20
M7x80	16
M10x80	8
M13x85	8



REF. BESCHREIBUNG

51920 GASBRENNER

0.14 10 100 400 18,00€

53370

26,00€

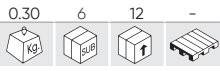

KUNSTSTOFFKAPPE - M2,3,4,5,6,8,10



PCS

M2	25
M3	25
M4	30
M5	30
M6	30
M8	20
M10	20

53355

11,50€

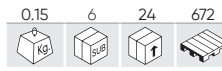

SATZ VON MINI-SICHERUNGEN



PCS

5A	20
10A	20
15A	20
20A	20
25A	20
30A	20

53356

11,50€

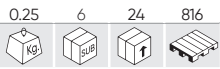

SET VAN AUTO-ZEKERINGEN



REF.	PCS	€
10915 5A	20	0,25€
10917 10A	20	0,30€

REF.	PCS	€
10918 15A	20	0,30€

REF.	PCS	€
10919 20A	20	0,30€
10920 25A	20	0,25€
10921 30A	20	0,30€

53367

9,50€

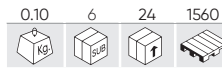

SATZ VON AUTO-SICHERUNGEN



PCS

5A	8
10A	8
15A	8



PCS

20A	8
25A	8
30A	8

53368

9,00€

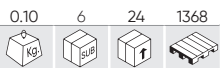

SATZ VON MINI-SICHERUNGEN



PCS

5A	8
10A	8
15A	8
20A	8
25A	8
30A	10

53380

11,50€

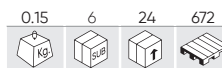

SATZ VON MINI-SICHERUNGEN



PCS

5A	20
10A	20
15A	20
20A	20
25A	20
30A	20

52054

17,00€

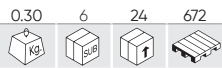

SATZ AUS 252 SICHERUNGEN



REF.	Icon	PCS	€
10905	3A	20	0,25€
10906	4A	20	0,25€
10907	5A	20	0,25€

REF.	Icon	PCS	€
10908	7,5A	20	0,30€
10909	10A	20	0,30€
10910	15A	20	0,30€

REF.	Icon	PCS	€
10911	20A	20	0,30€
10912	25A	20	0,25€
10913	30A	20	0,30€

REF.	Icon	PCS	€
10914	4A	8	0,25€
10915	5A	8	0,25€
12954	3A	8	0,25€

REF.	Icon	PCS	€
10916	7,5A	8	0,30€
10917	10A	8	0,30€
10918	15A	8	0,30€

REF.	Icon	PCS	€
10919	20A	8	0,30€
10920	25A	8	0,25€
10921	30A	8	0,30€



52053

45,00€

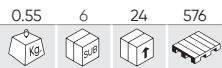

SET KABELSCHUHE 635 STÜCK



REF.	Icon	PCS	€
10885	RV1.25-4S	50	0,20€
10886	RV2-4S	50	0,20€
10887	RV2-6S	30	0,25€
10888	RV5.5-6S	20	0,30€
10889	RV5.5-5S	20	0,30€
10893	RV2-5S	40	0,25€

REF.	Icon	PCS	€
10894	SV1-4S	50	0,20€
10895	SV2-4S	40	0,20€

REF.	Icon	PCS	€
10896	FDD1.25-250	45	0,30€
10898	FDD2-250	40	0,30€
10900	FDD5.5-250	25	0,30€

REF.	Icon	PCS	€
10890	BV5.5	15	0,35€
10891	BV2	25	0,25€
10892	BV1.25	30	0,30€

REF.	Icon	PCS	€
10897	MDD1.25-250	50	0,30€
10899	MDD2-250	50	0,30€
10901	MDD5.5-250	30	0,25€

REF.	Icon	PCS	€
10902	FDN1.25-250	25	0,30€



CRIMPZANGE
SEITE 61 SEHEN



53357

7,00€



KROKODILKLEMMEN SET - 2 TEILE



53385

19,30€



ZANGE - KAROSSERIEKLAMMERN LOSEN



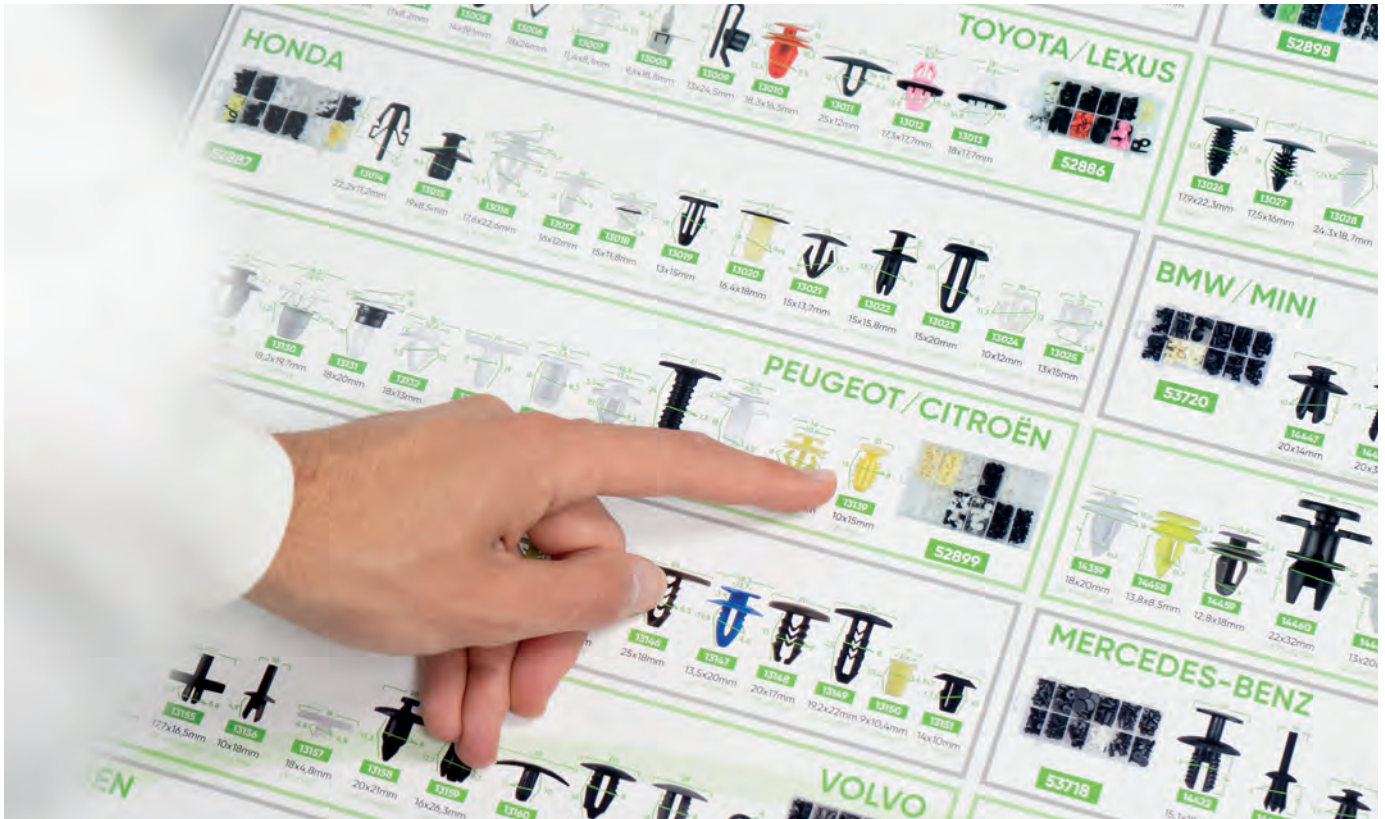

16294

14,00€

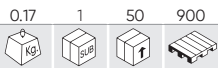

PLAKATKLAMMER ECHE GRÖSSE

TECHNISCHE DATEN:

Größe des Posters: 1000x640mm
Material: 250g laminiertes Papier
Es hat Löcher zum Aufhängen.



TAMAÑO REAL DE LOS CLIPS
CLIPS REAL SIZE

52851

9,65€



HEBEL FÜR KLAMMERN SET - 2 TEILE



53110

27,30€



GREIFER SET - 6 TEILE



- 5"x8.5mm
- 5"x10.3mm
- 5"x4.5mm
- 15"x8.5mm
- 15"x10.3mm
- 15"x4.5mm



VERBRAUCHSMATERIALIEN



EINHEITEN
PRO BOX



EINHEITEN PRO
ERSATZTEILBEUTEL



PRÄSENTATION IN
EINEM DISPLAY

52896



26,00€



KUNSTSTOFF-CLIPS BOX FÜR MAZDA - 190 TEILE

REF.	BESCHREIBUNG	kg	Einheit	€
13104	OE:2042301	8	8	1,90€
13105	OE:999100402	15	15	2,50€
13106	OE:B0016830200	8	8	2,00€
13107	OE:N30413356A	8	8	2,15€
13108	OE:992640543A	20	20	1,90€
13109	OE:99249051B	30	30	2,90€
13110	OE:6508197AA	15	15	1,85€
13111	OE:B1016825200	10	10	1,20€
13112	OE:B09251833	6	6	1,65€
13113	OE:992640543A	20	20	2,20€
13114	OE:B45556741	20	20	2,20€
13115	OE:G03158762	30	30	2,50€

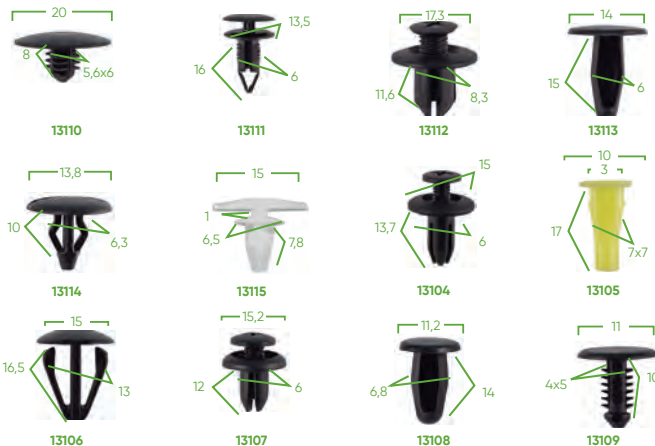

52886



18,00€



KUNSTSTOFF-CLIPS BOX FÜR TOYOTA / LEXUS - 89 TEILE

REF.	BESCHREIBUNG	kg	Einheit	€
13002	OE:9018906001	8	8	1,45€
13003	OE:9046707138	5	4	1,70€
13004	OE:9046707117	10	10	1,85€
13005	OE:9046709138	10	10	1,25€
13006	OE:9046709101	5	5	1,40€
13007	OE:75521611000	10	10	1,30€
13008	OE:7503933060	8	8	2,25€
13009	OE:9017905060	4	4	1,65€
13010	OE:677711250	8	8	1,75€
13011	OE:9046708124	5	5	1,15€
13012	OE:7539533030	8	8	1,80€
13013	OE:9046711063	8	8	1,75€



52887



22,00€



KUNSTSTOFF-CLIPS BOX FÜR HONDA - 150 TEILE

REF.	BESCHREIBUNG	kg	Einheit	€
13014	OE:75103SJ4003	12	12	1,45€
13015	OE:90675SB003	5	5	1,20€
13016	OE:91566SP0003	6	6	1,15€
13017	OE:91513SE003	25	25	2,60€
13018	OE:91530ST5003	25	25	1,45€
13019	OE:90687SA50030	15	15	1,75€
13020	OE:91620SR2003	8	8	1,70€
13021	OE:38529689A6300	8	8	1,30€
13022	OE:90683SA5003	10	10	2,10€
13023	OE:90672671003	10	10	1,50€
13024	OE:91534SEO000	18	18	2,45€
13025	OE:34355SD2003	8	8	1,50€



52899

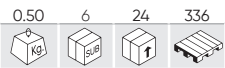

34,00€



KUNSTSTOFF-CLIPS BOX FÜR PEUGEOT/CITROEN - 345 TEILE

REF.	BESCHREIBUNG	kg	sub	€
13128	OE:947098	50	50	1,85€
13129	OE:856535	20	20	2,00€
13130	OE:6991W4	20	20	3,75€
13131	-	20	20	3,45€
13132	OE:694143	25	25	2,65€
13133	OE:743707	35	35	3,45€
13134	OE:7703074022	30	30	3,95€
13135	OE:7703077059	35	35	3,45€
13136	OE:698317	15	15	2,60€
13137	OE:699502	25	25	2,25€
13138	OE:6995X3	30	30	2,85€
13139	OE:69945	40	40	3,85€



52900

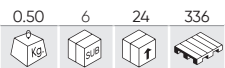

34,00€



KUNSTSTOFF-CLIPS BOX FÜR FIAT - 308 TEILE

REF.	BESCHREIBUNG	kg	sub	€
13140	OE:14591784	30	30	2,65€
13141	OE:1459487	20	10	1,80€
13142	OE:1300433650	25	25	3,10€
13143	OE:71717421	8	8	1,95€
13144	OE:82456515	25	25	2,20€
13145	OE:5757139	25	25	3,85€
13146	-	20	8	4,50€
13147	OE:46306526	25	25	3,10€
13148	OE:14591687	25	25	3,30€
13149	OE:14592387	25	25	3,10€
13150	OE:83468473	30	30	2,25€
13151	OE:7677865	50	30	5,35€

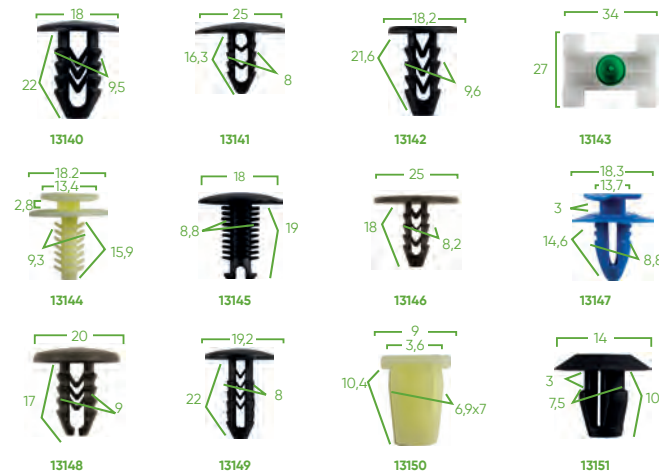

52901

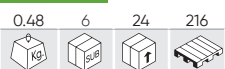

34,00€



KUNSTSTOFF-CLIPS BOX FÜR VOLVO - 350 TEILE

REF.	BESCHREIBUNG	kg	sub	€
13152	OE:8099905N07	25	25	3,05€
13153	OE:4292906	30	30	3,10€
13154	OE:12681763	20	20	3,20€
13155	OE:51131804205	40	40	5,60€
13156	OE:947098	40	40	3,30€
13157	OE:591740	40	40	3,85€
13158	OE:6384801G00	25	25	3,75€
13159	OE:9133417	20	20	3,20€
13160	OE:9133073	40	40	5,00€
13161	OE:3272075327462B	30	30	3,55€
13162	OE:327462A	20	20	2,60€
13163	OE:3923712	20	20	2,80€

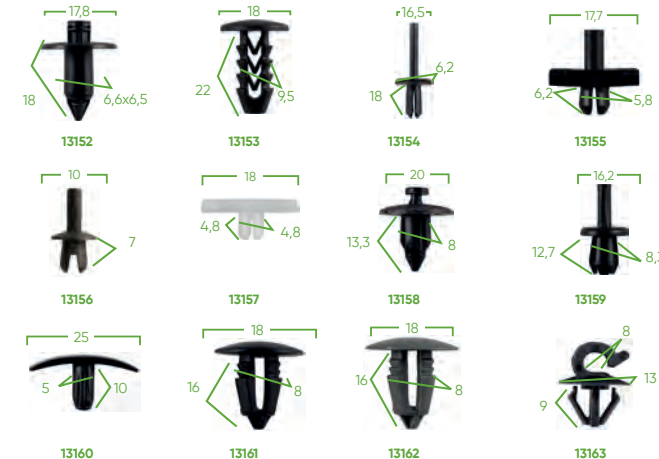

52889

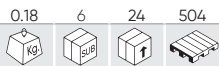

19,00€



KUNSTSTOFF-CLIPS BOX FÜR VOLKSWAGEN - 85 TEILE

REF.	BESCHREIBUNG	1	2	€
13038	OE:1H0868243B	2	2	1,40€
13039	OE:N90833801	10	10	1,65€
13040	OE:3A0853575	8	8	1,80€
13041	OE:4A0853825	5	5	1,55€
13042	OE:6U085733	15	15	1,95€
13043	OE:3B0853576	3	3	1,20€
13044	OE:1H0819055B01C	6	6	1,55€
13045	OE:443853909A	5	5	1,20€
13046	OE:171885767	6	6	1,55€
13047	OE:N9020160H	5	5	1,45€
13048	OE:NO385501	10	10	2,20€
13049	OE:191941142	10	10	2,05€

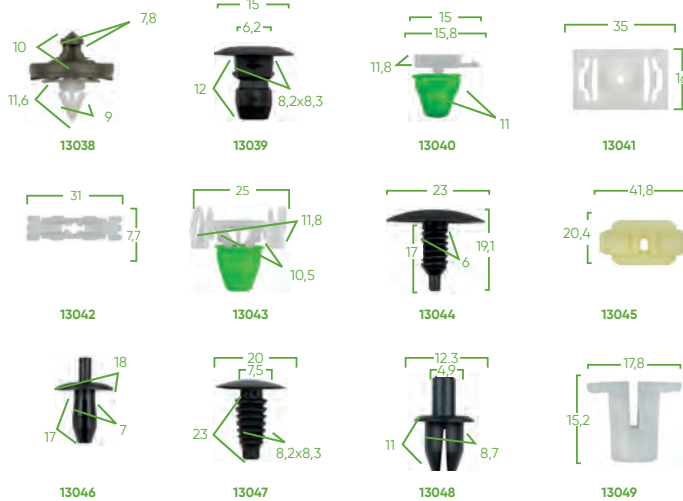

52891

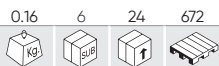

28,00€



KUNSTSTOFF-CLIPS BOX FÜR FORD - 169 TEILE

REF.	BESCHREIBUNG	1	2	€
13056	OE:388577S	8	8	1,55€
13057	OE:N801925S	5	5	1,50€
13058	OE:N806289S	20	20	2,20€
13059	OE:N379830S	20	20	2,35€
13060	OE:1007932	5	5	1,60€
13061	OE:16500308	20	20	2,65€
13062	OE:N803170S	20	20	2,35€
13063	OE:W706713S300	6	6	1,15€
13064	OE:N388246S	20	20	2,60€
13065	OE:F22Z16774A	15	15	2,00€
13066	OE:1673046	5	5	2,25€
13067	OE:F1CZ16674A	25	25	2,55€

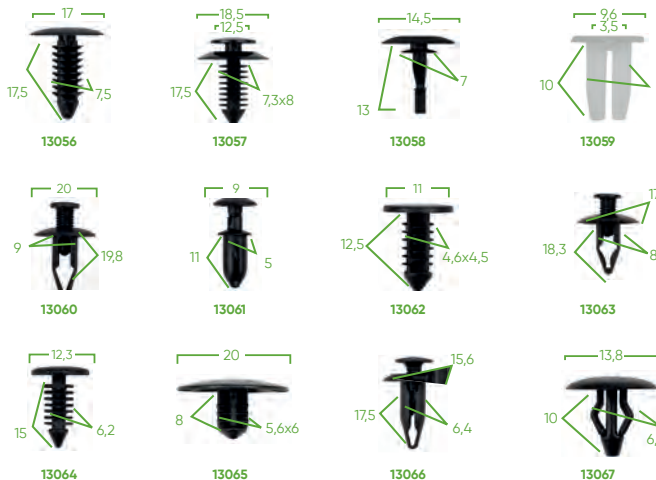

52894

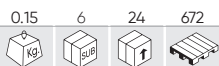

22,00€



KUNSTSTOFF-CLIPS BOX FÜR NISSAN - 139 TEILE

REF.	BESCHREIBUNG	1	2	€
13080	OE:76906T300	15	15	1,75€
13081	OE:0155300172	20	20	2,30€
13082	OE:68425H5000	10	10	1,35€
13083	OE:75521611000	6	6	1,50€
13084	OE:62869N4700	20	20	2,10€
13085	OE:6384401A00	5	5	1,60€
13086	OE:7688257A00	5	5	1,25€
13087	OE:6684101G00	25	25	3,30€
13088	OE:1099830880	10	10	2,40€
13089	OE:8942798070	10	10	1,70€
13090	OE:6384801G00	8	8	1,70€
13091	OE:6385401A00	5	5	1,25€



52890

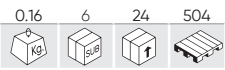

22,00€



KUNSTSTOFF-CLIPS BOX FÜR AUDI - 31 TEILE

REF.	BESCHREIBUNG	kg	sub	€
13050	OE:3B0868243	5	15	1,55€
13051	OE:1H0867199A	5	20	1,50€
13052	OE:1H0868243B	3	3	1,25€
13053	OE:357853575	10	10	2,80€
13054	OE:1H0853585A	5	5	2,35€
13055	OE:3A0853575	3	3	3,00€

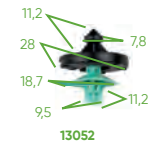

13052



13054

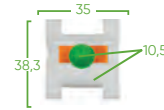

13055



13050



13051



13053



52892

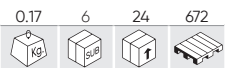

22,00€



KUNSTSTOFF-CLIPS BOX FÜR BMW - 95 TEILE

REF.	BESCHREIBUNG	kg	sub	€
13068	OE:51311802258	25	25	2,85€
13069	OE:5131804205	30	30	4,55€
13070	OE:51118174185	10	10	2,15€
13071	OE:51481938725	10	10	2,05€
13072	OE:703867299	15	15	2,75€
13073	OE:51131960054	5	5	2,10€



13068

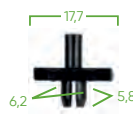

13069



13070

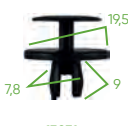

13071

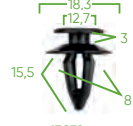

13072



13073



52897

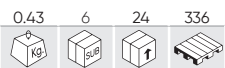

38,00€



KUNSTSTOFF-CLIPS BOX FÜR RENAULT - 300 TEILE

REF.	BESCHREIBUNG	kg	sub	€
13116	OE:7703077421	50	50	5,45€
13117	-	50	50	3,65€
13118	OE:7703081184	60	60	15,90€
13119	-	15	15	5,60€
13120	OE:7703074022	60	60	5,50€
13121	OE:7703077059	65	65	8,75€

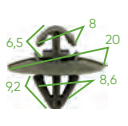

13116

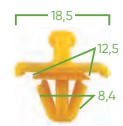

13117



13118

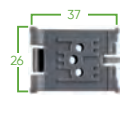

13119



13120

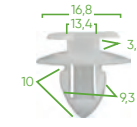

13121



52898

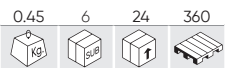

36,00€



KUNSTSTOFF-CLIPS BOX FÜR VAUXHALL/OPEL - 300 TEILE

REF.	BESCHREIBUNG	kg	sub	€
13122	OE:90218614	20	20	1,95€
13123	OE:174864	40	40	5,35€
13124	OE:NO385501	100	100	8,20€
13125	OE:2345959	50	50	5,95€
13126	OE:2240582	50	50	1,55€
13127	OE:180942	40	40	5,60€

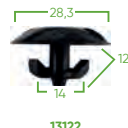

13122

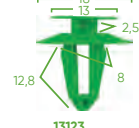

13123

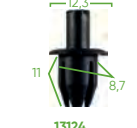

13124

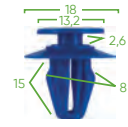

13125

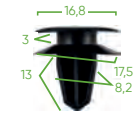

13126



13127



52893

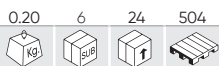

26,00€



KUNSTSTOFF-CLIPS BOX FÜR BENZ - 95 TEILE

REF.	BESCHREIBUNG	kg	Stk	€
13074	OE:A0019884481	30	30	4,65€
13075	OE:A0019882981	20	20	5,35€
13076	OE:A1249900492	15	15	3,90€
13077	OE:A0019888081	4	4	2,55€
13078	OE:A1249880492	6	6	2,55€
13079	OE:A0019880325	20	20	3,35€

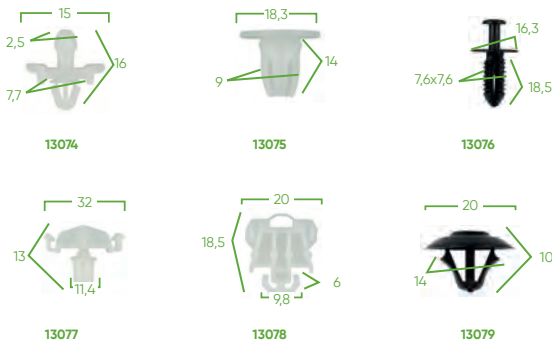

52895



22,00€



KUNSTSTOFF-CLIPS BOX FÜR MITSUBISHI -134 TEILE

REF.	BESCHREIBUNG	kg	Stk	€
13092	OE:8942180270	15	50	1,65€
13093	OE:9018905013	30	30	2,95€
13094	OE:MU480033	10	10	1,50€
13095	OE:128100231	8	6	1,20€
13096	OE:MU480034	8	8	1,70€
13097	OE:MR138807	3	3	1,20€
13098	OE:MB253964	4	4	1,65€
13099	OE:HB121467	30	30	2,75€
13100	OE:MB271999	3	3	1,20€
13101	OE:MB696120	8	8	1,50€
13102	OE:MR200300	5	5	1,60€
13103	OE:MB846992	10	10	1,80€

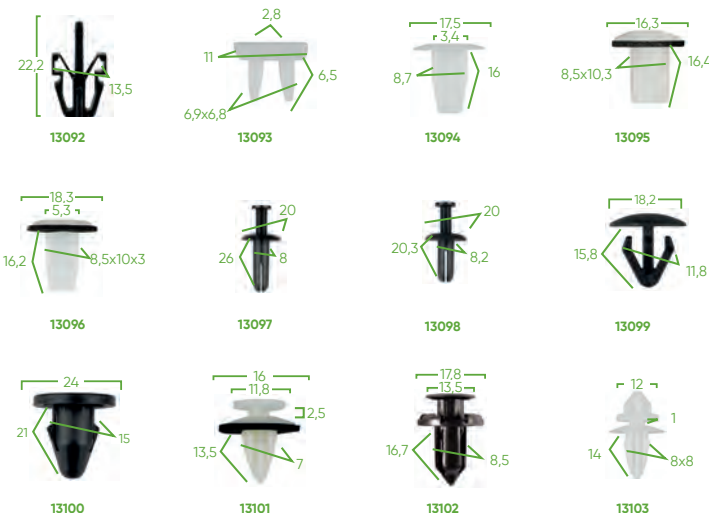

52888



24,00€



KUNSTSTOFF-CLIPS BOX POLSTERUNG, BMW MINI - 128 TEILE

REF.	BESCHREIBUNG	kg	Stk	€
13026	OE:388577S	8	8	1,55€
13027	-	10	10	1,85€
13028	OE:6003423	6	6	1,45€
13029	OE:VW:N989022 CHRYSLER: 6003349 FORD:385661	6	6	1,65€
13030	OE:CHRYSLER: 6502328 GM:20699808	25	25	2,80€
13031	OE:N804379S	4	4	1,85€
13032	OE:FORD:F22Z16774A MAZDA:6508197AA	15	15	2,00€
13033	OE:GM:16674629 FORD:N806113S	10	10	1,60€
13034	OE:0153301781	20	20	2,65€
13035	OE:GM:10124502 BMW:52201964201 LAND ROVER:- DZM10080	6	6	1,65€
13036	OE:VW:N9020160H BMW:51471904317 OPEL:2207713	6	6	1,40€
13037	-	12	12	2,10€

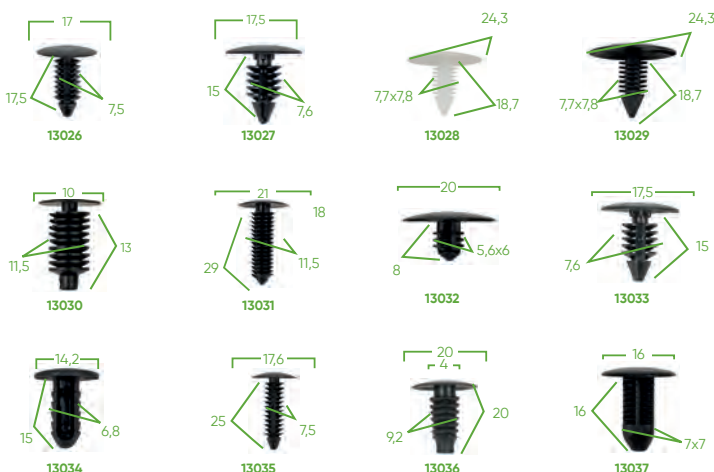

53720

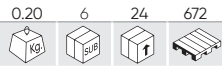

19,00€



KUNSTSTOFF-CLIPS BOX FÜR POLSTERUNG, BMW MINI - 112 TEILE

REF.	BESCHREIBUNG	€
14447	OE: 51471911992 7 6 1,45€	
14449	OE: 51717002953 13 10 2,20€	
14471	OE: 51489119216 5 5 1,90€	
14472	OE: A0009905492 5 5 1,35€	
14474	OE: 51118174185 8 8 1,50€	
14475	OE: 2019900050 6 6 1,65€	
14476	OE: 51481915964 9 9 2,05€	
14477	OE: 0009881625 15 15 2,45€	
14478	OE: 7146976114 15 15 4,05€	
14479	OE: 91503SP0003 6 6 1,65€	
14480	- 15 15 2,05€	
14481	OE: 51161943122 8 8 1,70€	

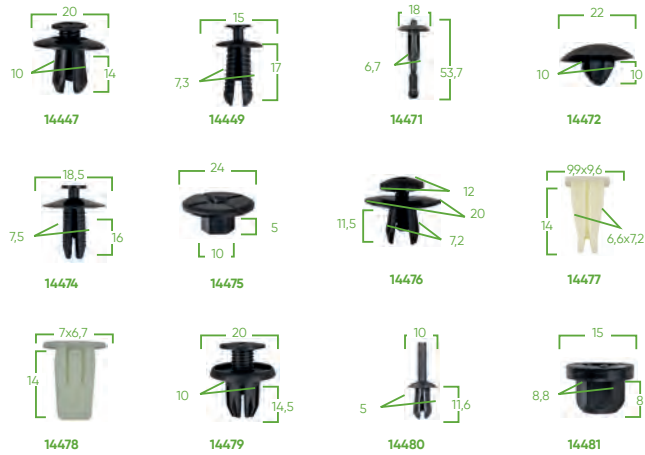

53719

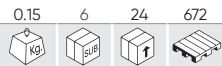

19,00€



KUNSTSTOFF-CLIPS BOX FÜR TÜRVERKLEIDUNG/RAHMEN, BMW MINI - 92 TEILE

REF.	BESCHREIBUNG	€
14359	- 8 8 1,05€	
14458	- 6 6 1,70€	
14459	OE: 7147122912 2 2 1,45€	
14460	OE: 51411973500 8 8 1,15€	
14461	- 8 8 1,35€	
14462	- 8 8 1,65€	
14463	OE: 611769 10 10 1,65€	
14464	OE: 7147145753 10 10 1,50€	
14465	- 8 8 2,00€	
14466	OE: 51418224768 8 4 1,65€	
14468	- 8 8 1,30€	
14469	OE: 7147133419 8 8 1,45€	

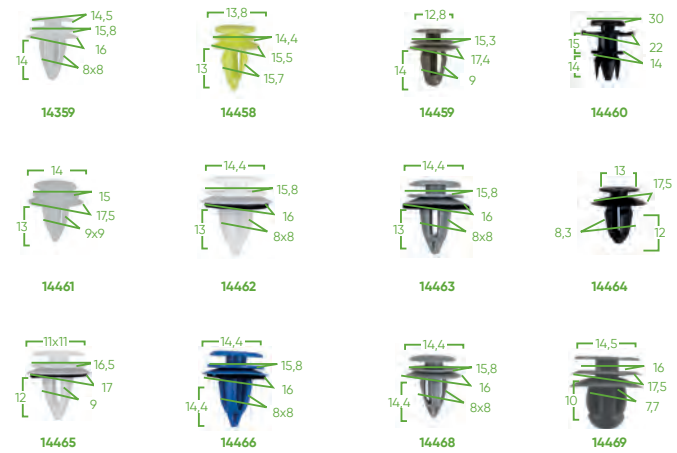

53718

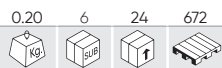

19,00€



KUNSTSTOFF-CLIPS BOX FÜR VERKLEIDUNG/POLSTERUNG, MERCEDES-BENZ - 151 TEILE

REF.	BESCHREIBUNG	€
14422	OE: A0009913940 20 20 1,50€	
14446	OE: 9903492 6 6 2,80€	
14447	OE: 51471911992 12 12 1,45€	
14448	OE: N105835019B9 10 10 2,05€	
14449	OE: A0009905492 12 12 2,20€	
14450	OE: N0385012 12 12 2,15€	
14451	OE: A1239900092 25 25 2,15€	
14452	- 20 20 2,55€	
14453	- 6 6 3,05€	
14455	- 12 12 2,10€	
14456	- 6 6 1,35€	
14457	OE: A1249900492 10 10 1,70€	

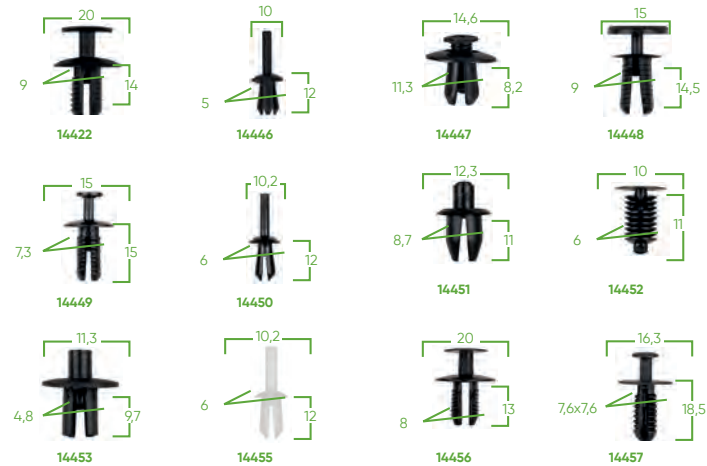

53717

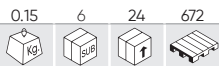

19,00€



KUNSTSTOFF-CLIPS BOX FÜR TÜRVERKLEIDUNG/RAHMEN, MERCEDES-BENZ - 96 TEILE

REF.	BESCHREIBUNG	kg	Stk	€
14434	-	8	8	1,60€
14435	-	6	6	1,45€
14436	OE: A0009910198	8	8	1,70€
14437	OE: A0019912698	6	6	1,45€
14438	OE: A0089880978	8	8	1,35€
14439	OE: 0069884378	8	8	1,75€
14440	-	8	8	1,75€
14441	OE: 0019884981	10	10	1,65€
14442	-	6	6	1,45€
14443	-	8	8	1,45€
14444	OE: 0019886081	10	10	1,90€
14445	-	10	10	1,45€

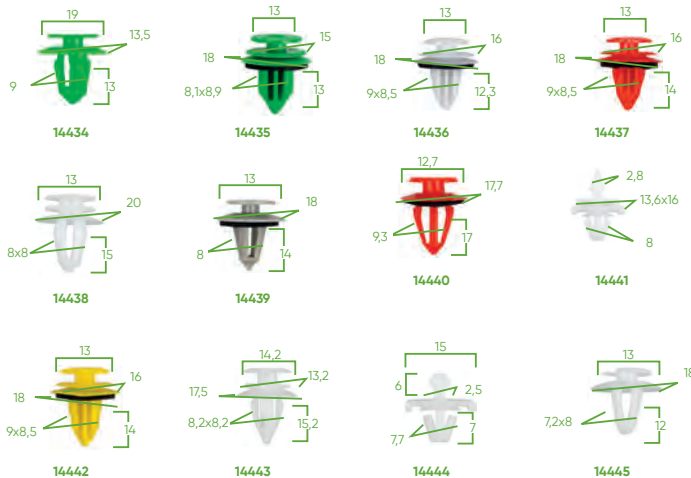

53716

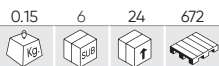

19,00€



KUNSTSTOFF-CLIPS BOX FÜR TÜRVERKLEIDUNG/RAHMEN/POLSTERUNG, VAG/SEAT/SKODA - 79 TEILE

REF.	BESCHREIBUNG	kg	Stk	€
14422	OE: A0009913940	6	6	1,50€
14423	OE: 6E0837732	15	15	3,55€
14424	-	7	7	1,85€
14425	OE: 6Q0868243	2	2	2,05€
14426	OE: 171201969	8	8	1,90€
14427	OE: 4D0807300	8	4	1,20€
14428	OE: 251823717	12	12	1,40€
14429	-	6	6	1,80€
14430	OE: 8E0821989A	3	3	2,25€
14431	OE: 3B0868243	2	2	1,45€
14432	OE: 1H0823171	10	10	1,45€

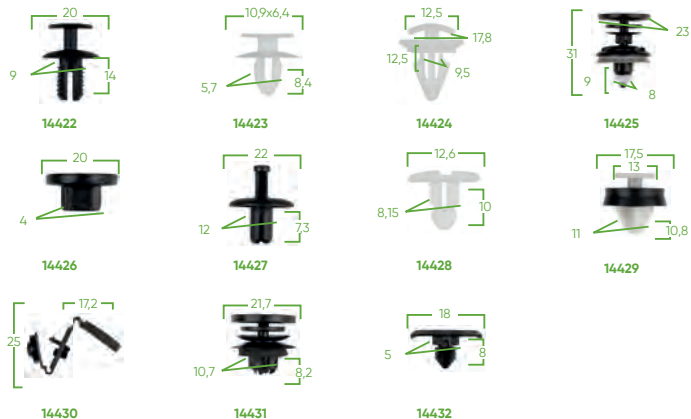

53715

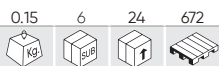

19,00€



KUNSTSTOFF-CLIPS BOX VERKLEIDUNG/POLSTERUNG, PEUGEOT/CITROËN - 110 TEILE

REF.	BESCHREIBUNG	kg	Stk	€
14410	-	10	10	1,85€
14411	-	10	5	1,70€
14412	-	10	10	1,70€
14413	-	10	10	3,25€
14414	OE: 2346824	10	10	1,70€
14415	OE: A1249900492	10	10	1,70€
14416	OE: 6992C6	10	5	1,25€
14419	-	15	15	1,95€
14420	-	15	15	1,50€
14421	OE: 14093311	10	10	2,45€



53714

16,00€

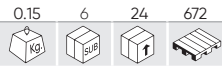

KUNSTSTOFF-CLIPS BOX FÜR VERKLEIDUNG/RAHMEN, PEUGEOT/CITROËN - 80 TEILE

REF.	BESCHREIBUNG	kg	Stk	€
14398	OE: 6995X3	8	8	1,30€
14399	OE: 129943	12	6	1,90€
14402	OE: 856548	8	8	1,50€
14404	OE: 71728806	8	8	2,10€
14405	OE: 968865987703	16	8	1,45€
14406	OE: 856540	10	10	1,55€
14408	OE: 856534	10	10	1,45€
14409	OE: 357853586	8	8	1,35€

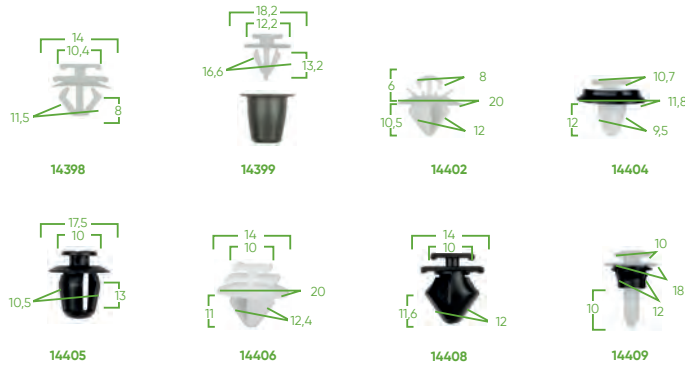

53713

16,00€

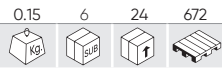

KUNSTSTOFF-CLIPS BOX FÜR TÜRVERKLEIDUNG PEUGEOT/CITROËN - 93 TEILE

REF.	BESCHREIBUNG	kg	Stk	€
14350	OE: 6991Y8	6	6	1,80€
14358	OE: PG 6991Y8 CT 6991Y8 FIAT 9654280780 RENAULT 703077469	10	10	1,70€
14387	-	8	8	1,45€
14388	OE: 7703077250	8	8	2,05€
14389	OE: 6995A3	6	6	1,25€
14390	-	6	6	1,35€
14391	-	15	15	2,15€
14392	-	6	6	1,35€
14393	-	8	8	1,50€
14395	-	8	8	1,65€
14396	-	6	6	1,20€
14397	-	6	6	1,45€

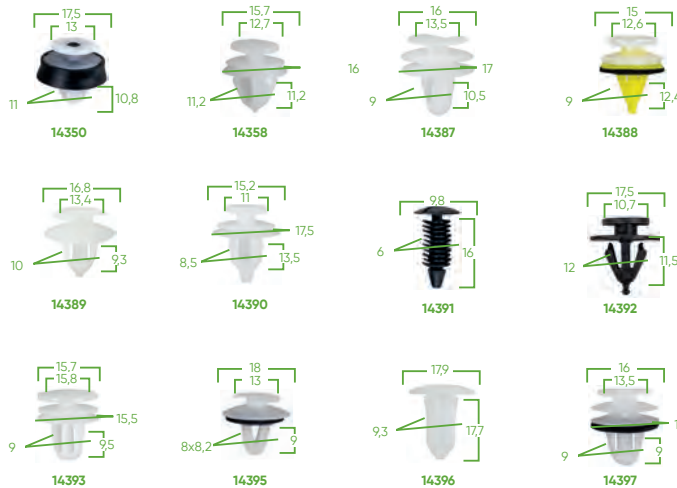

53712

16,00€

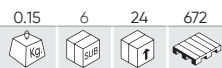

KUNSTSTOFF-CLIPS BOX FÜR VERKLEIDUNG/POLSTERUNG, RENAULT DACIA - 109 TEILE

REF.	BESCHREIBUNG	kg	Stk	€
14374	OE: 7703077435	3	3	1,70€
14375	-	15	15	1,85€
14376	OE: 7L6868307	20	20	2,60€
14377	-	10	10	1,90€
14378	OE: 7703077117	12	12	1,90€
14379	-	6	6	1,45€
14381	-	10	10	1,70€
14382	OE: 7703077153	6	6	1,85€
14383	OE: 7703072360	10	10	1,35€
14384	OE: W705956S300	12	12	2,10€
14416	OE: 6992C6	5	5	1,25€



53711

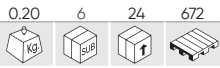

16,00€



KUNSTSTOFF-CLIPS BOX FÜR VERKLEIDUNG/RAHMEN RENAULT DACIA - 90 TEILE

REF.	BESCHREIBUNG		€
14356	OE: RENAULT 7703077368 OPEL 4430858	10 10	1,90€
14358	OE: PG 6991Y8 CT 6991Y8 FIAT 9654280780 RENAULT 703077469	12 10	1,70€
14364	OE: OP 7701470779 NI 7703077421 RENUALT 7703077421 IV 500326896	10 10	1,90€
14365	OE: OP 7701470779 NI 7703077421 RENUALT 7703077421 IV 500326896	10 10	1,90€
14366	OE: PG 6991Y8 CT 6991Y8 FIAT 9654280780 RENAULT 703077469	8 8	1,45€
14367	-	3 3	1,30€
14368	OE: 7L5853994	8 8	1,45€
14369	OE: 7701061797	15 15	4,95€
14370	-	3 3	3,00€
14371	-	3 3	3,00€
14372	-	4 4	1,20€
14373	-	4 4	1,35€



53710

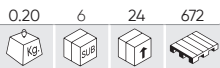

16,00€



KUNSTSTOFF-CLIPS BOX FÜR TÜRVERKLEIDUNG, RENAULT DACIA - 85 TEILE

REF.	BESCHREIBUNG		€
14350	OE: 6991Y8	12 6	1,80€
14351	-	8 15	1,65€
14352	OE: 51447780135	7 7	1,30€
14353	OE: 7703077476	8 2	2,10€
14355	OE: 7703077354	8 8	1,70€
14356	OE: RENAULT 703077368 OPEL 4430858	10 4	1,90€
14357	OE: 7703077430	10 12	1,90€
14358	OE: PG 6991Y8 CT 6991Y8 FIAT 9654280780 RENAULT 703077469	10 6	1,70€
14359	OE: 51418224768	4 3	1,05€
14361	-	8 15	1,70€

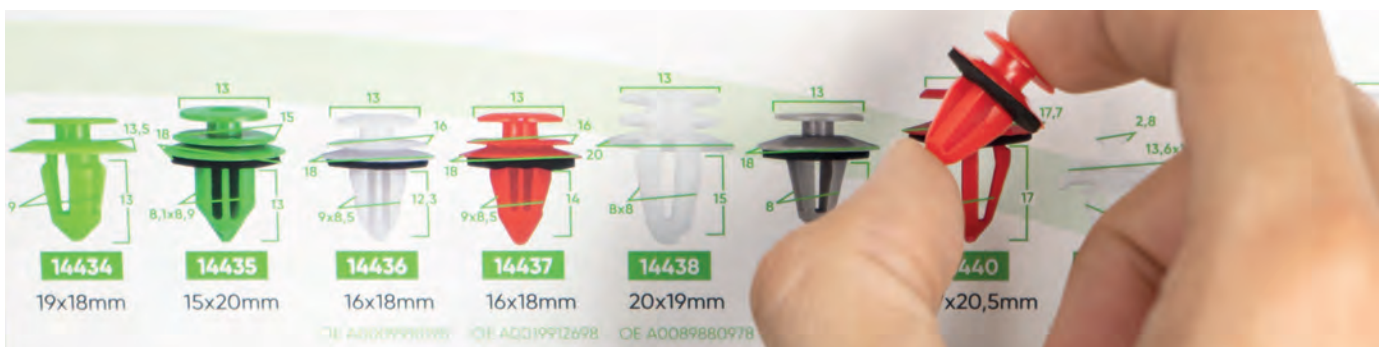
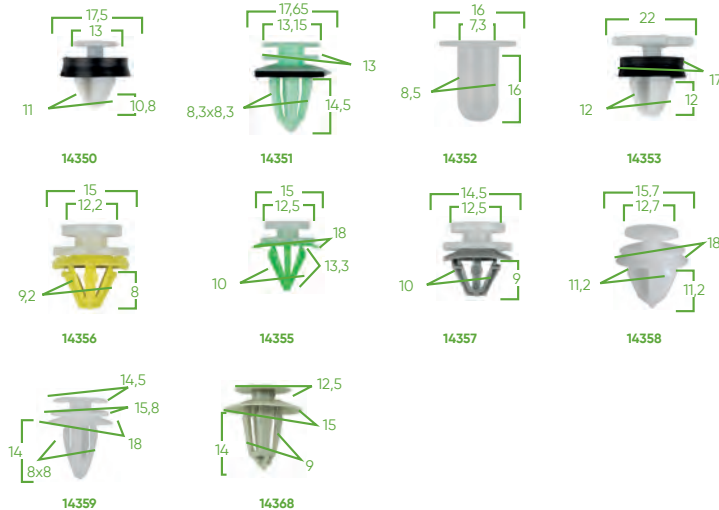

ARBEITSKLEIDUNG

406 WESTE

406 JACKEN

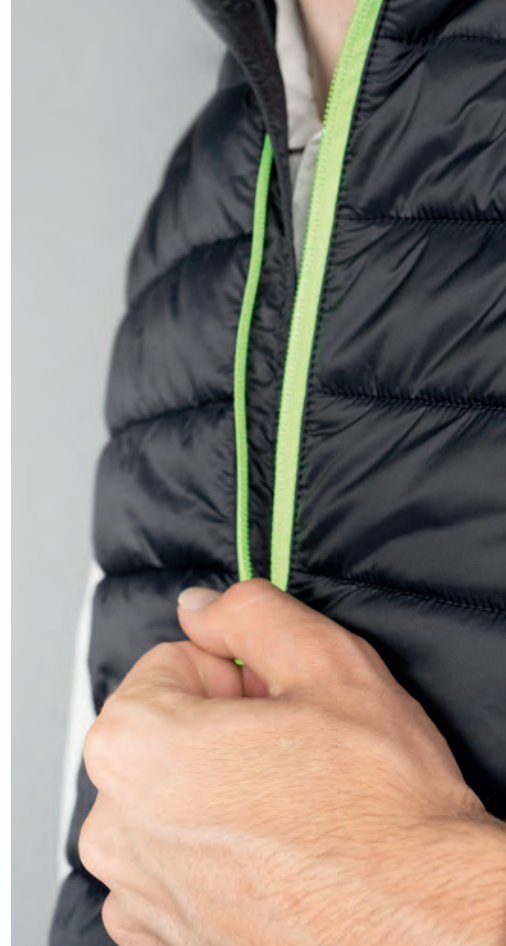



JBM WESTE



REF.		■	■	■	📦	📦	📦	🚚	€
70001	M	●			0.30	-	5	200	35,00€
70002	L	●			0.40	-	5	200	35,00€
70003	XL	●			0.40	-	5	200	35,00€
70009	XL		●		0.40	-	5	180	35,00€
70013	S		●		0.30	-	10	240	44,00€
70014	M		●		0.30	-	10	240	44,00€
70015	L		●		0.30	-	10	240	44,00€
70016	XL		●		0.35	-	10	240	44,00€
70017	XXL		●		0.35	-	10	200	44,00€

JBM JACKE



REF.		■	■	■	■	■	■	■	€
70004	M	●			0.60	-	5	140	42,00€
70005	L	●			0.70	-	5	140	42,00€
70006	XL	●			0.70	-	5	140	42,00€
70011	L		●		0.60	-	5	120	42,00€
70012	XL		●		0.70	-	5	120	42,00€

13929

3,45€



KLEIDERHAKEN 49 CM



METEXP

62,00€



STAND



WERBEMITTEL

408 WERBEARTIKEL

410 DISPLAYS / ZUBEHÖR

412 VERPACKUNGEN



53956

353,00€

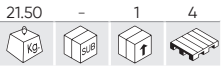

ROTIERENDER STUHL

ABMESSUNGEN: 70x55x126-136cm

VERSTELLBARE HÖHE

LENDENKISSEN

KOPFSTÜTZENKISSEN



Material: PU
 Stahlrahmenstärke: 1,2cm
 Sitz: Formschaumstoff
 Rückenlehne: Polyurethanschäum
 Armlehne: 2D
 Gaslift: Klasse 3
 Sohle Nylon: 350mm



54043

48,00€

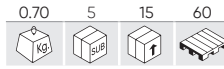

JBM RUCKSACK

Aufbewahrungsraum und Innenfächern: Dank zwei Fächern kann man unter anderem Laptops mit Diagonale bis zu 17,3 Zoll und Tablets aufbewahren.

Werkstoff: Polyurethan; wasserdichter, langlebiger und zuverlässiger Rucksack.

Leichtigkeit und Komfort: Handliche atmungsaktive Gitterkonstruktion des Rückens und die Gurtbänder aus Schwammmaterial.



53973

284,00€

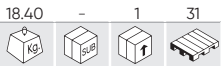

FALTBARES ZELT JBM 3X3M

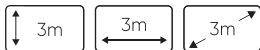

REF.	BESCHREIBUNG	Icon	Icon	Icon	Icon	€
14347	SCHUTZHÜLLE FÜR JBM-STAND	0.60	-	5	-	36,50€

15152

160,00€

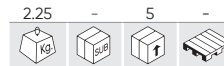

SEITENABDECKUNG FÜR JBM-DISPLAY REF. 53973

Besteht aus zwei Bestandteilen:
 - Seitenteil, der ¾ des Verdecks bedeckt.
 - Vorderteil, der ¼ des Verdecks bedeckt. Mit dem senkrechten Verschluss als Tür.



54325 22,50€

2.30 - 10 120

Kg SUB f

N

FUSSMATTE 100X65CM



54278 4,50€

0.10 5 200 1800

Kg SUB f

N

JBM KAPPE



54480 1,00€

0.00 500 2000 40000

Kg SUB f

N

JBM SCHLÜSSELKETTE



53949 4,50€

0.10 - 15 540

Kg SUB f

SCHWARZE JBM ICEBOX-TASCHE



53950 4,50€

0.10 - 15 630

Kg SUB f

GRÜNE JBM ICEBOX-TASCHE



13968 1,35€

0.01 50 200 2400

Kg SUB f

WERBE-TASCHE JBM



53533 1,50€

0.01 50 1000 12000

Kg SUB f

4-FARB-DRUCKKUGELSCHREIBER MIT JBM-FIRMENLOGO



54076 9,00€

0.50 - 50 700

Kg SUB f

KRUG JBM



WERBEMITTEL

53504

38,00€

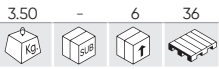

SCOOTER



14975

64,00€



SCHINKENHALTER



HAKEN

REF. FÜR	KG	BOX	UNIT	PALETTE	€
14034 DRUCKLUFT WERKZEUG	0.20	20	80	1920	9,00€
14623 REF. 60046, 60044, 60048, 60005, 60006	0.10	-	10	800	8,00€
14626 REF. 60023	0.10	-	10	-	7,00€
11318 EINZELSPITZE HAKEN	0.04	20	600	-	2,50€
16364 HAKEN MIT EINEM EINSATZ 280MM	0.20	-	200	-	3,50€
51315 HAKEN MIT GESCHLOSSENE SPITZE	0.02	20	320	44800	2,50€

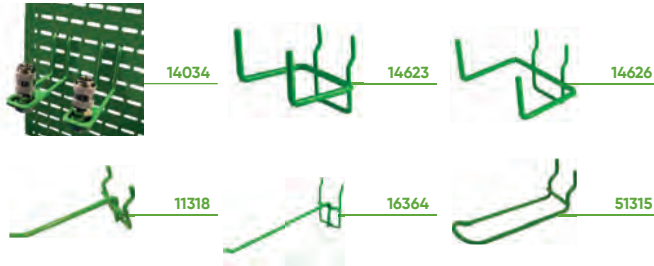

ABLAGEFACH

REF. FÜR	KG	BOX	UNIT	PALETTE	€
14622 REF. 60001, 60003, 60004, 60020	0.95	-	10	360	17,00€
14624 REF. 60007, 60010, 60011	0.65	-	10	300	17,00€
14625 REF. 60028, 60009	0.50	-	10	700	14,00€



53492

380,00€



WERKZEUG AUSSTELLUNGSTURM



WERKZEUG NICHT ENTHALTEN



METEXP

62,00€

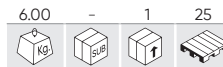

STAND



REF. BESCHREIBUNG	KG	BOX	UNIT	PALETTE	€
13929 KLEIDERHAKEN 49 CM	0.10	-	-	280	3,45€



53877 430,50€

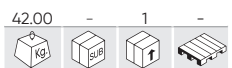

WERKZEUG AUSSTELLWAND

53878 574,00€

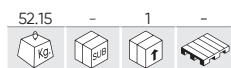

WERKZEUG-AUSSTELLUNGSSCHRANK + BELEUCHTUNG

53879 838,50€

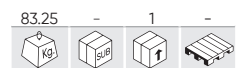

WERKZEUG-AUSSTELLUNGSSCHRANK MIT LICHT UND TÜREN



ENTHALTEN

14945	x1	11318
14346	x1	
14380	x1	
11318	x20	



ENTHALTEN

14945	x1	11318
14947	x1	
14380	x1	
11318	x20	



ENTHALTEN

14945	x1	11318
14947	x1	
14948	x1	
14996	x1	
11318	x20	



AUSSTELLER ZUBEHÖR

REF.	BESCHREIBUNG	KG	MB	CB	PL	€
14945	WERKZEUGSTAND-BASIS	37.80	-	1	15	303,50€
14946	KOPFTEIL FÜR WERKZEUGSTÄNDER	3.40	-	1	51	58,00€
14947	LEUCHTENAUFSATZ FÜR WERKZEUG-AUSSTELLUNGSSCHRANK	8.55	-	1	6	201,50€
14948	SATZ MIT ZWEI TÜREN FÜR DAS WERKZEUG-AUSSTELLUNGSSCHRANK	31.10	-	1	40	251,50€
14380	UNTERLAGE DES HALTERS DER WERKZEUGE 53877	5.00	-	1	34	51,00€
14996	ABLAGEFACH FÜR DAS AUSSTELLUNGSSCHRANK MIT TÜREN	5.00	-	1	33	65,00€

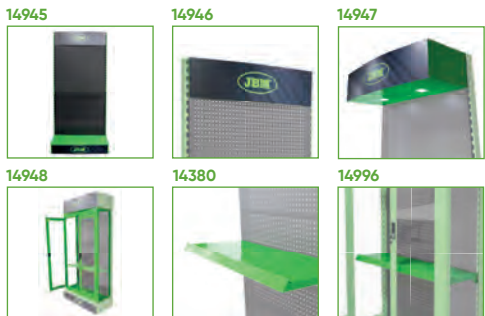

53914

75,00€

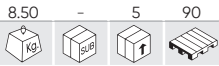

TRENNPFOSTEN MIT EINROLLBARES BAND

- Material: Stahl
- Rohrdurchmesser: 63 mm
- Fußdurchmesser: 320 mm
- Höhe: 910 mm
- Band in 4 Seiten
- Bandlänge: 3 m
- Bandbreite: 48 mm



14807

11,00€

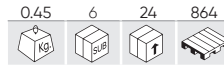

JBM-GARANTIESIEGEL



ALLE SPRACHEN IM SELBEN SIEGEL

- Breite 75 mm x Länge 125 m
- Polypropylen-Ausführung
- Klebstoff auf Basis des Lösungsmittels
- Dicke: 28 Mikrometer

Karton Box JBM

ERSATZTEILE BOX

REF. BESCHREIBUNG	Kg	Stk	Paletten	€
14922 BOX FÜR HANDWERKZEUGTEILE 14,5 X 9 X 10 CM	0.10	100	-	0,84€
14923 BOX FÜR HANDWERKZEUGTEILE 17,5 X 9 X 7 CM	0.10	100	-	0,84€
14924 BOX FÜR HANDWERKZEUGTEILE 24 X 11 X 7 CM	0.10	100	-	0,84€
14925 BOX FÜR HANDWERKZEUGTEILE 31,5 X 13 X 4 CM	0.10	100	-	0,84€
14926 BOX FÜR HANDWERKZEUGTEILE 32 X 8,5 X 7 CM	0.10	100	-	1,05€



WERBE-BOX

REF. BESCHREIBUNG	Kg	Stk	Paletten	€
13717 JBM SCHINKENBOX 76X14X29CM	0.90	1	200	7,65€
14083 GRÜNER KARTON PROMO 80X28X49CM	1.80	1	100	13,20€
14976 WERBEKARTON, 80X31X61 CM	2.20	1	80	18,84€
15056 WERBEKARTON, 40X30X61 CM	1.60	1	70	11,70€



KARTON BOX JBM

REF. BESCHREIBUNG	Kg	Stk	Paletten	€
11330 JBM KLEINER KARTON 19X10X11CM (GELENKMANSCHETTENSATZ)	0.05	50	4200	0,57€
12950 JBM-KARTON 60X40X30CM	0.80	15	75	3,45€
12952 JBM-KARTON 40X30X20CM	0.40	20	240	1,92€
13217 JBM-KARTON 57X30X25CM (NOTFALLAUSRÜSTUNG)	0.55	15	150	1,31€
14974 JBM-KARTON 54X24X40CM (20 GELENKSTIEFEL-SETS)	0.65	20	240	2,28€
15051 KARTON 40X32X30 CM	0.40	20	160	1,92€
14189 AMERIKANISCHE PALETTENBOX MIT DREIFACHKANAL	10.00	1	40	52,00€
14507 EUROPÄISCHE PALETTENBOX	8.00	1	40	50,00€



MARKIERUNG

LOGISTIK



GEWICHT IN KILOGRAMM



MENGE FÜR INNENKARTON



MENGE PRO KARTON



MENGE PRO PALETTE



MENGE PRO BEUTEL



MENGE PRO SET



PRÄSENTATION IM DISPLAY

ALLGEMEINES



ANZAHL DER TEILE



DARSTELLUNG IM BLISTER



MAGNETISCH



TAKTIL



AKKU-LADEKAPAZITÄT



LADEDAUER



ERGONOMISCHER GRIFF



NICHT WASCHBAR



SCHUTZ VOR REGEN UND FEUCHTIGKEIT



RECYCELBARES PRODUKT



INFORMATIONEN



KABELLOS



ELEKTRISCHES AUTO



HOCHSPANNUNGSSCHILDER



EUROPÄISCHE REGELUNG



AMERIKANISCHE REGELUNG

UNIVERSAL

UNIVERSELLE REGELUNG

MASSEINHEITEN



LÄNGE



MASSE



DURCHMESSER



SONSTIGES



KAPAZITÄT



ZOLL



MAXIMUM - MINIMUM



GRAD



BEREICH



CELSIUS GRAD



TON

MASSEINHEITEN FÜR BESTIMMTE ARTIKEL



SCHEIBENDURCHMESSER



LOCHDURCHMESSER DER SCHEIBE IN "



ROHRDURCHMESSER



INNERER UND ÄUSSERER ROHRDURCHMESSER



SCHLAUHLÄNGE



STECKERLÄNGE

MATERIAL



HOLZ



STAHL



STAHL S2



ALUMINIUM



KUPFER



CHROMIERT



CHROM-VANADIUM



CHROM-MOLYBDÄN



NEODYMIUM



ZINN



VINYL-POLYCHLORID



POLYPROPYLEN



POLYETHYLEN



POLYETHYLEN HOHER DICHT



STAHL LAMINIERT



MESSING



LATEX



NYLON



HYDRIERTER NITRIL-BUTADIEN-KAUTSCHUK

SIE KÖNNEN AUCH FINDEN



ZIEGELN



HOLZ























STAHL

TECHNISCHE SPEZIFIKATIONEN

HANDWERKZEUGE





BITS

 SCHLITZBITS	 PHILIPS BITS	 POZIDRIV BITS	 TORQ BITS
 RIBE BITS	 VIERZACK-BIT	 DREIZEHNBIT	 ALLEN BIT
 TORX-BIT	 12-PUNKTE-BIT	 QUADRAT-BIT	 FÜNFZACKIGER TORX-BIT
 SPLINE-PUNKT	 SCHMETTERLING-BIT	 MANIPULATIONSSICHERER INBUS-BIT	 MANIPULATIONSSICHERER TORX-BIT
 12-ZACKIGER MANIPULATIONSSICHERER BIT	 MANIPULATIONSSICHERER VIERKANT-BIT	 MANIPULATIONSSICHERER FÜNFPUNKT-TORX-BIT	 UNVERLETZLICHER SPLINE-PUNKT
 TENSOR-BIT			

STECKDOSEN

 SECHSKANT-STECKDOSE	 TORX-STECKDOSE	 12-PUNKT-STECKDOSE	 QUADRATSTECKDOSE
 5-PUNKT-STECKDOSE	 STECKSOCKEL	 MANIPULATIONSSICHERE INNENSECHSSTECKDOSE	 MANIPULATIONSSICHERE TORX-STECKDOSE
 MANIPULATIONSSICHERE 12-FACH STECKDOSE	 MANIPULATIONSSICHERE VIERKANTSTECKDOSE	 MANIPULATIONSSICHERE FÜNFPUNKTSTECKDOSE	 MANIPULATIONSSICHERER STECKSOCKEL

SCHLÜSSEL

 SECHSKANTSCHLÜSSEL	 TORX SCHLÜSSEL	 ZWÖLFKANTSCHLÜSSEL	 QUADRATSCHLÜSSEL
 FÜNFZACKIGER SCHLÜSSEL			







RATSCHETTE

 24 ZÄHNE	 72 ZÄHNE	 90 ZÄHNE
--	--	--

ELEKTRISCHE WERKZEUGE

 WATS	 VATIUMS	 HERTZ	 KILOVATIUM
 AMPERE	 WECHSELSTROM	 DIREKTSTROM	 ELEKTRISCHER WIDERSTAND
 LITHIUM-IONEN-BATTERIE	 MICROUSB USB	 ANZÜNDERSTECKER	

DRUCKLUFTWERKZEUGE

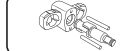
 PFUND FÜR QUADRATZOLL (DRUCK)	 DRUCK EINHEIT	 KUBIKFUSS PRO MINUTE (DURCHFLUSS)	 PFERDESTÄRKEN (LEISTUNG)
 ALLGEMEINE UMDREHUNGEN PRO MINUTE	 RÜCKWÄRTSUMDREHUNGEN PRO MINUTE	 VORWÄRTSUMDREHUNGEN PRO MINUTE	 MAXIMALE NEWTON PRO METER
 NEWTON PRO METER	 IMPULSE PRO MINUTE	 KILOPASCAL	 MEGAPASCAL
 HOHE LUFTMENGE UND NIEDRIGER DRUCK	 HINTEN-AUSGANG	 AN SCHLAUCH ANSCHLIESSBAR	 LUFT-EINTRITT 1/4"
 GESCHWINDIGKEITSKAPAZITÄT	 JUMBO-HAMMER-SYSTEM	 DOPPELHAMMER-MECHANISMUS	

REFERENZNUMMERN INDEX

REF.	SEITE	PREIS
10000	305	7,00 €
10054	232	2,90 €
10055	232	3,90 €
10264	53	2,00 €
10485	231	8,10 €
10486	231	8,00 €
10494	231	6,50 €
10495	231	3,00 €
10496	231	3,00 €
10497	231	3,00 €
10498	231	3,00 €
10499	231	3,00 €
10500	231	3,00 €
10501	231	8,10 €
10502	231	3,50 €
10526	57	10,00 €
10531	41	3,00 €
10532	41	2,70 €
10533	41	3,00 €
10534	41	3,25 €
10535	41	3,50 €
10536	41	3,65 €
10537	41	3,90 €
10538	41	4,30 €
10539	41	4,75 €
10540	41	5,25 €
10541	41	5,55 €
10542	41	5,85 €
10543	41	7,00 €
10544	41	8,10 €
10545	41	9,75 €
10546	41	11,60 €
10547	41	13,50 €
10548	41	1,75 €
10549	41	2,00 €
10550	41	2,15 €
10551	41	2,15 €
10552	38	7,10 €
10553	38	7,35 €
10554	38	7,50 €
10555	38	7,80 €
10556	38	8,10 €
10557	38	8,10 €
10558	38	9,35 €
10559	38	9,50 €
10560	38	10,60 €
10561	38	11,00 €
10562	38	12,30 €
10563	38	12,50 €
10564	42	2,50 €
10565	42	3,50 €
10566	42	3,50 €
10567	42	3,50 €

REF.	SEITE	PREIS
10568	42	4,00 €
10569	42	4,50 €
10570	42	4,50 €
10571	42	5,00 €
10579	42	3,00 €
10580	42	3,10 €
10581	42	3,40 €
10582	42	4,00 €
10583	42	4,15 €
10584	42	5,05 €
10585	42	6,75 €
10586	42	7,60 €
10587	42	9,80 €
10588	42	10,50 €
10589	42	2,00 €
10590	42	2,40 €
10591	44	2,50 €
10592	44	2,55 €
10593	44	3,15 €
10594	44	3,20 €
10595	44	3,35 €
10596	44	4,25 €
10597	44	4,50 €
10598	44	4,60 €
10599	44	6,00 €
10600	44	6,25 €
10601	44	6,50 €
10602	44	7,05 €
10603	44	2,10 €
10604	44	2,25 €
10617	46	14,10 €
10618	46	15,10 €
10619	46	15,70 €
10620	46	16,20 €
10621	46	9,50 €
10622	46	10,00 €
10623	46	12,60 €
10624	46	13,50 €
10625	46	15,70 €
10626	46	17,80 €
10627	44	2,80 €
10628	44	3,10 €
10629	44	3,65 €
10630	44	3,90 €
10631	44	4,20 €
10632	44	5,30 €
10633	44	6,60 €
10634	44	7,80 €
10635	44	8,15 €
10636	44	8,80 €
10637	44	12,10 €
10638	44	12,70 €
10642	57	10,00 €

REF.	SEITE	PREIS
10643	57	10,00 €
10644	57	10,00 €
10672	242	9,50 €
10673	242	9,50 €
10674	242	9,50 €
10675	242	9,50 €
10732	89	18,70 €
10735	89	20,30 €
10750	139	13,00 €
10751	139	15,00 €
10766	139, 357	1,59 €
10772	386	0,05 €
10773	386	0,10 €
10774	386	0,10 €
10775	386	0,15 €
10776	386	0,20 €
10777	386	0,20 €
10778	386	0,35 €
10779	385, 386	0,05 €
10780	385, 386	0,05 €
10781	385, 386	0,05 €
10782	386	0,05 €
10783	386	0,05 €
10784	385, 386	0,05 €
10785	385, 386	0,10 €
10786	385, 386	0,15 €
10787	386	0,05 €
10788	386	0,05 €
10789	386	0,05 €
10790	386	0,05 €
10791	386	0,05 €
10792	386	0,05 €
10793	382	0,25 €
10794	382	0,40 €
10795	382	0,60 €
10796	382	0,07 €
10797	382	0,09 €
10798	382	0,12 €
10799	382	0,13 €
10800	382	0,15 €
10801	382	0,17 €
10802	382	0,19 €
10803	382	0,05 €
10804	382	0,22 €
10805	385	0,10 €
10812	385	0,30 €
10813	385	0,30 €
10823	388	0,20 €
10824	388	0,20 €
10825	388	0,20 €
10826	388	0,40 €
10827	388	0,60 €
10828	388	0,45 €

REF.	SEITE	PREIS
10829	388	0,20 €
10830	388	0,20 €
10831	388	0,20 €
10832	388	0,20 €
10833	388	0,20 €
10834	388	0,25 €
10835	388	0,25 €
10836	388	0,30 €
10837	388	0,30 €
10838	388	0,30 €
10839	388	0,40 €
10840	388	0,35 €
10868	390	0,30 €
10869	390	0,30 €
10870	390	0,45 €
10871	390	0,30 €
10872	390	0,40 €
10873	390	0,45 €
10874	390	0,30 €
10875	390	0,40 €
10876	390	0,45 €
10877	384	0,25 €
10878	384	0,30 €
10879	384	0,20 €
10880	384	0,20 €
10881	384	0,25 €
10882	382	0,25 €
10883	382	0,25 €
10884	382	0,25 €
10885	394	0,20 €
10886	394	0,20 €
10887	394	0,25 €
10888	394	0,30 €
10889	394	0,30 €
10890	394	0,35 €
10891	394	0,25 €
10892	394	0,30 €
10893	394	0,25 €
10894	394	0,20 €
10895	394	0,20 €
10896	394	0,30 €
10897	394	0,30 €
10898	394	0,30 €
10899	394	0,30 €
10900	394	0,30 €
10901	394	0,25 €
10902	394	0,30 €
10905	394	0,25 €
10906	394	0,25 €
10907	394	0,25 €
10908	394	0,30 €
10909	394	0,30 €
10910	394	0,30 €

REF.	SEITE	PREIS
10911	394	0,30 €
10912	394	0,25 €
10913	394	0,30 €
10914	394	0,25 €
10915	393, 394	0,25 €
10916	394	0,30 €
10917	393, 394	0,30 €
10918	393, 394	0,30 €
10919	393, 394	0,30 €
10920	393, 394	0,25 €
10921	393, 394	0,30 €
10923	134	1,10 €
10953	229	12,50 €
10955	200	11,00 €
10961	144	13,00 €
10964	190, 350	9,00 €
10965	190, 350	6,00 €
10966	190, 350	13,50 €
11103	139	6,00 €
11106	202	3,00 €
11107	144	4,50 €
11121	168, 169, 176	4,10 €
11122	168, 169, 176	5,45 €
11123	168, 176	6,50 €
11124	176	7,65 €
11125	176	8,50 €
11126	176	11,20 €
11127	176	13,80 €
11128	176	14,10 €
11129	176	14,10 €
11130	176	13,10 €
11131	176	14,10 €
11132	176	13,70 €
11133	176	12,00 €
11134	176	15,00 €
11135	176	17,20 €
11136	176	15,30 €
11137	176	18,20 €
11138	176	18,00 €
11139	176	18,80 €
11140	176	20,40 €
11141	176	18,60 €
11142	176	21,30 €
11143	176	26,40 €
11144	176	33,30 €
11145	176	35,30 €
11146	176	37,30 €
11147	176	41,00 €
11148	176	47,00 €
11149	176	45,00 €
11150	176	55,00 €
11151	176	57,00 €
11152	176	57,00 €
11153	172, 176	23,40 €
11154	176	21,70 €
11155	172, 176	24,40 €

REF.	SEITE	PREIS
11156	176	28,90 €
11157	176	26,60 €
11158	172, 176	28,50 €
11159	176	30,30 €
11160	176	27,00 €
11161	176	32,30 €
11162	176	29,10 €
11163	176	32,70 €
11164	176	30,70 €
11165	176	34,60 €
11166	176	30,90 €
11167	176	38,00 €
11168	176	41,00 €
11169	176	39,20 €
11170	176	40,00 €
11171	176	51,00 €
11172	176	48,00 €
11173	176	47,00 €
11174	176	47,00 €
11175	176	49,00 €
11176	176	56,00 €
11177	176	55,00 €
11178	176	53,00 €
11179	176	65,00 €
11180	176	59,00 €
11181	176	65,00 €
11182	176	73,00 €
11183	176	70,00 €
11184	176	87,00 €
11185	176	97,00 €
11186	176	91,00 €
11187	176	98,00 €
11188	176	103,00 €
11189	176	121,00 €
11190	176	138,00 €
11191	176	149,00 €
11192	176	152,00 €
11193	176	183,00 €
11194	176	176,00 €
11195	168, 169, 176	3,70 €
11212	63	5,00 €
11213	63	10,60 €
11214	63	12,50 €
11244	45	8,50 €
11245	45	9,15 €
11246	45	12,40 €
11247	45	14,00 €
11248	45	14,60 €
11249	45	26,50 €
11258	43	7,30 €
11259	43	8,30 €
11260	43	9,75 €
11261	43	11,35 €
11262	43	13,50 €
11314	173	8,50 €
11315	173	8,50 €
11316	173	8,50 €

REF.	SEITE	PREIS
11318	410	2,50 €
11324	139	17,50 €
11325	139	17,50 €
11328	355	4,00 €
11330	412	0,57 €
11360	32	2,60 €
11361	32	3,20 €
11362	32	5,20 €
11363	32	3,90 €
11364	32	4,50 €
11365	32	9,40 €
11374	200	5,50 €
11375	200	6,50 €
11376	200	5,50 €
11377	200	5,50 €
11378	200	6,50 €
11379	200	6,00 €
11380	200	6,50 €
11381	200	6,50 €
11382	200	6,00 €
11383	200	6,00 €
11384	200	6,00 €
11385	200	5,50 €
11386	200	6,00 €
11387	200	6,00 €
11388	200	6,00 €
11389	200	6,00 €
11390	200	6,00 €
11391	200	6,50 €
11392	200	6,00 €
11393	200	6,00 €
11394	200	6,00 €
11434	226	12,00 €
11435	226	12,00 €
11436	226	12,00 €
11437	226	12,00 €
11438	226	12,00 €
11439	226	12,00 €
11440	226	12,00 €
11441	226	12,00 €
11442	226	12,00 €
11443	227	14,00 €
11444	227	14,00 €
11445	227	15,00 €
11446	227	15,00 €
11447	227	15,50 €
11450	226	12,00 €
11541	180	11,00 €
11542	180	11,00 €
11543	180	11,00 €
11544	180	7,00 €
11545	180	11,00 €
11546	180	12,00 €
11547	180	12,00 €
11613	176	11,00 €
11614	176	13,00 €
11615	176	14,20 €

REF.	SEITE	PREIS
11616	176	18,10 €
11617	176	18,70 €
11618	176	18,80 €
11619	176	19,50 €
11621	176	290,00 €
11622	176	399,00 €
11623	176	489,00 €
11624	176	189,00 €
11625	176	282,00 €
11628	173	9,50 €
11639	43	4,00 €
11640	43	4,50 €
11641	43	5,00 €
11642	43	5,00 €
11643	43	6,00 €
11644	43	7,00 €
11645	43	7,00 €
11646	43	9,45 €
11867	308	9,00 €
11878	214	4,10 €
11879	214	5,10 €
11880	214	10,50 €
11890	359	0,55 €
11891	359	0,50 €
11893	211	7,00 €
11894	211	7,00 €
11895	211	8,65 €
11896	211	8,80 €
11897	190, 351	155,00 €
11900	370	3,50 €
11901	370	2,50 €
11902	370	3,50 €
11903	370	5,00 €
11904	370	2,00 €
11905	370	1,50 €
11906	370	8,50 €
11907	370	11,00 €
11936	202	4,00 €
11937	202	5,00 €
11938	174	47,00 €
11945	53	7,00 €
11946	53	4,50 €
11947	53	19,00 €
11956	152	5,50 €
11957	152	5,50 €
11959	189	10,50 €
11960	369, 370	1,50 €
11962	32, 168, 169, 175	7,50 €
11963	175	9,00 €
11964	32, 175	12,50 €
11965	175	16,00 €
11966	175	18,00 €
11967	175	18,00 €
11971	99	3,60 €
11974	339	1,80 €
11975	339	1,80 €
11976	339	1,80 €

REF.	SEITE	PREIS
11977	339	1,80 €
11978	339	1,80 €
11979	339	1,80 €
11980	339	1,80 €
11981	339	1,80 €
11982	339	1,80 €
11983	339	1,80 €
11989	144	2,00 €
11990	168, 169, 174	15,30 €
11994	89	33,00 €
11996	88	48,00 €
11997	88	39,00 €
11998	88	49,00 €
12009	162	11,00 €
12022	188	33,70 €
12029	35	5,50 €
12030	35	6,50 €
12044	305	147,00 €
12055	351	20,00 €
12060	64	2,50 €
12061	169, 170, 176	9,50 €
12062	169, 170, 176	9,50 €
12063	169, 170, 176	9,50 €
12064	169, 176	9,00 €
12065	169, 170, 176	9,00 €
12066	169, 170, 172, 176	9,00 €
12067	169, 176	9,50 €
12068	169, 170, 172, 176	9,50 €
12069	169, 170, 172, 176	9,50 €
12070	169, 170, 176	10,50 €
12071	169, 170, 176	11,00 €
12072	169, 176	12,00 €
12074	169, 174	11,50 €
12075	168, 169, 174	15,50 €
12093	226	12,00 €
12200	219	14,50 €
12901	207	5,20 €
12926	241	21,50 €
12927	241	21,50 €
12928	241	22,00 €
12929	241	23,00 €
12930	241	23,50 €
12931	171	7,50 €
12932	171	7,50 €
12933	171	8,00 €
12934	171	7,50 €
12935	171	8,00 €
12936	171	8,50 €
12937	168, 169, 174	9,50 €
12938	171	10,00 €
12939	171	10,00 €
12940	171	10,00 €
12941	171	10,00 €

REF.	SEITE	PREIS
12942	171	10,00 €
12943	171	10,00 €
12944	171	10,00 €
12945	171	10,50 €
12950	412	3,45 €
12952	412	1,92 €
12954	394	0,25 €
12955	180	27,80 €
12956	180	27,80 €
12957	180	27,80 €
12958	180	27,80 €
12959	180	27,80 €
12960	180	27,80 €
12961	180	27,80 €
12973	370	1,00 €
12974	196	21,00 €
12975	196	23,00 €
12977	221	36,50 €
12984	176	379,00 €
12987	152	1,50 €
12988	166	12,00 €
12995	53	7,00 €
12996	53	7,00 €
12997	53	7,50 €
12998	53	9,00 €
12999	53	9,50 €
13002	396	1,45 €
13003	396	1,70 €
13004	396	1,85 €
13005	396	1,25 €
13006	396	1,40 €
13007	396	1,30 €
13008	396	2,25 €
13009	396	1,65 €
13010	396	1,75 €
13011	396	1,15 €
13012	396	1,80 €
13013	396	1,75 €
13014	396	1,45 €
13015	396	1,20 €
13016	396	1,15 €
13017	396	2,60 €
13018	396	1,45 €
13019	396	1,75 €
13020	396	1,70 €
13021	396	1,30 €
13022	396	2,10 €
13023	396	1,50 €
13024	396	2,45 €
13025	396	1,50 €
13026	400	1,55 €
13027	400	1,85 €
13028	400	1,45 €
13029	400	1,65 €
13030	400	2,80 €
13031	400	1,85 €
13032	400	2,00 €

REF.	SEITE	PREIS
13033	400	1,60 €
13034	400	2,65 €
13035	400	1,65 €
13036	400	1,40 €
13037	400	2,10 €
13038	398	1,40 €
13039	398	1,65 €
13040	398	1,80 €
13041	398	1,55 €
13042	398	1,95 €
13043	398	1,20 €
13044	398	1,55 €
13045	398	1,20 €
13046	398	1,55 €
13047	398	1,45 €
13048	398	2,20 €
13049	398	2,05 €
13050	399	1,55 €
13051	399	1,50 €
13052	399	1,25 €
13053	399	2,80 €
13054	399	2,35 €
13055	399	3,00 €
13056	398	1,55 €
13057	398	1,50 €
13058	398	2,20 €
13059	398	2,35 €
13060	398	1,60 €
13061	398	2,65 €
13062	398	2,35 €
13063	398	1,15 €
13064	398	2,60 €
13065	398	2,00 €
13066	398	2,25 €
13067	398	2,55 €
13068	399	2,85 €
13069	399	4,55 €
13070	399	2,15 €
13071	399	2,05 €
13072	399	2,75 €
13073	399	2,10 €
13074	400	4,65 €
13075	400	5,35 €
13076	400	3,90 €
13077	400	2,55 €
13078	400	2,55 €
13079	400	3,35 €
13080	398	1,75 €
13081	398	2,30 €
13082	398	1,35 €
13083	398	1,50 €
13084	398	2,10 €
13085	398	1,60 €
13086	398	1,25 €
13087	398	3,30 €
13088	398	2,40 €
13089	398	1,70 €

REF.	SEITE	PREIS
13090	398	1,70 €
13091	398	1,25 €
13092	400	1,65 €
13093	400	2,95 €
13094	400	1,50 €
13095	400	1,20 €
13096	400	1,70 €
13097	400	1,20 €
13098	400	1,65 €
13099	400	2,75 €
13100	400	1,20 €
13101	400	1,50 €
13102	400	1,60 €
13103	400	1,80 €
13104	396	1,90 €
13105	396	2,50 €
13106	396	2,00 €
13107	396	2,15 €
13108	396	1,90 €
13109	396	2,90 €
13110	396	1,85 €
13111	396	1,20 €
13112	396	1,65 €
13113	396	2,20 €
13114	396	2,20 €
13115	396	2,50 €
13116	399	5,45 €
13117	399	3,65 €
13118	399	15,90 €
13119	399	5,60 €
13120	399	5,50 €
13121	399	8,75 €
13122	399	1,95 €
13123	399	5,35 €
13124	399	8,20 €
13125	399	5,95 €
13126	399	1,55 €
13127	399	5,60 €
13128	397	1,85 €
13129	397	2,00 €
13130	397	3,75 €
13131	397	3,45 €
13132	397	2,65 €
13133	397	3,45 €
13134	397	3,95 €
13135	397	3,45 €
13136	397	2,60 €
13137	397	2,25 €
13138	397	2,85 €
13139	397	3,85 €
13140	397	2,65 €
13141	397	1,80 €
13142	397	3,10 €
13143	397	1,95 €
13144	397	2,20 €
13145	397	3,85 €
13146	397	4,50 €

REF.	SEITE	PREIS
13147	397	3,10 €
13148	397	3,30 €
13149	397	3,10 €
13150	397	2,25 €
13151	397	5,35 €
13152	397	3,05 €
13153	397	3,10 €
13154	397	3,20 €
13155	397	5,60 €
13156	397	3,30 €
13157	397	3,85 €
13158	397	3,75 €
13159	397	3,20 €
13160	397	5,00 €
13161	397	3,55 €
13162	397	2,60 €
13163	397	2,80 €
13217	412	1,31 €
13226	67	4,50 €
13227	67	4,50 €
13228	67	4,50 €
13229	67	4,50 €
13230	67	4,50 €
13231	67	4,50 €
13232	67	4,50 €
13234	305	224,50 €
13235	384	0,15 €
13236	384	0,15 €
13237	384	0,15 €
13238	384	0,20 €
13239	384	0,20 €
13240	384	0,40 €
13241	384	0,55 €
13447	40	16,50 €
13448	40	17,50 €
13449	40	20,00 €
13450	40	23,00 €
13451	40	28,00 €
13452	40	29,50 €
13453	39	9,00 €
13454	39	9,50 €
13455	39	10,50 €
13456	39	11,50 €
13457	39	12,00 €
13460	39	15,00 €
13462	39	17,00 €
13463	40	5,30 €
13464	40	5,30 €
13465	38, 39, 40	5,55 €
13466	38, 39, 40	5,55 €
13467	38, 39, 40	6,00 €
13468	38, 39, 40	6,25 €
13469	38, 39, 40	6,25 €
13470	38, 39, 40	6,60 €
13471	38, 39, 40	6,90 €
13472	38, 39, 40	7,25 €
13473	38, 39, 40	8,10 €

REF.	SEITE	PREIS
13474	38, 39, 40	8,70 €
13475	38, 39, 40	9,10 €
13476	38, 39, 40	9,60 €
13477	40	9,85 €
13478	40	12,20 €
13479	40	13,10 €
13480	40	15,50 €
13481	40	15,80 €
13482	40	22,10 €
13483	40	25,50 €
13484	40	27,20 €
13491	40	5,30 €
13492	40	5,35 €
13493	40	5,50 €
13494	40	6,00 €
13495	40	6,40 €
13496	40	6,60 €
13497	40	7,50 €
13498	40	8,50 €
13499	162	12,50 €
13500	162	12,90 €
13667	66, 89	17,60 €
13668	88	18,70 €
13674	68, 383	0,50 €
13675	68, 383	0,50 €
13676	68, 383	0,50 €
13677	68, 383	0,50 €
13678	68, 383	0,50 €
13680	174	15,50 €
13681	174	15,50 €
13682	174	15,50 €
13683	174	15,50 €
13684	174	15,50 €
13685	174	15,50 €
13686	174	15,50 €
13687	174	15,50 €
13688	174	15,50 €
13689	174	15,50 €
13704	69	21,00 €
13707	59	14,00 €
13708	59	14,00 €
13709	59	14,00 €
13710	59	14,00 €
13712	59	14,00 €
13717	412	7,65 €
13723	176	18,50 €
13724	176	19,20 €
13725	176	19,20 €
13726	176	19,00 €
13727	176	18,70 €
13728	176	18,50 €
13729	176	22,00 €
13730	176	22,00 €
13731	176	21,60 €
13732	176	23,80 €
13733	176	24,90 €
13734	176	25,70 €

REF.	SEITE	PREIS
13735	176	25,80 €
13736	176	25,90 €
13738	360	3,50 €
13739	360	5,50 €
13740	360	5,50 €
13741	372	21,00 €
13745	176	25,20 €
13746	176	25,40 €
13747	176	25,40 €
13748	176	24,90 €
13805	370	10,50 €
13806	370	10,50 €
13809	166	18,50 €
13810	166	20,50 €
13813	185	7,00 €
13814	185	11,00 €
13817	151	17,00 €
13818	151	20,50 €
13819	388	6,50 €
13820	388	7,00 €
13821	388	14,00 €
13822	388	11,00 €
13823	388	6,00 €
13824	388	8,00 €
13825	388	11,50 €
13826	388	13,00 €
13827	388	15,00 €
13828	388	11,50 €
13829	388	10,50 €
13830	388	10,50 €
13831	388	12,60 €
13832	388	13,00 €
13833	388	9,00 €
13839	144	8,50 €
13842	180	8,50 €
13843	180	7,00 €
13844	180	9,00 €
13845	180	8,00 €
13856	202	7,80 €
13859	172	16,00 €
13874	172	17,50 €
13875	172	18,50 €
13876	172	18,50 €
13877	172	18,50 €
13879	360	1,38 €
13880	360	1,50 €
13923	89	7,45 €
13929	406, 410	3,45 €
13930	165	1,50 €
13931	165	2,50 €
13932	165	2,50 €
13933	165	2,00 €
13934	165	2,50 €
13935	165	2,50 €
13936	165	3,50 €
13937	165	4,00 €
13938	165	3,50 €

REF.	SEITE	PREIS
13939	165	4,00 €
13945	387	7,40 €
13946	387	6,70 €
13947	387	5,85 €
13948	387	5,00 €
13949	387	6,50 €
13950	387	7,80 €
13951	387	5,15 €
13952	387	10,90 €
13953	387	8,00 €
13954	387	12,70 €
13955	387	4,95 €
13956	387	4,30 €
13957	387	9,70 €
13958	387	5,45 €
13959	387	10,10 €
13960	387	9,65 €
13961	387	9,25 €
13962	387	1,76 €
13963	387	12,40 €
13964	387	15,00 €
13965	387	1,50 €
13966	387	12,90 €
13967	387	4,65 €
13968	409	1,35 €
13969	204	19,00 €
13982	303	4,00 €
14004	171	9,50 €
14005	171	10,50 €
14006	171	9,50 €
14007	171	9,50 €
14008	171	9,50 €
14009	171	9,50 €
14010	171	11,00 €
14011	171	11,00 €
14013	152	3,50 €
14026	53	5,50 €
14027	53	5,60 €
14029	53	8,50 €
14030	53	9,50 €
14031	131, 144	7,90 €
14032	144	12,00 €
14033	144	4,50 €
14034	410	9,00 €
14049	237	8,00 €
14050	237	10,50 €
14051	237	18,00 €
14052	237	19,50 €
14075	165	2,00 €
14076	165	1,50 €
14077	165	4,50 €
14078	165	4,00 €
14083	412	13,20 €
14114	89	19,30 €
14118	365	26,00 €
14120	146	22,00 €
14121	146	26,00 €

REF.	SEITE	PREIS
14122	148	34,00 €
14123	148	33,00 €
14124	150	20,50 €
14125	150	19,50 €
14126	153	54,00 €
14127	155	32,50 €
14129	151	12,50 €
14130	151	21,00 €
14131	149	24,00 €
14133	155	16,50 €
14135	155	12,50 €
14136	152	12,00 €
14137	159	131,00 €
14145	328	8,50 €
14146	328	8,00 €
14147	328	25,00 €
14148	328	25,00 €
14153	149	20,50 €
14154	153	42,00 €
14157	161	8,30 €
14158	161	9,95 €
14159	161	12,60 €
14160	161	12,80 €
14161	161	13,70 €
14162	153	25,50 €
14163	153	25,50 €
14164	153	25,50 €
14165	146	26,50 €
14167	70	2,50 €
14168	160	7,00 €
14169	163	3,00 €
14172	173	8,50 €
14173	173	9,50 €
14177	173	9,50 €
14178	173	9,50 €
14179	58	8,50 €
14180	58	7,90 €
14183	68	31,00 €
14187	219	6,00 €
14188	160	0,50 €
14189	412	52,00 €
14190	165	2,00 €
14191	165	2,00 €
14192	165	4,00 €
14193	165	4,00 €
14195	166	4,00 €
14196	166	4,00 €
14197	166	4,50 €
14198	166	4,00 €
14199	166	4,00 €
14200	166	4,50 €
14201	165	4,00 €
14202	165	4,00 €
14203	165	4,50 €
14204	165	1,50 €
14205	165	1,50 €
14206	165	1,50 €

REF.	SEITE	PREIS
14207	165	1,50 €
14208	165	1,50 €
14209	165	1,50 €
14211	237	11,00 €
14212	237	12,00 €
14213	237	12,00 €
14214	237	14,00 €
14286	153	2,99 €
14287	153	2,99 €
14288	153	6,00 €
14289	153	6,10 €
14296	74, 75, 76, 77, 83	118,00 €
14297	74, 75, 76, 77, 83	87,00 €
14298	74, 75, 76, 77, 83	51,50 €
14299	74, 75, 76, 77, 83	87,00 €
14300	220	19,00 €
14301	220	19,00 €
14314	166	5,00 €
14315	166	4,50 €
14330	153	3,50 €
14336	149	58,00 €
14340	237	10,50 €
14341	237	10,50 €
14342	237	10,50 €
14343	237	10,50 €
14344	237	11,00 €
14345	237	11,00 €
14346	237	11,00 €
14347	408	36,50 €
14348	212	12,50 €
14349	212	20,50 €
14350	403, 404	1,80 €
14351	404	1,65 €
14352	404	1,30 €
14353	404	2,10 €
14354	90	14,00 €
14355	404	1,70 €
14356	404	1,90 €
14357	404	1,90 €
14358	403, 404	1,70 €
14359	401, 404	1,05 €
14361	404	1,70 €
14364	404	1,90 €
14365	404	1,90 €
14366	404	1,45 €
14367	404	1,30 €
14368	404	1,45 €
14369	404	4,95 €
14370	404	3,00 €
14371	404	3,00 €
14372	404	1,20 €
14373	404	1,35 €
14374	403	1,70 €
14375	403	1,85 €
14376	403	2,60 €
14377	403	1,90 €

REF.	SEITE	PREIS
14378	403	1,90 €
14379	403	1,45 €
14380	411	51,00 €
14381	403	1,70 €
14382	403	1,85 €
14383	403	1,35 €
14384	403	2,10 €
14387	403	1,45 €
14388	403	2,05 €
14389	403	1,25 €
14390	403	1,35 €
14391	403	2,15 €
14392	403	1,35 €
14393	403	1,50 €
14395	403	1,65 €
14396	403	1,20 €
14397	403	1,45 €
14398	403	1,30 €
14399	403	1,90 €
14402	403	1,50 €
14404	403	2,10 €
14405	403	1,45 €
14406	403	1,55 €
14408	403	1,45 €
14409	403	1,35 €
14410	402	1,85 €
14411	402	1,70 €
14412	402	1,70 €
14413	402	3,25 €
14414	402	1,70 €
14415	402	1,70 €
14416	402, 403	1,25 €
14419	402	1,95 €
14420	402	1,50 €
14421	402	2,45 €
14422	401, 402	1,50 €
14423	402	3,55 €
14424	402	1,85 €
14425	402	2,05 €
14426	402	1,90 €
14427	402	1,20 €
14428	402	1,40 €
14429	402	1,80 €
14430	402	2,25 €
14431	402	1,45 €
14432	402	1,45 €
14434	402	1,60 €
14435	402	1,45 €
14436	402	1,70 €
14437	402	1,45 €
14438	402	1,35 €
14439	402	1,75 €
14440	402	1,75 €
14441	402	1,65 €
14442	402	1,45 €
14443	402	1,45 €
14444	402	1,90 €

REF.	SEITE	PREIS
14445	402	1,45 €
14446	401	2,80 €
14447	401	1,45 €
14448	401	2,05 €
14449	401	2,20 €
14450	401	2,15 €
14451	401	2,15 €
14452	401	2,55 €
14453	401	3,05 €
14455	401	2,10 €
14456	401	1,35 €
14457	401	1,70 €
14458	401	1,70 €
14459	401	1,45 €
14460	401	1,15 €
14461	401	1,35 €
14462	401	1,65 €
14463	401	1,65 €
14464	401	1,50 €
14465	401	2,00 €
14466	401	1,65 €
14468	401	1,30 €
14469	401	1,45 €
14471	401	1,90 €
14472	401	1,35 €
14474	401	1,50 €
14475	401	1,65 €
14476	401	2,05 €
14477	401	2,45 €
14478	401	4,05 €
14479	401	1,65 €
14480	401	2,05 €
14481	401	1,70 €
14507	412	50,00 €
14534	161	16,50 €
14560	161	8,80 €
14561	166	8,80 €
14563	214	18,00 €
14564	183	9,20 €
14565	183	26,70 €
14566	183	16,70 €
14567	183	38,00 €
14568	183	9,20 €
14569	183	9,20 €
14570	183	4,05 €
14571	183	9,20 €
14573	183	4,05 €
14578	92	12,50 €
14580	92	41,00 €
14583	148	6,00 €
14594	221, 389	2,00 €
14595	221, 389	1,50 €
14596	221, 389	2,00 €
14597	221, 389	7,60 €
14598	221, 389	17,80 €
14599	221, 389	4,50 €
14600	221, 389	9,50 €

REF.	SEITE	PREIS
14601	221, 389	11,00 €
14602	221, 389	11,00 €
14611	240	12,00 €
14612	240	11,00 €
14613	240	13,50 €
14616	321	96,00 €
14618	147	19,00 €
14622	123, 410	17,00 €
14623	123, 410	8,00 €
14624	123, 410	17,00 €
14625	123, 410	14,00 €
14626	123, 410	7,00 €
14633	147	22,50 €
14710	183	3,50 €
14711	183	3,75 €
14712	183	4,00 €
14713	183	4,25 €
14714	183	4,50 €
14715	183	4,75 €
14723	172	18,00 €
14724	172	18,50 €
14725	172	18,50 €
14726	172	17,50 €
14728	168, 169, 176	3,80 €
14729	168, 169, 176	3,80 €
14730	168, 169, 176	3,80 €
14731	168, 169, 176	3,80 €
14732	168, 169, 176	3,80 €
14733	168, 169, 176	4,30 €
14734	168, 169, 176	5,40 €
14735	169	6,50 €
14736	170, 176	5,00 €
14737	170, 176	5,00 €
14738	170, 176	5,50 €
14739	170, 176	5,50 €
14740	170, 176	5,55 €
14741	170, 176	5,55 €
14742	170, 176	5,55 €
14743	170, 176	5,15 €
14744	170, 176	5,35 €
14745	170, 176	6,25 €
14746	170, 176	6,40 €
14747	170, 176	7,10 €
14748	170, 176	8,30 €
14749	32, 175	2,00 €
14750	32, 175	2,00 €
14751	32, 175	4,00 €
14752	32, 175	4,00 €
14753	143	13,00 €
14771	164, 338	10,50 €
14772	164	8,50 €
14774	338	10,50 €
14775	380	30,50 €
14779	150	33,00 €
14781	377	990 €

REF.	SEITE	PREIS
14783	92	5,50 €
14793	378	12,00 €
14803	380	43,00 €
14807	412	11,00 €
14825	123	1,50 €
14826	123	1,50 €
14827	123	2,00 €
14828	123	1,50 €
14829	123	1,50 €
14830	123	1,50 €
14831	123	1,50 €
14832	123	2,00 €
14833	123	2,05 €
14834	123	2,50 €
14835	123	3,00 €
14836	123	3,50 €
14837	123	3,30 €
14838	123	3,40 €
14839	123	4,70 €
14840	123	3,35 €
14841	124	2,58 €
14842	124	9,50 €
14843	125	0,50 €
14844	125	0,50 €
14845	125	0,50 €
14846	125	0,50 €
14847	125	0,50 €
14848	125	0,50 €
14849	125	1,00 €
14850	125	1,00 €
14851	125	1,00 €
14852	125	1,00 €
14853	125	1,00 €
14854	125	1,00 €
14855	125	1,00 €
14856	125	1,00 €
14857	125	1,50 €
14858	125	1,50 €
14859	125	1,50 €
14860	125	2,00 €
14861	125	2,00 €
14862	125	2,00 €
14863	125	2,50 €
14864	125	2,50 €
14865	125	2,50 €
14866	125	3,00 €
14867	125	3,00 €
14868	125	0,55 €
14869	125	0,60 €
14870	125	1,00 €
14871	125	1,00 €
14872	125	1,00 €
14873	125	1,00 €
14874	125	1,00 €
14875	125	1,50 €
14876	125	1,50 €
14877	125	1,50 €

REF.	SEITE	PREIS
14878	125	2,00 €
14879	125	2,00 €
14880	125	2,50 €
14881	125	2,50 €
14882	125	3,00 €
14883	125	3,50 €
14884	125	3,65 €
14885	125	4,00 €
14886	125	4,60 €
14887	125	5,00 €
14888	125	6,00 €
14889	125	6,50 €
14890	125	7,00 €
14891	125	7,50 €
14892	125	8,00 €
14893	128	2,00 €
14894	128	1,20 €
14895	128	1,90 €
14896	128	2,10 €
14897	128	0,88 €
14898	128	0,98 €
14899	128	0,88 €
14900	128	0,98 €
14901	124	3,60 €
14902	124	4,65 €
14903	124	5,25 €
14904	124	6,85 €
14905	124	8,50 €
14906	124	10,20 €
14907	124	0,50 €
14908	124	0,60 €
14909	124	0,80 €
14910	124	1,00 €
14911	124	1,30 €
14912	124	1,55 €
14913	124	1,90 €
14914	124	2,10 €
14915	124	2,65 €
14916	124	2,95 €
14917	124	3,45 €
14920	123	2,50 €
14922	412	0,84 €
14923	412	0,84 €
14924	412	0,84 €
14925	412	0,84 €
14926	412	1,05 €
14930	204	9,50 €
14931	204	8,00 €
14932	204	9,50 €
14933	204	9,50 €
14934	124	4,25 €
14935	124	8,45 €
14945	411	303,50 €
14946	411	58,00 €
14947	411	201,50 €
14948	411	251,50 €
14950	116	6,50 €

REF.	SEITE	PREIS
14951	116	9,50 €
14952	116	19,00 €
14953	116	8,50 €
14970	168	2,50 €
14971	168	2,50 €
14972	168	3,50 €
14973	168, 169	11,50 €
14974	412	2,28 €
14975	410	64,00 €
14976	412	18,84 €
14978	53	7,50 €
14979	53	9,00 €
14980	53	13,00 €
14981	53	22,50 €
14982	53	27,50 €
14985	128	6,00 €
14986	128	4,00 €
14987	128	8,50 €
14988	128	8,00 €
14989	128	6,00 €
14990	128	10,50 €
14991	128	2,00 €
14992	200	8,50 €
14993	128	5,00 €
14994	128	3,50 €
14995	128	8,00 €
14996	411	65,00 €
15010	97	16,50 €
15011	97	18,00 €
15012	97	31,50 €
15014	127	20,00 €
15023	92	12,50 €
15024	92	15,00 €
15025	92	12,50 €
15026	92	15,00 €
15030	92	8,00 €
15033	92	6,00 €
15034	92	57,00 €
15035	92	8,50 €
15036	92	8,50 €
15037	92	8,00 €
15038	92	34,50 €
15040	92	12,50 €
15041	92	15,00 €
15042	92	7,50 €
15049	117	37,40 €
15050	92	9,50 €
15051	412	1,92 €
15052	219	3,00 €
15053	219	10,50 €
15054	219	34,00 €
15056	412	11,70 €
15058	92	7,50 €
15059	378	10,00 €
15062	378	1,00 €
15065	92	6,50 €
15068	90	15,20 €

REF.	SEITE	PREIS
15069	90	32,80 €
15070	82	0,50 €
15071	82	0,60 €
15072	82	0,70 €
15073	82	1,00 €
15074	82	1,00 €
15075	82	1,20 €
15076	82	3,50 €
15083	88	8,50 €
15084	88, 203, 307	68,00 €
15093	317	38,00 €
15094	317	39,50 €
15095	317	13,00 €
15096	317	40,00 €
15122	39, 75, 85	74,00 €
15138	51	10,50 €
15139	51	12,00 €
15140	51	13,50 €
15144	93	30,00 €
15145	94	20,45 €
15146	94	16,20 €
15147	50	5,00 €
15148	50	5,00 €
15149	50	5,00 €
15152	408	160,00 €
15155	75, 85	59,00 €
15156	43, 85	70,00 €
15157	85	42,00 €
15158	85	59,00 €
15159	85	44,00 €
15160	85	42,00 €
15161	75, 85	62,00 €
15162	36, 87, 345	30,20 €
15206	43	15,00 €
15207	43	16,50 €
15208	43	17,00 €
15209	43	18,00 €
15227	36	3,50 €
15228	36	4,00 €
15229	36	5,00 €
15230	36	5,00 €
15231	36	3,50 €
15232	36	4,00 €
15233	36	5,00 €
15234	36	3,00 €
15253	222, 225	62,00 €
15300	369	5,00 €
15313	90	14,00 €
15315	86	28,20 €
15316	39, 86	58,00 €
15317	369	4,50 €
15328	39	6,00 €
15329	39	5,50 €
15330	39	5,50 €
15331	39	5,50 €
15332	39	6,00 €
15333	39	6,50 €

REF.	SEITE	PREIS
15334	39	7,00 €
15335	39	7,50 €
15336	39	8,00 €
15337	39	8,50 €
15338	39	9,00 €
15339	39	9,50 €
15375	183	28,00 €
15385	135	18,00 €
15448	343	5,50 €
15454	57, 86	35,40 €
15460	343	5,00 €
15494	200	12,50 €
15495	200	12,50 €
15496	200	11,50 €
15497	200	11,00 €
15498	200	11,50 €
15499	200	11,00 €
15500	200	10,00 €
15501	200	10,00 €
15502	200	10,00 €
15503	200	11,00 €
15504	200	10,00 €
15505	200	4,00 €
15506	200	4,00 €
15507	200	4,50 €
15508	200	4,50 €
15509	200	5,00 €
15510	200	5,00 €
15511	200	8,00 €
15514	75, 86	9,35 €
15515	39	15,50 €
15516	39	19,00 €
15517	39	22,50 €
15541	86	27,60 €
15552	190, 351	181,00 €
15564	148	11,90 €
15619	355	4,00 €
15631	303	98,00 €
15632	38	9,00 €
15633	38	9,50 €
15634	38	11,00 €
15635	38	12,50 €
15636	38	14,00 €
15637	38	15,00 €
15681	85	134,00 €
15706	63, 86	31,00 €
15730	78, 84	289,00 €
15731	78, 84	214,00 €
15732	78, 84	293,50 €
15733	78, 84	113,00 €
15734	78, 84	288,50 €
15735	78, 84	152,00 €
15736	78, 84	488,50 €
15737	66, 86	45,00 €
15783	65	3,50 €
15784	65	3,50 €
15785	65	3,50 €

REF.	SEITE	PREIS
15786	65	3,50 €
15787	65	3,50 €
15799	63, 87	28,30 €
15866	350	32,00 €
15874	310	6,50 €
16010	46	4,00 €
16011	46	4,00 €
16012	46	4,00 €
16013	46	4,50 €
16014	46	4,50 €
16015	46	5,00 €
16016	46	5,00 €
16017	46	5,00 €
16018	46	5,50 €
16019	46	6,00 €
16020	41	17,00 €
16021	41	19,50 €
16022	41	23,00 €
16023	41	26,50 €
16024	41	34,50 €
16025	41	37,50 €
16052	137, 144	2,09 €
16053	137, 144	2,85 €
16111	61, 87	19,20 €
16130	343	290,00 €
16161	91	17,50 €
16162	91	35,10 €
16163	91	10,20 €
16188	91	39,60 €
16198	343	5,00 €
16237	237	23,00 €
16238	237	23,00 €
16239	237	23,00 €
16240	237	26,00 €
16241	237	23,00 €
16242	237	26,00 €
16243	237	23,00 €
16273	150	12,50 €
16294	395	14,00 €
16295	206	30,00 €
16300	227	7,60 €
16301	227	7,60 €
16302	227	7,60 €
16304	172	31,00 €
16305	172	31,00 €
16309	220	149,00 €
16316	221	18,50 €
16318	126	0,50 €
16319	126	0,50 €
16320	126	0,50 €
16321	126	1,00 €
16322	126	1,00 €
16323	126	1,00 €
16324	126	1,50 €
16325	126	1,50 €
16326	126	2,00 €
16327	126	2,00 €

REF.	SEITE	PREIS
16328	126	2,50 €
16329	126	3,00 €
16330	126	3,50 €
16331	126	3,50 €
16332	126	4,00 €
16333	126	4,50 €
16334	126	5,50 €
16335	126	6,00 €
16336	126	6,50 €
16341	147	32,50 €
16342	65	2,50 €
16343	65	2,50 €
16344	90	43,00 €
16354	90	1,50 €
16355	90	2,00 €
16356	90	2,50 €
16357	90	2,50 €
16358	90	12,00 €
16359	90	10,00 €
16360	90	12,00 €
16361	90	16,50 €
16362	90	20,00 €
16363	90	14,50 €
16364	123, 410	3,50 €
16366	206	11,00 €
16367	206	10,00 €
16368	206	12,00 €
16369	206	12,00 €
16370	206	12,00 €
16371	206	11,00 €
16372	206	11,50 €
16373	206	12,00 €
16374	206	12,00 €
16375	206	15,00 €
16376	206	15,00 €
16377	206	16,00 €
16378	206	15,00 €
16379	206	15,00 €
16380	206	16,00 €
16381	206	10,00 €
16382	206	10,00 €
16383	206	15,00 €
16384	206	15,00 €
16385	242	10,00 €
16386	242	11,50 €
16387	92	10,50 €
16388	242	11,50 €
16389	242	11,50 €
16391	39	4,60 €
16392	39	4,60 €
16393	39	4,60 €
16394	39	5,10 €
16395	39	5,10 €
16396	39	5,10 €
16397	39	5,50 €
16398	39	5,50 €
16399	39	5,50 €

REF.	SEITE	PREIS
16400	259	6,50 €
16401	39	6,10 €
16402	39	6,10 €
16403	39	6,10 €
16430	233	20,50 €
16431	233	20,50 €
16432	233	20,50 €
16433	233	20,50 €
16434	233	20,50 €
16435	233	21,50 €
16436	233	21,50 €
16448	222	16,50 €
16462	389	36,50 €
16463	389	36,50 €
16464	389	36,50 €
16465	389	39,50 €
16466	389	50,00 €
16467	389	36,50 €
16468	389	36,50 €
16469	389	36,50 €
16470	389	39,50 €
16471	389	50,00 €
16472	389	17,50 €
16473	389	17,50 €
16474	389	17,50 €
16475	389	17,50 €
16476	389	24,00 €
16477	389	24,50 €
16478	389	24,50 €
16479	389	7,50 €
16480	389	7,50 €
16481	93	14,00 €
16482	93	13,50 €
16490	73	650,00 €
16491	73	307,00 €
16492	73	675,00 €
16493	73	436,00 €
16494	73	139,00 €
16496	73	127,00 €
16497	73	77,00 €
16498	73	84,00 €
16499	73	162,00 €
16500	73	463,00 €
16516	73	121,00 €
16538	389	19,50 €
16539	389	18,00 €
16540	389	13,00 €
16541	389	13,00 €
16542	389	23,50 €
16543	389	13,00 €
16546	43	5,00 €
16547	43	5,50 €
16548	43	9,00 €
16549	43	14,00 €
16561	73	36,50 €
16564	147	17,00 €
16565	233	19,50 €

REF.	SEITE	PREIS
16566	233	22,50 €
16571	172	32,00 €
16572	172	33,50 €
16574	172	34,00 €
16575	172	34,50 €
16576	172	35,50 €
16577	172	36,00 €
16583	126	8,50 €
16584	126	10,50 €
16585	126	11,50 €
16586	126	13,00 €
16587	126	14,00 €
16588	126	15,00 €
16600	73	252,00 €
16627	73	225,00 €
16628	73	382,00 €
16629	73	419,00 €
16642	65	1,00 €
16737	226	12,00 €
50400	191	168,00 €
50403	191	98,00 €
50409	192	26,00 €
50410	191	168,00 €
50431	357	3,80 €
50517	350	129,00 €
50518	350	169,00 €
50523	357	4,70 €
50524	357	4,70 €
50525	365	1,00 €
50526	365	4,80 €
50551	357	350,00 €
50562	44	23,50 €
50564	42	30,00 €
50567	57	9,60 €
50577	186	12,60 €
50585	361	14,70 €
50600	368	0,60 €
50601	368	0,29 €
50622	46	64,00 €
50623	21	60,00 €
50630	324	590,00 €
50631	322	68,00 €
50632	335	298,00 €
50644	359	11,60 €
50651	391	18,00 €
50652	391	16,50 €
50654	354	4,00 €
50656	190, 351	290,00 €
50717	359	21,90 €
50724	69	28,00 €
50731	217	68,00 €
50751	156, 312	43,00 €
50760	368	0,10 €
50761	368	0,19 €
50762	368	0,29 €
50763	368	0,38 €
50764	368	0,49 €

REF.	SEITE	PREIS
50765	368	0,58 €
50766	368	0,68 €
50767	368	0,78 €
50768	368	0,88 €
50778	368	0,10 €
50779	368	0,19 €
50780	368	0,29 €
50781	368	0,38 €
50782	368	0,49 €
50783	368	0,58 €
50784	368	0,68 €
50785	368	0,78 €
50786	368	0,88 €
50787	98	8,00 €
50788	98	14,50 €
50789	98	29,00 €
50792	236	105,00 €
50793	236	94,00 €
50797	349	490,00 €
50807	221, 391	38,00 €
50808	99	77,00 €
50815	314	88,00 €
50816	315	88,00 €
50818	314	198,00 €
50819	316	28,00 €
50820	316	34,50 €
50821	316	47,00 €
50822	316	59,00 €
50823	316	94,00 €
50824	316	88,00 €
50825	316	154,00 €
50827	223, 321	387,00 €
50830	317	560,00 €
50831	322	460,00 €
50835	319	290,00 €
50836	323	148,00 €
50838	323	299,00 €
50839	320	180,00 €
50840	322	138,00 €
50843	99	79,00 €
50844	99	65,00 €
50852	312	24,50 €
50901	181	16,00 €
50902	54	13,00 €
50903	181	30,80 €
50910	142	45,00 €
50911	324	788,00 €
50913	190, 351	195,00 €
50915	357	4,20 €
50916	192	0,88 €
50917	305	271,00 €
50918	304	341,00 €
50923	188, 320	454,00 €
50924	308, 351	342,00 €
50935	304	595,00 €
50937	69	10,50 €
50942	331, 344	28,00 €

REF.	SEITE	PREIS
50957	95	22,00 €
50959	95, 386	14,00 €
50966	354	4,00 €
50966C	354	3,00 €
50980	34	22,00 €
50982	34	22,00 €
50983	30	48,00 €
50985	30	59,00 €
51017	56	6,80 €
51018	56	7,05 €
51020	56	6,65 €
51021	56	7,05 €
51028	172	163,00 €
51033	339	98,00 €
51035	94	799,00 €
51050	95	285,00 €
51051	95	34,80 €
51055	368	0,98 €
51059	195	99,00 €
51119	229	62,00 €
51120	213	41,00 €
51121	222	27,30 €
51123	229	91,00 €
51124	241	88,00 €
51125	238	88,00 €
51126	234	18,00 €
51127	52	56,00 €
51127R	52	14,00 €
51131	180	61,00 €
51140	240	64,00 €
51206	146	228,00 €
51207	146	289,00 €
51210	148	650,00 €
51211	148	560,00 €
51212	148	488,00 €
51213	148	690,00 €
51214	150	148,00 €
51215	150	119,00 €
51216	153	650,00 €
51218	155	288,00 €
51220	151	240,00 €
51221	151	199,00 €
51222	149	128,00 €
51226	155	233,00 €
51235	329	49,00 €
51238	328	138,00 €
51239	328	159,00 €
51245	155	99,00 €
51246	358	6,40 €
51253	305	41,00 €
51258	134	0,15 €
51259	231	58,00 €
51260	29	37,00 €
51262	52	51,00 €
51262R	52	14,00 €
51266	359	28,00 €
51272	62	7,50 €

REF.	SEITE	PREIS
51277	157	64,00 €
51283	196	78,00 €
51305	50	28,90 €
51306	50	28,10 €
51307	50	29,70 €
51315	410	2,50 €
51318	38	98,00 €
51326	134	4,40 €
51332	200	98,00 €
51333	32	18,00 €
51336	173	29,30 €
51337	204	50,00 €
51338	52	53,00 €
51338R	52	14,00 €
51340	296	39,30 €
51341	163	35,00 €
51347	230	9,90 €
51349	242	37,30 €
51352	201	9,80 €
51353	201	11,50 €
51354	202	13,20 €
51355	60, 369	19,00 €
51356	308	48,00 €
51358	371	7,50 €
51359	371	9,00 €
51360	181	8,05 €
51361	181	9,80 €
51362	371	3,00 €
51363	328	114,00 €
51364	221	26,00 €
51365	328	118,00 €
51368	224	19,00 €
51369	224	28,00 €
51383	157	11,10 €
51385	162	4,55 €
51386	162	5,95 €
51387	162	3,25 €
51388	153	22,00 €
51389	153	22,00 €
51390	153	22,00 €
51391	153	22,00 €
51392	153	34,00 €
51393	153	34,00 €
51398N	375	1,54 €
51400	204	17,00 €
51401	204	22,00 €
51402	204	20,50 €
51403	204	17,50 €
51405	50	21,10 €
51406	50	29,20 €
51409	33	36,00 €
51410	33	36,00 €
51412	364	2,10 €
51414	224	14,00 €
51416	47	12,00 €
51419	91	2,79 €
51422	91	2,97 €

REF.	SEITE	PREIS
51439	153	26,00 €
51440	153	28,00 €
51441	153	26,00 €
51442	153	28,00 €
51443	162	5,50 €
51444	162	5,05 €
51445	162	5,05 €
51447	53, 87	16,00 €
51448	53, 87	52,00 €
51452	322	69,00 €
51479	53	31,80 €
51488	273	16,00 €
51489	284	12,00 €
51490	225	36,00 €
51491	230	154,00 €
51493	207	68,00 €
51494	205	107,00 €
51495	232	59,00 €
51496	236	8,00 €
51500	240	29,00 €
51501	233	38,00 €
51504	63	8,50 €
51525	62	9,80 €
51526	62	9,80 €
51528	44	49,00 €
51538	388	0,15 €
51539	388	0,15 €
51540	388	0,15 €
51541	388	0,25 €
51542	388	0,20 €
51543	388	0,25 €
51544	388	0,25 €
51545	388	0,30 €
51546	389	0,19 €
51554	389	0,28 €
51573	134	2,50 €
51574	95	52,00 €
51575	96	317,00 €
51576	93	125,00 €
51600	96	109,00 €
51604	368	0,98 €
51612	357	5,95 €
51613	357	2,90 €
51614	357	3,60 €
51615	357	5,95 €
51616	23	378,00 €
51622	192	25,30 €
51632N	375	1,54 €
51633	375	1,54 €
51634	375	1,54 €
51636N	375	1,54 €
51638N	375	1,54 €
51640N	375	1,54 €
51642N	375	1,54 €
51653	91	5,10 €
51654	91	4,80 €
51655	91	4,10 €

REF.	SEITE	PREIS
51656	91	3,65 €
51657	91	5,85 €
51658	91	4,50 €
51659	46	59,00 €
51661	47	12,00 €
51674	63	7,75 €
51692	355	3,55 €
51693	355	3,55 €
51694	355	3,55 €
51696	355	3,55 €
51697	364	0,80 €
51703	359	10,50 €
51705	359	8,45 €
51706	366	22,80 €
51707	366	9,05 €
51708	366	14,20 €
51709	366	14,70 €
51710	366	17,80 €
51711	366	21,20 €
51712	366	8,65 €
51713	366	13,10 €
51714	366	15,80 €
51715	366	20,30 €
51716	366	23,60 €
51717	366	11,20 €
51718	366	14,80 €
51719	366	22,00 €
51720	366	23,50 €
51721	366	25,00 €
51722	366	13,10 €
51723	366	18,70 €
51724	366	24,40 €
51725	366	28,30 €
51726	366	31,40 €
51727	366	49,00 €
51737	94	699,00 €
51738	93	850,00 €
51741	370	0,50 €
51742	370	0,50 €
51743	370	0,55 €
51745	376	0,70 €
51746	34	12,00 €
51751	320	99,00 €
51785	376	1,00 €
51795	47	9,00 €
51796	47	14,00 €
51797	47	18,00 €
51798	47	39,60 €
51799	389	0,20 €
51801	51	62,00 €
51804	386	58,00 €
51805	53, 87	17,00 €
51812	56	46,00 €
51814	369	8,00 €
51816	329	58,00 €
51817	354	4,50 €
51818	18	109,00 €

REF.	SEITE	PREIS
51824	192	36,80 €
51830	52	94,00 €
51831	339	24,00 €
51832	181	18,00 €
51837	336	195,00 €
51838	336	667,00 €
51839	198	24,00 €
51842	330	6,90 €
51843	389	0,19 €
51853	70	18,00 €
51855	23	378,00 €
51858	364	15,00 €
51859	339	3,80 €
51861	159, 359	199,00 €
51863	366	54,00 €
51864	45, 87	64,00 €
51886	142	44,00 €
51889	130	49,00 €
51890	46	92,00 €
51895	315	99,00 €
51896	235	82,00 €
51897	235	122,00 €
51898	235	139,00 €
51899	235	137,00 €
51901	319	999,00 €
51902	229	84,00 €
51905	316	34,50 €
51906	316	39,00 €
51907	316	48,00 €
51908	368	44,00 €
51909	65	2,46 €
51918	63	12,50 €
51919	228	89,00 €
51920	234, 392	18,00 €
51923	201	12,50 €
51925	365	1,00 €
51927	296	25,00 €
51928	308	14,00 €
51929	143	22,00 €
51934	201	11,50 €
51935	354	135,00 €
51936	354	135,00 €
51937	354	135,00 €
51951	70	15,60 €
51958	228	422,00 €
51960	138	34,00 €
51961	138	34,00 €
51962	138	25,00 €
51963	138	29,00 €
51964	138	28,00 €
51965	138	29,50 €
51966	139	18,00 €
51967	144	16,00 €
51968	144	16,00 €
51969	139	14,00 €
51972	60	12,00 €
51973	366	45,00 €

REF.	SEITE	PREIS
51975	91	2,27 €
51976	91	1,63 €
51978	191	84,00 €
51980	156	15,00 €
51981	157	21,50 €
51982	349	120,00 €
51983	349	185,00 €
51984	349	190,00 €
51985	191	84,00 €
51986	234	11,90 €
51989	216	49,00 €
51991	230	54,00 €
51995	58, 59	24,50 €
51998	226	38,00 €
52010	239	80,00 €
52012	228	68,00 €
52016	235	2,10 €
52017	235	2,40 €
52018	235	2,60 €
52019	235	3,20 €
52021	235	3,40 €
52022	235	4,50 €
52023	235	6,60 €
52024	235	10,60 €
52025	235	13,00 €
52026	181	31,80 €
52027	382	14,00 €
52028	385	15,20 €
52029	385	14,00 €
52030	388	98,00 €
52031	387	44,00 €
52032	386	28,00 €
52033	390	43,00 €
52043	384	16,50 €
52044	382	19,00 €
52047	357	3,30 €
52048	357	3,95 €
52049	66	14,00 €
52050	59	98,00 €
52052	57	53,00 €
52053	394	45,00 €
52054	394	17,00 €
52055	322	139,00 €
52056	242	66,00 €
52057	191	6,80 €
52058	191	4,50 €
52059	35	29,00 €
52060	35	32,00 €
52065	191	45,00 €
52066	218	12,00 €
52069	328	29,50 €
52070	328	40,00 €
52071	328	47,00 €
52076	211	111,00 €
52077	183	29,50 €
52148	99	65,00 €
52149	349	230,00 €

REF.	SEITE	PREIS
52152	60	13,50 €
52153	227	46,00 €
52156	149	140,00 €
52157	155	48,00 €
52158	386	38,50 €
52159	151	64,00 €
52160	151	48,00 €
52162	79, 338, 346	38,00 €
52163	388	95,00 €
52165	149	118,00 €
52167	150	48,00 €
52169	55	25,00 €
52170	55	16,00 €
52171	155	39,00 €
52180	63	19,00 €
52181	63	22,50 €
52182	63	24,00 €
52183	63	26,20 €
52184	63	43,00 €
52185	63	55,00 €
52186	63	72,00 €
52187	364	21,80 €
52188	63	15,50 €
52190	216	8,00 €
52191	197	198,00 €
52195	334	170,00 €
52197	50	36,30 €
52198	32	37,70 €
52200	351	88,00 €
52202	351	88,00 €
52207	50	24,20 €
52227	223	247,00 €
52230	190, 350	398,00 €
52231	330	49,00 €
52233	330	328,00 €
52235	48	11,00 €
52236	48	13,30 €
52237	48	18,10 €
52238	48	24,90 €
52241	319	1.690,00 €
52242	311	12,00 €
52243	311	8,50 €
52244	191	84,00 €
52251	364	21,80 €
52254	135	64,00 €
52259	359	3,75 €
52262	185	7,50 €
52263	185	13,50 €
52264	185	18,60 €
52265	185	30,50 €
52269	202	7,00 €
52270	224	109,00 €
52271	283	18,00 €
52272	57	24,60 €
52273	212	44,00 €
52275	198	38,00 €
52293	231	98,00 €

REF.	SEITE	PREIS
52295	185	6,50 €
52296	239	119,00 €
52297	239	172,00 €
52298	239	177,00 €
52302	140	25,40 €
52303	140	26,40 €
52304	316	84,00 €
52305	205	106,00 €
52308	100	440,00 €
52309	100	941,00 €
52310	375	3,65 €
52311	201	19,00 €
52312	201	9,00 €
52313	201	8,00 €
52314	201	26,60 €
52315	198	16,00 €
52316	232	18,90 €
52317	232	19,90 €
52318	69	73,00 €
52319	232	8,80 €
52320	34	22,00 €
52321	186	8,80 €
52327	186	12,00 €
52328	197	99,00 €
52329	303	36,40 €
52330	194	99,00 €
52331	159	201,00 €
52337	168	65,00 €
52338	173	41,00 €
52339	171	61,00 €
52340	171	58,00 €
52341	169	58,00 €
52342	170	63,00 €
52343	173	52,00 €
52344	171	197,00 €
52345	168	109,00 €
52346	169	103,00 €
52347	171	158,00 €
52348	172	179,00 €
52349	48	22,10 €
52350	48	22,60 €
52351	48	25,40 €
52352	48	32,40 €
52353	48	33,40 €
52354	48	34,40 €
52355	48	36,60 €
52357	48	54,00 €
52358	48	63,00 €
52362	357	1,23 €
52363	357	1,23 €
52364	357	2,86 €
52365	357	2,46 €
52368	357	1,14 €
52369	357	1,19 €
52370	357	1,17 €
52373	93	252,00 €
52375	137	38,00 €

REF.	SEITE	PREIS
52378	163	10,00 €
52381	157	20,50 €
52382	331, 344	19,50 €
52384	132	29,00 €
52385	186	251,00 €
52386	186	23,60 €
52390	187	35,20 €
52391	311	5,00 €
52412	59	5,00 €
52414	141	19,00 €
52415	141	19,00 €
52416	203	14,00 €
52417	203	28,00 €
52418	21	179,00 €
52419	89	80,00 €
52420	89	108,00 €
52421	89	172,00 €
52422	213	24,70 €
52424	47	64,00 €
52425	63	33,30 €
52426	63	52,00 €
52427	63	64,00 €
52428	305	40,00 €
52430	376	10,90 €
52432	224	35,00 €
52433	69	4,80 €
52434	197	125,00 €
52439	331	227,00 €
52450	338	105,00 €
52451	43	42,00 €
52452	310	8,00 €
52453	310	21,00 €
52454	238	12,90 €
52455	198	16,00 €
52456	137	36,00 €
52460	63	16,60 €
52461	63	25,70 €
52462	68	25,30 €
52463	67	26,10 €
52464	67	42,00 €
52466	98	11,00 €
52468	62	5,90 €
52472	62	4,90 €
52473	62	9,90 €
52474	187	68,00 €
52475	187	62,00 €
52476	187	50,00 €
52477	187	70,00 €
52478	187	49,00 €
52479	187	24,70 €
52480	187	44,00 €
52481	187	52,00 €
52482	187	44,00 €
52483	187	41,00 €
52484	187	66,00 €
52485	187	51,00 €
52486	187	62,00 €

REF.	SEITE	PREIS
52487	187	63,00 €
52488	211	28,00 €
52489	210	58,00 €
52490	156	6,65 €
52491	156	10,50 €
52493	378	4,50 €
52494	241	227,00 €
52495	216	14,50 €
52497	192	26,80 €
52498	308	58,00 €
52500	54	19,00 €
52502	187	31,40 €
52503	187	32,50 €
52504	187	27,60 €
52505	187	20,80 €
52506	187	16,00 €
52507	187	30,10 €
52508	59	38,40 €
52509	59	36,20 €
52511	187	42,00 €
52512	187	50,00 €
52514	320	84,00 €
52515	70, 216	9,10 €
52516	98	28,00 €
52517	98	6,00 €
52518	201	115,00 €
52519	36, 345	25,50 €
52524	53	51,00 €
52525	53	13,80 €
52526	53	28,40 €
52527	151	82,00 €
52528	155	49,00 €
52530	361	14,00 €
52533	161, 182	10,00 €
52534	361	15,00 €
52535	361	16,50 €
52536	130	57,00 €
52538	31	62,00 €
52539	31	59,00 €
52540	159, 182	221,00 €
52541	222	45,00 €
52542	99	109,00 €
52543	160	182,00 €
52544	175	93,00 €
52545	175	177,00 €
52546	171	39,60 €
52547	168	96,00 €
52550	30	92,00 €
52551	242	151,00 €
52552	372	128,00 €
52555	134	2,38 €
52558	134	2,38 €
52565	63	11,50 €
52566	140	28,00 €
52567	140	29,00 €
52568	141	28,00 €
52569	141	28,00 €

REF.	SEITE	PREIS
52570	375	2,60 €
52571	375	2,60 €
52572	375	2,60 €
52573	375	2,60 €
52574	152	69,00 €
52575	68, 160	119,00 €
52583	69	8,50 €
52587	50	39,90 €
52588	50	45,00 €
52591	214	12,00 €
52592	214	22,00 €
52593	214	34,00 €
52595	68	64,00 €
52596	67	114,00 €
52597	67	146,00 €
52598	121, 340	1.080,00 €
52599	210	230,00 €
52600	342	884,00 €
52601	304	397,00 €
52603	28	74,00 €
52604	28	78,00 €
52605	28	76,00 €
52606	28	88,00 €
52607	203	49,00 €
52608	203	44,00 €
52609	68	29,00 €
52615	201	112,00 €
52616	296	44,00 €
52617	204	7,00 €
52618	365	29,00 €
52619	59	23,10 €
52620	31	8,80 €
52621	232	11,00 €
52624	241	28,00 €
52625	60, 198	9,00 €
52626	238	46,00 €
52627	238	120,00 €
52628	308	26,50 €
52629	208	99,00 €
52633	359	1,00 €
52634	91	5,25 €
52635	91	4,80 €
52636	194	114,00 €
52637	229	48,00 €
52638	69	9,95 €
52639	209	123,00 €
52640	225	52,00 €
52641	225	55,00 €
52642	228	32,00 €
52643	339	596,00 €
52644	360	8,80 €
52645	371	0,55 €
52646	371	0,50 €
52648	158	9,00 €
52649	370	5,00 €
52650	370	5,00 €
52652	369	2,80 €

REF.	SEITE	PREIS
52653	369	3,00 €
52655	371	39,70 €
52656	371	39,50 €
52657	371	37,50 €
52658	371	39,70 €
52659	371	39,70 €
52660	372	126,00 €
52662	370	36,50 €
52663	370	30,00 €
52664	372	168,00 €
52665	368	0,37 €
52666	368	0,36 €
52667	368	0,76 €
52668	368	1,49 €
52669	368	2,22 €
52670	368	2,95 €
52671	368	3,70 €
52672	368	4,45 €
52673	370	18,00 €
52675	154	84,00 €
52676	154	98,00 €
52677	202	17,00 €
52678	202	18,00 €
52685	210	88,00 €
52687	218	168,00 €
52690	215	54,00 €
52691	232	54,00 €
52692	324	129,00 €
52693	213	24,50 €
52694	168	49,00 €
52696	213	12,00 €
52697	213	16,00 €
52699	228	22,00 €
52700	70	20,50 €
52703	384	22,00 €
52711	383	27,50 €
52714	33	15,70 €
52715	33	10,00 €
52716	33	15,90 €
52717	33	11,00 €
52718	152	48,00 €
52719	389	0,19 €
52722	22	87,00 €
52724	151	381,00 €
52725	151	349,00 €
52727	239	34,60 €
52728	239	68,00 €
52729	239	128,00 €
52730	239	288,00 €
52731	239	38,00 €
52732	239	58,00 €
52733	239	98,00 €
52734	213	51,00 €
52735	166	4,85 €
52736	166	5,35 €
52737	166	5,50 €
52738	375	5,00 €

REF.	SEITE	PREIS
52739	375	5,00 €
52740	184	690,00 €
52749	189	79,00 €
52753	30	107,00 €
52754	204	54,00 €
52757	209	16,00 €
52758	154	88,00 €
52760	70, 216	4,10 €
52761	61	8,00 €
52762	61	9,00 €
52765	185	21,70 €
52768	356	13,80 €
52769	356	14,50 €
52770	356	23,00 €
52771	356	23,40 €
52772	356	13,90 €
52773	356	14,60 €
52774	356	14,80 €
52775	356	15,20 €
52776	356	13,80 €
52777	356	15,50 €
52778	356	14,60 €
52779	356	17,10 €
52780	356	13,90 €
52781	356	14,60 €
52782	356	14,80 €
52783	356	15,20 €
52786	64	14,60 €
52787	157	9,00 €
52788	181	39,00 €
52789	308	15,20 €
52791	58, 59	18,00 €
52794	69	28,00 €
52795	354	5,80 €
52796	228	98,00 €
52797	305	198,00 €
52798	156	18,00 €
52801	212	26,00 €
52802	226	54,00 €
52804	309	343,00 €
52805	309	426,00 €
52806	309	742,00 €
52807	309	1.714,00 €
52809	201	8,50 €
52810	170	9,00 €
52811	170	9,90 €
52812	59	65,00 €
52813	212	79,00 €
52814	149	528,00 €
52815	208	110,00 €
52816	232	28,10 €
52817	232	23,50 €
52819	216	22,00 €
52821	212	28,80 €
52822	230	32,00 €
52823	226	124,00 €
52827	138	46,00 €

REF.	SEITE	PREIS
52828	138	43,00 €
52829	222	19,00 €
52830	64	24,00 €
52831	64	18,00 €
52832	215	75,00 €
52833	237	39,30 €
52834	224	195,00 €
52835	224	272,00 €
52836	184	1.100,00 €
52838	142	56,00 €
52839	142	64,00 €
52842	372	11,00 €
52843	139	31,60 €
52845	323	170,00 €
52846	57	37,80 €
52847	57	41,00 €
52849	230	8,50 €
52850	215	7,80 €
52851	181, 395	9,65 €
52852	230	6,80 €
52858	206	298,00 €
52862	357	1,15 €
52864	357	1,20 €
52865	357	0,50 €
52866	357	0,25 €
52869	100	52,00 €
52870	100	100,00 €
52871	100	258,00 €
52873	69	11,00 €
52874	225	82,00 €
52875	225	79,00 €
52876	180	182,00 €
52877	64	15,80 €
52878	64	11,20 €
52879	64	10,10 €
52880	47	42,00 €
52881	47	17,00 €
52882	213	14,00 €
52884	329	73,00 €
52885	64	18,00 €
52886	396	18,00 €
52887	396	22,00 €
52888	400	24,00 €
52889	398	19,00 €
52890	399	22,00 €
52891	398	28,00 €
52892	399	22,00 €
52893	400	26,00 €
52894	398	22,00 €
52895	400	22,00 €
52896	396	26,00 €
52897	399	38,00 €
52898	399	36,00 €
52899	397	34,00 €
52900	397	34,00 €
52901	397	34,00 €
52902	342	970,00 €

REF.	SEITE	PREIS
52903	342	1.100,00 €
52904	69	61,00 €
52905	70	28,00 €
52906	196	38,00 €
52908	34	17,00 €
52909	34	12,50 €
52910	138	39,00 €
52912	45, 87	91,00 €
52913	51	292,00 €
52914	177	223,00 €
52915	177	199,00 €
52916	177	218,00 €
52917	177	122,00 €
52918	177	146,00 €
52919	177	181,00 €
52920	177	155,00 €
52921	177	117,00 €
52922	177	180,00 €
52923	177	59,00 €
52924	177	52,00 €
52925	177	176,00 €
52926	177	201,00 €
52927	177	59,00 €
52928	177	172,00 €
52929	177	185,00 €
52930	178	117,00 €
52931	178	45,00 €
52932	178	45,00 €
52933	178	194,00 €
52934	178	102,00 €
52935	178	94,00 €
52936	178	199,00 €
52937	178	265,00 €
52938	178	199,00 €
52939	178	28,00 €
52940	178	235,00 €
52941	178	70,00 €
52942	178	105,00 €
52943	178	75,00 €
52944	178	110,00 €
52945	178	281,00 €
52952	331, 344	74,00 €
52953	152	38,00 €
52955	61	19,80 €
52956	61	19,60 €
52957	61	23,80 €
52958	61	28,20 €
52959	61	42,00 €
52960	61	46,00 €
52962	226	42,00 €
52963	217	49,00 €
52964	56	9,45 €
52965	56	9,20 €
52966	56	9,45 €
52967	56	9,40 €
52969	172	20,70 €
52973	42	59,00 €

REF.	SEITE	PREIS
52977	182	137,00 €
52980	335	480,00 €
52982	60, 186	53,00 €
52985	322	598,00 €
52987	132	20,00 €
52991	311	10,50 €
52992	311	18,00 €
52998	185	48,00 €
52999	321	178,00 €
53001	217	242,00 €
53007	357	0,42 €
53008	201	15,50 €
53009	209	42,00 €
53010	54	18,00 €
53017	38	57,00 €
53018	40	119,00 €
53025	69	3,50 €
53026	69	5,80 €
53027	69	9,00 €
53028	331	5,80 €
53029	331	6,80 €
53030	331	12,00 €
53031	100	59,00 €
53032	100	126,00 €
53033	364	21,50 €
53037	371	0,50 €
53038	371	0,50 €
53039	371	0,50 €
53040	371	0,50 €
53041	235	37,60 €
53042	69	9,90 €
53043	175	53,00 €
53044	175	121,00 €
53045	140	35,00 €
53046	140	39,00 €
53047	141	330,00 €
53048	141	89,00 €
53049	140	89,00 €
53051	141	158,00 €
53052	140	158,00 €
53053	215	12,00 €
53054	238	6,00 €
53055	236	33,00 €
53056	241	127,00 €
53057	217	149,00 €
53058	241	193,00 €
53059	242	52,00 €
53060	170	34,90 €
53062	240	99,00 €
53063	162	36,70 €
53064	162	37,40 €
53065	162	36,90 €
53066	162	61,00 €
53067	162	61,00 €
53068	162	63,00 €
53069	208	98,00 €
53070	48	16,20 €

REF.	SEITE	PREIS
53071	48	26,10 €
53072	48	31,60 €
53073	48	50,00 €
53074	17	78,00 €
53077	174	62,00 €
53078	310	18,00 €
53079	189	89,00 €
53080	189	99,00 €
53081	52	115,00 €
53082	52	148,00 €
53083	65	64,00 €
53084	34	24,00 €
53085	135	30,00 €
53086	238	9,00 €
53087	356	11,20 €
53088	356	11,50 €
53089	356	11,50 €
53090	356	11,50 €
53091	356	10,20 €
53092	356	10,20 €
53093	356	10,20 €
53094	356	10,20 €
53095	66	20,50 €
53096	209	28,80 €
53108	22	92,00 €
53110	181, 395	27,30 €
53111	332	19,00 €
53112	314	298,00 €
53118	230	231,00 €
53119	213	52,00 €
53120	65	6,00 €
53121	65	7,35 €
53122	65	9,50 €
53124	188	287,00 €
53125	188	477,00 €
53126	189	243,00 €
53127	34	12,00 €
53129	216	84,00 €
53134	189	144,00 €
53137	155	38,00 €
53140	152	98,00 €
53141	155	68,00 €
53144	307	18,00 €
53145	332	39,20 €
53146	239	30,50 €
53147	163	41,00 €
53150	369	24,00 €
53151	143	14,00 €
53154	36, 345	462,00 €
53156	32	26,20 €
53159	25	289,00 €
53162	332	60,00 €
53164	36, 345	16,50 €
53165	36, 345	19,60 €
53166	339	10,50 €
53167	339	12,50 €
53168	339	19,00 €

REF.	SEITE	PREIS
53177	356	11,90 €
53178	356	12,20 €
53179	356	12,20 €
53180	356	12,20 €
53181	356	11,90 €
53182	356	12,20 €
53183	356	12,70 €
53184	356	12,20 €
53185	355	13,20 €
53186	355	13,20 €
53187	311	39,00 €
53188	311	7,00 €
53189	337	128,00 €
53190	337	98,00 €
53191	98	14,80 €
53192	98	52,00 €
53196	192	33,00 €
53197	174	46,00 €
53198	311	9,50 €
53200	318	69,00 €
53202	160	15,70 €
53203	357	0,46 €
53204	160	81,00 €
53205	157	19,00 €
53206	202	38,20 €
53207	225	118,00 €
53208	225	126,00 €
53209	329	8,50 €
53210	48	48,00 €
53211	99	75,00 €
53212	16	174,00 €
53214	309	285,00 €
53215	307	19,00 €
53216	130	49,00 €
53217	132	47,00 €
53218	318	26,00 €
53220	334	260,00 €
53221	365	4,75 €
53224	180	142,00 €
53225	56	3,50 €
53226	192	14,90 €
53227	135	28,00 €
53229	388	38,70 €
53230	183	19,70 €
53232	185	39,00 €
53235	203	10,40 €
53236	203	11,50 €
53237	203	12,90 €
53238	203	18,40 €
53240	234	58,00 €
53241	361	9,00 €
53246	324	1.144,00 €
53249	231	192,00 €
53250	208	85,00 €
53251	213	88,00 €
53253	96	98,00 €
53256	368	34,00 €

REF.	SEITE	PREIS
53259	249	97,00 €
53260	249	168,00 €
53261	249	214,00 €
53262	250	251,00 €
53263	250	57,00 €
53264	250	143,00 €
53265	251	195,00 €
53266	251	224,00 €
53267	251	277,00 €
53268	258	92,00 €
53269	252	50,00 €
53270	270	70,00 €
53271	270	227,00 €
53272	271	195,00 €
53273	271	75,00 €
53274	284	30,50 €
53275	284	35,50 €
53276	285	160,00 €
53277	285	45,00 €
53278	285	143,00 €
53279	286	97,00 €
53280	286	112,00 €
53281	286	55,00 €
53282	287	48,00 €
53283	287	92,00 €
53284	287	306,00 €
53285	288	56,00 €
53286	288	87,00 €
53287	288	245,00 €
53288	289	72,00 €
53289	274	45,00 €
53290	274	51,00 €
53291	274	68,00 €
53292	275	116,00 €
53293	261	134,00 €
53294	261	119,00 €
53295	262	77,00 €
53296	262	60,00 €
53297	267	45,00 €
53298	267	91,00 €
53299	278	291,00 €
53300	278	41,00 €
53301	278	44,00 €
53302	279	44,00 €
53303	244	89,00 €
53304	244	279,00 €
53305	279	136,00 €
53306	244	53,00 €
53307	279	38,50 €
53308	245	55,00 €
53309	245	285,00 €
53310	245	498,00 €
53311	275	97,00 €
53312	246	127,00 €
53313	258	139,00 €
53314	258	98,00 €
53315	295	285,00 €

REF.	SEITE	PREIS
53316	280	34,00 €
53317	280	34,00 €
53318	261	24,00 €
53319	246	18,00 €
53320	289	12,00 €
53321	289	10,50 €
53324	264	12,50 €
53325	289	7,50 €
53326	290	16,00 €
53327	290	11,00 €
53328	226	76,00 €
53330	212	38,00 €
53331	67	31,80 €
53332	67	34,50 €
53339	70	9,50 €
53340	388	86,00 €
53343	149	285,00 €
53346	50	18,00 €
53347	205	100,00 €
53348	382	14,00 €
53349	392	14,00 €
53350	382	14,00 €
53351	384	12,50 €
53352	390	12,00 €
53353	387	18,00 €
53354	384	14,00 €
53355	393	11,50 €
53356	393	11,50 €
53357	394	7,00 €
53358	390	11,50 €
53359	390	16,00 €
53360	384	18,00 €
53361	384	24,00 €
53362	385	14,00 €
53363	382	34,00 €
53364	382	16,00 €
53365	385	14,00 €
53366	385	14,00 €
53367	393	9,50 €
53368	393	9,00 €
53369	385	14,00 €
53370	393	26,00 €
53371	383	29,00 €
53372	383	26,00 €
53373	383	14,50 €
53374	392	10,00 €
53376	392	10,50 €
53377	386	20,00 €
53378	390	13,00 €
53380	393	11,50 €
53381	390	14,50 €
53382	383	11,00 €
53383	383	11,50 €
53384	225	165,00 €
53385	61, 394	19,30 €
53388	233	90,00 €
53389	57	31,50 €

REF.	SEITE	PREIS
53390	58	34,50 €
53391	234	86,00 €
53393	234	118,00 €
53394	223	598,00 €
53395	218	16,00 €
53396	58	18,30 €
53399	92	3,50 €
53400	92	5,70 €
53401	92	7,40 €
53402	92	9,60 €
53403	92	6,50 €
53404	92	6,50 €
53405	92	5,30 €
53406	92	8,55 €
53407	92	12,70 €
53408	92	19,30 €
53409	92	9,00 €
53410	217	92,00 €
53411	60	5,00 €
53412	60	4,00 €
53414	333	49,00 €
53415	333	188,00 €
53416	158	14,10 €
53417	158	26,30 €
53418	158	16,90 €
53419	372	9,70 €
53420	44	72,00 €
53421	315	298,00 €
53422	314	368,00 €
53423	323	199,00 €
53426	217	39,80 €
53427	134	5,00 €
53428	139	18,00 €
53429	139	18,00 €
53430	178	286,00 €
53434	392	18,00 €
53441	201	9,80 €
53444	27	195,00 €
53445	60	17,10 €
53449	158	16,40 €
53450	158	28,30 €
53452	280	26,50 €
53453	218	7,00 €
53456	220	98,00 €
53459	221	66,00 €
53463	242	98,00 €
53464	209, 387	153,00 €
53468	52	8,50 €
53470	171	176,00 €
53472	204	12,00 €
53473	204	36,00 €
53474	234	94,00 €
53477	217	36,10 €
53478	52	4,55 €
53479	52	6,40 €
53480	52	19,90 €
53481	52	27,40 €

REF.	SEITE	PREIS
53484	332	615,00 €
53485	205	140,00 €
53486	183	29,30 €
53487	59	16,70 €
53488	229	61,00 €
53489	211	68,00 €
53490	209	275,00 €
53492	163, 410	380,00 €
53499	220	29,00 €
53500	220	29,00 €
53501	209	24,00 €
53502	236	38,70 €
53503	338	12,00 €
53504	410	38,00 €
53505	135	77,00 €
53506	135	36,00 €
53507	354	27,00 €
53508	365	14,00 €
53517	64	9,50 €
53518	310	3,50 €
53519	130	42,00 €
53520	146	228,00 €
53522	209	24,00 €
53523	275	91,00 €
53524	237	51,00 €
53525	182	12,00 €
53526	338, 348	119,00 €
53531	169	109,00 €
53532	164, 348	119,00 €
53533	409	1,50 €
53536	143	34,00 €
53537	204	14,50 €
53538	204	14,50 €
53539	219	66,00 €
53541	152	168,00 €
53542	159, 372	980,00 €
53543	337	13,80 €
53545	180	35,70 €
53547	56	14,70 €
53548	56	15,60 €
53549	56	14,30 €
53550	56	14,70 €
53551	374	16,00 €
53552	374	16,00 €
53553	374	16,00 €
53561	365	28,00 €
53565	24	258,00 €
53566	304	32,00 €
53567	161	43,00 €
53568	133	12,00 €
53569	133	18,00 €
53570	136	154,00 €
53572	161	348,00 €
53573	151	36,00 €
53574	31	47,00 €
53575	55	16,00 €
53576	153	189,00 €

REF.	SEITE	PREIS
53581	164, 348	119,00 €
53582	164, 348	174,00 €
53583	164, 348	174,00 €
53584	338, 348	119,00 €
53585	338, 348	168,00 €
53586	338, 348	168,00 €
53587	173	44,00 €
53588	146	178,00 €
53589	70	12,00 €
53590	321	1.190,00 €
53591	64	5,50 €
53592	312	25,00 €
53593	160	41,00 €
53594	163	54,00 €
53595	163	61,00 €
53596	376	3,65 €
53597	376	3,70 €
53598	376	3,95 €
53599	221, 389	30,30 €
53602	61	30,50 €
53603	61	45,00 €
53604	61	118,00 €
53605	372	141,00 €
53606	158	55,00 €
53608	148	98,00 €
53609	302	182,50 €
53610	302	294,00 €
53611	156	27,50 €
53612	310	96,00 €
53613	68	19,50 €
53614	68	21,50 €
53615	68	34,60 €
53616	68	10,40 €
53617	68	9,25 €
53618	68	13,90 €
53620	89	88,00 €
53621	355	2,50 €
53622	355	2,50 €
53623	355	2,50 €
53624	355	2,50 €
53625	160	68,00 €
53626	154, 184	18,00 €
53627	305	22,50 €
53629	164	14,30 €
53630	164	18,80 €
53631	164	33,50 €
53632	164	46,00 €
53633	164	46,00 €
53634	164	63,00 €
53635	225	85,00 €
53636	354	22,00 €
53637	215	85,00 €
53638	222	243,00 €
53639	47	28,60 €
53640	47	34,40 €
53641	47	41,00 €
53642	47	54,00 €

REF.	SEITE	PREIS
53643	47	92,00 €
53644	303	1.238,00 €
53645	303	268,00 €
53646	153	69,00 €
53648	290	107,00 €
53649	291	89,00 €
53650	212	47,00 €
53651	280	91,00 €
53652	237	53,00 €
53653	264	207,00 €
53654	47	81,00 €
53655	182	12,00 €
53656	334	198,00 €
53657	334	248,00 €
53658	334	99,00 €
53659	334	121,00 €
53660	334	146,00 €
53661	77	790,00 €
53662	214	89,00 €
53663	235	8,00 €
53664	238	38,00 €
53665	238	19,00 €
53666	238	28,00 €
53667	35	32,00 €
53668	35	34,00 €
53669	215	45,00 €
53670	202	29,50 €
53671	51, 89	41,00 €
53672	82	440,00 €
53673	183	80,00 €
53674	94	447,00 €
53675	186	50,00 €
53676	186	44,00 €
53677	186	55,00 €
53678	186	52,00 €
53681	149	743,00 €
53682	322	98,00 €
53683	196	116,00 €
53684	321	1.880,00 €
53685	189	310,00 €
53686	77	790,00 €
53687	328	298,00 €
53688	328	495,00 €
53689	147	238,00 €
53690	137	34,00 €
53691	137	36,00 €
53693	360	521,00 €
53694	54	18,40 €
53695	360	504,00 €
53696	209	22,00 €
53697	302	398,00 €
53698	360	717,00 €
53701	240	188,00 €
53702	97	28,50 €
53703	97	41,00 €
53704	97	42,00 €
53705	191	80,00 €

REF.	SEITE	PREIS
53706	291	98,00 €
53707	136	153,00 €
53708	74, 76, 77, 83	325,00 €
53710	404	16,00 €
53711	404	16,00 €
53712	403	16,00 €
53713	403	16,00 €
53714	403	16,00 €
53715	402	19,00 €
53716	402	19,00 €
53717	402	19,00 €
53718	401	19,00 €
53719	401	19,00 €
53720	401	19,00 €
53721	355	18,80 €
53724	332	46,00 €
53725	314	248,00 €
53726	148	128,00 €
53727	23	198,00 €
53728	23	198,00 €
53729	184	19,10 €
53733	147	238,00 €
53734	130	23,70 €
53735	203	44,00 €
53736	189	98,00 €
53737	45	12,50 €
53738	45	10,90 €
53739	45	10,50 €
53740	45	9,10 €
53741	204	14,00 €
53742	223	1.325,00 €
53743	32, 175	39,70 €
53744	170	63,00 €
53745	362	6,40 €
53746	362	6,40 €
53747	362	6,40 €
53748	362	6,60 €
53749	362	6,70 €
53750	362	6,70 €
53751	362	6,80 €
53752	362	6,95 €
53753	362	7,10 €
53754	362	7,40 €
53755	362	7,50 €
53756	362	7,90 €
53757	362	7,90 €
53758	362	8,20 €
53759	362	8,50 €
53760	362	9,60 €
53761	77	490,00 €
53762	77	490,00 €
53767	77	790,00 €
53768	77	490,00 €
53769	80, 297, 300	178,00 €
53770	80, 298, 300	198,00 €
53771	80, 299, 300	158,00 €

REF.	SEITE	PREIS
53772	80, 299, 300	229,00 €
53773	80, 297, 300	298,00 €
53774	80, 298, 300	190,00 €
53775	80, 300	1.109,00 €
53776	131	19,10 €
53778	354	4,50 €
53779	318	36,00 €
53780	132	14,50 €
53781	377	18,00 €
53782	96	14,00 €
53784	150	148,00 €
53785	376	4,80 €
53786	380	98,00 €
53791	378	4,80 €
53794	376	28,00 €
53796	380	76,00 €
53797	377	0,10 €
53802	380	120,00 €
53806	380	250,00 €
53808	379	16,50 €
53809	379	8,00 €
53811	379	8,90 €
53826	378	16,00 €
53827	378	32,00 €
53832	378	1,81 €
53838	380	38,00 €
53839	379	0,25 €
53845	318	64,00 €
53849	312	16,10 €
53850	123	14,90 €
53851	125	88,00 €
53852	125	207,00 €
53853	125	14,40 €
53854	125	27,00 €
53855	125	24,80 €
53856	125	62,00 €
53857	126	27,00 €
53858	126	28,80 €
53859	124	67,00 €
53860	124	3,65 €
53861	124	5,45 €
53862	377	6,00 €
53863	377	3,00 €
53864	369	138,00 €
53867	82	1.095,00 €
53868	74	1.090,00 €
53869	75	990,00 €
53870	75	990,00 €
53872	348	118,00 €
53873	307	285,00 €
53874	307	398,00 €
53875	216	134,00 €
53876	259	64,00 €
53877	411	430,50 €
53878	411	574,00 €
53879	411	838,50 €

REF.	SEITE	PREIS
53880	320	598,00 €
53881	164, 348	79,00 €
53882	164, 348	79,00 €
53883	50	18,40 €
53884	50	30,20 €
53885	50	35,70 €
53886	50	20,30 €
53887	50	30,30 €
53888	50	37,90 €
53895	317	107,00 €
53896	317	127,00 €
53897	317	140,00 €
53898	317	148,00 €
53902	378	25,00 €
53903	97	59,00 €
53904	77	790,00 €
53905	56	7,30 €
53906	56	8,65 €
53908	56	7,25 €
53909	56	9,70 €
53910	392	19,00 €
53911	57	8,80 €
53912	75	1.280,00 €
53913	75	1.280,00 €
53914	379, 412	75,00 €
53915	22	65,00 €
53917	54	9,00 €
53919	363	81,00 €
53921	190	39,00 €
53922	190	29,00 €
53927	329	66,00 €
53928	26	278,00 €
53929	329	95,00 €
53932	61	8,00 €
53939	74	1.280,00 €
53940	79, 344, 346, 379	13,20 €
53942	79, 344, 346, 379	0,50 €
53943	54, 86	21,50 €
53944	54, 86	19,50 €
53945	54, 86	18,90 €
53946	377	0,83 €
53947	336	145,00 €
53948	336	324,00 €
53949	409	4,50 €
53950	409	4,50 €
53951	80, 300	1.794,00 €
53952	80, 300	1.794,00 €
53953	20	29,00 €
53954	45	8,50 €
53955	45	10,00 €
53956	408	353,00 €
53957	377	0,26 €
53958	98	6,50 €
53964	364	9,65 €
53965	364	25,80 €
53967	57	10,20 €

REF.	SEITE	PREIS
53968	314	49,00 €
53969	323	96,00 €
53970	343	3.790,00 €
53972	52	550,00 €
53973	408	284,00 €
53974	134	38,00 €
53976	61	9,00 €
53977	332	17,50 €
53978	195	38,90 €
53979	45, 88	34,60 €
53980	45, 88	34,60 €
53981	333	143,00 €
53982	333	219,00 €
53983	188	215,00 €
53984	374	8,00 €
53985	374	8,00 €
53986	374	8,00 €
53987	344, 379	9,50 €
53988	173	101,00 €
53992	392	18,00 €
53993	66	77,00 €
53997	211	48,00 €
53999	127	2,00 €
54000	127	2,50 €
54001	317	285,00 €
54002	127	3,00 €
54003	238	104,00 €
54004	133	16,00 €
54005	46	14,00 €
54006	77	490,00 €
54008	127	3,50 €
54010	127	4,50 €
54011	127	5,00 €
54013	369	35,00 €
54015	57	10,20 €
54016	211	76,00 €
54017	182	12,00 €
54018	49	9,85 €
54019	49	17,90 €
54021	49	13,50 €
54022	49	9,95 €
54023	49	13,50 €
54024	49	17,90 €
54028	49	28,00 €
54029	49	28,00 €
54030	49	18,80 €
54031	49	19,30 €
54032	39, 88	84,00 €
54033	161	49,00 €
54034	9	178,00 €
54035	12	149,00 €
54036	13	99,00 €
54037	14	88,00 €
54038	15	88,00 €
54039	135	154,00 €
54040	330	240,00 €
54041	40	198,00 €

REF.	SEITE	PREIS
54042	358	13,00 €
54043	408	48,00 €
54044	143	99,00 €
54045	9	179,00 €
54046	12	150,00 €
54047	13	100,00 €
54048	14	89,00 €
54049	15	89,00 €
54050	306	895,00 €
54051	308	39,00 €
54053	342	248,00 €
54054	342	268,00 €
54055	342	220,00 €
54056	342	260,00 €
54057	342	248,00 €
54058	342	348,00 €
54059	343	428,00 €
54060	55	6,00 €
54061	55	6,00 €
54066	39, 87	83,00 €
54068	200	120,00 €
54069	221	29,50 €
54070	55	18,00 €
54071	55	26,50 €
54072	358	38,50 €
54073	363	70,00 €
54074	363	18,50 €
54076	409	9,00 €
54078	144	68,00 €
54079	41	83,00 €
54080	96	53,50 €
54081	43	28,00 €
54082	11	189,00 €
54083	49	9,75 €
54084	49	13,10 €
54085	49	17,80 €
54086	49	9,25 €
54087	49	17,30 €
54088	135	132,00 €
54089	65	17,50 €
54090	21	56,00 €
54091	35, 345	441,00 €
54092	291	24,00 €
54093	35, 79, 87, 345, 346	441,00 €
54097	41	38,90 €
54098	47	158,50 €
54099	66	13,80 €
54100	302	265,00 €
54101	38	61,00 €
54105	21	33,00 €
54106	17, 46	89,00 €
54108	18	66,00 €
54109	20	34,00 €
54110	40	46,00 €
54111	333	4,75 €
54112	62	18,00 €
54113	333	7,65 €

REF.	SEITE	PREIS
54114	79, 330, 346	248,00 €
54115	43	26,80 €
54116	18	66,00 €
54117	38	74,00 €
54119	44	78,00 €
54120	41	59,00 €
54122	131	38,00 €
54123	131	40,00 €
54124	131	47,00 €
54125	337	152,00 €
54126	54	39,00 €
54129	79, 346	110,00 €
54130	79, 345, 346	58,00 €
54131	345	58,00 €
54132	79, 346	190,00 €
54133	135	547,00 €
54134	78, 84	1.415,00 €
54135	197	82,00 €
54136	372	107,00 €
54137	315	288,00 €
54139	218	147,00 €
54140	17	36,00 €
54141	22	42,00 €
54142	62	15,20 €
54143	318	249,00 €
54144	318	298,00 €
54145	318	377,00 €
54146	318	492,00 €
54147	318	198,00 €
54149	42	60,00 €
54150	42	23,50 €
54151	374	9,00 €
54152	374	9,00 €
54153	374	9,00 €
54154	29	37,50 €
54155	374	8,00 €
54156	374	8,00 €
54157	374	8,00 €
54158	86	38,00 €
54159	43	47,00 €
54160L	143	17,50 €
54160R	143	17,50 €
54161	142	90,00 €
54162	142	81,00 €
54163	142	80,00 €
54164	29	34,00 €
54166	363	32,40 €
54168	20	49,00 €
54169	363	13,80 €
54170	363	16,50 €
54172	137	81,00 €
54173	137	87,00 €
54174	41	139,00 €
54175	326	34,00 €
54176	350	188,00 €
54177	374	16,00 €

REF.	SEITE	PREIS
54178	374	16,00 €
54179	374	16,00 €
54181	310	25,10 €
54182	310	34,70 €
54183	310	38,20 €
54184	310	44,00 €
54186	206	250,00 €
54187	46	39,30 €
54188	376	19,00 €
54189	376	19,00 €
54190	376	19,00 €
54191	376	19,00 €
54192	375	8,90 €
54193	375	8,90 €
54194	375	8,90 €
54195	375	8,90 €
54198	372	59,00 €
54199	292	94,00 €
54200	296	56,00 €
54201	264	37,60 €
54202	246	68,00 €
54203	247	91,00 €
54204	265	124,00 €
54205	281	49,00 €
54206	252	113,00 €
54207	270	38,90 €
54208	265	76,00 €
54209	265	29,70 €
54210	276	84,00 €
54211	247	74,00 €
54212	247	39,40 €
54213	260	19,80 €
54214	281	96,00 €
54215	248	57,00 €
54216	248	49,00 €
54217	281	104,00 €
54218	292	142,00 €
54219	253	60,00 €
54220	208	197,00 €
54221	282	111,00 €
54222	253	59,00 €
54223	266	149,00 €
54224	266	64,50 €
54225	276	133,00 €
54226	295	71,00 €
54227	253	122,00 €
54228	254	187,00 €
54229	337	48,00 €
54230	337	68,00 €
54231	337	138,00 €
54232	337	248,00 €
54233	79, 346	1.856,00 €
54234	79, 346	1.856,00 €
54235	79, 346	1.856,00 €
54236	79, 346	1.856,00 €
54237	78	1.887,00 €
54238	78	1.887,00 €

REF.	SEITE	PREIS
54239	78	1.887,00 €
54240	78	1.887,00 €
54241	79, 346	120,00 €
54246	182	104,00 €
54247	182	99,00 €
54248	158	58,00 €
54249	158	103,00 €
54250	10	188,00 €
54251	157	43,00 €
54252	340	199,00 €
54253	227	166,00 €
54254	62	43,00 €
54255	156, 312	68,00 €
54256	330	48,00 €
54257	319	318,00 €
54258	19	58,00 €
54260	266	277,00 €
54261	24	321,00 €
54262	323	88,00 €
54263	323	130,00 €
54264	323	240,00 €
54265	343	1.290,00 €
54266	29	39,50 €
54267	133	9,50 €
54269	51	56,00 €
54270	136	42,00 €
54271	136	54,00 €
54273	214	10,10 €
54274	214	11,00 €
54275	214	13,20 €
54277	19	53,50 €
54278	409	4,50 €
54279	58	6,00 €
54280	237	156,50 €
54288	259	72,50 €
54289	277	38,00 €
54290	306	4.307,00 €
54291	220	5.054,00 €
54293	254	17,50 €
54294	374	8,00 €
54295	81	500,00 €
54296	81	520,00 €
54297	81	540,00 €
54298	354	7,50 €
54299	227	227,00 €
54302	53	11,50 €
54304	50	26,00 €
54305	351	232,50 €
54306	352	219,50 €
54308	352	89,00 €
54309	352	71,00 €
54310	352	57,00 €
54311	58	13,00 €
54312	210	191,50 €
54313	126	43,00 €
54314	126	82,00 €
54316	172	182,00 €

REF.	SEITE	PREIS
54317	226	124,00 €
54318	271	105,00 €
54321	343	898,00 €
54322	344, 379	19,00 €
54323	259	119,00 €
54324	257	11,00 €
54325	409	22,50 €
54326	79, 344, 346, 379	7,30 €
54327	72	2.788,00 €
54328	94	199,00 €
54329	371	37,50 €
54330	58	12,50 €
54331	65	27,00 €
54336	150	259,00 €
54338	39	60,00 €
54339	51	273,00 €
54340	147	296,00 €
54341	335	643,00 €
54342	335	858,00 €
54343	53	31,00 €
54344	132	10,50 €
54345	206	15,00 €
54346	127	11,50 €
54347	214	46,00 €
54348	126	291,00 €
54349	325	8,00 €
54350	325	12,50 €
54351	325	14,00 €
54352	325	18,00 €
54353	325	23,50 €
54354	325	34,50 €
54355	325	12,00 €
54356	326	19,50 €
54357	325	15,00 €
54358	325	18,50 €
54359	326	14,00 €
54360	325	14,00 €
54361	325	14,00 €
54362	326	14,00 €
54363	325	14,00 €
54364	326	14,00 €
54365	325	12,50 €
54366	326	18,50 €
54367	306	729,00 €
54368	219	2.329,00 €
54369	374	16,00 €
54370	374	16,00 €
54371	374	16,00 €
54372	198	157,00 €
54373	210	395,00 €
54374	96	75,50 €
54376	58	12,00 €
54379	131	28,00 €
54380	233	119,00 €
54381	233	5,00 €
54382	233	5,00 €
54383	233	5,00 €

REF.	SEITE	PREIS
54384	222	32,50 €
54386	324, 346	5.839,00 €
54388	93	366,00 €
54389	76	790,00 €
54390	389	199,00 €
54391	207	221,00 €
54392	207	1.855,00 €
54393	95	92,00 €
54394	95	64,00 €
54395	95	53,00 €
54396	320	2.250,00 €
54397	147	249,00 €
54398	254	41,00 €
54399	255	56,50 €
54400	255	141,00 €
54401	255	57,00 €
54402	256	201,00 €
54403	256	225,00 €
54404	256	131,00 €
54405	257	111,00 €
54406	257	73,00 €
54407	292	59,50 €
54408	293	46,00 €
54409	293	32,00 €
54410	293	33,50 €
54411	294	36,00 €
54412	294	57,00 €
54413	294	115,00 €
54414	272	97,50 €
54415	272	60,00 €
54416	272	31,00 €
54417	273	153,00 €
54418	273	37,00 €
54419	262	57,00 €
54420	263	102,00 €
54421	263	52,00 €

REF.	SEITE	PREIS
54422	267	140,00 €
54423	268	108,00 €
54424	263	64,50 €
54425	268	124,00 €
54426	268	69,00 €
54427	269	113,00 €
54428	269	31,00 €
54429	269	55,00 €
54430	248	34,00 €
54431	295	184,00 €
54432	260	43,00 €
54433	260	18,00 €
54434	282	48,50 €
54435	282	14,50 €
54436	283	124,00 €
54437	283	110,00 €
54438	277	40,00 €
54439	277	32,50 €
54479	59	36,50 €
54480	409	1,00 €
54482	334	677,00 €
54483	325	14,00 €
54484	325	26,00 €
54485	325	36,00 €
54486	325	9,50 €
54487	326	15,00 €
54488	325	15,00 €
54489	326	19,50 €
54490	326	15,00 €
54491	326	17,50 €
54492	326	19,50 €
54493	325	13,50 €
54494	325	14,00 €
54495	326	18,00 €
54496	326	16,50 €
54497	326	12,50 €

REF.	SEITE	PREIS
54498	309	6.090,00 €
54501	80, 300	1.794,00 €
54502	80, 300	1.794,00 €
54503	76	490,00 €
54534	355	24,00 €
60001	116	88,00 €
60003	116	110,00 €
60004	117	79,00 €
60005	105	132,00 €
60006	106	182,00 €
60007	111	170,00 €
60009	108	168,00 €
60010	111	170,00 €
60011	112	175,00 €
60012	122	48,00 €
60013	122	80,00 €
60015	122	138,00 €
60016	122	49,00 €
60017	122	64,00 €
60019	110	178,00 €
60020	110	175,00 €
60022	112	470,00 €
60023	106	212,00 €
60024	105	190,00 €
60025	105, 122	31,60 €
60026	105, 122	379,00 €
60027	118	99,00 €
60028	109	142,00 €
60029	119	240,00 €
60030	119	112,00 €
60031	120	142,00 €
60032	113	123,00 €
60033	108	104,00 €
60035	117	30,00 €
60037	114	222,00 €
60038	113, 312	255,00 €

REF.	SEITE	PREIS
60039	118	265,00 €
60040	120	440,00 €
60041	114	77,00 €
60042	115	106,00 €
60043	115	123,00 €
60044	103	330,00 €
60044C	103	485,00 €
60045	121	298,00 €
60046	102	174,00 €
60046C	102	339,00 €
60047C	107	318,00 €
60048	104	366,00 €
60048C	104	560,00 €
60049C	109	329,00 €
70001	406	35,00 €
70002	406	35,00 €
70003	406	35,00 €
70004	406	42,00 €
70005	406	42,00 €
70006	406	42,00 €
70009	406	35,00 €
70011	406	42,00 €
70012	406	42,00 €
70013	406	44,00 €
70014	406	44,00 €
70015	406	44,00 €
70016	406	44,00 €
70017	406	44,00 €
90003	160	35,20 €
90004	160	25,80 €
JBMW-BEXP	362	24,50 €
METEXP	361, 406, 410	62,00 €
SERIE124	360	710,00 €
SERIE262	154, 184	199,00 €





www.jbmcamp.com



JBMprofessionaltools



@jbmttools



jbmttools



JBM Campllong S.L.U.



CAT2024DE



8 435034 988734