



VOTRE OUTIL



2024



SETS D'OUTILS

7

SETS D'OUTILS
JEUX DE DOUILLES
BOÎTES À OUTILS / MALLETES
JEUX DE DOUILLES
JEUX DE CLIQUETS MIN
SETS D'ADAPTATEURS
JEUX DE DOUILLES
JEUX DE DOUILLES À EMBOUT
OUTILS ISOLÉS



OUTILS À MAIN

37

CLÉS
BARRES DE SERRAGE
CLIQUET
CLÉS DYNAMOMÉTRIQUES
BARRES D'EXTENSION
TOURNEVIS
PINCES
OUTILS D'INSPECTION
MARTEAUX
OUTILS DE COUPE
CISEAUX
RIVETEUSES
OUTILS DE MESURE
DIVERS



MEUBLES D'ATELIER

71

CHARIOTS À OUTILS
SETS À OUTILS
ACCESSOIRES POUR CHARIOT
TABLES DE TRAVAIL
STOCKAGE
TABOURETS / CHARIOT DE MECANICIEN
ÉTAUX/ENCLUMES



OUTILS ÉLECTRIQUES SANS FIL

101

VISSAGE
PERÇAGE
SABLAGE/POLISSAGE
SCIE
OUTILS SPÉCIAUX
OUTILS ÉLECTRIQUES DE JARDINAGE
BATTERIES/CHARGEURS
ACCESSOIRES/CONSOMMABLES



ÉCLAIRAGE

129

LAMPES D'INSPECTION
LAMPES FRONTALES
LAMPE À LOUPE LED
INONDATION LED
BONNET D'ÉCLAIRAGE
BALISES
LAMPE DE TRAVAIL LED
SIGNALISATION
ACCESSOIRES ET PIÈCES DÉTACHÉES



OUTILS PNEUMATIQUES

145

VISSAGE
 PERÇAGE
 DÉCOUPAGE / SERVANT
 SABLAGE/POLISSAGE
 SOUFFLETTES À AIR
 ENTRETIEN DES PNEUS
 AUTRES
 ENROULEUR DE TUYAU À AIR
 TUYAUX DE RACCORDEMENT
 ACCESSOIRES ET CONSOMMABLES



OUTILS D'IMPACT

167

DOUILLES D'IMPACT
 OUTILS SPÉCIAUX POUR PNEUS
 ADAPTATEURS
 PIÈCES DÉTACHES DOUILLES D'IMPACT
 OUTILS SPÉCIAUX POUR CAMIONS



TRAVAUX DE CARROSSERIE

179

OUTILLAGE DE CARROSSERIE
 RESTAURATION DE PHARES
 REMPLACEMENT DE VITRES
 RÉPARATION DE CHÂSSIS
 MOBILIER AUXILIAIRE
 ENTRETIEN D'INTÉRIEUR



FREINS

193

OUTILS DE TRACTION
 PURGEUR DE FREINS
 MAINTENANCE



OUTIL SPÉCIAL

199

SYSTÈME DE LUBRIFICATION
 EXTRACTEURS D'INJECTEURS
 BLOC/CYLINDRE
 EMBRAYAGE
 SYSTÈME DE REFROIDISSEMENT
 SYSTÈME A/C
 TRANSMISSION
 SUSPENSION
 ÉCHAPPEMENT
 SYSTÈME ÉLECTRIQUE
 RÉPARATION DE BOBINES
 MOTO
 EXTRACTEURS



OUTILS DE CHRONOMÉTRAGE

243

FIAT/ALFA ROMEO
BMW/MINI
PSA
FORD
JAGUAR/LAND ROVER
JEEP/CHRYSLER

MERCEDES-BENZ
RENAULT/DACIA/NISSAN
OPEL/VAUXHALL
VAG
OUTILS SUPPLÉMENTAIRES
AUTRES



ACCESSOIRES POUR LUBRIFIANTS

301

POMPES D'ALIMENTATION EN CARBURANT DIESEL
POMPES D'ALIMENTATION EN URÉE
POMPES D'EXTRACTION/DE REMPLISSAGE
COLLECTEURS D'HUILE
PISTOLETS D'ASPIRATION
SEAUX COLLECTEURS D'HUILE
AUTRES



OUTILS HYDRAULIQUES

313

CRICS À ROULETTES
CRICS À BOUTEILLES
CRICS GRIFFÉS
CRICS HYDRAULIQUE TÉLESCOPIQUE
BÉQUILLES POUR CRIC DE VOITURE
AUTRES
TRANSPALETTE MANUELLE
PRESSES
GRUES
TABLES ÉLÉVATRICES
TAMPON EN CAOUTCHOUC POUR ÉLÉVATEUR



OUTILLAGE ELECTRIQUE

327

DÉMARREUR DE SAUT
ENTRETIEN DE LA BATTERIE
MULTIMETRES
INSPECTION VISUELLE
SOUDURE
ÉQUIPEMENT D'ATELIER
CLIMATISATION
THERMOMÈTRES
AUTRES



ÉNERGIES RENOUVELABLES ET MOBILITÉ DU FUTUR

341

CÂBLES DE RECHARGE POUR VOITURES ÉLECTRIQUES
CHARGEURS POUR VOITURES ÉLECTRIQUES
GÉNÉRATEUR D'ÉLECTRICITÉ
OUTILS ISOLÉS



ACCESSOIRES D'ATELIER

347

ENROULEURS DE TUYAUX
ÉCHELLES
CHARIOTS ET PLATEFORMES



ACCESSOIRES POUR VÉHICULES

353

SIGNALISATION
TROUSSE DE PREMIERS SECOURS
AMPOULES
KITS DE PREMIERS SECOURS
SÉCURITÉ
JEUX DE SOUFFLETS DE CARDAN ET PINCES
BALAIS
ESSUIE-GLACES
VÉLO
AUTRES
CAPTEURS DE STATIONNEMENT
TUBES FLEXIBLES



ACCESSOIRES POUR PNEUS

367

POIDS DE ROUE
RÉPARATION DE CREVAISONS
VALVES PNEUMATIQUES
DÉMONTAGE ET INSTALLATION

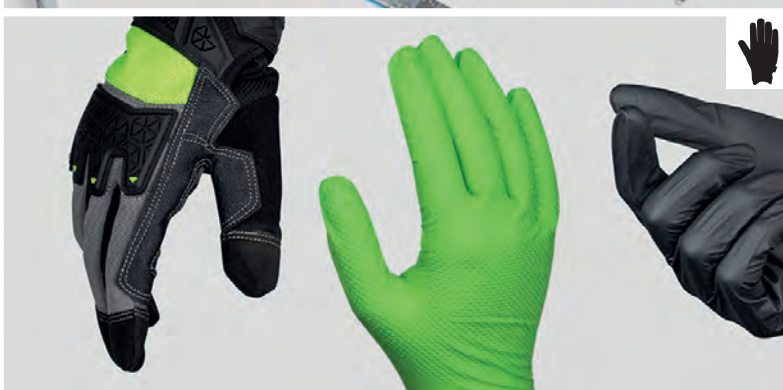

SÉCURITÉ ET EPI

373

GANTS/EPI
MASQUES / DISPENSEURS
DELIMITATION
MESUREUR D'OZONE



CONSOMMABLES

381

GOUPILLES ET CIRCLIPS
RONDELLES
VIS ÉCROU RONDELLES
RONDELLES POUR CARROSSERIE
AUTRES
JOINTS TORIQUES
CONNECTEURS DE TUYAUX
ÉLECTRIQUE
PINCES ET AGRAFES EN PLASTIQUE



VÊTEMENTS DE TRAVAIL

405

GILETS
VESTES



PROMOTIONNEL

407

PRODUITS PROMOTIONNELS
PRÉSENTOIRS / ACCESSOIRES
EMBALLAG

JBM VOTRE OUTIL

JBM est votre marque d'outils professionnels

Entreprise leader spécialisée dans l'industrie et l'automobile

+7.000

PRODUITS
DISPONIBLES

+23.000

EUROPALETTES
EN STOCK

+68

NOUS EXPORTONS
VERS PLUS DE 68 PAYS

+550

NOUVEAUX
PRODUITS PAR AN

PLUS DE 30 ANS D'EXPÉRIENCE

Chez JBM, nous sommes des spécialistes de la distribution d'outils et d'équipements automobiles, offrant un service de proximité et de qualité à nos plus de 11 000 clients répartis dans plus de 68 pays.

EXPERTS EN DISTRIBUTION ET LOGISTIQUE

JBM dispose d'un réseau logistique en constante amélioration, qui permet une distribution rapide et efficace non seulement dans la péninsule ibérique mais aussi à tous les clients internationaux.

LARGE GAMME DE PRODUITS

Nous vous proposons une gamme complète de plus de 7 000 références en caisses à outils, mallettes à outils, outillage à main en tous genres, armoires à outils, outillage d'atelier, éclairage, mallettes consommables...



**UN SERVICE
DE QUALITÉ
SOUTENU PAR PLUS
DE 11.000 CLIENTS**

**LIVRAISONS
INTERNATIONALES
NOUS EXPORTONS VERS
PLUS DE 68 PAYS**

**SIÈGE SOCIAL EN
ESPAGNE ET ENTREPÔT
DE PLUS DE 6 000 M²**

SETS D'OUTILS

- 9 SETS D'OUTILS
- 17 JEUX DE DOUILLES
- 24 BOÎTES À OUTILS / MALLETES
- 28 JEUX DE DOUILLES
- 32 JEUX DE CLIQUETS MIN
- 32 SETS D'ADAPTATEURS
- 33 JEUX DE DOUILLES
- 34 JEUX DE DOUILLES À EMBOUT
- 35 OUTILS ISOLÉS



DES OUTILS DE HAUTE QUALITÉ POUR LE QUOTIDIEN

01

CONÇU POUR UNE PERFORMANCE OPTIMALE DANS TOUS LES TYPES DE TRAVAUX

02

MATÉRIAU RÉSISTANT AVEC FINITION EN ACIER CHROMÉ DE QUALITÉ OPTIMALE

03

POIGNÉE ERGONOMIQUE DE GRAND DIAMÈTRE POUR UNE MEILLEURE CAPACITÉ DE TORSION



54034

178,00€

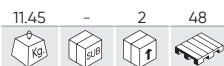

COFFRET À OUTILS DE 216 PIÈCES AVEC DOUILLES HEXAGONALES ZINGUÉ



ACIER ZINGUÉ

54045

179,00€



COFFRET À OUTILS 216 PIÈCES 6 PANS - CHROME



CHROMÉ



CONTIENT

	1/2" x14	13, 14, 15, 16, 17, 18, 19, 20, 21, 22, 24, 27, 30, 32mm
	3/8" x10	10, 11, 12, 13, 14, 15, 16, 17, 18, 19mm
	1/4" x13	4, 4.5, 5, 5.5, 6, 7, 8, 9, 10, 11, 12, 13, 14mm
	1/2" x5	16, 17, 18, 19, 22mm
	3/8" x6	10, 11, 12, 13, 14, 15mm
	1/4" x7	4, 5, 6, 7, 8, 9, 10mm
	1/2" x3	E20, E22, E24
	3/8" x6	E10, E11, E12, E14, E16, E18
	1/4" x5	E4, E5, E6, E7, E8
		x3 1/2" - 3/8" - 1/4"
	1/2" x2	125, 250mm
	3/8" x1	125mm
	1/4" x2	50, 100mm
	x3	1/2" - 3/8" - 1/4"
	1/2" x1	adaptateur 3/8" H x 1/2" M
	1/2" x1	8mm
	3/8" x1	8mm
	1/4" x1	6mm

	1/2" x2	16, 21mm
	3/8" x1	18mm
	1/2" x12	8, 9, 10, 11, 12, 13, 14, 15, 16, 17, 18, 19mm
	1/2" x7	1.27, 1.5, 2, 2.5, 3, 4, 5mm
	1/4" x1	
	1/4" x1	
	1/4" x1	
	1/2" x1	T70
	1/2" x1	14mm
	x3	PH0, PH1, PH2
	x3	P20, P21, P22
	x4	3, 4, 5, 6mm
	1/4" x4	SL4, SL5.5, SL6.5, SL7
	x8	T8, T9, T10, T15, T20, T25, T27, T30
	x8	T8, T9, T10, T15, T20, T25, T27, T30

	8mm x4	7, 8, 10, 12mm
	6mm x6	2, 2.5, 3, 4, 5, 6mm
	8mm x3	SL8, SL10, SL12
	8mm x3	PH2, PH3, PH4
	8mm x3	P22, P23, P24
	8mm x5	T40, T45, T50, T55, T60
	6mm x3	T5, T6, T7
	8mm x5	T40, T45, T50, T55, T60
	6mm x1	T7
	8mm x4	M10, M11, M12, M13
	6mm x5	M5, M6, M7, M8, M9
	8mm x2	M10, M12
	6mm x3	M5, M6, M8
	8mm x1	TS50
	6mm x8	TS10, TS15, TS20, TS25, TS27, TS30, TS40, TS45
	x4	0, 1, 2, 3mm
	x3	6, 8, 10mm
	6mm x4	4, 6, 8, 10mm
	x3	1, 2, 3mm
	x4	1, 2, 3, 4mm
	6mm x1	1/4"

54250

188,00€

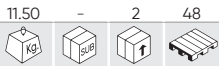

COFFRET À OUTILS 216 PIÈCES 12 PANS - ZINGUÉ



ACIER ZINGUÉ



CONTIENT

	1/2" x14	13, 14, 15, 16, 17, 18, 19, 20, 21, 22, 24, 27, 30, 32mm
	3/8" x10	10, 11, 12, 13, 14, 15, 16, 17, 18, 19mm
	1/4" x13	4, 4.5, 5, 5.5, 6, 7, 8, 9, 10, 11, 12, 13, 14mm
	1/2" x5	16, 17, 18, 19, 22mm
	3/8" x6	10, 11, 12, 13, 14, 15mm
	1/4" x7	4, 5, 6, 7, 8, 9, 10mm
	1/2" x3	E20, E22, E24
	3/8" x6	E10, E11, E12, E14, E16, E18
	1/4" x5	E4, E5, E6, E7, E8
	12	x3 1/2" - 3/8" - 1/4"
	1/2"	x2 125, 250mm
	3/8"	x1 125mm
	1/4"	x2 50, 100mm
	1/2"	x3 1/2" - 3/8" - 1/4"
	1/2"	x1 adaptateur 3/8" H x 1/2" M

	1/2"	x1 8mm
	3/8"	x1 8mm
	1/4"	x1 6mm
	1/2"	x2 16, 21mm
	3/8"	x1 18mm
	1/2"	x12 8, 9, 10, 11, 12, 13, 14, 15, 16, 17, 18, 19mm
	1/2"	x7 1.27, 1.5, 2, 2.5, 3, 4, 5mm
	1/4"	x1
	1/4"	x1
	1/4"	x1
	1/2"	x1 T70
	1/2"	x1 14mm
		x3 PH0, PH1, PH2
		x3 PZ0, PZ1, PZ2
		x4 3, 4, 5, 6mm
	1/4"	x4 SL4, SL5.5, SL6.5, SL7
		x8 T8, T9, T10, T15, T20, T25, T27, T30
		x8 T8, T9, T10, T15, T20, T25, T27, T30

	8mm	x4 7, 8, 10, 12mm
	6mm	x6 2, 2.5, 3, 4, 5, 6mm
	8mm	x3 SL8, SL10, SL12
	8mm	x3 PH2, PH3, PH4
	8mm	x3 PZ2, PZ3, PZ4
	8mm	x5 T40, T45, T50, T55, T60
	6mm	x3 T5, T6, T7
	8mm	x5 T40, T45, T50, T55, T60
	6mm	x1 T7
	8mm	x4 M10, M11, M12, M13
	6mm	x5 M5, M6, M7, M8, M9
	8mm	x2 M10, M12
	6mm	x3 M5, M6, M8
	8mm	x1 TS50
	6mm	x8 TS10, TS15, TS20, TS25, TS27, TS30, TS40, TS45
		x4 0, 1, 2, 3mm
		x3 6, 8, 10mm
	6mm	x4 4, 6, 8, 10mm
		x3 1, 2, 3mm
		x4 1, 2, 3, 4mm
	6mm	x1 1/4"

54082

189,00€

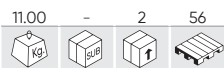

COFFRET À OUTILS 132 PIÈCES 6 PANS ZINGUÉES

132 PCS CrV

ACIER ZINGUÉ



SPÉCIAL AUTOMOBILE



CONTIENT

	1/2" x7 19, 21, 22, 24, 27, 30, 32mm
	3/8" x12 8, 9, 10, 11, 12, 13, 14, 15, 16, 17, 18, 19mm
	1/4" x11 4, 5, 5.5, 6, 7, 8, 9, 10, 11, 12, 13mm
	3/8" x4 13, 14, 15, 17mm
	1/4" x4 8, 10, 12, 13mm
	3/8" x6 E8, E10, E11, E14, E16, E20
	1/2" x1
	3/8" x1
	1/4" x1
	1/2" x2 127, 254mm
	3/8" x2 76, 152mm
	1/4" x1 50mm
	x1 Ø14mm
	x1

	x1 3/8"(H) - 1/2"(M)
	x1 3/8"(H) - 1/2"(M)
	x1 3/8"(H) - 1/2"(M)
	1/2" x1
	3/8" x1
	1/4" x1
	1/2" x3 17, 19, 21mm
	1/4" x1 6mm
	x1
	x1 PH2x100
	x1 SL6x100
	x12 8, 9, 10, 11, 12, 13, 14, 15, 16, 17, 18, 19mm
	x1
	1/2" x1 H17
	x1

	1/2" x1 21mm
	3/8" x2 16, 18mm
	1/2" x1 T52
	1/2" x1 M16
	x2 5.5, 6.5mm
	x2 PH1, PH3
	3/8" x2 PZ1, PZ3
	x4 4, 5, 6, 8mm
	x6 T20, T30, T40, T45, T50, T55
	x3 4, 5, 6.5mm
	x3 PH1, PH2, PH3
	6mm x3 PZ1, PZ2, PZ3
	x4 3, 4, 5, 6
	x7 T10, T15, T20, T25, T27, T30, T40
	x9 1.5, 2, 2.5, 3, 4, 5, 6, 8, 10mm

54035

149,00€

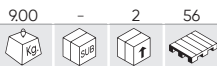

COFFRET À OUTILS DE 179 PIÈCES AVEC DOUILLES HEXAGONALES ZINGUÉ



ACIER ZINGUÉ

54046

150,00€

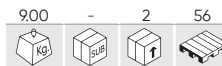

COFFRET À OUTILS 179 PIÈCES 6 PANS - CHROME



CHROMÉ



CONTIENT

	1/2" x17	10, 11, 12, 13, 14, 15, 16, 17, 18, 19, 20, 21, 22, 24, 27, 30, 32mm
	3/8" x10	10, 11, 12, 13, 14, 15, 16, 17, 18, 19mm
	1/4" x13	4, 4.5, 5, 5.5, 6, 7, 8, 9, 10, 11, 12, 13, 14mm
	1/2" x5	16, 17, 18, 19, 22mm
	3/8" x6	10, 11, 12, 13, 14, 15mm
	1/4" x7	4, 5, 6, 7, 8, 9, 10mm
	1/2" x2	E20, E24
	3/8" x6	E10, E11, E12, E14, E16, E18
	1/4" x5	E4, E5, E6, E7, E8
	1/2" x3	1/2" - 3/8" - 1/4"
	1/2" x2	125, 250mm
	3/8" x1	125mm
	1/4" x2	50, 100mm

	x3	1/2" - 3/8" - 1/4"
	1/2" x2	16, 21mm
	3/8" x1	18mm
	1/2" x1	8mm
	3/8" x1	8mm
	1/4" x1	6mm
	x7	1.27, 1.5, 2, 2.5, 3, 4, 5mm
	x1	1/4"
	x1	1/4"
	x3	PH1, PH2, PH3
	x3	PZ1, PZ2, PZ3
	x5	2, 3, 4, 5, 6mm
	x3	SL4, SL5.5, SL7
	x8	T8, T9, T10, T15, T20, T25, T27, T30
	x8	T8, T9, T10, T15, T20, T25, T27, T30

	x11	T5, T6, T7, T8, T9, T10, T15, T20, T25, T27, T30
	x9	T7, T10, T15, T20, T25, T27, T30, T40, T45
	x5	M5, M6, M7, M8, M9
	x3	M5, M6, M8
	x2	PH3, PH4
	x2	PZ3, PZ4
	x5	7, 8, 10, 12, 14mm
	x3	SL8, SL10, SL12
	x6	T40, T45, T50, T55, T60, T70
	x6	T40, T45, T50, T55, T60, T70

54036

99,00€

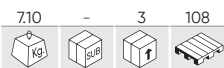

COFFRET À OUTILS DE 113 PIÈCES AVEC DOUILLES HEXAGONALES ZINGUÉ



ACIER ZINGUÉ

54047

100,00€



COFFRET À OUTILS 113 PIÈCES 12 PANS - CHROME



CHROMÉ



CONTIENT

	1/2"	x17	10, 11, 12, 13, 14, 15, 16, 17, 18, 19, 20, 21, 22, 24, 27, 30, 32mm
	1/4"	x13	4, 4.5, 5, 5.5, 6, 7, 8, 9, 10, 11, 12, 13, 14mm
	1/2"	x5	14, 15, 17, 19, 22mm
	1/4"	x8	6, 7, 8, 9, 10, 11, 12, 13mm
	1/2"	x8	E10, E11, E12, E14, E16, E18, E20, E24
	1/4"	x5	E4, E5, E6, E7, E8
		x2	1/2" - 1/4"
	1/2"	x2	125, 250mm
	1/4"	x2	50, 100mm

		x2	1/2" - 1/4"
	1/2"	x1	adaptateur 3/8" H x 1/2" M
	1/2"	x1	8mm
		x5	7, 8, 10, 12, 14mm
		x3	SL8, SL10, SL12
		x2	PH3, PH4
	8mm	x2	PZ3, PZ4
		x5	T40, T45, T50, T55, T60
		x5	5, 6, 8, 10, 12mm

	1/2"	x2	16, 21mm
		x3	1.5, 2, 2.5mm
		x1	1/4"
		x1	1/4"
		x2	PH1, PH2
		x2	PZ1, PZ2
	1/4"	x4	3, 4, 5, 6mm
		x3	SL4, SL5.5, SL6.5
		x7	T8, T10, T15, T20, T25, T27, T30

54037

88,00€

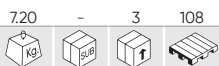

COFFRET À OUTILS DE 108 PIÈCES AVEC DOUILLES HEXAGONALES ZINGUÉ



ACIER ZINGUÉ

54048

89,00€

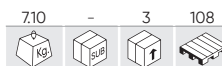

COFFRET À OUTILS 108 PIÈCES 6 PANS - CHROME



CHROMÉ



CONTIENT

	1/2"	x17	10, 11, 12, 13, 14, 15, 16, 17, 18, 19, 20, 21, 22, 24, 27, 30, 32mm
	1/4"	x13	4, 4.5, 5, 5.5, 6, 7, 8, 9, 10, 11, 12, 13, 14mm
	1/2"	x5	14, 15, 17, 19, 22mm
	1/4"	x8	6, 7, 8, 9, 10, 11, 12, 13mm
	1/2"	x8	E10, E11, E12, E14, E16, E18, E20, E24
	1/4"	x5	E4, E5, E6, E7, E8
	1/2"	x2	1/2" - 1/4"
	1/2"	x2	125, 250mm
	1/4"	x2	50, 100mm
	1/2"	x2	1/2" - 1/4"
	1/2"	x1	adaptateur 3/8" H x 1/2" M

	1/2"	x2	16, 21mm
	1/2"	x1	8mm
		x3	1.5, 2, 2.5mm
		x1	1/4"
		x1	1/4"
		x2	PH3, PH4
		x2	PZ3, PZ4
	8mm	x5	7, 8, 10, 12, 14mm
		x3	SL8, SL10, SL12
		x5	T40, T45, T50, T55, T60

		x2	PH1, PH2
		x2	PZ1, PZ2
	1/4"	x4	3, 4, 5, 6mm
		x3	SL4, SL5.5, SL6.5
		x7	T8, T10, T15, T20, T25, T27, T30

54038

88,00€

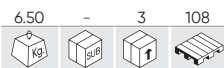

COFFRET À OUTILS DE 94 PIÈCES AVEC DOUILLES HEXAGONALES ZINGUÉ



ACIER ZINGUÉ



PIÈCES DE RECHANGE

54049

89,00€



COFFRET À OUTILS 94 PIÈCES 6 PANS - CHROMÉ



CHROMÉ



PIÈCES DE RECHANGE

CONTIENT

	1/2"	x18	10, 11, 12, 13, 14, 15, 16, 17, 18, 19, 20, 21, 22, 23, 24, 27, 30, 32mm
	1/4"	x13	4, 4.5, 5, 5.5, 6, 7, 8, 9, 10, 11, 12, 13, 14mm
	1/2"	x4	14, 15, 17, 19mm
	1/4"	x8	6, 7, 8, 9, 10, 11, 12, 13mm
	1/2"	x2	1/2" - 1/4"
	1/2"	x2	125, 250mm
	1/4"	x2	50, 100mm
	1/2"	x2	1/2" - 1/4"
	1/2"	x1	adaptateur 3/8" H x 1/2" M

	1/2"	x1	8mm
		x3	1.5, 2, 2.5mm
	1/2"	x2	16, 21mm
		x2	PH3, PH4
		x2	PZ3, PZ4
	8mm	x4	8, 10, 12, 14mm
		x3	SL8, SL10, SL12
		x4	T40, T45, T50, T55
	8mm	x1	1/4"

		x1	1/4"
		x1	1/4"
		x1	1/4"
		x2	PH1, PH2
		x2	PZ1, PZ2
	1/4"	x4	3, 4, 5, 6mm
		x3	SL4, SL5.5, SL7
		x6	T8, T10, T15, T20, T25, T30

53212

174,00€

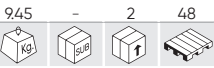

COFFRET D'OUTILS DE 303 PIÈCES AVEC DOUILLES HEXAGONALES ZINGUÉES



ACIER ZINGUÉ



CONTIENT

	x18	10, 11, 12, 13, 14, 15, 16, 17, 18, 19, 20, 21, 22, 23, 24, 27, 30, 32mm
	x2	125, 250mm
	x2	16, 21mm
	x1	8mm
	x1	adaptateur 3/8" H x 1/2" M
	x1	UNIVERSAL
	x1	72
	x13	4, 4.5, 5, 5.5, 6, 7, 8, 9, 10, 11, 12, 13, 14mm
	x2	50, 100mm
	x1	6,3mm
	x1	1/4"
	x1	UNIVERSAL
	x1	72
	x8	T25, T27, T30, T35, T40 (x2), T45, T50
	x2	PH3, PH4
	x2	PZ3, PZ4
	x4	H5.5, H6.5, H7, H8
	x4	5.5, 6.5, 7, 8mm
	x4	5, 6, 8, 10mm

	x9	3, 4, 4.5, 5, 5.5, 6, 6.5, 7, 8mm
	x9	T8, T10, T15, T20, T25, T27, T30, T35, T40
	x9	H1.5, H2, H2.5, H3, H.4, H5, H5.5, H6, H8
	x3	5, 6, 8mm
	x4	1, 2, 3, 4
	x3	6, 8, 10
	x3	C1, C2, C3
	x6	2, 2.5, 3, 4, 5, 6mm
	x4	S0, S1, S2, S3
	x6	5/64, 3/32, 7/64, 1/8, 9/64, 5/32
	x4	4, 6, 8, 10mm
	x10	PH0 (x2), PH1 (x2), PH2 (x4), PH3 (x2)
	x10	PZ0 (x2), PZ1 (x2), PZ2 (x4), Z3 (x2)
	x10	1/16, 5/64, 3/32, 7/64, 1/8, 9/64, 5/32, 3/16, 7/32, 1/4
	x10	T8, T10, T15, T20, T25, T27, T30, T35, T40, T45
	x6	1.5, 2, 2.5, 3, 3.5, 4mm
	x4	PH000, PH00, PH0, PH1
	x2	PZ0, PZ1
	x8	T5, T6, T7, T8, T9, T10, T15, T20

	x1		x1	300g
	x1		x1	
	x10		x1	
	x1		x23	
	x1	3m		x22
	x1			x10
	x1	8"		x10
	x2	0.4x2.5, 0.5x3.0x50mm		
	x3	PH0x50, PH00x50, PH000x50mm		
	x2	0.8x4x100, 1.2x6.5x125mm		
	x2	PH1x80, PH2x100mm		
	x7	1.27, 1.5, 2, 2.5, 3, 4, 5mm		
	x13	1.5, 2, 2.5, 3, 3.2, 3.5, 4, 4.5, 4.8, 5, 5.5, 6, 6.5mm		

54106

89,00€

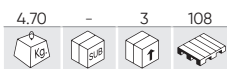

MALLETTE D'OUTILS EN POUCES DE 37 PIÈCES ZINGUÉES



ACIER ZINGUÉ



PIÈCES DE RECHANGE

CONTIENT

	1/2" x17	5/16", 3/8", 7/16", 1/2", 9/16", 19/32", 5/8", 11/16", 3/4", 13/16", 7/8", 15/16", 1", 1-1/16", 1-1/8", 1-3/16", 1-1/4"		1/2" x2	5" - 10"
	1/4" x8	3/16", 7/32", 1/4", 9/32", 5/16", 11/32", 3/8", 7/16"		1/4" x1	3"
	x2	1/2" - 1/4"		x1	1/2" - 1/4"
	1/2" x2	16, 21mm		x2	1/2" - 1/4"
				x1	1/4"

53074

78,00€

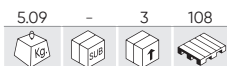

COFFRET D'OUTILS DE 74 PIÈCES AVEC DOUILLES À 12 ARÊTES, ZINGUÉES



ACIER ZINGUÉ



PIÈCES DE RECHANGE



CONTIENT

	1/2" x18	10, 11, 12, 13, 14, 15, 16, 17, 18, 19, 20, 21, 22, 23, 24, 27, 30, 32mm
	1/4" x10	4, 5, 5.5, 6, 7, 8, 10, 11, 12, 13mm
	x2	1/2" - 1/4"
	x2	125, 250mm
	1/4" x1	100mm
	x1	1/2"
	x5	PH0, PH1, PH2, PH3, PH4
	x5	PZ0, PZ1, PZ2, PZ3, PZ4
	x6	3, 4, 5, 6, 8, 10mm
	x5	SL3, SL4, SL5.5, SL6, SL7
	x8	T8, T10, T15, T20, T25, T27, T30, T40
	x4	4, 5, 6, 7mm
	1/2" x1	adapteur 3/8" H x 1/2" M
	1/2" x1	21mm
	x3	1.5, 2, 2.5mm
	x1	1/4"
	1/4" x1	6mm

54140

36,00€



KIT D'OUTILS 56 PIÈCES AVEC DOUILLES À 12 ARÊTES ZINGUÉES

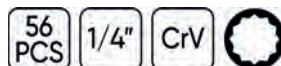

ACIER ZINGUÉ



PIÈCES DE RECHANGE



CONTIENT

	x13	4, 4.5, 5, 5.5, 6, 7, 8, 9, 10, 11, 12, 13, 14mm
	x1	T2
	x2	50, 100mm
	x1	1/4"
	x1	
	x1	
	x1	
	x1	
	x4	SL4, SL5, SL6, SL7
	x3	M5, M6, M8
	x8	T8, T10, T15, T20, T25, T27, T30, T40
	x8	T8, T10, T15, T20, T25, T27, T30, T40
	x3	PH0, PH1, PH2
	x3	PZ0, PZ1, PZ2
	x6	3, 4, 5, 6, 7, 8mm

CR-V 25 L

SETS D'OUTILS

54108

66,00€

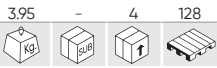

COFFRET D'OUTILS 22 PIÈCES DOUILLES HEXAGONALES 1/2" ZINGUÉES

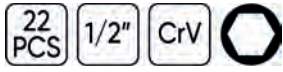

ACIER ZINGUÉ



CONTIENT

	1/2"	x17	10, 11, 12, 13, 14, 15, 16, 17, 18, 19, 20, 21, 22, 24, 27, 30, 32mm
	1/2"	x1	
	1/2"	x2	75, 125mm
		x1	3/8" (H) - 1/2" (M)
		x1	1/2"

54116

66,00€

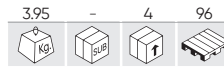

COFFRET D'OUTILS 22 PIÈCES DOUILLES À 12 TRANCHANTS 1/2" ZINGUÉ

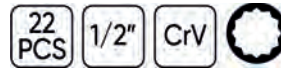

ACIER ZINGUÉ



CONTIENT

	1/2"	x17	10, 11, 12, 13, 14, 15, 16, 17, 18, 19, 21, 22, 24, 27, 30, 32mm
	1/2"	x1	1/2"
	1/2"	x2	125, 250mm
	1/2"	x1	
	1/2"	x1	3/8"(H) - 1/2"(M)

51818

109,00€

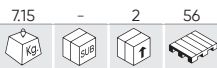

COFFRET D'OUTILS DE 72 PIÈCES AVEC DOUILLES HEXAGONALES ZINGUÉES



ACIER ZINGUÉ



CONTIENT

	1/2"	x13	10, 11, 12, 13, 14, 15, 17, 19, 22, 24, 27, 30, 32mm
	1/4"	x10	4, 5, 6, 7, 8, 9, 10, 11, 12, 13mm
	1/4"	x5	5, 6, 7, 8, 9mm
	1/2"	x1	1/2"
	1/4"	x1	1/4"
	1/2"	x1	125mm
	1/4"	x1	75mm

	x1	
	x1	300gr
	x1	
	x1	
	x4	SL3, SL4, SL5, SL6
	x3	PH1, PH2, PH3
	x7	T10, T15, T20, T25, T27, T30, T40

	x2	1/2" - 1/4"
	1/2"	x2 16, 21mm
	1/4"	x1 6mm
		x8 10, 11, 12, 13, 14, 15, 17, 19mm
	x3	1.5, 2, 2.5mm
	x1	1/4"
	x2	PH2x100, PH1x40mm
	x3	8x200, 6x100, 6x40mm

54258

58,00€



COFFRET D'OUTILS DE 77 PIÈCES ZINGUÉ



ACIER ZINGUÉ



CONTIENT

	x5 PH0, PH1, PH2, PH2, PH3		x1
	x5 PZ0, PZ1, PZ2, PZ2, PZ3		x10
	x5 SL3, SL4, SL5, SL5.5, SL6mm		x1
	x5 T10, T15, T20, T25, T30		x1
	x4 6x7, 8x9, 10x11, 12x13mm		x1
	x9 1.5, 2, 2.5, 3, 4, 5, 6, 8, 10mm		x1
	x3 PH2x100, PH00x50, PH000x50		x1
	x3 SL6x100, SL2.5x50, SL3.0x50		x10
	x1		x10



54277

53,50€



COFFRET DE DOUILLES 3/8" DE 59 PIÈCES 6 PANS ZINGUÉ

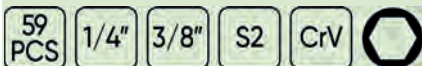

ACIER ZINGUÉ



PIÈCES DE RECHANGE

CONTIENT

	3/8" x17	6, 7, 8, 9, 10, 11, 12, 13, 14, 15, 16, 17, 18, 19, 20, 21, 22mm		x2	PH3, PH4		x2	PH1, PH2	
	x1	3/8"		x2	PZ3, PZ4		x2	PZ1, PZ2	
	3/8" x2	75, 150mm		8mm	x5	7, 8, 10, 12, 14mm		x4	3, 4, 5, 6mm
	3/8" x1	8mm		x3	SL8, SL10, SL12		x3	SL4, SL5.5, SL6.5	
	3/8" x1	8mm		x5	T40, T45, T50, T55, T60		x7	T8, T10, T15, T20, T25, T27, T30	
	x1	3/8"							
	x1	1/4"							

53953

29,00€

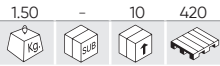

JEU DE 130 DOUILLES ET EMBOUTS ZINGUÉS

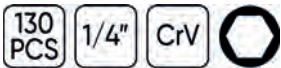

ACIER ZINGUÉ



PRÉSENTOIR DE 10 UNITÉS



PIÈCES DE RECHANGE

CONTIENT

	1/4"	x13	4, 4.5, 5, 5.5, 6, 7, 8, 9, 10, 11, 12, 13, 14mm
	T2	x1	1/4"
	1/4"	x1	50mm
	1/4"	x1	1/4"
	1/4"	x1	6mm
	1/4"	x1	1/4"
	1/4"	x1	1/4"
	1/4"	x7	1.27, 1.5, 2, 2.5, 3, 4, 5mm

	25mm	x10	T8, T10, T15, T20, T25, T27, T30, T35, T40, T45
	25mm	x9	T8, T10, T15, T20, T25, T27, T30, T35, T40
	25mm	x3	M5, M6, M8
	25mm	x3	6, 8, 10mm
	25mm	x3	C1, C2, C3
	25mm	x4	1, 2, 3, 4mm
	25mm	x4	4, 6, 8, 10mm
	25mm	x4	0, 1, 2, 3mm

	25mm	x10	1/16, 5/64, 3/32, 7/64, 1/8, 9/64, 5/32, 3/16, 7/32, 1/4
	25mm	x9	1.5, 2, 2.5, 3, 4, 5, 5.5, 6, 8mm
	25mm	x6	5/64, 3/32, 7/64, 1/8, 9/64, 5/32
	25mm	x6	2, 2.5, 3, 4, 5, 6mm
	25mm	x9	3, 4, 4.5, 5, 5.5, 6, 6.5, 7, 8mm
	50mm	x2	4, 6mm
	25mm	x10	PH0(x2), PH1(x2), PH2(x4), PH3(x2)
	50mm	x2	PH1, PH2
	25mm	x10	P20(x2), PZ1(x2), PZ2(x4), PZ3(x2)

54109

34,00€

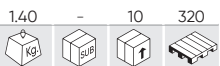

JEU DE 46 PIÈCES AVEC DOUILLES HEXAGONALES ZINGUÉES



ACIER ZINGUÉ



PIÈCES DE RECHANGE



CONTIENT

	1/4"	x13	4, 4.5, 5, 5.5, 6, 7, 8, 9, 10, 11, 12, 13, 14mm
	1/4"	x1	
	T2	x1	
	1/4"	x1	
	1/4"	x2	50, 100mm
	1/4"	x4	1.27, 1.5, 2.0, 2.5mm
	1/4"	x1	
	1/4"	x1	UNIVERSAL
	1/4"	x1	1/4"
	3/8"	x3	SL4, SL5.5, SL7
	3/8"	x3	PH1, PH2, PH3
	3/8"	x3	PZ1, PZ2, PZ3
	3/8"	x6	H3, H4, H5, H6, H7, H8
	3/8"	x6	T10, T15, T20, T25, T30, T40

54168

49,00€

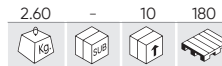

KIT D'OUTILS 3/8" 59 PIÈCES AVEC DOUILLES À 12 ARÊTES ZINGUÉES

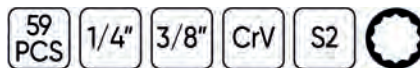

ACIER ZINGUÉ



PIÈCES DE RECHANGE



CONTIENT

	3/8"	x17	6, 7, 8, 9, 10, 11, 12, 13, 14, 15, 16, 17, 18, 19, 20, 21, 22mm
	T2	x1	3/8"
	3/8"	x2	75, 150mm
	3/8"	x1	8mm
	3/8"	x1	8mm
	3/8"	x1	
	1/4"	x1	
	8mm	x5	7, 8, 10, 12, 14mm
	8mm	x3	8, 10, 12mm
	8mm	x5	T40, T45, T50, T55, T60
	3/8"	x2	PH1, PH2
	3/8"	x2	PZ1, PZ2
	3/8"	x4	3, 4, 5, 6mm
	3/8"	x3	4, 5.5, 6.5mm
	3/8"	x7	T8, T10, T15, T20, T25, T27, T30

54105 33,00€

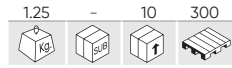

KIT D'OUTILS 3/8" 59 PIÈCES AVEC DOUILLES À 12 ARÊTES ZINGUÉES

56 PCS 1/4" CrV S2

ACIER ZINGUÉ



CONTIENT

	1/4"	x13	4, 4.5, 5, 5.5, 6, 7, 8, 9, 10, 11, 12, 13, 14mm
	1/4"	x1	1/4"
	1/4"	x2	50, 100mm
	1/4"	x1	1/4"
	1/4"	x1	1/4"
	1/4"	x1	1/4"
	1/4"	x1	6mm
	PH0, PH1, PH2	x3	
	PZ0, PZ1, PZ2	x3	
	3, 4, 5, 6, 7, 8mm	x6	
	6mm	x4	SL4, SL5, SL6, SL7
	6mm	x3	M5, M6, M8
	6mm	x8	T8, T10, T15, T20, T25, T27, T30, T40
	6mm	x8	T8, T10, T15, T20, T25, T27, T30, T40
	6mm	x1	1/4"

52418 179,00€

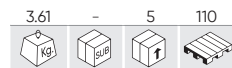

MALLETTE D'OUTILS DE PASSAGE DE 39 PIÈCES CHROMÉE

39 PCS CrV

CHROMÉ

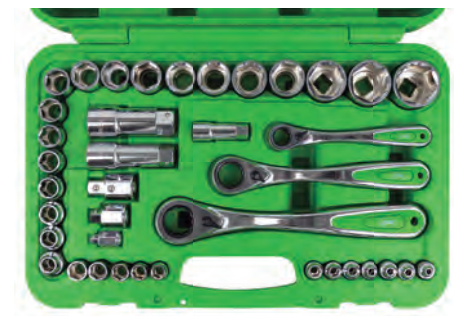

CONTIENT

	13mm	x12	4, 4.5, 5, 5.5, 6, 7, 8, 9, 10, 11, 12, 13mm
	19mm	x10	10, 11, 12, 13, 14, 15, 16, 17, 18, 19mm
	22mm	x5	20, 21, 22, 23, 24mm
	22mm	x3	27, 30, 32mm
	1/2"	x3	13, 19, 22mm
	1/2"	x3	13, 19, 22mm
	1/4"	x1	13mm
	3/8"	x1	19mm
	1/2"	x1	22mm

54090 56,00€

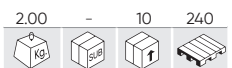

KIT D'OUTILS DE PASSAGE 14 PIÈCES ZINGUÉ

ACIER ZINGUÉ

14 PCS 1/2" CrV



CONTIENT

	x11	13, 14, 15, 16, 17, 18, 19, 21, 22, 24, 27mm
	x1 (75mmL)	12,5mm
	x1	1/2"
	x1 (go-through)	

50623 60,00€



BOÎTIER CHROMÉ GO-THROUGH EN 17 PIÈCES

CHROMÉ

17 PCS 1/4" CrV



CONTIENT

	x13	4, 4.5, 5, 5.5, 6, 7, 8, 9, 10, 11, 12, 13, 14mm
	x1	75mm
	x1	1/4"
	x1	145mm

SETS D'OUTILS

52722

87,00€



COFFRET DE 61 PIÈCES DOUILLES CANNELÉES 1/2" ET 1/4" ZINGUÉES



ACIER ZINGUÉ



PIÈCES DE RECHANGE

53108

92,00€



CAISSE À OUTILS 61 PIÈCES DOUILLES CANNELÉES 1/2" ET 1/4" CHROMÉES

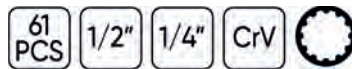

CHROMÉ



PIÈCES DE RECHANGE

CONTIENT

	1/2"	x11	14, 15, 16, 17, 18, 19, 22, 24, 27, 30, 32mm
	1/4"	x12	4, 4.5, 5, 5.5, 6, 7, 8, 9, 10, 11, 12, 13mm
		x2	1/2" - 1/4"
	1/2"	x2	5" - 10"
	1/4"	x2	2" - 4"
		x2	1/2" - 1/4"

		x1	adaptateur 3/8" H x 1/2" M
	1/2"	x2	16, 21mm
		x1	25mm
		x3	1.5, 2, 2.5mm
		x1	1/4"
		x1	1/4"
		x1	AD

		x3	PH1, PH2, PH3
		x3	PZ1, PZ2, PZ3
	25mm	x5	3, 4, 5, 6, 8mm
		x3	SL4, SL5.5, SL7
		x5	T10, T15, T20, T25, T30

53915

65,00€

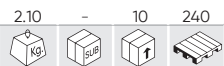

JEU DE 6 DOUILLES 1/2" TORX TYPE E EXTRA LONG ZINGUÉ

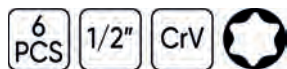

ACIER ZINGUÉ



CONTIENT

		1/2"	x6	E10, E12, E14, E16, E18, E20
--	--	------	----	------------------------------

E12 Douille pour culasse de BMW:
 - Moteur M42, 1,8 L, 4 cylindres, 16 V, modèle 318 (1989)
 - Moteur M50, 2,0 L, 2, 5 L, 6 cylindres, 24 V, modèles 520i, 525i (1991)

54141

42,00€

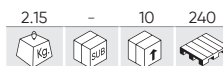

JEU DE 28 DOUILLES TORX COURTES ET LONGUES ZINGUÉES

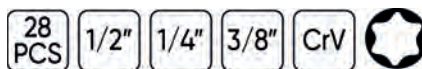

ACIER ZINGUÉ



CONTIENT

	1/4"	x5 (25mm)	E4, E5, E6, E7, E8
	3/8"	x5 (28mm)	E10, E11, E12, E14, E16
	1/2"	x4 (38mm)	E18, E20, E22, E24
	1/4"	x5 (50mm)	E4, E5, E6, E7, E8
	3/8"	x5 (63mm)	E10, E11, E12, E14, E16
	1/2"	x4 (76mm)	E18, E20, E22, E24



PIÈCES DE RECHANGE



51616 378,00€

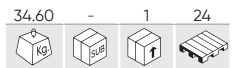

COFFRET MÉTALLIQUE AVEC 22 PIÈCES D'AUTOCLAVE HEXAGONALES ZINGUÉES DE 1".



ACIER ZINGUÉ



BOÎTE MÉTALLIQUE
CONTIENT

	1"	x17	36, 38, 41, 46, 50, 54, 55, 58, 60, 63, 65, 67, 70, 71, 75, 77, 80mm
	1"	x1	650mm
	1"	x2	205, 410mm
	1"	x1	
	1"	x1	



51855 378,00€



COFFRET MÉTALLIQUE AVEC 22 PIÈCES DE 1" AUTOCLAVE SUR 12 BORDS ZINGUÉS



ACIER ZINGUÉ



BOÎTE MÉTALLIQUE
CONTIENT

	1"	x17	36, 38, 41, 46, 50, 54, 55, 58, 60, 63, 65, 67, 70, 71, 75, 77, 80mm
	1"	x1	650mm
	1"	x2	205, 410mm
	1"	x1	
	1"	x1	



53727 198,00€

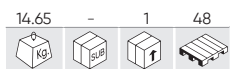

COFFRET D'OUTILS AVEC 21 PIÈCES DOUILLE HEXAGONALE 3/4" ZINGUÉE

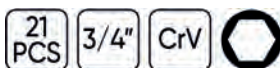

ACIER ZINGUÉ



CONTIENT

	3/4"	x16	19, 21, 22, 23, 24, 26, 27, 29, 30, 32, 35, 36, 38, 41, 46, 50mm
	3/4"	x1	495mm
	3/4"	x3	100, 200, 400mm
	3/4"	x1	445mm



53728 198,00€



MALLETTE D'OUTILS AVEC 21 PIÈCES 3/4" 12-LAMES ZINGUÉES



ACIER ZINGUÉ



CONTIENT

	3/4"	x16	19, 21, 22, 23, 24, 26, 27, 29, 30, 32, 35, 36, 38, 41, 46, 50mm
	3/4"	x1	495mm
	3/4"	x3	100, 200, 400mm
	3/4"	x1	445mm



54261

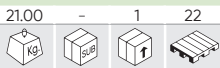

321,00€



N

BOÎTE MÉTALLIQUE AVEC OUTILS 143 PIÈCES ZINGUÉES

143 PCS CrV

ACIER ZINGUÉ



CONTIENT

	x13	4, 4.5, 5, 5.5, 6, 7, 8, 9, 10, 11, 12, 13, 14mm		x20	8, 9, 10, 11, 12, 13, 14, 15, 16, 17, 18, 19, 20, 21, 22, 23, 24, 27, 30, 32mm		x4	SL5x75, SL6x100, SL8x150, SL10x200mmL
	x6	8, 10, 11, 12, 13, 14mm		x2	5" - 10"		x3	PH1x80, PH2x100, PH3x150mmL
	x7	E4, E5, E6, E7, E8, E10, E11		x2	1/2" x2 16, 21mm		x4	PH1, PH2x2, PH3
	x2	2", 4"		x1	UNIVERSAL		x4	PZ1, PZ2x2, PZ3
	x1	110mmL		x1	3/8"(F) - 1/2"(M)		x4	SL3, SL4, SL5, SL6
	1/4" x1			x1			x4	H3, H4, H5, H6
	x1	150L		x2	1/2" 72		x7	T10, T15, T20, T25, T27, T30, T40
	x3	PH1,PH2,PH3		x2	1/4" 72		x7	TT10,TT15,TT20,TT25,TT27,TT30,TT40
	x3	SL4,SL5.5,SL6.5		x12	6,7,8,9,10,11,12,13,14,17,19,22mm		x1	1/4"
	x6	TT10,TT15,TT20,TT25,TT30,TT40		x8	6x7,8x9,10x11,12x13,14x15,16x17,18x19,20x22mm		x1	6.35mmx60mmL
	x6	H3,H4,H5,H6,H7,H8		x1	7"-180mm		x1	1/4"-6.35mm
	x1			x1	8"-200mm		x1	7"-180mm
	x1	250mm		x1			x1	10"-250mm

53565

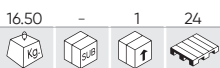

258,00€



BOÎTE À OUTILS EN FER 64 PIÈCES ZINGUÉES

64 PCS CrV

ACIER ZINGUÉ

CONTIENT

	1/2" x18	10, 11, 12, 13, 14, 15, 16, 17, 18, 19, 20, 21, 22, 23, 24, 27, 30, 32mm		x1	1/2"
	x1	1/2"		x1	1/2"
	x3	76, 127, 254mm		x1	255mm
	x1	21mm		x1	457mm
	x18	6, 7, 8, 9, 10, 11, 12, 13, 14, 15, 16, 17, 18, 19, 20, 21, 22, 24mm		x9	1.5, 2, 2.5, 3, 4, 5, 6, 8, 10mm
	x3	PH1x100, PH2x150, H3x200mm		x3	SL5x100, SL6x150, SL8x200mm
	x1	250mm		x1	180mm
	x1	200mm		x1	180mm



53159

289,00€

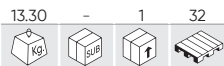

CAISSE À OUTILS EN ALUMINIUM 159 PIÈCES ZINGUÉES



ACIER ZINGUÉ



PIÈCES DE RECHANGE

CONTIENT



	1/2" x14	14, 15, 16, 17, 18, 19, 20, 21, 22, 23, 24, 27, 30, 32mm
	1/4" x10	4, 5, 6, 7, 8, 9, 10, 11, 12, 13mm
	x2	1/4" - 1/2"
	1/2" x2	50, 100mm
	1/4" x2	125, 250mm
	1/4" x1	150mm
	x2	1/4" - 1/2"
	1/2" x1	adaptateur 3/8" H x 1/2" M
	x2	1/4" - 1/2"
	1/4" x1	250mm
	1/4" x1	110mm
	1/2" x2	16, 21mm
	x1	1/4"

	x9	8, 10, 11, 12, 13, 15, 17, 19, 22mm
	x9	1.5, 2, 2.5, 3, 4, 5, 6, 8, 10mm
	x1	100-250V
	x1	
	x2	PH1x80, PH2x10mm
	x4	SL3x75, SL4x100, SL6.5x125, SL8x150mm
	x1	PH00x50mm
	x1	SL2.5x50mm
	x1	250mm
	x1	200mm
	x1	160mm
	x1	7" (180mm)
	x1	180mm
	x1	220mm
	x1	160mm
	x1	160mm

	x1	
	x6	1,5mm
	x1	
	x1	300gr
	x1	3m
	x1	200mm
	x5	
	x1	18mm
	x10	
	x40	6.35mm
	x15	8mm



53928

278,00€

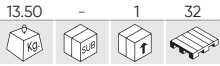

COFFRET D'OUTILS DE 135 PIÈCES AVEC DOUILLES HEXAGONALES ZINGUÉES



ACIER ZINGUÉ



CONTIENT



	x10	10, 11, 12, 13, 14, 15, 17, 19, 22, 24mm
	x2	16, 21mm
	x1	UNIVERSAL
	x2	125, 250mm
	x1	3/8" - 1/2"
	x1	
	x9	4, 5, 6, 7, 8, 9, 10, 11, 12mm
	x1	UNIVERSAL
	x1	
	x2	50, 100mm
	x1	6mm
	x9	8, 10, 11, 12, 13, 14, 17, 19, 22mm
	x1	150mm
	x1	

	x4	PH1, PH2, PH2, PH3
	x4	PZ1, PZ2, PZ2, PZ3
	x4	SL3, SL4, SL5, SL6
	x4	H3, H4, H5, H6
	x7	TT10, TT15, TT20, TT25, TT27, TT30, TT40
	x7	TT10, TT15, TT20, TT25, TT27, TT30, TT40
	x1	6mm
	x1	6mmL
	x5	
	x1	
	x2	PH1x80mm, PH2x100mm, SL3.0x75mm, SL4.0x100mm, SL6.5x125mm, SL8x150mm
	x4	

	x1	
	x1	
	x3	SL1.5, SL2, SL3, PH000, PH00, PH0, PH1, T4, T5, T6, T7, T8, T10, T15, T20
	x4	
	x8	
	x4	TS0.8, TS1.2, TS1.5, TS2.0
	x1	H2.0
	x1	
	x1	
	x9	1.5, 2, 2.5, 3, 4, 5, 6, 8, 10mm
	x1	
	x1	5m
	x1	300g

	x1	250mm
	x1	180mm
	x1	180mm
	x1	200mm
	x1	160mm
	x1	200mm
	x1	
	x3	
	x1	18mm

53444

195,00€

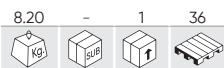

CAISSE À OUTILS EN ALUMINIUM 108 PIÈCES DOUILLES 1/2" ZINGUÉES

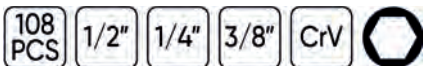

ACIER ZINGUÉ



CONTIENT



	x9	10, 11, 12, 13, 14, 15, 17, 18, 19mm
	x2	75, 150mm
	x1	16mm
	x1	Ⓢ
	x1	adaptateur 3/8" H x 1/2" M
	x8	4, 4.5, 5, 5.5, 6, 7, 8, 9mm
	x1	150mmL
	x1	6mm
	x2	PH1x80, PH2x100mm
	x4	SL3.5x75, SL4x100, SL6.5x125, SL8x150mm
	x1	PH00x50mm
	x1	SL2.5x50mm
	x1	

	x9	6x7, 8x9, 10x11, 12x13, 14x15, 16x17, 18x19, 20x22mm
	x9	1.5, 2, 2.5, 3, 4, 5, 6, 8, 10mm
	x1	
	x6	
	x1	200mm
	x1	18mm
	x10	
	x1	220mm
	x1	180mm
	x1	160mm
	x1	250mm
	x1	160mm

	x30	
	x1	
	x1	300g
	x1	3m



52603

74,00€

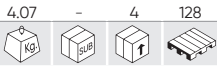

COFFRET DE 26 EMBOUTS ET 12 PANS



CONTIENT

	x8 (55mmL)	M5, M6, M8, M9, M10, M12, M14, M16
	x7 (100mmL)	M5, M6, M8, M9, M10, M12, M14
	x7 (140mmL)	M5, M6, M8, M9, M10, M12, M14
	x4 (200mmL)	M8, M10, M12, M14

52606

88,00€



COFFRET DE 32 EMBOUTS RIBE

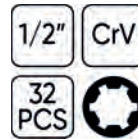

CONTIENT

	x9 (55mmL)	M5, M6, M7, M8, M9, M10, M12, M13, M14
	x9 (100mmL)	M5, M6, M7, M8, M9, M10, M12, M13, M14
	x7 (140mmL)	M7, M8, M9, M10, M12, M13, M14
	x7 (200mmL)	M7, M8, M9, M10, M12, M13, M14

52604

78,00€

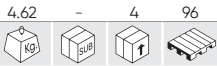

COFFRET DE 30 PIÈCES ET 6 PANS

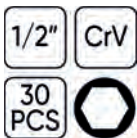

CONTIENT

	x9 (55mmL)	5, 6, 7, 8, 10, 12, 14, 17, 19mm
	x8 (100mmL)	5, 6, 7, 8, 10, 11, 12, 13mm
	x7 (140mmL)	5, 6, 7, 8, 10, 12, 14mm
	x6 (200mmL)	5, 6, 7, 8, 10, 12mm

52605

76,00€



COFFRET DE 32 EMBOUTS TORX

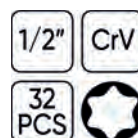

CONTIENT

	x10 (55mmL)	T20, T25, T27, T30, T40, T45, T50, T55, T60, T70
	x10 (100mmL)	T20, T25, T27, T30, T40, T45, T50, T55, T60, T70
	x6 (140mmL)	T40, T45, T50, T55, T60, T70
	x6 (200mmL)	T40, T45, T50, T55, T60, T70



54266

39,50€

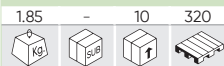

N

COFFRET DOUILLES TORX ET EMBOUTS 1/2" 19 PIÈCES



CONTIENT

	x9	E10, E11, E12, E14, E16, E18, E20
	x10	T20, T25, T27, T30, T40, T45, T50, T55, T60, T70



PIÈCES DE RECHANGE

54154

37,50€

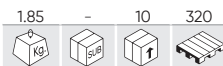

JEU DE 12 PIÈCES 1/2" POINTES TORX

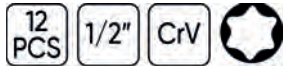

CONTIENT

	x6	T20, T25, T30, T40, T45, T50
	x6	T55, 60, T70, T80, T90, T100



PIÈCES DE RECHANGE

51260

37,00€



JEU DE 6 PANS BTR

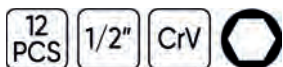

CONTIENT

	x6	H5, H6, H7, H8, H10, H12
	x1	H14
	x5	H16, H17, H18, H19, H20



PIÈCES DE RECHANGE

54164

34,00€



JEU DE 12 PIÈCES DE POINTES 12 PANS

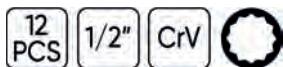

CONTIENT

	x6 (55mmL)	M4, M5, M6, M8, M9
	x6 (70mmL)	M10, M12, M14, M16, M18, M20



PIÈCES DE RECHANGE



SETS D'OUTILS

50983

48,00€

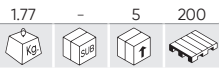

JEU DE 42 EMOBOUTS DE VISSAGE TORX, 12 ET 6 PANS

42 PCS 1/2"
3/8" S-2



CONTIENT

	3/8"	x1	10mm
	1/2"	x1	10mm
	30mm	x7	4, 5, 6, 7, 8, 10, 12mm
	75mm	x7	4, 5, 6, 7, 8, 10, 12mm
	30mm	x8	T20, T25, T30, T40, T45, T50, T55, T60
	75mm	x8	T20, T25, T30, T40, T45, T50, T55, T60
	30mm	x5	M5, M6, M8, M10, M12
	75mm	x5	M5, M6, M8, M10, M12



50985

59,00€

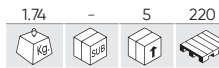

JEU DE 42 EMOBOUTS DE VISSAGE (INVIOLE) TORX, 12 ET 6 PANS

42 PCS 1/2"
3/8" S-2



CONTIENT

	3/8"	x1	10mm
	1/2"	x1	10mm
	30mm	x7	4, 5, 6, 7, 8, 10, 12mm
	75mm	x7	4, 5, 6, 7, 8, 10, 12mm
	30mm	x8	T20, T25, T30, T40, T45, T50, T55, T60
	75mm	x8	T20, T25, T30, T40, T45, T50, T55, T60
	30mm	x5	M5, M6, M8, M10, M12
	75mm	x5	M5, M6, M8, M10, M12



52550

92,00€

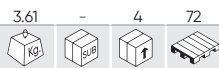

COFFRET DE 75 EMOBOUTS DE VISSAGE

75 PCS 1/2"
3/8" S-2

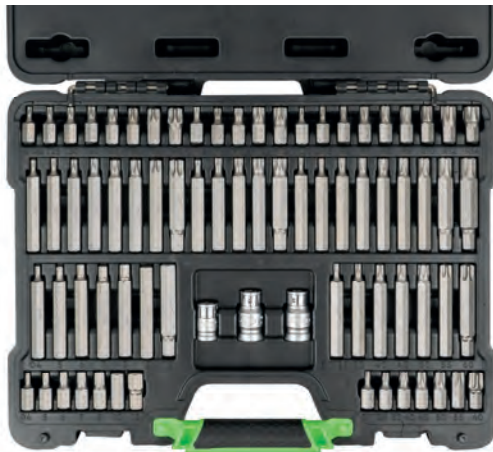

CONTIENT

	3/8"	x1	10mm
	1/2"	x2	10mm
	30mm	x7	4, 5, 6, 7, 8, 10, 12mm
	75mm	x7	4, 5, 6, 7, 8, 10, 12mm
	30mm	x8	T20, T25, T30, T40, T45, T50, T55, T60
	75mm	x8	T20, T25, T30, T40, T45, T50, T55, T60
	30mm	x5	M5, M6, M8, M10, M12
	75mm	x5	M5, M6, M8, M10, M12
	30mm	x8	R5, R6, R7, R8, R9, R10, R12, R14
	75mm	x8	R5, R6, R7, R8, R9, R10, R12, R14
	30mm	x8	TT20, TT25, TT30, TT40, TT45, TT50, TT55, TT60
	75mm	x8	TT20, TT25, TT30, TT40, TT45, TT50, TT55, TT60

52753

107,00€

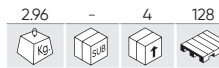

COFFRET DE 55 EMOBOUTS DE VISSAGE HEAVY DUTY

55 PCS 1/2"
3/8" S-2



CONTIENT

	3/8"	x1	10mm
	1/2"	x2	10, 14mm
	30mm	x9	4, 5, 6, 7, 8, 10, 12, 14, 16mm - ISO 2136
	75mm	x9	4, 5, 6, 7, 8, 10, 12, 14, 16mm - ISO 2136
	30mm	x10	T20, T25, T30, T40, T45, T50, T55, T60, T70, T80 - DIN 2325
	75mm	x10	T20, T25, T30, T40, T45, T50, T55, T60, T70, T80 - DIN 2325
	30mm	x7	M5, M6, M8, M10, M12, M14, M16 - DIN 2325
	75mm	x7	M5, M6, M8, M10, M12, M14, M16 - DIN 2325

52539

59,00€

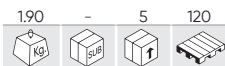

JEU DE VISSAGE



CONTIENT

	x10	PH3, PH4
	x10	PZ3, PZ4
	x25	7, 8, 10, 12, 14mm
	x15	SL8, SL10, SL12
	x25	T40, T45, T50, T55, T60



52538

62,00€



JEU DE DOUILLES POUR TOURNEVIS DE 1/4"



CONTIENT

	x10	PH1, PH2
	x10	PZ1, PZ2
	x15	SL4, SL5.5, SL6.5
	x35	T8, T10, T15, T20, T25, T27, T30



53574

47,00€

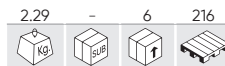

COFFRET DE 208 EMBOUTS



CONTIENT

	x12	1.5, 2, 2.5, 3, 3.5, 4, 4.5, 5, 5.5, 6, 7, 8mm
	x5	2.5, 3, 4, 5, 6mm
	x5	2.5, 3, 4, 5, 6mm
	x18	PH00, PH0, PH1(x5), PH2(x5), PH3(x5), PH4
	x3	PH1, PH2, PH3
	x3	PH1, PH2, PH3
	x17	PZ00, PZ0, PZ1(x5), PZ2(x5), PZ3(x4), PZ4
	x3	PZ1, PZ2, PZ3
	x3	PZ1, PZ2, PZ3
	x14	T5, T6, T7, T8, T9, T10, T15, T20, T25, T27, T30, T35, T40, T45
	x7	T10, T15, T20, T25, T27, T30, T40
	x7	T10, T15, T20, T25, T27, T30, T40

	x3	6, 8, 10mm
	x3	6, 8, 10mm
	x4	4, 6, 8, 10mm
	x4	4, 6, 8, 10mm
	x4	1, 2, 3, 4mm
	x4	1, 2, 3, 4mm
	x6	2, 2.5, 3, 4, 5, 6mm
	x6	5/64, 3/32, 7/64, 1/8, 9/64, 5/32
	x13	T5, 6, 7, 8, 9, 10, 15, 20, 25, 27, 30, 40, 45
	x3	1, 2, 3mm
	x4	0, 1, 2, 3mm
	x3	M5, M6, M8
	x9	TS10, TS15, TS20, TS25, TS27, TS30, TS40, TS45, TS50



	x12	SL2, SL2.5, SL3, SL3.5, SL4, SL4.5, SL5, SL5.5, SL6, SL6.5, SL7, SL8
	x10	4, 5, 6, 7, 8, 9, 10, 11, 12, 13
	x10	5/32, 3/16, 7/32, 1/4, 9/32, 5/16, 11/32, 3/8, 7/16, 1/2
	x1	1/4"
	x1	
	x1	

52620

8,80€

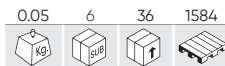

ADAPTATEUR ANGULAIRE



- Pour les zones de difficile acces.
- Avec fonction de prise rapide.
- Extraction facile.
- Bit de 6mm.

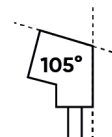

53156

26,20€

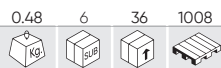

COFFRET DE 38 PIÈCES AVEC CLIQUET MINI DE 1/4"



PIÈCES DE RECHANGE



CONTIENT

	1/4"	x11	4, 4.5, 5, 6, 7, 8, 9, 10, 11, 12, 13mm		6mm	x5	4, 5, 6, 7, 8mm
	1/4"	x1			6mm	x3	SL6, SL8, SL10
		x2	PH3, PH4		6mm	x8	T8, T9, T10, T15, T20, T25, T30, T40
		x2	PZ3, PZ4			x4	M5, M6, M9, M10
						x1	1/4"

52198

37,70€

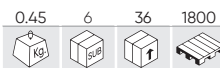

COFFRET DE 37 PIÈCES AVEC CLIQUET MINI DE 1/4"

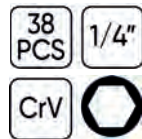

PIÈCES DE RECHANGE



CONTIENT

	1/4"	x11	4, 4.5, 5, 6, 7, 8, 9, 10, 11, 12, 13mm		6mm	x5	4, 5, 6, 7, 8mm
	1/4"	x1			6mm	x3	SL6, SL8, SL10
		x2	PH3, PH4		6mm	x8	T8, T9, T10, T15, T20, T25, T30, T40
		x2	PZ3, PZ4			x4	M5, M6, M9, M10
						x1	1/4"

51333

18,00€

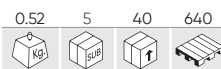

COFFRET DE 6 ADAPTATEURS

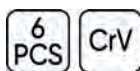

PIÈCES DE RECHANGE

REF.	mm				€
11360	1/4H - 3/8M	0.03	10	100	2,60€
11361	1/4M - 3/8H	0.03	5	300	3,20€
11362	1/2H - 3/4M	0.14	10	100	5,20€
11363	3/8H - 1/2M	0.50	10	100	3,90€
11364	1/2H - 3/8M	0.05	10	100	4,50€
11365	3/4H - 1/2M	0.14	10	100	9,40€

53743

39,70€

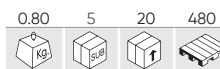

JEU DE 6 TÊTES À PERCUSSION



PIÈCES DE RECHANGE

REF.	mm				€
14749	1/4"H - 3/8"M	0.03	20	200	2,00€
14750	3/8"H - 1/4"M	0.05	20	100	2,00€
14751	3/8"H - 1/2"M	0.15	20	100	4,00€
14752	1/2"H - 3/8"M	0.16	10	100	4,00€
11962	1/2"H - 3/4"M	0.17	10	100	7,50€
11964	3/4"H - 1/2"M	0.35	10	100	12,50€



52714 15,70€



RAIL A DOUILLES TOURNEVIS 1/2" 6 PANS

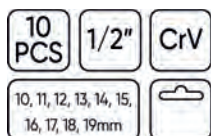

PIÈCES DE RECHANGE



52716 15,90€



RAIL A DOUILLES TOURNEVIS 1/2" 12 PANS

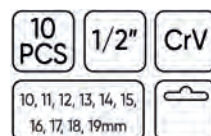

PIÈCES DE RECHANGE



52715 10,00€



RAIL A DOUILLES TOURNEVIS 1/4" 6 PANS

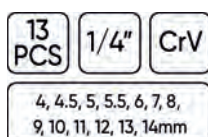

PIÈCES DE RECHANGE



52717 11,00€



RAIL A DOUILLES TOURNEVIS 1/4" 12 PANS

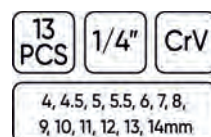

PIÈCES DE RECHANGE



51410 36,00€



RAIL A DOUILLES 6 PIÈCES 1/2" POINTE TORX INVOLABLE



PIÈCES DE RECHANGE



51409 36,00€



RAIL A DOUILLES 6 PIÈCES 1/2" 12 PANS INVOLABLE / POINTE XZN

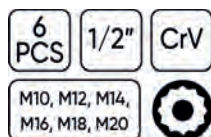

PIÈCES DE RECHANGE



SETS D'OUTILS

52909

12,50€

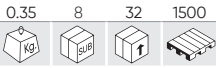

RAIL A 18 DOUILLES TOURNEVIS 1/4"



CONTIENT

	x2 PH1, PH2		x3 SL4, SL5.5, SL6.5
	x2 PZ1, PZ2		x7 T8, T10, T15, T20, T25, T27, T30
	x4 3, 4, 5, 6mm		

PIÈCES DE RECHANGE

52908

17,00€

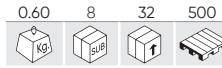

RAIL A 30 DOUILLES TOURNEVIS 1/4"

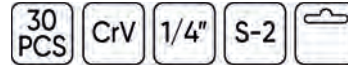

CONTIENT

	x3 PH0, PH1, PH2		x4 SL4, SL5.5, SL6.5, SL7
	x3 PZ0, PZ1, PZ2		x8 T8, T9, T10, T15, T20, T25, T27, T30
	x4 3, 4, 5, 6mm		x8 T8, T9, T10, T15, T20, T25, T27, T30

PIÈCES DE RECHANGE

53084

24,00€

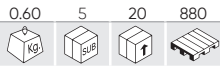

RAIL A DOUILLES TORX 3/8" - 1/2"

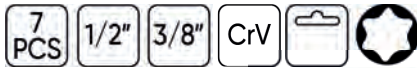

PIÈCES DE RECHANGE

	x3 T55, T60, T70		x4 T30, T40, T45, T50
--	------------------	--	-----------------------

53127

12,00€

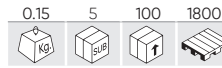

RAIL DE 7 POINTES TORX INVOLABLE 1/4"



PIÈCES DE RECHANGE

	x7 T10, T15, T20, T25, T30, T40, T45
--	--------------------------------------

51746

12,00€

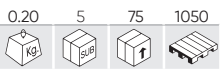

RAIL A DOUILLES TS 5 PANS INVOLABLES



TS10, TS15, TS20, TS25, TS30, TS40, TS45



50980

22,00€

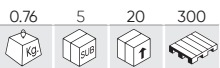

RAIL A DOUILLES TOURNEVIS RIBE



	x3 M12, M13, M14
	x4 M6, M7, M8, M10

50982

22,00€

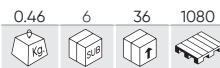

RAIL A DOUILLES TOURNEVIS TÊTE SPHERIQUE



	x7 M4, M5, M6, M7, M8, M10
--	----------------------------

52320

22,00€

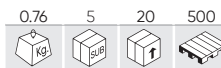

RAIL A DOUILLES 12 PANS



	x3 M12, M13, M14
	x4 M6, M7, M8, M10

12029

5,50€

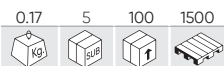

DOUILLE POINTE XZN 1/2" INVIOLEABLE M16X58MM



12030

6,50€



DOUILLE POINTE XZN 1/2" INVIOLEABLE M16X100MM



DOUILLE TOURNEVIS EXTRALONGUE 12 PANS - 800MM 1/2"

REF.	DESCRIPTION					€
52059	Ø 8mm - 800mm	0.57	-	25	1750	29,00€
52060	Ø 10mm - 800mm	0.57	-	25	1750	32,00€
53667	Ø 12mm - 800mm	0.80	10	20	-	32,00€
53668	Ø 14mm - 800mm	1.05	10	20	-	34,00€



54091

441,00€

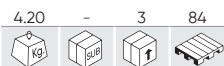

TROUSSE À OUTILS AVEC ISOLATION VDE - 26 PIÈCES

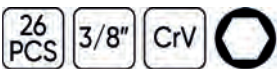

CONTIENT

	3/8" x10	8, 10, 11, 12, 13, 14, 16, 17, 18, 19, 21, 22mm
	3/8" x1	200mm
	1/2" x1	125mm
	3/8" x1	200mm

	x2	4x100mmL, 5,5x125mmL
	x2	PH1x80mm, PH2x100mm
	x1	185mm
	x1	

54093

441,00€



MODULE D'OUTILS VDE AVEC ISOLATION EVA (ÉTHYLÈNE VINYLE ACÉTATE) - 26 PIÈCES

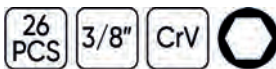

	x6	7x86, 8x99, 10x109, 12x127, 14x141, 17x156mm
	x1	185mm

15162

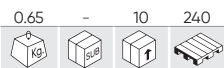

MODULE D'OUTILS VDE EN FIBRE DE CARBONE, PLATEAU EN EVA - 8 PIÈCES



PIÈCES DE RECHANGE

REF.	Ø	kg	10	50	€
15227	0.5x3.0x75mm	0,02	10	50	3,50€
15228	0.8x4.0x100mm	0,05	10	50	4,00€
15229	1.0x5.5x125mm	0,08	5	50	5,00€
15230	1.2x6.5x150mm	0,11	5	50	5,00€
15231	PH0x75mm	0,02	10	50	3,50€
15232	PH1x80mm	0,05	10	50	4,00€
15233	PH2x100mm	0,08	5	50	5,00€
15234	Testeur Pour Circuit Automobile 140mm	0,02	10	50	3,00€

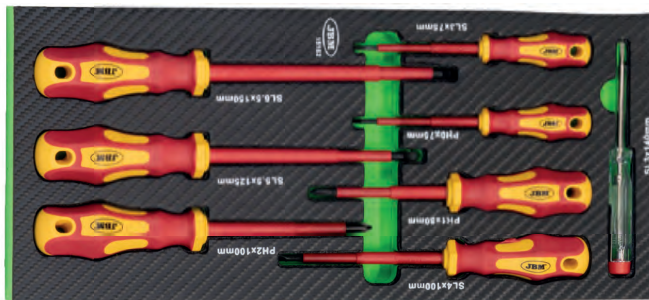

- ⊖ x4 0.5x3.0x75, 0.8x4.0x100, 1.0x5.5x125, 1.2x6.5x150mm
- ⊕ x3 PH0x75, PH1x80, PH2x100mm
- ⚡ x1 SL3x140mm

53154

462,00€



TROUSSE À OUTILS ISOLANTS 20 PIÈCES DE 3/8"



CONTIENT

🔧	3/8"	x12	8, 10, 11, 12, 13, 14, 16, 17, 18, 19, 21, 22mm
🔧	3/8"	x1	200mm
🔧	3/8"	x2	125, 250mm
🔧	3/8"	x1	200mm
🔧	3/8"	x4	75mm, 4, 5, 6, 8mm



52519

25,50€

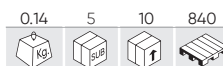

JEU DE 7 TOURNEVIS ISOLÉS 1000V



CONTIENT

- ⊕ x2 PH00x50, PH0x50mm
- ⊖ x5 SL1.5x0.23x50, SL1.8x0.30x50, SL2.0x0.40x50, SL2.5x0.40x50, SL3.0x0.50x50mm

COUPEAU ISOLANT

REF.	DESCRIPTION	kg	6	36	1152	€
53164	DROIT	0.10	6	36	1152	16,50€
53165	COURBÉ	0.10	6	36	1152	19,60€



OUTILS À MAIN

- 38 CLÉS
- 48 BARRES DE SERRAGE
- 49 CLIQUET
- 51 CLÉS DYNAMOMÉTRIQUES
- 53 BARRES D'EXTENSION
- 53 TOURNEVIS
- 56 PINCES
- 62 OUTILS D'INSPECTION
- 63 MARTEAUX
- 64 OUTILS DE COUPE
- 65 CISEAUX
- 66 RIVETEUSES
- 68 OUTILS DE MESURE
- 69 DIVERS

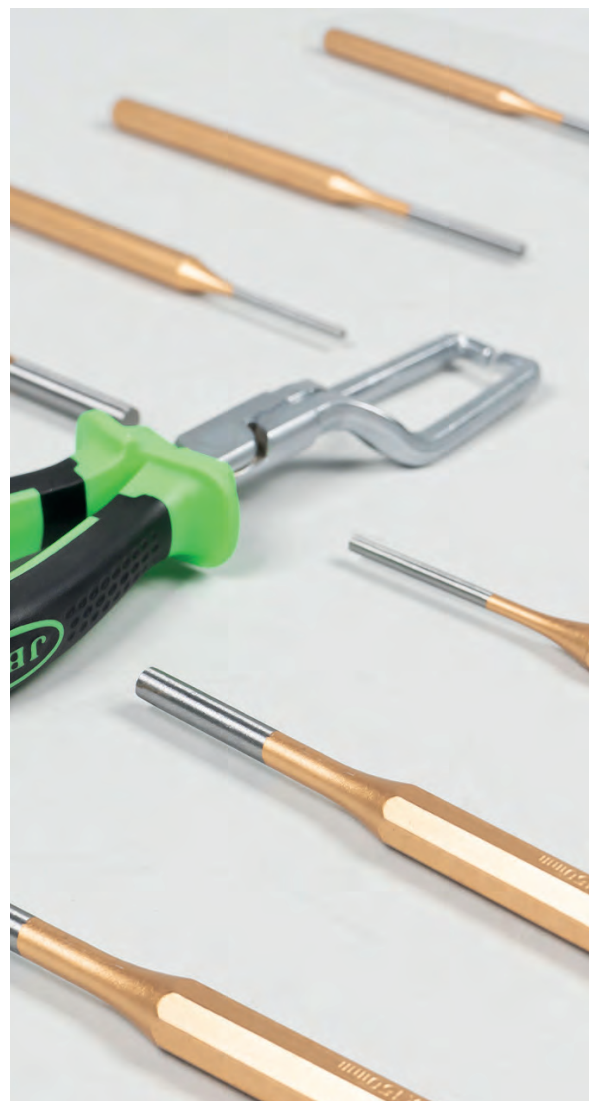

54101

61,00€

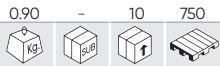

JEU DE 6 CLÉS CLIQUETS



8x9, 10x11, 12x13,
14x15, 16x18, 17x19mm



PIÈCES DE RECHANGE DISPONIBLES

REF.	mm	Kg	Box	Box	€
15632	8x9	0.04	10	100	9,00€
15633	10x11	0.07	10	100	9,50€
15634	12x13	0.11	10	100	11,00€

REF.	mm	Kg	Box	Box	€
15635	14x15	0.13	10	100	12,50€
15636	16x18	0.19	10	100	14,00€
15637	17x19	0.25	10	100	15,00€

53017

57,00€

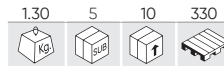

JEU DE 7 CLÉS MIXTES A CLIQUET ARTICULÉES



8, 10, 11, 13,
14, 17, 19 mm



PIÈCES DE RECHANGE DISPONIBLES

REF.	mm	Kg	Box	Box	€
10552	8	0.06	10	100	7,10€
10554	10	0.09	10	100	7,50€
10555	11	0.09	10	100	7,80€
10557	13	0.13	10	100	8,10€

REF.	mm	Kg	Box	Box	€
10558	14	0.14	5	100	9,35€
10561	17	0.22	10	100	11,00€
10563	19	0.28	10	100	12,50€

54117

74,00€

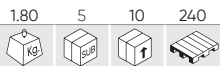

JEU DE 12 CLÉS COMBINÉES AVEC CLIQUET



8, 9, 10, 11, 12, 13, 14, 15,
16, 17, 18, 19 mm



PIÈCES DE RECHANGE DISPONIBLES

REF.	mm	Kg	Box	Box	€
13465	8	0.05	10	100	5,55€
13466	9	0.06	10	100	5,55€
13467	10	0.10	10	100	6,00€
13468	11	0.08	10	100	6,25€
13469	12	0.09	10	100	6,25€
13470	13	0.10	10	100	6,60€

REF.	mm	Kg	Box	Box	€
13471	14	0.11	10	100	6,90€
13472	15	0.13	10	100	7,25€
13473	16	0.15	10	100	8,10€
13474	17	0.19	10	100	8,70€
13475	18	0.22	10	100	9,10€
13476	19	0.22	10	100	9,60€

51318

98,00€

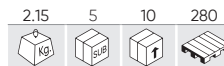

JEU DE 12 CLÉS MIXTES A CLIQUET ARTICULÉES



8, 9, 10, 11, 12, 13, 14,
15, 16, 17, 18, 19 mm



PIÈCES DE RECHANGE DISPONIBLES

REF.	mm	Kg	Box	Box	€
10552	8	0.06	10	100	7,10€
10553	9	0.07	10	100	7,35€
10554	10	0.09	10	100	7,50€
10555	11	0.09	10	100	7,80€
10556	12	0.11	10	100	8,10€
10557	13	0.13	10	100	8,10€

REF.	mm	Kg	Box	Box	€
10558	14	0.14	5	100	9,35€
10559	15	0.16	10	100	9,50€
10560	16	0.19	5	50	10,60€
10561	17	0.22	10	100	11,00€
10562	18	0.26	5	100	12,30€
10563	19	0.28	10	100	12,50€

54338



60,00€

N

CLÉ À CLIQUET À TÊTE INTERCHANGEABLE 12 PCS

PIÈCES DE RECHANGE DISPONIBLES

REF.	mm				€	REF.	mm				€
16391	8	0.01	30	100	4,60€	16397	14	0.05	30	100	5,50€
16392	9	0.05	30	100	4,60€	16398	15	0.05	30	100	5,50€
16393	10	0.05	30	100	4,60€	16399	16	0.05	30	100	5,50€
16394	11	0.05	30	100	5,10€	16401	17	0.05	30	100	6,10€
16395	12	0.05	30	100	5,10€	16402	18	0.05	30	100	6,10€
16396	13	0.05	30	100	5,10€	16403	19	0.10	30	100	6,10€

12 PCS 72

8, 9, 10, 11, 12, 13, 14, 15, 16, 17, 18, 19 mm

ARTICULADA ARTICULATED



15316

58,00€

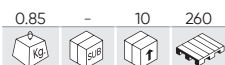

JEU DE 3 CLÉS A 72 DENTS - TYPE « 4 EN 1 »

3 PCS 72



PIÈCES DE RECHANGE DISPONIBLES

REF.	mm				€
15515	12-13mm x 8-10mm	0.15	10	50	15,50€
15516	14-15mm x 9-11mm	0.20	10	50	19,00€
15517	18-19mm x 16-17mm	0.40	5	50	22,50€

54066

83,00€



JEU DE 7 CLÉS EXTRA LONGUES AVEC CLIQUET

7 PCS 72



PIÈCES DE RECHANGE DISPONIBLES

REF.	mm				€	REF.	mm				€
13453	8	0.10	6	36	9,00€	13457	14	0.25	6	36	12,00€
13454	10	0.15	10	100	9,50€	13460	17	0.40	6	24	15,00€
13455	12	0.20	6	36	10,50€	13462	19	0.50	6	24	17,00€
13456	13	0.20	6	36	11,50€						

54032

84,00€



JEU DE 12 CLÉS MIXTES À CLIQUET ARTICULÉES COURTES

12 PCS 90

ARTICULADA ARTICULATED



PIÈCES DE RECHANGE DISPONIBLES

REF.	mm				€	REF.	mm				€
15328	8	0.05	12	96	6,00€	15334	14	0.11	12	96	7,00€
15329	9	0.05	12	96	5,50€	15335	15	0.13	12	96	7,50€
15330	10	0.05	12	96	5,50€	15336	16	0.14	12	96	8,00€
15331	11	0.07	12	96	5,50€	15337	17	0.16	12	96	8,50€
15332	12	0.09	12	96	6,00€	15338	18	0.18	12	96	9,00€
15333	13	0.10	12	96	6,50€	15339	19	0.20	12	96	9,50€

15122

74,00€



MODULE EVA CARBONE DE 12 CLÉS AVEC CLIQUET

12 PCS 72



PIÈCES DE RECHANGE DISPONIBLES

REF.	mm				€	REF.	mm				€
13465	8	0.05	10	100	5,55€	13471	14	0.11	10	100	6,90€
13466	9	0.06	10	100	5,55€	13472	15	0.13	10	100	7,25€
13467	10	0.10	10	100	6,00€	13473	16	0.15	10	100	8,10€
13468	11	0.08	10	100	6,25€	13474	17	0.19	10	100	8,70€
13469	12	0.09	10	100	6,25€	13475	18	0.22	10	100	9,10€
13470	13	0.10	10	100	6,60€	13476	19	0.22	10	100	9,60€

53018

119,00€

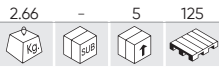



JEU DE 6 CLÉS A CLIQUET ARTICULÉES

6 PCS   72

8x9, 10x11, 12x13,
14x15, 16x18, 17x19mm

 ARTICULADA
ARTICULATED

PIÈCES DE RECHANGE DISPONIBLES

REF.	mm				€
13447	8x9	0.10	6	36	16,50€
13448	10x11	0.15	6	36	17,50€
13449	12x13	0.25	6	36	20,00€
13450	14x15	0.30	6	36	23,00€
13451	16x18	0.35	6	24	28,00€
13452	17x19	0.40	6	24	29,50€



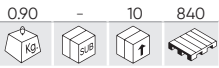

54110

46,00€





JEU DE 8 CLÉS MIXTES A CLIQUET COURTES

8 PCS   72

10, 11, 12, 13, 14,
15, 17, 19mm

PIÈCES DE RECHANGE DISPONIBLES

REF.	mm				€
13491	10	0.05	10	100	5,30€
13492	11	0.06	10	100	5,35€
13493	12	0.07	10	100	5,50€
13494	13	0.08	5	100	6,00€
13495	14	0.09	10	100	6,40€
13496	15	0.12	10	100	6,60€
13497	17	0.14	10	100	7,50€
13498	19	0.19	10	100	8,50€



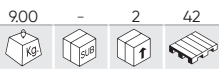

54041

198,00€



JEU DE 22 CLÉS COMBINÉES AVEC CLIQUET

22 PCS   90

6, 7, 8, 9, 10, 11, 12, 13, 14, 15, 16,
17, 18, 19, 20, 21, 22, 23, 24,
27, 30, 32mm

PIÈCES DE RECHANGE DISPONIBLES

REF.	mm				€
13463	6	0.03	10	100	5,30€
13464	7	0.04	10	100	5,30€
13465	8	0.05	10	100	5,55€
13466	9	0.06	10	100	5,55€
13467	10	0.10	10	100	6,00€
13468	11	0.08	10	100	6,25€
13469	12	0.09	10	100	6,25€
13470	13	0.10	10	100	6,60€
13471	14	0.11	10	100	6,90€
13472	15	0.13	10	100	7,25€
13473	16	0.15	10	100	8,10€
13474	17	0.19	10	100	8,70€
13475	18	0.22	10	100	9,10€
13476	19	0.22	10	100	9,60€
13477	20	0.23	6	60	9,85€
13478	21	0.37	6	60	12,20€
13479	22	0.37	6	60	13,10€
13480	23	0.37	6	48	15,50€
13481	24	0.53	6	48	15,80€
13482	27	0.60	6	24	22,10€
13483	30	0.80	6	24	25,50€
13484	32	1.12	6	24	27,20€



54079

83,00€

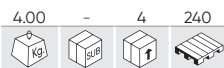

JEU DE 21 CLÉS MIXTES

21 PCS 6, 7, 8, 9, 10, 11, 12, 13, 14, 15, 16, 17, 18, 19, 20, 21, 22, 24, 27, 30, 32mm

PIÈCES DE RECHANGE DISPONIBLES

REF.	mm	kg	sub	mm	€
10531	10	0.05	10	100	3,00€
10532	11	0.06	10	100	2,70€
10533	12	0.07	10	100	3,00€
10534	13	0.08	10	100	3,25€
10535	14	0.10	10	100	3,50€
10536	15	0.10	10	100	3,65€
10537	16	0.11	10	100	3,90€
10538	17	0.14	10	100	4,30€
10539	18	0.16	10	100	4,75€

REF.	mm	kg	sub	mm	€
10540	19	0.20	10	100	5,25€
10541	20	0.21	6	60	5,55€
10542	21	0.25	-	50	5,85€
10543	22	0.25	-	50	7,00€
10544	24	0.33	10	100	8,10€
10545	27	0.41	10	50	9,75€
10546	30	0.52	-	25	11,60€
10547	32	0.59	-	25	13,50€
10548	6	0.03	10	100	1,75€

REF.	mm	kg	sub	mm	€
10549	7	0.03	10	100	2,00€
10550	8	0.03	10	100	2,15€
10551	9	0.04	10	100	2,15€



54097

38,90€

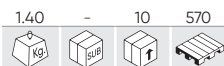

JEU DE 14 CLÉS PLATES MIXTES

14 PCS CrV 6, 7, 8, 9, 10, 11, 12, 13, 14, 15, 16, 17, 18, 19 mm

PIÈCES DE RECHANGE DISPONIBLES

REF.	mm	kg	sub	mm	€
10531	10	0.05	10	100	3,00€
10532	11	0.06	10	100	2,70€
10533	12	0.07	10	100	3,00€
10534	13	0.08	10	100	3,25€
10535	14	0.10	10	100	3,50€
10536	15	0.10	10	100	3,65€
10537	16	0.11	10	100	3,90€

REF.	mm	kg	sub	mm	€
10538	17	0.14	10	100	4,30€
10539	18	0.16	10	100	4,75€
10540	19	0.20	10	100	5,25€
10548	6	0.03	10	100	1,75€
10549	7	0.03	10	100	2,00€
10550	8	0.03	10	100	2,15€
10551	9	0.04	10	100	2,15€



54120

59,00€



JEU DE 7 CLÉS PLATES MIXTES

7 PCS CrV 20, 21, 22, 24, 27, 30, 32mm



PIÈCES DE RECHANGE DISPONIBLES

REF.	mm	kg	sub	mm	€
10541	20	0.21	6	60	5,55€
10542	21	0.25	-	50	5,85€
10543	22	0.25	-	50	7,00€
10544	24	0.33	10	100	8,10€

REF.	mm	kg	sub	mm	€
10545	27	0.41	10	50	9,75€
10546	30	0.52	-	25	11,60€
10547	32	0.59	-	25	13,50€

54174

139,00€



JEU DE 6 CLÉS PLATES MIXTES

6 PCS CrV XL 34, 36, 38, 41, 46, 50mm



PIÈCES DE RECHANGE DISPONIBLES

REF.	mm	kg	sub	mm	€
16020	34	0.36	10	100	17,00€
16021	36	0.00	10	100	19,50€
16022	38	0.43	10	100	23,00€

REF.	mm	kg	sub	mm	€
16023	41	0.47	10	100	26,50€
16024	46	0.51	10	100	34,50€
16025	50	0.58	10	100	37,50€

OUTILS À MAIN

50564

30,00€

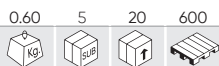

JEU DE 8 CLÉS PLATES MIXTES SÉRIE COURTE



PIÈCES DE RECHANGE DISPONIBLES

REF.	mm				€	REF.	mm				€	REF.	mm				€
10564	10	0.05	10	100	2,50€	10567	13	0.05	10	100	3,50€	10570	17	0.10	10	100	4,50€
10565	11	0.05	10	100	3,50€	10568	14	0.05	10	100	4,00€	10571	19	0.15	10	100	5,00€
10566	12	0.05	10	100	3,50€	10569	15	0.05	10	100	4,50€						



54150

23,50€

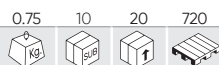

JEU DE 7 CLÉS PLATES

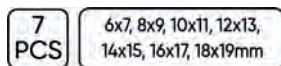

PIÈCES DE RECHANGE DISPONIBLES

REF.	mm				€	REF.	mm				€
10579	10x11	0.06	10	100	3,00€	10583	18x19	0.19	10	100	4,15€
10580	12x13	0.07	10	100	3,10€	10589	6x7	0.03	10	100	2,00€
10581	14x15	0.10	10	100	3,40€	10590	8x9	0.04	10	100	2,40€
10582	16x17	0.14	10	100	4,00€						



54149

60,00€



JEU DE 12 CLÉS PLATES

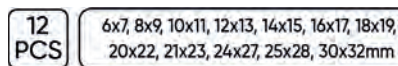

PIÈCES DE RECHANGE DISPONIBLES

REF.	mm				€	REF.	mm				€
10579	10x11	0.06	10	100	3,00€	10585	21x23	0.31	-	50	6,75€
10580	12x13	0.07	10	100	3,10€	10586	24x27	0.35	10	100	7,60€
10581	14x15	0.10	10	100	3,40€	10587	25x28	0.36	-	50	9,80€
10582	16x17	0.14	10	100	4,00€	10588	30x32	0.54	-	25	10,50€
10583	18x19	0.19	10	100	4,15€	10589	6x7	0.03	10	100	2,00€
10584	20x22	0.25	6	60	5,05€	10590	8x9	0.04	10	100	2,40€



52973

59,00€



JEU DE 12 CLÉS PLATES - BRILLANT

PIÈCES DE RECHANGE DISPONIBLES

REF.	mm				€	REF.	mm				€
10579	10x11	0.06	10	100	3,00€	10585	21x23	0.31	-	50	6,75€
10580	12x13	0.07	10	100	3,10€	10586	24x27	0.35	10	100	7,60€
10581	14x15	0.10	10	100	3,40€	10587	25x28	0.36	-	50	9,80€
10582	16x17	0.14	10	100	4,00€	10588	30x32	0.54	-	25	10,50€
10583	18x19	0.19	10	100	4,15€	10589	6x7	0.03	10	100	2,00€
10584	20x22	0.25	6	60	5,05€	10590	8x9	0.04	10	100	2,40€



6x7, 8x9, 10x11, 12x13, 14x15, 16x17, 18x19, 20x22, 21x23, 24x27, 25x28, 30x32mm



54115 26,80€

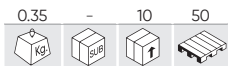

JEU DE 4 CLÉS TORX PLATES

4 PCS E6xE8, E10xE12, E14xE18, E20xE24



PIÈCES DE RECHANGE DISPONIBLES

REF.	mm				€
16546	E6xE8	0.05	10	100	5,00€
16547	E10xE12	0.07	10	100	5,50€
16548	E14xE18	0.08	10	100	9,00€
16549	E20xE24	0.09	10	100	14,00€

54081 28,00€

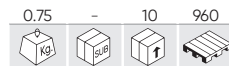

JEU DE CLÉS PLATES MIXTES 6 PANS

5 PCS 10x11HEX, 12x13HEX, 14x15HEX, 16x17HEX, 18x19HEX



PIÈCES DE RECHANGE DISPONIBLES

REF.	mm				€
11258	10x11	0.10	5	100	7,30€
11259	12x13	0.10	5	100	8,30€
11260	14x15	0.11	5	100	9,75€
11261	16x17	0.18	5	100	11,35€
11262	18x19	0.21	-	100	13,50€

54159 47,00€

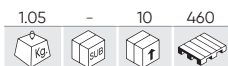

JEU DE 8 CLÉS TIP C DEMI LUNE 12 PANS

8 PCS

6x7, 8x9, 10x11, 12x13, 14x15, 16x17, 18x19, 20x22mm



PIÈCES DE RECHANGE DISPONIBLES

REF.	mm				€
11639	6x7	0.61	5	50	4,00€
11640	8x9	0.04	5	50	4,50€
11641	10x11	0.04	5	50	5,00€
11642	12x13	0.06	5	50	5,00€

REF.	mm				€
11643	14x15	0.09	5	-	6,00€
11644	16x17	0.12	5	50	7,00€
11645	18x19	0.15	5	50	7,00€
11646	20x22	0.22	5	-	9,45€

52451 42,00€

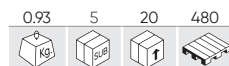

JEU DE 8 CLÉS TIP C DEMI LUNE 12 PANS

8 PCS

6x7, 8x9, 10x11, 12x13, 14x15, 16x17, 18x19, 20x22mm



PIÈCES DE RECHANGE DISPONIBLES

REF.	mm				€
11639	6x7	0.61	5	50	4,00€
11640	8x9	0.04	5	50	4,50€
11641	10x11	0.04	5	50	5,00€
11642	12x13	0.06	5	50	5,00€

REF.	mm				€
11643	14x15	0.09	5	-	6,00€
11644	16x17	0.12	5	50	7,00€
11645	18x19	0.15	5	50	7,00€
11646	20x22	0.22	5	-	9,45€

15156 70,00€

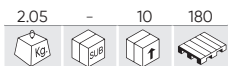

JEU DE 4 CLÉS FERMÉES DOUBLE FACE EN FIBRE DE CARBONE, PLATEAU EN EVA

PIÈCES DE RECHANGE DISPONIBLES

REF.	mm				€
15206	21x23	0.45	5	50	15,00€
15207	24x27	0.50	5	50	16,50€
15208	25x28	0.45	5	50	17,00€
15209	30x32	0.67	10	50	18,00€

4 PCS 21x23, 24x27, 25x28, 30x32mm



OUTILS À MAIN

54119

78,00€

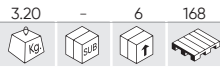

JEU DE 12 CLÉS À OEIL CONTRE COUDÉE 12 PANS

12 PCS



6x7, 8x9, 10x11, 12x13, 14x15, 16x17, 18x19, 20x22, 21x23, 24x27, 25x28, 30x32mm



PIÈCES DE RECHANGE DISPONIBLES

REF.	mm				€	REF.	mm				€
10627	6x7	0.04	10	100	2,80€	10633	18x19	0.22	10	100	6,60€
10628	8x9	0.06	10	100	3,10€	10634	20x22	0.43	-	50	7,80€
10629	10x11	0.08	10	100	3,65€	10635	21x23	0.30	-	50	8,15€
10630	12x13	0.11	10	100	3,90€	10636	24x27	0.35	-	25	8,80€
10631	14x15	0.14	10	100	4,20€	10637	25x28	0.48	6	24	12,10€
10632	16x17	0.18	10	100	5,30€	10638	30x32	0.73	6	24	12,70€

50562

23,50€

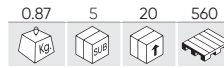

JEU DE 7 CLÉS CONTRECOURBÉES AVEC DEUX MÂCHOIRES

7 PCS



6x7, 8x9, 10x11, 12x13, 14x15, 16x17, 18x19mm



PIÈCES DE RECHANGE DISPONIBLES

REF.	mm				€	REF.	mm				€
10627	6x7	0.04	10	100	2,80€	10631	14x15	0.14	10	100	4,20€
10628	8x9	0.06	10	100	3,10€	10632	16x17	0.18	10	100	5,30€
10629	10x11	0.08	10	100	3,65€	10633	18x19	0.22	10	100	6,60€
10630	12x13	0.11	10	100	3,90€						

51528

49,00€

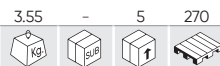

JEU DE 14 CLÉS PIPE À DOUBLE BOUCHE

14 PCS



8, 9, 10, 11, 12, 13, 14, 15, 16, 17, 18, 19, 20, 21mm



PIÈCES DE RECHANGE DISPONIBLES

REF.	mm				€	REF.	mm				€
10591	10	0.09	10	200	2,50€	10598	17	0.32	10	60	4,60€
10592	11	0.12	10	200	2,55€	10599	18	0.43	10	40	6,00€
10593	12	0.16	10	120	3,15€	10600	19	0.41	10	40	6,25€
10594	13	0.17	10	100	3,20€	10601	20	0.45	10	30	6,50€
10595	14	0.20	10	100	3,35€	10602	21	0.47	10	30	7,05€
10596	15	0.25	10	70	4,25€	10603	8	0.07	10	300	2,10€
10597	16	0.30	10	70	4,50€	10604	9	0.08	10	200	2,25€

53420

72,00€

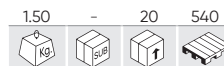

JEU DE 8 CLÉS TUBE

8 PCS



6x7, 8x9, 10x11, 12x13, 14x15, 16x17, 18x19, 20x22mm



53979

34,60€

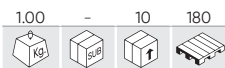

COFFRET DE 8 CLÉS TORX POIGNOTÉE



T10x75, T15x75, T20x100, T25x100, T30x150, T40x150, T45x200, T50x200mm

53980

34,60€

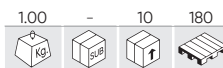

COFFRET DE 8 CLÉS 6 PANS POIGNOTÉE

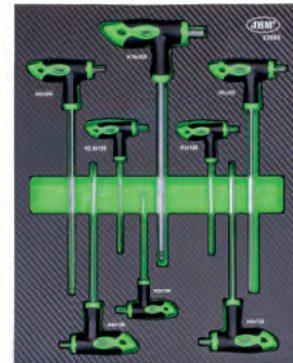

H2x100, H2.5x100, H3x100, H4x150, H5x150, H6x200, H8x200, H10x200

JEUX DE 6 CLÉS PLATES EXTRA LONGUES

51864

64,00€



10x11mm (290mmL), 12x14mm (330mmL), 13x15mm (368mmL), 16x18mm (407mmL), 17x19mm (407mmL), 22x24mm (430mmL)



52912

91,00€



E6xE7 (200mmL), E8xE10 (235mmL), E11xE12 (290mmL), E14xE16 (370mmL), E18xE20 (410mmL), E22xE24 (420mmL)



PIÈCES DE RECHANGE DISPONIBLES

REF.	mm				€	REF.	mm				€
11244	10x11	0.13	5	100	8,50€	11247	16x18	0.30	6	36	14,00€
11245	12x14	0.18	10	50	9,15€	11248	17x19	0.31	10	36	14,60€
11246	13x15	0.25	6	36	12,40€	11249	22x24	0.43	5	-	26,50€

KIT DE 9 BUSES

TORX

REF.	mm	DESCRIPTION				€
53737	90-218mm	JEU DE 9 BUSES TORX (EXTRA LONGUES)	0.42	10	40 1000	12,50€
53739	86-150mm	JEU DE 9 BUSES TORX (LONGUES)	0.32	10	40 960	10,50€
53955	72-170mm	JEU DE 9 BUSES TORX (COURTES)	0.25	10	40 1480	10,00€



T10, T15, T20, T25, T27, T30, T40, T45, T50

HEXAGONALES

REF.	mm	DESCRIPTION				€
53738	90-220mm	JEU DE 9 BUSES HEXAGONALES (EXTRA LONGUES)	0.45	10	40 1000	10,90€
53740	72-170mm	JEU DE 9 BUSES HEXAGONALES (LONGUES)	0.37	10	40 960	9,10€
53954	43-97mm	JEU DE 9 BUSES HEXAGONALES (COURTES)	0.25	10	40 1480	8,50€



1,5, 2, 2,5, 3, 4, 5, 6, 8, 10mm



OUTILS À MAIN

51659

59,00€

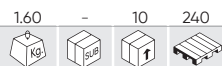

COFFRET CLÉS A DOUILLES ARTICULÉES 6 PIÈCES 12 PANS

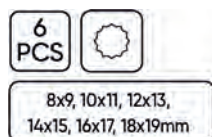

PIÈCES DE RECHANGE DISPONIBLES

REF.	mm	Kg	SUB	Height	Length	€
10621	8-9	0.09	10	100	9,50€	
10622	10-11	0.13	10	100	10,00€	
10623	12-13	0.16	5	100	12,60€	

50622

64,00€

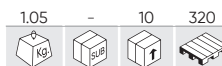

COFFRET CLES A DOUILLES ARTICULÉES 4 PIÈCES TORX

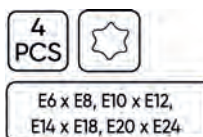

PIÈCES DE RECHANGE DISPONIBLES

REF.	mm	Kg	SUB	Height	Length	€
10617	E6xE8	0.07	10	100	14,10€	
10618	E10xE12	0.11	10	100	15,10€	
10619	E14xE18	0.20	10	100	15,70€	
10620	E20xE24	0.34	10	100	16,20€	

54187

39,30€



JEU DE 10 CLÉ À PIED-DE-BICHE 3/8"

PIÈCES DE RECHANGE DISPONIBLES

REF.	mm	Kg	SUB	Height	Length	€
16010	10	0.04	10	100	4,00€	
16011	11	0.04	10	100	4,00€	
16012	13	0.04	10	100	4,00€	
16013	14	0.05	10	100	4,50€	
16014	15	0.05	10	100	4,50€	

REF.	mm	Kg	SUB	Height	Length	€
16015	16	0.05	10	100	5,00€	
16016	17	0.05	10	100	5,00€	
16017	18	0.06	10	100	5,00€	
16018	19	0.06	10	100	5,50€	
16019	22	0.08	10	100	6,00€	

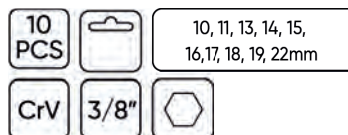

OUTILS EN POUCE

51890

92,00€

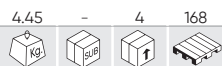

JEU DE 17 CLÉS MIXTES EN POUCE

17 PCS

5/16, 3/8, 7/16, 1/2, 9/16, 19/32, 5/8, 11/16, 3/4, 13/16, 7/8, 15/16, 1", 1 1/16, 1 1/8, 1 3/16, 1 1/4



54005

14,00€

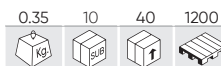

JEU DE 9 CLÉS ALLEN EN POUCE

9 PCS

CrV



1/16", 5/64", 3/32", 1/8", 5/32", 3/16", 1/4", 5/16", 3/8"

72-170mm



54106

89,00€

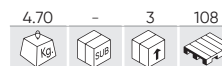

MALLETTE D'OUTILS EN POUÇES DE 37 PIÈCES ZINGUÉES

37 PCS

CrV

1/2"

1/4"



CLÉ EN CROIX CROISEMENT SOUDÉ

51661 12,00€

1.17 5 20 360

1/2" 355mm

17, 19, 21mm

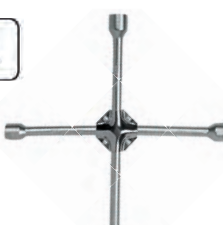

52880 42,00€

3.75 - 5 120

3/4" 700mm

24, 27, 32mm

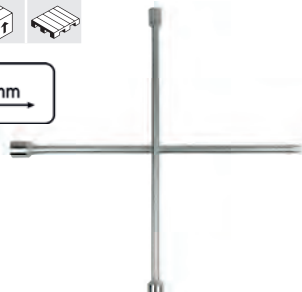

52881 17,00€

1.40 - 10 480

1/2" 400mm

17, 19, 21, 22mm



51416 12,00€

1.05 10 20 360

CLÉ TELESCOPIQUE À DOUILLE REVERSIBLE 330-490MM





1/2"



17/19mm
21/23mm





CLÉ À MOLETTE

MODÈLE 1

REF.	DESCRIPTION		mm					€
51798	CLÉ À MOLETTE 18"	53mm	450mm	1.90	3	12	480	39,60€
52424	CLÉ À MOLETTE 24"	62mm	610mm	3.75	-	5	350	64,00€



MODÈLE 2

REF.	DESCRIPTION		mm					€
51795	CLÉ À MOLETTE 8"	22mm	200mm	0.28	6	60	3600	9,00€
51796	CLÉ À MOLETTE 10"	28mm	250mm	0.48	6	36	2400	14,00€
51797	CLÉ À MOLETTE 12"	37mm	300mm	0.71	6	24	960	18,00€



MODÈLE 3

REF.	DESCRIPTION		mm					€
53639	CLÉ À MOLETTE 6"	28mm	150mm	0.15	6	96	576	28,60€
53640	CLÉ À MOLETTE 8"	30mm	200mm	0.28	6	72	504	34,40€
53641	CLÉ À MOLETTE 10"	33mm	250mm	0.50	6	36	1151	41,00€
53642	CLÉ À MOLETTE 12"	40mm	300mm	0.83	6	10	1200	54,00€
53643	CLÉ À MOLETTE 16"	52mm	400mm	1.53	-	12	336	92,00€
54098	CLÉ À MOLETTE 20"	65mm	640mm	2.70	-	6	-	158,50€





53654 81,00€

1.40 - 5 200





JEU DE CLÉS À CROCHET

8 PCS 35-60, 60-90, 90-120mm

160mm 177mm 250mm







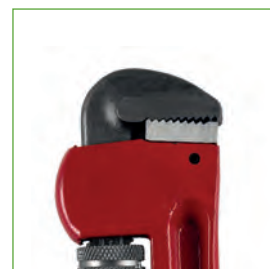

CLÉ STILLSON SERRE-TUBE

REF.	DESCRIPTION		"					€
52235	CLÉ STILLSON SERRE-TUBE 300MM	50mm	12"	0.90	6	24	1140	11,00€
52236	CLÉ STILLSON SERRE-TUBE 350MM	60mm	14"	1.09	6	24	760	13,30€
52237	CLÉ STILLSON SERRE-TUBE 450MM	70mm	18"	1.75	4	12	720	18,10€
52238	CLÉ STILLSON SERRE-TUBE 600MM	75mm	24"	2.50	2	8	600	24,90€
53210	CLÉ STILLSON SERRE-TUBE 915MM	110mm	36"	4.95	-	4	96	48,00€







CLÉ STILLSON ALUMINIUM

REF.	DESCRIPTION		mm					€
53070	CLÉ STILLSON ALUMINIUM 12"	45mm	270mm	0.68	6	24	900	16,20€
53071	CLÉ STILLSON ALUMINIUM 14"	50mm	320mm	0.92	4	12	900	26,10€
53072	CLÉ STILLSON ALUMINIUM 18"	65mm	410mm	1.35	4	12	900	31,60€
53073	CLÉ STILLSON ALUMINIUM 24"	75mm	540mm	2.05	2	8	1000	50,00€



SERRE JOINT

REF.	DESCRIPTION					€
52349	SERRE JOINT 90X200MM	1.25	-	10	480	22,10€
52350	SERRE JOINT 90X300MM	1.41	-	10	540	22,60€
52351	SERRE JOINT 90X400MM	1.60	-	10	480	25,40€
52352	SERRE JOINT 120X300MM	1.99	-	10	360	32,40€
52353	SERRE JOINT 120X400MM	2.10	-	10	350	33,40€
52354	SERRE JOINT 120X500MM	2.41	-	6	300	34,40€
52355	SERRE JOINT 120X600MM	2.62	-	4	300	36,60€
52357	SERRE JOINT 150X800MM	4.60	-	5	125	54,00€
52358	SERRE JOINT 150X1000MM	5.35	-	5	120	63,00€



CLIQUET 72 DENTS AVEC DOUILLES

REF.	DESCRIPTION					€
54028	CLIQUET 72 DENTS DE 1/2" AVEC DOUILLES HEX.	1.30	4	24	432	28,00€
54029	CLIQUET 72 DENTS DE 1/2" AVEC DOUILLES 12 PANS	1.25	4	24	432	28,00€
54030	CLIQUET 72 DENTS DE 1/4" AVEC DOUILLES HEX.	0.35	6	36	1008	18,80€
54031	CLIQUET 72 DENTS DE 1/4" AVEC DOUILLES 12 PANS	0.35	6	36	864	19,30€



	54028 - 54029	10, 11, 12, 13, 14, 15, 16, 17, 18, 19mm
	54030 - 54031	4, 5, 6, 7, 8, 9, 10, 11, 12, 13mm

CLIQUET 72 DENT

CHROMÉ

REF.	DESCRIPTION					€
54022	CLIQUET 72 DENTS DE 1/4" 145MM – ACIER CHROMÉ	0.15	12	36	1440	9,95€
54023	CLIQUET 72 DENTS DE 3/8" 200MM – ACIER CHROMÉ	0.30	12	24	1440	13,50€
54024	CLIQUET 72 DENTS DE 1/2" 255MM – ACIER CHROMÉ	0.60	12	24	960	17,90€



PRÉSENTOIR DE 12 UNITÉS



ACIER ZINGUÉ

REF.	DESCRIPTION					€
54018	CLIQUET 72 DENTS DE 1/4" 145MM - ACIER ZINGUÉ	0.15	12	36	1440	9,85€
54019	CLIQUET 72 DENTS DE 1/2" 255MM - ACIER ZINGUÉ	0.60	12	24	864	17,90€
54021	CLIQUET 72 DENTS DE 3/8" 200MM - ACIER ZINGUÉ	0.60	12	24	1440	13,50€



PRÉSENTOIR DE 12 UNITÉS



CLIQUET 72 DENTS ACIER ZINGUÉ

REF.	DESCRIPTION					€
54083	CLIQUET À MANCHE DROIT 72 DENTS - 1/4"	0.14	12	24	2592	9,75€
54084	CLIQUET À MANCHE DROIT 72 DENTS - 3/8"	0.30	12	24	1440	13,10€
54085	CLIQUET À MANCHE DROIT 72 DENTS - 1/2"	0.60	12	24	960	17,80€



PRÉSENTOIR DE 12 UNITÉS



CLIQUET À MANCHE LARGE DROIT 72 DENTS

REF.	DESCRIPTION					€
54086	CLIQUET À MANCHE LARGE DROIT 72 DENTS 1/4	0.10	12	24	2592	9,25€
54087	CLIQUET À MANCHE LARGE DROIT 72 DENTS - 1/2 POUCE	0.50	12	24	1008	17,30€



PRÉSENTOIR DE 12 UNITÉS



OUTILS À MAIN

52197

36,30€



CLIQUET ARTICULÉ EXTENSIBLE 72 DENTS DE 1/2"

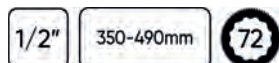

PRÉSENTOIR DE 6 UNITÉS

52207

24,20€



MINI CLIQUET 1/4 "72 DENTS 85MM - ACIER ZINGUÉ



PRÉSENTOIR DE 12 UNITÉS

CLIQUET ARTICULÉ 72 DENTS

REF.						€
52587	1/4" 172mm	0.16	12	144	3456	39,90€
52588	1/2" 172mm	0.17	12	144	3456	45,00€



PRÉSENTOIR DE 12 UNITÉS



CLIQUET ARTICULÉ 72 DENTS

REF.						€
51305	1/2" 175mm	0.31	12	48	816	28,90€
51306	1/4" 165mm	0.30	12	48	816	28,10€



PRÉSENTOIR DE 12 UNITÉS



CLIQUET À TÊTE PIVOTANTE 72 DENTS

REF.						€
51405	1/4" 145mm	0.58	12	24	-	21,10€
51406	1/2" 280mm	0.66	12	24	864	29,20€



PRÉSENTOIR DE 12 UNITÉS



CLIQUET EXTENSIBLE 72 DENTS

REF.						€
51307	1/2" 305-445mm	0.92	6	12	360	29,70€
53346	1/4" 150-200mm	0.25	6	12	-	18,00€
54304	1/2" 450-610mm	1.15	-	6	480	26,00€



PRÉSENTOIR DE 6 UNITÉS



CLIQUET LONG 72 DENTS

REF.	DESCRIPTION					€
53886	1/4" 305mm	0.27	10	40	1680	20,30€
53887	3/8" 457mm	0.68	10	20	700	30,30€
53888	1/2" 609mm	1.27	4	16	480	37,90€



RECHANGE

REF.	"					€
15147	3/8"	0.10	-	100	-	5,00€

REF.	"					€
15148	1/2"	0.20	-	100	-	5,00€

REF.	"					€
15149	1/4"	0.05	-	100	-	5,00€



51801

62,00€

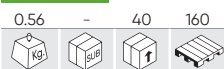

CLIQUET FLEXIBLE 72 DENTS DE 3/8" 500MM



POUR LES ENDROITS DIFFICILE D'ACCÈS

COMMANDE AVEC POIGNÉE

TÊTE PIVOTANTE



53671

41,00€



KIT DE 3 CLIQUETS RACCOURCIS

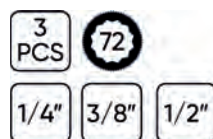

KIT DE RÉPARATION POUR CLÉ À CLIQUET

REF.	DESCRIPTION					€
15138	1/4"	0.10	-	50	-	10,50€
15139	3/8"	0.15	-	50	-	12,00€
15140	1/2"	0.20	-	50	-	13,50€

54339

273,00€



CLÉ DYNAMOMÉTRIQUE NUMÉRIQUE DIGITAL 1/2" 10-200NM



N

52913

292,00€



CLÉ DYNAMOMÉTRIQUE AVEC LA TÊTE INTERCHANGEABLE, 200NM

1/2"

	x1	1/2"
	x9	13, 14, 15, 17, 19, 22, 24, 27, 30mm
	x1	40-200Nm

- Certificat d'étalonnage d'usine inclus.



54269

56,00€



ENSEMBLE DE 21 PIÈCES AVEC CLÉ DYNAMOMÉTRIQUE 1/4"

1/4" N

	x1	5-25Nm		x3	PH1, PH2, PH3
	x1	100mm		x8	H2, H2.5, H3, H4, H5, H6, H8, H10 (37mmL)
	x1	UNIVERSAL		x1	H5 (87mmL)
	x1	1/4" (F) - 3/8" (M)		x5	T10, T15, T20, T25, T30



53972

550,00€

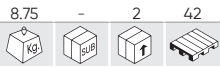

CLÉ DYNAMOMÉTRIQUE DE 3/4"

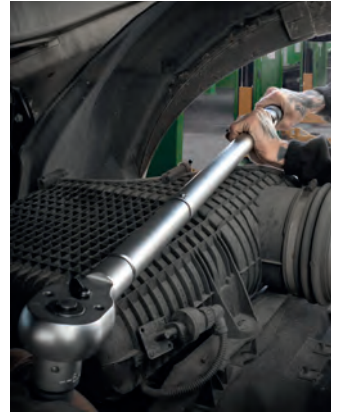
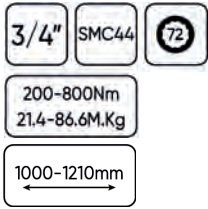

- Certificat d'étalonnage d'usine inclus.

CLÉ DYNAMOMÉTRIQUE AVEC JUDAS

REF.	DESCRIPTION					€
53081	1/4" 4-20NM (36T) 375mm	1.10	5	25	350	115,00€
53082	1/2" 40-210NM (24T) 560mm	1.90	4	8	168	148,00€

- Certificat d'étalonnage d'usine inclus.



CLÉ DYNAMOMÉTRIQUE

REF.	DESCRIPTION					€
51127	1/2" 28-210NM 470mm	1.70	4	8	256	56,00€
51262	1/4" 5-25NM 270mm	0.80	4	16	384	51,00€
51338	3/8" 19-110NM 365mm	1.05	4	16	384	53,00€



TROUSSE DE RÉPARATION

REF.	"					€	REF.	"					€	REF.	"					€
51127R	1/2"	0.15	-	20	-	14,00€	51262R	1/4"	0.05	-	20	-	14,00€	51338R	3/8"	0.05	-	20	-	14,00€



51830

94,00€

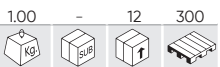

TOURNEVIS DYNAMOMÉTRIQUE MÉCANIQUE

- Precision: CW: +/- 4%
- Rang de operation: 2-10 N-m
- Unites selection: N-m, in-lb.
- Long (mm): 242
- Embouts: 1/4"
- Vie utile: 2000 cycles

- Certificat d'étalonnage d'usine inclus.

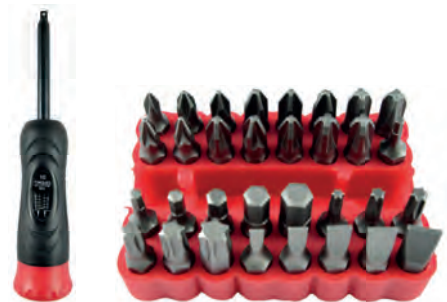

TOURNE-À-GAUCHE EN T 1/2" 250MM

REF.	DESCRIPTION					€
53468	1/2" 250mm	0.35	6	48	600	8,50€
53478	1/4" 115mm	0.50	5	100	1200	4,55€
53479	3/8" 200mm	0.15	5	50	300	6,40€
53480	3/4" 460mm	1.35	5	10	440	19,90€
53481	1" 550mm	2.85	-	5	300	27,40€



BARRE ARTICULÉ

REF.	DESCRIPTION					€
52524	3/4" 1020mm	3.60	3	6	144	51,00€
52526	1/2" 600mm	1.65	5	10	600	28,40€
52525	1/2" 430mm	0.85	10	20	1500	13,80€



RECHANGE

REF.	"					€
11945	1/2"	0.15	25	100	-	7,00€

POUR 52526

REF.	"					€
11946	1/2"	0.06	25	300	-	4,50€

POUR 52525

REF.	"					€
11947	3/4"	0.51	10	40	960	19,00€

POUR 52524



54343

31,00€

1.15	-	6	594
------	---	---	-----

CLÉ À ROCHET EXTENSIBLE DE 1/2" (12,7 MM)
D'UNE LONGUEUR DE 450 À 600 MM



51479

31,80€

0.65	12	24	1056
------	----	----	------

RALLONGE TÉLESCOPIQUE DE 1/2" À TÊTE SPHERIQUE



PRÉSENTOIR DE 12 UNITÉS

51805

17,00€

0.33	4	20	640
------	---	----	-----

JEU DE RALONGES DE 1/4"
À TÊTE SPHERIQUE



51447

16,00€

0.34	5	20	960
------	---	----	-----

JEU DE RALLONGES DE 1/4"
À TÊTE NORMAL



51448

52,00€

2.38	-	5	300
------	---	---	-----

JEU DE RALLONGES DE 1/2"
À TÊTE SPHERIQUE



PIÈCES DE RECHANGE DISPONIBLES

REF.	mm				€
12995	50	0.03	5	100	7,00€
12996	75	0.04	20	100	7,00€
12997	100	0.06	20	100	7,50€
12998	152	0.08	5	100	9,00€
12999	227	0.11	5	100	9,50€

PIÈCES DE RECHANGE DISPONIBLES

REF.	mm				€
14026	50	0.03	10	100	5,50€
14027	75	0.04	-	50	5,60€
10264	100	0.05	10	100	2,00€
14029	152	0.07	-	50	8,50€
14030	227	0.11	-	50	9,50€

PIÈCES DE RECHANGE DISPONIBLES

REF.	mm				€
14978	50	0.10	5	100	7,50€
14979	125	0.20	5	50	9,00€
14980	250	0.40	5	25	13,00€
14981	380	0.60	5	20	22,50€
14982	510	0.60	5	10	27,50€

54302

11,50€

0.45	10	40	650
------	----	----	-----

JEU DE 6 TOURNEVIS DE PRÉCISION

x3 PH00, PH0, PH1
 x3 SL2, SL3, SL4



OUTILS À MAIN

52500

19,00€

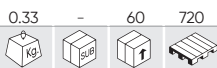

ETUI DE 8 TOURNEVIS DE PRECISION COURTES

8
PCS



CONTIENT

- ⊕ x3 PH00x25, PH0x25, PH1x25
- ⊖ x5 SL0.4x2x25, SL0.4x2.5x25, SL0.5x3x.25, SL0.5x3.5x25, SL0.8x4x25

53917

9,00€

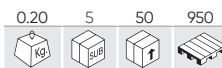

ETUI DE 7 TOURNEVIS DE PRECISION LONGUES

7
PCS



CONTIENT

- ⊕ x3 PH00, PH0, PH1
- ⊖ x4 SL.1.4, SL2.0, SL.2.4, SL3.0

53694

18,40€

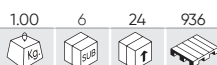

TOURNEVIS À FRAPPER DE 1/2"

8
PCS CrV 1/2"



CONTIENT

- ⊕ x1 1/2"
- ⊖ x1 1/2" - 8mm
- ⊕ x3 PH 2x36mm, 3x36mm, 3x70mm
- ⊖ x3 SL 7x36mm, 8x36mm, 8x70mm

54126

39,00€



ETUI DE TOURNEVIS À FRAPPER MAGNETIQUE

12
PCS GO-THROUGH



CONTIENT

- ⊕ x6 PH0x75mm, PH1x75mm, PH2x38mm, PH2x100mm, PH3x125mm, PH4x200mm
- ⊖ x6 SL3.2x75mm, SL5x75mm, SL6x38mm, SL6x100mm, SL8x150mm, SL9.5x200mm

53010

18,00€

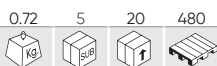

ETUI DE TOURNEVIS AVEC MANCHE INTERCHANGEABLE

11
PCS



CONTIENT

- ⊕ x2 PH1, PH2
- ⊖ x2 4x6, 5x7mm
- ⊕ x3 T10x15, T20x25, T30x40
- ⊕ x3 H4x4mm, H5x5mm, H6x6mm
- x1

50902

13,00€



JEU DE 4 TOURNEVIS À FRAPPER PLATS

4
PCS 3", 4", 6", 8"



JEU DE TOURNEVIS AVEC EVA CARBONE MODULE

53943

21,50€

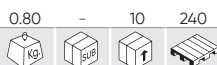

⊕ PH4x200, PH3x150, PH2x100, PH2x38, PH1x80, PH0x120, PH1x100

53944

19,50€

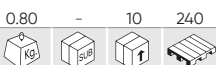

⊖ SL9x200, SL4x125, SL5x100, SL5x80, SL6x38, SL6x100, SL8x150mm

53945

18,90€

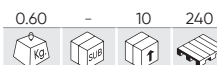

⊕ T8x75, T9x75, T10x75, T15x75, T20x75, T25x100, T27x100

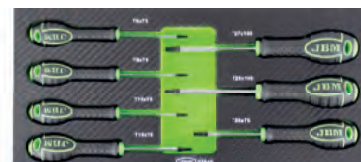
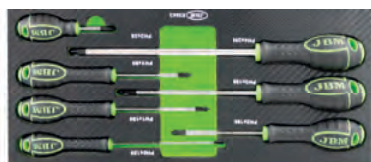

54060 6,00€

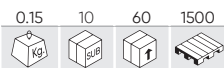

TOURNEVIS RÉVERSIBLE PLAT-CRUCIFORME 6X150MM

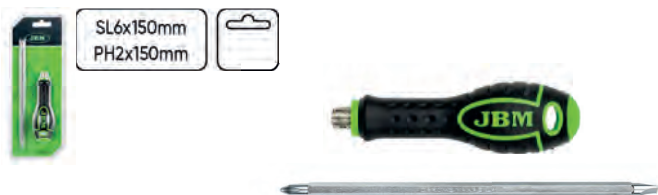

54061 6,00€

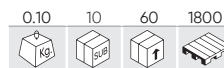

TOURNEVIS RÉVERSIBLE PLAT-CRUCIFORME 6X100MM



54071 26,50€

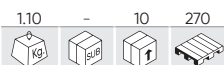

JEU DE 6 TOURNEVIS À TRAVERS (3 CRUCIFORME + 3 PLATS)



CONTIENT

- ⊕ x3 PH3x150, PH2x100, PH1x75mm
- ⊖ x3 SL8x150, SL6.5x100, SL5.5x75mm

54070 18,00€

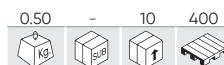

JEU DE 6 TOURNEVIS (2 CRUCIFORME + 4 PLATS)



CONTIENT

- ⊕ x2 PH1x80, PH2x100mm
- ⊖ x4 SL6.5x150, SL5.5x125, SL4x100, SL3x80mm

52170 16,00€

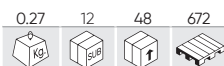

TOURNEVIS FLEXIBLES AVEC EMBOUTS

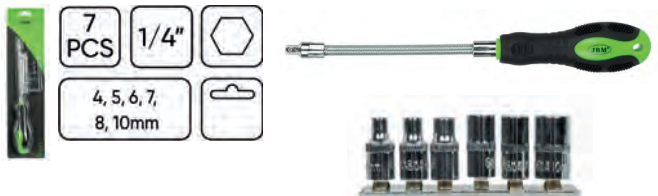

52169 25,00€



JEU DE 3 TOURNEVIS FLEXIBLES PORTE EMBOUTS



53575 16,00€



TOURNEVIS FLEXIBLES AVEC EMBOUTS



500mm



- x3 1/4" 4 mm
- 5 mm
- 7 mm

OUTILS À MAIN

53225

3,50€

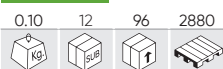

MAGNÉTISEUR / DÉMAGNÉTISEUR



51812

46,00€



JEU DE 5 PINCES



CONTIENT

A	x1	160mm
B	x1	160mm
C	x1	180mm
D	x1	200mm
E	x1	250mm

PINCE CIRCLIPS EMBOUTS DROIT



POUR INTERIEUR

REF.	DESCRIPTION					€
51018	7" 180mm	0.14	5	100	1800	7,05€
52964	9" 225mm	0.23	6	60	1440	9,45€
53549	13" 330mm	0.45	5	30	-	14,30€



POUR EXTERIEUR

REF.	DESCRIPTION					€
51017	7" 180mm	0.17	5	100	1800	6,80€
52966	9" 225mm	0.28	6	60	1800	9,45€
53547	13" 330mm	0.50	5	30	-	14,70€



PINCE CIRCLIPS EMBOUTS COUDÉS



POUR INTERIEUR

REF.	DESCRIPTION					€
51021	7" 180mm	0.16	5	100	-	7,05€
52965	9" 225mm	0.24	6	60	1440	9,20€
53550	13" 330mm	0.45	5	30	-	14,70€



POUR EXTERIEUR

REF.	DESCRIPTION					€
51020	7" 180mm	0.13	5	100	1600	6,65€
52967	9" 225mm	0.24	6	60	1440	9,40€
53548	13" 330mm	0.50	5	30	-	15,60€



PINCE COUPANTE DIAGONALE

REF.	DESCRIPTION					€
53905	6" 160mm	0.20	6	60	1440	7,30€
53906	7" 180mm	0.20	6	60	1560	8,65€



PINCE A BEC DROIT

REF.	DESCRIPTION					€
53908	6" 160mm	0.15	6	60	1440	7,25€
53909	8" 200mm	0.20	6	60	1440	9,70€



PINCE UNIVERSELLE

REF.	DESCRIPTION						€
53911	6" 160mm	0.20	6	60	1440		8,80€
53967	8" 200mm	0.30	6	60	1440		10,20€
54015	7" 180mm	0.20	6	60	1920		10,20€



15454

35,40€

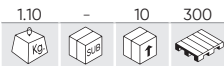

8"

MODULE PINCE SEEGER EVA 8"

REF.	DESCRIPTION						€
10526	PINCE À CIRCLIPS POUR INTERIEUR - EMBOUT DROIT 8"	0.21	5	50	-		10,00€
10642	PINCE À CIRCLIPS POUR EXTERIEUR - EMBOUT DROITE 8"	0.22	5	50	-		10,00€
10643	PINCE À CIRCLIPS POUR INTERIEUR - EMBOUT COURBE 8"	0.21	5	50	-		10,00€
10644	PINCE À CIRCLIPS POUR EXTERIEUR - EMBOUT COURBE 8"	0.22	5	50	-		10,00€



53389

31,50€

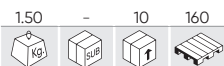

SET DE PINCES SEEGER AVEC POINTE INTERCHANGEABLE



PINCE MULTIPRISE

REF.								€
52052	515mm	140mm	1.88	5	10	400		53,00€
50567	250mm	40mm	0.34	10	60	1500		9,60€



52846

37,80€

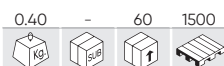

PINCES EXTRA LONGUES SYSTÈME CISEAUX-DROIT

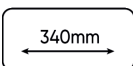

52847

41,00€



PINCES EXTRA LONGUES SYSTÈME CISEAUX-COURBÉ 45°

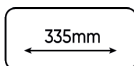

52272

24,60€



JEU DE 3 PINCES LONGUES 0°, 45°, 90°



OUTILS À MAIN

53390

34,50€

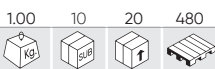

PINCE UNIVERSELLE POUR COLLIER AUTOSERRANT



REF.	DESCRIPTION					€
14180	JEU DE PIÈCES DE RECHANGE POUR 53390	0,01	-	100	-	7,90€

51995

24,50€



PINCE UNIVERSELLE POUR COLLIER AUTOSERRANT



REF.	DESCRIPTION					€
14179	JEU DE PIÈCES DE RECHANGE POUR 51995	0,01	-	100	-	8,50€

53396

18,30€



PINCE POUR COLLIER DE SERRAGE DE TUYAUX D'ÉCHAPPEMENT

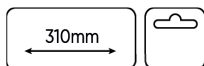

52791

18,00€



PINCE POUR COLLIERS CLIC-R

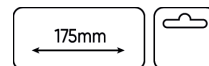

54376

12,00€



OUTIL DE BANDAGE DE JOINT DE CARDAN AVEC COUPEUR

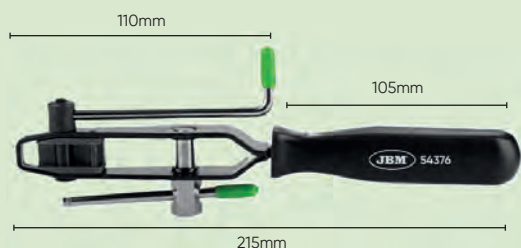

54311

13,00€



PINCE POUR COLLIER A SERTIR



54330

12,50€



PINCES POUR JOINTS DE TIGE DE VALVES

280 mm

OPEL, VW, FORD



54279

6,00€



PINCES POUR EXTRACTION D'AMPOULES

100°



54479

36,50€

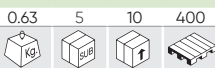

N

PINCE POUR BANDES MÉTALLIQUES AUTOBLOQUANTES



52412

5,00€

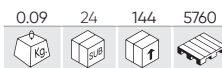

PINCE MULTIFUNCTION 105MM

CONTIENT

- x2 Tournevis plat
- x1 Pointe cruciforme
- x1 Ouvre-bouteille
- x1 Ouvre-boîte
- x1 Lime 25mm
- x1 Scie 40mm
- x1 Outil de coupe 40mm



52050

98,00€



COFFRET DE PINCES SPÉCIALE A COLLIERS

PIÈCES DE RECHANGE DISPONIBLES

REF.	DESCRIPTION	Kg	Unité	Boîte	Palettes	€
A 13707	PINCE POUR COLLIER DE SERRAGE AVEC POINTE ROTATIVE	0.25	10	40	-	14,00€
B 13708	PINCE POUR COLLIER DE SERRAGE ÉLASTIQUE	0.24	6	48	-	14,00€
C 13709	PINCE POUR COLLIER DE SERRAGE AVEC POINTE DROITE	0.24	6	48	576	14,00€
D 13710	PINCE POUR COLLIER DE SERRAGE ÉLASTIQUE 45°	0.70	6	48	1536	14,00€
E 13712	PINCE POUR EXTRACTION DE TUBES	0.21	10	40	-	14,00€
F 51995	PINCE UNIVERSELLE POUR COLLIER AUTOSERRANT	0.53	5	40	480	24,50€
G 52791	PINCE POUR COLLIERS CLIC-R	0.25	5	50	1500	18,00€



52619

23,10€

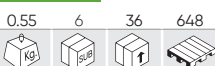

PINCE POUR COLLIER A SERTIR



Trou de 1/2" afin de pouvoir utiliser comme clé.
Ouverture: 0-20mm



52812

65,00€



PINCE POUR COLLIER A SERTIR



Avec prise femelle pour le serrage à cliquet.
Ouverture: 34mm



53487

16,70€



PINCE PLATE POUR LA CONDUITE DE CARBURANT



52508

38,40€



PINCE POUR ANNEAU



ONGLET ANTIBLOCCAGE

52509

36,20€



OUTILS À MAIN

52625

9,00€



PINCE POUR RESSORT DE FREIN



51355

19,00€



PINCE SPÉCIALE MASSE D'ÉQUILIBRAGE



52982

53,00€

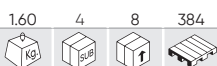

JEU DE 3 PINCES ETAUX EXTRA LONGUES



53445

17,10€



JEU DE PINCES POUR DÉCONNEXION DE TUYAU D'ESSENCE



- x1 5/16" Ø 8mm
- x1 3/8" Ø 10mm
- x1 APPLICATION SPÉCIALE



51972

12,00€



PINCE A DÉNUDER AUTO-AJUSTABLE



0.25~2.5mm²

08-6mm



52152

13,50€



CISEAUX CÂBLE

ACERO INOXIDABLE
STAINLESS STEEL

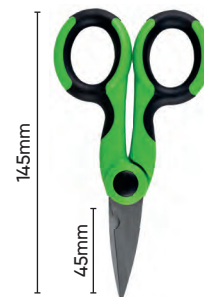

53411

5,00€

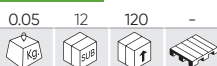

PINCES PLIABLES MINI



53412

4,00€



PINCES PLIABLES MINI



PINCES MINIS PLIABLES

REF.	DESCRIPTION					€
53602	360mm - Ø 125mm ²	0.60	-	5	300	30,50€
53603	550mm - Ø 250mm ²	1.75	-	5	300	45,00€
53604	800mm - Ø 500mm ²	3.70	-	5	120	118,00€



COUPE BOULONS

REF.	DESCRIPTION					€
52955	12" - 300mm	0.77	-	20	200	19,80€
52956	14" - 350mm	0.95	-	20	200	19,60€
52957	18" - 450mm	1.47	-	10	360	23,80€
52958	24" - 600mm	2.40	-	8	210	28,20€
52959	30" - 750mm	3.78	-	5	100	42,00€
52960	36" - 900mm	5.15	-	5	105	46,00€



53385 19,30€

0.15	6	54	1026
------	---	----	------



PINCE POUR EXTRACTION D'AGRAFES DE CARROSSERIE



53976 9,00€

0.20	6	60	1440
------	---	----	------



PINCE A BEC SPÉCIAL TERMINAUX 6" - 160MM



52761 8,00€

0.25	12	72	1800
------	----	----	------



PINCE À SERTIR POUR COSSES ISOLÉES ET NON ISOLÉES 9"



53932 8,00€

0.25	12	72	1296
------	----	----	------



PINCE À SERTIR POUR COSSES ISOLÉES ET NON ISOLÉES 9"



52762 9,00€

0.25	12	72	1800
------	----	----	------



PINCE À SERTIR POUR COSSES NON ISOLÉES 8-3/4"

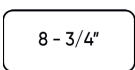

16111 19,20€

0.61	-	10	200
------	---	----	-----



MODULE DÉNUDEUSE + BORNES EVA POUR SERVANTE D'OUTILS



OUTILS À MAIN

54254

43,00€



PINCE À BORNES AVEC EMBOUT INTERCHANGEABLE

7 PCS

COMPREND

- 9° PLIERS
- 0.15-6MM° BIT
- 10-35MM° BIT
- 0.5-6MM° BIT

- 0.5-10MM° BIT
- 0.5-4MM° BIT
- TOURNEVIS PH2X150



54112

18,00€

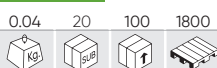

EXTRACTEUR DE TERMINAL AVEC SIX CONNECTEURS

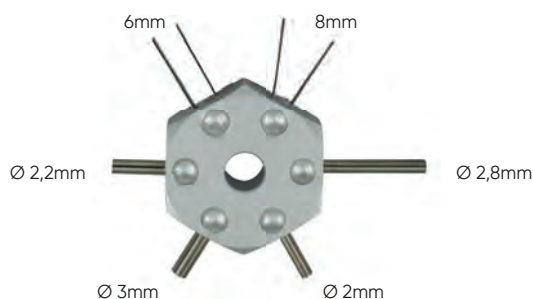

54142

15,20€



ENSEMBLE DE CROCHETS, PIOCHES ET LEVIER NON-MARQUÉS (6 PIÈCES)

6 PCS

COMPREND

- 2 embouts crochets
- 2 embouts droits
- 2 embouts coudés
- 6 embouts avec leviers



AIMANT FLEXIBLE

REF.	DESCRIPTION	Ø	—					€
51525	AIMANT FLEXIBLE AVEC POINTE MAGNÉTIQUE	A	7mm	500mm	0.14	10	60 960	9,80€
51526	DOIGT FLEXIBLE À 4 GRIFFES	B	20mm	500mm	0.10	12	144 2016	9,80€
52473	AIMANT FLEXIBLE AVEC LED	C	15mm	545mm	0.18	10	60 960	9,90€

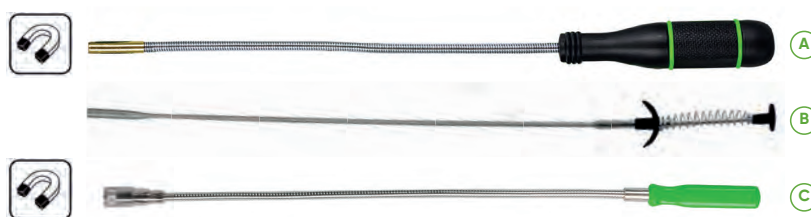

OUTILS D'INSPECTION

REF.	DESCRIPTION	Ø	—					€
51272	AIMANT TÉLESCOPIQUE AVEC POINTE LED	A	18mm	90-810mm	0.05	12	72 1512	7,50€
52472	AIMANT TÉLESCOPIQUE AVEC POINTE MAGNÉTIQUE	B	10mm	135-600mm	0.15	12	108 4320	4,90€
52468	MIROIR D'INSPECTION TÉLESCOPIQUE ARTICULÉ	C	50mm	280-445mm	0.09	12	48 1536	5,90€



15706

31,00€



JEU D'OUTILS DE RAMASSAGE MAGNÉTIQUE – 5 PIÈCES



15799

28,30€



MARTEAUX ASSORTIS – MODULE EVA CARBONE



MARTEAU AVEC MANCHE EN PLASTIQUE

REF.	DESCRIPTION					€
52182	2Kg - 297mm	2.20	6	12	504	24,00€
52184	4Kg - 880mm	4.31	-	4	128	43,00€
52185	6Kg - 895mm	6.97	-	4	72	55,00€
52186	8Kg - 900mm	8.68	-	2	72	72,00€



MARTEAU EN NYLON ANTI-REBOND

REF.	DESCRIPTION					€
52425	Ø 40mm	0.70	6	12	768	33,30€
52426	Ø 60mm	1.50	2	12	288	52,00€
52427	Ø 70mm	2.02	2	12	204	64,00€



EMBOUNTS EN NYLON DE RECHANGE

REF.	mm					€	REF.	mm					€	REF.	mm					€
11212	Ø 40	0.02	5	100	-	5,00€	11213	Ø 60	0.08	5	50	-	10,60€	11214	Ø 70	0.11	5	50	-	12,50€



MARTEAU DE MÉCANICIEN

REF.	DESCRIPTION					€
51674	505g	0.60	6	36	864	7,75€
52565	1000g	1.13	6	24	720	11,50€



MARTEAU À BOULE

REF.	DESCRIPTION					€
51504	454g	0.55	4	40	800	8,50€
51918	1000g	1.25	6	18	648	12,50€



MARTEAU ANTI-REBOND

REF.	DESCRIPTION					€
52180	1,35Kg - 355mm	1.45	6	12	432	19,00€
52181	1,80Kg - 370mm	1.81	6	12	300	22,50€
52183	2,20Kg - 405mm	2.30	6	12	288	26,20€



HACHE ET HACHETTE AVEC MANCHE EN BOIS

REF.	DESCRIPTION					€
52188	360mm	0.82	4	24	875	15,50€
52460	410mm	1.17	4	24	864	16,60€
52461	700mm	2.00	4	12	240	25,70€



OUTILS À MAIN

52830

24,00€

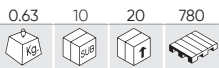

SCIE EN ARC AVEC POIGNÉE ERGONOMIQUE

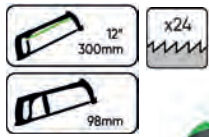

PRÉSENTOIR
DE 10 UNITÉS

52831

18,00€

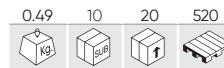

SCIE EN ARC

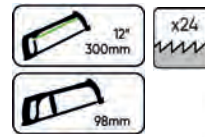

PRÉSENTOIR
DE 10 UNITÉS

REF. DESCRIPTION

12060 LAMES POUR SCIE À MÉTAUX REF.52830 + 52831 + 51675

0.02 100 800 - 2,50€

53591

5,50€

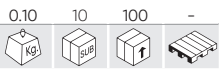

DÉNUDEUR DE FILS

- Plage de coupe: 8 à 28 mm.
- Longueur du produit: 170 mm.
- Longueur de la lame: 20 mm.
- Profondeur du crochet: 5 mm.



52786

14,60€

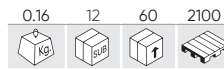

COUPEAU AVEC SYSTÈME COUPE-CEINTURE ET POINTE CASSE VITRE



PRÉSENTOIR
DE 12 UNITÉS

COUPE-TUBE

REF.	DESCRIPTION	kg	L	cm	mm	€
52878	3-32mm	0.22	10	50	1500	11,20€
52879	3-35mm	0.24	10	50	1500	10,10€
52877	Ø MAX: 42mm	0.43	6	48	624	15,80€
53517	Ø MAX: 30mm	0.13	10	60	600	9,50€



52885

18,00€



LOT DE 12 POINÇONS CREUX - METRIQUE



3, 4, 5, 6, 7, 8, 9, 10,
12, 14, 16, 19mm



54331

27,00€



N

SET DE 3 COUTEAUX PROFESSIONNELS



	LAME	TAILLE DE LA LAME	LONGUEUR	POIDS
A	x4	60x19mm	175mm	115,5g
B	x1	100x10mm	160mm	129,7g
C	x4	60x19mm	175mm	115,5g



PIÈCES DE RECHANGE DISPONIBLES

REF.	DESCRIPTION				€
16342	SET DE 10 LAMES DE COUPE POUR RÉF.54331	0.01	10	100	2,50€
16343	SET DE 10 LAMES DE COUPE TRAPÉZOÏDALE POUR RÉF.54331	0.01	10	100	2,50€

51909

2,46€

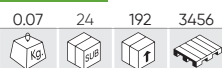

CUTTER PROFESSIONNEL



PRÉSENTOIR DE 24 UNITÉS



PIÈCES DE RECHANGE DISPONIBLES

REF.	DESCRIPTION				€
16642	SET DE 10 LAMES DE COUPE POUR RÉF.51909	0.01	10	100	1,00€

BURINS

REF.	DESCRIPTION					€
53120	150mm	0.35	6	24	1200	6,00€
53121	250mm	0.55	6	24	864	7,35€
53122	350mm	0.90	6	12	720	9,50€



ACERO 45C

53083

64,00€

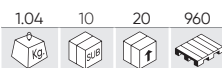

JEU DE 4 BURINS

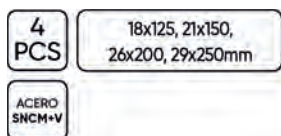

54089

17,50€



SET DE 5 BURINS

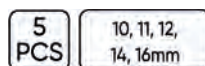

PIÈCES DE RECHANGE DISPONIBLES

REF.	mm				€
15783	155x10	0.09	6	24	3,50€
15784	155x11	0.09	6	24	3,50€
15785	155x12	0.09	6	24	3,50€
15786	155x14	0.09	6	24	3,50€
15787	155x16	0.09	6	24	3,50€



OUTILS À MAIN

53095

20,50€

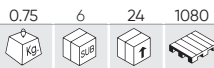

JEU DE 6 CHASSES GOUPILLES



54099

13,80€

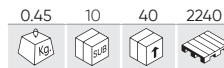

JEU DE 5 CHASSES GOUPILLES

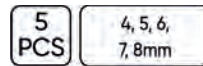

15737

45,00€

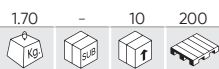

MODULE POUR CISEAUX ET PERFORATEURS

9 PCS



52049

14,00€

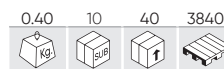

JEU DE 5 POINTEAUX



13667

17,60€

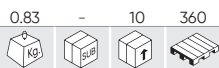

MODULE EVA DE RIVETUSE + RIVETS POUR SERVANTE D'OUTILS



53993

77,00€



RIVETUSE ARTICULÉE MULTI-FONCTIONNELLE

- Tête rotative à 360°
- Compact, permet de travailler facilement dans de petits espaces
- Conçu pour une utilisation à une main

COMPREND

- Embouts de rivets standards 2,4 mm (3/32") - 3,2 mm (1/8") - 4,0 mm (5/32") - 4,8 mm (3/16")
- Poinçons pour écrous à riveter M3x0,5 - M4x0,7 - M5x0,8 - M6x1
- Poinçons pour rivets M6x1 - M5x0,8 - M4x0,7
- 3 clés 5,5x8,5 mm - 12x17 mm - 15x19 mm
- Porte-broche M6x1 - M5x0,8 - M4x0,7 - M3x0,5



52596

114,00€



RIVETEUSE POUR EMBOUTS FILETÉS 400MM / 16"

400mm 16"

M3, M4, M5, M6, M8, M10, M12



52597

146,00€



RIVETEUSE EMBOUTS FILETÉS AUTOMATIQUE 440MM / 17"

440mm 17"

M3, M4, M5, M6, M8, M10, M12



PIÈCES DE RECHANGE POUR 52595, 52596, 52597

REF.	DESCRIPTION				€
13226	M3	0.03	-	100	4,50€
13227	M4	0.04	20	100	4,50€
13228	M5	0.04	20	100	4,50€
13229	M6	0.04	20	100	4,50€

REF.	DESCRIPTION				€
13230	M8	0.04	20	100	4,50€
13231	M10	0.05	-	100	4,50€
13232	M12	0.05	-	100	4,50€



52463

26,10€



RIVETEUSE 300MM / 12"

300mm 12"

3,2mm (1/8), 4,0mm (5/32), 4,8mm (3/16)



52464

42,00€



RIVETEUSE 400MM/16"

400mm 16"

2,4mm (3/32), 3,2mm (1/8), 4,0mm (5/32), 4,8mm (3/16), 6,4mm (1/4)



53331

31,80€

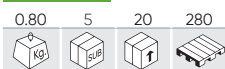

RIVETEUSE 10" 250MM

250mm 10"

2,4mm (3/32), 3,2mm (1/8), 4,0mm (5/32), 4,8mm (3/16), 6,4mm (1/4)



53332

34,50€



RIVETEUSE EXTENSIBLE 8" 200MM

200mm 8"

2,4mm (3/32), 3,2mm (1/8), 4,0mm (5/32), 4,8mm (3/16), 6,4mm (1/4)



OUTILS À MAIN

52595

64,00€

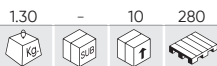

RIVETEUSE POUR EMBOUTS FILETÉS COMPACTE 200MM / 8"

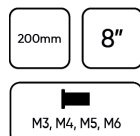

52462

25,30€

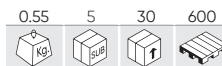

RIVETEUSE COMPACTE 200MM / 8"



52609

29,00€

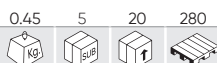

RIVETEUSE + RIVETS EN PLASTIQUE

Ø 6,6mm x 17,2mm (10u.)
Ø 6,3mm x 25,2mm (10u.)
Ø 5mm x 17,2mm (10u.)
Ø 5mm x 15,8mm (10u.)



PIÈCES DE RECHANGE DISPONIBLES

REF.	Ø					€
13674	6x19,3mm	0.04	25	2500	0,50€	
13675	6x17,8mm	0.01	25	500	0,50€	
13676	6x25,5mm	0.01	100	1000	0,50€	
13677	6x24,5mm	0.03	25	1000	0,50€	
13678	6x24mm	0.01	25	1000	0,50€	

52575

119,00€



RIVETEUSE PNEUMATIQUE



- Traction: 1586LBS / 720 KGS.
- Longueur tige: 9/16" - 14mm.
- Max. serrer 60FT IB / 23-69NM.
- Entree d'air: 1/4".
- Consommation moyenne d'air: 0.03CFM/0.86L/MIN.

COMPRED

- 2 Multioutils
- Crochet rapide
- Joints torique
- Recipient arriere



NIVEAU

D'ALUMINIUM

REF.	DESCRIPTION					€
53613	500mm	0.55	5	30	1260	19,50€
53614	600mm	0.60	5	30	840	21,50€
53615	800mm	0.85	5	20	600	34,60€



D'ALUMINIUM MAGNETISÉ

REF.	DESCRIPTION					€
53616	500mm	0.30	5	60	1260	10,40€
53617	600mm	0.30	5	60	840	9,25€
53618	800mm	0.35	5	30	600	13,90€

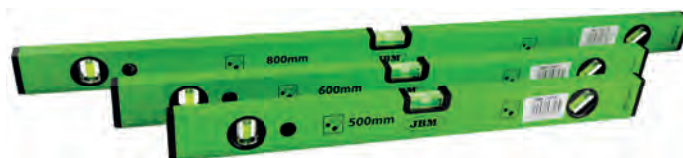

EXPOSANT POUR LES NIVEAUX

REF.					€
14183	0.80	-	10	-	31,00€



MÈTRES AUTOBLOQUANTS

REF.	DESCRIPTION					€
53025	3m x 16mm	0.13	12	48	2016	3,50€
53026	5m x 25mm	0.26	12	48	2016	5,80€
53027	7,5m x 25mm	0.40	12	48	1500	9,00€



PRÉSENTOIR DE 12 UNITÉS

52433 4,80€

0.10	10	50	1820

JEU DE JAUGES D'ÉPAISSEUR-20 (0.05-1.0 MM)

0,05-1mm



52638 9,95€

0.35	5	50	1800

PINCE EMPORTE PIÈCES REVOLVER

Ø 2, 2.5, 3, 3.5, 4, 4.5mm



52318 73,00€

0.64	6	24	336

NIVEAU DE CARROSSAGE MAGNÉTIQUE

-6° / +6°



52904 61,00€

2.00	-	5	175

COMPARATEUR AVEC SUPPORT MAGNETIQUE



REF.	DESCRIPTION					€
13704	COMPARATEUR POUR REF.52904	0.10	-	50	1500	21,00€

PIED À COULISSE

REF.				€
50724	0.30	5	50	28,00€
50937	0.24	10	50	10,50€



50724
DIGITAL

50937
MÉCANIQUE

JAUGE DE PROFONDEUR

REF.				€
52873	0.04	5	300	11,00€
53042	0.05	10	100	9,90€



52873
MÉCANIQUE

53042
DIGITAL

CLÉ SERRAGE ANGULAIRE

REF.				€
52583	0.20	4	48	8,50€
52794	0.48	6	24	28,00€



52583

52794
MAGNÉTIQUE

OUTILS À MAIN

51951

15,60€

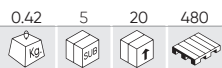

SET DE 3 SPATULES EN ACIER



53339

9,50€

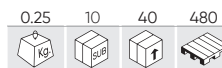

COFFRET DE 4 SPATULES ACIER



53589

12,00€

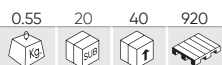

AGRAFEUSE INDUSTRIELLE



HAUTEUR DES AGRAFES : 4-14 mm



52700

20,50€

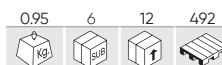

COFFRET EVASEMENT TUYAU FREIN

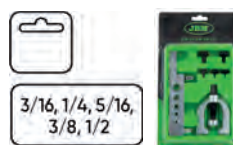

REF.	DESCRIPTION					€
14167	1000 PCS AGRAFES POUR RÉF. 53589 (11,3 X 0,7 X 8 MM)	0.10	50	100	-	2,50€

51853

18,00€



JEU DE 5 LIMES EN ACIER



52760

4,10€



BROSSES MÉTALLIQUES



52515

9,10€



BROSSES MÉTALLIQUES



52905

28,00€



PINCE À CINTRER POUR TUBES 6-8-10MM



DEGRÉS MARQUÉS

TIUBES EN ALUMINIUM, CUIVRE ET ACIER

MEUBLES D'ATELIER

- 72 CHARIOTS À OUTILS
- 83 SETS À OUTILS
- 90 ACCESSOIRES POUR CHARIOT
- 93 TABLES DE TRAVAIL
- 95 STOCKAGE
- 99 TABOURETS / CHARIOT DE MECANICIEN
- 100 ÉTAUX/ENCLUMES



54327

2.788,00€

259,60 - - 1



N

ENSEMBLE DE MEUBLES MODULAIRES POUR GARAGE (18 PCS)

MOBILE 6 TOOL TROLLEY WITH 6 DRAWERS
WITH A RUBBER MAT

DIMENSIONS GÉNÉRALES

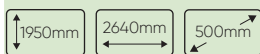

ATTELAGE CARRÉ

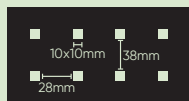

MESURES SPÉCIFIQUES

	A	B	C	D	E	F	G
HAUTEUR	1890mm	340mm	340mm	38mm	900-950mm	750-880mm	900-950mm
LARGE	600mm	680mm	680mm	2040mm	680mm	666mm	680mm
PROFONDEUR	500mm	280mm	25mm	500mm	500mm	460mm	500mm

DIMENSIONS INTERIEUR

	A1	B1	E1	E2	E3	F1	F2	G1
HAUTEUR	1890mm	340mm	58mm	136mm	216mm	58mm	137mm	715mm
LARGE	600mm	680mm	567mm	567mm	567mm	567mm	567mm	596mm
PROFONDEUR	500mm	280mm	408mm	408mm	408mm	408mm	408mm	475mm

LES PANNEAUX À OUTILS SONT COMPATIBLES AVEC NOS CROCHETS: REF.16354, 16355, 16356, 16357



LIVRE SANS OUTIL

PIÈCES DE RECHANGE ET ACCESSOIRES

REF.	DESCRIPTION					€
16490	ARMOIRE HAUTE (RÉF. 54327)	56.20	-	1	-	650,00€
16491	ARMOIRE D'ANGLE 800X800X338MM (REF.54327)	22.00	-	1	-	307,00€
16492	ARMOIRE D'ANGLE AVEC PANNEAU MDF (RÉF. 54327)	59.40	-	1	-	675,00€
16493	MEUBLE À 3 TIROIRS AVEC PORTE-ROULEAU DE PAPIER (RÉF. 54327)	41.20	-	1	-	436,00€
16494	ARMOIRE MURALE (RÉF. 54327)	10.40	-	1	-	139,00€
16496	PANNEAU MDF 1360X500X38MM (REF. 16627/16628/16500)	19.40	-	1	-	127,00€
16497	PANNEAU MDF 680X500X38MM (REF. 16627/16628/16500)	9.80	-	1	-	77,00€
16498	JEU DE PANNEAU PERFORÉ 3 PCS. 680X338X25MM (REF.54327)	6.00	-	1	-	84,00€
16499	JEU DE PANNEAU PERFORÉ 6 PCS. 775X338X25MM (REF. 54327)	13.00	-	1	-	162,00€
16500	ARMOIRE 2 PORTES (REF.54327)	33.60	-	1	-	463,00€
16516	JEU DE PANNEAU PERFORÉ 4 PCS. POUR ARMOIRE D'ANGLE (REF. 16492)	9.20	-	1	-	121,00€
16561	BARRE DE SUPPORT (REF.54327)	7.80	-	4	-	36,50€
16627	ARMOIRE À 4 TIROIRS (RÉF.54327)	43.50	-	1	-	225,00€
16628	ARMOIRE À 6 TIROIRS (REF.54327)	49.00	-	1	-	382,00€
16629	TABLE DE TRAVAIL MDF 2040X500X38MM (REF.54327)	27.80	-	1	-	419,00€
16600	PANNEAU D'ACIER INOXYDABLE 2 040 X 500 MM (REF.54327)	33.00	-	1	-	252,00€



SERVANTE D'OUTILS 12 TIROIRS

53939 1.280,00€

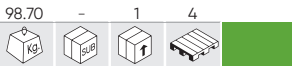

COMPLETE

172 PCS

DIMENSIONS INTERIEUR 1A COLONNE

A PETITS TIROIRS (X4)



B MOYENS TIROIRS (X1)



C GRAND TIROIR (X1)



DIMENSIONS GÉNÉRALES



53868 1.090,00€

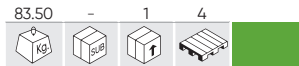

VIDE

172 PCS

DIMENSIONS INTERIEUR 2A COLONNE

D PETITS TIROIRS (X4)



E MOYENS TIROIRS (X1)



F GRAND TIROIR (X1)



ATTELAGE CARRÉ

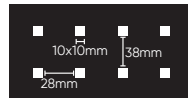

AVEC MODULES EVA:

53708

325,00€

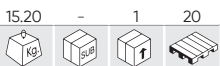

JEU DE 4 MODULES EVA CARBONE POUR OUTILS

CONTIENT

REF.	Box	Box	Pallet	€
14296	6.05	4	80	118,00€
14297	3.30	4	96	87,00€
14298	2.10	4	96	51,50€
14299	3.25	4	96	87,00€

14296



PIÈCES DE RECHANGE



14297



PIÈCES DE RECHANGE

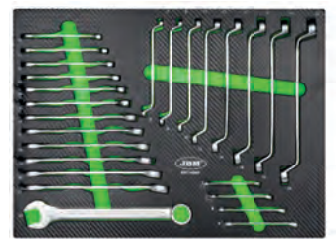

14298



PIÈCES DE RECHANGE



14299



PIÈCES DE RECHANGE



POUR PLUS D'INFORMATION

PAGE 83

SERVANTE MOBILE 7 TIROIRS - XL

53912 1.280,00€

74.50 - - 4

COMPLETE

199 PCS XL

53869 990,00€

74.50 - 1 4

VIDE

199 PCS XL

53913 1.280,00€

74.50 - - 4

COMPLETE

199 PCS XL

53870 990,00€

74.50 - 1 4

VIDE

199 PCS XL



DIMENSIONS INTERIEUR

PETITS TIROIRS (X5)

74mm 705mm 400mm 25Kg

GRANDS TIROIRS (X2)

151,5mm 705mm 400mm 35Kg

ATTELAGE CARRÉ

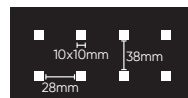

DIMENSIONS GÉNÉRALES

984mm 980mm 510mm



AVEC MODULES EVA:

CONTIENT

REF.				€
14296	6.05	4	80	118,00€
14297	3.30	4	96	87,00€

REF.				€
14298	2.10	4	96	51,50€
14299	3.25	4	96	87,00€

REF.				€
15122	1.70	10	200	74,00€
15155	2.45	10	180	59,00€

REF.				€
15161	2.10	10	180	62,00€
15514	0.05	10	360	9,35€

14296

PIÈCES DE RECHANGE

15122

PIÈCES DE RECHANGE

14297

PIÈCES DE RECHANGE

15161

PIÈCES DE RECHANGE

14298

PIÈCES DE RECHANGE

15155

PIÈCES DE RECHANGE

14299

PIÈCES DE RECHANGE

15514

SERVANTE D'OUTILS 7 TIROIRS - VERD

172 PCS 300Kg

N

54389 790,00€

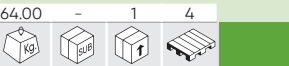

COMPLETE

54503 490,00€

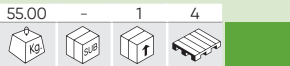

VIDE

DIMENSIONS INTERIEUR

PETITS TIROIRS (X5)



GRANDS TIROIRS (X2)



CAPACITÉ DE CHARGE DU TIROIR: 35KG.
CAPACITÉ DE CHARGE TOTALE: 300KG.

DIMENSIONS GÉNÉRALES

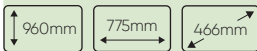

ATTELAGE CARRÉ

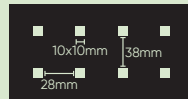

AVEC MODULES EVA:

53708

325,00€

15.20 - 1 20



JEU DE 4 MODULES EVA CARBONE POUR OUTILS

CONTIENT

REF.	Kg	Box	Units	€
14296	6.05	4	80	118,00€
14297	3.30	4	96	87,00€
14298	2.10	4	96	51,50€
14299	3.25	4	96	87,00€

14296



PIÈCES DE RECHANGE



14297



PIÈCES DE RECHANGE

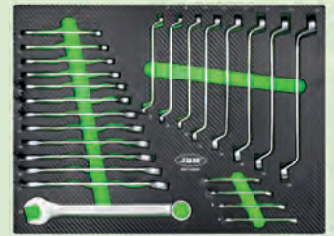

14298



PIÈCES DE RECHANGE



14299



PIÈCES DE RECHANGE



POUR PLUS D'INFORMATION

PAGE 83

SERVANTE D'OUTILS 7 TIROIRS

53661 790,00€

65.50 - 1 4

COMPLETE

53761 490,00€

52.50 - 1 4

VIDE

53767 790,00€

56.00 - 1 4

COMPLETE

53768 490,00€

56.00 - 1 4

VIDE

53686 790,00€

65.00 - 1 4

COMPLETE

53762 490,00€

55.50 - 1 4

VIDE

53904 790,00€

65.00 - 1 4

COMPLETE

54006 490,00€

55.00 - 1 4

VIDE

DIMENSIONS INTERIEUR

PETITS TIROIRS (X5)



GRANDS TIROIRS (X2)



CAPACITÉ DE CHARGE DU TIROIR: 30KG.
CAPACITÉ DE CHARGE TOTALE: 70KG.

DIMENSIONS GÉNÉRALES



ATTELAGE CARRÉ

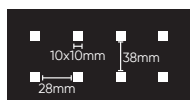

172 PCS 280Kg



AVEC MODULES EVA:

53708 325,00€

15.20 - 1 20

JEU DE 4 MODULES EVA CARBONE POUR OUTILS

CONTIENT

REF.	Kg	1	20	€
14296	6.05	4	80	118,00€
14297	3.30	4	96	87,00€
14298	2.10	4	96	51,50€
14299	3.25	4	96	87,00€

14296

PIÈCES DE RECHANGE

14297

PIÈCES DE RECHANGE

14298

PIÈCES DE RECHANGE

14299

PIÈCES DE RECHANGE

POUR PLUS D'INFORMATION

PAGE 83

SERVANTE À OUTILS 7 TIROIRS SPÉCIAL CAMIONS

54240 1.887,00€



COMPLETE

54237 1.887,00€



COMPLETE

54238 1.887,00€



COMPLETE

54239 1.887,00€



COMPLETE

DIMENSIONS INTERIEUR

PETITS TIROIRS (X5)



GRANDS TIROIRS (X2)



CAPACITÉ DE CHARGE DU TIROIR: 30KG.
CAPACITÉ DE CHARGE TOTALE: 70KG.

DIMENSIONS GÉNÉRALES



ATTELAGE CARRÉ

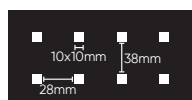

AVEC MODULES EVA:



54134

1.415,00€



JEU D'OUTILS POUR LA RÉPARATION DES VÉHICULES

CONTIENT

REF.	Box	Box	Pallet	€
15730	10.22	2	48	289,00€
15731	5.20	2	48	214,00€

REF.	Box	Box	Pallet	€
15732	6.40	2	48	293,50€
15733	3.55	2	48	113,00€

REF.	Box	Box	Pallet	€
15734	9.40	2	48	288,50€
15735	10.00	2	48	152,00€

REF.	Box	Box	Pallet	€
15736	14.80	2	40	488,50€

15730



PIÈCES DE RECHANGE



15731



PIÈCES DE RECHANGE



15732



PIÈCES DE RECHANGE



15733



PIÈCES DE RECHANGE



15734



PIÈCES DE RECHANGE



15735



PIÈCES DE RECHANGE



15736



PIÈCES DE RECHANGE



POUR PLUS D'INFORMATION

PAGE 84



SERVANTE D'OUTILS 7 TIROIRS SPÉCIAL VDE

54236 1.856,00€

67.70 - 1 4

COMPLETE

54233 1.856,00€

67.70 - 1 4

COMPLETE

54234 1.856,00€

67.70 - 1 4

COMPLETE

54235 1.856,00€

67.70 - 1 4

COMPLETE

DIMENSIONS INTERIEUR

PETITS TIROIRS (X5)



GRANDS TIROIRS (X2)



CAPACITÉ DE CHARGE DU TIROIR: 30KG.
CAPACITÉ DE CHARGE TOTALE: 70KG.

DIMENSIONS GÉNÉRALES



ATELAGE CARRÉ

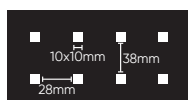

Servante spécialement configurée afin de couvrir toutes les nécessités basiques du maintien et réparation de véhicules hybrides et électriques, ainsi que pour les travaux de hautes tensions.

24 PCS

CLASS CLASS 0

ENROLLABLE ROLLS

DVE

GS

1000V IEC 60900 C



CONTIENT

REF.	DESCRIPTION	UNI.					€
52162	TERMOMÈTRE LASER -50°C A 550°C	1	0.17	6	72	576	38,00€
53940	POTEAU DE PLASTIQUE POUR CHAINES - JAUNE / NOIR	4	0.55	-	6	90	13,20€
54326	CHAÎNE PVC - 7M - JAUNE/NOIR	4	0.30	-	20	720	7,30€
53942	MAILLE DE CHAÎNE EN PLASTIQUE NOIR	8	0.01	50	5000	75000	0,50€
54093	MODULE D'OUTILS VDE AVEC ISOLATION EVA (ÉTHYLENE VINYLE ACÉTATE) -26 PIÈCES	1	3.25	-	4	80	441,00€
54114	MESUREUR DE RÉSISTANCE D'ISOLATION	1	1.48	-	10	100	248,00€
54129	TAPIS ISOLANT CLASSE 0	1	0.03	10	50	-	110,00€
54130	GANTS ISOLANTS POUR TRAVAUX SOUS TENSION T9	1	0.35	-	1	100	58,00€
54132	ÉCRAN FACIAL ISOLANT POUR LES TRAVAUX ÉLECTRIQUES	1	0.70	-	1	72	190,00€
54241	PERCHE DE SAUVETAGE ISOLÉE - 45KV	1	1.10	-	1	50	120,00€

POUR PLUS D'INFORMATION
PAGE 345

SERVANTE D'OUTILS 7 TIROIRS AVEC JEU D'OUTILS POUR RÉGLER LA SYNCHRONISATION

53951 1.794,00€

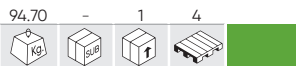

COMPLETE

53952 1.794,00€

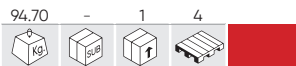

COMPLETE

54501 1.794,00€

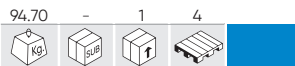

COMPLETE

54502 1.794,00€

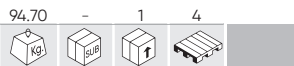

COMPLETE

DIMENSIONS INTERIEUR

PETITS TIROIRS (X5)

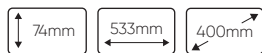

GRANDS TIROIRS (X2)



CAPACITÉ DE CHARGE DU TIROIR: 30KG.
CAPACITÉ DE CHARGE TOTALE: 70KG.

DIMENSIONS GÉNÉRALES



ATTELAGE CARRÉ

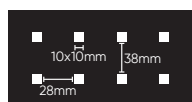

AVEC MODULES EVA:

53775

1.109,00€

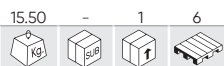

JEU DE 6 OUTILS POUR SYNCHRONISATION DU MOTEUR

CONTIENT

REF.	Kg	1	36	€
53769	5.90	3	36	178,00€
53770	6.15	3	36	198,00€

REF.	Kg	3	36	€
53771	4.05	3	36	158,00€
53772	6.40	3	36	229,00€

REF.	Kg	3	36	€
53773	6.60	3	36	298,00€
53774	6.95	3	36	190,00€

POUR PLUS D'INFORMATION

PAGE 297



53769



RENAULT / NISSAN / OPEL / VOLVO

53770



FORD / SEAT / VOLKSWAGEN / MAZDA / VOLVO

53771



FIAT / FORD / CITROËN / PEUGEOT

53772



FORD / VAG / MAZDA / VOLVO

53773



FIAT / ALFA / LANCIA / OPEL / SUZUKI / FORD

53774



OPEL / CHEVROLET / SAAB / FIAT / LANCIA / SUZUKI / FORD

54295

500,00€

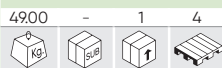

N

SERVANTE D'OUTILS 7 TIROIRS ÉGAUX - VERD - VIDE

DIMENSIONS GÉNÉRALES

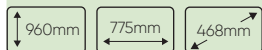

ATTELAGE CARRÉ

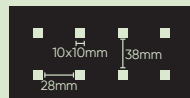

DIMENSIONS INTERIEUR



54296

520,00€



N

SERVANTE D'OUTILS 8 TIROIRS ÉGAUX - VERD - VIDE

DIMENSIONS GÉNÉRALES



ATTELAGE CARRÉ

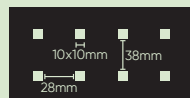

DIMENSIONS INTERIEUR



54297

540,00€

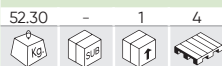

N

SERVANTE D'OUTILS 9 TIROIRS ÉGAUX - VERD - VIDE

DIMENSIONS GÉNÉRALES

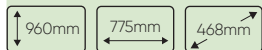

ATTELAGE CARRÉ

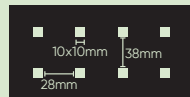

DIMENSIONS INTERIEUR



53672

440,00€

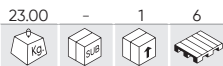

97 PCS

SERVANTE MODULAIRE



3 MODULES INDÉPENDANTS ÉQUIPÉS DE:



	1/2"	x11	8,10,11,12,13,14,16,17,19,21,22mm
	1/4"	x13	4,4.5,5,5.5,6,7,8,9,10,11,12,13,14mm
	1/2"	x1	
	1/4"	x1	
	1/2"	x2	125,300mm
	1/4"	x2	50,100mm
		x1	180mm
		x1	160mm
		x2	160mm, 180mm
		x2	PH2x125, PH1x100mm
		x2	6x150mm, 5x100mm
		x9	8,9,10,11,12,13,14,17,19mm
		x1	250mm
		x1	300g
		x1	250mm
		x1	200mm
		x8	1,5x8mm
		x1	3mm
	1/4"	x32	
	1/4"	x1	
	1/4"	x1	
	1/4"	x1	
	1/2"	x1	
	1/4"	x1	

A BOÎTE À OUTILS EN MODULES EVA + PLATEAU SUPÉRIEUR AMOVIBLE



B 2 TIROIRS AVEC OUTILS EN MODULES EVA



C COMPARTIMENT À OUVERTURE FRONTALE



53867

1.095,00€

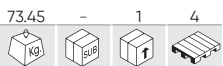

SERVANTE À OUTILS 9 TIROIRS AVEC SÉPARATEURS - VERT

DIMENSIONS GÉNÉRALES

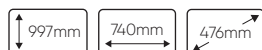

DIMENSIONS INTERIEUR



REF.	mm	UNI.			€
15073	174x53mm	21	0.05	200	1,00€
15076	396x53mm	18	0.30	50	3,50€

TU POURRAIS AUSSI AIMER...

REF.	mm			€
15070	67x53mm	0.05	200	0,50€
15071	103x53mm	0.05	200	0,60€
15072	138x53mm	0.05	200	0,70€
15074	210x53mm	0.10	200	1,00€
15075	280x53mm	0.10	200	1,20€

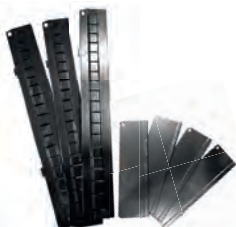

AVEC SÉPARATEURS ORGANISATION LIBRE

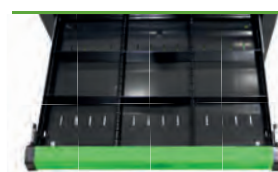

ATTELAGE CARRÉ

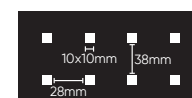



MODULES EVA FINITION EN FIBRE DE CARBON

53708

325,00€



JEU DE 4 MODULES EVA CARBONE POUR OUTILS

CONTIENT

14296

118,00€



	1/2"	x17	x10, 11, 12, 13, 14, 15, 16, 17, 18, 19, 20, 21, 22, 24, 27, 30, 32mm
	1/4"	x13	4, 4.5, 5, 5.5, 6, 7, 8, 9, 10, 11, 12, 13, 14mm
	1/2"	x5	14, 15, 17, 19, 22mm
	1/4"	x8	6, 7, 8, 9, 10, 11, 12, 13mm
	1/2"	x8	E10, E11, E12, E14, E16, E18, E20, E24
	1/4"	x5	E4, E5, E6, E7, E8
	72	x2	1/2" - 1/4"
	1/2"	x2	125, 250mm
	1/4"	x2	50, 100mm
		x2	
	1/2"	x1	
	1/2"	x2	16, 21mm

		x2	PH1, PH2
		x2	PZ1, PZ2
	1/4"	x4	3, 4, 5, 6mm
		x3	SL4, SL5.5, SL6.5
		x8	T8, T10, T15, T20, T25, T27, T30
		x2	PH3, PH4
		x2	PZ3, PZ4
	8mm	x5	7, 8, 10, 12, 14mm
		x3	SL8, SL10, SL12
		x5	T40, T45, T50, T55, T60
		x1	1/4"
		x1	1/4"
	1/2"	x1	8mm
		x3	1.5, 2, 2.5mm

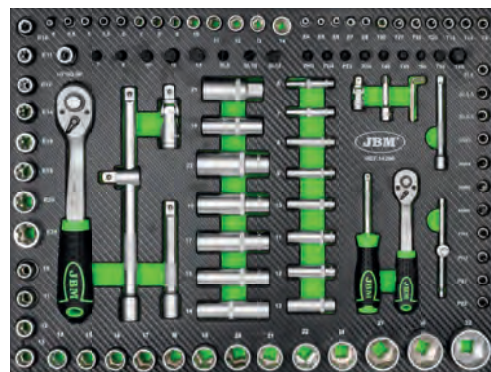

14297

87,00€

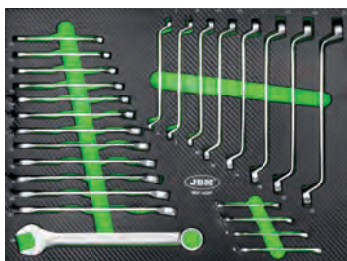

	6x7, 8x9, 10x11, 12x13, 14x15, 16x17, 18x19, 20x22mm
	6, 7, 8, 10, 11, 12, 13, 14, 15, 17, 19, 22mm

14298

51,50€

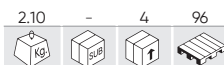

	PH0x75, PH1x100, PH2x100, PH3x150, PH4x200
	6, 7, 8, 10, 11, 12, 13, 14, 15, 17, 19, 22mm
	2x38mm
	6x38mm
	1.5, 2, 2.5, 3, 4, 5, 6, 8, 10mm
	10, 15, 20, 25, 27, 30, 40, 45, 50mm

14299

87,00€



	35mm		8"
	450g		10"
	10"		7.5"
	8"		3m
	8"		

54134

1.415,00€

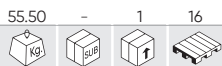

JEU D'OUTILS POUR LA RÉPARATION DES VÉHICULES

CONTIENT

15730

289,00€

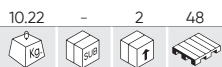

	55mm	H5, H6, H7, H8, H10, H12
	65mm	H14
	70mm	H16, H17, H18, H18, H20
	30mm	H4, H5, H6, H7, H8, H10, H12 M5, M6, M8, M10, M12 T20, T25, T30, T40, T45, T50, T55
	75mm	H4, H5, H6, H7, H8, H10, H12 M5, M6, M8, M10, M12 T20, T25, T30, T40, T45, T50, T55
	1/2"	x9 E10, E11, E12, E14, E16, E18, E20, E22, E24
	1/2"	x10 10, 11, 12, 13, 14, 15, 16, 17, 18, 19mm

	1/2"	x3 50, 125, 250mm
	1/2"	x1 430mm
	1/2"	x1 10mm
	3/4"	x5 21, 24, 27, 34, 36mm
	3/4"	x4 24, 30, 32, 36 mm
		1/2x10, 3/8x10mm
		1/2x10, 3/8x10mm
	3/8"	10mm
	1/4"	300, 380, 450mm
	1/4"	
	1/2"	12



15731

214,00€



	6x7, 8x9, 10x11, 12x13, 14x15, 16x17, 18x19, 20x22, 21x23, 24x27, 25x28, 30x32mm
	6, 7, 8, 10, 11, 12, 13, 14, 15, 17, 19, 22, 24mm

15732

293,50€



	10, 13, 17mm
	10x11, 12x13, 14x17mm
	E10xE12, E14xE18, E20xE24
	8x10, 11x13, 14x15, 16x17, 18x19mm
	27, 30, 32, 36mm
	10, 13, 17, 19mm

15733

113,00€



	PH0x75mmL, PH1x75mmL, PH2x100mmL, PH2x38mmL, PH3x150mmL, PH4x200mmL
	SL3.5x75mmL, SL5x75mmL, SL6x100mmL, SL6x38mmL, SL8x150mmL, SL9.5x200mmL
	10x11, 12x13, 14x15mm
	10x11, 12x13, 14x15, 16x17, 18x19mm

15734

288,50€



	1kg
	24, 27, 30, 32, 36, 41mm
	3/4" 500mm
	3/4" 500mm
	1.5, 2, 2.5, 3, 4, 5, 6, 8, 10mm

15735

152,00€



	220mm		250mm
	330mm		6" - 160mm
	330mm		7" - 180mm
	330mm		0°/45°/90°
	330mm		300mm

15736

488,50€



	1/2"	78mm	13, 14, 15, 16, 17, 18, 19, 21, 22, 24mm
	3/4"	78mm	22, 24, 27, 30, 32, 33, 36, 38, 46mm
	1/2"	90mm	51, 60mm
	1/2"		T40, T45, T50, T60, T70
	1/2"	78mm	H6, H8, H14, H17
	3/4"	100mm	T80, T90, T100
	1/2"	40mm	M18
	1/2"(M)x3/4"(H)	3/4"(M)x1/2"(H)	
	1/2" - 3/4"		125mm

15681

134,00€

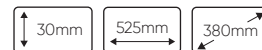
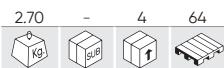

	H3, H4, H5, H6, H7, H8		7, 8, 10, 12, 14mm
	M8, M10, M12		PH3, PH4
	PH0, PH1, PH2, PH3		PZ3, PZ4
	PZ0, PZ1, PZ2, PZ3		8mm
	1/2" SL4, SL5.5, SL6.5, SL7		SL8, SL10, SL12
	T8, T9, T10, T15, T20, T25, T27, T30, T40		T40, T45, T50, T55, T60, T70
	T8, T9, T10, T15, T20, T25, T27, T30, T40		T40, T45, T50, T55, T60, T70
	TS10, TS15, TS20, TS25, TS27, TS30, TS40, TS45, TS50		H7 (230mmL), H10, H11, H13 (140mmL), H14, H17, H19, H22, H24 (55mmL)
	1/2" 8mm		M9 (100mmL), M10, M12, M14 (140mmL), M16 (53mmL), M16 (100mmL)
	3/8" 8mm		1/2" R7, R8 (240mmL), R9 (100mmL), R10 (140mmL)
	1/4" 6mm		T30 (300mmL), T40, T45, T50, T55, T60, T70 (140mmL), T80 (100mmL)
	1/2" M18		HT5 (160mmL)

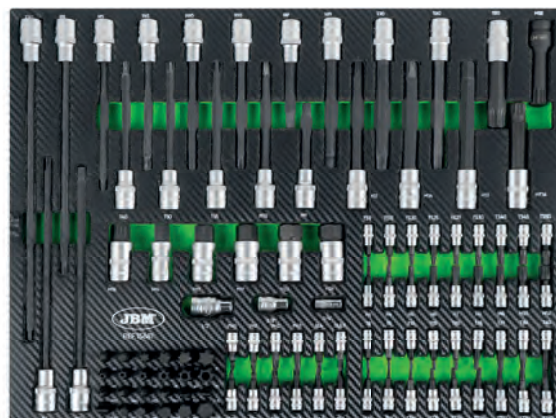

15122 74,00€

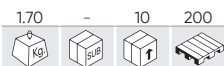

x12 8, 9, 10, 11, 12, 13, 14, 15, 16, 17, 18, 19mm

15155 59,00€

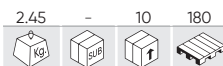

x11 8, 10, 11, 12, 13, 14, 15, 16, 17, 18, 19mm

15156 70,00€

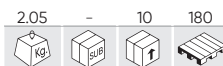

x4 21x23, 24x27, 25x28, 30x32mm

15157 42,00€



x7 6x8, 10x12, 13x14, 15x17, 19x21, 22x24mm

15158 59,00€

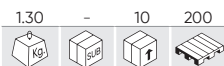

x7 8, 10, 11, 13, 14, 17, 19mm

15159 44,00€

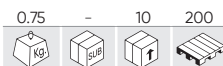

x5 8x10, 11x13, 14x15, 17x19, 20x22mm

15160 42,00€

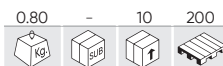

x6 8x9, 10x11, 12x13, 14x15, 16x17, 18x19mm

15161 62,00€

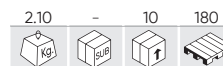

x4 27, 29, 30, 32mm

15316 58,00€

0.85 - 10 260

210mm
120mm
50mm

x3 8, 9, 10, 11, 12, 13, 14, 15, 16, 17, 18, 19mm

53943 21,50€

0.80 - 10 240

210mm
120mm
50mm

x7 PH4x200, PH3x150, PH2x100, PH2x38 PH1x80, PH0x120, PH1x100

53944 19,50€

0.80 - 10 240

210mm
120mm
50mm

x7 SL9x200, SL4x125, SL5x100, SL5x80, SL6x38, SL6x100, SL8x150mm

53945 18,90€

0.60 - 10 240

210mm
120mm
50mm

x7 T8x75, T9x75, T10x75, T15x75, T20x75, T25x100, T27x100

15454 35,40€

1.10 - 10 300

210mm
120mm
50mm

x1 8" x1 8"
x1 8" x1 8"

15541 27,60€

0.95 - 10 220

210mm
120mm
50mm

x1 7" - 180mm
x1 8" - 200mm
x1 8" - 200mm

15706 31,00€

0.55 - 10 240

210mm
120mm
50mm

x1 180 - 770mm x1 280 - 870mm
x1 130 - 640mm x1 170-580mm
x1 495mm

15737 45,00€

1.70 - 10 200

210mm
120mm
50mm

x1 6x180mm
x2 8x180, 10x180mm
x3 6x180, 8x180, 10x180mm
x3 2x160, 16x175, 19x180mm

15315 28,20€

1.05 - 10 260

210mm
120mm
50mm

x1 8" x1 8"
x1 8" x1 8"
x1 8"

15514 9,35€

0.05 - 10 360

210mm
120mm
50mm

VIDE

54158 38,00€

1.70 - 10 200

210mm
120mm
50mm

3/8" x1 10mm
1/2" x1 10mm
30mm x7 4, 5, 6, 7, 8, 10, 12mm
75mm x7 4, 5, 6, 7, 8, 10, 12mm
30mm x8 T20, T25, T30, T40, T45, T50, T55, T60
75mm x8 T20, T25, T30, T40, T45, T50, T55, T60
30mm x5 M5, M6, M8, M10, M12
15mm x5 M5, M6, M8, M10, M12

15162 30,20€

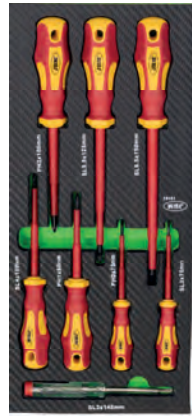
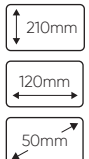
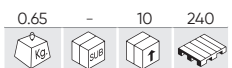

- ⊖ x4 SL3x75, SL4x100, SL5.5x125, SL6.5x150mm
- ⊕ x3 PH0x75, PH1x80, PH2x100mm
- ⌵ x1 140mm

54093

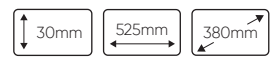
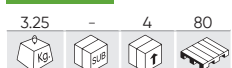

- 3/8" x10 45mm 8, 10, 11, 12, 13, 14, 16, 17, 18, 19, 21, 22mm
- ⊖ x2 4x100, 5,5x125mmL
- ⊕ x2 PH1x80, PH2x100mm
- x1 185mm
- x1 52mm
- x1 185mm
- x6 7x86, 8x99, 10x109, 12x127, 14x141, 17x156mm
- 1/2" x1 125mm
- 3/8" x1 200mm
- 3/8" x1 200mm

15799 28,30€

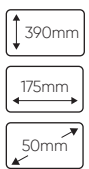
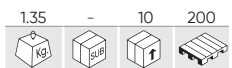

- x1 450g
- x1 35mm

16111 19,20€

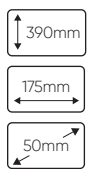
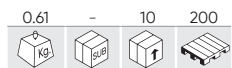

- x1 220mm
- ⊖ BV1.25 ⊕ BV2
- ⊖ RV2-4 ⊕ RV2-4L
- ⊖ SV2-4 ⊕ SV5.5-6
- ⊖ MDD2-250 ⊕ FDD2-250

51805 17,00€



- x5 50, 75, 100, 152, 227mm

51447 16,00€

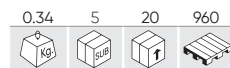

- x5 50, 75, 100, 152, 227mm

51448 52,00€

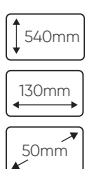

- x5 50, 125, 250, 380, 510mm

52912 91,00€

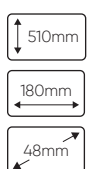

- x6 E6xE7 (200mmL), E8xE10 (235mmL), E11xE12 (290mmL), E14xE16 (370mmL), E18xE20 (410mmL), E22xE24 (420mmL)

54066 83,00€



- x7 8mm (23,5mmL), 10mm (29,3mmL), 12mm (32,8mmL), 13mm (34,9mmL), 14mm (36,7mmL), 17mm (41mmL), 19mm (42mmL)

51864 64,00€

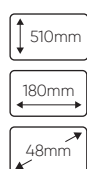
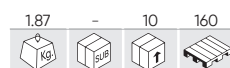

- x6 10x11mm (290mmL), 12x14mm (330mmL), 13x15mm (368mmL), 16x18mm (407mmL), 17x19mm (407mmL), 22x24mm (430mmL)

54032 84,00€

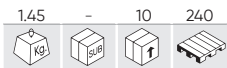

400mm
180mm
50mm



x12 8mm (89mmL), 9mm (94mmL), 10mm (95mmL), 11mm (99mmL), 12mm (102mmL), 13mm (107mmL), 14mm (114mmL), 15mm (117mmL), 16mm (123mmL), 17mm (125mmL), 18mm (130mmL), 19mm (135mmL)

15083 8,50€

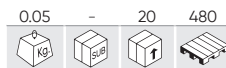

380mm
175mm
50mm



VIDE

15084 68,00€

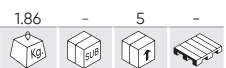

380mm
175mm
50mm

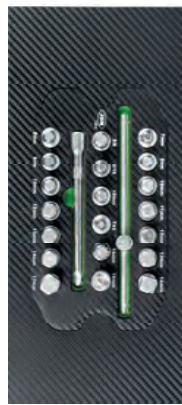

x2 5/16", 3/8"
x7 7, 8, 10, 11, 12, 13, 14mm
x1 10mm
x1 10mm
x7 8, 9, 10, 12, 13, 14, 17mm
x1 T45
x1 M16
x1 200mm x1 150mm

53979 34,60€

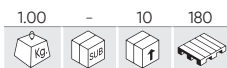

390mm
340mm
50mm



x8 T10x75, T15x75, T20x100, T25x100, T30x150, T40x150, T45x200, T50x200mm

53980 34,60€

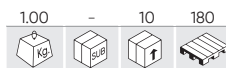

390mm
340mm
50mm



x8 H2x100, H2.5x100, H3x100, H4x150, H5x150, H6x200, H8x200, H10x200

MODULES EVA

11996 48,00€

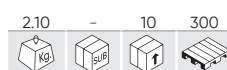

390mm
175mm
50mm



x10 6x7, 8x9, 10x11, 12x13, 14x15, 16x17, 18x19, 20x22, 24x27, 30x32mm

11997 39,00€

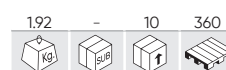

390mm
175mm
50mm



x8 6x7, 8x9, 10x11, 12x13, 14x15, 16x17, 18x19, 20x22mm

11998 49,00€



390mm
175mm
50mm



x17 6, 7, 8, 9, 10, 11, 12, 13, 14, 15, 16, 17, 18, 19, 20, 21, 22mm

13668 18,70€

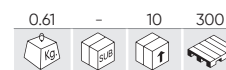

390mm
175mm
50mm



x1 3m
x1 230mm
x1 50mm
x1 250mm

11994 33,00€

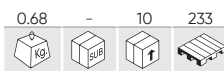

390mm
175mm
50mm



- x1 1/4" x1 250mm
- x1 1/4" x1 125mm
- x1 1/4"
- x13 4, 4.5, 5, 5.5, 6, 7, 8, 9, 10, 11, 12, 13, 14mm

14114 19,30€

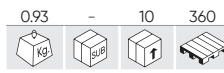

390mm
175mm
50mm



- x1 10"
- x1 10"

13667 17,60€

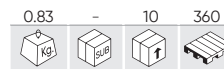

390mm
175mm
50mm



- x1 253mm
- 2x6, 3x7, 3x9, 6x10mm

13923 7,45€

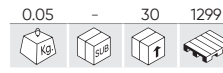

390mm
175mm
50mm



VIDE

53671 41,00€

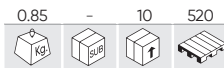

210mm
120mm
50mm



- x3 1/4" - 85 mm
- 1/2" - 135 mm
- 3/8" - 102 mm

53620 88,00€

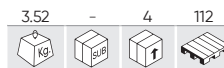

30mm 525mm 380mm



- x17 6, 7, 8, 9, 10, 11, 12, 13, 14, 15, 16, 17, 18, 19, 20, 21, 22mm
- x8 6x7, 8x9, 10x11, 12x13, 14x15, 16x17, 18x19, 20x22mm

MODULES EN PLASTIQUE

10732 18,70€

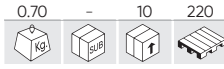

390mm
175mm
50mm



- x1 3m
- x1 230mm
- x1 50mm
- x1 250mm

10735 20,30€

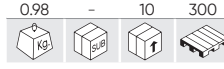

390mm
175mm
50mm



- x1 8"
- x1 8"
- x1 8"
- x1 8"
- x1 8"

PANNEAUX PERFORÉ

REF.	mm					€
52419	A 1000x600mm	7.07	-	1	30	80,00€
52420	B 1500x600mm	10.80	-	2	35	108,00€
52421	C 2000x600mm	14.00	-	1	38	172,00€

ATTELAGE CARRÉ

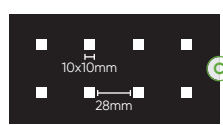
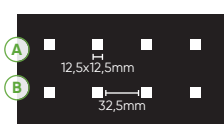
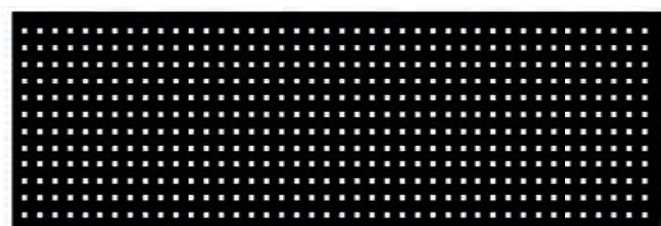

ACCÉSSOIRES POUR SERVANTES

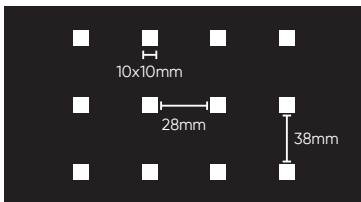

15068 15,20€

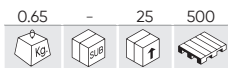

15069 32,80€

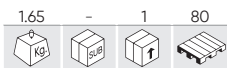

15313 14,00€

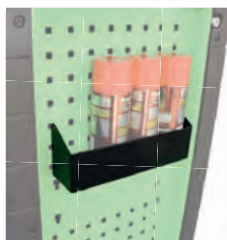
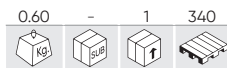

14354 14,00€



16359 10,00€



16361 16,50€



16362 20,00€



16363 14,50€

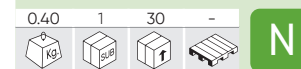

16344 43,00€



16358 12,00€

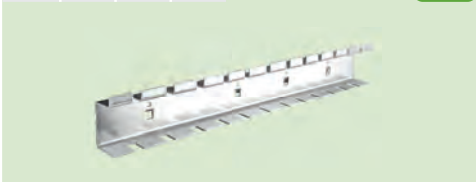

16360 12,00€

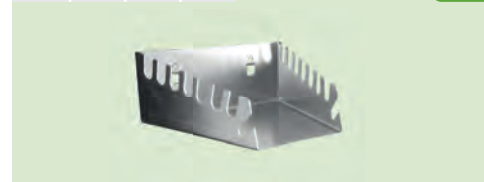

16354 1,50€



16355 2,00€

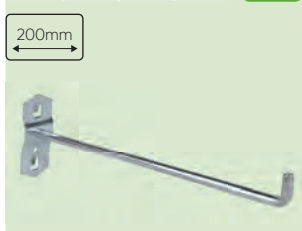

16356 2,50€



16357 2,50€

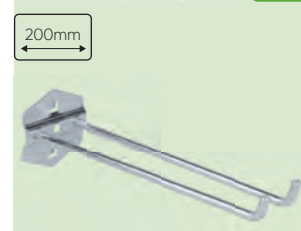

ACCÉSSOIRES POUR SERVANTES

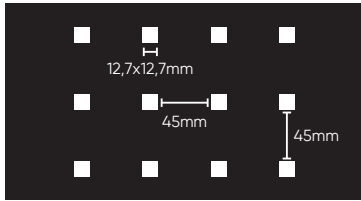

16161 17,50€

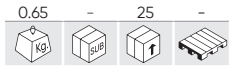

16162 35,10€

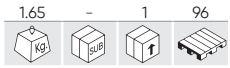

16163 10,20€

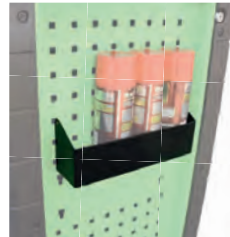
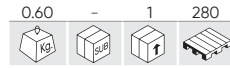

16188 39,60€

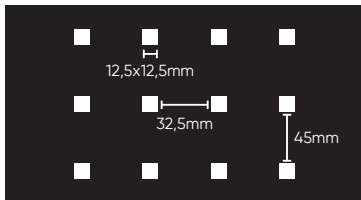

51655 4,10€

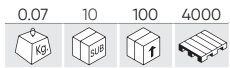

51976 1,63€

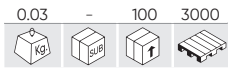

51658 4,50€

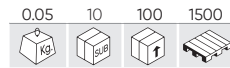

51422 2,97€



52634 5,25€

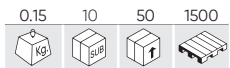

51975 2,27€

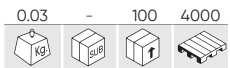

51419 2,79€

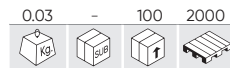

51656 3,65€

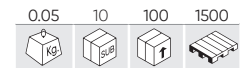

51654 4,80€

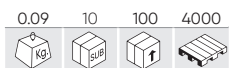

52635 4,80€

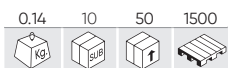

51657 5,85€

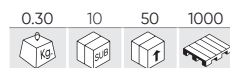

51653 5,10€



PIÈCES DE RECHANGE

REF.	DESCRIPTION					€
14578	JEU DE 2 GRANDS INSERTS DE ROULEMENT À BILLES POUR 53661, 53686, 53904, 54006	1.05	-	25	-	12,50€
14580	COUVERCLE SUPÉRIEUR POUR RÉF. 53661 - 53686 - 53904 - 54006 - 54389	2.60	-	3	39	41,00€
14783	PROTECTEUR DROIT POUR RÉF. 53686, 53661, 53904, 54006, 54389	0.25	-	50	-	5,50€
15023	ROUE FIXE POUR RÉF. 53765, 53766, 53870	0.65	-	10	-	12,50€
15024	ROUE PIVOTANTE POUR RÉF. 53765, 53766, 53870	0.95	-	8	-	15,00€
15025	ROUE FIXE POUR RÉF. 53900, 53901	0.65	-	10	-	12,50€
15026	ROUE PIVOTANTE POUR RÉF. 53900, 53901	0.95	-	8	-	15,00€
15030	POIGNÉE POUR RÉF.53765, 53766	0.30	-	50	-	8,00€
15033	POIGNÉE ÉTROITE POUR RÉF. 53868	0.14	-	50	-	6,00€
15034	COUVERCLE SUPÉRIEUR POUR RÉF. 53868	2.00	-	2	-	57,00€
15035	POIGNÉE POUR RÉF. 53869	0.36	-	20	-	8,50€
15036	POIGNÉE POUR RÉF. 53870	0.36	-	20	-	8,50€
15037	POIGNÉE POUR RÉF. 53900, 53901	0.10	-	-	-	8,00€
15038	COUVERCLE SUPÉRIEUR POUR RÉF. 53869, 53870	2.00	-	2	-	34,50€
15040	ROUE FIXE POUR RÉF. 53904, 54006, 54389	0.66	-	10	-	12,50€
15041	ROUE PIVOTANTE POUR RÉF. 53904, 54006, 54389	0.98	-	8	-	15,00€
15042	POIGNÉE POUR RÉF. 53904, 54006	0.10	-	1	-	7,50€
15050	POIGNÉE POUR RÉF. 53661, 53686	0.10	-	50	-	9,50€
15058	PROTECTION LATÉRALE POUR RÉF. 53868	0.36	-	-	-	7,50€
15065	PROTECTION LATÉRALE POUR RÉF. 53869, 53870	0.28	-	12	-	6,50€
16387	POIGNÉE POUR RÉF. 54389	0.40	-	-	-	10,50€



CADENAS

COURT

REF.	DESCRIPTION					€
53403	38mm	0.15	8	96	3168	6,50€
53405	32mm	0.10	8	96	3168	5,30€
53406	50mm	0.30	8	48	1728	8,55€
53407	63mm	0.35	8	48	3168	12,70€
53408	75mm	0.48	3	24	840	19,30€

LONG

REF.	DESCRIPTION					€
53404	38mm	0.15	8	96	3168	6,50€
53409	50mm	0.30	8	48	3168	9,00€



CADENAS RESISTANT À L'EAU

REF.	DESCRIPTION					€
53399	30mm	0.90	8	48	3168	3,50€
53400	40mm	0.20	8	48	499	5,70€
53401	50mm	0.35	8	48	499	7,40€
53402	65mm	0.05	10	40	499	9,60€



54388

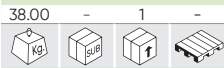

366,00€

N

CHARIOT DE DIAGNOSTIC

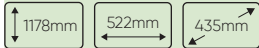

Chariot d'atelier multifonctionnel avec quatre plateaux et un compartiment verrouillé. Il permet de placer des ordinateurs portables, des testeurs et des chargeurs de batterie.

Il est doté de deux poignées et de roues rotatives qui facilitent grandement le transport. Il comprend également un panneau perforé, un porte-rouleau de papier et deux plateaux latéraux pour ranger les outils.

DIMENSIONS DE L'ÉTAGÈRE SUPÉRIEURE	433x398mm
DIMENSIONS DU PANNEAU PERFOR	430x475mm
NOMBRE TOTAL D'ÉTAGÈRES	4
CAPACITÉ DU PLATEAU SUPÉRIEUR	20Kg
DIAMÈTRE DES ROUES	101mm
ROUES AVEC FREINS	2



REF. DESCRIPTION

REF.	DESCRIPTION	Kg	Q	€
16481	ROUE AVEC FREIN POUR REF. 54388	11.60	20	14,00€
16482	ROULETTE POUR REF. 50818	2.80	20	13,50€



51576

125,00€

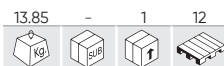

SERVANTE ATELIER 3 PLATEAUX



52373

252,00€



SERVANTE ATELIER 3 PLATEAUX XXL



51738

850,00€

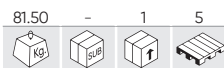

ETABLI 3 TIROIRS

DIMENSIONS GÉNÉRALES



DIMENSIONS TIROIR INTERIEUR



REF. DESCRIPTION

REF.	DESCRIPTION	Kg	Q	€
15144	TAPIS EN CAOUTCHOUC POUR TABLE DE TRAVAIL RÉF. 51738	2.50	100	30,00€



51737

699,00€

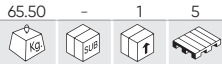

ETABLI 2 TIROIRS



DIMENSIONS GÉNÉRALES



DIMENSIONS TIROIR INTERIEUR



REF. DESCRIPTION

REF.	DESCRIPTION	Kg	m³	1	5	€
15145	JEU DE 2 TAPIS EN CAOUTCHOUC POUR TABLE DE TRAVAIL RÉF. 51737	1.90	-	100	100	20,45€

53674

447,00€

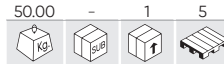

ÉTABLI DE 1 TIROIR



DIMENSIONS GÉNÉRALES



DIMENSIONS TIROIR INTERIEUR



REF. DESCRIPTION

REF.	DESCRIPTION	Kg	m³	1	5	€
15146	TAPIS DE BUREAU EN CAOUTCHOUC, RÉF. 53674	1.35	-	100	100	16,20€

51035

799,00€

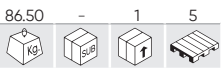

ETABLI AVEC PANNEAU PERFORÉ



DIMENSIONS GÉNÉRALES



DIMENSIONS TIROIR INTERIEUR



ATTELAGE CARRÉ

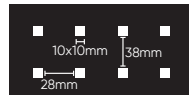

54328

199,00€



ÉTABLI PLIABLE AVEC PANNEAU ARRIÈRE



N

DIMENSIONS GÉNÉRALES



DIMENSIONS PLIÉ



ATTELAGE CARRÉ

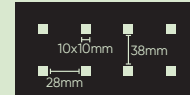

SURFACE DE TRAVAIL



LIVRE SANS OUTIL

50957

22,00€

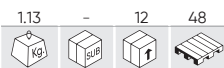

MALLETTE DE RANGEMENT 24+2



- 24 compartiments de 8x5,5 cm.
- 2 compartiments de 15x7,5 cm.
- Rabattable de 26 à 5 séparations.

50959

14,00€

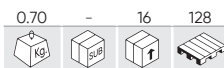

MALLETTE DE RANGEMENT 20+1



- 20 compartiments de 6x7 cm.
- 1 compartiment de 35x7 cm.
- Rabattable de 19 à 4 séparations.

51051

34,80€

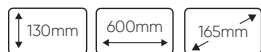
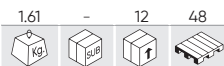

CASIER DE RANGEMENT



TIROIRS
INSÉPARABLES

51050

285,00€

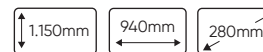
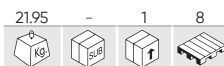

ETAGERES SUR PIEDS AVEC 47 BOITES A BEC

GRANDS COMPARTIMENTS

Total: 15
Dimensions: 24x14,5x13 cm
Dimensions de l'étagère: 84x14x24 cm
Total étagères: 3

COMPARTIMENTS PETITS

Total: 32
Dimensions: 16x10x7,5 cm
Dimensions de l'étagère: 84x16x8 cm
Total étagères: 4



51574

52,00€

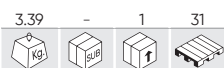

COFFRE À OUTILS 5 COMPARTIMENTS



DIMENSIONS GÉNÉRALES



OUVERT



COFFRE À OUTILS

REF.						€
54393	750x200x220mm - 9Kg	7.70	-	1	15	92,00€
54394	530x200x220mm - 5,2Kg	5.70	-	1	22	64,00€
54395	450x200x220mm - 4,5Kg	6.20	-	1	24	53,00€



N

51575

317,00€

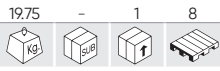

COFFRE À OUTILS 6 TIROIRS

DIMENSIONS GÉNÉRALES



PETITS TIROIRS (X3)

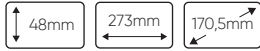

MOYENS TIROIRS (X2)



GRAND TIROIR (X1)



51600

109,00€

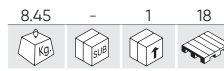

COFFRE À OUTILS 3 TIROIRS FRONTAUX

DIMENSIONS GÉNÉRALES

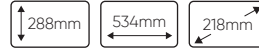

DIMENSIONS TIROIR INTERIEUR



53782

14,00€

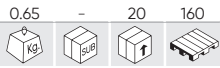

SAC À DOS POUR OUTILS ÉLECTRIQUES – GRAND

25 Kg 13L



53253

98,00€

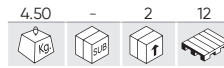

VALISE D'OUTILS

20 Kg 18L



54080

53,50€

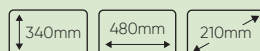

N

SAC À OUTIL

20L



54374

75,50€



N

SAC À DOS D'OUTILS

15 Kg





SAC À DOS POUR OUTILS

REF.	DESCRIPTION					€
53702	SAC À DOS POUR OUTILS ÉLECTRIQUES - PETIT	1.00	-	5	180	28,50€
53703	SAC À DOS POUR OUTILS ÉLECTRIQUES - MOYEN	1.40	-	5	120	41,00€
53704	SAC À DOS POUR OUTILS ÉLECTRIQUES - GRAND	1.65	-	5	120	42,00€

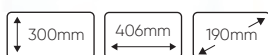

53903

59,00€



JEU DE 3 PLATEAUX D'OUTILS ANTIDÉRAPANTS FLÉXIBLES

3
PCS

REF.	DESCRIPTION					€
15010	285x137x27mm	0.40	-	20	360	16,50€
15011	285x202x27mm	0.45	-	20	320	18,00€
15012	543x300x27mm	1.05	-	10	120	31,50€

BOL MAGNÉTIQUE PLIANT

REF.	Ø SUPERIOR	Ø BASE	MESURES DÉPLOYÉES	MESURES PLIANTES					€
52516	225mm	88mm	135mm	43mm	0.42	6	24	1152	28,00€
52517	135mm	53mm	90mm	31mm	0.10	12	72	1152	6,00€



50787 8,00€

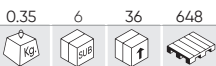

PLATEAU MAGNÉTIQUE Ø150MM



50788 14,50€

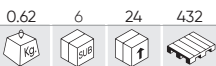

PLATEAU RECTANGULAIRE MAGNETIQUE



52466 11,00€

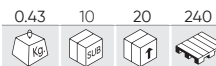

BOL MAGNÉTIQUE

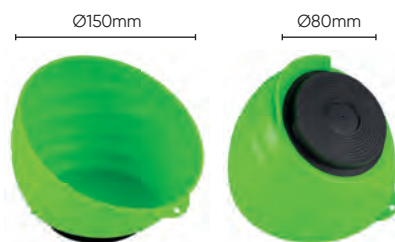

53958 6,50€

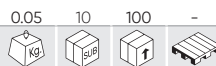

JEU DE 5 AIMANTS



50789 29,00€

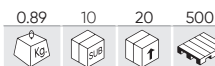

BARRE AIMANTÉE



53192 52,00€

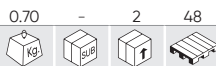

TAPIS DE SOL PLIANT



DIMENSIONS GÉNÉRALES



MESURES PLIÉ



- MOUSSE EVA.

53191 14,80€



TAPIS DE SOL INDIVIDUEL



DIMENSIONS GÉNÉRALES



- MOUSSE EVA.

50843

79,00€

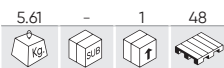

TABOURET ATELIER RÉGLABLE



Ø 295mm

Ø 380mm



50844

65,00€

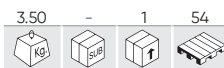

TABOURET FIXE



DIMENSIONS GÉNÉRALES



52148

65,00€

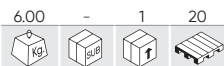

SIÈGE DE VISITE FIXE



DIMENSIONS GÉNÉRALES



50808

77,00€



SIÈGE DE VISITE PLIABLE



DIMENSIONS GÉNÉRALES



REF. DESCRIPTION

REF.	DESCRIPTION					€
11971	ROUES PER REF. 52148	0.20	5	50	-	3,60€

53211

75,00€

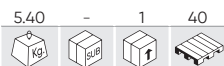

SIÈGE DE VISITE CONVERTIBLE PLIABLE



DIMENSIONS GÉNÉRALES

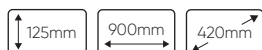

MESURES PLIÉ

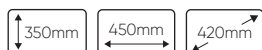

52542

109,00€



SIÈGE DE VISITE CONVERTIBLE EN SIÈGE



DIMENSIONS GÉNÉRALES



MESURES PLIÉ

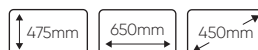

52869

52,00€

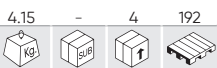

ÉTAU D'ÉTABLI 100MM



52870

100,00€

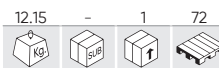

ÉTAU D'ÉTABLI 150MM



53031

59,00€

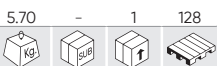

ÉTAU SUR BASE TOURNANTE



53032

126,00€



ÉTAU D'ÉTABLI BASE ROTATIVE 6"



52871

258,00€

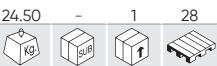

ÉTAU D'ÉTABLI 150MM TYPE RAPIDE



OUVERTURE IMMEDIATE
AVEC LEVIER +
EMBASE TOURNANTE

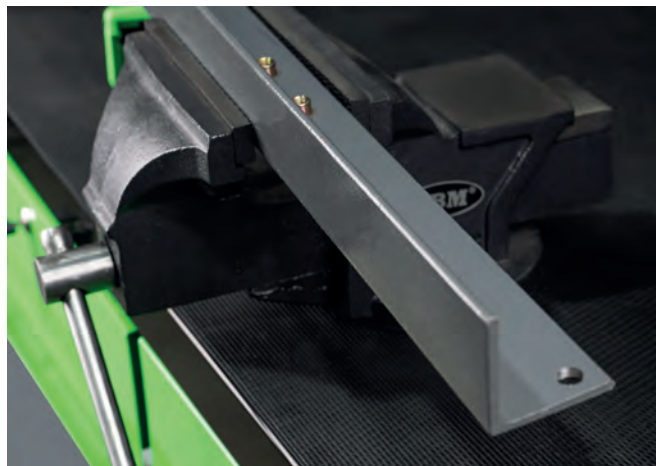

ENCLUME PROFESSIONNELLE

REF.	Kg.	mm					€
52308	50Kg	190x625x140mm	47.00	-	1	24	440,00€
52309	100Kg	245x790x180mm	100.00	-	1	8	941,00€

ACIER



OUTILS ÉLECTRIQUES SANS FIL

- 102 VISSAGE
- 106 PERÇAGE
- 108 SABLAGE/POLISSAGE
- 110 SCIE
- 113 OUTILS SPÉCIAUX
- 118 OUTILS ÉLECTRIQUES DE JARDINAGE
- 122 BATTERIES/CHARGEURS
- 123 ACCESSOIRES/CONSOMMABLES



**UTILISEZ-LES AVEC DES BATTERIES JBM:
UNE SEULE BATTERIE ADAPTÉE À TOUS LES OUTILS**

TROIS TYPES DE BATTERIE ET DEUX TYPES DE CHARGEUR.
CHOISISSEZ CELUI QUE VOUS PRÉFÉREZ!



60046C

339,00€

5,00 - 4 40



N

CLÉ À CHOCS SANS FIL BRUSHLESS 1/2" 550NM AVEC MALLETTE

COMPREND

REF.	DESCRIPTION					€
60013	BATTERIE LITHIUM-ION 4.0 AH	0.75	-	5	700	80,00€
60016	CHARGEUR 20 V - 4A	0.80	-	5	210	49,00€
60046	CLÉ À CHOC BRUSHLESS BATTERIE 1/2" 550NM	1.50	-	4	200	174,00€

Cet outil a été conçu pour serrer et desserrer les vis et les écrous qui nécessitent un couple élevé. Il est équipé d'une lampe de travail à LED et d'un sélecteur de sens de rotation qui vous permet également de verrouiller la gâchette et d'empêcher le démarrage accidentel de l'outil.

Il dispose de 5 vitesses différentes, 3 pour serrer et 2 pour desserrer, permettant d'ajuster la vitesse en fonction de l'opération à effectuer. De plus, grâce à sa poignée ergonomique, une meilleure prise en main et une plus grande précision sont obtenues.

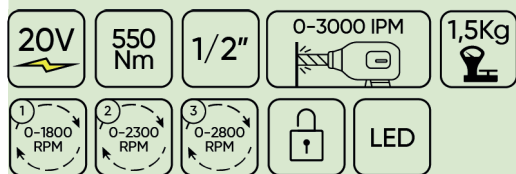

- MOTOR BRUSHLESS
- RÉTRO-ÉCLAIRAGE LED
- SÉLECTEUR DE SENS DE ROTATION AVANT / ARRIÈRE
- POIGNÉE
- 5 VITESSES DIFFÉRENTES
- CROCHET POUR COURROIE

NOS COMPARTIMENTS SONT COMPATIBLES AVEC LES BATTERIES 4.0AH ET 6.0AH.



60046

174,00€

1,50 - 4 200



N

CLÉ À CHOC BRUSHLESS BATTERIE 1/2" 550NM

BATTERIE NON INCLUSE.



**UTILISEZ-LES AVEC DES BATTERIES JBM:
UNE SEULE BATTERIE ADAPTÉE À TOUS LES OUTILS**

TROIS TYPES DE BATTERIE ET DEUX TYPES DE CHARGEUR.
CHOISISSEZ CELUI QUE VOUS PRÉFÉREZ!



60044C

485,00€

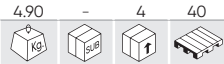

CLÉ À CHOCS SANS FIL BRUSHLESS 1/2" 1300NM AVEC MALLETTE

COMPREND

REF.	DESCRIPTION					€
60013	BATTERIE LITHIUM-ION 4.0 AH	0.75	-	5	700	80,00€
60016	CHARGEUR 20 V - 4A	0.80	-	5	210	49,00€
60044	CLÉ À CHOC 1/2" 1300NM AVEC MOTEUR BRUSHLESS	3.25	-	5	90	330,00€

Cet outil a été conçu pour tendre et desserrer les vis et les écrous nécessitant l'application d'un couple élevé. Il est équipé d'un moteur sans balais X-TorQ de nouvelle génération qui permet de dévisser les vis et les écrous coincés ou très serrés jusqu'à 2 fois plus rapidement. Robuste et durable. Avec un boîtier en aluminium protégé par un élastomère sur sa partie avant.

Il est équipé d'une lumière LED de travail et d'un sélecteur de sens de rotation qui permet également de verrouiller la gâchette pour éviter un démarrage accidentel de l'outil. Il dispose de 5 vitesses différentes, 3 pour serrer et 2 pour desserrer, permettant d'ajuster la vitesse selon l'opération que vous allez effectuer. Son double marteau au design innovant offre plus d'IPM et moins de vibrations.

Nouvel anneau de fixation de la douille : changement plus rapide des douilles et fixation plus sûre. Équilibre parfait de l'outil et poids pour les travaux nécessitant des douilles de grandes dimensions et des niveaux de couple élevés. Grand crochet utile pour suspendre la machine sur des structures métalliques ou à la ceinture de travail. De plus, grâce à sa poignée ergonomique, une meilleure prise en main et précision sont obtenues.

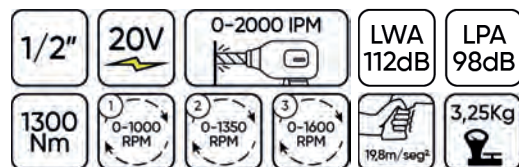

- MOTOR BRUSHLESS
- RÉTRO-ÉCLAIRAGE LED
- SÉLECTEUR DE SENS DE ROTATION AVANT / ARRIÈRE
- POIGNÉE
- 5 VITESSES DIFFÉRENTES
- CROCHET POUR COURROIE

NOS COMPARTIMENTS SONT COMPATIBLES AVEC LES BATTERIES 4.0AH ET 6.0AH.

60044

330,00€



CLÉ À CHOC 1/2" 1300NM AVEC MOTEUR BRUSHLESS

BATTERIE NON INCLUSE.



60048C

560,00€

7.15	-	4	32

N

CLÉ À CHOCS SANS FIL BRUSHLESS 3/4" 1300NM AVEC MALLETTE

COMPREND

REF.	DESCRIPTION					€
60015	BATTERIE LITHIUM-ION 6.0 AH	1.00	-	20	630	138,00€
60016	CHARGEUR 20 V - 4A	0.80	-	5	210	49,00€
60048	CLÉ À CHOC 3/4" 1300NM AVEC MOTEUR SANS BALAIS	3.26	-	4	64	366,00€

Cet outil a été conçu pour serrer et desserrer les vis et écrou nécessitant un couple de serrage élevé. Il est équipé d'une lampe de travail à LED et d'un sélecteur de sens de rotation qui permet également de verrouiller la gâchette pour éviter tout démarrage accidentel de l'outil.

Il dispose de 5 vitesses différentes, 3 pour serrer et 2 pour desserrer, permettant d'ajuster la vitesse en fonction de l'opération à effectuer. De plus, grâce à sa poignée ergonomique, une meilleure prise en main et une plus grande précision sont obtenues.

- MOTOR BRUSHLESS
- RÉTRO-ÉCLAIRAGE LED
- SÉLECTEUR DE SENS DE ROTATION AVANT / ARRIÈRE
- POIGNÉE
- 5 VITESSES DIFFÉRENTES
- CROCHET POUR COURROIE

NOS COMPARTIMENTS SONT COMPATIBLES AVEC LES BATTERIES 4.0AH ET 6.0AH.



60048

366,00€

3.26	-	4	64

N

CLÉ À CHOC 3/4" 1300NM AVEC MOTEUR SANS BALAIS

BATTERIE NON INCLUSE.



PIÈCES DE RECHANGE

60005

132,00€

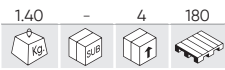

CLÉ À CHOC BRUSHLESS

BATTERIE NON INCLUSE.

Cet outil est conçu pour serrer rapidement les vis et les écrous et il est particulièrement utile lorsque vous travaillez avec des attaches longues et des matériaux durs. Le tournevis est muni d'un éclairage LED de la zone de travail pour un travail plus confortable et précis, d'un mandrin à changement rapide hexagonal de 1/4" de pouce pour une installation et un retrait rapides de la buse, ainsi que d'un déclencheur avec fonction de verrouillage pour éviter un démarrage accidentel de l'outil.

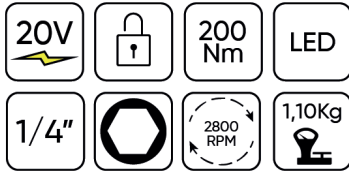

- A MOTOR BRUSHLESS
- B RÉTRO-ÉCLAIRAGE LED
- C SÉLECTEUR DE SENS DE ROTATION AVANT / ARRIÈRE
- D POIGNÉE
- E 5 VITESSES DIFFÉRENTES
- F CROCHET POUR COURROIE
- G BATTERIE NON INCLUSE



ACCESSOIRES ET PIÈCES DE RECHANGE

PAGE 126

60024

190,00€



1/2" CLIQUET ÉLECTRIQUE BRUSHLESS - 12V

BATTERIE NON INCLUSE.

Cet outil est conçu pour serrer/desserer les attaches dans les endroits difficiles d'accès.

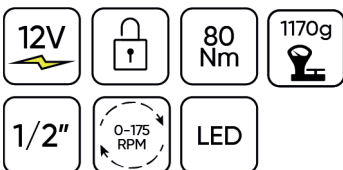

- A CLÉ CARRÉE 1/2 "
- B CHANGEMENT DE DIRECTION: AVANT / ARRIÈRE
- C LAMPE DE TRAVAIL LED INTÉGRÉE
- D INDICATEUR DE NIVEAU DE BATTERIE
- E INTERRUPTEUR DE VERROUILLAGE
- F VITESSE VARIABLE
- G PROTECTION DE SURCHARGE

COMPREND

REF.	DESCRIPTION					€
60025	CHARGEUR 12 V POUR RÉF. 60026	0.30	5	4	700	31,60€
60026	BATTERIE AU LITHIUM-ION 2.0 A*H SAMSUNG - POUR RÉF. 60024	0.20	5	40	1400	37,90€



60023

212,00€



PERFORATEUR AVEC MOTEUR BRUSHLESS

BATTERIE NON INCLUSE.

Cet outil est conçu pour le forage à percussion et le déchetage du béton et de la brique, ainsi que pour le forage habituel d'autres matériaux tels que l'acier, le bois, le métal, la céramique et le plastique.



- A MOTOR BRUSHLESS
- B JAUGE DE PROFONDEUR
- C CLAPET ANTI-POUSSIÈRE
- D MANDRIN À SERRAGE RAPIDE POUR OUTIL AVEC QUEUE SDS
- E COMMUTATEUR DE MODE DE FONCTIONNEMENT
- F COMMUTATEUR DE SENS DE ROTATION
- G POIGNÉE
- H RÉTRO-ÉCLAIRAGE LED
- I BATTERIE NON INCLUSE



- COMPRED**
 CLAPET ANTI-POUSSIÈRE
 JAUGE DE PROFONDEUR
 POIGNÉE SUPPLÉMENTAIRE
 BURIN POINTU
 BURIN PLAT
 FORETS SDS: Ø8/10/12 X 150 MM



ACCÉSSOIRES ET PIÈCES DE RECHANGE

PAGE 123

60006

182,00€



PERCEUSE À PERCUSSION À DEUX VITESSES AVEC MOTEUR BRUSHLESS

BATTERIE NON INCLUSE.

Cet outil est conçu pour le perçage du bois et du métal, les opérations de percussion principalement dans la maçonnerie, le béton, la pierre et la brique rouge, ainsi que pour le serrage/desserrage des vis et écrous.



- A MOTOR BRUSHLESS
- B RÉTRO-ÉCLAIRAGE LED
- C SÉLECTEUR DE SENS DE ROTATION AVANT / ARRIÈRE
- D POIGNÉE
- E CROCHET POUR COURROIE
- F BATTERIE NON INCLUSE



Poignée supplémentaire



ACCÉSSOIRES ET PIÈCES DE RECHANGE

PAGE 124

60047C

318,00€



N

PERCEUSE À PERCEUSE SANS FIL À 2 VITESSES AVEC MALLETTTE

COMPREND

REF.	DESCRIPTION					€
60013	BATTERIE LITHIUM-ION 4.0 AH	0.75	-	5	700	80,00€
60016	CHARGEUR 20 V - 4A	0.80	-	5	210	49,00€

Cet outil a été conçu pour percer des trous dans différents types de matériaux. Il peut effectuer des perçages dans le bois et le métal, ainsi que des perçages à percussion, plus courants dans la maçonnerie, dans la brique, le béton et la pierre. Vous pouvez également serrer, desserrer et dévisser les écrous et les vis. Pour ce faire, il dispose d'une bague de réglage qui permet de choisir entre 20 niveaux de couple différents.

Il dispose d'un sélecteur de vitesse et d'un sélecteur pour régler le sens de rotation à gauche ou à droite. Ce sélecteur, situé en position centrale, permet de verrouiller la gâchette et d'éviter un démarrage intempestif de l'outil.

Il est équipé d'une lumière LED pour améliorer la vision de la zone de travail. Comme accessoires, il dispose d'un crochet pour pouvoir l'accrocher à la ceinture et d'une poignée auxiliaire pour une meilleure tenue.

- MOTOR BRUSHLESS
- RÉTRO-ÉCLAIRAGE LED
- SÉLECTEUR DE SENS DE ROTATION AVANT / ARRIÈRE
- POIGNÉE
- 5 VITESSES DIFFÉRENTES
- CROCHET POUR COURROIE
- POIGNÉE SUPPLÉMENTAIRE

NOS COMPARTIMENTS SONT COMPATIBLES AVEC LES BATTERIES 4.0AH ET 6.0AH.



ACCÉSSOIRES ET PIÈCES DE RECHANGE

PAGE 124



60009

168,00€

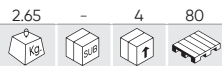

POLISSEUSE AVEC MOTEUR BRUSHLESS

BATTERIE NON INCLUSE.

L'outil est conçu pour les processus de finition, tels que le polissage et l'arrondi des coins et des bords, ainsi que pour l'obtention de surfaces lisses avec un disque et un tampon de polissage.



- A MOTEUR BRUSHLESS
- B COMMUTATEUR DE TOURS À 9 VITESSES:
- C COMMUTATEUR DE SÉCURITÉ.
- D POIGNÉE SOUPLE
- E POIGNÉE SUPPLÉMENTAIRE EN FORME DE D
- F BOUTON DE VERROUILLAGE DE LA BROCHE
- G TAMPON DE POLISSAGE
- H BATTERIE NON INCLUSE



CLÉ HEXAGONALE



PIÈCES DE RECHANGE



60033

104,00€



MEULEUSE BRUSHLESS

BATTERIE NON INCLUSE.

Cet outil est conçu pour poncer le bois, le fer, le plastique et les matériaux similaires à l'aide d'un papier abrasif approprié. La conception de cette ponceuse prévoit trois vitesses, une poignée confortable et un sac à poussière intégré.



- A MOTEUR BRUSHLESS
- B INTERRUPTEUR MARCHÉ/BOUTON DE RÉGLAGE DE VITESSE
- C INTERRUPTEUR ARRÊT
- D COLLECTEUR DE POUSSIÈRE
- E BASE
- F BATTERIE NON INCLUSE



PIÈCES DE RECHANGE

60049C

329,00€



N

MEULEUSE ANGULAIRE 125MM AVEC MALLETTE

COMPREND

REF.	DESCRIPTION					€
60013	BATTERIE LITHIUM-ION 4.0 AH	0.75	-	5	700	80,00€
60016	CHARGEUR 20 V - 4A	0.80	-	5	210	49,00€

BATTERIE NON INCLUSE.

La meuleuse d'angle sans fil est conçue pour effectuer tout type de travaux de coupe, de polissage et de ponçage. Elle comprend une poignée frontale et un capot de protection.



COUVECLE DE MEULE

POIGNÉE SUPPLÉMENTAIRE

BATTERIE NON INCLUSE

NOS COMPARTIMENTS SONT COMPATIBLES AVEC LES BATTERIES 4.0AH ET 6.0AH.



ACCÉSSOIRES ET PIÈCES DE RECHANGE

PIÈCES DE RECHANGE

PAGE 127

60028

142,00€

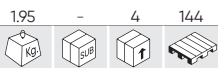

MEULEUSE ANGULAIRE AVEC MOTEUR SANS BALAIS - 125MM

BATTERIE NON INCLUSE.

La meuleuse d'angle sans fil est conçue pour effectuer tout type de travaux de coupe, de polissage et de ponçage. Elle comprend une poignée frontale et un capot de protection.



ACCÉSSOIRES ET PIÈCES DE RECHANGE

PIÈCES DE RECHANGE

PAGE 127



CLÉ

60019

178,00€

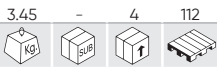

SCIE ALTERNATIVE AVEC MOTEUR BRUSHLESS

BATTERIE NON INCLUSE.

Cet outil est conçu pour couper une grande variété de matériaux et est largement utilisé. Sa conception permet un remplacement rapide et pratique de la lame de scie grâce au support à serrage rapide et se caractérise par une vitesse de coupe réglable en fonction de l'opération.

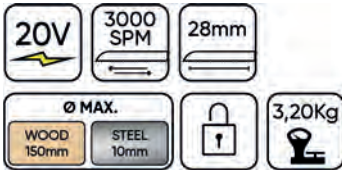

- A MOTOR BRUSHLESS
- B LAME DE SCIE
- C SABOT
- D SUPPORT À SERRAGE RAPIDE
- E BOUTON DE VERROUILLAGE DU BOUTON DE DÉMARRAGE
- F POIGNÉE SOUPLE
- G BATTERIE NON INCLUSE



ACCESSOIRES ET PIÈCES DE RECHANGE

PAGE 128

COMPREND
1 LAME POUR BOIS
1 LAME POUR MÉTAL

60020

175,00€

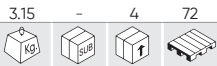

RABOTEUSE MOTEUR BRUSHLESS

BATTERIE NON INCLUSE.

Cet outil est conçu pour travailler avec du bois. Il permet d'obtenir une surface lisse du bois et de l'effiler si nécessaire.

Le rabot est muni d'une base en alliage d'aluminium pour un positionnement précis, d'un système de collecte de poussière pour collecter la poussière provenant du traitement du bois et d'un bouton de verrouillage du déclencheur pour éviter un démarrage accidentel de l'outil.

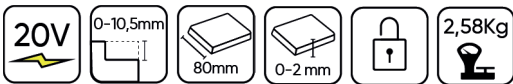

- A MOTOR BRUSHLESS
- B BOUTON DE VERROUILLAGE
- C POIGNÉE DE RÉGLAGE DE LA PROFONDEUR DE RAINURAGE
- D GUIDE DE COUPE PARALLÈLE
- E GUIDE DE PROFONDEUR DE BOUVETAGE
- F POIGNÉE DE RÉGLAGE DU GUIDE DE BOUVETAGE
- G PORT DE DÉPOUSSIÉRAGE
- H RAINURE EN V
- I BATTERIE NON INCLUSE



COMPREND
1 POIGNÉE DE RÉGLAGE DE PROFONDEUR DE LANGUETTE
3 POIGNÉE DE RÉGLAGE
1 GUIDE PARALLÈLE
1 CLÉ
1 VIS

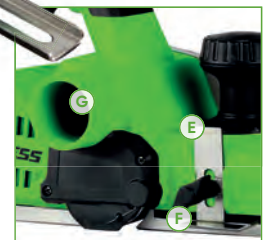

60010

170,00€

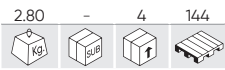

SCIE À HORLOGER AVEC MOTEUR BRUSHLESS

BATTERIE NON INCLUSE.

Cet outil est conçu pour scier des matériaux tels que le bois, l'acier, le plastique et le métal. La scie à horloger est munie d'un mécanisme pendulaire à 4 positions : 3 positions pour la coupe orbitale et 1 position pour la coupe directe, ce qui vous permet de choisir la vitesse de coupe optimale de la lame en fonction de la dureté du matériau.



- A MOTOR BRUSHLESS
- B PROTÈGE-LAME
- C SUPPORT RAPIDE
- D LAME DE SCIE
- E RÉGULATEUR DE COURSE PENDULAIRE
- F LEVIER DE RÉGLAGE DU SABOT
- G BOUTON DE VERROUILLAGE DU BOUTON DE DÉMARRAGE
- H BATTERIE NON INCLUSE



PIÈCES DE RECHANGE

ACCÉSSOIRES ET PIÈCES DE RECHANGE

PAGE 128



COMPREND

- 1 LAME POUR BOIS
- 1 GUIDE DE BORD
- 1 TUYAU DE POUSSIÈRE

60007

170,00€

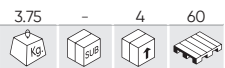

SCIE À DISQUE AVEC MOTEUR BRUSHLESS

BATTERIE NON INCLUSE.

Cet outil est conçu pour scier du bois. La scie circulaire d'un diamètre de 165 mm avec 24 dents est idéale pour les coupes longitudinales/transversales droites, ainsi que pour le sciage de planches et panneaux de bois à un angle allant jusqu'à 45°.



- A MOTOR BRUSHLESS
- B LEVIER POUR PROTÈGE-DISQUE INFÉRIEUR
- C PATIN
- D PROTÈGE-DISQUE INFÉRIEUR
- E POIGNÉE DE BLOCAGE D'ANGLE DE COUPE
- F POIGNÉE AVANT
- G BOUTON DE BLOCAGE DU DÉCLENCHEUR
- H BATTERIE NON INCLUSE



PIÈCES DE RECHANGE

ACCÉSSOIRES ET PIÈCES DE RECHANGE

PAGE 128



COMPREND

- 1 LAME 24T TCT 165 MM
- 1 GUIDE DE BORD
- 1 CLÉ HEXAGONALE

60011

175,00€



SCIE À DISQUE MINIATURE AVEC MOTEUR BRUSHLESS

BATTERIE NON INCLUSE.

Cet outil est conçu pour scier du bois. La scie circulaire d'un diamètre de 115 mm avec 24 dents est idéale pour les coupes longitudinales/transversales droites, ainsi que pour le sciage de planches et panneaux de bois à un angle allant jusqu'à 45°. La scie possède également un bouton de verrouillage du déclencheur pour éviter un démarrage accidentel de l'outil et un boîtier en aluminium.



- A MOTOR BRUSHLESS
- B PROTÈGE-DISQUE INFÉRIEUR DU
- C LEVIER DU PROTÈGE-DISQUE INFÉRIEUR
- D PLAQUE D'APPUI
- E PROTÈGE-DISQUE SUPÉRIEUR
- F GUIDE POUR COUPES
- G BOUTON DE VERROUILLAGE
- H BATTERIE NON INCLUSE



- COMPREND**
- 1 LAME 24T TCT 115MM
 - 1 GUIDE DE BORD
 - 1 TUYAU DE POUSSIÈRE
 - 1 CLÉ HEXAGONALE



ACCÉSSOIRES ET PIÈCES DE RECHANGE

PIÈCES DE RECHANGE

PAGE 128

60022

470,00€



SCIE À TRONÇONNER AVEC MOTEUR BRUSHLESS

BATTERIE NON INCLUSE.

Cet outil est conçu pour scier du bois et des matériaux similaires. L'outil vous permet d'effectuer des coupes à onglet lorsqu'une coupe inclinée le long de la surface de la pièce à travailler est nécessaire, des coupes à un angle qui sont utilisées, en règle générale, pour les joints formant un angle de 90°, ainsi que des coupes combinées lorsqu'une coupe angulaire est nécessaire en même temps le long du bord et de la surface avant de la pièce à travailler.

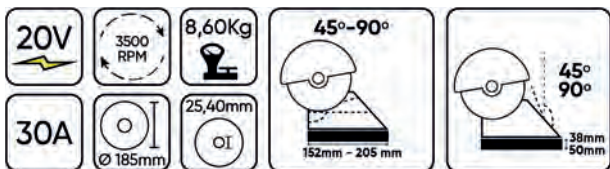

- COMPREND**
- 1 SCIE CIRCULAIRE À 40 DENTS
 - 1 PINCE
 - 1 CLÉ POUR DISQUE COUPANTE
 - 1 SAC À POUSSIÈRE



ACCÉSSOIRES ET PIÈCES DE RECHANGE

PIÈCES DE RECHANGE

PAGE 128



60032

123,00€

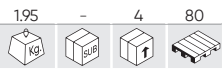

PISTOLET JOINT BATTERIE

BATTERIE NON INCLUSE.

Cet outil est conçu pour combler toutes les crevasses ou fissures dans une grande variété de matériaux tels que le métal, le verre, le bois et la céramique.



- A PORTE-CARTOUCHE
- B PISTON
- C TIGE DE PISTON
- D POIGNÉE DE LA TIGE DE PISTON
- E DÉCLENCHEUR DE DÉPLACEMENT DE LA TIGE DE PISTON
- F RÉGULATEUR DE VITESSE
- G LAMPE LED
- H BATTERIE NON INCLUSE



PIÈCES DE RECHANGE

60038

255,00€

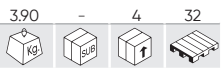

SERINGUE DE GRAISSE BATTERIE

BATTERIE NON INCLUSE.

Cet outil est un pistolet graisseur. Grâce à l'alimentation par batterie, l'outil est facile à utiliser et à transporter.



- A MOLETTE DE RÉGLAGE DU DÉBIT DE GRAISSE
- B BOUTON DE VERROUILLAGE
- C POIGNÉE ERGONOMIQUE SOUPLE
- D TUYAU FLEXIBLE
- E TUBE DE GRAISSE
- F PORTE-OUTIL
- G BATTERIE NON INCLUSE



PIÈCES DE RECHANGE

60041

77,00€



OUTIL MULTIFONCTIONNEL OSCILLANT SANS FIL

BATTERIE NON INCLUSE.

Une variété d'accessoires peut être utilisée avec l'outil oscillant multifonction pour s'adapter à une grande variété de tâches. L'outil est particulièrement utile pour le nettoyage, le ponçage et le sciage en profondeur dans des endroits difficiles d'accès.

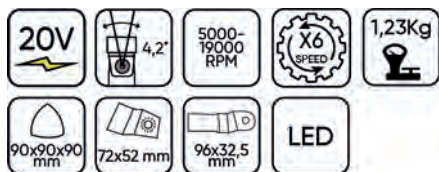

- A MOTOR BRUSHLESS
- B LEVIER DE SERRAGE
- C SUPPORT DE FIXATION
- D VOLANT DE SÉLECTION DE LA VITESSE
- E LAMPE DE TRAVAIL
- F PORTE-OUTIL
- G BATTERIE NON INCLUSE



COMPREND

- 1 LAME DE SCIE PLONGEANTE
- 1 FEUILLE DE PONÇAGE
- 1 PLAQUE DE PONÇAGE
- 1 GRATTOIR
- 1 RONDELLE
- 1 POIGNÉE

60037

222,00€



CLOUEUSE / AGRAFEUSE BATTERIE

BATTERIE NON INCLUSE.

L'outil est conçu pour fixer le carton, les matériaux isolants, le tissu, le papier d'aluminium, le cuir et les matériaux similaires au bois ou à d'autres surfaces similaires par un enfoncement à haute puissance avec de l'air comprimé.



- A RÉTROÉCLAIRAGE LED
- B GOUPILLE DE CONTACT DE SÉCURITÉ
- C MAGASIN
- D INDICATEUR LED
- E POIGNÉE DE SÉLECTION DE L'ENTRAÎNEMENT
- F INTERRUPTEUR DE RÉTROÉCLAIRAGE LED
- G BATTERIE NON INCLUSE



ACCESSOIRES ET PIÈCES DE RECHANGE

PAGE 127

AGRAFES DE TYPE LÉGER AVEC HAUT ÉTROIT TAILLE 18

LONGUEUR DES AGRAFES MAX.	40 mm
ÉPAISSEUR MAXIMALE DE LA SECTION DE L'AGRAFE	1.2 mm
LARGEUR MAXIMALE DE LA SECTION DES AGRAFES	1 mm
TAILLE DE LA PARTIE SUPÉRIEURE DE L'AGRAFE MAX.	6 mm

CLOUS SANS CAPUCHON TAILLE 18

LONGUEUR DES CLOUS MAX	50 mm
LARGEUR MAXIMALE DE LA SECTION TRANSVERSALE DU CLOU	1.25 mm
ÉPAISSEUR MAXIMALE DE LA SECTION TRANSVERSALE DU CLOU	1.05 mm

60042

106,00€

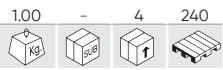

PISTOLET À CHALEUR BATTERIE

BATTERIE NON INCLUSE.

Cet outil est conçu pour combler toutes les crevasses ou fissures dans une grande variété de matériaux tels que le métal, le verre, le bois et la céramique.

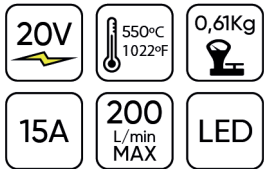

- A COUVERCLE AVANT
- B BUSE
- C RÉTROÉCLAIRAGE LED
- D VERROU DE L'INTERRUPTEUR D'ALIMENTATION
- E CROCHET MÉTALLIQUE
- F BATTERIE NON INCLUSE



PIÈCES DE RECHANGE

60043

123,00€

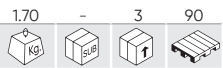

PULVÉRISATEUR DE PEINTURE SANS FIL

BATTERIE NON INCLUSE.

Cet outil est conçu pour pulvériser la peinture sur des surfaces intérieures et extérieures.



- A RÉGULATEUR DE DÉBIT (VITESSE D'ÉCOULEMENT)
- B RÉSERVOIR
- C BLOQUEUR DE RÉSERVOIR
- D FILTRE À AIR
- E BATTERIE NON INCLUSE



PIÈCES DE RECHANGE

UTILISEZ-LES AVEC DES BATTERIES JBM: UNE SEULE BATTERIE ADAPTÉE À TOUS LES OUTILS

TROIS TYPES DE BATTERIE ET DEUX TYPES DE CHARGEUR.
CHOISISSEZ CELUI QUE VOUS PRÉFÉREZ!

**Batteries et chargeurs NON INCLUS dans les outils.*



60001

88,00€

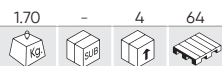

ASPIRATEUR PORTATIF

BATTERIE NON INCLUSE.

Cet aspirateur électrique sans fil est conçu pour nettoyer tous les matériaux qui ne sont pas dangereux pour la santé.



- A COLLECTEUR DE POUSSIÈRE
- B BOUTON D'ÉJECTION DU COLLECTEUR DE POUSSIÈRE
- C INTERRUPTEUR PRINCIPAL
- D CARTER MOTEUR
- E SUCEUR PLAT
- F TÊTE DE BROSSE
- G BUSE DE SOL
- H TUBE DE RALLONGE
- I BATTERIE NON INCLUSE



COMPREND

REF.	DESCRIPTION					€
14950	TUBE DE RALLONGE POUR RÉF. 60001	0.08	5	10	-	6,50€
14951	BUSE À FENTE POUR RÉF. 60001	0.01	-	10	-	9,50€
14952	BUSE DE SOL POUR RÉF. 60001	0.15	-	5	-	19,00€
14953	BROSSE POUR RÉF. 60001	0.05	-	10	-	8,50€

60003

110,00€



POMPE ÉLECTRIQUE POUR POMPAGE DE ROUE

BATTERIE NON INCLUSE.

Grâce à cette pompe, vous pourrez gonfler des pneus d'automobile et de vélo, des ballons, des radeaux, des mate-las / piscines gonflables, etc.

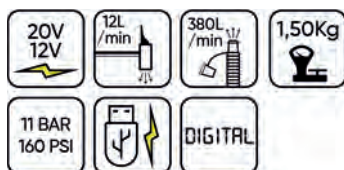

- A INDICATEUR LED
- B COMMUTATEUR AVEC INDICATEUR LED
- C COMMUTATEUR DE SÉLECTION DE MODE DE FONCTIONNEMENT
- D BOUTONS DE RÉGLAGE DE PRESSION
- E CONNECTEUR USB
- F TUYAU HAUTE PRESSION
- G TUYAU HAUTE PERFORMANCE
- H PRISE POUR ALLUME-CIGARE AVEC UNE TENSION DE 12 V
- I BATTERIE NON INCLUSE



COMPREND



60004

79,00€

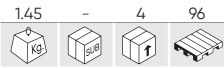

FEU DE TRAVAIL LED

BATTERIE NON INCLUSE.

Ce feu de travail LED est conçu pour créer l'éclairage nécessaire dans la zone de travail et dans d'autres endroits. Le feu peut être connecté à un réseau 230 V à l'aide d'un câble réseau situé à l'arrière de l'appareil.

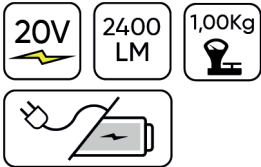

- A INTERRUPTEUR (ON / OFF)
- B TÊTE ROTATIVE DE LA LAMPE DE TRAVAIL
- C MATRICE LED
- D BLOQUEUR DE POSITION LATÉRAL
- E CÂBLE RÉSEAU
- F BATTERIE NON INCLUSE



REF.	DESCRIPTION					€
15049	TREPIED POUR FEU DE TRAVAIL LED (REF. 60004)	2,10	-	4	120	37,40€

60035

30,00€

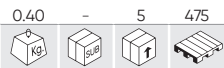

LED RECHARGEABLE WORK LIGHT

BATTERIE NON INCLUSE.

Cette lampe de travail LED est conçue pour fournir l'éclairage nécessaire dans la zone de travail et d'autres lieux. Elle est alimentée par une batterie lithium-ion portable, ce qui la rend portable et idéale pour tous les lieux de travail et les situations où l'alimentation secteur est limitée.

Le diffuseur de la lampe LED fournit un flux lumineux de 500 et 1000 lumens, et le mécanisme pivotant de la lampe (90°) vous permet d'ajuster l'angle souhaité. De plus, le kit comprend une poignée souple pour une manipulation plus confortable et un crochet de suspension pour la fixation à un autre objet.

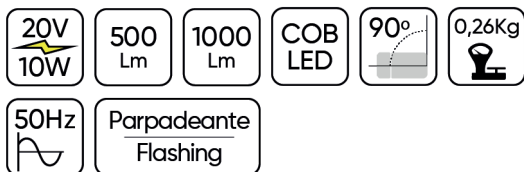

- A DIFFUSEUR
- B MÉCANISME PIVOTANT
- C CROCHET DE SUSPENSION
- D INTERRUPTEUR ON/OFF
- E BATTERIE NON INCLUSE



60039

265,00€

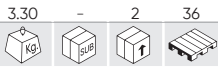

MACHINE À LAVER BATTERIE AVEC MOTEUR BRUSHLESS

BATTERIE NON INCLUSE.

Le nettoyeur haute pression avec moteur BRUSHLESS est conçu pour nettoyer les véhicules, les équipements, les outils, les meubles de jardin, etc.



- A MOTEUR BRUSHLESS
- B BUSE ROTATIVE À 5 POSITIONS
- C RACCORD RAPIDE DE BUSE
- D TUBE
- E INDICATEUR DE PRESSION
- F SÉLECTEUR DE PRESSION
- G INTERRUPTEUR DE VERROUILLAGE
- H RACCORD RAPIDE DE TUYAU
- I BATTERIE NON INCLUSE



PIÈCES DE RECHANGE



60027

99,00€

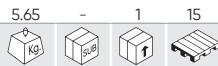

PULVÉRISATEUR ÉLECTRIQUE INDUSTRIEL À DOS AVEC RÉSERVOIR 15 L

BATTERIE NON INCLUSE.

L'outil convient à la désinfection des maisons privées, des lieux publics, des fermes d'élevage, des jardins, etc., et vous permet de détruire toutes les particules dangereuses, d'empêcher leur propagation et en même temps d'empêcher la reproduction des insectes et le développement de maladies.

Poignée intelligente qui fournit un verrou pour un fonctionnement continu. De plus, la livraison comprend 4 buses avec un débit spécifique et des performances en fonction des exigences : 1 buse conique creuse, 1 buse conique creuse double, 1 buse réglable à 4 trous, 1 buse de ventilateur.



- A POIGNÉE POUR UN TRANSPORT FACILE
- B COUSSIN RESPIRANT ET ERGONOMIQUE
- C COUVERCLE DE REMPLISSAGE AVEC VERROU
- D MONTANT TÉLESCOPIQUE POUR PULVÉRISATION
- E BATTERIE NON INCLUSE

COMPRED



60029

240,00€

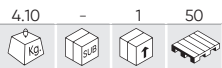

TRONÇONNEUSE BATTERIE AVEC MOTEUR BRUSHLESS

BATTERIE NON INCLUSE.

Cet outil forestier est conçu pour des tâches telles que l'abattage, l'ébranchage, le sciage et la coupe d'arbres. L'outil est équipé d'une poignée pour régler la tension du guide-chaîne et de la chaîne, d'un frein de chaîne pour arrêter la chaîne lors du recul et d'un attrape-chaîne pour l'attraper si elle se casse ou se détache. Il dispose également d'un système de lubrification automatique de la chaîne et d'un bouton de verrouillage du déclencheur pour éviter tout démarrage accidentel. L'outil se compose d'un guide-chaîne, d'une chaîne et d'une protection pour protéger à la fois le guide-chaîne et la chaîne pendant le transport et le stockage.



- A MOTOR BRUSHLESS
- B CHAÎNE DE SCIE
- C GUIDE-CHAÎNE
- D FREIN DE CHAÎNE / PROTECTION AVANT
- E POIGNÉE AVANT
- F BOUTON DE VERROUILLAGE
- G BOUCHON DU RÉSERVOIR D'HUILE
- H BATTERIE NON INCLUSE



COMPREND



60030

112,00€

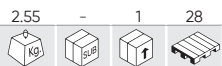

SOUFFLEUR A BATTERIE

BATTERIE NON INCLUSE.

Cet outil est conçu pour ramasser les feuilles, l'herbe, le papier et les matériaux similaires. La conception légère et alimentée par batterie facilite le transport de l'outil d'un endroit à un autre. La conception prévoit un commutateur de débit et de volume d'air élevé/faible et une poignée souple pour une utilisation facile.



- A MOTOR BRUSHLESS
- B TUBE
- C EMBOUT DU TUBE DU VENTILATEUR SOUFLANT
- D BOÎTIER
- E BATTERIE NON INCLUSE

N'ACCÉPTE PAS LES BATTERIES 6.0 AH



60031

142,00€



TAILLE-HAIE A BATTERIE

BATTERIE NON INCLUSE.

Cet outil est conçu pour une exécution rapide et commode des tâches de jardinage telles que la taille ou la coupe des haies vives ou des buissons. La conception légère et alimentée par batterie facilite le transport de l'outil d'un endroit à un autre.

Le kit de l'outil comprend un protège-lame pour maintenir la débroussailleuse en bon état, une enveloppe de protection qui aide à éloigner les débris des mains et des yeux de l'opérateur, et une poignée auxiliaire pour un meilleur contrôle et un environnement de travail confortable. De plus, la conception fournit deux interrupteurs et un bouton de verrouillage qui empêche tout démarrage accidentel de l'outil.



- A MOTOR BRUSHLESS
- B LAME DE COUPE
- C PORTE-LAME
- D ENVELOPPE
- E POIGNÉE AUXILIAIRE
- F INTERRUPTEUR AUXILIAIRE
- G BOUTON DE VERROUILLAGE
- H POIGNÉE ARRIÈRE
- I BATTERIE NON INCLUSE



COMPREND
PROTÈGE-LAME



60040

440,00€



MACHINE DE JARDIN BATTERIE MULTIFONCTIONNELLE (4 EN 1)

BATTERIE NON INCLUSE.

L'outil de jardin électrique multifonctionnel (4 en 1) est conçu pour une grande variété de tâches extérieures, telles que le débroussaillage des espaces verts, la taille des haies, la taille des branches etc. L'outil est idéal pour l'entretien complet du jardin.

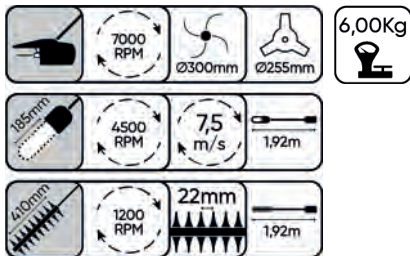

- A MOTOR BRUSHLESS
- B PROTECTION
- C LAME À TROIS DENTS
- D LAME
- E SCIE
- F POIGNÉES
- G DÉBROUSSAILLEUSE
- H TÊTE FAUCHEUSE
- I TAILLE-HAIE
- J SCIE À BARRE
- K BATTERIE NON INCLUSE



52598

1.080,00€



ROBOT TONDEUSE

Robot tondeuse moderne et fonctionnelle, parfait pour l'entretien et le bien être de votre pelouse et de vos espaces verts. Il est équipé d'un moteur brushless, alimenté par une puissante batterie de 5200 Ah, pour une autonomie d'environ 150 minutes. Le plateau de coupe à trois lames en acier qui effectue une coupe mulching. Ce système de coupe broie très finement l'herbe, puis la dépose directement sur le sol, donnant à la pelouse un aspect impeccable sans procéder à l'enlèvement des restes. De plus, avec cette coupe, l'herbe déposée sur la pelouse va se décomposer et devenir un nutriment pour le sol, créant un cycle biologique totalement naturel. Le câble périphérique et les piquets fournis permettent une installation facile et sans outil.



5200 mAh Capacité de la batterie battery capacity	1400m ² Superficie de coupe Mowing area	IP X4	DC 15-25.5V tension de sortie tension de sortie	2,5h	22m/min
115,44W consommation de puissance power consumption	AC 100-240V 50/60Hz tension d'alimentation input voltage	7,5Kg	2h	70 dB(A)	50-35,5-24 cm



CONNEXION DE L'APPLICATION



PIÈCES DE RECHANGE

- A MOTOR BRUSHLESS
- B BOUTON STOP
- C STATION DE CHARGE
- D ROUE ARRIÈRE
- E COUVERCLE DE LA POIGNÉE

60045

298,00€



TONDEUSE À GAZON SANS FIL

BATTERIE NON INCLUSE.

Cette tondeuse sans fil vous permet de garder votre jardin en parfait état. Elle est équipée d'un moteur sans balais qui augmente l'efficacité et réduit le niveau de bruit. Elle est également très légère et facile à utiliser.

40V	800W	35L	11,6 Kg.
3.300 RPM	6x 25-75mm	152 - 203mm Ø	370mm Ø
96 dB(A)	IP X1	4.0A	11,40Kg



- A MOTOR BRUSHLESS
- B TONDEUSE À GAZON
- C POIGNÉE
- D SAC DE RAMASSAGE D'HERBE

FONCTIONNE AVEC 2 BATTERIES 4AH (NON INCLUES)



PIÈCES DE RECHANGE

**UTILISEZ-LES AVEC DES BATTERIES JBM:
UNE SEULE BATTERIE ADAPTÉE
À TOUS LES OUTILS**

TROIS TYPES DE BATTERIE ET DEUX TYPES DE CHARGEUR.
CHOISISSEZ CELUI QUE VOUS PRÉFÉREZ!

**Batteries et chargeurs NON INCLUS dans les outils.*



BATTERIE LI-ION



INDICATEURS DE CHARGE LED



PROTECTION CONTRE LES COURTS-CIRCUITS



PROTECTION CONTRE LA SURCHAUFFE



PROTECTION CONTRE LA SURCHARGE DE LA BATTERIE



60012



48,00€



60013



80,00€



60015



138,00€



POUR REF. 60024

60026

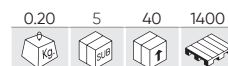

37,90€



CHARGEURS



INDICATEURS DE CHARGE LED



PROTECTION CONTRE LES COURTS-CIRCUITS



PROTECTION CONTRE LA SURCHAUFFE



PROTECTION CONTRE LA SURCHARGE DE LA BATTERIE



60016



49,00€



2.0AH
30min +/-10min

4.0AH
60min +/-15min

6.0AH
90min +/-15min



CHARGEUR RAPIDE

60017



64,00€



2.0AH
30min +/-10min

4.0AH
45min +/-10min

6.0AH
60min +/-15min



POUR REF. 60026

60025

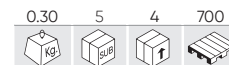

31,60€



2.0AH
60min +/-10min

ACCÉSSOIRES



REF.	DESCRIPTION	mm						€
14622	PLATEAU POUR RÉF. 60001, 60003, 60004, 60020	320x180	A	0.95	-	10	360	17,00€
14623	CROCHET POUR RÉF. 60005, 60006, 60018	70x84	B	0.10	-	10	800	8,00€
14624	PLATEAU POUR RÉF. 60007, 60010, 60011	290x160	C	0.65	-	10	300	17,00€
14625	CROCHET POUR RÉF. 60008, 60009	40x200x100	D	0.50	-	10	700	14,00€
14626	CROCHET POUR RÉF. 60023	115x70	E	0.10	-	10	-	7,00€
16364	CROCHET À UNE POINTE 280MM	280		0.20	-	200	-	3,50€

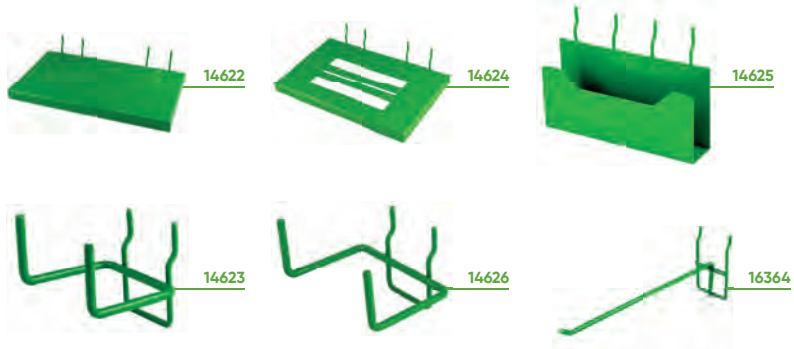

PIÈCES DE RECHANGE



BURIN SDS-PLUS

REF.	DESCRIPTION				€
14837	BURIN À EXTRÉMITÉ AIGÜE SDS-PLUS 14X250MM	0.25	10	100	3,30€
14838	BURIN À EXTRÉMITÉ PLATE SDS-PLUS 20X250MM	0.25	10	100	3,40€
14839	BURIN À EXTRÉMITÉ PLATE SDS-PLUS 40X250MM	0.29	10	50	4,70€
14840	BURIN À RAINURER SDS-PLUS 250MM	0.27	10	50	3,35€



53850

14,90€

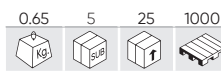

KIT DE FORETS POUR PERCEUSE AVEC EMMANCHEMENT SDS-PLUS



PIÈCES DE RECHANGE DISPONIBLES

REF.	mm				€
14826	Ø 5x110mm	0.05	125	500	1,50€
14828	Ø 6x110mm	0.05	25	500	1,50€
14829	Ø 6x160mm	0.04	25	500	1,50€
14830	Ø 8x110mm	0.04	25	500	1,50€
14831	Ø 8x160mm	0.05	25	500	1,50€
14832	Ø 10x160mm	0.05	25	200	2,00€
14920	Ø 12x160mm	0.10	100	200	2,50€

TU POURRAIS AUSSI AIMER...

REF.	mm				€
14825	Ø 4x110mm	0.05	100	200	1,50€
14827	Ø 5x160mm	0.04	25	500	2,00€
14833	Ø 10x210mm	0.10	20	200	2,05€
14834	Ø 12x210mm	0.10	100	200	2,50€
14835	Ø 14x210mm	0.10	20	125	3,00€
14836	Ø 16x210mm	0.14	20	120	3,50€



14841

2,58€

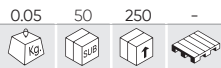

ADAPTATEUR SDS-PLUS POUR MANDRIN DE PERÇAGE 1/2"



14842

9,50€

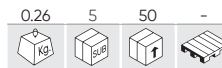

MANDRIN DE PERÇAGE À CHANGEMENT RAPIDE 2-13 MM 1/2"-20 UNF (FILETAGE FIN UNIFIÉ)



60006
60047C

53860

3,65€

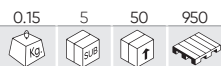

KIT DE FORETS POUR BÉTON 4-10 MM



PIÈCES DE RECHANGE DISPONIBLES

REF.	mm				€
14908	Ø 4x75mm	0.01	50	100	0,60€
14909	Ø 5x80mm	0.01	50	100	0,80€
14910	Ø 6x100mm	0.01	50	100	1,00€
14912	Ø 8x120mm	0.05	50	100	1,55€
14914	Ø 10x120mm	0.04	20	100	2,10€

TU POURRAIS AUSSI AIMER...

REF.	mm				€
14915	Ø 11x150mm	0.05	20	100	2,65€
14916	Ø 12x150mm	0.06	20	100	2,95€
14917	Ø 13x150mm	0.10	20	100	3,45€



53861

5,45€

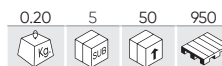

KIT DE FORETS POUR BÉTON 3-10 MM



PIÈCES DE RECHANGE DISPONIBLES

REF.	mm				€
14907	Ø 3x60mm	0.01	50	100	0,50€
14908	Ø 4x75mm	0.01	50	100	0,60€
14909	Ø 5x80mm	0.01	50	100	0,80€
14910	Ø 6x100mm	0.01	50	100	1,00€
14911	Ø 7x100mm	0.01	50	100	1,30€
14912	Ø 8x120mm	0.05	50	100	1,55€
14913	Ø 9x120mm	0.05	50	100	1,90€
14914	Ø 10x120mm	0.04	20	100	2,10€



53859

67,00€



KIT DE SCIES CLOCHES BIMÉTALLIQUES AVEC ADAPTATEURS



	x6	22, 29, 35, 44, 51, 68mm
	x2	14-30mm, 32-152mm



PIÈCES DE RECHANGE DISPONIBLES

REF.	mm				€
14901	22mm	0.04	10	50	3,60€
14902	29mm	0.08	10	50	4,65€
14903	35mm	0.10	10	50	5,25€
14904	44mm	0.12	10	50	6,85€
14905	51mm	0.12	10	50	8,50€
14906	68mm	0.19	10	50	10,20€
14934	14-30mm	0.07	10	50	4,25€
14935	32-152mm	0.20	10	50	8,45€

KIT DE FORETS HÉLICOÏDAUX HSS 4341

53852 207,00€



170 PCS HSS-G 4341
METAL 1-10 mm



53856 62,00€



25 PCS HSS-G 4341
METAL 1-13 mm



53854 27,00€



19 PCS HSS-G 4341
METAL 1-10 mm



PIÈCES DE RECHANGE DISPONIBLES

REF.	mm				€
14868	Ø 1x34mm	0.01	50	400	0,55€
14869	Ø 1.5x40mm	0.01	50	400	0,60€
14870	Ø 2x49mm	0.01	50	400	1,00€
14871	Ø 2.5x57mm	0.01	50	400	1,00€
14872	Ø 3x61mm	0.01	50	400	1,00€
14873	Ø 3.5x70mm	0.01	50	400	1,00€
14874	Ø 4x75mm	0.01	50	400	1,00€
14875	Ø 4.5x80mm	0.01	50	400	1,50€
14876	Ø 5x86mm	0.01	50	300	1,50€
14877	Ø 5.5x93mm	0.02	50	300	1,50€
14878	Ø 6x93mm	0.02	25	400	2,00€
14879	Ø 6.5x101mm	0.02	25	400	2,00€
14880	Ø 7x109mm	0.03	25	400	2,50€
14881	Ø 7.5x109mm	0.03	25	400	2,50€
14882	Ø 8x117mm	0.04	25	400	3,00€
14883	Ø 8.5x117mm	0.04	25	400	3,50€
14884	Ø 9x125mm	0.05	25	400	3,65€
14885	Ø 9.5x125mm	0.05	25	400	4,00€
14886	Ø 10x133mm	0.06	25	400	4,60€
14887	Ø 10.5x133mm	0.07	25	400	5,00€
14888	Ø 11x142mm	0.08	25	400	6,00€
14889	Ø 11.5x142mm	0.09	25	400	6,50€
14890	Ø 12x151mm	0.10	25	300	7,00€
14891	Ø 12.5x151mm	0.09	25	200	7,50€
14892	Ø 13x151mm	0.09	25	200	8,00€

1x34, 1.5x40, 2x49, 2.5x57, 3x61, 3.5x70, 4x75, 4.5x80, 5x86, 5.5x93, 6x93, 6.5x101, 7x109, 7.5x109, 8x117, 8.5x117, 9x125, 9.5x125, 10x133mm

1x34, 1.5x40, 2x49, 2.5x57, 3x61, 3.5x70, 4x75, 4.5x80, 5x86, 5.5x93, 6x93, 6.5x101, 7x109, 7.5x109, 8x117, 8.5x117, 9x125, 9.5x125, 10x133, 10.5x133, 11x142, 11.5x142, 12x151, 12.5x151, 13x151mm

1x34, 1.5x40, 2x49, 2.5x57, 3x61, 3.5x70, 4x75, 4.5x80, 5x86, 5.5x93, 6x93, 6.5x101, 7x109, 7.5x109, 8x117, 8.5x117, 9x125, 9.5x125, 10x133mm

KIT DE FORETS HÉLICOÏDAUX HSS 4241 NOIR

53851 88,00€



170 PCS HSS-G 4241
METAL 1-10 mm



53855 24,80€



25 PCS HSS-G 4241
METAL 1-13 mm



53853 14,40€



19 PCS HSS-G 4241
METAL 1-10 mm



PIÈCES DE RECHANGE DISPONIBLES

REF.	mm				€
14843	Ø 1x34mm	0.01	50	400	0,50€
14844	Ø 1.5x40mm	0.01	50	400	0,50€
14845	Ø 2x49mm	0.01	50	400	0,50€
14846	Ø 2.5x57mm	0.01	50	400	0,50€
14847	Ø 3x61mm	0.01	50	400	0,50€
14848	Ø 3.5x70mm	0.01	50	400	0,50€
14849	Ø 4x75mm	0.01	50	400	1,00€
14850	Ø 4.5x80mm	0.01	50	400	1,00€
14851	Ø 5x86mm	0.01	50	300	1,00€
14852	Ø 5.5x93mm	0.01	50	300	1,00€
14853	Ø 6x93mm	0.02	25	400	1,00€
14854	Ø 6.5x101mm	0.02	25	400	1,00€
14855	Ø 7x109mm	0.02	25	400	1,00€
14856	Ø 7.5x109mm	0.03	25	400	1,00€
14857	Ø 8x117mm	0.03	25	400	1,50€
14858	Ø 8.5x117mm	0.04	25	400	1,50€
14859	Ø 9x125mm	0.04	25	400	1,50€
14860	Ø 9.5x125mm	0.05	25	400	2,00€
14861	Ø 10x133mm	0.05	25	400	2,00€
14862	Ø 10.5x133mm	0.06	25	400	2,00€
14863	Ø 11x142mm	0.07	25	400	2,50€
14864	Ø 11.5x142mm	0.07	25	400	2,50€
14865	Ø 12x151mm	0.08	25	300	2,50€
14866	Ø 12.5x151mm	0.09	25	200	3,00€
14867	Ø 13x151mm	0.09	25	200	3,00€

1x34, 1.5x40, 2x49, 2.5x57, 3x61, 3.5x70, 4x75, 4.5x80, 5x86, 5.5x93, 6x93, 6.5x101, 7x109, 7.5x109, 8x117, 8.5x117, 9x125, 9.5x125, 10x133mm

1x34, 1.5x40, 2x49, 2.5x57, 3x61, 3.5x70, 4x75, 4.5x80, 5x86, 5.5x93, 6x93, 6.5x101, 7x109, 7.5x109, 8x117, 8.5x117, 9x125, 9.5x125, 10x133, 10.5x133, 11x142, 11.5x142, 12x151, 12.5x151, 13x151mm

1x34, 1.5x40, 2x49, 2.5x57, 3x61, 3.5x70, 4x75, 4.5x80, 5x86, 5.5x93, 6x93, 6.5x101, 7x109, 7.5x109, 8x117, 8.5x117, 9x125, 9.5x125, 10x133mm

JEU DE FORETS HÉLICOÏDAUX HSS-CO5 COBALT

N

54348 291,00€

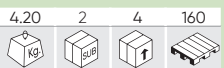

170 PCS HSS CO5
METAL 1-10 mm

54314 82,00€

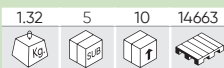

25 PCS HSS CO5
METAL 1-13 mm

54313 43,00€

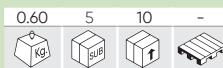

19 PCS HSS CO5
METAL 1-10 mm

PIÈCES DE RECHANGE DISPONIBLES

REF.	mm				€
16318	∅ 1x34mm	0.50	25	400	0,50€
16319	∅ 1.5x40mm	0.50	25	400	0,50€
16320	∅ 2x49mm	0.50	25	400	0,50€
16321	∅ 2.5x57mm	0.50	25	400	1,00€
16322	∅ 3x61mm	0.50	25	400	1,00€
16323	∅ 3.5x70mm	0.50	25	400	1,00€
16324	∅ 4x75mm	0.05	25	400	1,50€
16325	∅ 4.5x80mm	0.50	25	400	1,50€
16326	∅ 5x86mm	0.50	25	400	2,00€
16327	∅ 5.5x93mm	0.50	25	400	2,00€
16328	∅ 6x93mm	0.50	25	400	2,50€
16329	∅ 6.5x101mm	0.50	25	400	3,00€
16330	∅ 7x109mm	0.50	25	400	3,50€
16331	∅ 7.5x109mm	0.50	25	400	3,50€
16332	∅ 8x117mm	0.50	25	400	4,00€
16333	∅ 8.5x117mm	0.05	5	200	4,50€
16334	∅ 9x125mm	0.50	25	200	5,50€
16335	∅ 9.5x125mm	0.50	25	200	6,00€
16336	∅ 10x133mm	0.50	25	200	6,50€
16583	∅ 10.5x133mm	0.07	25	200	8,50€
16584	∅ 11x142mm	0.07	25	200	10,50€
16585	∅ 11.5x142mm	0.08	25	200	11,50€
16586	∅ 12x151mm	0.10	25	200	13,00€
16587	∅ 12.5x151mm	0.10	25	200	14,00€
16588	∅ 13x151mm	0.11	25	200	15,00€



1x34, 1.5x40, 2x49, 2.5x57, 3x61, 3.5x70, 4x75, 4.5x80, 5x86, 5.5x93, 6x93, 6.5x101, 7x109, 7.5x109, 8x117, 8.5x117, 9x125, 9.5x125, 10x133mm

1x34, 1.5x40, 2x49, 2.5x57, 3x61, 3.5x70, 4x75, 4.5x80, 5x86, 5.5x93, 6x93, 6.5x101, 7x109, 7.5x109, 8x117, 8.5x117, 9x125, 9.5x125, 10x133, 10.5x133, 11x142, 11.5x142, 12x151, 12.5x151, 13x151mm

1x34, 1.5x40, 2x49, 2.5x57, 3x61, 3.5x70, 4x75, 4.5x80, 5x86, 5.5x93, 6x93, 6.5x101, 7x109, 7.5x109, 8x117, 8.5x117, 9x125, 9.5x125, 10x133mm

53857 27,00€

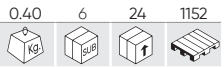

KIT S2 D'EMBOUITS À CHOC À CHANGEMENT RAPIDE – REVÊTEMENT NOIR

57 PCS S2



PRÉSENTOIR DE 6 UNITÉS



COMPREND

	x9	PH	25mm	1x3, 2x3, 3x3
	x9	PZ	25mm	1x3, 2x3, 3x3
	x4	H	25mm	3, 4, 5, 6
	x6	SL	25mm	4x2, 5x2, 6x2
	x14	TX	25mm	10x2, 15x2, 20x2, 25x2, 27x2, 30x2, 40x2
	x7	T	25mm	10, 15, 20, 25, 27, 30, 40
	x7		65mm	PH2, PH3, PZ1, PZ2, T20, T25, SL6
	x1		60mm	

* PEUT ÊTRE UTILISÉ ÉGALEMENT POUR REF. 60005

53858 28,80€

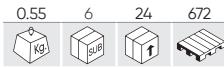

KIT S2 D'EMBOUITS À CHOC AVEC ADAPTATEURS – REVÊTEMENT NOIR

33 PCS S2



PRÉSENTOIR DE 6 UNITÉS



COMPREND

	x4	PH	25mm	1, 2x2, 3
	x3	PZ	25mm	1, 2, 3
	x4	H	25mm	3, 4, 5, 6
	x4	SL	25mm	3, 4, 5, 6
	x6	TX	25mm	10, 15, 20, 25, 30, 40
	x6		75mm	T15, T20, T25, PH2, PZ2, SL5
	x4		48mm	6, 7, 8, 10mm
	x1		60mm	
	x1		80mm	

* PEUT ÊTRE UTILISÉ ÉGALEMENT POUR REF. 60005

54346

11,50€

0.30	6	36	144

N

JEU DE 3 BROSSES DE NETOYAGE POUR PERCEUSE

3 PCS PP 1/4"

- A Ø 88mm
- B Ø 100mm
- C Ø 50mm



60037

JEU DE CLOUS SANS TÊTE

REF.	mm				€
53999	25x1,25mm	0.20	-	50	2,00€
54000	30x1,25mm	0.25	-	50	2,50€
54002	38x1,25mm	0.30	-	50	3,00€

1000 PCS



JEU D'AGRAFES À COURONNE ÉTROITE

REF.	mm				€
54008	25x6mm	0.45	-	40	3,50€
54010	32x6mm	0.55	-	40	4,50€
54011	38x6mm	0.65	-	40	5,00€

1000 PCS



60028
60049C

15014

20,00€

0.10	50	100	-

M14 115-230 mm

ÉCROU DE VERROUILLAGE RAPIDE M14 POUR MEULEUSE D'ANGLE



OUTILS ÉLECTRIQUES SANS FIL

À MÉTAL

REF.	POUR	DESCRIPTION					€
14893	60008	T42 - 115x2,5mm	0.05	50	100	-	2,00€
14894	60028	T42 - 125x2,5mm	0.05	50	200	-	1,20€
14895	60008	T27 - 115x6mm	0.15	25	100	-	1,90€
14896	60028	T27 - 125x6mm	0.78	25	100	-	2,10€

ACIER INOXYDABLE

REF.	POUR	DESCRIPTION					€
14897	60008	T41 - 115x1mm	0.01	50	400	-	0,88€
14898	60028	T41 - 125x1mm	0.03	50	400	-	0,98€
14899	60008	T41 - 115x1,6mm	0.03	50	400	-	0,88€
14900	60028	T41 - 125x1,6mm	0.04	50	400	-	0,98€



14893

T27	80 m/s	13300 RPM
Ø115mm	Ø22,23mm	



14894

T42	80 m/s	12200 RPM
Ø125mm	Ø22,23mm	



14897

T41	80 m/s	13300 RPM
Ø115mm	Ø22,23mm	



14898

T41	80 m/s	12200 RPM
Ø125mm	Ø22,23mm	



14895

T42	80 m/s	13300 RPM
Ø115mm	Ø22,23mm	



14896

T27	80 m/s	12200 RPM
Ø125mm	Ø22,23mm	



14899

T41	80 m/s	13300 RPM
Ø115mm	Ø22,23mm	



14900

T41	80 m/s	12200 RPM
Ø125mm	Ø22,23mm	



À MÉTAL (ACIER INOXYDABLE, ALUMINIUM, CUIVRE)

REF.	POUR	DESCRIPTION					€
14988	60007	24T 165mm	0.25	20	40	2400	8,00€
14989	60011	24T 115mm	0.10	20	100	3600	6,00€
14990	60022	40T 185mm	0.30	20	40	2200	10,50€
14993	60010	T118A	0.05	20	200	7200	5,00€
14995	60019	150mm 24TPI	0.05	20	200	8400	8,00€

À BOIS

REF.	POUR	DESCRIPTION					€
14985	60007	24T 165mm	0.25	20	40	2400	6,00€
14986	60011	24T 115mm	0.10	20	100	3600	4,00€
14987	60022	40T 185mm	0.30	20	40	2200	8,50€
14991	60010	T244D	0.05	20	200	7200	2,00€
14994	60019	150mm 6TPI	0.05	20	200	8400	3,50€



14989

	x24	7000 RPM
Ø115mm	Ø10mm	



14988

	x24	7000 RPM
Ø165mm	Ø20mm	



14990

	x40	7000 RPM
Ø185mm	Ø25,4mm	



14955

	24TPI	10mm CORTE HA HA CUT
150mm		



14994

	6TPI	150mm CORTE HA HA CUT
150mm		



14991

	T244D	100mm CORTE HA HA CUT
100mm		



14993

	T118A	8mm CORTE HA HA CUT
76mm		



14986

	x24	7000 RPM
Ø115mm	Ø10mm	



14985

	x24	7000 RPM
Ø165mm	Ø20mm	



14987

	x40	7000 RPM
Ø185mm	Ø25,4mm	

ÉCLAIRAGE

- 130 LAMPES D'INSPECTION
- 132 LAMPES FRONTALES
- 134 LAMPE À LOUPE LED
- 135 INONDATION LED
- 136 BONNET D'ÉCLAIRAGE
- 137 BALISES
- 139 LAMPE DE TRAVAIL LED
- 142 SIGNALISATION
- 144 ACCESSOIRES ET PIÈCES DÉTACHÉES

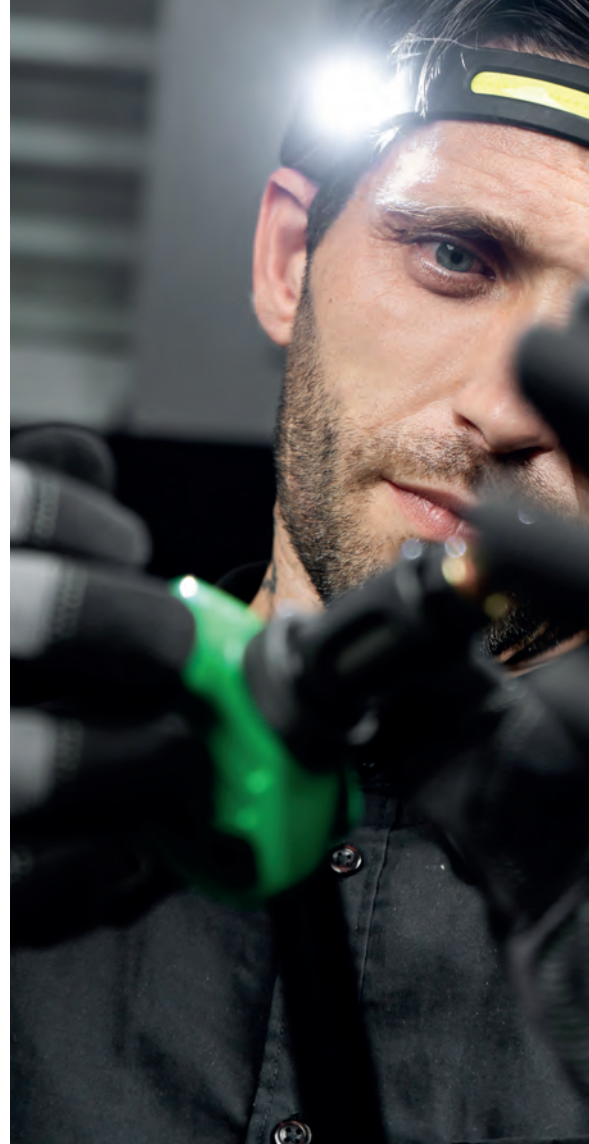

53734

23,70€

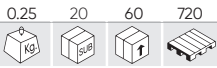

LAMPE DE TRAVAIL - 400LM

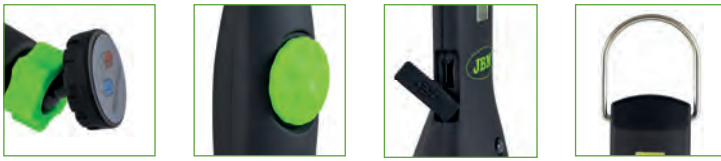

BASE ROTATIVE
360°
MAGNÉTISÉE

SÉLECTEUR
D'INTENSITÉ
LUMINEUSE

CHARGEUR USB

AVEC CROCHET



LED COB
400Lm - 2,5H

LED COB
30Lm - 10H

LI-ION
3.7V 2.600mah



PRÉSENTOIR
DE 20 UNITÉS



53519

42,00€

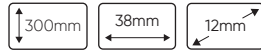
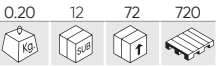

LAMPE DE TRAVAIL PORTATIVE ULTRA COMPACTE



150Lm - 4H

300Lm - 2H

LI-POLI
3.7V 800mA

LED
3W COB

100V
240V

50-60
Hz

6500± 400
KELVIN

IP
44

68-71
ICR

5V
0.6A



PRÉSENTOIR
DE 12 UNITÉS

52536

57,00€

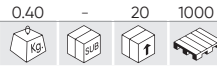

LAMPE DE TRAVAIL EXTRA PLATE LED COB AVEC BATTERIE RECHARGABLE

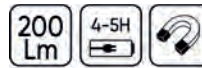

INTENSITY 1
3H

INTENSITY 2
4H

LITHIUM
3.7V 1.900mA

LED
2W COB



DISEÑO REGISTRADO
REGISTERED DESIGN



51889

49,00€

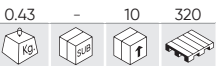

LAMPE DE TRAVAIL ATELIER 24+6 LEDS AVEC BATTERIE RECHARGABLE/DOUBLE AIMANT ARRIERE ET BASE AIMANTÉE

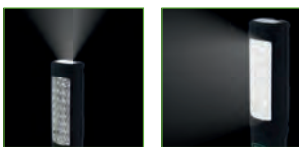

80
Lm

3-4H

80Lm - 5H

LED
24+6

LITHIUM
3.7V 2200mah



53216

49,00€

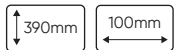
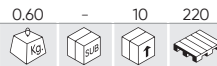

LAMPE DE TRAVAIL LED COB AVEC BASE FLEXIBLE



170Lm - 4H

LED
2W COB

LITHIUM
3.7V 2.000mA

LITHIUM
5V 1000mA



BALADEUSE D'ATELIER AVEC BASE AIMANTÉE ARTICULÉE

54122 38,00€

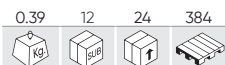

300 Lm	3-4H		
LED 3W - 7H	COB 3W - 2,5H		
LITHIUM 3.7V 2.000mA	6500± 400 KELVIN		
IP 44	68-71 ICR	100V 240V	5V 1A

54123 40,00€

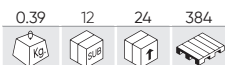

500 Lm	6-7H		
LED 3W - 14H	COB 5W - 3H		
LITHIUM 3.7V 4.000mA	6500± 400 KELVIN		
IP 44	68-71 ICR	100V 240V	5V 1A

54124 47,00€

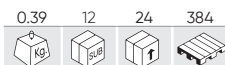

1000 Lm	6-8H		
LED 3W - 14H	COB 10W - 3H		
LM 1000 5min	900 30min	700 145min	
LITHIUM 3.7V 4.000mA	6500± 400 KELVIN		
IP 44	68-71 ICR	100V 240V	5V 1A



PRÉSENTOIR DE 12 UNITÉS

REF. DESCRIPTION

14031 ADAPTATEUR RÉSEAU USB

54379

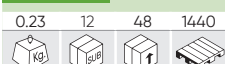

LAMPE DE TRAVAIL COB RECHARGEABLE SOLAIRE

28,00€

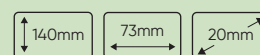

N

80-800 Lm	5,2V	0,5W	
3,5H	4-12H	BANCO DE ENERGIA POWER BANK	
80Lm 3W COB	800Lm 10W COB		
x1 LI-POLI 3.7V - 4000mAh			

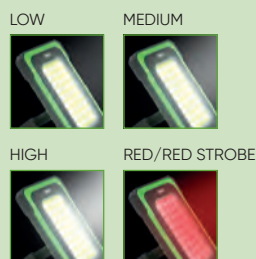

PRÉSENTOIR DE 12 UNITÉS

53776



LAMPE DE TRAVAIL DE POCHE AVEC BATTERIE

19,10€



90 Lm	300 Lm	2,5H	
300Lm 5W COB - 3H	LI-ION 3.7V 1500mah		
250Lm 3W COB - 3,5H	ABS	TPR	
90Lm 3W LED - 6H			



PRÉSENTOIR DE 12 UNITÉS



250LM 3W COB

300LM 5W COB

90LM 3W LED



54344

10,50€

0,10	10	100	1200

CHAPEAU POUR LAMPE FRONTALE LED

120 Lm	60 Lm	25 Lm
--------	-------	-------

LM 120	60	25
40min	6-8h	8-10h

3.7V 250mAh	2H
-------------	----

LUZ DISPERSA SCATTERED LIGHT	1W
---------------------------------	----

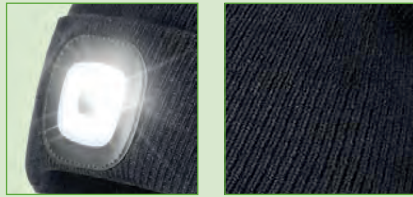

DISPOSITIF LUMINEUX AMOVIBLE

POLYESTER (65%)
ACRYLIQUE (35%)



N

52987

20,00€

0,17	10	40	720

LAMPE DE TRAVAIL DE POCHE AVEC BATTERIE

120 Lm	2,5H
--------	------

120Lm - 2,5H	
--------------	--

LITHIUM 3.7V 1.000mAh	LED 3W COB
--------------------------	---------------



PRÉSENTOIR DE 10 UNITÉS



160mm	30mm	20mm
-------	------	------



53780

14,50€

0,45	5	20	300

LAMPE DE TRAVAIL LED 400LM

400 Lm	6W	220V 240V
--------	----	--------------

IP 20	50 Hz
-------	-------

6000± 7000 KELVIN

H05RN-F 2x0.75mm ² - 5m

CÂBLE D'ALIMENTATION DE 2,5M



52384

29,00€

0,33	-	20	600

LAMPE DE TRAVAIL EXTRAPLATE AVEC LED COB

- Longueur du CÂBLE : 5m
- Longueur du CÂBLE DC : 0,1m
- Longueur de CÂBLE DC jusqu'à pinces : 0,3m

200 Lm	12V 24V
--------	------------

LED 3W COB

75mm	325mm	90mm
------	-------	------



53217

47,00€

0,30	-	20	620

LAMPE DE TRAVAIL LED COB PORTABLE AVEC BASE AIMANTÉE

200 Lm	4H
--------	----

LED 2W COB	
---------------	--

LITHIUM 3.7V 2.200mah

LITHIUM 5V 1.000mah



45mm	380mm
------	-------

54004

16,00€

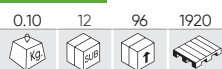

PORTATIF À LUMIÈRE FRONTALE DE TÊTE COB

COB 350Lm - 5W COB	LED 90Lm - 3W XPE
COB 350Lm - 2,5H 150Lm - 5 H Flash - 8 H	LED XPE 150Lm - 4H 60Lm - 8 H
LI-ION 3.7V 1.200mA	Gel de silice Silica gel
2m	IP X4



BOUTON DE CAPTEUR DE MOUVEMENT

Appuyez pour activer/ désactiver.
Passez votre main devant le bouton pour allumer et éteindre la lumière.

- Matériau: gel de silice
- Indicateur de puissance, indicateur d'induction
- Mode d'activation du capteur de mouvement
- Câble de chargement USB inclus



PRÉSENTOIR DE 12 UNITÉS



XPE LED



COB



COB FLASH

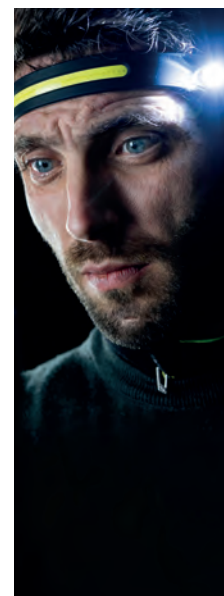

53569

18,00€



PORTATIF À LUMIÈRE FRONTALE DE TÊTE 800 LM (COB + CREE)

RÉGULATEUR DE MISE AU POINT

3 MODES D'ÉCLAIRAGE

BATTERIES RECHARGEABLES

INDICATEUR DE LUMIÈRE ALLUMÉE



MAX 800 Lm	2,5H	150m
LED COB + CREE	x2 18650	
High Low Flash COB		



53568

12,00€



PORTATIF À LUMIÈRE FRONTALE DE TÊTE 350 LM

RÉGULATEUR DE MISE AU POINT

3 MODES D'ÉCLAIRAGE

MAX 350 Lm	2,5H	150m
High Low Flash SOS		
LI-ION 2000mAh		



54267

9,50€

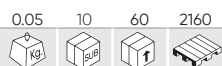

GANT LUMINEUX À LAMPES LED

70 Lm	120 mAh	+20H
LED	DERECHA RIGHT	
x2 CR2016 INCLUIDAS / INCLUDED		
x2 LED 3.0V		



ÉCLAIRAGE

53974

38,00€

0.75 5 20 240

LAMPE DE TRAVAIL RECHARGEABLE

1500 Lm
5-6H **100%** **50%**
2.5H 6H
LED 20W COB **ABS**
100% SOS **50% FLASH**

4 MODES D'ÉCLAIRAGE
 100% 50% SOS FLASH



MULTIPOSITION



37mm 240mm 225mm

52555

2,38€

0.03 48 192 3456

LAMPE TORCHE 9 LEDS



27 Lm **x9 LED** **x3 AAA**
 30mm 93mm PRÉSENTOIR DE 12 UNITÉS

52558

2,38€

0.03 48 192 3072

51326

4,40€

0.07 12 144 2880

LAMPE TORCHE 21 LEDS



63 Lm **x21 LED** **x3 AAA**
 95mm 35mm PRÉSENTOIR DE 12 UNITÉS

PILES DE RECHANGE

REF.	DESCRIPTION					€	
51258	"AAA" R03 1,5V	0.01	60	2400	134400	0,15€	

POUR REF. 51326, 52233, 52555, 52558

REF.	DESCRIPTION					€	
10923	9V	0.05	10	500	-	1,10€	

POUR REF. 52162, 52450, 51929, 50942

53427

5,00€

0.05 12 96 3456

TORCHE STYLO 6 LED'S AIMANTÉ



PRÉSENTOIR DE 12 UNITÉS

45 Lm **x6 LED** **x3 AAA**



51573

2,50€

0.07 12 96 3168

LAMPE DINAMO 2 LEDS



6 Lm **x2 LED**

PRESENTATION EN BOITE INDIVIDUELLE



53227

28,00€

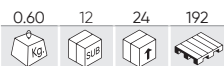

LOUPE LED DE TABLE

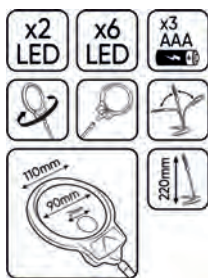

53085

30,00€

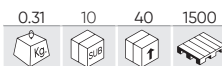

LED LOUPE

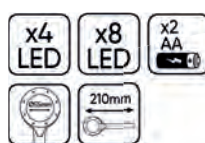

TRÉPIED POUR LA LANTERNE LED

REF.	Max.	Min.				€
53506	1830mm	840mm	2.40	-	8	36,00€
52254	2770mm	1290mm	3.51	-	4	64,00€



53505

77,00€



LANTERNE LED DE 50W



54039

154,00€

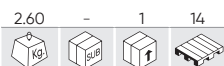

LAMPE LED INDUSTRIELLE

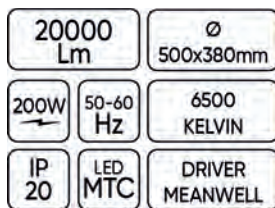

54133

547,00€



JEU DE 6 LAMPES À LED INDUSTRIELLES 54039

6 PCS



REF. DESCRIPTION

15385 ABAT-JOUR DE RECHANGE POUR REF.54039

54088

132,00€



LAMPE LED INDUSTRIELLE



ÉCLAIRAGE

54270

42,00€

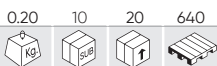

580mm

LAMPE LED AVEC SUPPORT MAGNÉTIQUE

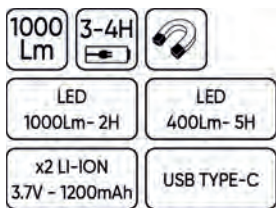

54271

54,00€

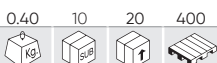

1200-1800mm

BARRE LED MAGNÉTIQUE AVEC SANGLE DE CAPOT



ARTICULÉ

53707

153,00€



1050mm

LAMPE LED AVEC SUPPORT MAGNÉTIQUE

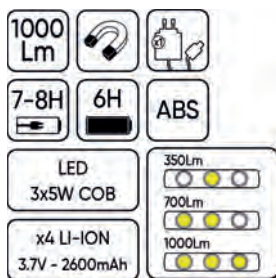

3 MODES D'ÉCLAIRAGE
BATTERIE RECHARGEABLE
LUMIÈRES QUI INDIQUENT L'ÉTAT DE LA BATTERIE

AUGMENTER CONSIDÉRABLEMENT LA VISIBILITÉ DANS LA ZONE DE TRAVAIL

PERMET DE DIRIGER L'AMPOULE INDIVIDUELLEMENT SI NÉCESSAIRE

AVEC SUPPORT MAGNÉTIQUE POUR S'ADAPTER À TOUTES LES SITUATIONS



53570

154,00€



1170-1750mm

LAMPE LED D'INSPECTION SOUS CAPOT

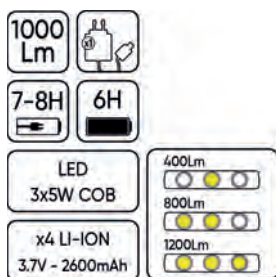

3 MODES D'ÉCLAIRAGE
BATTERIE RECHARGEABLE
LUMIÈRES QUI INDIQUENT L'ÉTAT DE LA BATTERIE

AUGMENTER CONSIDÉRABLEMENT LA VISIBILITÉ DANS LA ZONE DE TRAVAIL

PERMET DE DIRIGER L'AMPOULE INDIVIDUELLEMENT SI NÉCESSAIRE



54173 87,00€

0.75 5 20 240

GYROPHARE RECHARGEABLE V BASE MAGNÉTIQUE

- FONCTIONS:
FONCTION 1: CLIGNOTANT
FONCTION 2: DOUBLE CLIGNOTANT
FONCTION 3: ROTATION

20W 5V x45 LED

PC ABS 2-3H 2-3H

LI-ION 7.4V - 2200mA -30°C 50°C IP 65



REF. DESCRIPTION

REF.	DESCRIPTION	0.05	10	100	€
16053	CÂBLE USB TYPE A / FICHE RONDE 5.5MM				2,85€

54172 81,00€

0.80 5 20 240

GYROPHARE RECHARGEABLE BASE FLEXIBLE

- FONCTIONS:
FONCTION 1: CLIGNOTANT
FONCTION 2: DOUBLE CLIGNOTANT
FONCTION 3: ROTATION

20W 5V x45 LED

PC ABS 2-3H 2-3H

LI-ION 7.4V - 2200mA -30°C 50°C IP 65



REF. DESCRIPTION

REF.	DESCRIPTION	0.05	10	100	€
16052	CÂBLE USB TYPE A / FICHE RONDE 3.5MM				2,09€

53691 36,00€

0.70 - 20 320

GYROPHARE LED MAGNÉTIQUE

- FONCTIONS:
FONCTION 1: CLIGNOTANT
FONCTION 2: DOUBLE CLIGNOTANT
FONCTION 3: ROTATION



53690 34,00€

0.55 - 20 200

GYROPHARE LED 12-24V BASE FLEXIBLE

- FONCTIONS:
FONCTION 1: CLIGNOTANT
FONCTION 2: DOUBLE CLIGNOTANT
FONCTION 3: ROTATION



x8 LED 18W 12V 24V IP 66

112mm Ø 125cm -30°C 50°C

4m PC ECE R10 ECE R65



x8 LED 18W 12V 24V IP 66

182mm Ø 125cm -30°C 50°C

PC ECE R10 ECE R65



52375 38,00€

0.70 - 20 240

170mm Ø140mm

GYROPHARE 6 FONCTIONS À LED 12-24V AVEC PRISE ALLUME-CIGARE

- LENTILLE ABS-BAES.
- TULIPE ANTI-RUPTURE.
- CÂBLE: SPIRAL DE 2,5M AVEC PRISE ALLUME-CIGARE.
- CONSOMATION: 9W.

- FONCTIONS:
FONCTION 1: ROTATION
FONCTION 2: DOUBLE ÉCLAIR
FONCTION 3: 6 ÉCLATS

12V 24V 9W

170mm Ø 140cm IP 56

2,5m PC/ABS ECE R10



BASE MAGNÉTIQUE

52456 36,00€

0.60 - 20 160

240mm Ø128mm

GYROPHARE LED 12-24V BASE FLEXIBLE

- LENTILLE PC.
- TULIPE ANTI-RUPTURE.
- CONSOMATION: 8W.

- FONCTIONS:
FONCTION 1: ROTATION
FONCTION 2: DOUBLE ÉCLAIR
FONCTION 3: 6 ÉCLATS

12V 24V 8W PC/ABS

240mm Ø 128cm IP 56

ECE R10



ABS - BAES
BASE FLEXIBLE

ÉCLAIRAGE

51964

28,00€

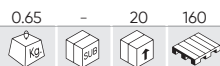

GYROPHARE AVEC TIGE FLEXIBLE H1 12V 55W



Tulipe antirupture
Lentille: PC
Fil de la lentille avec scellage durable
T/min : 40
Système de pignon/vis sans fin
Ampoule H1, 12 V 55 W
Avec base filetée
Consommation de courant : 3.0 Amp



ABS - BAES
BASE FLEXIBLE

51965

29,50€



GYROPHARE AVEC TIGE FLEXIBLE H1 24V 70W



Tulipe antirupture
Lentille: PC
Fil de la lentille avec scellage durable
T/min : 40
Système de pignon/vis sans fin
Ampoule H1, 24V 70W
Avec base filetée
Consommation de courant : 3.0 Amp



ABS - BAES
BASE FLEXIBLE

51962

25,00€

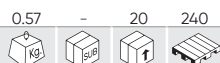

GYROPHARE SANS CABLE H1 12V 55W



Tulipe antirupture
Coque ABS - BAES
Fil de la coque avec scellage durable
T/min : 40
Système de pignon/vis sans fin
Ampoule H1, 12V 55W
Consommation de courant : 3.0 A



51963

29,00€



GYROPHARE SANS CABLE H1 24V 70W



Tulipe antirupture
Coque ABS - BAES
Fil de la coque avec scellage durable
T/min : 40
Système de pignon/vis sans fin
Ampoule H1, 24V 70W
Consommation de courant : 3.0 A



51960

34,00€



GYROPHARE AVEC CÂBLE AIMANTÉ H1 12V-55W



Coque ABS - BAES
Bord coque avec scellage durable
T/min : 40
Système de pignon/vis sans fin
Ampoule H1 12V 55W
Câble : Spirale de 4 m avec prise d'allume-cigare.
Consommation de courant : 3.0 A



51961

34,00€



GYROPHARE AVEC CÂBLE AIMANTÉ H1 24V 70W



Coque ABS - BAES
Bord coque avec scellage durable
T/min : 40
Système de pignon/vis sans fin
Ampoule H1 24V 70W
Câble : Spirale de 4 m avec prise d'allume-cigare.
Consommation de courant : 3.0 A



GYROPHARE SCINTILLANT

REF.						€
52827		0.50	-	20	400	46,00€
52828		0.54	-	20	320	43,00€
52910		0.50	-	20	320	39,00€

- AVEC 3 INTERRUPTEURS DE FONCTION.
- 3 MODES INTERMITTENTS:
ROTATION
6 ÉCLATS
MODE DOUBLE FLASH



51966



GYROPHARE SCINTILLANT 12 V-110 V



- Lentille ABS - BAES.
- XÉNON.
- Consommation de courant: 3.0 A.



BASE EN TULIPE FILETÉE

18,00€

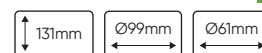

ACCÉSSOIRES POUR SERVANTES

REF.	DESCRIPTION				€
11103	LAMPE RECHANGE POUR 51966	0.01	-	100	6,00€
10766	LAMPE RECHANGE POUR 51960, 51962	0.01	-	200	1,59€
10750	CONNECTEUR POUR GYROPHARE AVEC REF. 51964, 51965, 52456	0.25	-	50	13,00€
10751	CONNECTEUR DE LAMPE POUR GYROPHARE REF. 51964, 51965, 52300 ET 52456	0.30	-	50	15,00€
52843	BARRE DE LUMIERE EXTENSIBLE POUR FAIRE TOURNER	0.90	-	20 1500	31,60€
51969	COQUE ORANGE GYROPHARE POUR REF. 51960, 51961, 51964	0.12	-	50 1000	14,00€
11324	COQUE BLEU POUR GYROPHARE REF. 51960, 51961, 51964	0.13	-	100	17,50€
11325	COQUE DE GYROPHARE ROUGE POUR REF. 51960, 51961, 51964	0.12	-	50 451	17,50€

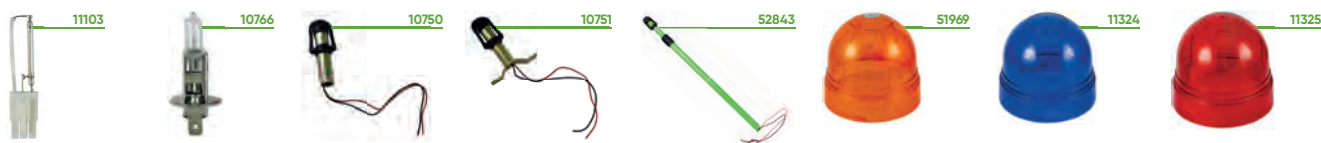

PROJECTEUR DE TRAVAIL LUMIÈRE DISPERSÉE

53428

18,00€

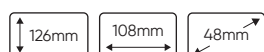

53429

18,00€

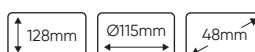

ÉCLAIRAGE

52566

28,00€

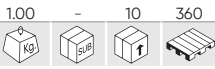

1450 Lm x9 LED 27W 10V/40V
 +30.000H IP 68
 LUZ DISPERSA SCATTERED LIGHT AI

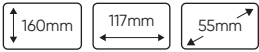

52567

29,00€

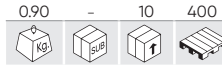

1450 Lm x9 LED 27W 10V/40V
 +30.000H IP 68
 LUZ DISPERSA SCATTERED LIGHT AI

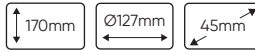

52302

25,40€

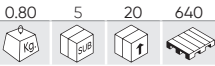

1450 Lm x9 LED 27W 10V/40V
 +30.000H IP 68
 LUZ DISPERSA SCATTERED LIGHT AI

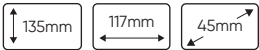

52303

26,40€

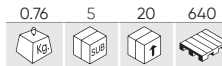

1450 Lm x9 LED 27W 10V/40V
 +30.000H IP 68
 LUZ DISPERSA SCATTERED LIGHT AI

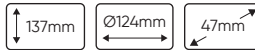

53049

89,00€

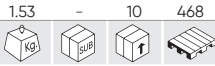

3600 Lm x4 LED 40W 9V/36V
 +30.000H IP 68
 LUZ DISPERSA SCATTERED LIGHT AI



53052

158,00€

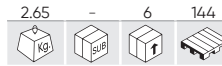

7200 Lm x8 LED 80W 9V/36V
 +30.000H IP 68
 LUZ DISPERSA SCATTERED LIGHT AI

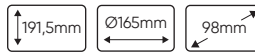

53045

35,00€

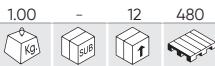

2800 Lm x16 LED 48W 10V/40V
 +20.000H IP 67
 LUZ DISPERSA SCATTERED LIGHT AI

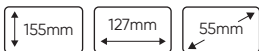

53046

39,00€

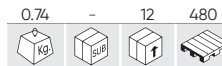

2272 Lm x16 LED 24W 9V/36V
 +20.000H IP 68
 LUZ DISPERSA SCATTERED LIGHT AI

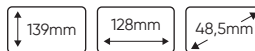

PROJECTEUR DE TRAVAIL LUMIÈRE CONCENTRÉE

52568

28,00€

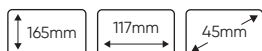
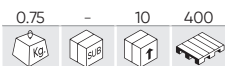

52569

28,00€

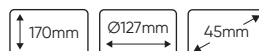

53048

89,00€

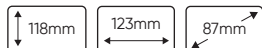

53051

158,00€

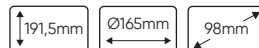

52415

19,00€

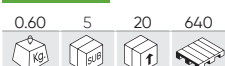

52414

19,00€

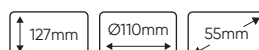

53047

330,00€



GIRATOIR

VITESSE RÉGLABLE DE MOUVEMENT

DISTANCE TÉLÉCOMMANDÉE 100M

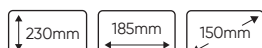

ÉCLAIRAGE

54161 90,00€

2.75 - 6 48

2100mm

RAMPE D'ÉCLAIRAGE TÉLESCOPIQUE DE 1,4 A 2,1M



RÈGLEMENT	HOMOLOGATION
3	E9*3R02/17*23444*00
4	E9*4R00/19*23444*00
6	E9*6R01/29*23444*00
7	E9*7R02/27*23444*00
10	E9*10R06/00*22232*02

x42 LED 12V 24V IP 65

7 PIN 7,5m

54163 80,00€

1.85 - 6 54

140mm 1100mm

RAMPE D'ÉCLAIRAGE DE REMORQUE 1.100MM X 140MM LED



RÈGLEMENT	HOMOLOGATION
3	E9*3R02/17*23444*00
4	E9*4R00/19*23444*00
6	E9*6R01/29*23444*00
7	E9*7R02/27*23444*00
10	E9*10R06/00*22232*02

x42 LED 12V 24V IP 65

7 PIN 5m

50910 45,00€

1.90 - 6 54

140mm 1100mm

RAMPE D'ÉCLAIRAGE REMORQUE DE 1100X140MM



RÈGLEMENT	HOMOLOGATION
4	E4*4R-0024080
6	E4*6R-0124080
7	E4*7R-0224080
10	E9*10R06/02*23498*00

12V 7 PINS

LED HDPE

52838 56,00€

1.85 - 6 54

140mm 1100mm

RAMPE D'ÉCLAIRAGE REMORQUE DE 1.100MM X 140MM LED



HOMOLOGATION
E4*7R-0218756

12V 7 PINS

LED HDPE

KIT DE SIGNALISATION ARRIÈRE AIMANTÉ LED

LISSE: 7,5M
SPIRALE: 2,5M

54162 81,00€

1.50 - 6 144

x42 LED 12V 24V IP 65

7 PINS



HOMOLOGATION
E9*7R02/27*23444*00



51886 44,00€

1.50 - 8 112

12V 7 PINS



RÈGLEMENT	HOMOLOGATION
3	E4*3R-023749
4	E4*4R-0024080
6	E4*6R-0124080
7	E4*7R-0224080
10	E9*10R06/02*23498*00

52839 64,00€

1.47 - 8 128

12V 7 PINS



RÈGLEMENT	HOMOLOGATION
3	E4*3R-0218756
4	E4*4R-0018756
6	E4*6R-0118756
7	E4*7R-0218756
10	E9*10R06/02*23199*01

54044

99,00€



JEU DE DEUX FEUX ARRIÈRE MAGNÉTIQUES SANS FIL



HOMOLOGATION

E9*10R05/01*16210*02

53151

14,00€



FEU LED POUR REMORQUES



- 4 fonctions:
- Bleu: Position et plaque d'immatriculation.
 - Rouge: feu de freinage.
 - Jaune: Clignotant.
 - Blanc: Masse.

FEU LED POUR REMORQUES

REF.					€
54160L	GAUCHE	0.20	5	20	17,50€
54160R	DROITE	0.20	5	20	17,50€

- 4 fonctions:
- Noire: Position et plaque d'immatriculation.
 - Rouge: feu de freinage.
 - Vert: Clignotant.
 - Blanc: Masse.

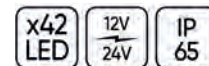

HOMOLOGATION

E9*7R02/27*23444*00

E9*10R06/01*23199*00

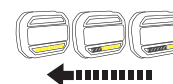

53536

34,00€



TESTEUR FAISCEAUX D'ATLAGE 7/13 PINS



REF. DESCRIPTION

REF.	DESCRIPTION					€
14753	EXTENSION À 7 BROCHES POUR LA RÉF. 53536	0.20	-	50	-	13,00€

51929

22,00€



TESTEUR FAISCEAUX D'ATLAGE 7 PINS



PRISE REMORQUE

PRISE VÉHICULE

ÉCLAIRAGE

ALARME DE RECUL 12V-80V

REF.	DB	IP	V	°C				€
51967	97DB	IP65	12V-80V	-30/70°C	0.20	50	1200	16,00€
51968	107DB	IP65	12V-80V	-30/70°C	0.23	50	1000	16,00€



- Résistant à différentes conditions climatiques.
- Possibilité de le laver avec de l'eau à pression.
- Protégé face aux polarités inverses.
- Scellage avec des résines époxy.



54078



68,00€



FEU DE SÉCURITÉ POUR CHARIOT ÉLÉVATEUR



Lampe de sécurité de forme ovale avec 2 diodes émettrices bleu foncé. La lampe projette une lumière bleu foncé directionnelle sur le sol pour avertir les passants.

Grâce à une telle lumière d'avertissement, on pourra éviter des collisions et des accidents impliquant les chariots élévateurs et les gens, tout en renforçant la sécurité dans les conditions de travail, en particulier dans les zones mortes. Idéale pour les environnements obstrués.



CHARGEUR ALLUME-CIGARE ET TRANSFORMATEUR

REF.	DESCRIPTION					€
10961	TRANSFORMATEUR SECTEUR POUR REF. 51889 ET 52257	0.08	-	50	-	13,00€
11107	ALLUME-CIGARE POUR RÉF. 51889	0.06	-	250	-	4,50€
11989	PRISE ALLUME-CIGARE POUR BALADEUSE ATELIER AVEC REF. 52536	0.04	-	200	-	2,00€
13839	ADAPTATEUR DE PRISE DE COURANT USB 110V/60HZ	0.04	-	200	-	8,50€
14031	ADAPTATEUR RÉSEAU USB	0.10	10	100	1152	7,90€
14032	ADAPTATEUR USB POUR ALLUME-CIGARES	0.10	10	100	1200	12,00€
14033	CÂBLE USB TYPE A / MICRO-B	0.10	10	100	500	4,50€
16052	CÂBLE USB TYPE A / FICHE RONDE 3.5MM	0.05	10	100	-	2,09€
16053	CÂBLE USB TYPE A / FICHE RONDE 5.5MM	0.05	10	100	-	2,85€



OUTILS PNEUMATIQUES

- 147 VISSAGE
- 151 PERÇAGE
- 152 DÉCOUPAGE / SERVANT
- 153 SABLAGE/POLISSAGE
- 156 SOUFFLETTES À AIR
- 158 ENTRETIEN DES PNEUS
- 160 AUTRES
- 163 ENROULEUR DE TUYAU À AIR
- 165 TUYAUX DE RACCORDEMENT
- 166 ACCESSOIRES ET CONSOMMABLES



JBM RECOMMANDE L'UTILISATION DE SES HUILES LUBRIFIANTES POUR OPTIMISER LES PERFORMANCES ET PROLONGER LA VIE DE L'OUTIL

REF.14534 REF.14560

PAGE 161



53520

228,00€

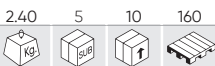

CLÉ À CHOC 1/2" (1756NM) - COMPOSITE



COMPOSITE
1756Nm



REF.	DESCRIPTION	kg	SUB	QTY	€
14121	TROUSSE DE RÉPARATION POUR OUTILS PNEUMATIQUES - 51207 / 53520	0.75	-	20	26,00€

51207

289,00€



COFFRET CLÉ À CHOCS COMPOSITE 1/2" + DOUILLES



COMPOSITE
1756Nm

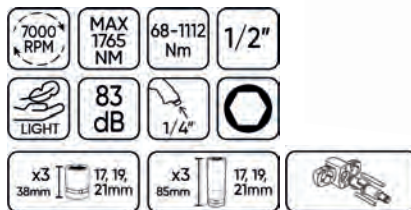

REF.	DESCRIPTION	kg	SUB	QTY	€
14121	TROUSSE DE RÉPARATION POUR OUTILS PNEUMATIQUES - 51207 / 53520	0.75	-	20	26,00€

51206

228,00€

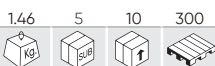

CLÉ À CHOC MINI 1/2" COMPOSITE



COMPOSITE
1302Nm

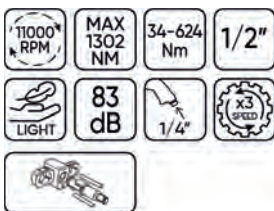

REF.	DESCRIPTION	kg	SUB	QTY	€
14120	TROUSSE DE RÉPARATION POUR OUTILS PNEUMATIQUES - 51206	0.15	-	5	22,00€

53588

178,00€



CLÉ À CHOC NANO 1/2" (1302NM)



1302Nm

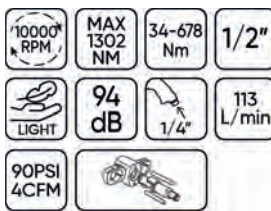

REF.	DESCRIPTION	kg	SUB	QTY	€
14165	TROUSSE DE RÉPARATION POUR OUTILS PNEUMATIQUES - 53588	0.05	-	20	26,50€

JBM RECOMMANDE L'UTILISATION DE SES HUILES LUBRIFIANTES POUR OPTIMISER LES PERFORMANCES ET PROLONGER LA VIE DE L'OUTIL

REF.14534 REF.14560

PAGE 161



53733 238,00€

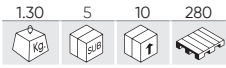

CLÉ PNEUMATIQUE ANGULAIRE À CHOC 1/2"



650Nm



REF.	DESCRIPTION	kg	L	cm	mm	€
14633	TROUSSE DE RÉPARATION POUR OUTILS PNEUMATIQUES - 53733	0.03	-	20		22,50€

54340 296,00€



N

CLÉ À CHOC ARTICULÉE 1/2"



813 Nm



REF.	DESCRIPTION	kg	L	cm	mm	€
16341	TROUSSE DE RÉPARATION POUR OUTILS PNEUMATIQUES - 54340	0.07	-	15		32,50€

54397 249,00€

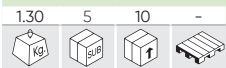

N

CLÉ À CHOCS COMPACTE DE 1/2"



1004Nm



REF.	DESCRIPTION	kg	L	cm	mm	€
16564	TROUSSE DE RÉPARATION POUR OUTILS PNEUMATIQUES - 54397	0.10	-	20		17,00€

53689 238,00€

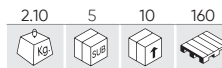

CLÉ À CHOC 1/2" (1950NM) - COMPOSITE



COMPOSITE
1950Nm

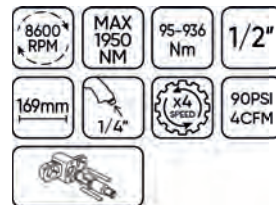

REF.	DESCRIPTION	kg	L	cm	mm	€
14618	TROUSSE DE RÉPARATION POUR OUTILS PNEUMATIQUES - 53689	0.01	-	20		19,00€

53608

98,00€

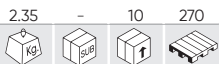

CLÉ À CHOC 1/2" 1200NM

1200Nm

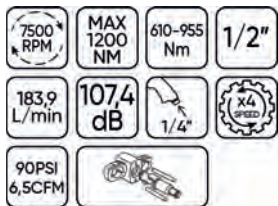

REF.	DESCRIPTION	kg	box	unit	€
14583	TROUSSE DE RÉPARATION POUR OUTILS PNEUMATIQUES - 53608	0.01	-	20	6,00€

53726

128,00€



CLÉ À CHOC 1/2" 1650NM

1650Nm

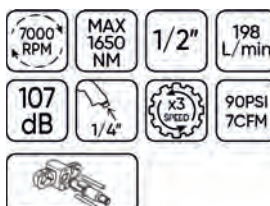

REF.	DESCRIPTION	kg	box	unit	€
15564	KIT DE RÉPARATION D'OUTILS PNEUMATIQUES - 53726	0.05	-	-	11,90€

51212

488,00€



CLÉ À CHOC 3/4" COMPOSITE

2034Nm

COMPOSITE



REF.	DESCRIPTION	kg	box	unit	€
14122	TROUSSE DE RÉPARATION POUR OUTILS PNEUMATIQUES - 51210 / 51212	1.12	-	50	34,00€

51211

560,00€



CLÉ À CHOC 1" COMPOSITE

2034Nm

COMPOSITE

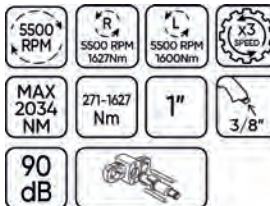

REF.	DESCRIPTION	kg	box	unit	€
14123	TROUSSE DE RÉPARATION POUR OUTILS PNEUMATIQUES - 51211 / 51213	1.16	-	20	33,00€

51210

650,00€



CLÉ À CHOC COMPOSITE 3/4" BROCHE LONGUE 15CM

2034Nm

COMPOSITE

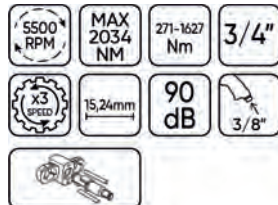

REF.	DESCRIPTION	kg	box	unit	€
14122	TROUSSE DE RÉPARATION POUR OUTILS PNEUMATIQUES - 51210 / 51212	1.12	-	50	34,00€

51213

690,00€



CLÉ À CHOC COMPOSITE 1" BROCHE LONGUE 19CM

2034Nm

COMPOSITE

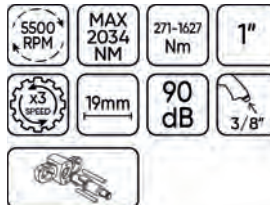

REF.	DESCRIPTION	kg	box	unit	€
14123	TROUSSE DE RÉPARATION POUR OUTILS PNEUMATIQUES - 51211 / 51213	1.16	-	20	33,00€

53681 743,00€

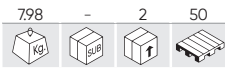

CLÉ D'IMPACT SPÉCIAL POUR LES CAMIONS 1" - ULTRA LÉGER



2441Nm



REF.	DESCRIPTION	kg	Box	Pallet	€
14336	TROUSSE DE RÉPARATION POUR OUTILS PNEUMATIQUES - 53681	1.17	10	10	58,00€

52814 528,00€

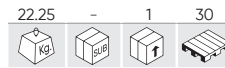

CLÉ À CHOC POUR CAMIONS 1" 3260NM



3260Nm



REF.	DESCRIPTION	kg	Box	Pallet	€
14153	TROUSSE DE RÉPARATION POUR OUTILS PNEUMATIQUES - 52814	0.05	-	15	20,50€

53343 285,00€

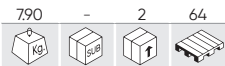

CLÉ À CHOC 3/4"

1600Nm



51222 128,00€



CLÉ À CHOC PAPILLON 1/2"

101Nm



REF.	DESCRIPTION	kg	Box	Pallet	€
14131	TROUSSE DE RÉPARATION POUR OUTILS PNEUMATIQUES - 51222	0.01	-	10	24,00€

52156 140,00€



COFFRET 16 PIÈCES PNEUMATIQUE AVEC CLÉ À ROCHET

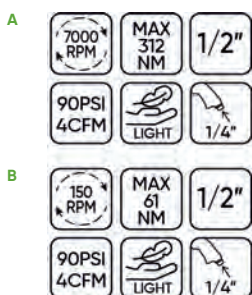

x10 9, 10, 11, 13, 14, 17, 19, 22, 24, 27mm

52165 118,00€



CLÉ À CHOC 1/2"

680Nm



54336

259,00€



N

CLIQUET PNEUMATIQUE ARTICULÉ DE 1/2"

95Nm



REF. DESCRIPTION

16273 TROUSSE DE RÉPARATION POUR OUTILS PNEUMATIQUES - 54336

0.15 - 15 12,50€

51214

148,00€

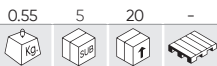

CLÉ À ROCHET 1/4" COMPOSITE

40,7Nm

COMPOSITE



REF. DESCRIPTION

14124 TROUSSE DE RÉPARATION POUR OUTILS PNEUMATIQUES - 51214 0.25 - 10 20,50€

51215

119,00€

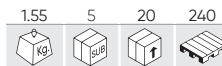

CLÉ A ROCHET 1/2

14-68Nm

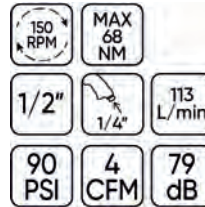

REF. DESCRIPTION

14125 TROUSSE DE RÉPARATION POUR OUTILS PNEUMATIQUES - 51215 0.03 - 10 19,50€

52167

48,00€

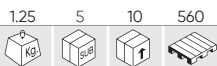

CLÉ À ROCHET 1/2"

61Nm



REF. DESCRIPTION

14779 TROUSSE DE RÉPARATION POUR OUTILS PNEUMATIQUES - 52167 0.05 - 10 33,00€

53784

148,00€

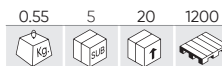

CLÉ À ROCHET 1/2" COMPOSITE

40,8Nm

COMPOSITE



REF. DESCRIPTION

14779 TROUSSE DE RÉPARATION POUR OUTILS PNEUMATIQUES - 53784 0.05 - 10 33,00€

51221 199,00€

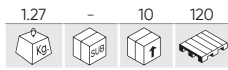

DÉPOINTUSE D'ANGLE REVERSIBLE 90°



REF.	DESCRIPTION	kg	Box	Unit	€
14130	TROUSSE DE RÉPARATION POUR OUTILS PNEUMATIQUES - 51221	0.40	-	10	21,00€

51220 240,00€

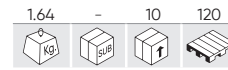

DÉPOINTUSE REVERSIBLE COMPOSITE



REF.	DESCRIPTION	kg	Box	Unit	€
14129	TROUSSE DE RÉPARATION POUR OUTILS PNEUMATIQUES - 51220	0.01	-	10	12,50€

53573 36,00€

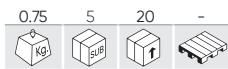

DÉPOINTUSE PNEUMATIQUE DROITE, 3/8"



52159 64,00€

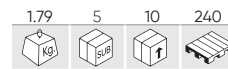

DÉPOINTUSE RÉVERSIBLE DE 1/2 "



52527 82,00€

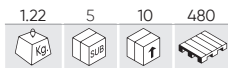

DÉPOINTUSE D'ANGLE RÉVERSIBLE 3/8



52160 48,00€

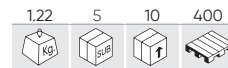

DÉPOINTUSE RÉVERSIBLE DE 3/8 "



DÉPOINTUSE PNEUMATIQUE AVEC DÉPLACEMENT DU FORET CENTRAL

52724 381,00€



REF.	DESCRIPTION	kg	Box	Unit	€
13817	FORET POUR 52725 - 6,5MM	0.10	-	500	17,00€

52725 349,00€



REF.	DESCRIPTION	kg	Box	Unit	€
13818	FORET POUR PARA 52725 - 8MM	0.10	-	500	20,50€

52718

48,00€

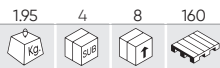

MARTEAU PNEUMATIQUE 9PCS



- A 21mm
- B 1,8mm
- C 21mm
- D 21mm



52953

38,00€

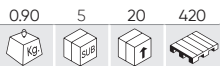

COUPEUSE PNEUMATIQUE 3"



REF.	DESCRIPTION	kg	sub	unit	€
12987	DISQUE POUR MEULEUSE PNEUMATIQUE 3" (52935)	0.02	50	500	1,50€

53140

98,00€

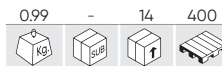

COUPEUSE PNEUMATIQUE



REF.	DESCRIPTION	kg	sub	unit	€
14013	DISQUE DE RECHANGE POUR RÉF. 53140	0.01	-	1000	3,50€

53541

168,00€

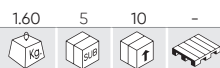

CISEAUX PNEUMATIQUES POUR MÉTAUX



REF.	DESCRIPTION	kg	sub	unit	€
14136	TROUSSE DE RÉPARATION POUR OUTILS PNEUMATIQUES - 53541	0.01	-	5	12,00€

52574

69,00€



SCIE PNEUMATIQUE



REF.	DESCRIPTION	kg	sub	unit	€
11956	RECHANGE 5 SCIES DE 4 DENTS POUR BOIS	0.03	10	300	5,50€
11957	RECHANGE 5 SCIE DE 32 DENTS POUR FER	0.01	10	250	5,50€

51216

650,00€

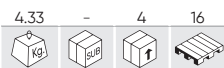

COFFRET BOSSEUSE ET ACCESSOIRES



ACCÉSSOIRES

REF.	DESCRIPTION				€
51388	BROSSE METAL ANGLE DE 23MM POUR REF. 51216	0.10	100	800	22,00€
51389	BROSSE METAL ANGLE DE 11 MM POUR REF. 51216	0.05	1	800	22,00€
51390	BROSSE FINE DE 23 MM	0.05	100	800	22,00€
51391	BROSSE METAL FINE DE 11 MM POUR 51216	0.04	1	800	22,00€
51392	GOMME DURE POUR PINTURE POUR REF. 51216	0.20	100	800	34,00€
51393	GOMME TENDRE POUR PINTURE POUR REF. 51216	0.10	50	800	34,00€
51439	ADAPT. ROUE 23MM	0.10	100	800	26,00€
51440	ADAPT. ROUE 11MM	0.10	1	800	28,00€
51441	ADAPT. POUR ROUE NOIRE DOUBLE	0.10	1	800	26,00€
51442	ADAPT. P/ROUE NOIRE SIMPLE	0.10	50	800	28,00€
REF.	DESCRIPTION				€
14126	TROUSSE DE RÉPARATION POUR OUTILS PNEUMATIQUES - 51216	0.01	-	10	54,00€

COMPREND

Différents types de roues (Pour la préparation de surfaces métalliques)
 11 mm Brosse à fil métallique (fin)
 23 mm Brosse à fil métallique (fin)
 11 mm Brosse à fil métallique (épais)
 23 mm Brosse à fil métallique (épais)
 Effaceur en gomme
 Effaceur de peintures avec base d'eau
 Adaptateur de 23 mm pour effaceur en gomme et brosse à fil métallique
 Adaptateur de 11 mm brosse à fil métallique
 Polisseur noir en caoutchouc (jusqu'à 6 pièces)
 Adaptateur unique de polisseur caoutchouc
 Adaptateur à double bande en caoutchouc

53576

189,00€

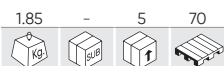

3" KIT POUR LA MACHINE DE POLISSAGE PNEUMATIQUE MINIATURE



REF.	DESCRIPTION				€
A 14162	COUSSINET DE POLISSAGE DE LAINE POUR RÉF. 53576	0.05	-	50	25,50€
B 14163	COUSSINET SPONGIEUX DOUX POUR RÉF. 53576 - BLANC	0.50	5	50	25,50€
C 14164	COUSSINET SPONGIEUX DUR POUR RÉF. 53576 - JAUNE	0.50	5	50	25,50€
D 14330	DISQUE VELCRO POUR 53576	0.01	5	50	3,50€
14154	TROUSSE DE RÉPARATION POUR OUTILS PNEUMATIQUES - 53576	0.05	-	10	42,00€

53646

69,00€



3" KIT POUR LA MACHINE DE POLISSAGE PNEUMATIQUE



REF.	DESCRIPTION				€
A 14286	COUSSINET SPONGIEUX DOUX POUR RÉF. 535646	0.01	10	200	2,99€
B 14287	COUSSINET SPONGIEUX DUR POUR RÉF. 53646	0.00	10	200	2,99€
C 14288	COUSSINET DE POLISSAGE DE LAINE POUR RÉF. 53646	0.01	10	200	6,00€
D 14289	DISQUE VELCRO POUR 53646	0.04	-	200	6,10€

53626

18,00€

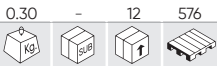

KIT DE RESTAURATION DE PHARES

14 PCS

COMPREND



PRÉSENTOIR DE 12 UNITÉS

- x2** Roues d'émeri p800
- x2** Roues d'émeri p1200
- x2** Roues d'émeri p2000
- x2** 3,0 Ml de liquide de protection uv.
- x2** Adaptateur (3/8" et 1/4")
- x1** 85 G de pâte à polir
- x1** Ruban adhésif
- x1** Roue à polir en laine
- x1** Disque éponge blanc



SERIE262

199,00€



SPÉCIALE KIT DE POLISSAGE: MACHINE POLISSAGE PNEUMATIQUE + 12 KIT RESTAURATION PHARES

53626

53646



x12u.

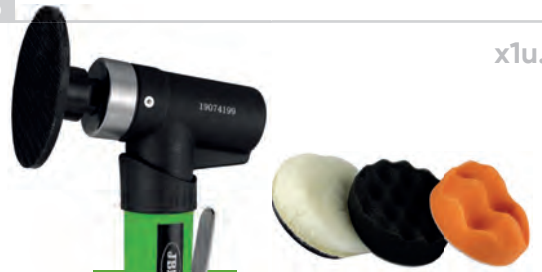

x1u.



52676

98,00€

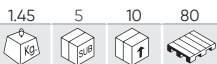

PONCEUSE AUTO-ASPIRANTE

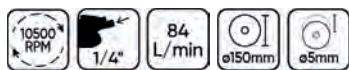

- Corps en aluminium avec manche coaouchouc (ergonomique). Avec tube d'aspiration et sac anti-poussière.



52675

84,00€

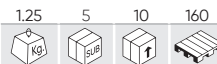

PONCEUSE ADAPTABLE ASPIRATEUR



52758

88,00€

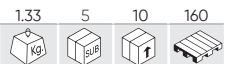

51226

233,00€

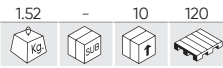

COFFRET MEULEUSE ORBITALE

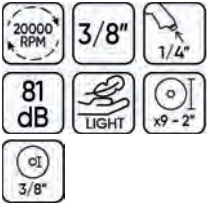

REF.	DESCRIPTION				€
14133	TROUSSE DE RÉPARATION POUR OUTILS PNEUMATIQUES - 51226	0.01	-	10	16,50€

52157

48,00€

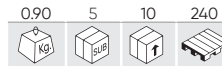

COFFRET DE 16 PIECES AVEC MOLEUSE PNEUMATIQUE



51245

99,00€

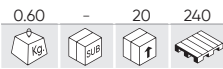

MINI MEULEUSE 3/8" 6MM



REF.	DESCRIPTION				€
14135	TROUSSE DE RÉPARATION POUR OUTILS PNEUMATIQUES - 51245	0.01	-	10	12,50€

52171

39,00€

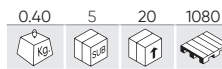

MINI MEULEUSE PNEUMATIQUE 1/4"

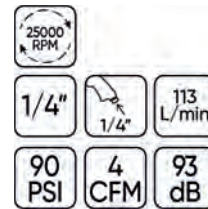

53141

68,00€

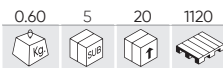

PERCEUSE PNEUMATIQUE



52528

49,00€

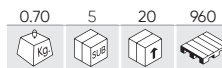

MEULEUSE D'ANGLE PNEUMATIQUE



53137

38,00€

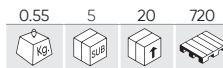

MINI MEULEUSE 1/4"



51218

288,00€

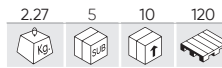

DISQUEUSE D'ANGLE COMPOSITE

COMPOSITE



REF.	DESCRIPTION				€
14127	TROUSSE DE RÉPARATION POUR OUTILS PNEUMATIQUES - 51218	0.01	-	10	32,50€

OUTILS PNEUMATIQUES

54255

68,00€

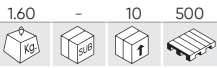

ENSEMBLE D'ACCÉSSOIRES POUR PISTOLET À GRAISSE

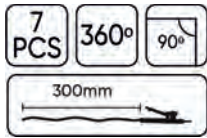

50751

43,00€

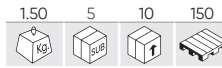

POMPE A GRAISSE PNEUMATIQUE

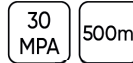

52490

6,65€

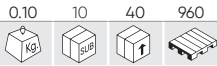

SOUFFLETE 100MM

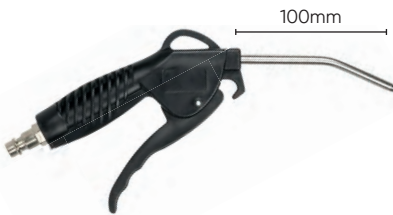

PRÉSENTOIR DE 10 UNITÉS

52491

10,50€

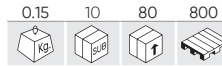

SOUFFLETE 300MM



PRÉSENTOIR DE 10 UNITÉS

53611

27,50€



PISTOLET À AIR EXTRA-LONG



GRAND VOLUME D'AIR

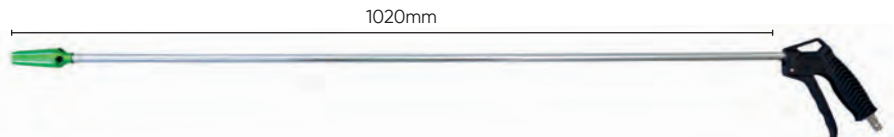

52798

18,00€

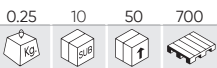

SOUFFLETE EXTENSIBLE

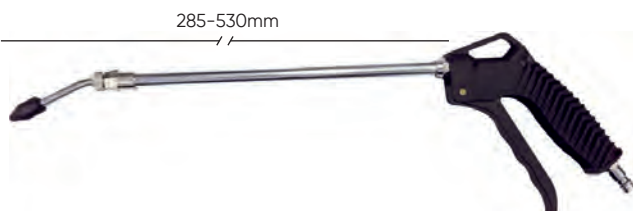

POINTE CAOUTCHOUTÉ POUR ÉVITER LES RAYURES

51980

15,00€

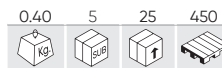

PISTOLET DE GONFLAGE



51981 21,50€



KIT PISTOLET DE GONFLAGE + SOUFFLETE



51277 64,00€



KIT D'OUTILS D'AIR COMPRIMÉ



52787 9,00€

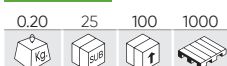

SARBACANE EN BLISTER INDIVIDUELLE



51383 11,10€



SOUFFLETES EN MÉTAL + ACCESSOIRES

- Pistolet à air.
- Emmanchement rapide européen.
- Emmanchement de tuyau.
- Extenseur de tube 10cm.
- Extenseur de tube 20cm.



PRÉSENTOIR DE 10 UNITÉS



54251 43,00€



PISTOLET D'ASPIRATION ET DE SOUFFLAGE



COMPREND



53205 19,00€

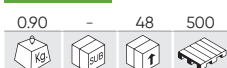

PISTOLET SOUFFLAGE GRAND DÉBIT



GRAND VOLUME D'AIR

- Pistolet de soufflage haut débit.
- Matériau: alliage d'aluminium.
- Surface: nickelée.

52381 20,50€



KIT SOUFFLETE 3/8" 5M



54248

58,00€

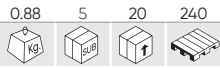

PISTOLET DE PULVÉRISATION D'AIR

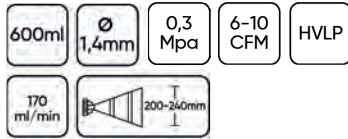

PIÈCES DE RECHANGE

54249

103,00€

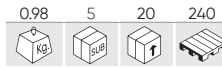

PISTOLET DE PULVÉRISATION D'AIR PROFESSIONNEL

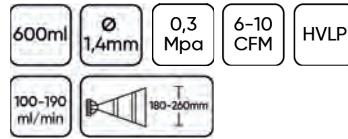

PIÈCES DE RECHANGE

53606

55,00€

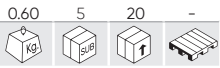

PISTOLET À SÉCHER PNEUMATIQUE



VANNE DE RÉGULATION D'AIR



53449

16,40€

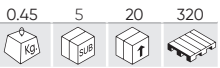

PISTOLET DE GONFLAGE ANALOGIQUE

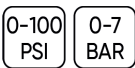

53450

28,30€

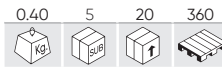

PISTOLET DE GONFLAGE DIGITAL



52648

9,00€

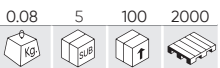

TESTEUR DE PRESSION



4,3 BAR

53416

14,10€

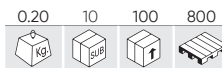

TESTEUR DE PRESSION DE PNEUMATIQUES AVEC TUBE (0-10BAR)



0-10 BAR

53417

26,30€

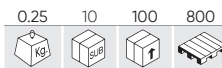

TESTEUR DIGITAL DE PRESSION DE PNEUMATIQUES AVEC TUBE (0-15BAR)

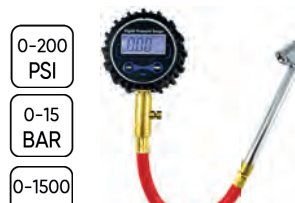

0-200 PSI
0-15 BAR
0-1500 KPA

53418

16,90€

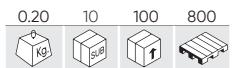

TESTEUR DIGITAL DE PRESSION DE PNEUMATIQUES (0-15BAR)

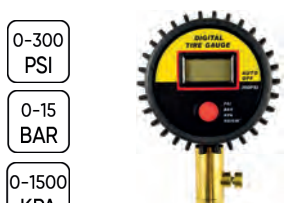

0-300 PSI
0-15 BAR
0-1500 KPA

51861

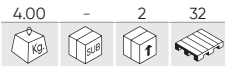

199,00€



EXPANDEUR SOUFFLETS DE CARDANS PNEUMATIQUE

- Matière: Aluminium.
- Ouverture de 20 à 100mm.

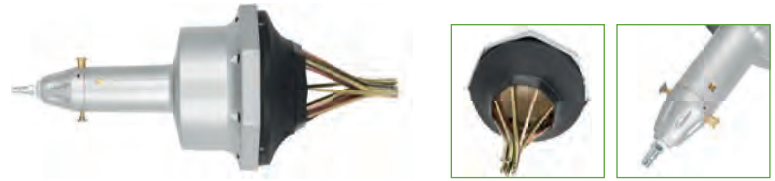

53542

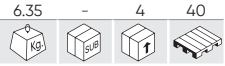

980,00€

DÉCOLLEUR DE PNEU



REF. DESCRIPTION

14137 TROUSSE DE RÉPARATION POUR OUTILS PNEUMATIQUES - 53542

0,65 5 5 131,00€

52540

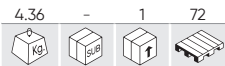

221,00€

VENTOUSE PNEUMATIQUE POUR CARROSSERIE

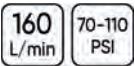

52331

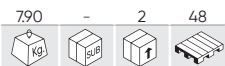

201,00€

COFFRET OUTILS PNEUMATIQUE

PISTOLE À CHOC + MARTEAU PNEUMATIQUE+ CLÉ À ROCHET PNEUMATIQUE + MINI MEULEUSE PNEUMATIQUE + PISTOLET À AIR + PISTOLET À AIR DROITE



OUTILS PNEUMATIQUES

52543

182,00€

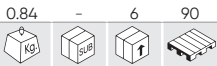

PISTOLET NETTOYAGE DE FAP

- Universel.
- Capacité maximale 650cc.
- Racor de Nylon de 4x6x2.7m.
- Rang de pression de travaille: 3 bar - 7 bar.
- Recipient en alu. + Base en alu.



REF.	DESCRIPTION	Kg	Box	Unit	€
90003	NETTOYANT	1.08	-	12 400	35,20€
90004	NEUTRALISANT	0.50	-	12 320	25,80€

53625

68,00€

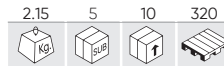

MARTEAU DE BROSSAGE PNEUMATIQUE



REF.	DESCRIPTION	Kg	Box	Unit	€
14188	AIGUILLE POUR RÉF. 53625	0.01	50	500	0,50€

53593

41,00€



PISTOLET À JET DE SABLE PNEUMATIQUE



- COMPREND**
- 1x Sableuse pneumatique.
 - 1x Piège.
 - 2x Sable (850g).

- 4x Buses: de traitement par points. de traitement de surface. pour les coins externes. pour les coins internes.

REF.	DESCRIPTION	Kg	Box	Unit	€
14168	BOUTEILLE DE SABLE (POUR RÉF. 53593)	0.95	-	20	7,00€

53202

15,70€

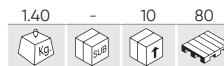

PISTOLET NETTOYAGE MOTEUR



- Pistolet de nettoyage du moteur.
- Matériel du réservoir: acier.
- Matériel du pistolet: alliage d'aluminium.
- Surface peinte.

53204

81,00€

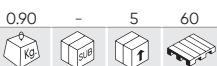

PISTOLET NETTOYANT THERMIQUE TORNADO



- Fortement recommandé pour le nettoyage à sec des véhicules.
- Matériel du réservoir: PE.
- Matériel du corps: Alliage d'aluminium.
- Finition polie.

52575

119,00€



RIVETUSE PNEUMATIQUE

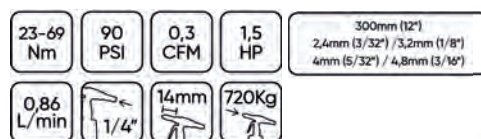

53567

43,00€

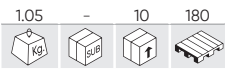

SERINGUE PNEUMATIQUE POUR GARNISSAGE DES JOINTS



- Pression de travail: 2,5-5 BAR.
- Entrée d'air: 1/4".
- Capacité de la cartouche: 310 ml.

52533

10,00€

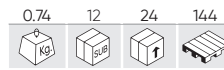

PISTOLET POUR CARTOUCHES 300ML

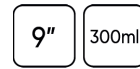

53572

348,00€

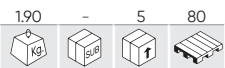

OUTILS PNEUMATIQUE POUR RECTIFICATION DE VALVES - PÉRCUSSON ET ROTATION

COMPREND

- 1 x machine à valve pneumatique.
- 5 ventouses (16, 20, 30, 35 et 40 mm).
- 5 x adaptateur de valve.
- 1x Clé Allen 3 mm.



54033

49,00€

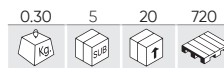

OUTIL DE FERMETURE DE SOUPAPES POUR PERÇAGE

- Diamètre de la ventouse : 16, 20, 30, 35, 40 mm
- Diamètre de l'axe : 8mm
- Longueur : 128 mm
- Fréquence de rotation de fonctionnement maximale : 1250 tr/min"



REF.	mm	Kg	L	mm	€
14157	16	0.01	-	50	8,30€
14158	20	0.01	-	50	9,95€
14159	30	0.01	-	50	12,60€
14160	35	0.01	-	50	12,80€
14161	40	0.10	-	50	13,70€



REF.	mm	Kg	L	mm	€
14157	16	0.01	-	50	8,30€
14158	20	0.01	-	50	9,95€
14159	30	0.01	-	50	12,60€
14160	35	0.01	-	50	12,80€
14161	40	0.10	-	50	13,70€



14534

16,50€

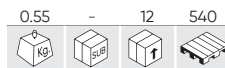

HUILE POUR OUTIL PNEUMATIQUE - 600ML

- Densité relative à 15°C: 0,845.
- Viscosité: 12,1 cSt à 40°C.
- Couleur: Incolore.



14560

8,80€

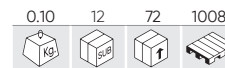

HUILE POUR OUTIL PNEUMATIQUE - 100ML

- Densité relative à 15°C: 0,845.
- Viscosité: 12,1 cSt à 40°C.
- Couleur: Incolore.





DISQUE DE COUPE

REF.	DESCRIPTION					€
51385	DISQUE DE COUPE POUR RÉF. 51219 DE 4"X1/32"	0.01	10	300	800	4,55€
51387	DISQUE DE COUPE DE 3"	0.03	10	300	800	3,25€



DISQUE DE PONÇAGE

REF.	DESCRIPTION					€
51386	DISQUE DE 5" DE PONÇAGE POUR RÉF. 51218	0.10	-	25	800	5,95€
51443	DISQUE DE PONÇAGE #60 POUR REF. 51226	0.50	25	150	800	5,50€
51444	DISQUE DE PONÇAGE DE #80 POUR REF. 51226	0.02	-	25	800	5,05€
51445	DISQUE DE PONÇAGE DE #120 POUR REF. 51226	0.02	-	25	800	5,05€



PLATEAUX POUR PONCEUSES

REF.	DESCRIPTION					€
13499	PLATEAUX 15 TROUS POUR PONCEUSES	0.10	-	50	1500	12,50€
13500	PLATEAUX 66 TROUS POUR 52675	0.65	5	50	-	12,90€
12009	PLATEAUX 6 TROUS POUR PONCEUSES	0.14	-	50	-	11,00€



FILTRE ET RÉGULATEUR À AIR

REF.	"					€
53063	1/4"	0.60	5	50	300	36,70€
53064	3/8"	0.63	5	50	300	37,40€
53065	1/2"	0.60	5	50	300	36,90€



FILTRE REGULATEUR D'AIR ET LUBRIFIANT

REF.	"					€
53066	1/4"	1.08	5	25	250	61,00€
53067	3/8"	0.50	5	25	250	61,00€
53068	1/2"	1.00	5	25	250	63,00€



53492 380,00€

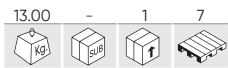

PRÉSENTOIR POUR OUTILS PNEUMATIQUES

1820mm
Ø500mm



LIVRE SANS OUTIL

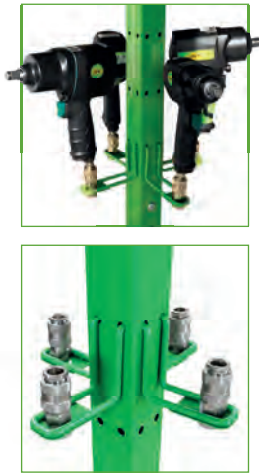

52378 10,00€

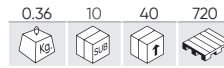

SUPPORT MAGNETIQUE

3Kg
Ø 60mm

51341 35,00€

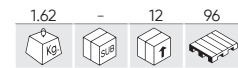

9Kg
Ø 70mm



53147 41,00€

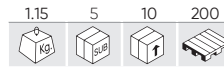

PRÉSENTOIR POUR OUTILS PNEUMATIQUES



LIVRE SANS OUTIL

53594 54,00€



TUYAU PNEUMATIQUE 8MM - 25 M

25m
Ø 8mm
Ø 13mm
300 PSI
20 BAR

HYBRID POLYMER
POLÍMERO HÍBRIDO

- Pression de travail: 300PSI / 20bar.
- Pression de rupture: 950PSI / 65bar.
- Température de travail: -40°C / 65°C

- Grande flexibilité.
- Retour à sa forme originale.
- Surface douce, n'endommage pas la peinture.
- Très résistant.

Diamètre intérieur: 8mm
Diamètre extérieur: 13mm

A utiliser avec:
REF. 52736 (M8)



53595 61,00€

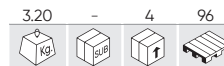

TUYAU PNEUMATIQUE 10MM - 25 M

25m
Ø 10mm
Ø 15mm
300 PSI
20 BAR

HYBRID POLYMER
POLÍMERO HÍBRIDO

- Pression de travail: 300PSI / 20bar.
- Pression de rupture: 950PSI / 65bar.
- Température de travail: -40°C / 65°C

- Grande flexibilité.
- Retour à sa forme originale.
- Surface douce, n'endommage pas la peinture.
- Très résistant.

Diamètre intérieur: 10mm
Diamètre extérieur: 15mm

A utiliser avec:
REF. 52737 (M10)







REF. DESCRIPTION

14169 JEU DE 10 PINCES 8-16 MM

0.10 - 125 - 3,00€

OUTILS PNEUMATIQUES

TUYAUX SPIRAL PNEUMATIQUES

REF.	m			"					€
53629	10m	8mm	5mm	1/4"	0.55	-	6	360	14,30€
53630	15m	8mm	5mm	1/4"	0.65	-	6	240	18,80€
53631	15m	12mm	8mm	1/4"	1.25	-	6	120	33,50€
53632	15m	15mm	10mm	1/4"	2.20	-	6	78	46,00€
53633	15m	15mm	10mm	3/8"	2.10	-	6	78	46,00€
53634	15m	18mm	13mm	1/2"	2.60	-	6	66	63,00€



AVEC EXTRÉMITÉS PIVOTANTES À 360 DEGRÉS POUR UN DÉPLACEMENT ET UNE UTILISATION FACILES

- MATÉRIAU DU TUYAU: PU.
- SURFACE FILETÉE: LAITON.

ENROULEUR DE TUYAU D'AIR



REMOBINAGE AUTOMATIQUE



SUPPORT MURAL INCLUS

14772 8,50€

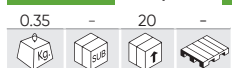

REF. 53582 / REF. 53583



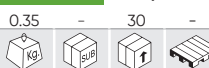

SUPPORT MURAL INCLUS

14771 10,50€



REF. 53532 / REF. 53581

20+2m

REF.	m	"				€
53582	22m	3/8"	10.85	-	14	174,00€
53583	22m	3/8"	10.75	-	14	174,00€





12+1m

REF.	m	"				€
53532	13m	3/8"	6.60	-	30	119,00€
53581	13m	3/8"	6.70	-	30	119,00€



10+1,5m

REF.	m	"				€
53881	11,5m	1/4"	4.50	-	48	79,00€
53882	11,5m	1/4"	4.50	-	48	79,00€



RACCORDEMENT DE TUYAU

REF.	DESCRIPTION					€
14204	EUR - M6 M 1/4"	0.06	50	200	-	1,50€
14205	EUR - M8 M 3/8"	0.06	50	200	-	1,50€
14206	EUR - M10 M 1/2"	0.05	50	200	-	1,50€
14207	US - M6 M 1/4"	0.05	50	200	-	1,50€
14208	US - M8 M 3/8"	0.06	50	200	-	1,50€
14209	US - M10 M 1/2"	0.05	50	200	-	1,50€



CONNECTEUR RAPIDE AVEC FIXATEUR - RACCORDEMENT DE TUYAU

REF.	DESCRIPTION					€
14201	M6	0.10	25	100	-	4,00€
14202	M8	0.10	25	100	-	4,00€
14203	M10	0.10	25	100	-	4,50€



CONNECTEUR / FILETAGE

		US				€
REF.	DESCRIPTION					€
13930	CONNECTEUR MÂLE US - FILETAGE MÂLE 1/4"	0.01	50	100		1,50€
13932	CONNECTEUR MÂLE US - FILETAGE MÂLE 3/8"	0.10	50	100		2,50€
14076	CONNECTEUR MÂLE US - FILETAGE FEMELLE 3/8"	0.10	50	100		1,50€
13933	CONNECTEUR MÂLE US - FILETAGE MÂLE 1/2"	0.10	50	100		2,00€
13935	CONNECTEUR MÂLE US- FILETAGE FEMELLE 1/4"	0.05	50	100		2,50€
13936	CONNECTEUR FEMELLE US - FILETAGE FEMELLE 1/4"	0.05	50	100		3,50€
13937	CONNECTEUR FEMELLE US - FILETAGE MÂLE 1/4"	0.05	50	100		4,00€
14078	CONNECTEUR FEMELLE US - FILETAGE FEMELLE 3/8"	0.10	50	100		4,00€
14191	CONNECTEUR MÂLE US - FILETAGE FEMELLE 1/2"	0.05	50	100		2,00€
14193	CONNECTEUR FEMELLE US - FILETAGE FEMELLE 1/2"	0.10	50	100		4,00€



		EUR				€
REF.	DESCRIPTION					€
13931	CONNECTEUR MÂLE EUR - FILETAGE MÂLE 1/4" (2 PCS)	0.05	50	100		2,50€
14075	CONNECTEUR MÂLE EUR - FILETAGE FEMELLE 3/8"	0.10	50	100		2,00€
13934	CONNECTEUR MÂLE EUR - FILETAGE FEMELLE 1/4" (2 PCS)	0.05	50	100		2,50€
13938	CONNECTEUR FEMELLE EUR - FILETAGE FEMELLE 1/4"	0.10	50	200		3,50€
13939	CONNECTEUR FEMELLE EUR - FILETAGE MÂLE 1/4"	0.10	50	100		4,00€
14077	CONNECTEUR FEMELLE EUR - FILETAGE FEMELLE 3/8"	0.10	50	100		4,50€
14190	CONNECTEUR MÂLE EUR - FILETAGE FEMELLE 1/2"	0.05	50	100		2,00€
14192	CONNECTEUR FEMELLE EUR - FILETAGE FEMELLE 1/2"	0.10	50	100		4,00€



OUTILS PNEUMATIQUES

CONNECTEUR RAPIDE AVEC FIXATEUR DE PROTECTION

REF.	DESCRIPTION						€
14195	FEMALE LOCK QUICK CONNECTOR – 1/4" MALE THREAD	0.50	25	100	-	-	4,00€
14196	FEMALE LOCK QUICK CONNECTOR – 3/8" MALE THREAD	0.10	25	100	-	-	4,00€
14197	FEMALE LOCK QUICK CONNECTOR – 1/2" MALE THREAD	0.10	25	100	-	-	4,50€
14198	FEMALE LOCK QUICK CONNECTOR – 1/4" FEMALE THREAD	0.10	25	100	-	-	4,00€
14199	FEMALE LOCK QUICK CONNECTOR – 3/8" FEMALE THREAD	0.10	25	100	-	-	4,00€
14200	FEMALE LOCK QUICK CONNECTOR – 1/2" FEMALE THREAD	0.10	25	100	-	-	4,50€



ADAPTATEUR ARTICULÉ POUR AIR COMPRIMÉ MÂLE

REF.	DESCRIPTION						€
14314	EUR 1/4"	0.06	25	100	-	-	5,00€
14315	US 1/4"	0.06	25	100	-	-	4,50€



14561

0.05	25	50	-

DÉRIVATEUR D'HUILE 1/4"



8,80€



CONNECTEUR RAPIDE PNEUMATIQUE

REF.	DESCRIPTION						€
52735	CONNECTEUR RAPIDE PNEUMATIQUE M6	0.05	25	200	4000	-	4,85€
52736	CONNECTEUR RAPIDE PNEUMATIQUE M8	0.10	25	200	4000	-	5,35€
52737	CONNECTEUR RAPIDE PNEUMATIQUE M10	0.10	25	200	4000	-	5,50€



ADAPTATEUR ARTICULÉ

REF.	DESCRIPTION						€
12988	ADAPTATEUR ARTICULÉ PNEUMATIQUE DE 1/2"	0.15	62	125	-	-	12,00€
13809	ADAPTATEUR ARTICULÉ DE 1/4"	0.10	62	250	-	-	18,50€
13810	ADAPTATEUR ARTICULÉ DE 3/8"	0.10	62	250	-	-	20,50€



OUTILS D'IMPACT

- 168 DOUILLES D'IMPACT
- 173 OUTILS SPÉCIAUX POUR PNEUS
- 174 ADAPTATEURS
- 176 PIÈCES DE RECHANGE DE DOUILLES D'IMPACT
- 177 OUTILS SPÉCIAUX POUR CAMIONS



52694

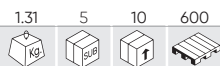

JEU DE 3 DOUILLES XZN DE 1/2" À CHOC



CONTIENT



49,00€

52337

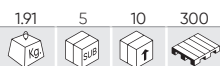

JEU DE 6 DOUILLES À CHOC 1/2" 6 PANS



CONTIENT

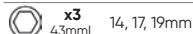

65,00€

52547



JEU DE 8 DOUILLES ET POINTES XZN DE 1/2" À CHOC

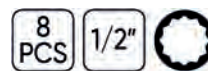

CONTIENT

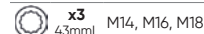
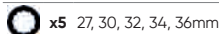

96,00€

52345

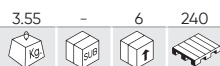

JEU DE 19 PIÈCES À CHOC DE 1/2" AVEC 14 DOUILLES 6 PANS + RÉDUCTEURS

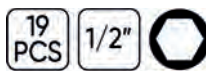

10, 11, 12, 13, 14, 15, 16, 17, 18, 19, 21, 22, 24, 27mm



PIÈCES DE RECHANGE DISPONIBLES

REF.	mm				€
14728	10	0.10	5	20	3,80€
14729	11	0.05	10	100	3,80€
14730	12	0.05	10	100	3,80€
14731	13	0.10	5	20	3,80€
14732	14	0.10	5	20	3,80€
14970	15	0.08	5	20	2,50€
14971	16	0.07	5	20	2,50€

REF.	mm				€
11195	17	0.10	10	100	3,70€
14972	18	0.12	5	20	3,50€
11121	19	0.10	10	60	4,10€
14733	21	0.10	5	20	4,30€
14734	22	0.15	5	20	5,40€
11122	24	0.14	10	20	5,45€
11123	27	0.20	10	50	6,50€

REF.	DESCRIPTION				€
12937	BARRE D'EXTENSION A CHOCK DU 50MM 1/2"	0.11	10	100	9,50€
14973	BARRE D'EXTENSION A CHOCK DU 150MM 1/2"	0.27	5	20	11,50€
12075	BARRE D'EXTENSION D'IMPACT 1/2" 250MM	0.45	10	50	15,50€
11962	REDUCTEUR À CHOCK 1/2" F 3/4" M	0.17	10	100	7,50€
11990	CARDAN POUR DOUILLES A CHOCK 1/2"	0.15	10	100	15,30€

109,00€

53531

109,00€



JEU 19 PIÈCES À CHOC DE 1/2" AVEC 14 DOUILLES 12 PANS + REDUCTEURS

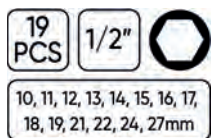

10, 11, 12, 13, 14, 15, 16, 17,
18, 19, 21, 22, 24, 27mm



PIÈCES DE RECHANGE DISPONIBLES

REF.	DESCRIPTION				€
12937	BARRE D'EXTENSION A CHOCK DU 50MM 1/2"	0.11	10	100	9,50€
14973	BARRE D'EXTENSION A CHOCK DU 150MM 1/2"	0.27	5	20	11,50€
12075	BARRE D'EXTENSION D'IMPACT 1/2" 250MM	0.45	10	50	15,50€

REF.	DESCRIPTION				€
11962	REDUCTEUR À CHOC 1/2" F 3/4" M	0.17	10	100	7,50€
11990	CARDAN POUR DOUILLES A CHOC 1/2"	0.15	10	100	15,30€

52341

58,00€

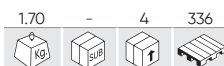

JEU DE 13 DOUILLES A CHOC DE 1/2" 6 PANS + REDUCTEUR



10, 11, 12, 13, 14, 17,
19, 21, 22, 24mm



PIÈCES DE RECHANGE DISPONIBLES

REF.	mm				€
14728	10	0.10	5	20	3,80€
14729	11	0.05	10	100	3,80€
14730	12	0.05	10	100	3,80€
14731	13	0.10	5	20	3,80€
14732	14	0.10	5	20	3,80€

REF.	mm				€
11195	17	0.10	10	100	3,70€
11121	19	0.10	10	60	4,10€
14733	21	0.10	5	20	4,30€
14734	22	0.15	5	20	5,40€
11122	24	0.14	10	20	5,45€

REF.	DESCRIPTION				€
14735	PORTE-BUSES À IMPACT 1/2"	0.05	5	20	6,50€
12074	BARRE D'EXTENSION D'IMPACT 1/2" 125MM	0.23	10	60	11,50€
11990	CARDAN POUR DOUILLES A CHOC 1/2"	0.15	10	100	15,30€

52346

103,00€



JEU 15 PIÈCES À CHOC AVEC 12 DOUILLES LONGUES DE 1/2" 6 PANS + RÉDUCTEURS



PIÈCES DE RECHANGE DISPONIBLES

REF.	mm				€
12061	10	0.14	10	100	9,50€
12062	12	0.15	10	100	9,50€
12063	13	0.15	10	50	9,50€
12064	15	0.17	10	100	9,00€
12065	16	0.30	10	20	9,00€
12066	17	0.20	10	100	9,00€

REF.	mm				€
12067	18	0.22	10	20	9,50€
12068	19	0.21	10	50	9,50€
12069	21	0.25	10	50	9,50€
12070	22	0.27	10	100	10,50€
12071	24	0.30	10	50	11,00€
12072	27	0.36	10	20	12,00€

REF.	DESCRIPTION				€
12074	BARRE D'EXTENSION D'IMPACT 1/2" 125MM	0.23	10	60	11,50€
12075	BARRE D'EXTENSION D'IMPACT 1/2" 250MM	0.45	10	50	15,50€
11990	CARDAN POUR DOUILLES A CHOC 1/2"	0.15	10	100	15,30€

53060

34,90€

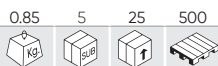

JEU DE 12 DOUILLES À CHOC 1/2" PROFIL BAS

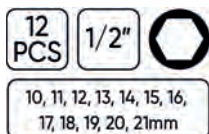

52342

63,00€

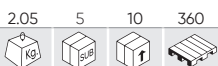

JEU DE 11 DOUILLES À CHOC 6 PANS DE 1/2"

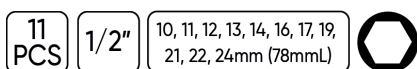

PIÈCES DE RECHANGE DISPONIBLES

REF.	mm				€
12061	10	0.14	10	100	9,50€
14736	11	0.15	5	20	5,00€
12062	12	0.15	10	100	9,50€
12063	13	0.15	10	50	9,50€
14737	14	0.15	5	20	5,00€
12065	16	0.30	10	20	9,00€

REF.	mm				€
12066	17	0.20	10	100	9,00€
12068	19	0.21	10	50	9,50€
12069	21	0.25	10	50	9,50€
12070	22	0.27	10	100	10,50€
12071	24	0.30	10	50	11,00€



53744

63,00€

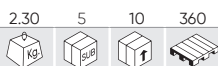

KIT DE 11 HAUTES TÊTES À PERCUSSION À 12 PANS 1/2"

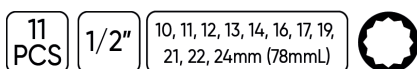

PIÈCES DE RECHANGE DISPONIBLES

REF.	mm				€
14738	10	0.15	10	100	5,50€
14739	11	0.15	10	100	5,50€
14740	12	0.16	10	100	5,55€
14741	13	0.15	10	100	5,55€
14742	14	0.15	10	100	5,55€
14743	16	0.14	10	100	5,15€

REF.	mm				€
14744	17	0.18	10	50	5,35€
14745	19	0.22	10	50	6,25€
14746	21	0.24	10	50	6,40€
14747	22	0.27	10	50	7,10€
14748	24	0.30	10	50	8,30€



52810

9,00€

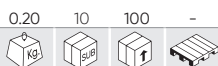

DOUILLE A CHOC XZN INVIOLEABLE M16

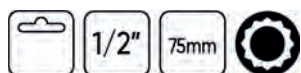

- Douille à choc carré 75 mm de long et 1/2" pour l'extraction du boulon de drainage avec pistolet d'impact sur les transmissions de véhicules VAG, Porsche, Ford, etc.

52811

9,90€

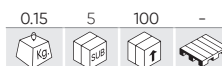

DOUILLE A CHOC XZN INVIOLEABLE M18

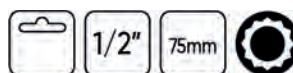

- Pour l'extraction du bras de direction sur les modèles de véhicules du groupe VAG.

52546

39,60€

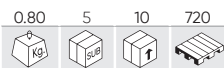

JEU DE 6 DOUILLES XZN DE 1/2" À CHOC



PIÈCES DE RECHANGE DISPONIBLES

REF.	43mmL	kg	L	Q	mm	€	REF.	78mmL	kg	L	Q	mm	€
12931	M14	0.08	10	200	7,50€	12934	M14	0.13	10	200	7,50€		
12932	M16	0.08	10	200	7,50€	12935	M16	0.14	10	200	8,00€		
12933	M18	0.09	10	200	8,00€	12936	M18	0.16	10	200	8,50€		

52344

197,00€

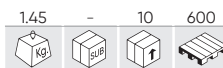

JEU DE 13 DOUILLES À CHOC DE 1/2" 6 PANS ET TORX

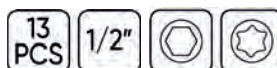

CONTIENT

- x5 45mmL 5, 6, 8, 10, 12mm
- x8 45mmL T30, T40, T45, T50, T55, T60, T70, T80

52339

61,00€



JEU DE 8 DOUILLES A CHOC 6 PANS DE 1/2"



PIÈCES DE RECHANGE DISPONIBLES

REF.	mm	kg	L	Q	mm	€	REF.	mm	kg	L	Q	mm	€
14004	5	0.30	10	240	9,50€	14008	10	0.11	10	240	9,50€		
14005	6	0.09	10	120	10,50€	14009	12	0.12	10	240	9,50€		
14006	7	0.09	10	240	9,50€	14010	14	0.14	10	120	11,00€		
14007	8	0.10	10	240	9,50€	14011	17	0.18	10	60	11,00€		

52340

58,00€



JEU DE 8 DOUILLES A CHOC TORX DE 1/2"



PIÈCES DE RECHANGE DISPONIBLES

REF.	mm	kg	L	Q	mm	€	REF.	mm	kg	L	Q	mm	€
12938	T25	0.08	10	50	10,00€	12942	T50	0.10	10	60	10,00€		
12939	T30	0.10	10	50	10,00€	12943	T55	0.10	10	50	10,00€		
12940	T40	0.10	10	50	10,00€	12944	T60	0.12	10	50	10,00€		
12941	T45	0.09	10	50	10,00€	12945	T70	0.15	10	50	10,50€		

53470

176,00€

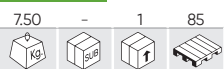

KIT DE 8 TÊTES HEXAGONALES DE BATTAGE HAUTE TAILLE 3/4"

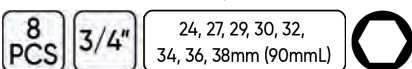

52347

158,00€



JEU DE 8 DOUILLES À CHOC 6 PANS 3/4"

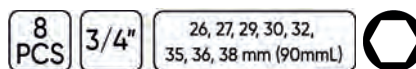

51028

163,00€



JEU DE 16 POINTES À CHOC

16 PCS 3/4"

PIÈCES DE RECHANGE DISPONIBLES

REF.	mm				€
14723	H17	0.35	-	10	18,00€
14724	T60	0.30	-	10	18,50€
14725	T70	0.30	-	10	18,50€
14726	T80	10.80	-	10	17,50€

	3/4"	x4	E18, E20, E22, E24
	3/4"	x5	T60, T70, T80, T90, T100
	3/4"	x4	H17, H19, H22, H24
		x2	1 - 3/4"
		x1	4mm



54316

182,00€



N

SET DE 8 LONGUES DOUILLES À IMPACT DE 1"

8 PCS 1"



x6	90mmL	24, 27, 30, 32, 33, 36mm
x2	95mmL	38, 41mm



PIÈCES DE RECHANGE DISPONIBLES

REF.	mm				€
16304	24	0.60	6	24	31,00€
16305	27	0.70	6	24	31,00€
16571	30	0.77	6	24	32,00€
16572	32	0.95	6	24	33,50€

REF.	mm				€
16574	33	0.94	-	-	34,00€
16575	36	1.00	6	24	34,50€
16576	38	1.25	6	24	35,50€
16577	41	1.32	6	24	36,00€

52348

179,00€



JEU DE 8 DOUILLES À CHOC 6 PANS 1"

8 PCS 1"



x2	58mmL	24, 27mm
x3	62mmL	30, 32, 33mm
x2	65mmL	36, 38mm
x1	68mmL	41mm



PIÈCES DE RECHANGE DISPONIBLES

REF.	mm				€
13859	24	0.50	6	24	16,00€
13874	27	0.60	6	72	17,50€
13875	30	0.50	6	18	18,50€
13876	32	0.60	6	24	18,50€

REF.	mm				€
13877	33	0.60	6	96	18,50€
11153	36	0.70	6	18	23,40€
11155	38	0.90	6	12	24,40€
11158	41	0.95	6	18	28,50€

52969

20,70€



JEU DE 3 DOUILLES À CHOC HEX. LONGUES

3 PCS 1/2"



17, 19, 21mm (78mmL)

PIÈCES DE RECHANGE DISPONIBLES

REF.	mm				€
12066	17	0.20	10	100	9,00€
12068	19	0.21	10	50	9,50€
12069	21	0.25	10	50	9,50€



53587

44,00€

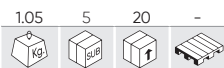

JEU DE 4 EMBOUTS À CHOC POUR LES ROUES EN ALLIAGES LÉGERS, 1/2"



PIÈCES DE RECHANGE DISPONIBLES

REF.	mm	mmL		kg	pcs	pcs	€
14172	15mm	85mmL	SMART	0.20	10	50	8,50€
14173	17mm	85mmL	MERCEDES-BENZ	0.20	10	50	9,50€
14177	22mm	85mmL	OPEL	0.25	10	50	9,50€
14178	21mm	85mmL	HYUNDAI / KIA	0.25	10	50	9,50€

52338

41,00€

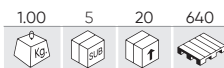

JEU DE 4 DOUILLES A CHOC 1/2" SPÉCIALES EXTRACTION DE ROUES



PIÈCES DE RECHANGE DISPONIBLES

REF.	mm	kg	pcs	pcs	€
11314	17	0.22	10	100	8,50€
11315	19	0.25	10	100	8,50€
11316	21	0.26	10	100	8,50€
11628	22	0.27	10	50	9,50€



51336

29,30€

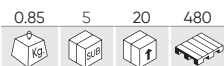

SET DE 3 DOUILLES D'IMPACT POUR EXTRACTION DE ROUES 1/2"



PIÈCES DE RECHANGE DISPONIBLES

REF.	mm	kg	pcs	pcs	€
11314	17	0.22	10	100	8,50€
11315	19	0.25	10	100	8,50€
11316	21	0.26	10	100	8,50€

52343

52,00€



JEU DE 12 DOUILLES A CHOC DE 1/2" 6 PANS SPECIAL EXTRACTION ROUE

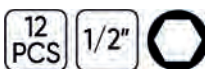

CONTIENT

x3	85mmL	17, 19, 21mm
	x1	42mmL 27mm
x8	38mmL	10, 11, 13, 14, 17, 19, 22, 24mm

53988

101,00€



JEU DE 10 DOUILLES D'IMPACT POUR EXTRACTION DE ROUES 1/2"



CONTIENT

A	1/2"	15mm	F	1/2"	23mm
B	1/2"	17mm	G	1/2"	24mm
C	1/2"	19mm	H	7/8"	TESLA
D	1/2"	21mm	I	17mm	MERCEDES
E	1/2"	22mm	J	21mm	HYUNDAI / KIA



53197

46,00€

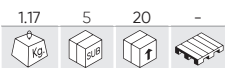

JEU DE 4 DOUILLES D'IMPACT POUR VIS DE SÉCURITÉ



CONTIENT

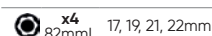

53077

62,00€



JEU DE BARRES D'EXTENSION À CHOC (LIMITATION DE COUPLE)



PIÈCES DE RECHANGE DISPONIBLES

	REF.	Nm					€
A	13688	100	0.22	-	-	1500	15,50€
B	13687	110	0.22	5	50	-	15,50€
C	13686	120	0.23	5	50	1000	15,50€
D	13685	135	0.25	5	50	1500	15,50€
E	13684	150	0.28	-	50	-	15,50€



TU POURRAIS AUSSI AIMER...

	REF.	Nm					€
F	13680	200	0.36	50	50	-	15,50€
G	13681	190	0.35	-	50	-	15,50€
H	13682	175	0.32	-	50	-	15,50€
I	13683	160	0.30	-	50	-	15,50€
J	13689	90	0.20	5	50	1500	15,50€



BARRE D'EXTENSION D'IMPACT

REF.	mm	"					€
12937	50	1/2"	0.11	10	100	1500	9,50€
12074	125	1/2"	0.23	10	60	-	11,50€
12075	250	1/2"	0.45	10	50	-	15,50€

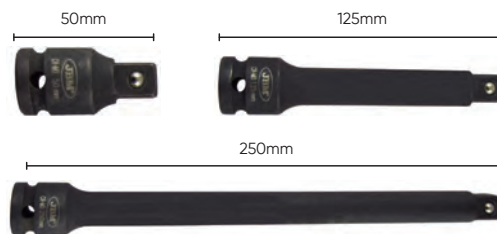

CARDAN POUR DOUILLES À CHOC

REF.	"					€
11938	3/4"	0.62	10	50	-	47,00€
11990	1/2"	0.15	10	100	-	15,30€



53043

53,00€

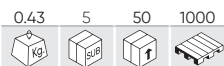

JEU DE 3 ARTICULATIONS À CHOC (FIXE ARTICULÉ)



53044

121,00€



JEU DE 8 DOUILLES À CHOC HEX. AVEC DOUBLE POSITION (FIXE/ARTICULÉ)

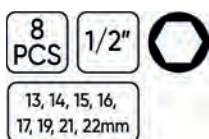

13, 14, 15, 16,
17, 19, 21, 22mm



52545

177,00€

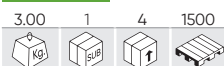

JEU DE 2 RÉDUCTEURS À CHOC

1" 1/2" F - 1" M
1" F - 1" 1/2" M



53743

39,70€

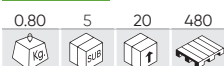

JEU DE 6 TÊTES À PERCUSSION



PIÈCES DE RECHANGE DISPONIBLES

REF.	mm				€
14749	1/4"H - 3/8"M	0.03	20	200	2,00€
14750	3/8"H - 1/4"M	0.05	20	100	2,00€
14751	3/8"H - 1/2"M	0.15	20	100	4,00€
14752	1/2"H - 3/8"M	0.16	10	100	4,00€
11962	1/2"H - 3/4"M	0.17	10	100	7,50€
11964	3/4"H - 1/2"M	0.35	10	100	12,50€



52544

93,00€



JEU DE 6 RÉDUCTEURS À CHOC



PIÈCES DE RECHANGE DISPONIBLES

REF.	mm				€
11962	1/2"H - 3/4"M	0.17	10	100	7,50€
11963	1/2"H - 1"M	0.25	6	54	9,00€
11964	3/4"H - 1/2"M	0.35	10	100	12,50€
11965	3/4"H - 1"M	0.45	6	48	16,00€
11966	1"H - 1/2"M	0.54	6	36	18,00€
11967	1"H - 3/4"M	0.56	4	36	18,00€

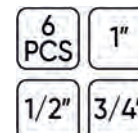

52914 223,00€

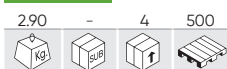

CAMION ENJOLIVEURS PRISE
BPW 120MM DR.41MM



120mm
8 PANS
CARRÉ HEXAGONAL 41mm

52915 199,00€



ROUE DE CAMION PRISE
ECROU BPW 111MM DR.41MM



111mm
OVAL
CARRÉ HEXAGONAL 41mm

52916 218,00€



ROUE DE CAMION PRISE
ECROU BPW 109MM DR.41MM



109mm
8 PANS
CARRÉ HEXAGONAL 41mm

52917 122,00€



DOUILLE EXTRACTION
MOYEUX CAMION BPW 65MM



65mm
OVAL
DIAGONALE 36MM

52918 146,00€



ENJOLIVEURS ARBRE ARRIERE
PRISE BPW 95MM



95mm
CARRÉ 3/4"

52919 181,00€



PRISE D'ECROU DE ROUE BPW
110MM 3/4 "



110mm
8 PANS
CARRÉ 3/4"

52920 155,00€



ARBRE PORTEUR ALVEOLE
D'EXTRACTION BPW 80MM
3/4 "



80mm
CARRÉ 3/4"

52921 117,00€



ARRIERE ECROU D'ARBRE
ALVEOLE D'EXTRACTION BPW
65MM 3/4 "



65mm
CARRÉ 3/4"

52922 180,00€



ARBRE PORTEUR ALVEOLE
D'EXTRACTION BPW 85MM
3/4 "



85mm
6 PANS
CARRÉ 3/4"

52923 59,00€



SUSPENSION SCANIA
EXTRACTION DE NOIX PRISE
28X37MM 3/4 "



28x37mm
CARRÉ 3/4"

52924 52,00€



SUSPENSION SCANIA
EXTRACTION D'ARBRE PRISE
34X46MM 3/4 "



34x46mm
CARRÉ 3/4"

52925 176,00€



SCANIA PRISE DE ROUE AVANT
DE 80MM H41



80mm
8 PANS
CARRÉ HEXAGONAL 41mm

52926 201,00€



PRISE DE ROUE ARRIERE DE
SCANIA 100MM 3/4 " 8 BORDS



100mm
8 PANS
CARRÉ 3/4"

52927 59,00€



SCANIA AMORTISSEUR
ARRIERE PRISE 34X56MM 3/4 "



34x56mm
CARRÉ 3/4"

52928 172,00€



PRISE DE ROUE SCANIA AVANT
80MM 3/4" 8 BORDS



80mm
8 PANS
CARRÉ 3/4"

52929 185,00€



PRISE D'ECROU DE ROUE DE
SCANIA 95MM 3/4 " 8 BORDS



95mm
8 PANS
CARRÉ 3/4"

OUTILS D'IMPACT

52930 117,00€

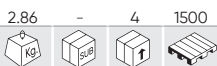

INSTALLATION DE CAMION
SCANIA VILEBREQUIN ARRIERE
OUTIL DE JOINT D'HUILE



SCANIA 310/320
BAGUES D'ÉTANCHÉITE 0366303-R

52931 45,00€

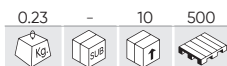

SCANIA CAMION ARBRE A
CAMES EN PRISE DE ROTATION
1/2 "



CARRÉ 1/2"

52932 45,00€



PRISE POUR SOUPAPE
D'INJECTION
ELECTROMAGNETIQUE
SCANIA 38MM 1/2 "



Ø38mm
CARRÉ 1/2"

52933 194,00€

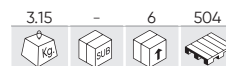

SCANIA 8 CRÉNEAUX SOCKET
420



Ø11,6mm - Ø10mm
8 ERGOTS
CARRÉ 3/4"
SCANIA 420

53430 286,00€



DOUILLE ESSIEU IVECO



Ø134mm - Ø110,5mm
118x134mm
IVECO
12 PANS

52935 94,00€



PRISONNIER PRISE CAMION
ECROU BENZ / HOMME 60MM



60mm
CARRÉ 3/4"

52936 199,00€



DOUILLES À ERGOTS
EXTRACTION BAGUE POUR
FURGONS / 6 ERGOTS / 80-
95MM



80-95mm
CARRÉ 3/4"
6 ERGOTS

52937 265,00€



CAMION ARBRE ARRIERE
ALVEOLE D'EXTRACTION DE
NOIX BENZ / HOMME 95-
115MM



95-115mm
CARRÉ 3/4"
6 ERGOTS

52938 199,00€



DIRECTION DE CAMION
ALVEOLE D'EXTRACTION DE
NOIX BENZ / HOMME H60
3/4 "



100mm
CARRÉ 3/4"
6 ERGOTS

52939 28,00€



PRISE DE CAMION BENZ /
HOMME POUR L'INJECTION
DE LA SOUPAPE DE DIESEL
D'EXTRACTION



22-28mm
CARRÉ 1/2"
4 ERGOTS

52940 235,00€



PRISE DE CAMION BENZ /
HOMME POUR DIFFERENTIEL
ARRIERE A ECROU



101mm
CARRÉ 3/4"
6 ERGOTS

52941 70,00€



OUTIL DE MOTEUR ET DES
ENGRANAGES ROTATION
ROUE BENZ / MAN 2



CARRÉ 1/2"

52942 105,00€

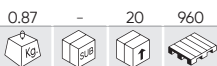

OUTIL DE MOTEUR ET DES
3 ENGRANAGES ROTATION
ROUE BENZ / MAN



CARRÉ 1/2"

52943 75,00€

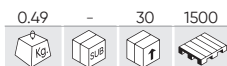

ROUE DE CAMION OUTIL DE
ROTATION POUR MOTEUR
MAN



CARRÉ 1/2"

52934 102,00€

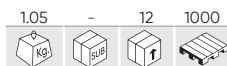

PRISONNIER PRISE CAMION
ECROU BENZ / HOMME 56MM



56mm
CARRÉ 3/4"

REF.	mm			€
52944	30	1.00	20	110,00€
52945	39	2.74	24	281,00€

EXTRACTOR DE MOYEU
CAMIONS ET VEHICULES
COMMERCIAUX



52944
CARRÉ HEXAGONAL
19mm

52945
CARRÉ HEXAGONAL
26mm

TRAVAUX DE CARROSSERIE

- 180 OUTILLAGE DE CARROSSERIE
- 183 RESTAURATION DE PHARES
- 185 REMPLACEMENT DE VITRES
- 186 RÉPARATION DE CHÂSSIS
- 188 MOBILIER AUXILIAIRE
- 191 ENTRETIEN D'INTÉRIEUR



53224

142,00€



SET DE RÉPARATION POUR BOSSELLEMENT

32 PCS AUDI

PIÈCES DE RECHANGE DISPONIBLES

REF. DESCRIPTION	kg	L	PCS	€
13842 SAC DE 5 DISQUES BLEUS POUR REF.53224	0.15	10	100	8,50€
13843 SAC DE 4 DISQUES JAUNES POUR REF.53224	0.01	10	100	7,00€
13844 SAC DE 10 DISQUES ROUGES POUR REF. 53224	0.05	10	50	9,00€
13845 JEUX DE 5 TUBES DE COLLE POUR REF. 53224	0.02	10	100	8,00€



52876

182,00€

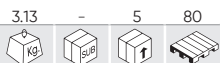

COFFRET TAS POUR CARROSSIER 7 PCS

PIÈCES DE RECHANGE DISPONIBLES

REF. DESCRIPTION	kg	L	PCS	€
A 12955 DOUBLE TAS DE CARROSSIER	0.28	-	25	99 27,80€
B 12956 TAS DE CARROSSIER RECTANGLE	0.31	-	25	99 27,80€
C 12957 TAS DE CARROSSIER COURBURE	0.37	5	25	99 27,80€
D 12958 TAS DE CARROSSIER FAÇON HACHETTE	0.41	-	25	27,80€
E 12959 TAS DE CARROSSIER ÉPINÇOIR	0.30	5	25	99 27,80€
F 12960 TAS DE CARROSSIER TALON	0.18	-	25	1500 27,80€
G 12961 TAS DE CARROSSIER ÉPINÇOIR AVEC MANCHE	0.34	-	25	27,80€



51131

61,00€



COFFRET CARROSSIER POUR DÉBOSELAGE

PIÈCES DE RECHANGE DISPONIBLES

REF. DESCRIPTION	kg	L	PCS	€
A 11541 MARTEAU TÊTE RONDE/CARRÉ	0.43	5	25	11,00€
B 11542 MARTEAU TÊTE RONDE/PANNE POINTUE	0.38	5	25	11,00€
C 11543 MARTEAU TÊTE RONDE /PANNE DROITE	0.42	5	25	11,00€
D 11544 TAS TALON	0.69	5	25	7,00€
E 11545 TAS À RAIL	0.79	5	25	11,00€
F 11546 TAS TÊTE CARRÉE	0.81	5	25	12,00€
G 11547 TAS VIRGULE	0.81	5	25	12,00€



53545

35,70€

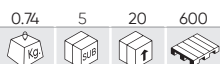

COFFRET DE DOUILLES 5 PIÈCES DE TÊTES HEXAGONALES ALLONGÉES 3/8"

5 PCS 3/8" CrV
 BMW, FORD, OPEL, VAG, VAUXHALL



8, 10, 12, 13, 14mm (120mmL)

51832 18,00€

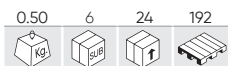

JEU DE 4 BURINS EN NYLON



19mm x 273mm
22mm x 273mm
25mm x 273mm
38mm x 273mm



50903 30,80€



JEU DE 5 LEVIERS COUDES MÉTAL



60, 43, 38,
28, 18cm



52026 31,80€

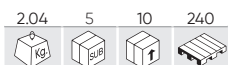

JEU DE 2 LEVIERS MÉTAL

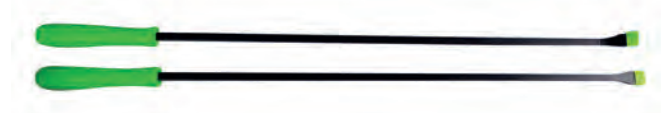

51360 8,05€



PIED DE BICHE 18"X5/8

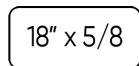

51361 9,80€



PIED DE BICHE 24" X 3/4

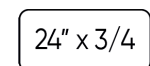

52851 9,65€



JEU DE 2 LEVIERS

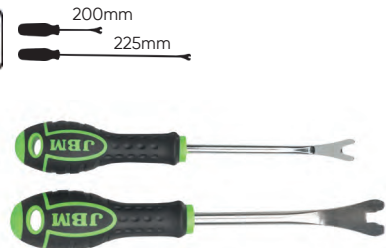

53110 27,30€



SET DE 6 LEVIERS



5"x8.5mm
5"x10.3mm
5"x4.5mm
15"x8.5mm
15"x10.3mm
15"x4.5mm

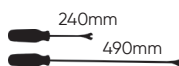

50901 16,00€

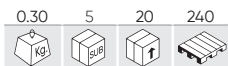

JEU DE 5 LEVIERS NYLON



UNIVERSAL
60x160mm
63x175mm
30x200mm
20x180mm
20x215mm



52788 39,00€

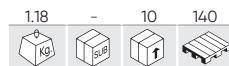

JEU DE 27 LEVIERS NYLON



52977

137,00€



JEU DE 4 LEVIERS EXTRA LONG



52540

221,00€



VENTOUSE PNEUMATIQUE POUR CARROSSERIE

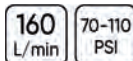

54017

12,00€

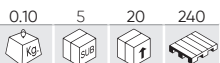

OUTIL D'ÉTANCHÉITÉ EN SILICONE



CINQ COUSSINETS DE REMPLACEMENT EN SILICONE: 3R, 6R, 10R, 13R, 17R



52533

10,00€



PISTOLET POUR CARTOUCHES 300ML

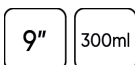

53525

12,00€

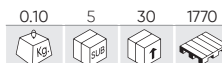

PINCE POUR LES DISPOSITIFS D'OUVREURE DU CAPOT ET DU COFFRE



- Diamètre d'ouverture maximum: 10mm.

53655

12,00€

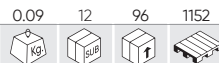

ARRACHEUR POUR POIGNÉES DE PORTE VAG



54246

104,00€

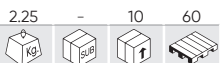

BALANCE DE PRÉCISION DE 5 KG

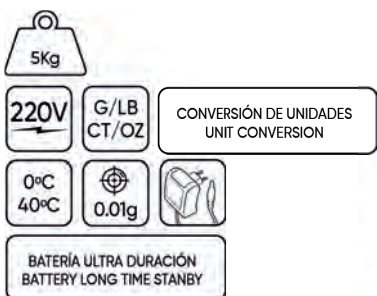

54247

99,00€



BALANCE DE PRÉCISION DE 2 KG

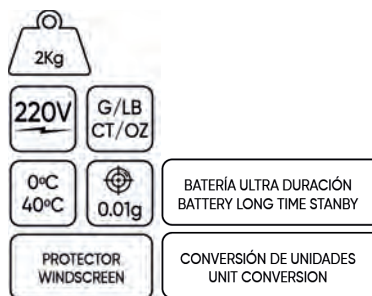

53230

19,70€

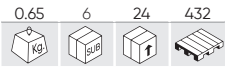

JEU D'OUTILS POUR OUVRIR LES VOITURES



52077

29,50€

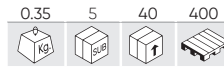

JEU DE 4 COUSSINS GONFLABLES

40-50mm

COMPREND

- Coussins de 16x16cm
- Coussins de 32x12cm
- Coussins de 19x6cm
- Coussins de 18x4,5cm
- Pompe manuel

- Pression maximale supportée: 100 kg



53486

29,30€

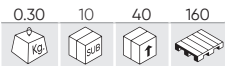

MIROIR D'INSPECTION DES FOSSES

Ø 800mm



53673

80,00€

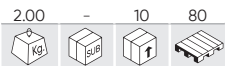

KIT DE RESTAURATION DES PHARES



PIÈCES DE RECHANGE DISPONIBLES

REF.	DESCRIPTION	kg	SUB	cm	€
A	14564 KIT DE 6 PAPIERS ÉMERIS POUR RÉF. 53673	0.10	10	100	9,20€
B	14565 ADAPTATEUR CA-CC POUR RÉF. 53673	0.20	10	50	26,70€
C	14566 ADAPTATEUR 12V POUR RÉF. 53673	0.05	10	100	16,70€
D	14567 TASSE D'ÉVAPORATION POUR RÉF. 53673	0.15	10	20	38,00€
E	14568 COUVERCLE COURBÉ AVEC BAGUE D'ÉTANCHÉITÉ EN CAOUTCHOUC POUR RÉF. 53673	0.01	10	200	9,20€
F	14569 COUVERCLE PLAT AVEC BAGUE D'ÉTANCHÉITÉ EN CAOUTCHOUC POUR RÉF. 53673	0.00	10	200	9,20€
G	14570 ENTONNOIR POUR RÉF. 53673	0.01	10	200	4,05€
H	14571 PLAQUE DE RODAGE POUR RÉF. 53673	0.05	-	10	9,20€
I	14573 PAPIER TEXTURÉ POUR RÉF. 53673	0.01	10	100	4,05€
J	15375 RÉCIPIENT AVEC LIQUIDE POUR RÉF. 53673	0.80	4	24	28,00€

15375

28,00€

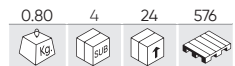

RÉCIPIENT AVEC LIQUIDE POUR RÉF. 53673

Le kit de réparation de phares en polymère liquide est un système innovateur qui permet de restaurer les phares grillés jusqu'à leur état d'origine, avec une brillance d'origine et une apparence idéale.



UFI: 9600-WOPH-M003-4PRX

BRILLANCE D'ORIGINE ET UNE APPARENCE IDÉALE

KIT DE 10 ÉLÉMENTS DE PAPIER ABRASIF

REF.	DESCRIPTION	kg	SUB	cm	€	REF.	DESCRIPTION	kg	SUB	cm	€
14710	GRAIN 180	0.25	10	100	3,50€	14713	GRAIN 600	0.15	10	100	4,25€
14711	GRAIN 280	0.20	10	100	3,75€	14714	GRAIN 800	0.15	10	100	4,50€
14712	GRAIN 360	0.20	10	100	4,00€	14715	GRAIN 1200	0.10	10	100	4,75€



TUTORIEL VIDÉO

52740

690,00€

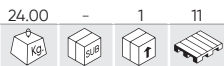

REGLOPHARES AVEC LUXOMETRE 152CM



HALOGENE / XENON / LED

- Distance de mesure: 50cm.
- Facile mesure de la deviation de l'axe optique des feux.
- Aussi pour les camions.

52836

1.100,00€

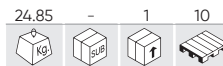

PHARE D'ALIGNEMENT DOUBLE LASER



HALOGENE / XENON / LED

- Aussi pour les camions.

DOUBLE LASER
LUXMETRE DIGITAL
ECRAN DE VERIFICATION

53626

18,00€



KIT DE RESTAURATION DE PHARES



COMPRED

- | | | | |
|--|--|--|--------------------------|
| | x2 roues d'emeril P800 | | x1 85 g de pate a polir |
| | x2 roues d'emeril P1200 | | x1 ruban adhesif |
| | x2 roues d'emeril P2000 | | x1 roue a polir en laine |
| | x2 3,0 ml de liquide de protection UV. | | x1 disque eponge blanc |
| | x2 adaptateur (3/8" et 1/4") | | |

PRESENTOIR DE 12 UNITES



SERIE262

199,00€

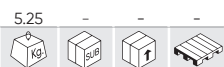

SPÉCIALE KIT DE POLISSAGE: MACHINE POLISSAGE PNEUMATIQUE + 12 KIT RESTAURATION PHARES

53626

x12u.



53646

x1u.



53729

19,10€

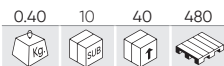

ENSEMBLE D'OUTILS DE REGLAGE LES PHARES

H6, H7, T25



52262

7,50€

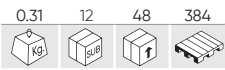

VENTOUSE 1 TÊTE Ø 115MM

40Kg
ø 115mm



52263

13,50€

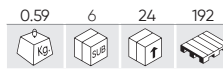

VENTOUSE 2 TÊTES Ø 115MM

70Kg
ø 115mm



52264

18,60€

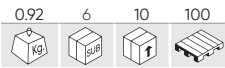

VENTOUSE 3 TÊTES Ø 115MM

100Kg
ø 115mm



52265

30,50€

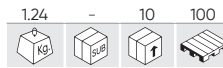

VENTOUSE 4 TÊTES Ø 115MM

120Kg
ø 115mm



52295

6,50€

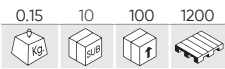

JEU DE DEUX MINI VENTOUSES Ø 60MM

5Kg
ø 60mm



52765

21,70€

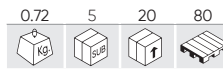

VENTOUSE 2 TÊTES ARTICULÉES Ø 120MM

80Kg
ø 120mm



52998

48,00€

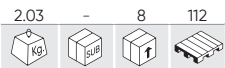

ENSEMBLE DE VENTOUSES ET CLIQUETS 5M X 25MM

80Kg
ø 120mm
5x25mm



53232

39,00€

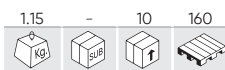

OUTILS POUR REMPLACEMENT DE VITRES

7
PCS



COMPREND

- 1x extracteur de moulures.
- 1x levier pour extraire la gomme.
- 1x crochet extracteur.
- 1x 1.8m de câble de coupe.
- 2x poignées pour le câble de coupe.
- 1x passe-câbles.

13813

7,00€

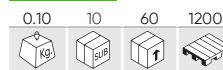

CÂBLE POUR EXTRACTION PARE-BRIS

POUR REF. 53232



13814

11,00€



OUTILS POUR EXTRACTION DE VITRES

POUR REF. 53232



TRAVAUX DE CARROSSERIE

52321 8,80€

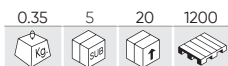

SANGLE DE FIXATION AVEC TENSEUR 5M X 25MM

5mx25mm



52327 12,00€

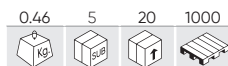

SANGLE DE FIXATION AVEC TENSEUR 8M X 25MM

8mx25mm



50577 12,60€



PINCE ÉTAU

CrV
280mm



52386 23,60€

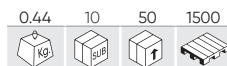

PINCE ÉTAU À BEC PERROQUET - BEC LISO

CrMo
215mm



52385



SET DE 6 PINCES À ÉTAU

251,00€



PINCE À VERROUILLAGE ET MÂCHOIRES

REF.	DESCRIPTION							€	
53675	PINCE À VERROUILLAGE ET MÂCHOIRES DROITES	10"	250mm	70mm	0.75	10	20	300	50,00€
53676	PINCE À VERROUILLAGE ET MÂCHOIRES COURBÉES	10"	250mm	90mm	0.85	10	20	300	44,00€
53677	PINCE À VERROUILLAGE, MÂCHOIRES COURBÉES ET SUPPORT ROTATIF	10"	250mm	80mm	0.90	10	20	300	55,00€
53678	PINCE À VERROUILLAGE ET MÂCHOIRES COURBÉES LONGUES	10"	300mm	105mm	0.90	10	20	300	52,00€



53675



53676



53677



53678



PRÉSENTOIR DE 10 UNITÉS

52982







JEU DE 3 PINCES ÉTAUX EXTRA LONGUES

53,00€

3 PCS
37cm 36cm 34cm



PINCE À VERROUILLAGE ET MÂCHOIRES

REF.	DESCRIPTION	mm	MATÉRIEL		T					€
52390	PINCE SPECIAL SOUDURE	250mm	CrMo	-	-	0.50	5	40	640	35,20€
52474	PINCE DE TIRAGE 5T	190mm	Acier	0-20mm	5T	3.49	-	5	1500	68,00€
52475	PINCE DE TIRAGE PLATE 3T	170mm	Acier	0-25mm	3T	3.60	-	10	1500	62,00€
52476	PINCE DE TIRAGE CARRÉ 5T	220mm	Acier	0-25mm	5T	3.10	-	10	1500	50,00€
52477	PINCE DE TIRAGE 2T	200mm	Acier	0-60mm	2T	2.65	-	6	1500	70,00€
52478	PINCE DE TIRAGE 90° 5T	170mm	Acier	0-20mm	5T	2.90	-	10	1500	49,00€
52479	PINCE DE TIRAGE PLATE 90° 3T	155mm	Acier	0-20mm	3T	1.18	-	30	1500	24,70€
52480	MINI PINCE DE TIRAGE CARRÉ 90° 3T	210mm	Acier	0-25mm	3T	2.00	-	10	1500	44,00€
52481	PINCE DE TIRAGE CARRÉ 3T	220mm	Acier	0-20mm	3T	2.05	-	10	1500	52,00€
52482	PINCE DE TIRAGE PLATE ANGLE 45° 5T	210mm	Acier	0-10mm	5T	2.13	-	8	1500	44,00€
52483	PINCE DE TIRAGE MINI 5T	210mm	Acier	0-10mm	5T	2.02	-	12	1500	41,00€
52484	UNIÓN CHÂINES 3T	275mm	Acier	0-110mm	3T	1.19	-	11	1500	66,00€
52485	UNIÓN CROCHETS 4T	270mm	Acier	0-90mm	4T	1.17	-	30	1000	51,00€
52486	UNIÓN CHÂINE CROCHET 3T	280mm	Acier	0-110mm	3T	1.21	-	11	1500	62,00€
52487	PINCE DE TIRAGE 5T	220mm	Acier	0-20mm	5T	2.27	-	7	1000	63,00€
52502	PINCE ÉTAU POUR SOUDURE	280mm	CrMo	0-110mm	-	0.84	10	30	540	31,40€
52503	PINCE ÉTAU POUR SOUDURE MACHOIRES AMOVIBLES	280mm	CrMo	0-105mm	-	0.85	10	30	540	32,50€
52504	PINCE ÉTAU POUR U ET CORNIERES 9"	225mm	CrMo	0-50mm	-	1.14	-	30	480	27,60€
52505	PINCE ÉTAU BLOCAGE	170mm	CrMo	0-40mm	-	0.27	36	72	2160	20,80€
52506	PINCE ÉTAU MACHOIRES AMOVIBLES	170mm	CrMo	0-50mm	-	0.28	36	72	2160	16,00€
52507	PINCE ÉTAU POUR U ET CORNIERES	250mm	CrMo	0-80mm	-	0.77	5	30	420	30,10€
52511	PINCE ÉTAU POUR SOUDURE 18"	440mm	CrMo	0-225mm	-	1.31	-	20	280	42,00€
52512	PINCE ÉTAU POUR SOUDURE MACHOIRES AMOVIBLES	440mm	CrMo	0-210mm	-	1.31	-	20	280	50,00€



53983

215,00€

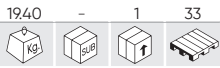

PORTE-PIÈCES - PARE-BRISE ET COQUE



12 TIGES DE 630MM
RECOUVERTES
DE MOUSSE DE
POLYÉTHYLÈNE
EXPANSÉ (EPE)

JUSQU'À 5 GRANDS
PANNEAUX OU VERRES

ROULETTES EN
POLYURÉTHANE (PU)
4" X 4" (DEUX ROULETTES
PIVOTANTES AVEC FREIN)

53125

477,00€

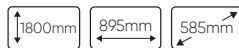
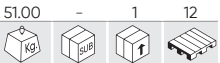

CHARIOT SPÉCIAL CARROSSERIE



x4 INCLUS

53124

287,00€



CHEVALET UNIVERSEL TÉLESCOPIQUE



HAUTEUR



LONGUEUR



50923

454,00€



CHARIOT CARROSSERIE



- Séparation: 0 à 110cm.

REF.	DESCRIPTION	Kg	Boîtes	Unités	Longueur	Prix
12022	ROUER POUR REF. 50923	194	-	10	1500	33,70€



53080 99,00€



CHEVALET POUR PARE-BRIS



70Kg

52749 79,00€

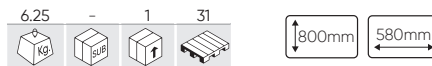

CHEVALET PLIABLE POUR CARROSSIER



220Kg

53079 89,00€



CHEVALET EN "X"



100Kg

MESURES DÉPLIÉ

660mm

600mm

870mm

MESURES PLIÉ

1140mm

600mm

300mm

REF.	DESCRIPTION	kg	box	€
11959	MOUSE POUR CHEVALET REF. 52749	0.08	100	10,50€

53736 98,00€



CHEVALET SUPPORT PARE-CHOCS



L'ANCRAGE RÉGLABLE PERMET QUE LE SUPPORT SOIT ADÉQUAT POUR TENIR DIVERS TYPES ET STYLES DE PARE-CHOCS

ANCRAGE RÉGLABLE: 75 CM -160CM

HAUTEUR MAXIMALE: 148CM

ACIER

53685 310,00€



SUPPORT DE PARE-CHOCS



RÉGLAGE DES BRAS DE SUPPORT DE 134 À 198 CM

4 ROUES DE 4 POUCES (DEUX PIVOTANTES AVEC FREIN)

ACIER ENDUIT DE POUDRE

53134 144,00€



SUPPORT ÉLÉMENTS POUR CARROSSERIE



150Kg

- 6 crochets pour serrer pièces pour peindre ou sécher.
- Cadre ajustable qui s'étend de 127cm à 203cm.

53126 243,00€



SUPPORT BASCULANT POUR ÉLÉMENT DE CARROSSERIE

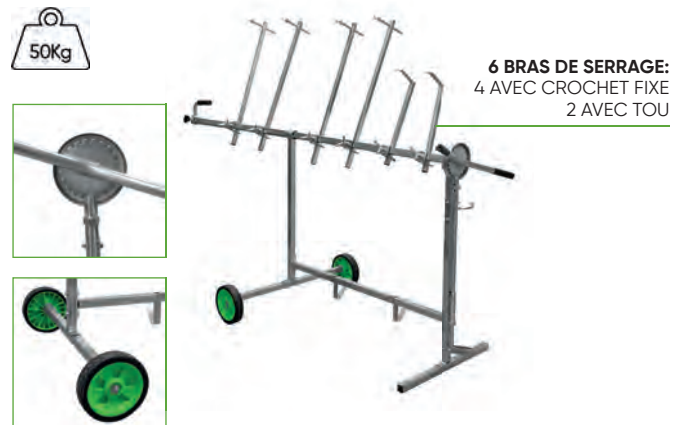

50Kg

6 BRAS DE SERRAGE: 4 AVEC CROCHET FIXE 2 AVEC TOU

52230

398,00€

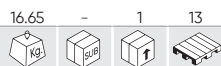
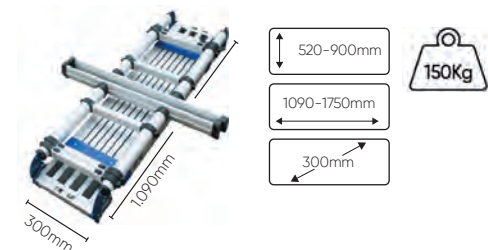

PLATE-FORME DE TRAVAIL TÉLESCOPIQUE



REF.	DESCRIPTION	KG	Sub	↑	↓	€
10964	PROTÈGE ANGLES POUR PLATE-FORME AVEC REF. 52230	0.01	-	1	-	9,00€
10965	EBÔUT POUR BARREAUX POUR PLATE-FORME REF. 52230	0.01	-	1	-	6,00€
10966	PIED DE RECHANGE POUR PLATE-FORME AVEC REF. 52230	0.06	-	1	-	13,50€

RENCONTRE AVEC: EN 131



50913

195,00€

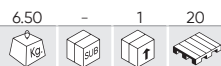

PLATE-FORME DE TRAVAIL EN ALUMINIUM



RENCONTRE AVEC: EN 131

50656

290,00€



JEU DE 2 PLATE-FORME DE TRAVAIL EN ALUMINIUM



RENCONTRE AVEC: EN 131

REF.	DESCRIPTION	KG	Sub	↑	↓	€
11897	100x30x30cm	4.66	-	1	16	155,00€
15552	130x30x55cm	6.80	-	1	18	181,00€

53922

29,00€

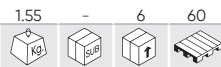

PORTE-ROULEAU PAPIER POUR MUR

- Acier inoxydable
- Rouleau: largeur max. 38 cm
- Pince - plastique ABS, gris.
- Vis et écrous de fixation en acier inoxydable.

PAPIER NON INCLUS



53921

39,00€

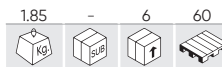

PORTE-ROULEAU PAPIER

- Matériau: acier inoxydable
- Rouleau: largeur max. 38 cm
- Pince - plastique ABS

PAPIER NON INCLUS



KIT PRÉSENTOIR MURAL + CONSOMMABLES D'ENTRETIEN VÉHICULE

50400 168,00€

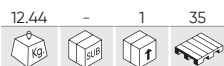

COMPREND

- 53705 PRÉSENTOIR MURAL NU
- 51978 ROULEAU DE HOUSSES DE SIÈGE
- 52057 BOBINE DE FILM COUVRE VOLANT
- 52058 MANCHE POUR BOBINE DE FILM
- 50409 BOITE DE 250 TAPIS PAPIER

50403 98,00€

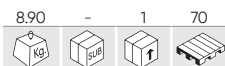

COMPREND

- 52065 PRÉSENTOIR MURAL NU
- 51978 ROULEAU DE HOUSSES DE SIÈGE
- 52057 BOBINE DE FILM COUVRE VOLANT
- 52058 MANCHE POUR BOBINE DE FILM

50410 168,00€



COMPREND

- 53705 PRÉSENTOIR MURAL NU
- 52244 ROULEAU DE HOUSSES DE SIÈGE
- 52057 BOBINE DE FILM COUVRE VOLANT
- 52058 MANCHE POUR BOBINE DE FILM
- 50409 BOITE DE 250 TAPIS PAPIER

PRÉSENTOIR MURAL NU

53705 80,00€

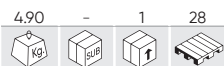

51985 84,00€

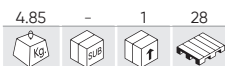

52065 45,00€



51978 84,00€



ROULEAU DE HOUSSES DE SIÈGE 25MC 250U.



250 PCS
25 mc

52244 84,00€



ROULEAU DE HOUSSE DE SIÈGE MODÈLE ANONYME 25MC 250 U



250 PCS
25 mc

52057 6,80€



BOBINE DE FILM COUVRE VOLANT

23 mc
- Longueur: 200m
- Largeur: 12,5cm
- Épaisseur: 23mc



REF. 52057

52058 4,50€



MANCHE POUR BOBINE DE FILM AVEC REF. 52057

23 mc

REF. 52058

TRAVAUX DE CARROSSERIE

50409

26,00€

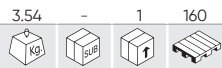

BOITE DE 250 TAPIS PAPIER

250
PCS



51824

36,80€

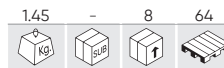

BOITE DE 250 HOUSSES DE VOLANT

250
PCS



50916

0.05 100 400 3200



KIT DE PROTECTION 5 EN 1

5
PCS 20
mc



0,88€



53226

14,90€

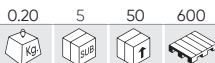

PROTECTION POUR SIÈGE DE VOITURE



- NYLON.
- UNIVERSEL.

51622

25,30€



PROTECTEUR MAGNÉTIQUE COUVRANT LES ANTENNES ET LES FRONTS



4 POINTS AIMANTÉS

DEUX FACES:
UNE EN VELOURS, UNE PLASTIQUE



MANCHE TÉLESCOPIQUE

REF.	Max.	Min.					€
52497	1200mm	530mm	0.29	6	48	480	26,80€
53196	1600mm	710mm	0.37	6	48	384	33,00€



FREINS

194 OUTILS DE TRACTION

197 PURGEUR DE FREINS

197 MAINTENANCE



52636

114,00€

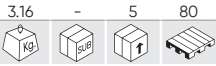

16 PCS

COFFRET REPOUSSE PISTON AVEC PISTOLET PNEUMATIQUE

- 0 General Motors (pistons Ø 2-1/2 pouces)
- 2 Citroën XM/Xantia (F/R), HONDA
Audi (F), Fiat, Alfa romeo (F), Ford Fiesta (F), Isuzu (F), Honda Concesto (F), Jaguar XJ6/ XJ40 (F/R), BMW 318is / 320i / 325T / 518i / 525i-1x / 740i / 850ci / M5 (F), Mercedes BENZ 190/200/300/420/560 serie (F), Mitsubishi Colt (F), Nissan Miera/Stanza/Sunny (F), Rover Austin/Metro200-400 series/Maestra/Montego (F), Toyota Camry (F), Volvo (F), VW Passat/Golf GTI (F)
- 3 Ford Australia/NZ Telstar, Mazda (R), Saab 9000 (R)/Lumina, Toyota, Fiat 164 2.0 (R), Alfa Romeo Prelude/CRS 16i, Honda Saturn (R)/Grand Prix, GM
- 5 Adaptateur 3/8"
- 6 Nissan Primera, VW Golf IV
Audi 80/90/V8+100/Coupe E (R), Rover 800 ABS, Subaru L+Z (R), Ford Sierra ABS/Granada/Scorpio ABS (R), Nissan Bluebird 1.8 Turbo/Silvia Turbo/Primera2.0i LS-GS-GSX (R), Peugeot 405 1.9Gi/Gri/Sri/Gtxi/Mi 16/605 2.0 Sri (R), Toyota Cecilia/Corolla GT/MR2 (R), VW Golf Gti/Jeta Synchron/Jetta Gti 16v, Passat CL, GL, GT, GT 16v, Corrado 16V scirocca GTX 16V(R), Citroën, Alfa romeo, Fiat, Honda, Jaguar, Renault, Saab, Seat, Lancia.
- 7 General Motors (pistons Ø 1-7/8 pouces)
- 9 General Motors (pistons Ø 2-1/8 pouces)
- A(Z) Renault (R21-Laguna (R))
- E Nissan Maximas/Cefiro
- F(G) Opel (Rear disk)/ Fiat Stilo
- K Citroën C5
- K1 Renault, Citroën C5

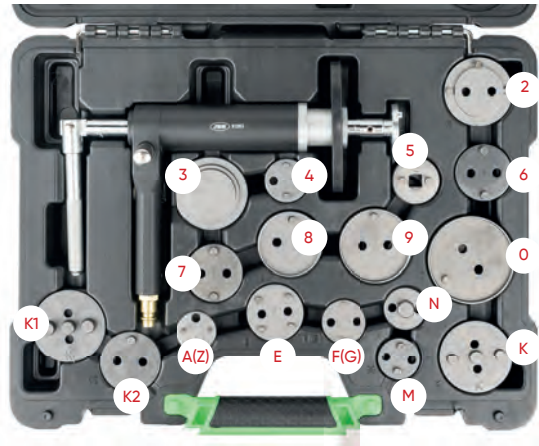

- K2 Renault, Citroën, Audi A8, S8
- M Ford, Mini Cooper, Nissan Primera 03
Saab, Honda, Alfa Romeo 164 2.0 Twin Spark/2.0 Turbo (88-)/3.0 V6, Audi 200 (80-)/Coupe GT SE (82-)/80/90/1Q0/200/Quattro (87-)/90/20V (88-), Ford Mondeo 2.0/Ghia, Lancia Themaalte (85-), Volkswagen Golf II GTI (83-87)/Sirocco 16V (84)
- N

52330

99,00€

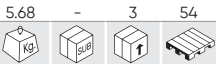

50 PCS OPEL PEUGEOT CITRÖEN RENAULT

COFFRET REPOUSSE PISTON

- 0 General Motors (pistons Ø 2-1/2 pouces)
- 1 Disc
- 2 Citroën XM, Xantia u.a.
- 3 Alfa Romeo,Audi, Austin, BMW, Ford, Honda, Jaguar, Mercedes-Benz. Mitsubishi, Nissan Rover, Toyota, VW
- 4 Alfa Romeo 164 2.0.Ford, Mazda, Saab 9000, Subaru
- 5 Adaptateur 3/8"
- 6 Nissan Primera, VW-Golf IV
Audi 8.0,90,V8 +100, Ford Sierra ABS+ Scorpio ab 85, Honda Prelude, Nissan Silvia 1.8 turbo, Rover 8000, Saab 9000, Subaru L+Z, VW-Golf+ Passat
- 7 General Motors (pistons Ø 1-7/8 pouces)
- 9 General Motors (pistons Ø 2-1/8 pouces)
- 11 Disc pour Jaguar Type S
- 12 Disc pour BMW mini
- A Nissan Premira 2.0, Bluebird
- A1 Ford Transit 06,Transit Connect 02,Tourneo Connect 02,Mondeo 00-07,C-Max 03, Focus 04
- B Ford, Lincoln, Subaru
- B1 Ford S-max 06,Scorpio 94-06,Mondeo 07,Kuga 08,Galaxy 00-06,Focus RS 03,Fiesta 01-02,Cougar 98-01
- C Nissan Primera (02), Opel Vectra 02-,Toyota Avensis
- D Citroën, Renault
- E Cefiro, Maxima
- F Peugeot 206 CC / Hdi / Gti. Elle exige un arrière 16mm à piston clé
- F1 Fiat Ducato
- G Opel
- G1 Volkswagen Golf V / VI
Alfa Romeo 155 1.8-2.0 164 TD(93) 164 3.0 V6(91), Audi 80,90,A3,A4,A6,A8, Citroen ZX 2 Ql 16V, Fiat Tipo TD 16V, Uno Turbo (85) Crama TD, Ford Sierra (ABS bak). Granada (85) Crama TD, Ford Sierra (ABS bak). (Australia& NZ) Thunderbird Turbo, Honda CRX, 1.6i-16V (8-90). Accord 1800 (84-85) 2.0i. Prelude 16V (88), Legend V6, Jaguar XJ 4, Oseries, Lancia Dadra 2.0, Ei Tur (93), Delta 1.6 Gti, Nissan, Peugeot, Renault, Seat, Subaru, Volvo V40 6S40.
- K Citroën C5
- K1 Citroën
- K2 Citroën, Renault.
- M Ford
- N Saab, Honda
- O Disc

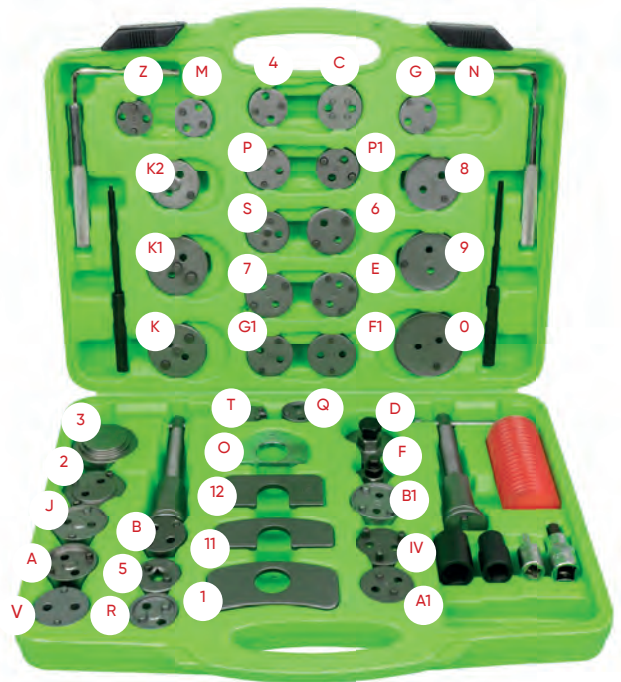

- P Audi, BMW, Ford, Lancia, Piston, Renault, Rover.
- P1 Peugeot 307,308.
Alfa Romeo 164 2.0 1., Fiat Uno, Turbo ie-Barchetta, Ford Escort MK III, Orion, XR31, Focus(98-) push-back pistons, Honda-most models (push-back pistons), Rover-most models(push-back pistons), Subaru Lserie & Serie 2
Ford(Australia& NZ) Teslar, Laser, Mazda 323 Gti. GTXX (86), 929 (82.), RX7(81-), 626
R 16V(87-) 626 GT (86-), 929 V6 (88-), Mitsubishi Galant GL Si, Toyota Celica, Corolla GT, MR2
Audi 100 TQ(91), BMW 740i 8cyl (91), Lancia Delta 1.9 TD (95), Proton 416. Renault-most models, Renault Laguna 2.0 (94), Laguna 2.2. D (95) Safrane 2.0-2.2 TD V6, Rover 623 Si, Volkswagen Golf Gtu Mk I&IV, Passat VR6, Vento GT (92)
- S
- T Rover 220 C Turbo (95)
- V Rover 216 Gti 16V,820 Si 2.0(93),825 SD 2.5 (93)
- Z Renault
- IV Iveco Daily, Volkswagen Passat 2.0 TDI 09-

53978

38,90€

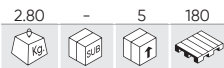
23
PCS

COFFRET REPOUSE PISTON - 23 PIÈCES

0	General Motors (pistons Ø 2-1/2 pouces)
1	Disc
2	Citroën XM, Xantia
3	Alfa Romeo, Audi, Austin, BMW, Ford, Honda, Jaguar, Mercedes-Benz, Mitsubishi, Nissan, Rover, Toyota, VW
4	Alfa Romeo 164 2.0, Ford, Mazda, Saab 9000, Subaru
5	Adaptateur 3/8"
6	Nissan Primera, VW.Golf IV
7	Audi 80;90;V8+100, Ford Sierra ABS+Scorpio de 1985, Honda Prelude, Nissan Silvia 1.8 turbo, Rover 8000, Saab 9000, Subaru L+Z, VW Golf + Passat
8	General Motors (pistons Ø 1-7/8 pouces)
9	General Motors (pistons Ø 2-1/8 pouces)
10	VW
K1	Citroën
A	Renault R21, Laguna
K2	Citroën
E	Nissan Maxima, Cefiro
M	Ford
F	Opel
N	Saab, Honda
K	Citroën C5
O	Disc

J Fiat Tipo TD 16V, Uno Turbo(85) Crama TD, Honda CRX, Alfa Romeo 155 1.8-2.0i, 164 TD (93), 164 3.0 V6 (91); Audi 80, 90, & V8's, A3, A4, A6, A8 (pinza trasera); Citroën ZX 2.0i 16v; Fiat Tipo TD 16V, Uno Turbo (85-), Crama TD; Ford Sierra (ABS bak), Granada (85-); Ford (Australia & NZ) Thunderbird Turbo; Honda CRX, 1.6i-16V (88-90), Accord 1800 (84-85), 2.0i (86-), Prelude 16V (88-), Legend V6; Jaguar XJ serie 40; Lancia Dedra. 2.0 Ei Tur(93), Delta 1.6 Gti. (92), The. majE 16v(92), Thema. 2000 Turbo. Kappa 2.Q-2.4LS, 2.4TD;

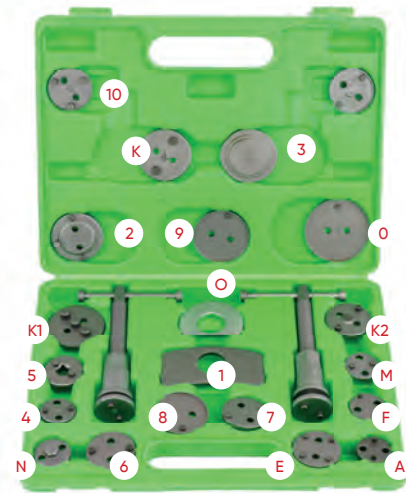

J Nissan 280 ZX (82-84), 300 ZX Turbo (84-89), Bluebird 16V (89-), Silvia 1.8 Turbo (85-88) 100 NZ 2.0 (93), Primera 2.0 GT (94), 200 SX turbo 16V, Maxima 2.0 GX-3.0 GX (95); Peugeot 306; Peugeot 309 Gtj 16S (91), 405. Srif Q. rj, Gil (87-), 405 M.1 16v; Renault Master Van; Rover 216 Gti 16V, 820 Si 2.0 (93), 825 SD 2.5 (93); Saab 9000 CS 2.0(93), 9000 CSE Turbo(93); Seat Toledo GT. 16V-GT 2.0(93), Ibiza 1.8 Gti 16V(95); Subaru Lserie & Serie 2; Volkswagen Passat 2.0 & 2.2 Litre(84), Golf Rallye (-89), Golf II Gti 16V(89-), Vento GT (92), Transporter T4; Volvo S40 & V40

51059

99,00€

37
PCS

COFFRET REPOUSE PISTON

0	Disc
1	Disc
2	Citroën XM, Xantia (F/R)
3	Alfa Romeo, Audi, Austin, BMW, Ford, Honda, Jaguar, Mercedes-Benz, Mitsubishi, Nissan, Rover, Toyota, VW.
4	Alfa Romeo 164 2,0,Ford,Mazada,Saab 9000,Subaru.
5	Adaptateur 3/8"
6	Nissan Primera,VW-Golf IV.
7	Audi 80,90,V8 +100,Ford Sierra ABS+Scorpio ab 85,Honda Prelude Nissan Silvia 1.8 turbo,Rover 8000, Saab 9000, Subaru L+Z, VW-Golf +Passat.
8	General Motors (pistons Ø 1-7/8 pouces)
9	General Motors (pistons Ø 2-1/8 pouces)
11	Disc pour Jaguar Type S
12	Disc pour BMW mini
A	Disque double axial de 1-3/16" pour Renault R21, Laguna
B	Ford, Lincoln, Subaru.
C	Mini Austin
D	Citroën, Renault.
E	Cefiro, Maxima
F	Opel Corsa, Astra, Zafiraand Vectra
G	Opel (disque arrière)
J	Alfa Romeo 155 1.8-2.0 164 TD(93) 164 3.0 V6(91) Audi,80,90,A3,A4,A6,A8 Citroën ZX 2 Qi 16V,Fiat Tipo TD 16V,Uno Turbo(85) Crama TD, Ford Sierra(ABS bak),Granada (85),(Australia & NZ) Thunderbird Turbo,Honda CRX,1.6i-16V (8-90),Accord 1800(84-85)2.0i,Prelude 16V(88),Legend V6,Jaguar XJ40series,Lancia Dedra 2.0 Ei Tur(93),Delta 1.6Gti,Nissan,Peugeot, Renault,Seat,Subaru,Volvo V40& S40.
K	Citroën C5
K1	Citroën, Renault.
K2	Citroën, Renault.
M	Ford
N	Saab,Honda. Z: Renault
O	GM Motors.
P	Audi, BMW, Ford, Lancia, Proton, Renault, Rover, VW
R	Ford (Australia & NZ) Telstar,Laser, Mazda 323 Gti,GTX(86-),929(82-),RX7(81-),626 16V (87-), 626 GT (86-),929 V6(88-),Mitsubishi Galant GL Si, Toyota Celica,Corolla GT,MR2.
S	Audi 100TQi(91), BMW 740i 8cyl.(91), Lancia Delta 1.9 TD(95), Proton 416, Renault-most models, Renault Laguna 2.0 (94), Laguna 2.2 D(95), Safrane 2.0-2.2 TD V6, Rover 623 Si, Volkswagen Golf Gti Mk 3&4,Passat VR6,Vento GT(92).

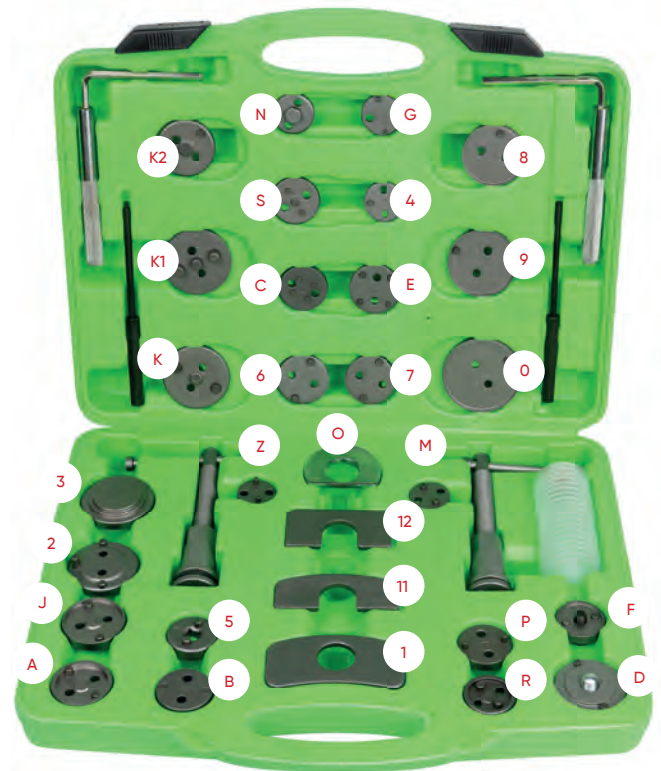

Z BMW, Mini

Caliper rotation à droite (avec filetage à droite)

Grappin rotation à gauche (avec filetage à gauche)

Pin Ø 3.0/ Pin Ø5.5 (100g Fat)

52906

38,00€



COFFRET REPOUSSE PISTON FREINS UNIVERSELLES



REF. DESCRIPTION

REF.	DESCRIPTION	kg	dm³	Q	€
12974	RECHANGE 2 PINS POUR REF.52906	0.50	-	50	21,00€
12975	RECHANGE 3 PINS POUR REF.52906	0.17	-	50	23,00€



ALFA ROMEO 164 2.0, FORD, MAZDA, SAAB 9000, SUBARU, NISSAN PRIMERA, VW, AUDI, FORD SIERRA ABS + SCORPIO AB 85, HONDA PRELUDE, NISSAN SILVIA 1.8 TURBO, ROVER 8000, SAAB 9000, FORD, OPEL, BMW, LANCIA, PROTON, RENAULT, ROVER, PEUGEOT 307, 308 A3- IVECO DAILY, VOLKSWAGON PASSAT 2.0 TDI 09, RENAULT LAGUNA.

53683

116,00€

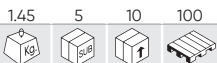

PISTOLET REPOUSSE PISTON FREINS - PROFIL BAS

- Pression normale d'usage: 5-8 bar.
- Pression maximale de travail: 14 bar.



51283

78,00€

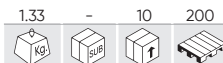

PISTOLET REPOUSSE PISTON FREINS PNEUMATIQUE

- Pression normale d'usage: 5-8 bar.
- Pression maximale de travail: 14 bar.



52191

198,00€

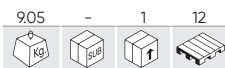

PURGEUR DE FREIN PNEUMATIQUE

5L

- Pression de travail: de 0 à 4 kg/cm² .
- Entrée et de sortie de 1/2".
- Poids: 5kg .
- Nombre d'adaptateurs: 11 + 2 universels.
- Domaines d'application: GM, Chrysler, Nissan.



REF. DESCRIPTION

52328 BOUCHONS POUR PURGUEUR DE FREIN POUR REF.52191

2.90 - 4 64 99,00€

52434

125,00€

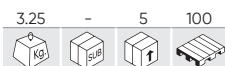
15
PCS

COFFRET POUR RÉPARATION ET ENTRETIEN DES FREINS

- x2 Clés pour vis de frein
- x1 Pinces de ressort de frein
- x1 Rournevis à choc
- x3 Douilles torunevis
- x1 Outil d'Assemblage
- x1 Tournevis avec articulation universelle
- x1 Outil special frein
- x1 Brosse
- x1 Brosse en laiton
- x1 Outil d'assemblage
- x1 Pince de câble de frein
- x1 Lime pour pince de frein



54135

82,00€

17
PCS

JEU DE DOUILLES POUR ÉTRIER DE FREIN

CONTIENT

	x2	14x38, 22x38mm
	x3	11,50x38, 15x38, 20x38mm
	x4	10, 12.50, 14, 19mm
	x1	10mm
	x4	H11x100, H7x70, H7x92, H9x50mm
	x2	7x24, 8x24mm
	x1	9x20mm



AUDI (A4, A5, S5, S8, Q5, Q7), PORSCHE (CAYENNE, MACAN, CAYMAN), MERCEDES BENZ, FORD, BMW, ALFA ROMEO

54372

157,00€



N

ENSEMBLE DE TESTEURS DE FREINS AVEC ET SANS ABS

Conçu pour la désinstallation des étriers de frein lors du remplacement des plaquettes de frein.

APPLICATIONS

Audi (TT (2007-), A4 (2001-), A6 (2005-), A8 (2003-), Q7, S5, S6, S8), Porsche (Cayenne, Macan, Cayman), Mercedes-Benz (ML320, Classe C), Ford (Mondeo, Fiesta, Focus, Edge), BMW (Series 3 -generación E36 / 5), Alfa Romeo, Jaguar (XF), Vauxhall, Volkswagen, Chrysler, Mini, SAAB

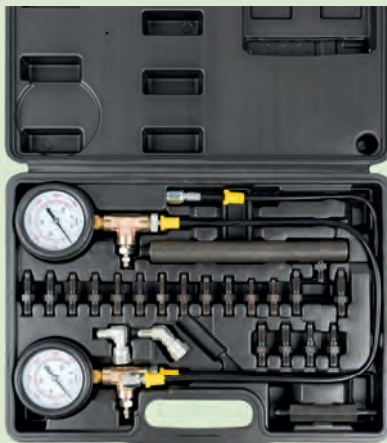

CONTIENT

- x1 Adaptateur Teves
- x1 Raccord tournant 45°
- x1 Raccord tournant 90°
- x2 Raccord droit 7/16-24
- x2 Raccord droit 1/4-28
- x2 Raccord droit 3/8-24
- x2 Raccord droit 5/16-24
- x2 Raccord droit M10-1.5
- x2 Raccord droit M8-1.25
- x2 Adaptateur pour purgeur M10-1.0
- x2 Raccord droit 7/16-20
- x2 Raccord droit M7-1.0

52625

9,00€

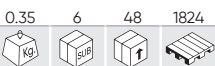

PINCE POUR RESSORT DE FREIN



- Pour extraire et installer les ressorts de retour des freins.

52315

16,00€

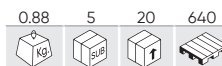

REPOUSSE PISTON MANUEL DE FREINS



51839

24,00€

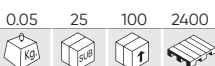

TESTEUR LIQUIDE DE FREIN

- Fonctionne avec des piles 1xAAA LR03.
- Avec 4 niveaux de qualité mesurables de 0% à 4 %.



52455

16,00€

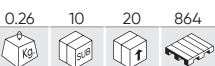

JEU DE JAUGES D'ÉPAISSEUR POUR PLAQUETTES DE FREIN

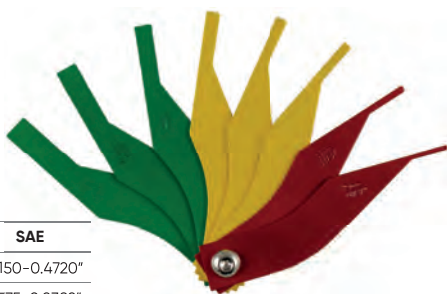

COULEUR	METRIC	SAE
Vert	8-10-12mm	0.3150-0.4720"
Jaune	4-5-6mm	0.1575-0.2382"
Rouge	2-3mm	0.0787-0.1181"

52275

38,00€



PURGEUR DE FREINS PNEUMATIQUE



- Température de fonctionnement: 10°C à 50°C.
- Tuyau en silicone: 2m.
- Pistolet de soufflage entrée d'air 1/4".
- Pression d'air: 6-12 bar (87 - 174 psi).
- Admission d'air: 180l/min.

OUTIL SPÉCIAL

- 200 SYSTÈME DE LUBRIFICATION
- 206 EXTRACTEURS D'INJECTEURS
- 213 BLOC/CYLINDRE
- 216 EMBRAYAGE
- 217 SYSTÈME DE REFROIDISSEMENT
- 219 SYSTÈME A/C
- 221 TRANSMISSION
- 223 SUSPENSION
- 229 ÉCHAPPEMENT
- 231 SYSTÈME ÉLECTRIQUE
- 235 RÉPARATION DE BOBINES
- 238 MOTO
- 238 EXTRACTEURS



54068

120,00€

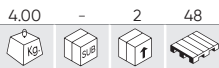

JEU DE CLÉS POUR FILTRES À HUILE EN ALUMINIUM, 19 PIÈCES

REF.	N° DE PIÈCES	DESCRIPTION	PANS x Ø				€
15494	05101	Mazda, Mitsubishi	15 x 100,5mm	0.18	-	50	12,50€
15495	0595	Nissan, Toyota	15 x 94,5mm	0.18	-	50	12,50€
15496	0592	Nissan, Subaru	15 x 92mm	0.18	-	50	11,50€
15497	0579	Toyota, Honda, Mitsubishi, Subaru, Mazda, Lsuzu	15 x 79mm	0.14	-	50	11,00€
15498	915	Volvo	16 x 87mm	0.24	-	50	11,50€
15499	901L	Lexus	14 x 79,5mm	0.15	-	50	11,00€
15500	901T	Toyota	14 x 70mm	0.13	-	50	10,00€
15501	901-1	Toyota	14 x 63-64mm	0.10	-	50	10,00€
15502	902	Ford, Mazda	14 x 66,5mm	0.89	-	50	10,00€
15503	1284	Dodge Sprinter (2007-), Mercedes Benz E320 (2007-), Jeep Cherokee 3.0L V6 Common Rail (2007-)	14 x 84mm	0.13	-	50	11,00€
15504	903B	Mercedes Benz	14 x 74mm	0.13	-	50	10,00€
15505	24mm	BMW 5, BMW 7, BMW X5 V8 (N62) (2004-), Saturn (2008), Astra 1.8L ECOTEC, Chrysler 3.6L V6 (2011-), 200, 300, T/C Dodge Jeep	6 x 24mm	0.47	-	50	4,00€
15506	27mm	Mercedes Benz Classe A	6 x 27mm	0.45	-	50	4,00€
15507	30mm	Audi A2, Vw Polo, Lupo 1.4L/1.6L	6 x 30mm	0.44	-	10	4,50€
15508	32,5mm	Opel Astra G, Corsa B, Zafira, Audi, VW 1-36 mm, Opel Omega, Vectra B, Zafira (98-), BMW M43/60)	6 x 32,5mm	0.45	-	50	4,50€
15509	36mm	Opel Omega, Vectra B, Zafira (98-), BMW M43/60, Mercedes Benz Vito CDI, C, E, VW Lupo 1.2 TDI, MAN	6 x 36mm	0.48	-	50	5,00€
15510	38mm	Opel Vectra 2.0D	6 x 38mm	0.50	-	50	5,00€
15511	917	Universal	55-90mm	0.22	-	50	8,00€



51332

98,00€



COFFRET CLOCHES POUR FILTRES À HUILE

REF.	N° DE PIÈCES	DESCRIPTION	PANS x Ø				€
11374	901	Toyota, Nissan, Fiat Daihatsu	14 x 65mm	0.05	5	20	5,50€
11375	902	Toyota, Daihatsu	14 x 67mm	0.45	5	20	6,50€
11376	903	VW, Mercedes, BMW, Opel, Audi	14 x 74mm	0.20	5	20	5,50€
11377	903-1	GM/AC, Wix, Ford, Isuzu	15 x 75mm	0.09	5	20	5,50€
11378	903-2	VW, Audi, Seat, BMW, Renault	8 x 74mm	0.09	5	20	6,50€
11379	903-3	Audi, Rover, Chrysler	15 x 74mm	0.11	5	20	6,00€
11380	903-4	Toyota, Lexus	14 x 73mm	0.11	5	20	6,50€
11381	903-6	Schlepper, Baumashinen	12 x 75mm	0.10	-	20	6,50€
11382	918	Rover, Chrysler, Audi	15 x 74mm	0.11	5	20	6,00€
11383	904	Nissan, Ford	15 x 79mm	0.50	5	20	6,00€
11384	905	GM, Chrysler	15 x 73mm	0.12	5	20	6,00€
11385	905-1	BMW, Mercedes, Opel, Audi, VW	14 x 74mm	0.10	5	20	5,50€
11386	906	Baumashinen, Schlepper	18 x 84mm	0.10	5	20	6,00€
11387	907	Mitsubishi, Toyota	15 x 89mm	0.13	5	20	6,00€
11388	908	Nissan, Toyota	15 x 91mm	0.14	5	20	6,00€
11389	915	Honda Accord, Mitsubishi, Isuzu	15 x 90mm	0.16	5	20	6,00€
11390	910	Toyota, Alfa Romeo, Ford	15 x 95mm	0.12	5	20	6,00€
11391	911	Fiat, Renault, Citroën	12 x 76mm	0.09	5	20	6,50€
11392	911-1	Subaru, Toyota, Honda, Nissan	15 x 80mm	0.09	5	20	6,00€
11393	914	Mazda, Toyota	15 x 101mm	0.18	5	20	6,00€
11394	909	Isuzu, Nissan	15 x 92mm	0.14	5	20	6,00€



REF.	DESCRIPTION				€
14992	CLÉ À 12 PANS POUR RÉF. 51332/ RÉF. 14141	0.14	-	100	8,50€
10955	CLIQUET 1/2" POUR EXTRACTEUR DE FILTRE 51332	0.14	-	50	11,00€

CLOCHES EXTRACTION FILTRE À HUILE

REF.	PANS x Ø	DESCRIPTION						€
52311	42mm	GRUPO VAG	0.13	6	72	1728		19,00€
52312	14 x 74mm	VW, OPEL, MERCEDES, BMW, AUDI	0.10	10	100	1000		9,00€
52313	16 x 86mm	VOLVO 540, 560, 570, 580	0.20	6	68	1008		8,00€
52314	16 x 87mm	BMW, VOLVO	0.20	5	50	600		26,60€
52809	14 x 64,5mm	TOYOTA	0.15	10	100	1000		8,50€
53441	14 x 76mm	-	0.20	5	20	800		9,80€



53008

15,50€

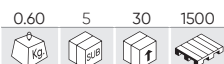

EXTRACTEUR DE FILTRE À HUILE POUR FORD, CITROËN, PEUGEOT 2.0, 2.2 HDI, TDCI



52518

115,00€



CLÉ À FILTRE DE CAMION 95-165MM



52615

112,00€



COFFRET DE 9 CLOCHES POUR FILTRES À HUILE

- Clé à double sens ajustable.
- Rang d'application: 60-80mm.

1/2"	x1	Universal	63 - 83mm
		Mercedes Benz, Smart	27mm
	x3	GM, Opel, Vauxhall, Mercedes Benz	32mm
		Mercedes Diesel, BMW, Mini, Ford	36mm
		Toyota (Allion, Auris, Corolla, Prius, Voxy, etc.)	64,5mm
3/8"	x3	Toyota, Lexus (6 Zyl.).	64,5mm
		Audi, BMW, Ford, Toyota, Volkswagen, Porsche, Mercedes-Benz	74,2mm
	x1	Hunday, Kia.	88,8mm
	x1	BMW 3+5+X, Volvo	86,6mm



9
PCS

CLÉ A FILTRE À 3 BRAS

51352

9,80€

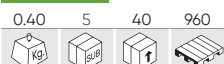

1/2" - 3/8"
57-118mm
Ø2-1/4" ~ 5"

51353

11,50€



1/2" - 3/8"
72-136mm
Ø2-1/2" ~ 4"

51923

12,50€



1/2" - 3/8"
72-136mm
Ø2-1/2" ~ 4"

51934

11,50€



1/2" - 3/8"
57-118mm
Ø2-1/2" ~ 4"

53206

38,20€

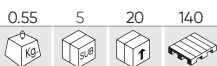

5
PCS

JEU DE 5 JAUGES NIVEAU D'HUILE POUR BENZ/AUDI

- Pour le control du liquide de transmission d'huile dans les moteurs Audi 100:
 - La première lecture est à froid à 20 °C.
 - La deuxième à 80 °C.
 - La troisième lecture est à 80 °C maximum.
- La jauge moteur pour vérifier le niveau d'huile est compatible avec une large sélection de moteurs de 1988 à 2005 dans la gamme Mercedes.

	Mercedes-Benz	920mm	- Code de transmission: 716.5,722.7,722.8.
	Mercedes-Benz	930mm	- Année de fabrication: 1988-1997. - Codes moteur: 103,104,111,119,120,137,604,605,606,611,612,613,628,642,647,648.
	Mercedes-Benz	930mm	- Année de fabrication: 1996-2005. - Codes moteur: 103,104,111,112,113,119,120,137,271,272,604,605,606,611,612,613,628,642,646,647,648.
	Mercedes-Benz	1200mm	- Code de transmission: 722.6.
	Audi	1160mm	- AUDI 100 moteurs.



REF.	DESCRIPTION					€
13856	BAGUETTE POUR CONTROL D'HUILE AUDI	0.04	5	100	-	7,80€

51354

13,20€



PINCE POUR FILTRES À HUILE

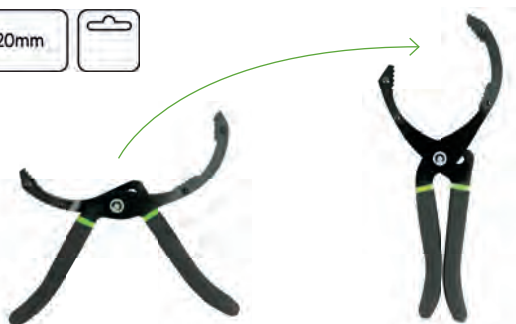

53670

29,50€



CLÉ POUR FILTRE À HUILE POUR VAG DSG 1/2" 24 MM



- Ensemble d'outils pour la réparation et la remise en état des boulons de roue, ainsi que pour son ancrage dans le filetage femelle du véhicule; utile dans les discussions partiellement endommagées.



52269

7,00€

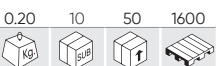

CLÉ À SANGLE REGLABLE

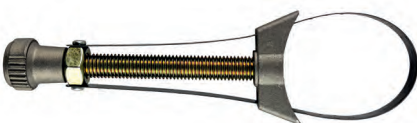

52677

17,00€

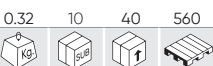

CLÉ À SANGLE RÉGLABLE Ø65-105MM



52678

18,00€



CLÉ À SANGLE RÉGLABLE Ø110-155MM



RECHANGE

REF.	mm				€
11106	360mm	0.02	10	50	3,00€

RECHANGE

REF.	mm				€
11936	383mm	0.15	5	300	4,00€

RECHANGE

REF.	mm				€
11937	540mm	0.04	10	100	5,00€

CLÉS À

52417 28,00€

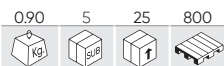

Ø160-300mm



CHAÎNE À HAUTE RÉSISTANCE

52416 14,00€

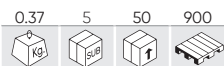

Ø150-540mm



COURROIE EN POLYMÈRE
(HAUTE RÉSISTANCE)

52607 49,00€

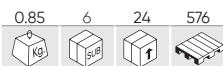

Ø60-140mm



DOUBLE CHAÎNE

52608 44,00€

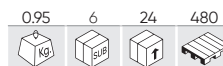

Ø60-195mm



DOUBLE CHAÎNE

53735



COFFRET DOUILLES DE VIDANGE 23PCS

44,00€

23 PCS 3/8"

CONTIENT

	x2	5/16", 3/8"	
	x7	7, 8, 10, 11, 12, 13, 14mm	
	x1	10mm	
	x1	10mm	
	x7	8, 9, 10, 12, 13, 14, 17mm	
	x1	T45	
	x1	M16	
	x1	200mm	
	x2	75, 150mm	

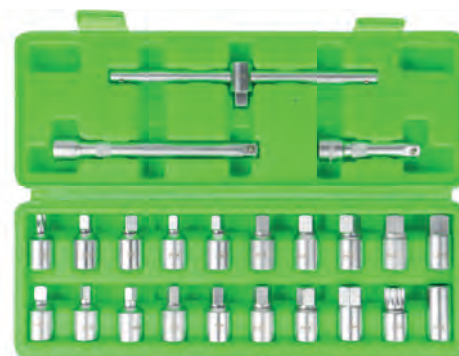

15084



BLOC D'EXTRACTION DE BOUCHONS DE CARTER

68,00€

240mm 135mm 32mm

CONTIENT

	x2	5/16", 3/8"
	x7	7, 8, 10, 11, 12, 13, 14mm
	x1	10mm
	x1	10mm
	x7	8, 9, 10, 12, 13, 14, 17mm
	x1	T45
	x1	M16
	x1	200mm
	x1	150mm



CONVIENT ÉGALEMENT POUR LES COLLECTEURS D'HUILE RÉF. 53873 ET 53874.

SET DE RÉPARATION DE VIS POUR BOUCHON DE CARTER

53235 10,40€

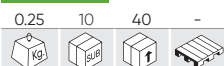

M13



53236 11,50€

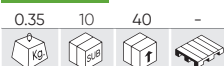

M15



53237 12,90€

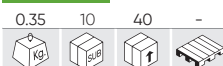

M17



53238 18,40€



M20



OUTIL SPÉCIAL

JEU DE 5 BOUCHONS PLASTIQUE D'ÉVACUATION D'HUILE

5
PCS

REF.	DESCRIPTION					€
13969	VAG	0.02	10	100	-	19,00€
53537	BMW	0.05	10	100	4000	14,50€
53538	Ford	0.10	10	100	4000	14,50€
53741	Ford / PSA	0.05	10	100	4000	14,00€



53472 12,00€

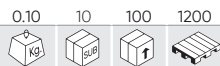

CLÉ POUR BOUCHONS PLASTIQUES D'ÉVACUATION D'HUILE (VAG)



OEM:T10549



52617 7,00€



CLÉ DE VIDANGE

- Pour Citroën, Renault, Peugeot.

8-10mm



53473 36,00€

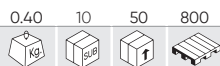

JEU D'OUTILS POUR BOUCHONS PLASTIQUES D'ÉVACUATION D'HUILE

5
PCS



A	x1	3/8"	80x100mm	Ford	OEM 1830727
B	x1	1/4"	1,5mm	VAG	OEM 06L 103 801
C	x1	1/4"	10mm	BMW	OEM 11137605018
D	x1	3/8"	3mm	Peugeot/Citroën	OEM 9801444780/OEM18711598
E	x1	1/4"	- 3/8"		

52754 54,00€



COMPRESSIOMETRE HUILE

0-10
BAR

0-140
PSI

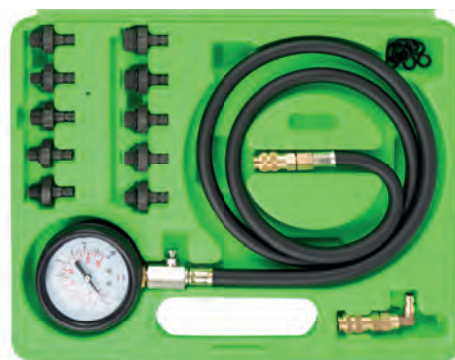

x1	M10x1.0mm
x1	M12x1.5mm
x1	M14x1.5mm
x1	M16x1.5mm
x1	M18x1.5mm
x1	1/8" DIN 2999
x1	1/8" x 27 NPT
x1	1/4" x 18 NPT
x1	3/8" x 20 UNF
x1	1/2" x 20 UNF

51337 50,00€

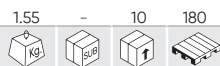

COFFRET DE REPARATION DES BOUCHONS DE CARTERS D'HUILE

24
PCS

- Bouchons de SKS3.
- Tarauds de 1015.
- Rondelle de Cuivre.

CONTIENT

- M13x1,5P
- M15x1,5P
- M17x1,5P
- M20x1,5P
- Tarauds: 1 x mesure
- Bouchons: 5 x mesure
- Rondelles: 10 x mesure

PIÈCES DE RECHANGE DISPONIBLES

	REF.	DESCRIPTION				€
	A 51400	M15 x 1.5P	0.15	50	100	17,00€
	B 51401	M17 x 1.5P	0.14	50	100	22,00€
	C 51402	M20 x 1.5P	0.10	25	50	20,50€
	D 51403	M13 x 1.5P	0.15	50	100	17,50€
	E 14930	M13 x 1.5P	0.05	10	100	9,50€
	F 14931	M15 x 1.5P	0.05	50	100	8,00€
	G 14932	M17 x 1.5P	0.07	5	100	9,50€
	H 14933	M20 x 1.5P	0.10	5	100	9,50€

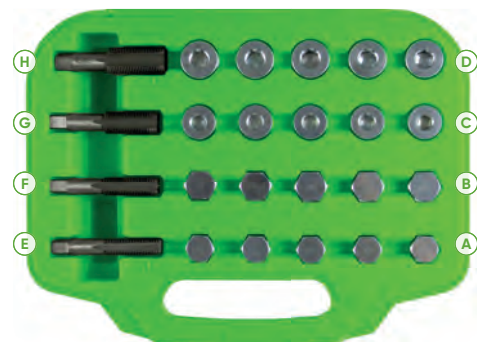

53485

140,00€



ÉTUI REMPLISSABLE D'HUILE AVEC ENTONNOIR ET ADAPTATEURS



- A Adaptateur de filetage M42 x 4,5 pour Subaru
- B Adaptateur de filetage M37 x 3,0 (type court) pour Lotus, Pontiac, Scion et Toyota
- C Adaptateur de filetage M35 x 4,0 pour Ford, Jaguar, Land Rover et Mazda
- D Adaptateur de filetage M32 x 3,5 pour Acura, Dodge, Ford, Honda, Jaguar, Jeep, Land Rover, Mazda et Nissan
- E Adaptateur à baïonnette pour Toyota et Lexus 3.0 et 3,3 l V6
- F Adaptateur à baïonnette pour Audi, BMW, Mercedes-Benz, Porsche, Volvo, VW et VW
- G Adaptateur de filetage M30 x 3,0 pour Dodge Cummins
- H Adaptateur de filetage (1/2 tour) pour Mazda 3/6/CX-5
- I Adaptateur de filetage (1/2 tour) pour Cadillac, Chevy, Ford, GMC, Hyundai, Jaguar, Land Rover, Mazda, Saab et Mercury
- J Adaptateur de filetage (1/4 de tour) pour les nouveaux bouchons de remplissage à partir de 2088 sur Audi, Seat, Skoda et VW avec moteur EA888
- K Adaptateur de filetage (1/2 tour) pour Dodge Hemi 6,4 L (2011-) et >3,6 L (>2014)
- L Adaptateur de filetage M37 x 3,0 (type long) pour Toyota, Lexus, Scion et Pontiac

53347

100,00€



ETUI REMPLISSABLE D'HUILE AVEC ENTONNOIR ET ADAPTATEURS



- A Adaptateur de filetage M42 x 4,5 pour Subaru
- B Adaptateur de filetage M37 x 3,0 pour Lotus, Pontiac, Scion, Toyota
- C Adaptateur de filetage M35 x 4,0 pour Ford, Jaguar, Land Rover, Mazda
- D Adaptateur de filetage M32 x 3,5 pour Acura, Dodge, Ford, Honda, Jaguar, Jeep, Land Rover, Mazda, Nissan
- E Adaptateur à baïonnette pour Toyota et Lexus 3,0, 3,3 l V6
- F Adaptateur à baïonnette pour Audi, BMW, Dodge, Mercedes-Benz, Porsche, Volvo, VW

52305

106,00€



COFFRET EXTRACTEURS BOUGIES PRÉCHAUFFAGE ENDOMAGÉES

16 PCS



- Extracteur de bougie de préchauffage de 16 pièces. Ce kit est utile pour l'extraction, cassé ou bloqué.
- Universel et idéal pour les moteurs Mercedes-Benz CDI.
- Extrait réchauffeurs cassés ou endommagés M8 et M10.
- Comprend les robinets 1/4" M8 et forets étagés de haute résistance double taille M8 et M10.

51494

107,00€



COFFRET D'EXTRACTION D'INJECTEURS

9 PCS S



- | | | | | | |
|--|------------|------------|--|----------------------|----------|
| | M12 x 1.75 | M8 x 1.5 | | M14 x 1.5 | M8 x 1.5 |
| | M14 x 1.5 | M17 x 1.5 | | M14 x 1.5 | |
| | M14 x 1.5 | M27 x 1.0 | | HRC: Hardness 30 -35 | |
| | M14 x 1.5 | M12 x 1.75 | | 1.75Kg. | |
| | M14 x 1.5 | M8 x 1.5 | | | |

54220

197,00€

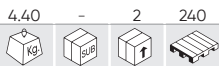

COFFRET À OUTIL D'INSTALLATION ET DE DÉMONTAGE D'INJECTEURS DE CARBURANT POUR BMW MERCEDES BENZ

MARQUES	<p>BMW: 135IS (2008-), 335 (2007-), 335XI (2007-), 535I (2008-), 535XI (2008-), 550I GT (2010-), 750Li (2009-), 750i (2009-), X3 3.0i (2007-), X5 (2011-), X5 3.0i (2008-), X6 (2008-)</p> <p>MERCEDES-BENZ: C-CLASS (2007-), CLK / SLK (2007-), E-CLASS (2007-), A / CLA / GLA 45 AMG (2013-), CL / CLS 63 AMG (2010-), E / G / GL 63 AMG (2011-), GLE 63 AMG (2015-), S / SL 63 AMG (2010-), SLK 55 AMG (2012-)</p>
OUTILS OEM	<p>BMW: 130180(1), 130195(2), 130270(3), 130320(4), 2249115(5)</p> <p>MERCEDES-BENZ: 271589023300(6), 278589003300(7)</p>
CODES MOTEUR	<p>BMW: N14 / N18 / N20 / N47 / N54 / N57 / N55 / N63</p> <p>MERCEDES-BENZ: M133 / M152 / M157 / M270 / M271 / M274 / M276 / M278</p>

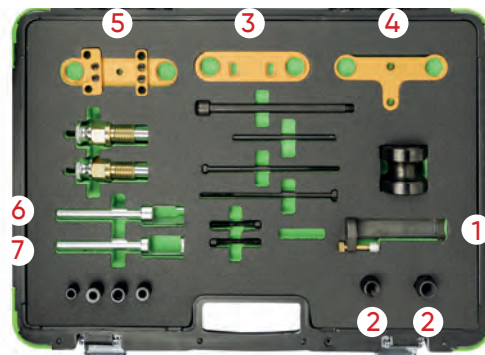

52815

110,00€



COFFRET EXTRACTEURS BOUGIES DE PRECHAUFFAGE

22 PCS



53250

85,00€



COFFRET D'EXTRACTEURS DE ROULEMENTS INTÉRIEURS ET EXTÉRIEURS

5 PCS



53069

98,00€



COFFRET D'EXTRACTEUR D'INJECTEURS DIESEL POUR CITROËN, PEUGEOT

9 PCS

CITROËN, PEUGEOT



- x1
- x3
- x2 Ø 17mm
- x2 Ø 25mm
- x2 25mm
- x2 29mm
- x1 21mm

52629

99,00€

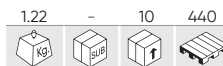

COFFRET D'EXTRACTION D'INJECTEUR POUR MERCEDES

3 PCS

MERCEDES



M16x1.5

51493

68,00€

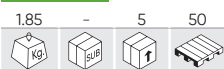

COFFRET AVEC JAUGE ET TESTEUR DU SYSTÈME D'INJECTION

31 PCS

BOSCH, SIEMENS, DENSO, DELPHI

Le but de cet instrument est de mesurer rapidement et efficacement la quantité de carburant que chaque injecteur renvoie au réservoir d'essence, de sorte à savoir si un injecteur déterminé est endommagé. Adéquat pour un usage sur Bosch, Siemens, Denso et Delphi injecteur.

COMPREND

- Perche à accrocher avec 6 bouteilles de mesure graduées
- Tubes de mesure
- Tubes blancs de remise
- Étui de stockage.



REF. DESCRIPTION



12901 BOUTEILLE + TAMPON + TUYAU POUR REF.51493 0.03 10 60 - 5,20€

54391

221,00€



TESTEUR DE BUSES D'INJECTEURS DIESEL

0-60 MPA 5-8 BAR 0-600 BAR 0-8700 PSI M12 M14

Cet outil vous permet de vérifier l'état des injecteurs tout en y appliquant une pression. Il est spécialement indiqué pour vérifier le schéma d'atomisation et la pression d'ouverture des injecteurs.

x1 M12
x2 M14



54392

1.855,00€

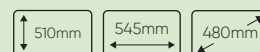

NETTOYEUR ET TESTEUR D'INJECTEUR GDI/EFI

220V 60W 50-60 Hz
0,1-10 BAR 5-8 BAR
<85% -10°C 40°C

Ce produit permet de nettoyer et de vérifier le bon fonctionnement des injecteurs GDI et EFI. Grâce à son microcontrôleur, la machine peut simuler les conditions réelles de fonctionnement du moteur. De cette façon, vous pouvez voir le comportement de chaque injecteur et y détecter d'éventuels défauts.

Pour nettoyer les injecteurs, utilisez le nettoyage par ultrasons, garantissant ainsi l'élimination complète de tout résidu pouvant être présent dans les injecteurs essence et diesel. Pour les systèmes EFI, cela inclut également.



TUTORIEL VIDÉO

54220

197,00€

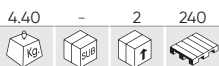

COFFRET À OUTIL D'INSTALLATION ET DE DÉMONTAGE D'INJECTEURS DE CARBURANT POUR BMW MERCEDES BENZ

MARQUES	<p>BMW: 135IS (2008-), 335 (2007-), 335XI (2007-), 535I (2008-), 535XI (2008-), 550I GT (2010-), 750Li (2009-), 750i (2009-), X3 3.0i (2007-), X5 (2011-), X5 3.0i (2008-), X6 (2008-)</p> <p>MERCEDES-BENZ: C-CLASS (2007-), CLK / SLK (2007-), E-CLASS (2007-), A / CLA / GLA 45 AMG (2013-), CL / CLS 63 AMG (2010-), E / G / GL 63 AMG (2011-), GLE 63 AMG (2015-), S / SL 63 AMG (2010-), SLK 55 AMG (2012-)</p>
OUTILS OEM	<p>BMW: 130180(1), 130195(2), 130270(3), 130320(4), 2249115(5)</p> <p>MERCEDES-BENZ: 271589023300(6), 278589003300(7)</p>
CODES MOTEUR	<p>BMW: N14 / N18 / N20 / N47 / N54 / N57 / N55 / N63</p> <p>MERCEDES-BENZ: M133 / M152 / M157 / M270 / M271 / M274 / M276 / M278</p>

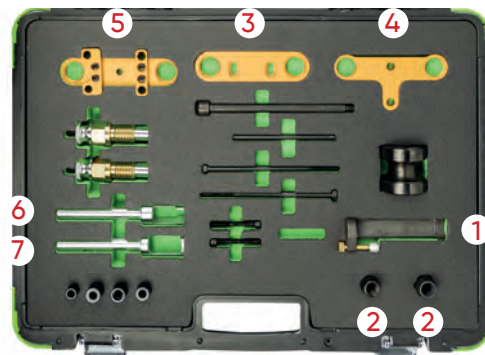

52815

110,00€



COFFRET EXTRACTEURS BOUGIES DE PRECHAUFFAGE

22 PCS



53250

85,00€



COFFRET D'EXTRACTEURS DE ROULEMENTS INTÉRIEURS ET EXTÉRIEURS

5 PCS



53069

98,00€



COFFRET D'EXTRACTEUR D'INJECTEURS DIESEL POUR CITROËN, PEUGEOT

9 PCS

CITROËN, PEUGEOT



	x1	
	x3	
	x2	Ø 17mm
	x2	Ø 25mm
	x2	25mm
	x2	29mm
	x1	21mm

52629

99,00€



COFFRET D'EXTRACTION D'INJECTEUR POUR MERCEDES

3 PCS

MERCEDES



M16x1.5

52639

123,00€

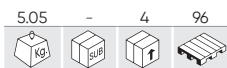

COFFRET MONTAGE ET DÉMONTAGE BIELLETES ET ROULES

- Ø 30-35mm
- Ø 35-40mm
- Ø 40-45mm



53464

153,00€



ÉTUI DE RONDELLES EN CUIVRE POUR INJECTEURS 551 PCS

551 PCS

POUR PLUS D'INFORMATION

PAGE 387



53501

24,00€

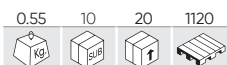

EXTRACTEUR DES POMPES À CARBURANT DIESEL POUR BMW



OEM 1 13 5 191 | 13 5 192 | 13 5 190 BMW.
BWM: M47 / M47T2 / M47TU / M57 / M57TU.
SERIES: E46 (318D-320D) (1988 - 2005) and E60, E61 (318TD-320TD-525D-530D-530-535) (2000 - 2006).

53009

42,00€

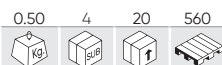

EXTRACTEURS POUR TUBES D'INJECTION DIESEL



- 3 PCS
- 1/2"
- 14, 17, 19mm

53522

24,00€



ARRACHE DE JOINT ÉJECTEUR



- 350mm
- Ø 4,5-15mm

53696

22,00€



EXTRACTEUR DE COLLIER DE SERRAGE HENN



VOLKSWAGEN, AUDI, SEAT, ŠKODA, BMW, PEUGEOT, CITROËN, DACIA, FIAT, FORD, KIA, LEXUS, MAZDA, MERCEDES, NISSAN, OPEL/VAUXHALL, PORSCHE, RENAULT, TOYOTA, VOLVO.

52757

16,00€



EXTRACTEUR DE JAUGE DE CARBURANT



53490

275,00€



COFFRET DE TEST DE COMPRESSION DES MOTEURS ESSENCE ET DIESEL

- M24
- M20
- M24
- M20
- Ø 10, 12, 14, 18mm



53096

28,80€



CLÉ POUR COUVERCLE DE JAUGE

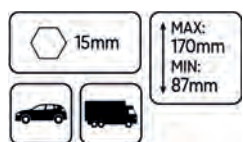

ALFA ROMEO, BMW, CHRYSLER, CITROËN, DAEWOO, FIAT, FORD, HONDA, HYUNDAI, ISUZU, JEEP, KIA, LADA, LANCIA, LAND ROVER, LDV, MAZDA, MERCEDES, MG, MITSUBISHI, NISSAN, PEUGEOT, RENAULT, ROVER, SAAB, SSANGYONG, SUZUKI, TOYOTA, VAG, VAUXHALL/OPEL, VOLVO

54373

395,00€



MANOMÈTRE HAUTE PRESSION À RAMPE COMMUNE



x2 M12x1,25	x6 M12x1,50
x2 M14x1,25	x6 M14x1,50

Un outil essentiel qui permet de mesurer la haute pression générée par la course de compression dans un cylindre d'air d'un moteur diesel. Il dispose ainsi d'une variété d'adaptateurs destinés aux différentes spécifications et connexions permettant de mesurer tout type de moteur diesel.



N

54312

191,50€



COMPRESSIOMETRE DIESEL / DCI MULTIMARQUE



DIAMÈTRE INTÉRIEUR
10, 12, 14, 18mm
DIAMÈTRE INTÉRIEUR
M20, M22, M24

ALFA, BMW, FIAT, FORD, LDV, PSA, RENAULT, SUZUKI, SAAB, CHRYSLER, DAEWOO, HYUNDAI, MERCEDES, MITSUBISHI, NISSAN, LANDROVER, MAZDA, ISUZU, OPEL.



N

52599

230,00€



TESTEUR DE PRESSIION DE CARBURANT (GASOIL ET ESSENCE)

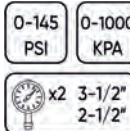

52489

58,00€



COMPRESSIOMETRE DIESEL

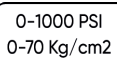

M18x1.5mm
M24x1.5mm
M24x2.0mm
M10x1.0x68mm
M10x1.25x45mm
M10x1.25x54mm
M10x1.25x68mm

FORD, BMW, MERCEDES BENZ, VW, CITROËN, MITSUBISHI, TOYOTA, PEUGEOT, RENAULT, VOLVO, MAZDA.

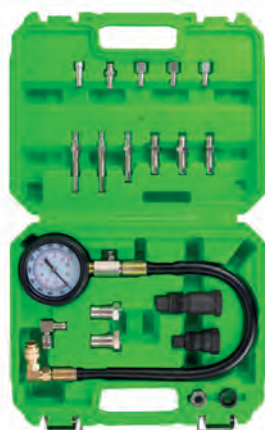

52685

88,00€



COMPRESSIOMETRE DIESEL POUR CAMION



M18
M24



53997

48,00€

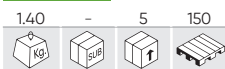

COMPRESSIOMÈTRE POUR CIRCUITS ESSENCE

0-10 BAR 0-140 BAR

LONGUEUR	25,5cm (1), 29,5cm (2), 110cm (3)
DIAMÈTRE EXTÉRIEUR	1,2cm (1), 1,2cm (2)
DIAMÈTRE INTÉRIEUR	0,6cm (1), 0,6cm (2)



54016

76,00€



POMPE PRESSION ET DEPRESSION

PRESSIION MAXIMALE

40 PSI (3 BAR)

PRESSIION MINIMALE

-20 PSI (-0,75 BAR)



52488

28,00€

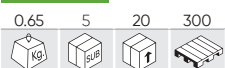

COMPRESSIOMETRE ESSENCE

0-300 BAR 0-21 Kg/cm2



53489

68,00€



MANOMÈTRE DE PRESSIION DE TURBOCOMPRESSEUR

-1~3 BAR 2m



52076

111,00€



COFFRET RÉPARATION DE BOUGIES DE PRÉCHAUFFAGE

- 1 Outil d'insertion - 2pcs.
- 2 Poignée Partie 8 - 1 pc.
- 3 Filetage M8 x 1,0 - 5pcs.
- 4 Filetage M10 x 1,0 - 5pcs.
- 5 Filetage M10 x 1,25 - 5pcs.
- 6 Filetage M12 x 1,25 - 5pcs.
- 7 Têtes d'insertion - 3pcs.
- 8 Insertion tige filetée - 1 pc.
- A Plaquette de coupe M14 x 1,25 (pour M12 x 1,25 fil) - 1 pc.
- B Plaquette de coupe M12 x 1,25 - 1 pc.
- C Plaquette de coupe M12 x 1,0 (filetage M10 x 1,25) - 1 pc.
- D Plaquette de coupe M10 x 1,25 - 1 pc.
- E Plaquette de coupe M10 x 1,0 (pour filetage M8 x 1,0) - 1 pc.
- F Plaquette de coupe M8 x 1,0 - 1 pc.



REF.	kg	box	€
11893 M8x1.0	0.01	5	7,00€
11894 M10x1.0	0.01	5	7,00€
11895 M10x1.25	0.02	5	8,65€
11896 M12x1.25	0.02	5	8,80€

OUTIL SPÉCIAL

52813

79,00€

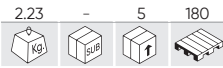

COFFRET 17 PIÈCES INJECTEUR ALESOIR

17
PCS



	x8	14x14, 15x19, 15.5x15.5, 17x17x, 17x17.5, 17x19, 17x19.5, 17x20mm
	x4	15.5x15.5, 17x17, 17.5x20.5, 17x21mm
	x1	19x21.5mm

	x1	19x225mm
	x1	19x170mm
	x1	19mm
	x1	2.5mm

52273

44,00€

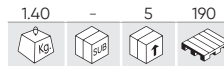

COFFRET D'ALÉSOIRS D'INJECTEUR

8
PCS

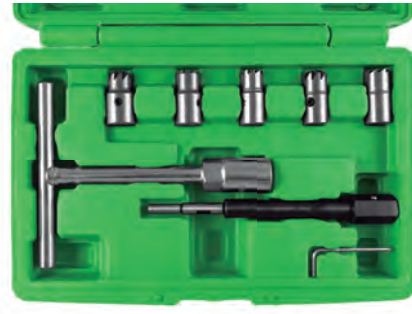

	x3	15x19mm 17x17mm BMW, PSA, Renault, Ford 17x19mm Mercedes CRD
	x2	17x17mm Mercedes 17x21mm Fiat/Iveco

	x1	12mm
	x1	19mm
	x1	

53650

47,00€

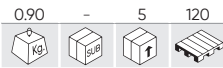

COFFRET DE NETTOYAGE DE SIÈGES D'INJECTEURS

19
PCS

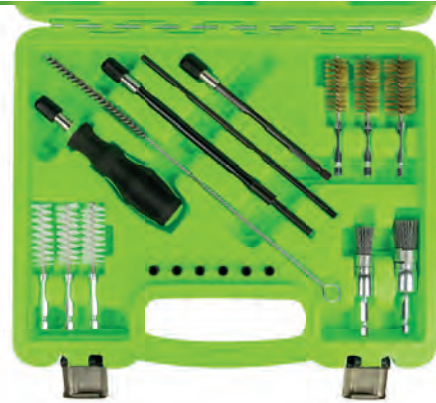

REF.	DESCRIPTION					€
14348	KIT DE 3 BALAIS DE NETTOYAGE DE LAITON (RÉF.53650)	0.05	-	50	-	12,50€
14349	KIT DE 2 BALAIS DE NETTOYAGE EN SILICONE (RÉF.53650)	0.07	-	100	-	20,50€

53330

38,00€



COFFRET DE DOUILLES POUR BOMBE INJECTEUR

5
PCS

1/2" 1/4" Cr-V



52801

26,00€

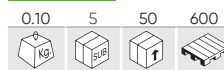

POMPE MANUELLE POUR INJECTION DIESEL



52821

28,80€



CLÉ POUR TUYAU D'INJECTION DIESEL



17mm

COFFRET A FRAPPER

Permettent d'appliquer un marquage numérique ou alphabétique sur toute surface métallique par indentation ou méthode d'impact. La zone de travail arrondie empêche les fissures ou les fractures sur la surface traitée.

52422 24,70€

0.82 3 6 540

A-Z & 0-9

36 PCS 3/16"

5mm

53119 52,00€

1.94 3 6 504

A-Z & 0-9

36 PCS 5/16"

8mm

52882 14,00€

0.30 10 60 1500

9 PCS 1/4"

6mm 0-8

51120 41,00€

2.10 - 5 120

COFFRET DÉMONTE SOUPAPES

- Valable pour voitures et motocyclettes.
- Les 5 adaptateurs permettent d'installer correctement et facilement pour comprimer le ressort de la soupape.

COMPREND
Compresseur à ressorts.
Adaptateurs de: 30, 25, 23, 19, 16mm.

52734 51,00€

2.61 - 5 175

LEVE SOUPAPES 45-145MM

Ø 30mm Ø 25mm
45-145mm

52693 24,50€

0.65 5 20 450

LÈVE SOUPAPES

53251 88,00€

2.80 - 4 60

KIT D'OUTILS POUR ANNEAUX DE PISTON

H:3" Ø 53-125mm
H:4" Ø 60-175mm
H:6" Ø 60-175mm

52697 16,00€

0.50 5 40 720

COLLIERS À SEGMENTS 6"

6" Ø 60-175mm

150mm

52696 12,00€

0.28 5 40 1200

COLLIERS À SEGMENTS 3"

3" Ø 53-175mm

77mm

OUTIL SPÉCIAL

PINCE POUR SEGMENTS DE PISTON

REF.	DESCRIPTION					€
54273	40-100mm	0.30	6	30	-	10,10€
54274	80-120mm	0.35	6	30	-	11,00€
54275	100-160mm	0.40	6	30	-	13,20€



52591 12,00€

0.10	12	72	1728

ALÉSOIR EXPANSIBLE POUR CYLINDRES - 2 BRAS 1 - 1/8"

1-18"
28,60mm
MAX: Ø 55mm
MIN: Ø 19mm



52592 22,00€

0.20	-	20	480

ALÉSOIR EXPANSIBLE POUR CYLINDRES - 3 BRAS 2"

2"
50,80mm
MAX: Ø 85mm
MIN: Ø 35mm



52593 34,00€

0.47	6	36	648

ALÉSOIR EXPANSIBLE POUR CYLINDRES - 3 BRAS 4"

4"
101,60mm
MAX: Ø 170mm
MIN: Ø 55mm



REF.	DESCRIPTION					€
11878	JEU DE 2 TAMPONS À POLIR 1-1/8" POUR RÉF. 52591	0.10	25	100	-	4,10€
11879	JEU DE 3 TAMPONS À POLIR 2" POUR RÉF. 52592	0.04	25	100	-	5,10€
11880	JEU DE 3 TAMPONS À POLIR 4" POUR RÉF. 52593	0.09	25	100	-	10,50€

53662 89,00€

1.78	5	10	80

TESTEUR DE FUITE POUR JOINT DE CULASSE DE CYLINDRE

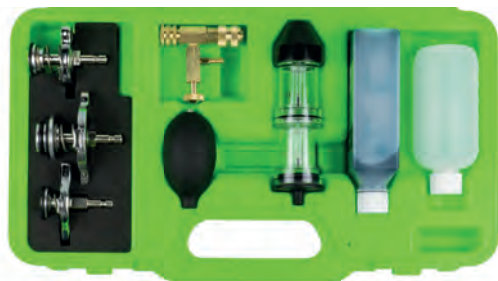

CONTIENT

Bouteille ronde de 200 ml.
Bouteille carrée de 250 ml.

ADAPTATEURS

Petit: Suzuki, Toyota, Mitsubishi.
Moyen: Suzuki, Toyota, Mitsubishi, Subaru, Peugeot, Nissan, Lexus, Mazda.
Grand: Ford, GM, Benz, JEEP.

REF.	DESCRIPTION					€
14563	LIQUIDE D'ESSAI COMBUSTION DÉTECTEUR DE FUITE	0.23	5	50	-	18,00€

54347 46,00€

2.00	-	5	100

TESTEUR DE FUITE DE CYLINDRE

7 BAR **100 PSI**

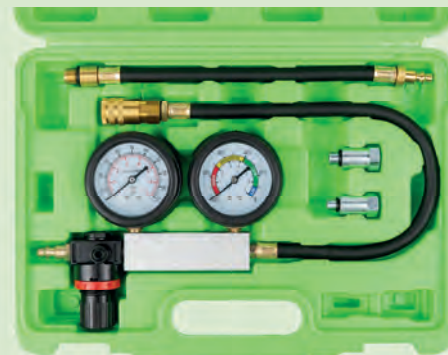

Il est utilisé pour vérifier les fuites dans un cylindre.

M12x1.25
M14x1.2

52832

75,00€

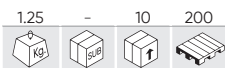

JEU DE CLÉS COURBÉES POUR EXTRACTION DE COURROIES TÊTE INTERCHANGEABLE



TÊTE INTERCHANGEABLE

x8		12, 13, 14, 15, 16, 17, 18, 19mm	x1	
x1				

52690

54,00€

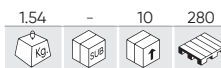

CLÉ UNIVERSELLE BLOCAGE POULIES

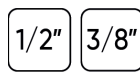

x4		3/8" - 13, 15, 16, 18mm	x1		1/2" - 230mm
x3		3/8" - 13, 14, 15mm	x1		3/8" - 585mm

53669

45,00€

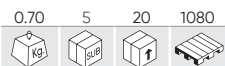

KIT DE DOUILLES AUTOMOBILE SPÉCIAL 10 PCS



- 10S pour pignon intermédiaire de Toyota
- 6S pour embrayages, culasses et têtes d'arbre d'équilibrage des Nissan et Renault
- 8S pour embrayages, culasses et têtes d'arbre d'équilibrage des Nissan et Renault
- 12S pour embrayages, culasses et têtes d'arbre d'équilibrage des Nissan et Renault
- 8TS pour arbre d'équilibrage de Nissan
- 14mm pour étriers de frein des Opel Astra G, Opel Zafira et Smart
- 10mm pour système de freinage et pompe à carburant de Nissan
- 12,5mm pour système de freinage et pompe à carburant de Nissan
- 19mm pour étriers de frein des Peugeot, Renault et Citroën
- 20mm pour bras inférieur de suspension indépendante de Honda Civic

53053

12,00€

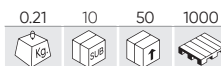

CROCHETS POUR L'EXTRACTION DE JOINTS



53637

85,00€



ORGANISATEUR SPÉCIAL POUR PIÈCES DE CULASSES

- Spécial pour les pièces de culasse.
- Maintient tous les composants propres et bien rangés au fur et à mesure qu'ils sont retirés de la culasse.
- Gagnez du temps. Cela facilite votre travail.



52850

7,80€



JEU DE 2X2 VENTOUSES A RODER LES SOUPAPES

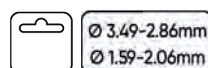

OUTIL SPÉCIAL

51989

49,00€

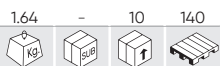

COFFRET DE 38 BROSSES MÉTAL / NYLON / LAITON

38
PCS

Ø 8, 9, 10, 11, 12, 13, 14, 15, 16, 17, 18, 19mm



- 1 Poignée de 1/4".
- 1 Extension.
- 36 brosses.

52760

4,10€

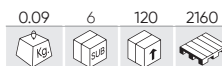

BROSSE MÉTALLIQUE



52515

9,10€

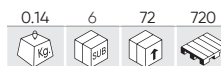

JEU DE 3 BROSSES MÉTALLIQUES

- 1 x Laiton.
- 1 x Nylon.
- 1 x Acier.



52819

22,00€

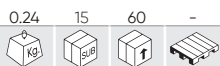

DOUILLE 1/2" POUR CHAMBRE DE PRÉCOMBUSTION (MERCEDES)

58
DENTS



53129

84,00€

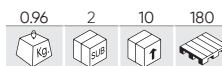

EXPANDEUR POUR JOINTS 18-90MM



53875

134,00€

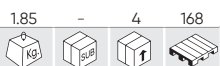

OUTIL DE DÉPOSE/REPOSE DE BRIDE ÉTANCHE DE L'ARBRE COUDÉ (GROUPE VAG)

MARQUES	VW: GOLF, TOURAN AUDI: A3, A4
OUTILS OEM	T10134
CODES MOTEUR	1.4I TURBO 1.4 ET 1.6 INJECTION DIRECTE DE CARBURANT 1.9/2.0 SDI MOTEURS DIESEL 2.0 DE SYSTÈME COMMON RAIL



52190

8,00€

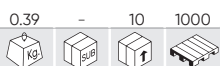

OUTIL POUR EMBRAYAGE FIAT

220x110mm



52495

14,50€

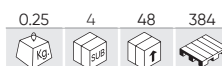

CENTREUR EMBRAYAGES UNIVERSEL

- Centreur d'embrayage pour la plupart des modèles dans le marché.
- Contient 3 adaptateurs de différent diamètre.



53001

242,00€

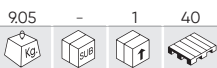

KIT DE CENTRAGE D'EMBRAYAGE SAC

VW, AUDI, BMV, MERCEDES, VOLVO, RENAULT, OPEL

- Évite les déformations de l'embrayage en utilisant le Prétendeur.
 - En utilisant l'Outil de Reset, nous porterons à la nouvelle position la bague de rajustement de la plaque de pression en montant une nouvelle soupape d'embrayage.
 - Adéquat pour presque tous les embrayages SAC (Embrayages à Ajustement Automatique).

AVANTAGES
 Tension de la plaque de pression de l'embrayage lors de l'assemblage et du démontage
 Remplacement du ressort d'ajustement avec l'outil de reset.
 Centrage de la soupape par rapport au coussinet guide.

CONTIENT
 Prétendeur d'embrayages.
 Centreur à 3 trous.
 Outil de reset.
 Set de goujons de centrage.
 Centreur à 4 trous.



53410

92,00€

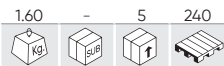

CENTREUR D'EMBRAYAGE SAC

DIAMÈTRE DE CENTRAGE

x3 15-19, 20-26,6, 23-36mm

DIAMÈTRE ACCESSOIRES

x8 12, 14, 15, 16, 17, 18, 19, 20mm



53057

149,00€

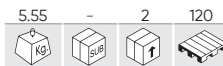

COFFRET DE RÉPARATION D'EMBRAYAGE DOUBLE FACE DE TRANSMISSION DSG/VAG

- Pour le service de changements de DSG en Golf (2004-), Golf Plus (2005-), AUDI A3 (2004-) avec des transmissions à 7 vitesses code 0AM, et Touareg (2003-) avec transmission 6 vitesses code 08D).
 - Références OEM des utiles: T10323, T10373, T10374.



50731

68,00€

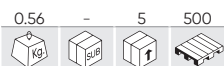

REFRACTOMETRE POUR ALCOHOL



52963

49,00€

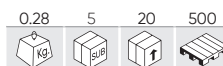

RÉFRACTOMÈTRE UNIVERSELLE

- Éthylène glycol:
 -50°C ~ -0°C.
 - Propylène glycol:
 -50°C ~ -0°C.
 - Liquide de nettoyage:
 -40°C ~ -0°C.
 - UREA AUS32:
 - 30% ~ 35%.
 - Liquide de batterie:
 - 1.100 - 1.400 sg/l.



UREA AUS32

53477

36,10€



JEU DE 8 PINCES PLATES AVEC LE FIXATEUR POUR LES TUYAUX FLEXIBLES

8 PCS

NYLON

8mm
 10mm
 13mm



53426

39,80€



VÉRIFICATEUR DE PRESSION ET VIDE

PRESSION PRESSURE 0-0,7Kg/cm² (0-10 PSIG)
 VACÍO VACUUM 0-28 inHg (0-70 cmHg)



OUTIL SPÉCIAL

52066

12,00€

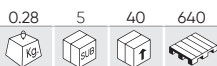

JEU DE 3 PINCES DURITES



0-20mm
0-35mm
0-70mm



53395

16,00€

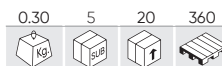

JEU DE 3 PINCES DURITES



Ø13mm
Ø20mm
Ø35mm



52687

168,00€



TESTEUR DE FUITE DE PRESSION POUR SYSTÈME DE RÉFRIGÉRATION



- 1 Pompe de pression avec soupape de décharge
- 2A Connecteur 1: attelage pour les têtes No.3(R123) et No.4 (R124)
- 2B Connecteur 2: attelage pour les têtes No. 3 (R123) et No. 5(R125)
- 3 Mercedes (W123, W126, W124, W201), GM(Buick), Jeep
- 4 Peugeot, Subaru, Chrysler, Acura, GM (Nova, Spectrum, Sprint), Mitsubishi, Nissan, Mazda, Toyota, Infiniti, GEO, Suzuki, Isuzu, Mercedes
- 5 Honda, Toyota, Suzuki, Mitsubishi, Chrysler, Acura
- 6 Mercedes Benz (ML, W163, W164), GM (Achiva, Skylark, Grand Am 1992~2002)
- 7 Volvo, Saab, Sterling, Citroën, Renault, Fiat, Alfa, Jeep
- 8 VW(Vento, T4, Passat-1996, Golf, Beetle, Sharan)
- 9 Audi(A4, A5, A6), BMW 345, VW (Passat - 1997-2002), Porsche(Cayenne)
- 10 BMW (E46, E36, E34, E39, E38, E32, E90)
- 11 Audi, VW
- 12 International, Land Rover, Jaguar
- 13 Mercedes (C, E, S, W140, W220, W124, W210, W211, W215, W216, W221, R230)
- 14 Ford Focus
- 15 Mazda(M3)
- 16 Mercedes classe A (W168)
- 17 BMW E60, E63, E64, E65
- 18 VW SHARAN 1.8T 2.8
- 19 TOYOTA-RAV4, PREVIA Adaptateur universelle en caoutchouc pour de purge et de remplissage de radiateurs



- 20 SAAB
- 21 LAND ROVER
- 22 Kia
- 23 Hunday

54139

147,00€



TESTEUR D'ÉTANCHÉITÉ À PRESSION UNIVERSEL POUR SYSTÈME DE RÉFRIGÉRATION (5 PCS)



x1 17-24mm
x1 28-31.5mm
x1 37-39.5mm
x1 47-48.5mm



53453

7,00€

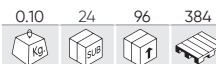

TESTEUR D'ANTIGEL

-43°C
131°C



54368

2.329,00€

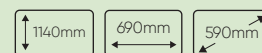

MACHINE DE NETTOYAGE DU SYSTÈME DE REFROIDISSEMENT

Cette machine vous permet de nettoyer et de remplir l'ensemble du système de refroidissement du véhicule de manière rapide et efficace. Grâce à la génération de pression, il fait circuler le liquide de refroidissement dans tout le système et le nettoie de différentes impuretés. Il est compatible avec différents types de réfrigérants.

La machine se connecte en 12V à la batterie du véhicule et dispose d'une interface intuitive qui, avec son écran tactile, ses deux manomètres et ses deux écrans pour observer l'état du fluide, la rendent très simple à utiliser. Il dispose de connecteurs rapides, de tuyaux et d'adaptateurs pour effectuer la tâche confortablement dans la grande majorité des véhicules. Il contient deux réservoirs de 20 litres, un pour le liquide de refroidissement neuf et l'autre pour le liquide de refroidissement usagé, tous deux vidés par la machine elle-même. Dans les circuits présentant de la rouille ou de l'huile, l'utilisation d'additifs est recommandée pour un plus grand pouvoir nettoyant.



53539

66,00€



KIT DE DÉTECTION DE FUITE POUR CLIMATISATION

CONTIENT

- 1 x lampe UV.
- 1 x lunettes de vision UV.
- 1 x pile rechargeable.
- 1 x chargeur
- 1 x seringue insertion fluide.
- 1 x adaptateur rapide.
- 1 x adaptateur extension.



REF. DESCRIPTION

REF.	DESCRIPTION	Q1	Q2	Q3	€
15052	BATTERIE RECHARGEABLE POUR RÉF. 53539	0.05	5	10	3,00€
15053	CHARGEUR POUR RÉF. 53539	0.08	-	10	10,50€
15054	LAMPE POUR RÉF. 53539	0.12	-	50	34,00€
14187	LUNETTES UV (RÉF. 53539)	0.05	10	120	6,00€
12200	SERINGUE DE DÉTECTION DE FUITE AA/CC (REF. 52844)	1.10	-	50	14,50€

OUTIL SPÉCIAL

54291

116.00	-	1	1

5.054,00€

N

MACHINE POUR CHARGER L'AIR CONDITIONNÉ

200V
±10% R134A
R1234YF

3/8 HP >2 Kg/min 100 L/min

450g/min 800g/min 12,12 cm³

LCD 360x128mm 50-60 Hz -10° 50°

99% <85% 180W

Cette machine a été conçue pour effectuer des travaux de nettoyage, de récupération de réfrigérant, d'aspiration, d'injection d'huile et de recharge de réfrigérant dans le système de climatisation du véhicule. Il exécute tous les processus sans que l'opérateur doive être attentif à tout moment.

CARACTÉRISTIQUES

ENTIÈREMENT AUTOMATIQUE.

FACILE À UTILISER

AVEC GRANDE FENÊTRE D'INSPECTION ET RÉTROÉCLAIRAGE LED

LES MANOMÈTRES FACILITENT L'OBSERVATION DES VALEURS

TAUX DE RÉCUPÉRATION ÉLEVÉ DU GAZ ET DU PÉTROLE

AVEC GRAND ÉCRAN LCD

AVEC BASE DE DONNÉES ET IMPRIMANTE

LE LOGICIEL ET LA BASE DE DONNÉES PEUVENT ÊTRE MIS À NIVEAU



PIÈCES DE RECHANGE



TUTORIEL VIDÉO

16309

1.40	-	1	-

149,00€

N

JEU DE 2 TUYAUX À HAUTE ET BASSE PRESSION DE 5 MÈTRES DE LONG (REF.54291)



1234YF ADAPTEUR POUR GAZ

Adaptateur rapide d'air conditionné / liquide de refroidissement de connexion rapide R1234YF. La conception de la connexion rapide permet une sécurité complète. Avec connexion qui protège contre les blessures et la perte de réfrigérant si déconnecté sous pression. Utilisation: AACC et réfrigérant



53499

29,00€

0.20	15	60	2400

1234YF ADAPTEUR POUR GAZ (HAUT)

- Rouge (haute pression)
- Matériel: laiton et métal
- Lester: 194g



53500

29,00€

0.20	15	60	2400

1234YF ADAPTEUR POUR GAZ (BAS)

- Bleu (basse pression)
- Matériel: laiton et métal
- Lester: 175g



53456

98,00€

2.90	-	5	75

SET DE VÉRIFICATION, REMPLISSAGE ET VIDAGE DE SYSTEME AACC (BAR)

BAR LOW: 0-24BAR HIGH: 0-34BAR

PSI LOW: 0-350PSI HIGH: 0-500PSI

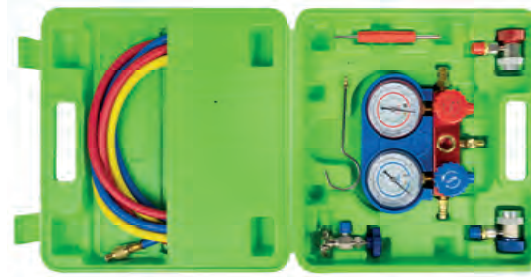

REF. DESCRIPTION

14300 ACCOUPLEMENT RAPIDE HAUTE PRESSION (RÉF. 53456)

14301 ACCOUPLEMENT RAPIDE BASSE PRESSION (RÉF. 53456)

REF.	DESCRIPTION	kg	SUB	up	down	€
14300	ACCOUPLEMENT RAPIDE HAUTE PRESSION (RÉF. 53456)	0.15	-	100	-	19,00€
14301	ACCOUPLEMENT RAPIDE BASSE PRESSION (RÉF. 53456)	0.15	-	100	-	19,00€

16316 18,50€

0.30 - 12 -

N

HUILE UNIVERSELLE PAG POUR SYSTÈMES DE CLIMATISATION 250ML

12977 36,50€

0.33 3 12 480

FLUIDES POUR SYSTEME DE CLIMATISATION. 250 ML

- Une application de 7,5 ml pour chaque 1,4L de réfrigérant.

50807 38,00€

0.16 6 24 744

MALLETTE JOINT POUR CLIM

Ø	PCS	Ø	PCS
5.29x1.78	20	8.80x1.90	20
6.07x1.78	20	10.82x1.78	15
6.8x1.9	20	10.77x2.62	15
7.65x1.78	20	11.0x2.0	15
7.80x1.90	20	12.0x2.0	15
8.0x2.0	20	13.9x1.80	10

Ø	PCS
13.95x2.62	10
14.0x2.0	10
15.0x2.0	10
17.0x2.0	10
17.17x1.78	10
17.04x3.53	10

53599 30,30€

0,16 10 100 -

ENSEMBLE DE NOYAUX DE SOUPAPE DE CLIMATISEUR

PIÈCES DE RECHANGE DISPONIBLES

REF	mm	PCS	€
14594	5x19mm R12	50	2,00€
14595	5x19mm	30	1,50€
14596	5x19mm R12	30	2,00€
14597	6x19mm	3	7,60€
14598	6x26mm	1	17,80€
14599	7x20mm R134A	10	4,50€
14600	6x22mm	5	9,50€
14601	8x22mm	1	11,00€
14602	9x22mm	4	11,00€



53459

1.05 - 10 150

KIT DE DÉCONNEXION D'AIR CONDITIONNÉ

66,00€

COLLIERS DE SERRAGE DE DIAMÈTRES

x6 8mm (5/16"), 9.5mm (3/8"), 13mm (1/2"), 16mm (5/8"), 19mm (3/4"), 22mm (7/8")

BLOQUEUR DE DIAMÈTRES

x4 9.5 mm (3/8"), 16mm (5/8"), 13mm (1/2"), 19mm (3/4")

54069 29,50€

0.20 10 40 360

TROUSSE À OUTILS DE NETTOYAGE DE MOYEU, 14 PIÈCES



- x1 Buse 8 mm avec adaptateur 1/2"
- x1 Meule à axe rond et tête hexagonale 8 mm
- x2 Patins amovibles avec base autocollante
- x5 Meules grossières, diamètre extérieur 40 mm
- x5 Meules à grain fin, diamètre extérieur 40 mm, diamètre intérieur 14mm

51364 26,00€

2.00 - 5 315

OUTILS EXTRACTION NOIX DE CARDANS

Ø 31mm 140-240mm



OUTIL SPÉCIAL

53638

243,00€

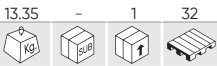

ARRACHEUR HYDRAULIQUE DE MOYEU DE ROUE

- Ce kit comprend 3 extracteurs / marteaux spécialement conçus pour simplifier le démontage du cube de roue et libérer l'arbre du moyeu sans l'endommager:
- Broche hydraulique
- Vis
- Marteau à percussion
- Pour extraction manuelle ou hydraulique.
- Avec une capacité maximale de 10 tonnes.
- Marteau de 4 kg.
- Longueur de barre: 57cm.
- Pour 3, 4, 5 et 6 trous.

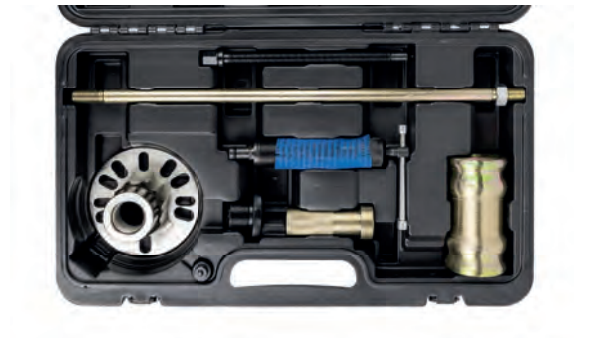

REF. DESCRIPTION

1.35 1 10 62,00€

15253 BROCHE HYDRAULIQUE POUR RÉF. 53384/53638

54384

32,50€



NETTOYANT DE DOUILLES

Il vous aide à nettoyer l'oxyde et la corrosion présents sur le moyeu de la roue. Il est équipé d'une bande velcro pour installer facilement le disque abrasif.

Diamètre extérieur : 150 mm
Diamètre intérieur : 90 mm
Vitesse maximale : 500 RPM

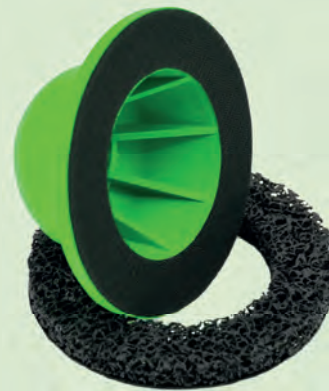

REF. DESCRIPTION

0.11 16 64 16,50€

16448 DISQUE DE NETTOYAGE POUR DOUILLES (REF.54384) 0.11 16 64 16,50€

52829

19,00€

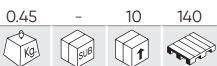

EXPANDEUR SOUFFLETS DE CARDANS

EXTÉRIEUR

Ø 10cm

INTÉRIEUR

Ø 9,5cm

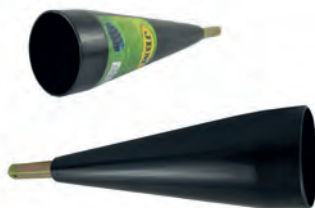

52541

45,00€

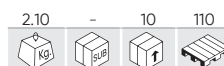

LEVIER CONTRÔLE DES JEUX DANS LES AXES



- Pour détecter mouvement: Roulements, silentblocs, roulements de roues, articulation axes, paliers cardans, support stabilisateurs, etc



51121

27,30€



COMPRESSEUR DE RESSORT

- Griffes et goujon forgés avec alliage fer-carbone, tous les deux thermo-traités pour assurer un grand professionnalisme au travail.
- Outil conçu pour être utilisé dans des espaces limités et sous l'arc de roue, offrant la plus grande protection.
- Ouverture maximale 250 mm.

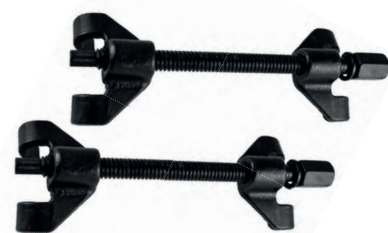

270mm

50827

387,00€

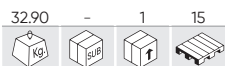

COMPRESSEUR DE RESSORTS



- Capacité : 1T (2200 lbs)
- Diamètre du ressort comprimé : 200 mm
- Longueur de compression : 200-500mm

53742

1.325,00€

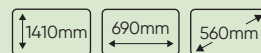

COMPRESSEUR DE RESSORTS 1T



- Capacité: 1000 kg
- Longueur de travail max.: 450 mm
- Course du cylindre: 420 mm
- Diamètre du ressort: Ø102-165mm
- Sens d'enroulement: sens horaire
- Principe de fonctionnement: pneumatique
- Pression d'air: 6,5 à 9 bars (94,27 à 130,53 psi / 0,65 à 0,9 MPa)
- Mode de fonctionnement: pédale

53394

598,00€



COMPRESSEUR DE RESSORTS

- Bras Télescopique et surfaces antidérapantes qui permettent une prise solide des ressorts.
- Serres équipés d'un plastique interchangeable pour éviter d'endommager le ressort de peinture
- Il empêche les ressorts de se plier en compression.
- Universel, couvre 90% du parc de véhicules.
- Il peut être utilisé pour les ressorts droits et coniques.

CONTIENT

Dispositif / piston.
Trois paires de mâchoires avec des couvertures en plastique.



PEUT ÊTRE UTILISÉ AVEC DES OUTILS PNEUMATIQUES

52227

247,00€



COMPRESSEUR DE RESSORT PROFESSIONEL MCPHERSON

- Spécifications:
- Charge maximale: 2500N.
- Un corps principal.
- Prise en charge étendue.
- 3 paires de mâchoires.
- Paire 1: Champ d'application: 80-115mm. Poids: 1,45 kg.
- Paire 2: Domaine d'utilisation: 110-195mm. Poids: 2,2 kg.
- Par 3: Domaine d'utilisation: 140-195mm. Poids: 2,3 kg.

BMW, TOYOTA, FORD, MITSUBISHI, VW, AUDI, SAAB, NISSAN, HONDA ACCORD, SUBARU, VOLVO, OPEL, PORSCHE.



NE PAS UTILISER AVEC CLÉ À CHOC

OUTIL SPÉCIAL

52270

109,00€



COFFRET MONTAGE ET DEMONTAGE SILENT-BLOCK

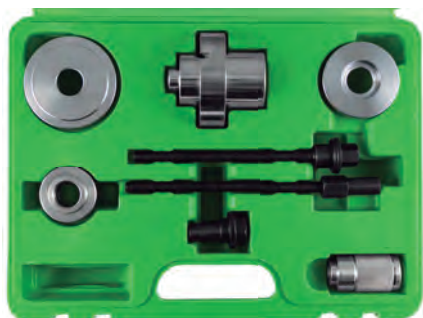

- _____ Axe, Extension de axe, Vis M10x1.25
- _____ Adaptateur en acier au carbone
- _____ Separateur
- _____ Piece de pression
- _____ Mandril de centrage en aleation en aluminium

52432

35,00€



EXTRACTEUR SILENT-BLOCK AVANT VAG



- Utile pour VW POLO 2002.
- Facilite la modification des coussinets en caoutchouc sur l'essieu avant.

EXTRACTEUR

REF.	DESCRIPTION	MAX	MIN						€
51368	EXTRACTEUR DE ROTULE DE DIRECTION	42mm	33mm	0.41	5	50	2700		19,00€
51369	EXTRACTEUR D'ÉCROUS AXIAUX	42mm	35mm	0.55	6	36	756		28,00€
51414	EXTRACTEUR POUR GOUJONS	20mm	15mm	0.59	5	40	1440		14,00€



51368



51369



51414

52834

195,00€



COFFRET DE DOUILLES AVEC ERGOTS EXTÉRIEURS

11 PCS 1/2" Cr-Mo

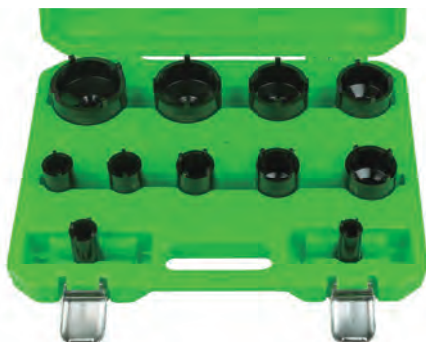

x11 22x3.3mm, 26x3.8mm, 30x4.3mm, 33x4.0mm, 37x4.8mm, 44x5.3mm, 50x5.8mm, 56x5.8mm, 63x6.3mm, 69x6.8mm, 75x6.8mm

52835

272,00€



JEU DE DOUILLES AVEC ERGOTS INTÉRIEURS

10 PCS 1/2"



x10 26x5.3mm, 1,2x6.25mm, 34.2x6.3mm, 38.2x6.65mm, 42.2x7.3mm, 50.1x8.25mm, 58.2x9.8mm, 74.6x11.9mm, 82.2x13.25mm, 87.7x13mm

OUTIL MONTAGE ET DÉMONTAGE BIELLETES ET ROULES

REF.	DESCRIPTION					€
52640	Ø 28-35mm	1.80	-	4	256	52,00€
52641	Ø 35-45mm	2.20	-	4	140	55,00€



CLÉ EXTRACTION DE BRAS DE DIRECTION

REF.	DESCRIPTION					€
52874	Ø 9-20mm	1.20	4	20	1500	82,00€
52875	Ø 14-23mm	1.25	5	20	1500	79,00€



53635



85,00€

440-630mm

ARRACHEUR DE ROULEMENTS DE ROUES AVEC COULISSEAU À CHOC

- Masse glissante: 4 kg.
- Rang de diamètre: 100-115mm.
- Pour vis M12.



51490

36,00€



COFFRET EXTRACTION DE ROTULES



MANCHE POUR SON UTILISATION AVEC UN MARTEAU
FOURCHES: 11/16, 15/16 ET 1-1/8

53384

165,00€



EXTRACTEUR DE ROTULES HYDRAULIQUE

- Overture: 100mm.
- Largeur: 35mm.



REF.	DESCRIPTION				€
15253	BROCHE HYDRAULIQUE POUR RÉF. 53384/53638	1.35	1	10	62,00€

53208

126,00€



COFFRET DE VIS DE SECURITÉ POUR BMW

22 PCS BMW 41-60



APPLICATIONS

BMW Serie 1 F20/F21
BMW Serie 3 F30/F31
BMW Serie 4 F32/F34/F36

BMW Serie 5 F10/F11
BMW Serie 6 F12/F13
BMW Serie 7 F01/F02/F04

x20 41, 42, 43, 44, 45, 46, 47, 48, 49, 50, 51, 52, 53, 54, 55, 56, 57, 58, 59, 60

53207

118,00€



COFFRET DE VIS DE SECURITÉ POUR VW

23 PCS VW



x1 B51 / 6PT	x1 B62 / 17PT	x1 ABC3 / 14PT	
x1 B52 / 7PT	x1 ABC0 / 10PT	x1 ABC4 / 15PT	x1 ABC7 / 19PT
x1 B53 / 8PT	x1 ABC1 / 11PT	x1 ABC5 / 16PT	x1 ABC8 / 20PT
x1 B54 / 9PT	x1 ABC2 / 13PT	x1 ABC6 / 17PT	x1 ABC9 / 21PT
x1 B55 / 10PT			
x1 B56 / 11PT			
x1 B57 / 12PT			
x1 B58 / 13PT			
x1 B59 / 14PT			
x1 B60 / 15PT			
x1 B61 / 16PT			

OUTIL SPÉCIAL

52802

54,00€

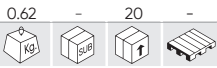

COFFRET DE D'EMBOUITS POUR VIS DE SECURITE POUR BMW

10 PCS BMW



x1	30/13 PT
x1	31/15 PT
x1	32/16 PT
x1	33/17 PT
x1	34/18 PT

x1	35/19 PT
x1	36/20 PT
x1	37/21 PT
x1	38/22 PT
x1	40/23 PT

53328

76,00€

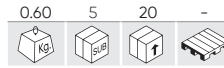

COFFRET DE D'EMBOUITS POUR VIS DE SECURITE POUR MERCEDES

12 PCS

MERCEDES



APPLICATIONS

A, B, C, GLK, CLC, CLS, CLK, E, SL, SLK, M, C300, C250, C350, E320, 204, 211, 212, R

51998

38,00€

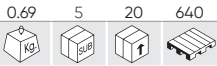

COFFRET DE DOUILLES TWIST DE 3/8" EXTRACTION D'ECROUS ENDOMMAGÉES

10 PCS 3/8" Cr-Mo

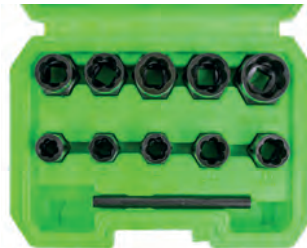

PIÈCES DE RECHANGE DISPONIBLES

REF.	mm	Kg	Box	Pallet	€
16737	9mm	0.07	-	100	12,00€
11434	10mm	0.04	-	100	12,00€
11435	11mm	0.04	-	100	12,00€
11436	12mm	0.04	-	100	12,00€
11437	13mm	0.04	-	100	12,00€

REF.	mm	Kg	Box	Pallet	€
11438	14mm	0.06	-	100	12,00€
11439	15mm	0.06	-	100	12,00€
11440	16mm	0.06	-	100	12,00€
11441	17mm	0.08	-	100	12,00€
11442	19mm	0.09	-	100	12,00€

52962

42,00€

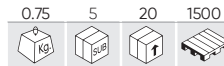

COFFRET DE DOUILLES TWIST 3/8" EXTRACTION D'ECROUS ENDOMMAGÉS 6-19MM

11 PCS 3/8" Cr-Mo



PIÈCES DE RECHANGE DISPONIBLES

REF.	mm	Kg	Box	Pallet	€
11450	6mm	0.07	-	100	12,00€
12093	8mm	0.07	-	100	12,00€
11434	10mm	0.04	-	100	12,00€
11435	11mm	0.04	-	100	12,00€
11436	12mm	0.04	-	100	12,00€
11437	13mm	0.04	-	100	12,00€

REF.	mm	Kg	Box	Pallet	€
11438	14mm	0.06	-	100	12,00€
11439	15mm	0.06	-	100	12,00€
11440	16mm	0.06	-	100	12,00€
11441	17mm	0.08	-	100	12,00€
11442	19mm	0.09	-	100	12,00€

52823

124,00€

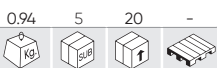

COFFRET DE VIS DE SECURITÉ POUR AUDI

22 PCS VAG

A, B, C, E, F, G, H, I, J, L, M, N, P, Q, R, S, T, V, W, X



x20 A, B, C, E, F, G, H, I, J, L, M, N, P, Q, R, S, T, V, W, X

54317

124,00€

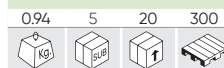

JEU DE VIS DE SECURITÉ POUR VAG

22 PCS VAG CR-MO

521,522,523,524, 525,526,527,528, 529,530,531,532, 533,534,535,536, 537,538,539,540



x20 521,522,523,524,525,526,527,528,529,530,531,532,533,534,535,536,537,538,539,540

52153

46,00€

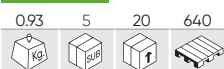

COFFRET DE DOUILLES TWIST DE 1/2" EXTRACTION D'ECROUS ENDOMMAGÉS



PIÈCES DE RECHANGE DISPONIBLES

REF.	mm				€	REF.	mm				€
11443	17mm	0.02	25	100	14,00€	11446	23mm	0.03	25	100	15,00€
11444	19mm	0.02	25	100	14,00€	11447	27mm	0.03	25	100	15,50€
11445	21mm	0.02	25	100	15,00€						



54253

166,00€



JEU DE RETRAIT DES BOULONS DE SÉCURITÉ DES ROUES

Kit principal facile à utiliser capable d'enLÉVER pratiquement n'importe quel écrou de roue de blocage. Le kit comprend des protecteurs qui protègent la roue de tout dommage. Très efficace et un outil d'atelier indispensable. Le kit contient deux tailles de lames de coupe à impact pour s'adapter à la plupart des écrous de roue de verrouillage en coupant le bord extérieur. Sont également incluses trois lames à double face pour le moulage directement dans la forme du socle.

UNIVERSSEL: Supprime une large gamme de tailles, de types et de profils, y compris ceux avec des colliers pivotants.

PIÈCES DE RECHANGE DISPONIBLES

REF.	DESCRIPTION				€
16300	CUTTER A ET MANDRIN (REF. 54253)	0.15	-	100	7,60€
16301	CUTTER B ET MANDRIN (REF. 54253)	0.15	-	100	7,60€
16302	CUTTER C (REF. 54253)	0.05	-	100	7,60€



54299

227,00€



COFFRET D'INSTALLATION ET DE DÉMONTAGE DE MOYEU ET DE ROULEMENT DE ROUE



	5,3cm		8,6x10,9cm
	5,8cm	B	8,2x10cm
	6,5cm		7,1x9,45cm
	6,6cm		8,9x17,6cm
A	Ø 2,3mm	C	9,9x17,6cm
	7,1cm		12x17,8cm
	7,3cm	D	Ø 2,3mm 9,5cm
	7,8cm	E	Ø 8,6mm 9,55cm
	8,3cm	F	2,4x28cm



OUTIL SPÉCIAL

51919

89,00€



COFFRET DE MULTIPLICATEUR DE FORCE

4
PCS



- Matériel: 4OCR.
- Puissance maximale: 5800Nm.
- Puissance de travail: 3800Nm.
- Multiple en rang 1:56.
- Includes douilles: 32mm, 33mm de 1".

52796

98,00€



DEMULATEUR DE FORCE ARTICULÉ

5
PCS 6000 Nm



- Emploi sur les camions avec enjoliveur et volant protecteur.
- Préviens les dommages de la bande de roulement.
- Unique sur le marché.
- Facilité d'adaptation à tout véhicule universelle.
- Utile pour vissage et dévisser sans effort.

CONTIENT

- 1x verre 1"32mm.
- 1x verre 1"33mm.

51958

422,00€



COFFRET DEMULATEUR DE FORCE 3/4" + REDUCTEUR DE 1/2"

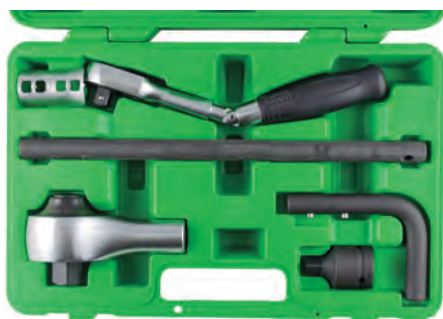

CONTIENT

- 1x Multiplicateur de couple.
- 1x Cliquet manuel.
- 1x Adaptateur 1/2" M x 3/4" F.
- 1x Kit libération.
- 1x Barre d'extension 90°.
- 1x Barre d'extension 350 mm.

CARACTÉRISTIQUES

- Rapport de transmission 1:4.
- Rapport de couple: 1: 3.3.
- Couple maximal d'entrée: 303 Nm.
- Couple maximal de sortie: 1.000 Nm.

52012

68,00€



MULATEUR DE FORCE JUNIOR

1/2"



VOITURE DE TOURISME

CONTIENT

- 1x Multiplicateur de couple.
- 1x Barre d'extension de 90°.
- Douilles de 17, 19 et 21 mm.

- Multiple en place: 1: 18.
- Couple maximal de sortie: 360 Nm.
- Couple maximal de torsion: 800 Nm.

EXTRACTEUR

REF.	DESCRIPTION	mm	Max.	Min.					€
52642	ARRACHE ROTULE	17-22mm	60mm	20mm	1.32	5	10	660	32,00€
52699	ARRACHE ROTULES	18-22mm	50mm	15mm	0.80	5	30	1140	22,00€



52642



52699

51123 91,00€

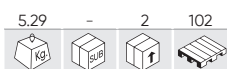

COFFRET DE 5 ARRACHES ROTULES



- Ce système permet l'extraction facile des types les plus populaires d'articulations de rotule et d'autres.
 - Le type de séparateur de la presse du joint permet le retrait du joint de rotule sans endommager les chargeurs et d'autres pièces, ce que font d'autres types d'extracteurs.

53488 61,00€



OUTIL DE RÉGLAGE DE CARROSSAGE (VAG)



x1	75mm	Seat - Toledo VW - Jeta / Golf
x1	85mm	Seat - Cordoba VW - Polo / 95>
x1	115mm	Chrysler - Voyager
x1	22mm	

51902 84,00€

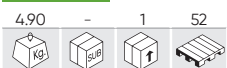

LEVIER POUR EXTRACTION DE ROTULES DE BRAS DE SUSPENSION

- Dimensions:
 Longueur: 1180mm.
 Diam. Tube: 3,5 cm.
 Distance d'ancrages: 50, 45, 40, 35, 30 cm.
 Ancrage de 15x13 cm.



REF. DESCRIPTION

10953 RECHANGE ANCRE DE FIXATION POUR REF. 51902

0.83	-	25	-	12,50€
------	---	----	---	--------

51119 62,00€



COFFRET 7 PIÈCES POUR SYSTÈME D'INJECTION LAMBDA

7 PCS 1/2" 3/8"

x1	1/2"	29x9 ~ 90mm
x1	1/2" ~ 7/8"	50mm
x1	1/2"	27x12 ~ 78mm
x1	3/8" ~ 7/8"	6 ~ 90mm
x1	3/8" ~ 7/8"	6 ~ 80mm
x1	3/8" ~ 7/8"	30mm
x1	3/8" ~ 1"	74mm
x1	1" ~ 1/16"	74mm



52637 48,00€



COFFRET D'EXTENSION POUR SYSTÈME D'ÉCHAPPEMENTS

x1	1-1/8" - 1-3/4"
x1	1-1/2" - 2-1/2"
x1	2-1/8" - 3-1/2"



OUTIL SPÉCIAL

51491

154,00€



COFFRET DOUILLE 14 PIÈCES POUR SYSTÈME D'INJECTION LAMBDA

14
PCS

17x78mm	12PT	Renault
19x78mm	12PT	VW, Polo, Audi, Seat, Mazda
20x78mm	6PT	Deschis, Japon
27x78mm	6PT	Deschis, Japon
21x90mm	12PT	Seat, Audi, VW, Skoda, Alfa Romeo, Mitsubishi
22x78mm	12PT	Seat, Audi, VW, Skoda, Opel
22x110mm	12PT	Mercedes, Citroën, Peugeot, Ford, Nissan, Mazda, Mitsubishi, Seat, Audi, VW...



51991

54,00€



ALIGNEUR DE DIRECTION

- Longueur totale ouvert: 1 950mm.
- Longueur totale fermé: 1 100mm.
- Dimensions de vis: M6x15mm.
- Tube extérieur de 20x20 en aluminium.
- Tube intérieur de 16x16 en fer zingué.



53118

231,00€



COFFRET POUR DÉMONTAGE AMORTISSEURS

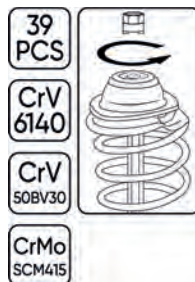

52822

32,00€

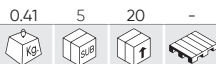

CLÉ ARTICULÉE POUR SONDE LAMBDA 22MM



52849

8,50€

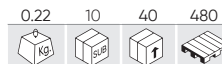

JEU DE 2 CROCHETS POUR EXTRAIRE GOMME DES TUYAUX ECHAPPEMENTS



52852

6,80€

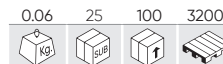

JEU DE 2 CROCHETS



51347

9,90€

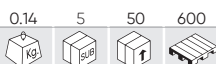

STÉTHOSCOPE POUR MÉCANICIEN

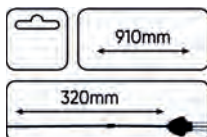

- Amplifie et localise des bruits internes mécaniques et des passages de fluides.
- Localise rapidement la source du bruit du moteur.
- Écoutez les problèmes de localisation rationnelle des flux d'eau, pétrole, gaz ou vapeur.
- Manche à l'épreuve des coups.



53249

192,00€

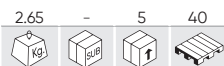

STÉTHOSCOPE ÉLECTRONIQUE

Kit apte pour détection des erreurs sur collecteurs d'admission/ échappement, injecteurs, radiateurs, etc. Permet d'ausculter plusieurs endroits du véhicule simultanément, facilitant la tâche de l'opérateur pour trouver et diagnostiquer les pannes. Sondes marquées en couleur pour faciliter la tâche de l'opérateur.

CARACTÉRISTIQUES

Longueur du câble du capteur: 4,8 m
 Longueur de la sonde audio: 14 cm
 Piles de 9V (incluses)
 Nombre de capteurs: 6
 Apte pour connecteur de 3,5 mm
 Longueur ajustable du microphone: 21cm.

x1	Testeurs audio	x6	Canaux de microphone de boîte
x1	Casques	x1	Velcro de fixation pour les capteurs
x6	Clips de microphone	x1	Piles de 9v



52293

98,00€

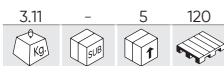

COFFRET D'EXTRACTION DE POULIES DE 30 PIÈCES

A	x1	H38x3 Pins - 20mmL
B	x1	H17x4 Pins - 30mmL
C	x1	3/8" Dr. x H10
D	x1	1/2" Dr. x H10
E	x9	M10xH12 (64mmL), T50xH12 (64mmL), H10xFH10 (68mmL), H8xH10 (75mmL), M8xH10 (75mmL), M10xH10 (75mmL), H10xH10 (75mmL), T40xH10 (75mmL), T50xH19 (75mmL)
F	x3	1/2" Dr. T50 - 17mm x T33 - 100mmL, 1/2" Dr. M10 - 17mm x T33 - 100mmL, 3/8" Dr. M10 - 12mm x T31 - 85mmL,
G	x4	1/2" Dr. T50 - 140mmL, 1/2" Dr. M10 - 140mmL, 1/2" Dr. T50 - 200mmL, 1/2" Dr. M10 - 200mmL
H	x5	H17xH21 (30mmL), H15xH28 (30mmL), H19xH28 (30mmL), H21xH28 (30mmL), H22xH28 (30mmL)
I	x2	H22 (30mmL), H17 (35mmL)
J	x3	H22x22mm x T33 (300mmL), H15x15mm x T33 (30mmL), 15mm x T33 (30mmL)

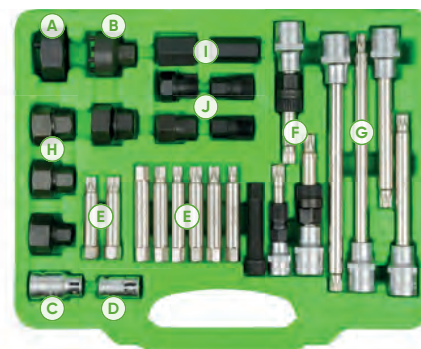

51259

58,00€

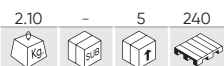

COFFRET DEMONTAGE POULIES ALTERNATEURS 18 PIÈCES

PIÈCES DE RECHANGE DISPONIBLES

REF.	DESCRIPTION	kg	cm	€
10485	DOUILLE POINTE XZN M10 110MM POUR 51259	0.10	5 100	8,10€
10486	DOUILLE POINTE TORX T50 110MM POUR 51259	0.15	5 50	8,00€
10494	DOUILLE RALONGE 14CM (POUR 51259)	0.16	- -	6,50€
10495	POINTE H10 POUR 51259	0.06	- -	3,00€
10496	POINTE H8 POUR 51259	0.06	5 50	3,00€
10497	POINTE M10 POUR 51259	0.06	5 100	3,00€
10498	POINTE M8 POUR 51259	0.06	5 50	3,00€
10499	POINTE T40 POUR REF.51259	0.05	5 60	3,00€
10500	EMBOUT T50 POUR 51259	0.06	5 100	3,00€
10501	DOUILLE POINTE XZN M10 90MM POUR 51259	0.08	5 100	8,10€
10502	EMBOUT M10 75MML POUR 51259	0.06	- 20	3,50€

CONTIENT

A	x3	T50x110mm (1/2"), M10x110 (1/2"), M10x90mm (3/8")	E	x1	1/2"x10mm
B	x1	M10x140mm	F	x1	M10x65mm
C	x2	19, 22mm	G	x6	T40, T50, M8, M10, H8, H10 (10x75mm)
D	x3	22x28, 19x28, 21x28mm	H	x1	H22

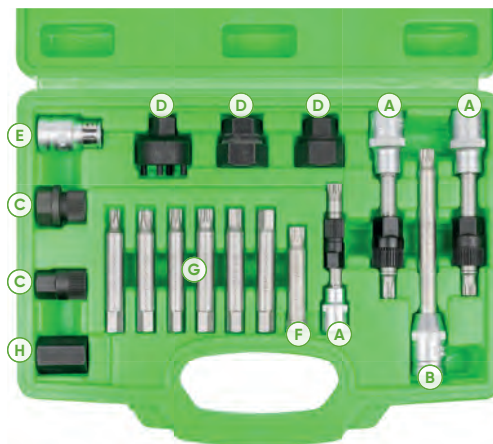

OUTIL SPÉCIAL

51495

59,00€

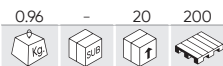

COFFRET D'EXTRACTION BOBINE D'ALLUMAGE VAG POUR VW



- Pour enLÈVEr et installer les bobines d'allumage avec couvercle de moteurs à injection de VW CYL 8 et 12 / 5 et 6 CYL, VW GOLF, BORA, 4 et 5 CYL. VW Passat, 6 CYL, Sharan VW, Touareg, Phaeton.
- Pour extraire et installer les bobines d'allumage avec étape de puissance de la VW Polo, Golf 1.4, 1.6i, 1.4i CADDY, BORA 1.4, 1.6 i Phaeton, Passat, Touran 1.6i, Transporter T4.



PINCE À BEC POUR BOUGIES

REF.	DESCRIPTION				€
52816	PINCE À BEC POUR BOUGIES DE PRÉCHAUFFAGE - 235MM	0.27	6	36	28,10€
52817	PINCE DROITE POUR BOUGIES DE PRÉCHAUFFAGE - DROITE 250MM	0.28	6	36	23,50€



52621

11,00€



NETTOYEUR DE BORNES DE BATTERIE



52319

8,80€



NETTOYEUR DE BORNE BATTERIES



CLÉ A BOUGIE MAGNÉTIQUE

REF.	"	mm				€
52316	3/8"	250mm - Ø14mm	0.20	12	48 2880	18,90€
52317	3/8"	250mm - Ø16mm	0.30	12	48 2880	19,90€



DOUILLE DE BOUGIE

REF.	"	mm				€
10054	1/2"	16mm	0.08	10	100 -	2,90€
10055	1/2"	21mm	0.14	10	100 -	3,90€



52691

54,00€



COFFRET DE CLÉS A BOUGIES ARTICULÉES

AVEC SYSTÈME MÉCANIQUE DE SUJÉTION

3/8"	8mm (82mm)	3/8"	12mm (82mm)
3/8"	9mm (82mm)	3/8"	14mm (82mm)
3/8"	10mm (82mm)	3/8"	16mm (82mm)



CLÉ ARTICULÉE POUR BOUGIE

REF.	DESCRIPTION					€
54381	CLÉ ARTICULÉE POUR BOUGIE 14MM	0.35	10	40	-	5,00€
54382	CLÉ ARTICULÉE POUR BOUGIE 16MM	0.35	10	40	-	5,00€
54383	CLÉ ARTICULÉE POUR BOUGIE 21MM	0.39	10	40	-	5,00€



N

54380

0.00	10	50	-

JEU DE 9 DOUILLES EN T (7-19MM)

119,00€



N

PIÈCES DE RECHANGE DISPONIBLES

REF.	mm				€	REF.	mm				€
16430	7	0.17	10	50	20,50€	16565	14	0.17	10	50	19,50€
16431	8	0.17	10	50	20,50€	16566	19	0.17	10	50	22,50€
16432	10	0.17	10	50	20,50€						
16433	11	0.17	10	50	20,50€						
16434	13	0.17	10	50	20,50€						
16435	15	0.17	10	50	21,50€						
16436	17	0.17	10	50	21,50€						

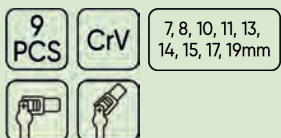

51501

0.88	5	20	240

COFFRET DE 12 PIÈCES EXTRACTION D'AIRBAGS

38,00€

12
PCS

- Pointes 0.5 PC 1/4" x 87 mm (L):
2x Torx: T25 (pour BMW), T30 (pour Audi, Opel, Renault, VW).
2x Torx (inviolable): T25H (Pour BMW), T30H (Pour AUDI, BMW, Mercedes, Opel).
1x Hex : 5 mm (Pour AUDI).

- 0.7 PC Outil extraction:
1x pour Airbag conducteur. 1999-04 nouveau style de carrosserie de VW Passat, JETTA, GOLF.
2x pour VW Passat B5, POLO, LUPO, AUDI A4, A6, Skoda Superb.
2x pour VW GOLF 4, New Beetle, SEAT, SKODA FABIA, AB Oktavia BJ.99.
1x pour VW GOLF 4 (BJ, 1998-2004), VW PASSAT BJ.1997 AB, AB BORA BJ.1999.
1x pour U.A VW-MODELLE : AB PASSAT BJ.2000.

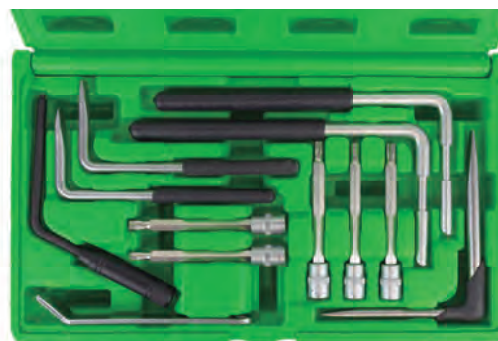

53388

1.50	-	5	120

COFFRET DE 52 PIÈCES POUR EXTRACTION D'ÉQUIPEMENTS D'AUDIO

90,00€

52
PCS

BLAUPUNKT, CLARION, SKODA, BMW, AUDI, GFUNDIG, JVC, PIONEER, VOLKSWAGEN, MERCEDES, OPEL DOPPEL-KUGEL-INBUS, PORSCHE, BECKER, KENWOOD, SONY, PANASONIC, FIAT BRAVA, FORD.



OUTIL SPÉCIAL

51126

18,00€

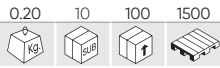

KIT D'ACCESSOIRES POUR LE DÉMONTAGE D'ÉQUIPE-RADIO

10
PCS

BLAUPUNKT, PEUGEOT, CLARION, SKODA, ALPINE, BMW, OPEL, AUDI, GFUNDIG VDO, JVC, PIONEER, VOLKSWAGEN, MERCEDES, PORSCHE, RENAULT, BECKER.



53393

118,00€

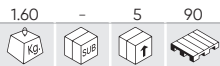

COFFRET DE 23 EXTRACTEURS DE TERMINAL

23
PCS



BMW, AUDI, VOLKSWAGEN, MERCEDES, OPEL, PORSCHE, JAGUAR, SAAB, SEAT, FORD, SKODA, RENAULT, CITROËN, CHRYSLER, FIAT, HONDA, MAZDA, MITSUBISHI, TOYOTA.

53391

86,00€

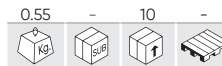

COFFRET DE 19 EXTRACTEURS DE TERMINAL

19
PCS

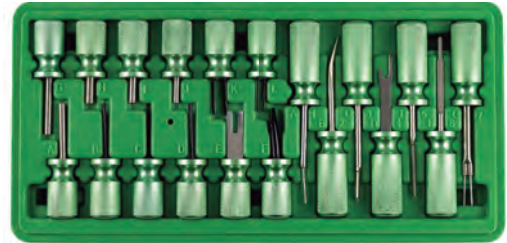

x19 A, B, C, D, E, F, G, H, I, J, K, L, A1, B2, C3, D4, E5, F6, G7

51986

11,90€



CARTOUCHE DE GAZ 200 ML

200ml



51920

18,00€

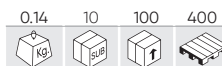

CHALUMEAU



53474

94,00€

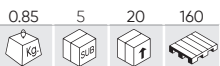

STROBOSCOPE NUMÉRIQUE

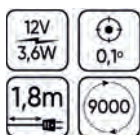

53240

58,00€

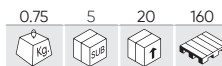

PISTOLET STROBOSCOPIQUE



53663

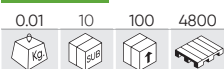

8,00€

OUTIL DE DÉSAMBLAGE DE CONNECTEURS VAG



- Outil permettant de démonter les connecteurs des véhicules du groupe VAG sans les endommager.



COFFRET KIT INSERTS HÉLICOÏDAUX

53041

37,60€

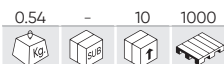

M14 x 1,25

SPÉCIAL BOUGIES



51898

139,00€

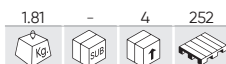

M18 x 2,5



51899

137,00€



M20 x 2,5



51896

82,00€

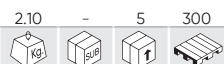

KIT INSERTS HÉLICOÏDEAUX

115 PCS



CONTIENT
Foret.
Filière mâle de finition.
Outil d'insertion hélicoïdal.
Pointeur de rupture.
Set de spirales en acier inox.

DIMENSIONS
25 x M5x0.8
25 x M6x1
25 x M8x1.25
25 x M10x1.5
10 x M12x1.75

51897

122,00€



KIT INSERTS HÉLICOÏDEAUX

39 PCS



CONTIENT
Foret.
Filière mâle de finition.
Outil d'insertion hélicoïdal.
Pointeur de rupture.
Set de spirales en acier inox.

DIMENSIONS
9 x M12x1.75
9 x M14x2
9 x M16x 2.0

INSERTS HÉLICOÏDEAUX

REF.	DESCRIPTION					€
52016	REPLACEMENT HÉLICOÏDES M5X0.8	0.01	10	300	72000	2,10€
52017	REPLACEMENT HÉLICOÏDES M6X1.0	0.01	500	1000	21000	2,40€
52018	REPLACEMENT HÉLICOÏDES M8X1.25	0.01	10	500	21000	2,60€
52019	REPLACEMENT HÉLICOÏDES M10X1.5	0.01	10	500	21000	3,20€
52021	REPLACEMENT HÉLICOÏDES M12X1.75	0.05	100	500	21000	3,40€
52022	REPLACEMENT HÉLICOÏDES M14X2.0	0.03	100	300	12600	4,50€
52023	REPLACEMENT HÉLICOÏDES M16X2.0	0.05	60	300	12600	6,60€
52024	REPLACEMENT HÉLICOÏDES M18X2.5	0.08	-	10	21000	10,60€
52025	REPLACEMENT HÉLICOÏDES M20X2.5	0.10	-	60	21000	13,00€

OUTIL SPÉCIAL

50793

94,00€

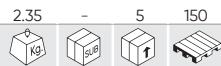

60
PCS

KIT DE 60 TARAUDS ET FILIÈRES METRIQUE ET POUCE

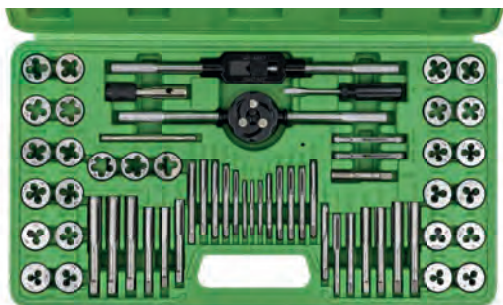

- x1 Mâle npt (pouces): 1/8-27
- x1 Dé de stock trp (pouces): 1/8-27
- x1 Mixte chiens porta: M3 ~ M12 ET 3/16" ~ 1/2".
- x1 Porta mixte de type 1t: M3 ~ M6 6-32 ET 4-40.
- x1 Taps porta mixtes: ø25mm
- x1 Tournevis.
- x1 Jeu de jauges métriques à la discussion.
- x1 Jeu de vis des jauges en pouces.
- x10 Mâles (métrique): m3x0.5, M4x0.7, M5x0.8, M6x1.0, M7x1.0, M8x1.25, M9x1.25, M10x1.0, M10x1.5, M12x1.75.
- x10 Mâles unc (pouces): 4-40, 6-32, 8-32, 10-24, 12-24, 1/4-20, 5/16-18, 3/8-16, 7/16-14, 1/2-13.
- x6 Unf taps (pouces): 10-32, 1/4-28, 5/16-24, 3/8-24, 7/16-20, 1/2-20.
- x10 Taps (métrique): M3x0.5, M4x0.7, M5x0.8, M6x1.0, M7x1.0, M8x1.25, M9x1.25, M10x1.0, M10x1.5, M12x1.75.
- x10 Unc meurt (pouces): 4-40, 6-32, 8-32, 10-24, 12-24, 1/4-20, 5/16-18, 3/8-16, 7/16-14, 1/2-13.
- x6 Unf taps (pouces): 10-32, 1/4-28, 5/16-24, 3/8-24, 7/16-20, 1/2-20.

50792

105,00€



58
PCS

KIT DE 58 TARAUDS ET FILIÈRES RECOUVERTES DE TITANE



- x1 Mâle type NPT : 1/8-27.
- x1 Filière type NPT : 1/8-27.
- x1 Porte-Mâles : M4~M12.
- x1 Porte-Mâles type T : M3~M6.
- x1 Porte-Filières : 25 mm O/D.
- x1 Tournevis.
- x1 Set de jauges à fileter.
- Mâles : M2x0.4 (x2), M3x0.6 (x2), M3x0.5 (x2), M3.5x0.6 (x2), M4x0.75 (x2), M4x0.7 (x2), M5x0.8 (x2), M6x0.75 (x2), M6x1.0 (x2), M7x0.75 (x2), M7x1.0 (x2), M8x1.0 (x2), M8x1.25 (x2), M10x1.25 (x2), M10x1.5 (x2), M12x1.25 (x2), M12x1.75 (x2)
- x17 Filières : M2x0.4, M3x0.6, M3x0.5, M3.5x0.6, M4x0.75, M4x0.7, M5x0.8, M6x0.75, M6x1.0, M7x0.75, M7x1.0, M8x1.0, M8x1.25, M10x1.25, M10x1.5, M12x1.25, M12x1.75

51496

8,00€

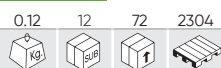

EXTRACTEUR DE GOUJONS QUEUE DE COCHON

- N°1 1/8" - 1/4" (M 3-6)
- N°2 1/4" - 5/16" (M 6-8)
- N°3 5/16" - 7/16" (M 8-11)
- N°4 7/16" - 9/16" (M 11-14)
- N°5 9/16" - 3/4" (M 14-18)



53502

38,70€



KIT D'EXTRACTEURS DES TARAUDS

- #2 M5
- #3 M6
- #4 M8
- #5 M10
- #6 M12
- #7 M14
- #8 M16
- #9 M20
- #10 M22



53055

33,00€



OUTILS POUR RIVER ET DÉMONTÉ LES CHAINES DE MOTOCYCLETTTE

POINTES DE RUPTURE 2.2mm, 2.9mm, 3.8mm



54280



156,50€

7 PCS N

KIT DE RÉPARATION DE FILETAGE DE BOUGIE

PIÈCES DE RECHANGE DISPONIBLES

REF.	DESCRIPTION				€
16237	M8X1,0 115MM	0.10	10	40	23,00€
16238	M10X1,0 115MM	0.10	10	40	23,00€
16239	M12X1,25 140MM	0.15	10	40	23,00€
16240	M12X1,25 270MM	0.30	10	40	26,00€
16241	M14X1,25 140MM	0.15	10	40	23,00€
16242	M14X1,25 270MM	0.35	10	40	26,00€
16243	M18X1,5 90MM	0.10	10	40	23,00€

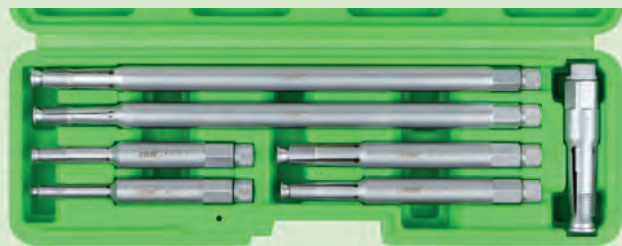

52833

39,30€

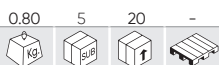

KIT DE DOUILLES EXTRACTEUR POUR GOUJONS

1/2"



PIÈCES DE RECHANGE DISPONIBLES

REF.	mm				€
14211	6mm	0.10	20	100	11,00€
14212	8mm	0.10	20	100	12,00€
14213	10mm	0.20	20	100	12,00€
14214	12mm	0.20	20	100	14,00€

53524

51,00€

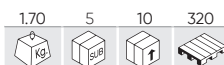

KIT DE 4 CASSE ECROUS

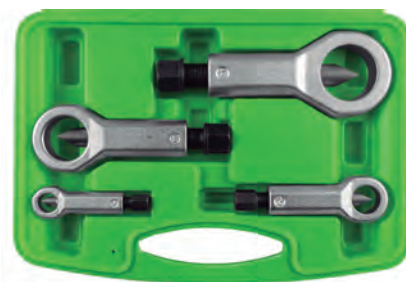

PIÈCES DE RECHANGE DISPONIBLES

REF.	mm					€
14049	9-12 mm (1/8" - 1/2")	0.10	-	50	-	8,00€
14050	12-16 mm (1/2" - 5/8")	0.20	-	50	-	10,50€
14051	16-22 mm (5/8" - 7/8")	0.44	25	50	-	18,00€
14052	22-36 mm (7/8" - 1-1/16")	0.65	-	20	-	19,50€

53652

53,00€



KIT DE RÉPARATION DE FILETAGE DE GOUJONS DE ROUE

PIÈCES DE RECHANGE DISPONIBLES

REF.	DESCRIPTION				€
14340	BOULON DE RÉPARATION M12X1.25 - PSA (RÉF. 53652)	0.05	-	20	10,50€
14341	BOULON DE RÉPARATION M12X1.5 - MERCEDES BENZ / BMW (RÉF. 53652)	1.14	-	20	10,50€
14342	BOULON DE RÉPARATION M12X1.75 - VOLVO (RÉF. 53652)	1.12	-	20	10,50€
14343	BOULON DE RÉPARATION M14X1.5 - VAG (RÉF. 53652)	1.29	-	20	10,50€
14344	DISQUE DE RÉPARATION M12X1.25 (RÉF. 53652)	0.49	-	20	11,00€
14345	DISQUE DE RÉPARATION M12X1.5 (RÉF. 53652)	0.50	-	20	11,00€
14346	DISQUE DE RÉPARATION M14X1.5 (RÉF. 53652)	0.46	-	20	11,00€



OUTIL SPÉCIAL

54003

104,00€

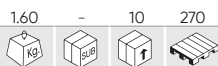

KIT DE RÉPARATION DE FILETAGE INTERNE ET EXTERNE



- x1 M14x1.5
- x1 M16x1.5
- x1 M18x1.5
- x1 M20x1.5
- x1 M22x1.5
- x1 M24x1.5
- x1 M27x2.0
- x1 M28x1.5



53665

19,00€

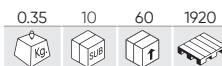

COUPE-CHAÎNE DE MOTOCYCLETTE (25-60)



53666

28,00€

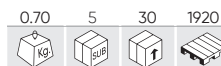

COUPE-CHAÎNE DE MOTOCYCLETTE (60-100)



53054

6,00€

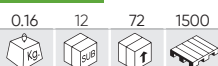

CLÉ À DOUILLE SPÉCIALE MOTOCYCLETTE



53086

9,00€

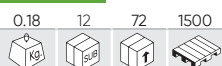

CLÉ POUR MOTOCYCLETTE



YAMAHA, KAWASAKI,
BMW, SUZUKI, HONDA

52454

12,90€



EXTRACTEUR BALAIS ESSUI-GLACES



53664

38,00€



EXTRACTEUR DE POULIES UNIVERSEL



Tige de 16mm de diamètre
avec bille de centrage et tête
hexagonale de 24mm.

51125

88,00€



COFFRET DÉCOLLEURS DE ROUEMENTS

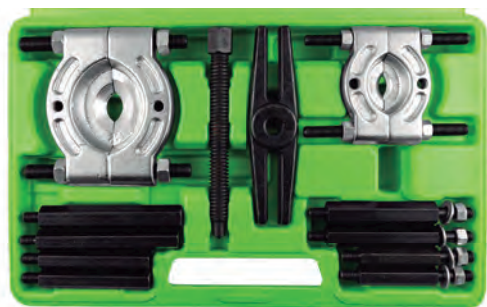

SET POUCE:

- x2 1/4", avec 30 mm et 50 mm.
- x1 Vis de 3/8" de 9.5x125 - 24 UNF.
- x1 Tête de 3/8" x 16 UNC.

SET 2 POUCES:

- x1 1/4" - 3 1/2", avec 50 x 75mm.
- x1 Vis de 1/2" de 12.7x135 - 20 UNF.
- x1 Tête de 3/8" x 16 UNC.

DÉCOLLEUR DE ROUEMENTS

REF.	DESCRIPTION	Kg	SUB	€
52626	75-105mm	3.65	- 5	800 46,00€
52627	105-150mm	6.50	- 2	231 120,00€



EXTRACTEUR 2 GRIFFES

REF.	DESCRIPTION	—	I					€
52727	EXTRACTEUR 2 GRIFFES 25-70MM	25-70mm	50mm	0.20	10	60	1200	34,60€
52728	EXTRACTEUR 2 GRIFFES 25-130MM	25-130mm	110mm	1.20	5	10	500	68,00€
52729	EXTRACTEUR 2 GRIFFES 60-200MM	60-200mm	160mm	3.26	-	3	240	128,00€
52730	EXTRACTEUR 2 GRIFFES 80-350MM	80-350mm	225mm	8.55	-	2	108	288,00€



REF.	DESCRIPTION					€
53146	PRÉSENTOIR POUR EXTRACTEURS	0.70	5	10	140	30,50€

EXTRACTEUR 3 GRIFFES

REF.	DESCRIPTION	—					€
52731	EXTRACTEUR 3 GRIFFES 50-100MM	50-100mm	0.90	4	24	504	38,00€
52732	EXTRACTEUR 3 GRIFFES 70-150MM	70-150mm	2.54	5	20	200	58,00€
52733	EXTRACTEUR 3 GRIFFES 95-200MM	95-200mm	5.20	-	4	112	98,00€



EXTRACTEUR 3 GRIFFES CONVERTIBLE EN 2 RÉVERSIBLE

REF.	DESCRIPTION	T					€
52010	EXTRACTEUR 3 GRIFFES CONVERTIBLE EN 2 RÉVERSIBLE 2T	2T	0.50	4	40	360	80,00€
52296	EXTRACTEUR 3 GRIFFES CONVERTIBLE EN 2 RÉVERSIBLE 5T	5T	1.57	4	8	120	119,00€
52297	EXTRACTEUR 3 GRIFFES CONVERTIBLE EN 2 RÉVERSIBLE 7T	7T	3.33	-	6	36	172,00€
52298	EXTRACTEUR 3 GRIFFES CONVERTIBLE EN 2 RÉVERSIBLE, LONGUE ET COURTE	2T	2.65	3	6	396	177,00€



OUTIL SPÉCIAL

53701

188,00€

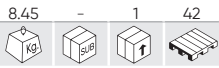

KIT D'ARRACHE-PIÈCES UNIVERSEL AVEC 2/3 PINCES

- Plage de travail 2 pattes: 45-120mm.
- Plage de travail 3 pattes: 50-130mm.
- Profondeur de serrage: 100, 200, 250mm.

CONTIENT

- Guide central pour 3 pattes.
- Guide central pour 2 pattes.
- Goujon: 275mm.
- Goujon: 165mm.
- Pattes longues avec pinces: 250mm.
- Pattes moyennes avec pinces: 200mm.
- Pattes courtes avec pinces: 100mm.

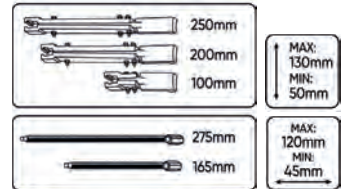

REF. DESCRIPTION

REF.	DESCRIPTION	kg	box	quantity	€
14611	EMBOUT DE PINCE POUR RÉF. 53701	0.10	-	50	12,00€
14612	VIS 165 MM POUR RÉF. 53701	0.15	-	20	11,00€
14613	VIS 275 MM POUR RÉF. 53701	0.30	-	20	13,50€

53062

99,00€

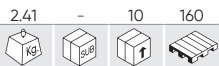

EXTRACTEUR DE COUSSINETS AVEC FAUSSES SPHERES

22 PCS
5, 6, 8, 9, 11, 12.5mm

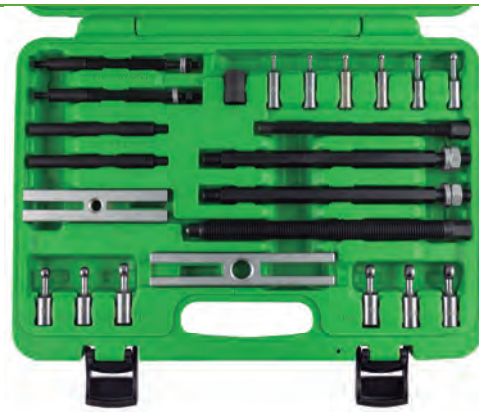

51140

64,00€

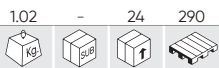

EXTRACTEUR DE POULIE VILEBREQUIN

- Conçu pour soutenir la poulie de l'arbre à cames immobile tandis qu'elle est détendue.
- Permet l'ajustement de l'axe central quand elles sont accouplées.
- En utilisant la barre vissée centrée pour déraciner la poulie.
- Vis de fixation: M6, M8.



51500

29,00€

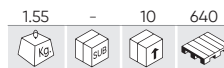

EXTRACTEUR DE POULIES

- Apte pour une utilisation dans des vilebrequins, alternateurs, unités d'AC et pompes à eau.
- Les bras du profilé bas permettent un accès facile à des zones difficiles du moteur.
- Conçu pour l'extraction du vilebrequin cannelé, coincé et de poulies auxiliaires.
- Rang: 40-160mm.



40-168mm

52494

227,00€

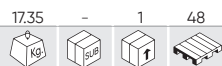

EXTRACTEUR UNIVERSEL DE RETIRAGE / INSTALLATION DE BOUGIES, ROULEMENTS ET SILENTBLOCKS

- Utile pour installer et désinstaller les bagues et suspension.
- Contient manches de taille différentes tiges filetées métriques pour couvrir la plupart des véhicules sur le marché.
- Dimensions: M10, M12, M14, M16, M18.

ADAPTATEURS (DIAMÈTRE EXTÉRIEUR/INTÉRIEUR) :

90/80, 85/75, 82/72, 80/70, 78/68, 76/66, 74/64, 72/62, 70/60, 68/58, 66/56, 64/54, 62/52, 60/50, 58/48, 56/46, 54/44, 52/42, 50/40, 48/38, 46/36, 44/34

REF. DESCRIPTION	Kg	Box	Box	Box	€
12926 VIS DE RECHANGE POUR 52494	0.46	-	20	1500	21,50€
12927 VIS DE RECHANGE M12 POUR 52494	0.52	-	20	-	21,50€
12928 VIS DE RECHANGE POUR 52494	0.60	-	30	1500	22,00€
12929 VIS DE RECHANGE M16 POUR 52494	0.66	-	20	-	23,00€
12930 VIS DE RECHANGE M18 POUR 52494	0.89	-	30	-	23,50€



51124

88,00€

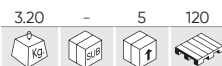

COFFRET EXTRACTION ROULEMENT

5 PCS

UNIVERSAL



CONTIENT

- Extracteur Universel (38,5mm).
- Adaptateur de 3/8" à 1/2" (10-14mm).
- Adaptateur de 9/16" à 11/16" (15-19mm).
- Adaptateur de 5/8" à 1" (18-25mm).
- Adaptateur de 1" à 11/4" (25-32mm).

52624

28,00€



COFFRET EXTRACTEUR POULIE ALTERNATEUR

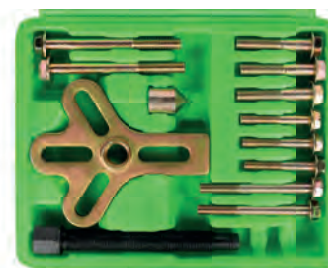

- x2 Vis 5/16" de 4"
- x2 Vis 1/4" de 3"
- x3 Vis 1/4" de 2"
- x3 Vis 5/16" de 2"
- x1 5" Vis de presión an alliage aluminium
- x1 Pointa giratoire 3/4"

53058

193,00€

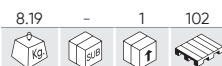

OUTIL POSE ROULEMENTS ET JOINTS SPI



- x49 Ø 18, 19, 20, 21, 22, 23, 24, 25, 26, 27, 28, 29, 30, 31, 32, 33, 34, 35, 36, 37, 38, 39, 40, 41, 42, 43, 44, 45, 46, 47, 48, 49, 50, 51, 52, 53, 54, 55, 56, 57, 58, 59, 60, 61, 62, 63, 64, 65, 74mm
- x1 Manche en métal (à utiliser avec un marteau) d'un diamètre de Ø 12 mm

53056

127,00€



COFFRET DE MONTAGE ET DÉMONTAGE DE ROULEMENTS



- x9 Ø 55.5, 59, 62, 65, 66, 71.5, 73, 78, 84mm
- x2 Ø 75.5, 83mm
- x1 Ø 69mm
- x1 295mm

OUTIL SPÉCIAL

52551

151,00€



COFFRET MONTAGE ET DÉMONTAGE DE ROUEMENTS



- x13** Tailles de disque : 50, 55, 60, 64, 67, 70, 72, 74, 75, 78, 82, 84, 88 mm
- x4** Cylindres : 76, 82, 92, 101 mm
- x1** Boulon : 32 mm
- x1** Sillet : 38mm
- x1** Vis renforcée pour une utilisation avec un outil à percussion.
- x1** Arbre en acier phosphaté pour éviter la corrosion.

53463

98,00€



KIT EXTRACTEUR DE BRAS D'ÉSSUIE GLACE



- VW: Polo, Lupo, Touareg , Porsche Cayenne.
 Opel: Astra G, Zaphira B, Corsa C, Vectra C.
 Honda: Jazz, CRV, FRV, Accord, Turnier.
 BMW: 5ème Modèle de E 39 à 2005.
 7ème Modèle de E 38 à 2005
 Audi: A3, A4, A5, A6. Audi Q7.
 Ford: Galaxy, Alhambra.
 Mercedes: A-Class, B-Class.

51349

37,30€



COFFRET MONTAGE ET DÉMONTAGE ROUEMENTS



- x13** 42 - 38mm, 40 - 35mm, 36 - 32mm, 30 - 28mm, 24 - 22mm, 27 - 25mm, 18 - 16mm, 20 - 18mm, 22 - 20mm, 12 - 10mm, 14 - 12mm, 16 - 14mm, 17 - 15mm

53059

52,00€



KIT D'EXTRACTIONS AXES ET RONDELLES



- x9** Ø 39,5, 44,5, 50, 59, 63, 65, 72, 76, 81mm

52056

66,00€



JEU DE 8 DOUILLES 1" POUR DEMULTIPLIEUR DE FORCE

PIÈCES DE RECHANGE DISPONIBLES

REF.	DESCRIPTION	Kg	Box	QTY	€
16385	DOUILLE 22MM 1" POUR DEMULTIPLIEUR DE FORCE	0.50	-	50	10,00€
16386	DOUILLE 24MM 1" POUR DEMULTIPLIEUR DE FORCE	0.45	-	50	11,50€
10674	DOUILLE 27MM 1" POUR DEMULTIPLIEUR DE FORCE	0.59	-	50	9,50€
10675	DOUILLE 30MM 1" POUR DEMULTIPLIEUR DE FORCE	0.55	-	50	9,50€
10672	DOUILLE 32MM 1" POUR DEMULTIPLIEUR DE FORCE	0.66	-	50	9,50€
10673	DOUILLE POUR MULTIPLIEUR DE FORCE 33MM 1" 52056	0.67	-	50	9,50€
16388	DOUILLE 38MM 1" POUR DEMULTIPLIEUR DE FORCE	0.70	-	50	11,50€
16389	DOUILLE 41MM 1" POUR DEMULTIPLIEUR DE FORCE	0.75	-	-	11,50€



OUTILS DE CHRONOMÉTRAGE

- 244 FIAT/ALFA ROMEO
- 249 BMW/MINI
- 258 PSA
- 261 FORD
- 267 JAGUAR/LAND ROVER
- 269 JEEP/CHRYSLER
- 270 MERCEDES-BENZ
- 273 RENAULT/DACIA/NISSAN
- 278 OPEL/VAUXHALL
- 283 VAG
- 295 AUTRES
- 297 OUTILS SUPPLÉMENTAIRES



53303

89,00€

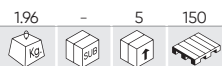

COFFRET DE CALAGE POUR FIAT / OPEL

MARQUES	FIAT: 1.9D/JTD (MOTOR PEUGEOT), 2.4D. ALFA ROMEO: 145, 146, 156 JTD. GM: GM 1.3, 1.6, 1.9, 2.0, 2.4 CDTI (2004 -).
OUTILS OEM	EN-46789 (1), EN-46789-100 (2), EN-46785 (3), EN-46788 (4), EN-46781 (5), EN-46789 (6)
CODES MOTEUR	GM: K1.3 CDTI Z13DT COMMON RAIL ENGINE. 1.9 CDTI / 04-12 - Z19DT Z19DTH Z19DTJ Z19DTL 2.0 CDTI / 08-12 - A20DT LBS / LBX / LBY / LCD.V SAAB: 1.9 TID.

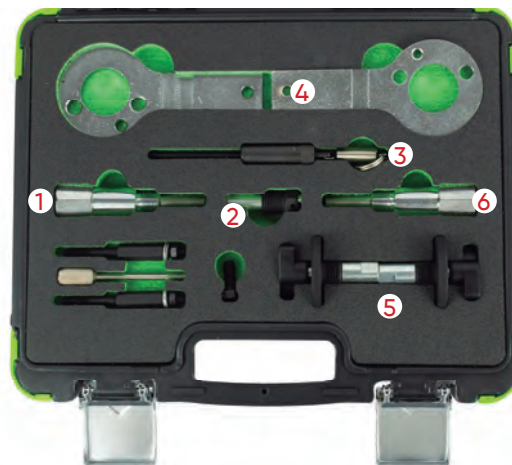

53304

279,00€

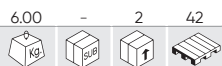

COFFRET DE CALAGE POUR FIAT

MARQUES	FIAT
OUTILS OEM	1 860 874 000 (1), 1 860 895 000 (2), 1 860 898 000 (3), 1 860 905 000 (4), 1 860 845 000 (5)
CODES MOTEUR	PETROL: FIAT BRAVA , BRAVO, BARCHETTA, CARGO, COUPE, MAREA, PALIO, WEEKEND, PUNTO, MULTILA, STILO, IDEA, DOBLO TWIN CAM ENGINES - 1.2, 1.4, 1.6, 1.8, 16V GASOIL: FIAT BRAVA, BRAVO, MAREA, WEEKEND, PALIO, PUNTO, MULTITPLA, DOBLO, ULYSSE, DUCATO, STILO JTD DIESEL ENGINES - 1.9D/TD . 1.9JTD . 2.4TD/JTD.

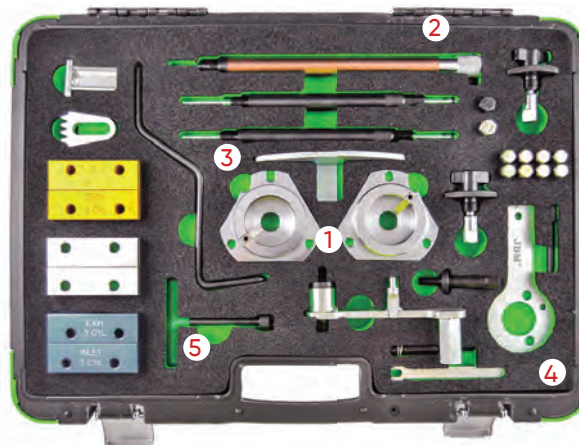

53306

53,00€

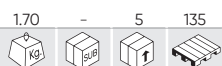

COFFRET DE CALAGE POUR FIAT 1.2 16V

MARQUES	FIAT: FIAT 1.2L 16V, FIAT PUNTO / BRAVA / BRAVO / STILO
OUTILS OEM	1860992000 (1) (2), 1871000900 (3), 1860987000 (4), 186985000 (5)
CODES MOTEUR	176 B9.000, 182 B2.000, 188 A5.000



53308

55,00€

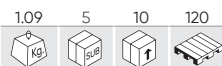

COFFRET DE CALAGE POUR ALFA ROMEO

MARQUES	ALFA ROMEO: 145,146,147,155,156, 1.4 1.6 1.8 2.0 TS, 1.4/1.6 16V; 145/146/147/155/156 (96-10), 1.8 16V; 145/146, (96-01), 155/156 (96-06), SPIDER/GTV (98-05), 2.0 16V; 145/146 (96-01), 147 (01-10), 155/156 (95-02), 166 (98-07), SPIDER/GTV (96-05), PÚRPURA / PURPLE: 1.4, 1.6 // AZUL / BLUE: 1.8, 2.0
OUTILS OEM	1822149000 (1), 1822154000 (2), 1825041000 (3), 1825042000 (4)
CODES MOTEUR	Z1.4/1.6-321.02, 321.03, 321.04, 335.03, 676.01 1.8/2.0-323.01, 672.04, 162.01, 323.10, 671.06, 322.01, 671.02, 322.05, 341.03, 363.01.

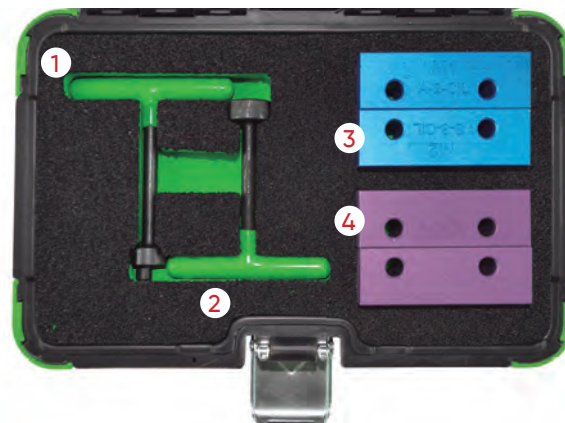

53309

285,00€

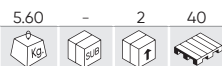

COFFRET DE CALAGE POUR ALFA/FIAT/LANCIA 1.4, 1.6, 1.8, 2.0 16V

MARQUES	ALFA ROMEO: 145,146,147,155,156, 1.4 1.6 1.8 2.0 TS, 1.4/1.6 16V; 145/146/147/155/156 (96-10), 1.8 16V; 145/146, (96-01), 155/156 (96-06), SPIDER/GTV (98-05), 2.0 16V; 145/146 (96-01), 147 (01-10), 155/156 (95-02), 166 (98-07), SPIDER/GTV (96-05), PURPUR: 1.4, 1.6 // BLAU: 1.8, 2.0 FIAT: BARCHETTA (96-00), BRAVA (95-00), BRAVO (95-0 0), COUPE (96-01), MAREA (96-00), MAREA WEEKEND (96-00), PUNTO/PUNTO CLASSIC (99-06), STILO (01-08) LANCIA: DEDRA (95-99), DELTA (96-99), KAPPA (98-02), LYBRA (99-06).
OUTILS OEM	1.4 16V: 335.03 1.6 16V: 321.02, 321.03, 321.04, 372.03, 676.01 1.8 16V: 322.01, 322.05, 671.06, 182A2.000, 183A1.000, 183A6.000, 188A6.000, 192A4.000 2.0 16V: 162.01, 323.01, 323.1, 341.03, 363.01, 672.04 2.0 20V: 175A3.000, 182A1.000, 182B7.000, 185A8.000.

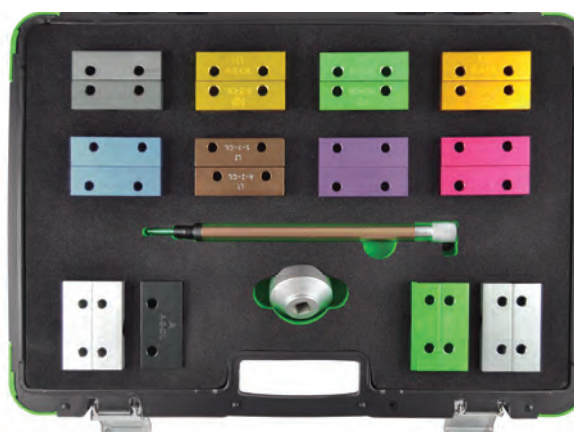

53310

498,00€



COFFRET DE CALAGE POUR FIAT/ALFA/LANCIA

MARQUES	ALFA FIAT LANCIA	ALLA, BARCHETTA, BRAVO, BRAVA, COUPE, DELTA, DEDRA, PUNTO, SPIDER, GT
OUTILS OEM	1860845000 (1), 1822154000 (2), 1860905000 (3), 1860992000 (4), 1860895000 (5), 1860874000 (6), 1860985000 (7), KM571A (8), 1 860 896 000 (9), 0153A (10)	
CODES MOTEUR	1.2 / 16V, 1.4 / 12V, 1.6 / 16V, 1.6 ECO. 1.8, 2.0 / 16V, 2.0 / 20V, 2.4 / 20V, 3.0 / V6.	



53312

127,00€



COFFRET DE CALAGE POUR FIAT/ALFA/FORD

MARQUES	FIAT: NEW 500 (07-09), IDEA (04-09), LINEA (07-09), GRANDE PUNTO (07-09), DOBLO 1 CARGO (05-09), PANDA EV02 (05) FORD: KA 1.2 DURATEC (09) ALFA ROMEO
OUTILS OEM	1 860 987 000 (1), 2 000 004 400 (2), 2 000 015 800 (3), 2 000 004 300 (4), 2 000 004 500 (5)
CODES MOTEUR	1.2: 169A4.000 / 199A4.000 . 1.4: 350A 1.000 / 188A4.000-EV02.

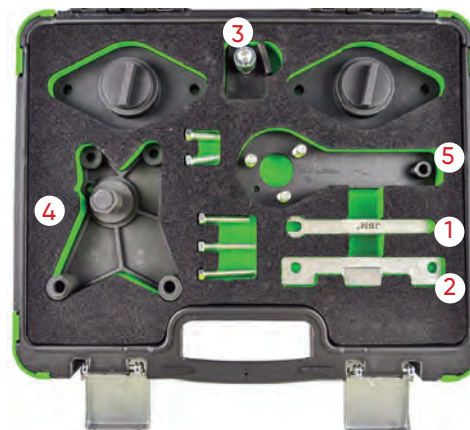

53319

18,00€

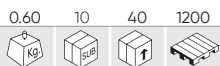

COFFRET DE CALAGE POUR FIAT IVECO 2.3, 3.0 JTD

MARQUES	FIAT: 2.3 / 3.0 JTD. IVECO: DAILY.
OUTILS OEM	99360614, 1860 617 000, 99360615, 2 000 018 200.
CODES MOTEUR	F1AE0481C, F1AE0481D, F1AE0481N, F1CE0481A/D.

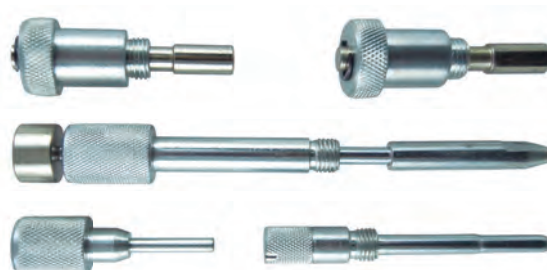

54202

68,00€



COFFRET DE CALAGE POUR FIAT/ALFA ROMEO/LANCIA

MARQUES	ALFA ROMEO: GIULIETTA (10-14), MITO (08-17). FIAT: 500 (07-19), 500L (12-19), 500C (07-19), 500 ABARTH (08-17), BRAVO (07-14), BRAVA/BRAVO (98-02), DOBLO/DOBLO CARGO (10-19), EGEA (15-20), GRANDE PUNTO (07-10), GRANDE PUNTO ABARTH (07-10), IDEA (04-12), LINEA (07-10), MAREA/WEEKEND (98-00), PALIO WEEKEND (01-06), PANDA (07-11), PUNTO (97-08), STILO (01-08), TIPO (15-20). LANCIA: DELTA (08-12), MUSA (04-13), YPSILON (96-11).
OUTILS OEM	2.000.004.500 (1), 1.860.985.000 (2), 1.860.992.000 (3), 1.860.987.000 (4), 2.000.015.800 (5)
CODES MOTEUR	1.2 16V:176B9.000, 182B2.000, 188A5.000. 1.4 16V / T-JET: 169A3.000, 192B2.000, 198A1.000, 198A4.000, 199A6.000, 198A8.000, , 312A1.000, 312A3.000, 843A1.000, 955A1.000.

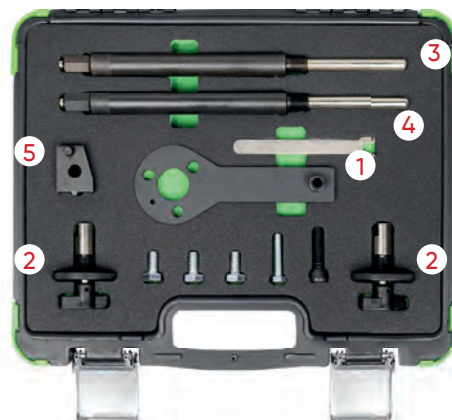

54203

91,00€

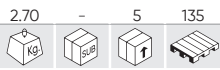

COFFRET DE CALAGE POUR ALFA ROMEO/LANCIA 1.8 TBI

MARQUES	ALFA ROMEO: 159(09-12), BRERA(09-11), GIULIETTA(10-19), SPIDER(09-11), 4C(13-19). LANCIA: DELTA(09-14).
OUTILS OEM	2 000033500 (1), 2000 003000 (2), 1860898 000 (3).
CODES MOTEUR	ALFA ROMEO 1,75 TBI: 939B1.000, 940A1.000, 940B2.000, 960A1.000 LANCIA 1,75 DI TURBO JET: 939B1.000

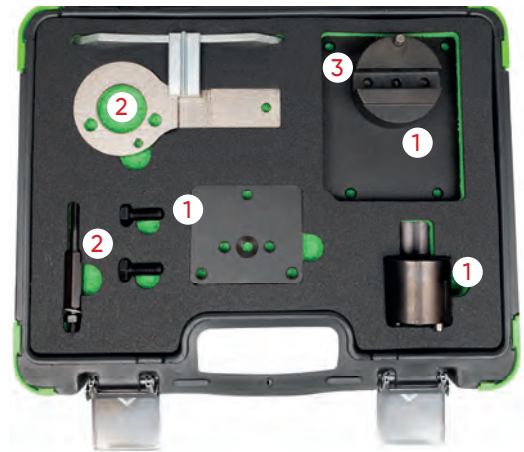

54211

74,00€

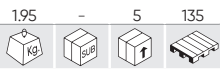

VOFFRET DE CALAGE POUR FIAT/FORD/OPEL/SUZUKI 1.3L

MARQUES	FIAT: PUNTO (2003-2007) / PANDA (2003-2009) / IDEA (2004-2006) / DOBLO (2004-2006). FORD: KA. VAUXHALL / OPEL: AGILA (2003-2008) / CORSA C (2003-2007) / CORSA D (2006-2009) / COMBO C (2003-2009) / ASTRA H (2004-2009) TIGRA B (2004-2009) / MERIVA (2004-2009). SUZUKI: IGNIS (2003-2009) / WAGON R (2003-2009) / SWIFT (2003-2010).
OUTILS OEM	1871000200 / 303-1469 / KM-662-C (1), EN 46785 / KM 955 / 09912-38300 (2), 1871000900 / 1860985000 / 303-1472 / EN 46781 / 09917-68610 (3), 1870900400 (4), 1870900300 / 303-1468 (5)
CODES MOTEUR	FIAT: 1.3 JTD 188A9.000 / 169A.000 / 188A8.000 / 199A3.000. FORD: 1.3 TDCI. VAUXHALL / OPEL: 1.3 CDTI Z13DT / Z13DTH / Z13DTJ. SUZUKI: 1.3 CDTI Z13DT.

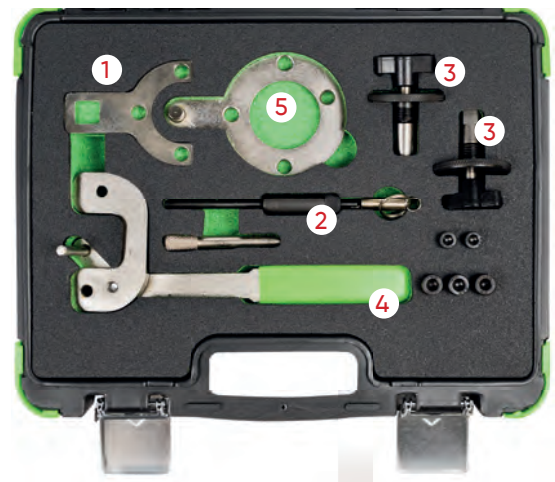

54212

39,40€

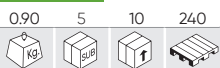

COFFRET DE CALAGE POUR FIAT/LANCIA 1,4 12V

MARQUES	MAREA/MAREA_WEEKEND(96-20), BRAVA(95-98), BRAVO(95-98). LANCIA: YPSILON(96-20)
OUTILS OEM	1860899000 (1), 1860901000 (2)
CODES MOTEUR	1.4 12V : 182A3.000, 182A5.000.



54215

57,00€

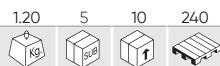

COFFRET DE CALAGE POUR ALFA ROMEO/FIAT 1.4 MULTIAIR

MARQUES	ALFA ROMEO GIULIETTA, MITO / FIAT PUNTO, PUNTO EVO 1.4 (TURBO) MULTIAIR (105/135/163/170PS)
OUTILS OEM	ALFA ROMEO / FIAT: 1860987000 (1), 2000034400 (2), 2000004500 (3)
CODES MOTEUR	940A2.000 / 940A2.000 / 955A8.000 / 955A8.000 / 940A2.000 / 955A8.000 / 955A2.000 / 955A7.000 / 955A6.000 / 955A8.000



54216

49,00€

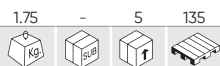

COFFRET DE CALAGE POUR FIAT/OPEL/ALFA 1.9, 2.4L 16V

MARQUES	OPEL 1.9, ALFA-ROMEO 1.9-2.4 L DIESEL, FIAT 1.9- 2.4 L DIESEL
OUTILS OEM	OPEL EN-46788 / FIAT 1.860.905.000 / 1.860.905.010 (1) FIAT 1.860.898.000 (2) OPEL EN-46789 / FIAT 1.870.896.900 (3) OPEL KM 6130 / KM 6349 (4)
CODES MOTEUR	OPEL 1.9 CDTI Z19DT, Z19DTH, Z19DTJ ALFA-ROMEO 1.9 Y 2.4 L : 323.02, 371.01, 342.02, 325.01, 362.02, 182B9.000, 937A2.000, 937A3.000, 192A5.000, 192B1.000, 937A4.000, 937A5.000, 939A2.000, 939A1.000, 939A7.000, 939A8.000, 839A6.000, 841C.000 FIAT 1.9 Y 2.4 L : 182B4.000, 182B9.000, 185A6.000, 186A6.000, 186A8.000, 186A9.000, 188A2.000, 188A7.000, 188B2.000, 192A1.000, 192A3.000, 192A5.000, 192A8.000, 192A9.000, 192B4.000, 192B5.000, 198A2.000, 198A3.000, 198A6.000, 199A5.000, 223A7.000, 937A5.000, 939A1.000, 939A2.000, 939A3.000, 939A7.000



54430

34,00€

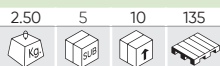

KIT DE DISTRIBUTION POUR ALFA ROMEO/FIAT/LANCIA 0.9 TWIN AIR

MARQUES	ALFA ROMEO: MITO (2001-2018) CHRYSLER: YPSILON (2011-2015) FIAT: 500/500C (2010-2020), 500L/500L LIVING/500L MPW (2012-2018), PUNTO (2012-2018), PANDA (2012-) LANCIA: YPSILON (2011-2018)
OUTILS OEM	2 000 035 100 (1) 2 000 035 200 (2) 2 000 035 300 (3)
CODES MOTEUR	Q.9: 199B6.000, 199B7.000, 312A2.000, 312A4.000, 312A5.000, 312A6.000, 312A7.000



53259

97,00€

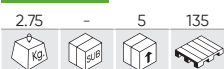

COFFRET DE CALAGE POUR BMW N42, N46 1.8, 2.0

MARQUES	BMW 1 SERIES: 118i E81/82/87/88 (04-14), 120i E81/82/87/88 (04-14). BMW 3 SERIES: 316i/TI COMPACT E46 (01-07), 318i/TI COMPACT E46 (01-07), 318i, E90/91/92/93 (05-12), 320i E90/91/92/93 (05-12). BMW 5 SERIES: 520i E60/61 (07-10), Z4 2.0 E85/86 (04-09). BMW X SERIES: X1 SDRIVE 18i E84 (10-12), X1 XDRIVE 18i E84 (10-12), X3 2.0 E83 (05-10).
OUTILS OEM	119350 (1), 119340 (2), 119291 (3), 119292 (4), 119270 (5), 115120 (6), 119190 (7), 119293 (8)
CODES MOTEUR	1.8: N42; B18A, N46; B18. / 2.0: N42; B20A, N46; B20, B20B, N46T; B20, B20B, B20BD, B20BZ, B20O2, B2O2.



53260

168,00€



COFFRET DE CALAGE POUR BMW N43 1,6/2,0

MARQUES	BMW 1 SERIES: 116i E81/82/87/88 (07-12), 118i E81/82/87/88 (06-14), 120i E81/82/87/88 (06-14). BMW 3 SERIES: 316i E90/91/92/93 (07-11), 318i E90/91/92/93 (07-13), 320i E90/91/92/93 (07-14). BMW 5 SERIES: 520i E60/61 (07-10).
OUTILS OEM	118690 (118691/118692/118693) (1), 118710 (118711/118712) (2), 113340 (3) (4), 118700 (5), 119340 (119341/119342) (6), 115120 (7).
CODES MOTEUR	1.6: N43 B16A/AA, B16AA, B16AA/OO. 2.0: N43 B20A, B20A/AA, B20AA, B20AY, B20KO, B20UO.

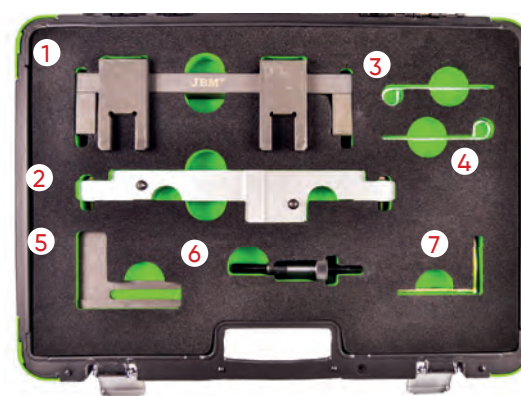

53261

214,00€

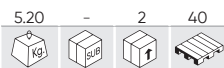

COFFRET DE CALAGE POUR BMW N42, N46 1.8, 2.0

MARQUES	BMW 1 SERIES: 118i E81/82/87/88 (04-14), 120i E81/82/87/88 (04-14). BMW 3 SERIES: 316i/TI COMPACT E46 (01-07), 318i/TI COMPACT E46 (01-07), 318i E90/91/92/93 (05-12), 320i (E90/91/92/93 (05-14). BMW 5 SERIES: 520i E60/61 (07-10). BMW X SERIES: X1 E84 SDRIVE 18i (10-12), X1 E84 XDRIVE 18i (10-12), X3 E83 2.0 (05-10). BMW Z SERIES: Z4 2.0 E85/86 (04-09).
OUTILS OEM	119190 (1), 119310 (2), 119302 (3)
CODES MOTEUR	2.0: N42 B18A, N42 B20A, N46 B18, N46 B20, N46 B20B, N46T B20, N46T B20B, N46T B20BD, N46T B20BZ, N46T B20O2, N46T B2O2

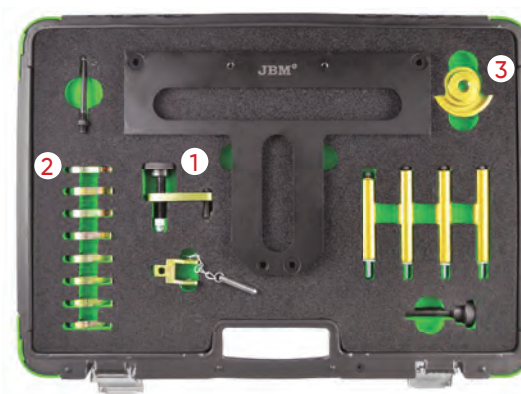

53262

251,00€

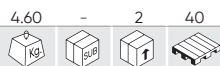

COFFRET DE CALAGE ARBRE À CAMES BMW M52TU, M54, M56

MARQUES	M52TUB25: 1997-2001 E46 323i/323Ci/323Ti (M52T); 1998-2001 E39 523i (M52TU); 1998-2001 E36/7 Z3 (M52TU). M52TUB28: 1997-2001 E46 328i/328Ci (M52TU); 1997-2001 E36/7 Z3 2.8 (M52B28/Z3); 1998-2001 E39 528i (M52TU); 1998-2001 E38 728i (M52TU). M54B22: 2001-2003 E46 320i/320Ci; 2001-2003 E39 520i; 2001-2002 E36 Z3 2.2i; 2003-2005 E85 Z4 2.2i; 2003-2005 E60/E61 520i. M54B25: 2001-2002 E36/7 Z3 2.5i; 2001-2005 E46 325i/325Xi; 2001-2006 E46 325Ci; 2001-2004 E46 325Ti; 2001-2004 E39 525i; 2003-2004 E60/E61 525i/525Xi; 2004-2006 E83 X3 2.5i; 2004-2006 E85 Z4 2.5i. M54B30: 2001-2005 E46 330i/330Xi; 2001-2006 E46 330Ci; 2001-2003 E39 530i/2001-2002 E36 Z3 3.0i; 2003-2005 BMW E60 530i; 2003-2006 E85 Z4 3.0i; 2001-2006 E53 X5 3.0i.
OUTILS OEM	116150 (1), 113450 (2), 113292 (3), 116180 (4), 114220(5)

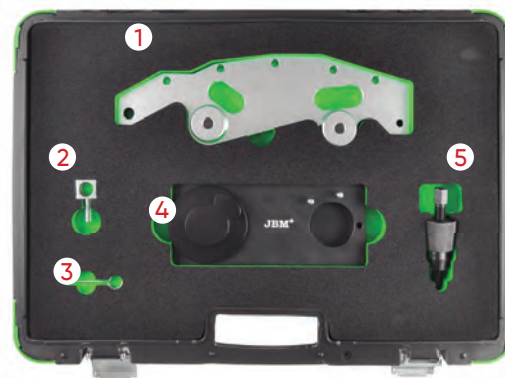

53263

57,00€



COFFRET DE CALAGE ARBRE A CAME BMW M47 LAND ROVER TD4,TD6

MARQUES	BMW 1 SERIES: 118D E87 (04-07), 120D E87 (04-07). BMW 3 SERIES: 318D/TD COMPACT E46 (01-05), 318D/TD E90/91 (05-08), 320D/TD COMPACT E46 (98-05), 320D/CD E90/91 (05-08), 325D E90/91/92/93 (02-10), 330D/CD E46/90/91/92/93 (99-07), 335D E90/91/92 (06-11). BMW 5 SERIES: 520D E39/60/61 (00-09), 525D/XD E39/60/61 (00-10), 530D/XD E46/60/61 (98-10), 535D E60/61 (04-10). BMW 6 SERIES: 635D E63/64 (07-11). BMW 7 SERIES: 730D/LD E38/65/66 (98-08). BMW X SERIES: X3 2.0D E83 (04-07), X3 3.0D/SD E83 (03-10), X5 3.0D E53/E70 (00-10), X6 3.0D E71/72 (08-10), X6 3.5D E71/72 (08-10). LAND ROVER: FREELANDER TD4 (00-06), RANGE ROVER TD6 (02-06). MG/ROVER: MG-ZT/T (01-05), ROVER 75 CDT/CDTI (99-05). VAUXHALL/OPEL: OMEGA-B (01-03).
OUTILS OEM	112300/12-108, 12-171/KM-813 (1), 113340/12-172/KM-823 (2) (3), 116322/12-174/KM-6267 (4) 116320 (5)
CODES MOTEUR	BM - 2.0D: M47, M47T2, M47TU / 2.5D: M57, M57T2, M57TU / 3.0D: M57, M57T2, M57TU LAND ROVER - 2.0D: 204D3 (TD4) / 3.0D: 306D1 (TD6) MG/ROVER- 2.0D: M47R / 2.0D CDT: M47R VAUXHALL/OPEL- 2.5D: Y25DT



53264

143,00€



COFFRET DE CALAGE POUR BMW N62, N73

MARQUES	BMW 5 SERIES: 540i E60/61 (05-10), 545i E60/61 (03-06), 550i E60/61 (05-10). BMW 6 SERIES: 645i E63/64 (03-06), 650i E63/64 (05-11). BMW 7 SERIES: 735i E65/66 (02-05), 740i E65/66 (05-10), 745i E65/66 (02-05), 750i E65/66 (05-08), 760i E65/66 (02-08). BMW X SERIES: X5 4.4 E53 (03-07), X5 4.8 E53/E70 (04-10).
OUTILS OEM	119463 (1), 119462 (2), 119340 (3), 119461 (4), 119190 (5)
CODES MOTEUR	3.6 V8: N62 B36A 4.4 V8: N62 B44A 4.0 V8: N62 B40A 4.8 V8: N62 B48B 6.0 V12: N73 B60A

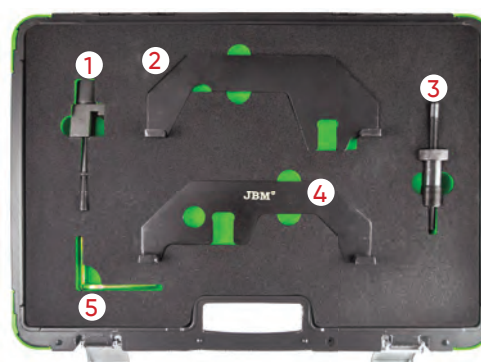

53265

195,00€

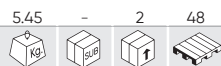

COFFRET DE CALAGE POUR BMW DIESEL M47, M57, M41, M51

MARQUES	BMW
OUTILS OEM	113360 (1), 116321 (2), 135190 (3), 135191 (4), 135192 (5), 116322 (6), 112300 (7), 113340 (8)
CODES MOTEUR	M41 / M51 / M47TU / M47TU T2. M57TU T2 3.01 1998 - 2008.

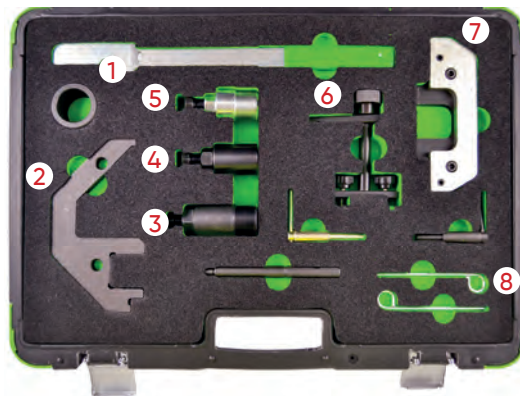

53266

224,00€



COFFRET DE CALAGE POUR BMW M42, M43, M50, M51, M52

MARQUES	BMW
OUTILS OEM	113240 (1), 115490 (2), 113190 (3), 112300 (4) (5), 113292 (6), 113320 (7)
CODES MOTEUR	PETROL: M42, M43, M50, M52, M60. DIESEL: M51

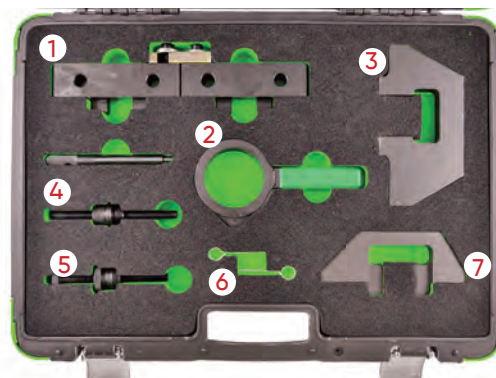

53267

277,00€



COFFRET DE CALAGE POUR BMW M40, M43, M42, M44, M52, M54, M56

MARQUES	BMW SERIES: 3, 5, 7, X, Z
OUTILS OEM	114220 (1), 112300 (2), 113240 (3), 115490 (4), 113292 (5), 113450 (6)
CODES MOTEUR	M40. M44. M50. M52. M54. M56.

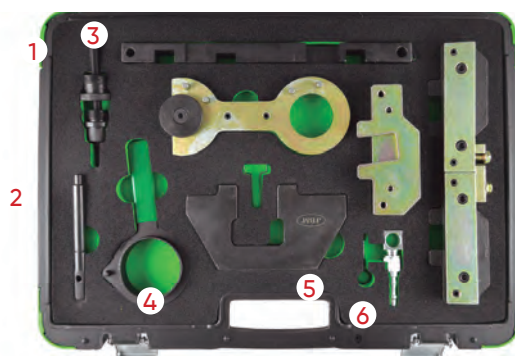

53269

50,00€

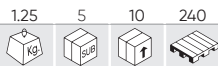

COFFRET DE CALAGE POUR BMW N47, N47S, N57

MARQUES	<p>BMW 1 SERIES: 116D E81/82/87/88 (08-12), 118D E81/82/87/88 (07-14), 120D E81/82/87/88 (07-14), 123D E81/82/87/88 (07-14). BMW 2 SERIES: 218D (11-14), 220D (11-14), 225D (11-14). BMW 3 SERIES: 316D E90/91/92/93 (09-12), 318D E90/91/92/93 (07-12), 320D E90/91/92/93 (07-12), 325D E90/91/92/93 (10-14), 330D/XD E90/91/92/93 (08-14). BMW 5 SERIES: 520D E60/61 (07-10), 525D F10/11 (10-12), 530D F10/11 (10-13), 530DGT F07 (09-12), 535D F10/11 (10-17), 535DGT F07 (10-12). BMW 7 SERIES: 730D/LD F01/02/04 (08-12), 740D F01/02/04 (09-12), 740D XDRIVE F01/02/04 (09-12), 750D XDRIVE F01/02/04 (12-15). BMW X SERIES: X1 SDRIVE 18D E84 (09-15), X1 SDRIVE 20D E84 (09-12), X1 XDRIVE 18D E84 (09-15), X1 XDRIVE 20D E84 (09-15), X1 XDRIVE 23D E84 (09-12), X3 2.0D E83 (07-10), X3 XDRIVE 18D E83 (08-10), X3 XDRIVE 30D E83 (11-12), X3 XDRIVE35D F25 (11-17), X5 3.0D E70 (10-13), X5 XDRIVE 40D X5 F15 M50D (13-17), E70 (10-13), X6 XDRIVE 30D E71/72 (10-14), X6 XDRIVE 40D E71/72 (10-14), X6 F16 M50D (14-17). BMW MINI: PACEMAN (13-17), COUNTRYMAN (10-17), MINI (10-15), ROADSTER (12-14), CLUBMAN (10-14), CLUBVAN (12-14).</p>
OUTILS OEM	118760 (1), 118740 (2), 116480 (3), 115320 (4)
CODES MOTEUR	<p>1.6 D: N47; C16K1, C16U1. 2.0 D: N47; C20K1, C20U1N47; D20, D20A, D20B, D20D, D20K1, D20O0, D20O1, D20T1, D20U0, D20U1, N47S D20T0, N47T; D20, D20O1, D20U1. 3.0 D: N57; B30B, B30B/T0, B30C, D30BT0, D30O0, D30O1, D30T0, D30T1, D30U0.</p>



54206

113,00€



COFFRET DE CALAGE POUR BMW/MINI 1.5 , 2.0L

MARQUES	<p>BMW - 1 SERIES - 114D, 116D, 214D - (F20/ 21) - (2015- 2017) - 2 SERIES - 216D, 118D, 125D - (F22/ 23/ 45/ 46) - (2014-2017) - 3 SERIES - 218D, 220D, 225D - (F30/31/34) - (2015-2017) - 4 SERIES - 316D/320D/325D - (F32, 33, 36) - (2015-2017) - 5 SERIES - 420D, 425D, 418D - (F10, 11) - (2014-2017) - X1 SERIES - 518D - (F48) - (2015-2017) - X3 SERIES - (F25) - (2014-2017) - EFFICIENT DYNAMICS - X4 SERIES - (F26) - (2014-2017) - XDRIVE - X5 SERIES - (F15) - (2015-2017) - SDRIVE MINI - CLUBMAN - (F54) - (2015-2017) - ONE D CONVERTIBLE - (F57) - (2016-2017) - COOPER D/ SD MINI HATCH (F55, 56) - (2014-2017)</p>
OUTILS OEM	114120 (1), 2347904 (2), 2365488 (3), 2288380 (4), 118760 (5), 118740, 118030 (6)
CODES MOTEUR	<p>1.5: B37 D15A, B37 C15A 2.0: B47 D20A, B47 D20B, B47 C20A, B47, B47 C20B</p>

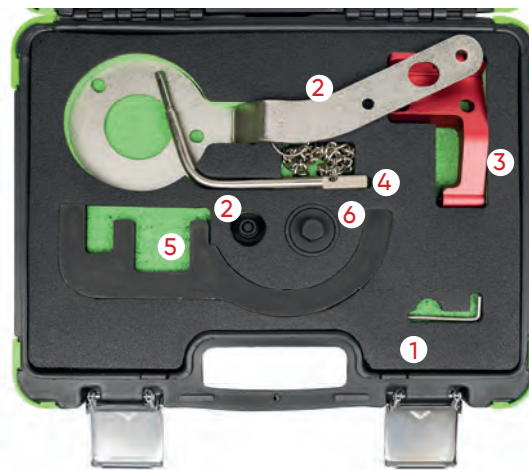

VOTRE JEU D'OUTILS DE CHRONOMÉTRAGE ENCORE PLUS PRÉCIS

ENTREZ LE CODE DE L'OUTIL OEM OU LE CODE DU MOTEUR DE VOTRE VOITURE DANS VOTRE NAVIGATEUR WEB ET TROUVEZ VOTRE OUTIL DE CHRONOMÉTRAGE COMPATIBLE

54219

60,00€

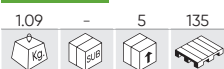

COFFRET DE CALAGE POUR BMW/MINI/CITROËN/PEUGEOT

MARQUES	BMW MINI PSA
OUTILS OEM	115140 (1), 119280 (2), 119330 (3), 113340 (4), 114360 (5)
CODES MOTEUR	BMW 1.6 (N40 / N45 / N45T, B16, B16A, B16AC) 1.8 / 2.0 (N42 / N46 / N46T) 2.0 / 3.0 (N51 / N52 / N52-COMPONENTE / N53 / N54) PSA 1.4 / 1.6 16V (EP3 / EP6 / EP6DT / EP6DTS) MINI 1.4 / 1.6 (N12 / N14)



54222

59,00€



COFFRET DE CALAGE POUR MINI 1.6

MARQUES	BMW: MINI COOPER S(07-10) PEUGEOT: 207(06-10), 307(06-10), GT(06-10), THP(06-10), GTI(06-10) CITROËN: DS3(06-10), C4(06-10), GRANDE PICASSO TPH(06-10)
OUTILS OEM	119550(1), 119551(2), 119552(3), 119590(4)
CODES MOTEUR	N14 B16A , N14 B16CD , N14 B16TO

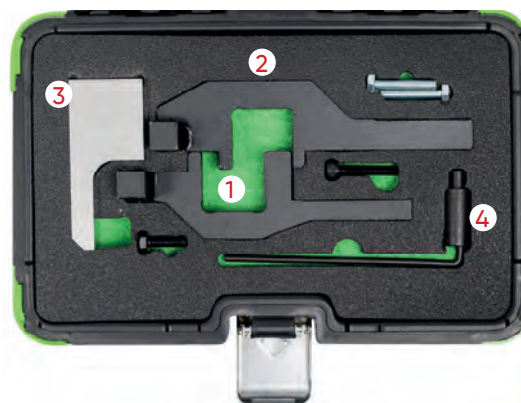

54227

122,00€



COFFRET DE CALAGE POUR BMW/MINI N13, N18, PSA

OUTILS OEM	EN-52127-2, EN-52588, E1 100, G 1376A, T10550/2, T10550/3, 0 496 709, 0109 2B, 0197 A11, 0197 A3, 0197 A31, 0197-A1, 0197-A1Z, 0197-A11, 0197A2, 0197-A31, 0197-A32, 0197-A33, 0197-BZ, 0197-M, 0197-N, 11 7 440 (1), 11 9 340 (2), 11 9 540, 11 9 551, 11 9 590, 1376-A, 2 299 362 (3)
CODES MOTEUR	N12 B14A, N13 B16A, N14 B16A, N14 B16C, N16 B16A, N18 B16A, N18 B16C, 5FA (EP6CDT), 5FD (EP6DTS), 5FE (EP6CDT), 5FE (EP6CDTM), 5FF (EP6DTS), 5FG (EP6CDTR), 5FH (EP6C), 5FK (EP6C), 5FK (EP6CB), 5FL (EP6C), 5FM (EP6CDTM), 5FN (EP6CDT), 5FP (EP6), 5FR (EP6DTE), 5FS (EP6C), 5FT (EP6DT), 5FU (EP6CDTX), 5FV (EP6CDT), 5FW (EP6), 5FX (EP6DT), 5FY (EP6DTS), 5GF (EP6FADTX), 5GF (EP6FADTXD), 5GG (EP6FADTX), 5GM (EP6FDTX), 5GN (EP6FDTR), 5GP (EP6FDTR), 5GR (EP6FDTX), 5GT (EP6FDTX), 5GW (EP6FDT), 5GY (EP6FADTXD), 5GY (EP6FDT), 5GY (EP6FDTM), 5GZ (EP6FDT), 8FN (EP3C), 8FP (EP3C), 8FR (EP3C), 8FS (EP3)



54228

187,00€



COFFRET DE CALAGE POUR BMW/MINI 1.2, 1.5, 2.0, 3.0

MARQUES	BMW: 1 SERIES (2015 - 2019), 2 SERIES (DESDE 2014), 3 SERIES (DESDE 2015), 4 SERIES (DESDE 2015), 5 SERIES (DESDE 2017), 6 SERIES (DESDE 2017), 7 SERIES (DESDE 2015), i8 (DESDE 2014), X1 (DESDE 2015), X2 (DESDE 2018), X3 (DESDE 2017), X4 (DESDE 2018) AND Z4 (DESDE 2019); MINI: CLUBMAN (DESDE 2015), HATCH (DESDE 2014), CONVERTIBLE (DESDE 2016) AND COUNTRYMAN (DESDE 2017)
OUTILS OEM	2 358 122 (1), 2 357 904 (2), 2 365 488 (3), 2 288 380 (4), 11 4 120 (5).
CODES MOTEUR	BMW: 1,5 B38 A15A, B38 B15A, B38 K15A ,1,6 B48 B16A, 2,0 B48 A20A, B48 A20B, B48 A20E, B48 B20A, B48 B20B , 3,0 B58 B30A, B58 B30B, B58 B30C MINI: 1,2 B38 A12A , 1,5 B36 A15A, B38 A15A , 2,0 B46 B20A, B48 A20A, B48 A20B



54293

17,50€



SUPPORT DE COMPTEUR DE VILEBREQUIN POUR BMW

MARQUES	BMW 1 SERIES E81/82/87/88: 116D (2008-2012),118D (2007-2012),120D (2007-2014), 123D (2007-2014) BMW 1 SERIES E22: 218D (2011-2014), 220D (2011-2014), 225D (2011-2014) BMW 3 SERIES E90/91/92/93: 316D (2007-2012), 318D (2007-2014),320D (2007-2012), 325D (2010-2012), 330D (2008-2014) BMW 5 SERIES E60/61: 520D (2007-2010) BMW 5 SERIES F10/11: 525D (2010-2013), 530D (2010-2013),530D XDRIVE (2011-2015), 535D (2010-2013), 535D XDRIVE (2011-2015),M550D XDRIVE (2012-2015) BMW 5 SERIES E07: 535D GT (2009-2015) BMW 7 SERIES F01/02/04: 730D (2008-2012), 740D (2009-2012),750D XDRIVE (2012-2015) BMW X1 E84: 18D SDRIVE (2009-2015), 20D SDRIVE (2009-2015), 18D XDRIVE (2009-2015), 20D XDRIVE (2009-2015), 23D XDRIVE (2009-2012) BMW X3 E83: 2.0D (2007-2008), 18D XDRIVE (2008-2010) BMW X5 E70: 3.0D XDRIVE (2010-2013), 40D (2010-2013) BMW X6 E71/71: 30D XDRIVE (2010-2014), 40D XDRIVE (2010-2014)
OUTILS OEM	T10016
CODES MOTEUR	2,0: N47D20C, N47D20D 2,0D: N47, D20A, D20A/KO, D20B, D20B/TO, D20C,D20O0, D20O1, D20U0, D20U1 D20K1 3,0D: N57, D30U0, D30O0, D30O1, D30T0, D20T0,D30A, D30A/O0, D30B , D30B/T1, D30C, D30C/S1,D30A0/O0, D30A0/O1



54398

41,00€

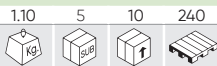

KIT DE BLOCAGE DU VOLANT/DE LA POULIE DU VILEBREQUIN POUR BMW/MINI

MARQUES	MINI HATCH (14-21), CABRIOLET (16-19), CLUBMAN (15-19), COUNTRYMAN (17-19)
OUTILS OEM	11 6 480 (1) 11 9265 (2) 11 4 180 (3) 11 9 810 (4) 11 9 811 (4)
CODES MOTEUR	BMW: 116i (15-19), 116d (15-19), 118d (15-19), 120d (15-19), 125d (15-19), M140i (16-19), 214d (15-19), 216i (18-19), 216d (14-20), 218d (17-19), 218i (15-21), 220d, (14-20), 225d (15-20), M240i (16-19), 316d (15-19), 318i (15-19), 320d (15-19), X1 (15-20),X2 (18-19), X3 (14-18), X4 (17-20), X5 (15-18), i8 (14-18) 325d (16-20),330i (15-20), 340i (15-19), 418i (15-20), 420d (15-20), 425d (16-18), 430i (16-20),440i (16-19), 518d (14-17), 525d (17-20), 530i (17-18), 540i (17-19), 620d (18-20), 630i (17-19), 640i (17-19), 725d (16-19), 730i, (15-19), 740i (15-19)



54399

56,50€

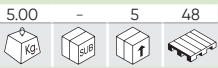

N

KIT DE DISTRIBUTION POUR BMW/ROVER/OPEL 2.5D

MARQUES	BMW: 318TDS (94-00) , 325TD (91-99) , 325TDS (91-99) , 525TD (90-03) , 525TDS (90-03) , 725TDS (95-02) RANGE ROVER: P38 (94-02) VAUXHALL/OPEL: OMEGA-B (94-01)
OUTILS OEM	KM811 (1), 113320 (1), 12112 (1) KM822 (2), 113360 (2), 12115 (2) KM813 (3), 115120 (3), 112300 (3), 12108 (3) KM823 (4), 113340 (4), 12172 (4)
CODES MOTEUR	256T, 25DT, M41/174T1, M51/256T1, M51/256T1L, X25DT

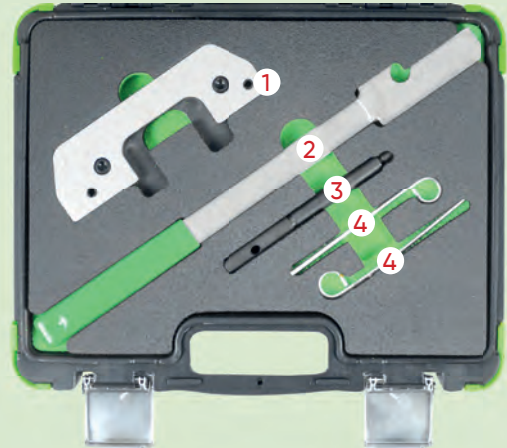

54400

141,00€

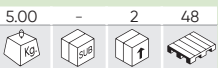

N

KIT DE DISTRIBUTION POUR BMW N20, N26

MARQUES	BMW: 1 SERIES 125I - F20/21 (2012-2016) 2 SERIES COUPE 220I, 228I - F22 (2014-2016) 2 SERIES CABRIOLET 220I 228I - F23 (2015-2016) 3 SERIES 320I 328I XDRIVE - F30/31 (2012-2015) 3 SERIES GRAN TURISMO 320I, 328I/XDRIVE - F34 (2013-2016) X4 XDRIVE 20I, 28I (F26) 2014 - 2018, X5 XDRIVE40E (F15) 2015 - 2018, Z4 SDRIVE18I, 20I, 28I (E89) 2011 - 2017 4 SERIES COUPE 420I, 428I/XDRIVE - F32(2013-2016), 4 SERIES CABRIOLET 420I, 428I/XDRIVE-F33 (2014-2016) 4 SERIES GRAN COUPE 420I, 428I/XDRIVE F36 (2014-2016) 5 SERIES 520I, 528I/XDRIVE(F10/11) 2010 - 2017, 5 SERIES GRAN TURISMO 528I-(F07) 2013 - 2016, X1 SDRIVE16I, 18I, 20I, XDRIVE20I, 28I-(E84) 2011 - 2015, X3 SDRIVE18I, 20I, XDRIVE20I, 28I (F25) 2011 - 2017
OUTILS OEM	11 9 340/341 (1), 11 9 340A (1), 11 9 341 (1), 119340 (1) 2 212 830 (2) 2 212 831 (3) 2 219 548 (4)
CODES MOTEUR	1,6 N20 B16A 2,0 N20 B20 N20 B20A N20 B20A N20 B20B N20 N20B/UO N20 B2000 N20 B2000 N26 B20 B26 B20A

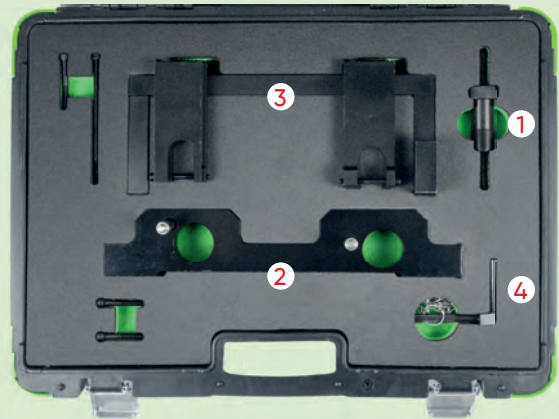

54401

57,00€



N

KIT DE DISTRIBUTION POUR BMW/MINI N13, N18

MARQUES	BMW 114i (2012-2015) BMW 116i (2012-2015) BMW 118i (2011-2015) BMW 316i (2012-2015) MINI CLUBMAN (R55) (2011-2014) MINI COOPER S (R56/57) (2010-2015) MINI COUNTRYMAN (R60) (2012-2016) MINI COUPE COOPER S (R58) (2012-2015) MINI PACEMAN (R61) (2013-2017) MINI ROADSTER (R59) (2012-2015)
OUTILS OEM	11 7 440 (1), 117440 (2), 11 9 340 (3), 11 9 590 (4), 49 6 709 (5)
CODES MOTEUR	N13 B16A N18 B16A N18 B16/MO N18B16A/MO N18B16C N18B16C/TO N18B16MO

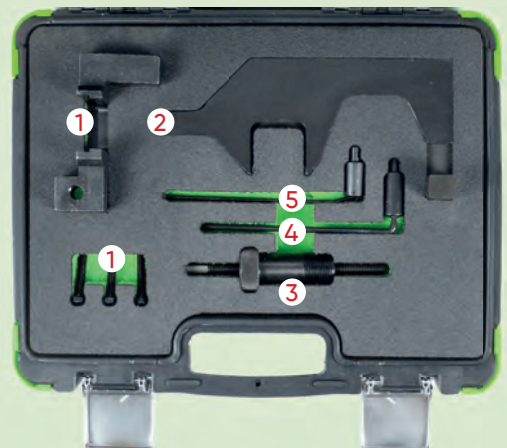

54402

201,00€



N

KIT DE DISTRIBUTION POUR BMW N51, N52, N53, N54, N55

MARQUES	E60: 523i, 523Li, 525i, 525Li, 525Xi, 528i, 528Xi, 530i, 530Li, 530Xi, 535i, 535Xi E61/E63: 523i, 525i, 525Xi, 530i, 530Xi, 535Xi, 630i E64/E65: 630i, 730i E66/E70: 730Li, X5 3.0Si E81/E82: 130i, 135is E83: X3 2.5i, 2.5Si, 3.0i, 3.0Si E85/E86: Z4 2.5i, 2.5Si, 3.0i, 3.0Si, Z4 3.0Si E87/E90: 130i, 323i, 325i, 325Xi, 328i, 328Xi, 330i, 330Xi, 335i, 335Xi E91: 323i, 325i, 325Xi, 328i, 328Xi, 330i, 330Xi, 335i, 335Xi E92: 323i, 325i, 325Xi, 328i, 328Xi, 330i, 330Xi, 335i E93: 325i, 328i, 330i, 335i
OUTILS OEM	110300 (1) 114280 (2) 114285 (3) 114290 (4) 114390 (5) 118520 (6) 119190 (7) 119340 (8)
CODES MOTEUR	N51/N52/N53/N54/N55

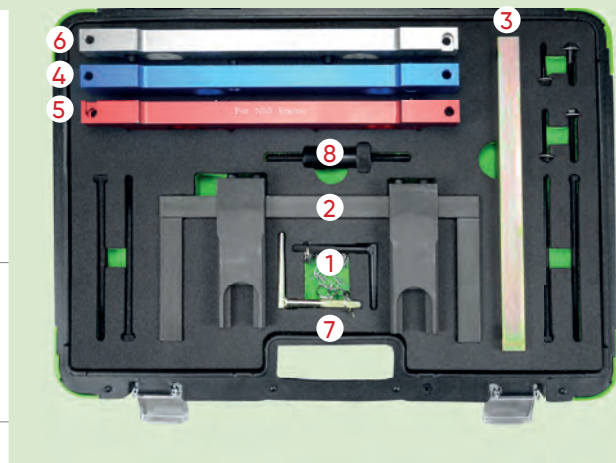

54403

225,00€



N

KIT DE DISTRIBUTION POUR BMW M60

MARQUES	BMW 5 SERIES: 530i, 540i (E34) (1992 – 1996), 535i, 540i (E39) (1996 – 2003) BMW 7 SERIES: 730i, 735i, 740i (E38) (1994 – 2002), 730i, 740i (E32) (1992 – 1994) BMW 8 SERIES: 840i (E31) (1993 – 1999) LAND ROVER/RANGE ROVER: (L322) (2002 – 2005) X5: 4.4, 4.6 (E53) (1999 – 2004)
OUTILS OEM	11 2 445 (1), 11 2 441/445 (1), LRT -12 223/2 (1) 11 2 441 (2), 12 223/1 (2), LRT 12-223/1 (2) 11 2 442 (3), 11 2 442/446 (3), 12 223/3 (3), LRT 12 223/3 (3) 11 2 446 (4), 12 223/4 (4), LRT 12 223/4 (4), LRT 12 224 (4) 11 3 390 (5), 113390/117380 (5), 12 222 (5), LRT 12 222 (5) 11 5 180 (6), 12 227 (6), LRT 12 227 (6) 11 2 300 (7), 11 5 120 (7), 12 108 (7), 12 171 (7), KM 813 (7), LRT 12 108 (7), LRT 12 171 (7) 11 6 420 (8), 12 226 (8), LRT 12 226 (8) 11 6 452 (9), 12 228/1 (9), LRT 12 228/1 (9) 11 6 451 (10), 12 228/2 (10), LRT 12 228/2 (10) 11 3 310 (11), 12 220 (11), LRT 12 220 (11) 11 6 440 (12), 12 224 (12), LRT 12 2214 (12) 11 7 380 (13), 12 221 (13), LRT 12 221 (13)
CODES MOTEUR	BMW 3.0: 30 8S 1 BMW 3.5: 35 8S 1, 35 8S 2 BMW 4.0: 40 8S 1 BMW 4.4: 44 8S 1, 44 8S 2 BMW 4.6: 46 8S 1 RANGE ROVER: V8/44 8S 2



54404

131,00€



N

KIT DE DISTRIBUTION POUR BMW N62, N73

MARQUES	SERIES 5, SERIES 6, SERIES 7, X5
OUTILS OEM	119461 (1), 119462 (2), 119463 (3), 119190 (4), 119340 (5), 119451 (6), 119452 (7), 119453 (8), 119454 (9), 113460 (10), B117207 (11)
CODES MOTEUR	N62 B36A, N62 B40A, N62 B44A, N62 B48A, N62 B48B, N73 B60A

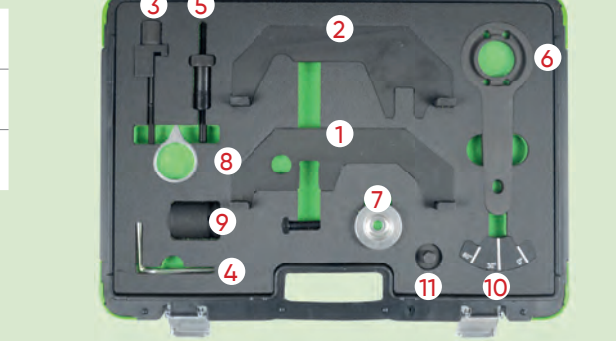

54405

111,00€



N

KIT DE DISTRIBUTION POUR BMW N63, N74

MARQUES	SERIES 5, SERIES 6, SERIES 7, X5, X6
OUTILS OEM	11 9 891 (1) 11 9 892 (1) 11 9 893 (2) 11 9 190 (3) 11 8 090 (4)
CODES MOTEUR	N63, N74

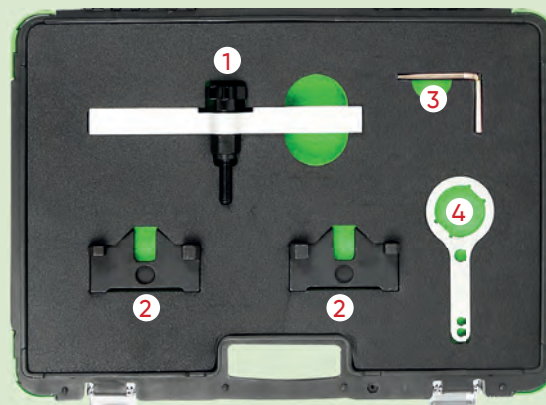

54406

73,00€



N

BLOQUEUR DE VOLANT MOTEUR BMW/MINI

MARQUES	<p>BMW 1 SERIES: F20/21 (12-15), 116i (04-12), 118i (04-14), 120i (04-14), 130i (05-07), 135i (07-11), 116D (08-12), 118D (04-14), 120D (04-14), 123D (07-14), M COUPE (11-12)</p> <p>BMW 3 SERIES: F30/31 (12-15), 316Ti (04-14), 316i (04-11), 316D (09-12), 318i (04-07), 318Ti/COMPACT (04-04)</p> <p>BMW 3 SERIES: 318D (03-12), 318TD (03-07), 320D (01-07), 320D COMPACT (01-05), 318i (05-13), 320D (07-14), 320i (05-14), (05-14), 320Si(05-06)</p> <p>BMW 3 SERIES: 323i (05-11), 325i (05-14), 325D (06-10), 330D (05-08), 330i (06-13), 335D (05-13), 335i (05-11)</p> <p>BMW 4 SERIES: 420i F32 (13-15), 428i F32 (13-15), 420i F33 CABRIOLET (14-15), 428i F33 CABRIOLET (14-15), 420i F36 (14-15), 428i F36 GRAN COUPE (14-15)</p> <p>BMW 5 SERIES: F10/11 (10-15), 520D (05-10), 520i (07-10) 523i (03-10), 525D (05-10), 525i (05-10), 525i (07-10), 530D (03-10), 530i (05-10), 535D (04-10)</p> <p>BMW 6 SERIES: 630i (04-11), 635D (07-11)</p> <p>BMW 7 SERIES: 730D (05-08), 730i (02-08) BMW X SERIES: X1 E84 (09-15), X3 E83 (03-14), X5 E53 (03-14), X3 F25 (11-15), X6 E71/72 (08-10)</p> <p>BMW Z SERIES: Z4 E85/86 (04-09), Z4 (E89) (11-15)</p> <p>MINI: MINI (03-06)</p>
OUTILS OEM	11 8 180 (1), 11 8 181 (2), 11 8 182 (3), 11 8 183 (4), 11 8 184 (5), 11 8 185 (6)
CODES MOTEUR	<p>BMW: M47T2, M57T2, M67, N43, N45, N45T, N46, N46T, N47, N51, N52, N53, N54</p> <p>MINI: W17 DIESEL</p>



54324

11,00€



N

INDICATEUR D'USURE DE LA CHAÎNE DE DISTRIBUTION MINI

MARQUES	MINI: CLUBMAN (2007-2014), CLUBVAN (2012-2014), COUNTRYMAN (2010-2017), COUPÉ (2011-2015), MINI (2006-2015), PACEMAN (2013-2017), ROADSTAR (2012-2015)
OUTILS OEM	2353281 (1)
CODES MOTEUR	<p>1,4: N12 B14AB, N12 B14</p> <p>1,6: N12 B16A, N16 B16A, N16 B16M0, N16 B16U0, N16 B16A/MO, N16 B16KO, N16 B16A/MO, N18 B16A, N18 B16A/MO, N18 B16C, N18 B16A/MO, N18, N18 B16M0, N18 B16C/T0</p>



53268

92,00€



COFFRET DE CALAGE POUR BMW/MINI/PSA 1.4, 1.6

MARQUES	BMW/MINI: MINI CLUBVAN R55 (12-14), MINI CLUBMAN R55 (08-14), MINI COUNTRYMAN R55 (07-10), MINI CLUBMAN R56/R57 (07-15), MINI R56/R57 (08-15), MINI COUPE R58 (11-15), MINI ROADSTER R59 (08-15), MINI CLUBMAN R60 (10-14), MINI CLUBVAN R60 (12-14), MINI ROADSTER R61 (13-15), MINI PACEMAN R61 (14-15), MINI COUNTRYMAN R60 (10-17). CITROËN: C4 (08-11), C4 PICASSO (08-13) C4 GRAND PICASSO (13-15). PEUGEOT: 207 (06-14), 207CC (07-15), 308 (07-15), 3008 (09-15), 5008 (09-15).
OUTILS OEM	BMW/MINI: 115590 (1), 119340 (2), 119551 (3) CITROËN: 0197-A1, 0197-A3, 0197-B. PEUGEOT: 0197-A1, 0197-A3, 0197-BZ.
CODES MOTEUR	1.4: N12B14, N14B14AB. 1.6: EP3(8FS), EP3C(8FR), EP6(5FW), EP6C(5FS), EP6CDT(5FV), EP6DT(5FT), EP6DT(5FX), EP6DTS(5FY), N14B16A, N14B16CD, N14B16TO, N14B16CD/TO, N16B16A, N16B16KO, N16B16A/MO, N16B16A/MO, N16B16M0, N16B16U0.



53313

139,00€



COFFRET DECALAGE POUR CITROEN/PEUGEOT

MARQUES	CITROËN: AX, BX, BOXER, BERLINGO, C25, DISPATCH, EVASION, J5, JUMPY, JUMPER, RELAY, SAXO, SYNERGIE, VISA, XM, XSARA, XANTIA, XZ, ZX. PEUGEOT: 106, 205, 206, 305, 306, 307, 309, 405, 406, 605, 607, 806, EXPERT, PARTNER, SOLARA, TALBOT.
OUTILS OEM	7099TM (1), 0188X (2), 0188P (3), 0189AZ (4), 0188H (5), 0132AJ1 (6), 0189A (7), 0188PM (8), 21-260 (9), 4527-TS1 (10), M8X70 (11), 0188K (12), 0188J (13), 0132Q (14), 4507-TL (15), 4507-TJ (16), 9044-T (17), 4507-TJ (18), 5711-TA (19), 7014-TJ (20), 7017-TR (21), 0188X (22), 7017-TW (23), 7014-TM (24), 0189L (25)

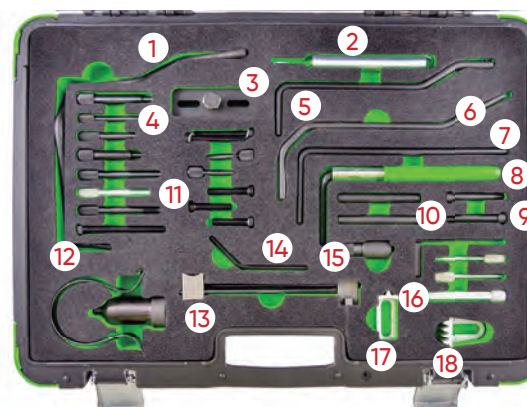

53314

98,00€



COFFRET DE CALAGE POUR CITROEN/PEUGEOT 1.8, 2.0

MARQUES	CITROËN: C4 PICASSO/GRAND PICASSO (06-10). C5 II (04-08), C8 (05-10), DISPATCH/JUMPY (07-11), XSARA 2.0 16V, C5 1.8/2.0/HPI, XSARA PICASSO 1.8/2.0 16V (02-05). PEUGEOT: 406 1.8 16V (00-04), 407 (06-10), 807 2.0 16V (02-05).
OUTILS OEM	0189S2 (1), 0188J (2), 0188J2 (2), 0189S1 (3), 21-260 (4), 0189B (5), 0188M (6), 0188AH (7), 0189R (8)
CODES MOTEUR	1.8 16V: EW7A(6FY). 2.0 16V: EW10A(RFJ), EW10ABE4(RFH), EW10J4S (RFK).

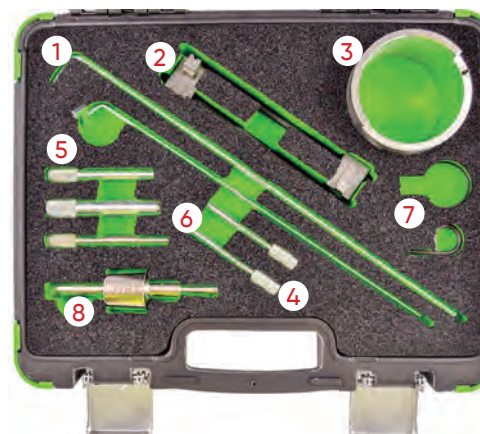

53876

64,00€

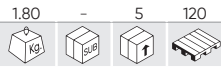

COFFRET DE CALAGE POUR CITROËN/PEUGEOT 1.0, 1.2 VTI

MARQUES	CITROËN: C3 (III) PEUGEOT: 208, 308, 2008 SUV (2012-2014)
OUTILS OEM	0109-2A (1) 0109-2B (2)
CODES MOTEUR	1.0/1.2 VTI. EBO, (ZMZ), EB2, (HMZ)



54288

72,50€

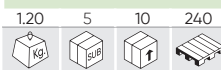

N

COFFRET DE CALAGE PSA 1.2 GDI PURETECH

MARQUES	CITROËN: BERLINGO IV (18-20), C1 II (14-18), C3 III (12-17), C3 IV (16-18), C4 CACTUS (14-20), C4 AIRCROSS (18-20), C-ELYSEE (12-18), DS3 (12-18) PEUGEOT: 108 (14-18), 208 (12-21), 2008 (13-21), 301 (12-20), 308 (13-21), 3008 (16-21), 508 (19-21), 5008 (14-21), PARTNER III (15-18) PARTNER IV (18-21) RIFTER (19-21) TOYOTA: AYGO (14-18) GM: CROSSLAND X (17-20), COMBO E (18-20), GRANDLAND X (17-20)
OUTILS OEM	CITROËN: G-0109-6 (2), 0109-2B (1), 0109-2C (3), 0109-2D (4), 0197-N (1) PEUGEOT: G-0109-6 (2), 0109-2B (1), 0109-2C (1), 0109-2D (4), 0197-N (1) VAUXHALL: EN-52127-2 (1), EN-52809 (2)
CODES MOTEUR	1.2 VTI: 1PP(HM01), EB2 (HMZ), EB2DTS(HNY), EB2 (HMW), EB2M (HMY), EB2 (HMZ), EB-2DTS(HNY), HMP (EB2FB), HMT(EB2D), HMU(EB2D),HMV (EB2M), HMY (EB2M), HMZ (EB2), HMZ (EB2D), HMZ (EB2F),HMZ (EB2FB) 1.2 E-VTI: HMZ (EB2F), EB2F (HMZ) 1.2 PURETECH THP: HNZ (EB2DT) 1.2 PURETECH VTI: EB2ADS (HNS), EB2D(HMT), EB2ADJ (HNP),EB2ADT (HNK), EB2ADTX (HNN), EB2DTS (HNW), EB2DTM (HNW),EB2DTSM (HNW), EB2FA (HMR), EB2FAD (HMH), EB-2FAD (HMM),EB2DT (HNZ), EB2F (HMX), EB2F (HMT), EB2F(HMZ), EB2DTS(HNY),EB2M(HMY)



REF. DESCRIPTION

16400 CALIBRE DE CONTRÔLE DE DISTRIBUTION - POUR PSA(REF.54288)

0.03 10 500 6,50€

54323

119,00€



N

COFFRET DE CALAGE POUR PSA 1.0, 1.2 VTI, 1.2 GDI PURETECH

MARQUES	CITROËN: C1 II (2014-2018), C3 III (2012-2017), C3 IV (2016-2018), C4 CACTUS (2014-2020), C4 AIRCROSS (2018-2020), C-ELYSEE (2012-2018), DS3 (2012-2018), BERLINGO IV (2018-2020), GM: CROSSLAND X (2017-2020), COMBO E (2018-2020), GRANDLAND X (2017-2020) PEUGEOT: 108 (2014-2018), 208 (2012-2021), 2008 (2013-2021), 301 (2012-2020), 308 (2013-2021), 3008 (2016-2021), 508 (2019-2021), 5008 (2014-2021), PARTNER III (2015-2018), PARTNER IV (2018-2021), RIFTER (2019-2021) TOYOTA: AYGO (2014-2018).
OUTILS OEM	EN-52127-2 (1), 0109-2B (1) J-0109-2C (2) J-0109-2D (3) EN-52127-1 (4), 0109-2A21 (4) G-0109-6 (5)
CODES MOTEUR	B12XHL (EB2DT), B12XHT (EB2DTS), D12XHL (EB2ADT), D12XHL (HNP/EB2ADT), D12X-HT (EB2ADTS), EBO (ZMZ), EBOF (ZMZ), EB2ADT (HNK), EB2ADT (HNP), EB2ADTD (HNK), EB2ADTS (HNS), EB2ADTX (HNN), EB2DT (HNZ), EB2DTM (HNW), EB2DTS (HNW), EB2DTS (HNY), EB2DTSM (HNW), EB2FA, EB2FAD, F12XHT (EB2ADTS), F12XHT (HNS/EB2ADTS), HMM (EB2FAD), HMM (EB2FAD), HMP (EB2FB), HMR (EB2FA), HMT (EB2), HMT (EB2F), HMU (EB2D), HMU (EB2FD), HMV (EB2M), HMW (EB2), HMX (EB2F), HMY (EB2M), HMZ (EB2), HMZ (EB2F), HNJ (EB2ADTXM), HNK (EB2ADT), HNK (EB2ADTD), HNK/EB2ADTD, HNL (EB2ADTSM), HNN (EB2ADTX), HNP (EB2ADT), HNS (EB2ADTS), HNS/EB2ADTS, HNT (EB2ADTS), HNV (EB2DT), HNV (EB2DTM), HNW (EB2DTS), HNW (EB2DTSM), HNX (EB2DT), HNX (EB2DTS), HNY (EB2DTS), HNZ (EB2DT), HN02, ZMZ (EBO), ZMZ (EBOF), 1PP (HM01)

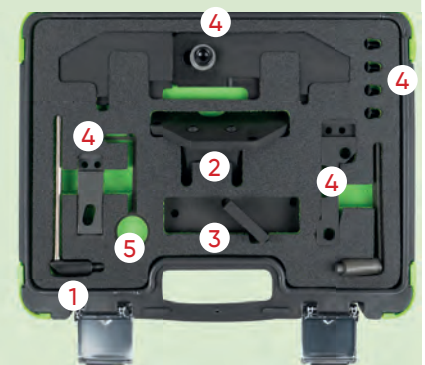

54213

19,80€

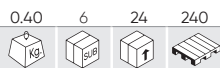

COFFRET DE CALAGE POUR ROVER/PEUGEOT/FORD/VOLVO 2.0, 2.2L D

MARQUES	PEUGEOT: 807 (05-11), 407 (05-11), 607 (05-09).CITROËN: C4 (04-10), C5 II (04-10). LAND ROVER: FREELANDER (06-10). VOLVO: S40 (03-10), V50 (06-10), C70 (06-10), S80 (07-10), C30 906-10), V70 (07-10).FORD: S MAX 2.2 (08-10), GALAXY 2.2 (08-10), MONDEO 2.2, 2.0 (07-10).
OUTILS OEM	PSA 0188.M, FORD 303-735, 303-1277, VOLVO 999-7122 (1) PSA 0188.X, FORD 303-1059, 303-1270, VOLVO 999-7121 (2) PSA 0188.F, FORD 303-393A, 303-393-01, 303-1272, VOLVO 999-7119/7120 (3)
CODES MOTEUR	PEUGEOT: DW10UTED4 (RHK), DW10BTED4 (RHR)DW12B-TED4 (4HS), (4HP), (4HT), (4HR). CITROËN: DW10BTED4 (RHR). LAND ROVER:DW12BTED4, 224DT. VOLVO:D420T 2.0D. FORD: QXBA(2.2), QXWA(2.0), QXBB(2.0),Q4BA(2.2), QXWA(2.0), QXWB(2.0), AZBA(2.0), AZBC(2.0), AZWA(2.0)

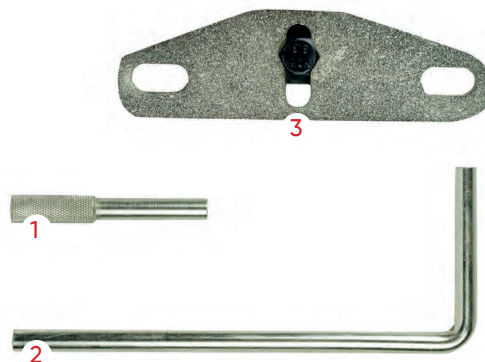

54432

43,00€



KIT DE DISTRIBUTION POUR PSA 2.7, 3.0 HDI

MARQUES	CITROËN C6 JAGUAR S-TYPE (X200) 2004 - 2008, XF S (X250) 2008 - 2015, XF S (X260) 2015 - 2020, XJ6 TDV1 (X350/358) 2005 - 2010, XJ (X351) 2010 - 2020, F-PACE S 30D (X761) 2016 - 2020 LAND ROVER: DISCOVERY 3 TDV6 (L319) 2004 - 2009, DISCOVERY 4/DISCOVERY SDV6, TDV6 (L319) 2009 - 2017, DISCOVERY SD6, TD6 (L462) 2017 - 2021, RANGE ROVER SDV6, SDV6 HYBRID, TDV6 (L405) 2012 - 2021, RANGE ROVER SPORT SDV6, TDV6 (L320) 2005 - 2013 PEUGEOT 407, 607 COUPE RANGE ROVER VELAR D275, D300 (L560) 2017 - 2021, RANGE ROVER SPORT SDV6, SDV6 HYBRID, TDV6 (L494) 2013 - 2021
OUTILS OEM	303 11117 (1), 303 11116 (2), 303 1132 (3), 303 1126 (4), 0195H (4), 0195C (5), 0195K (6), 0188-K (7)
CODES MOTEUR	2.7: DT17 TED4 (UHZ), DT17BTED4 (UHZ) 3.0: DT20C (X8C/X8Z), DT20CTED4 (X8Z)

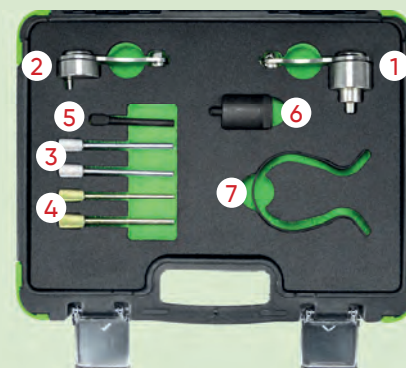

54433

18,00€



KIT DE DISTRIBUTION POUR PSA 1.0, 1.1, 1.2, 1.4, 1.6, 2.0

MARQUES	CITROËN BERLINGO 2008 - 2011, C2 2003 - 2010, C-ELYSEE 2012 - 2016, C3 PLURIEL 2003 - 2010, C4 2004 - 2011, NEMO 2008 - 2015, XSARA 2000 - 2005 PEUGEOT 106 1998 - 2003, 206 1998 - 2009, 207 2006 - 2013, 306 1998 - 2003, 307 2000 - 2008, 1007 2005 - 2010, PARTNER 1998 - 2011, BIPPER 2008 - 2015
OUTILS OEM	0132QY (1), 4507 TA (1), 0132AK (2), 0153AK (2), 0188K (2), 0189K (2), 1870 900 100 (2), 4533 TAD (2), MOT 1436 (2) 3MM PIN (3), 0132AB (4), 0178D (4), 0194A (4), 77440010400 (4), 1860.617000 (4), 11 9 790 (4), 21-260 (4), 303-732 (4), 4527 TS2 (4), 49 JEO2 018 (4), 5711 TD (4), 99360608 (4), 999 7169 (4), KM-6349 (4), 0132AJ1 (5), 0187B (5), 0189B (5), 0194B (5), 09919 58120 (5), 21 263 (5), 303 735 (5), 3031277 (5), 49 JEO2 021 (5), 607589011500 (5), 8MM DRILL BIT (5), 8MM PIN (5), 999 7122 (5), EN-52137 (5), MOT. 1430 (5), MOT 1430 (5), 0123-RZ (6), 0132R (6), 0153AA (6), 0153AB (6), 0153G (6), 0153ZY (6), 10MM PIN (6), 4507 TB (6), 7014 TN, 9767 27 (6), M10 X 70MM (6), 0132Q (7), 0132QZ (7), 132Z (7), 4507 TA (7)
CODES MOTEUR	1.0: TU9 (C1A), TU9/K (C1A), TU9M (CDY/CDZ), TU9MZ (CDY/CDZ), TU9M/L (CDZ), TU9M/L3 (CDY) 1.1: TU1A (HFV/HFX), TU1JP (HFV/HFY/HFZ), TU1JP/L4 (HFX), TU1/K (H1A), TU1M (HDZ), TU1M/L (HDZ), TU1M/L3 (HDY/HDZ), TU1M/Z (HDZ), TU1M+ (HDY/HDZ) 1.4: ET3J4 (KFU), ET3JP4 (KFU), TU3A (KFT/KFV/KFW), TU3FJ2 (K6B/KFZ), TU3FM (KDY), TU3JP (KFW/KFX/KFX), TU3JP/IFL4 (KFX)TU3JP/L3 (KFX), TU3JP/L4 (KFX), TU3JP/IFL4 (KFX), ET3J4 (KFU), TU3M (KDX), TU3M/Z (KDY) 1.6: EC5 (NFP), EC5F (NFP), TU5J2 (NFY/NFW), TU5J4 (NFU), TU5JP (NFT/NFZ), TU5JP/L3 (NFX), TU5JP/L4 (NFU/NFX), TU5JP4 (NFU), TU5JP4B (NFR), TU5JP4S (NFS), TU5JP4/L3 (NFX), TU5JP4/L4 (NFU/NFX), XU5JP (BFZ) 1.8: XU7JB (LFX), XU7JP (LFW), XU7JP/L3 (LFZ), XU7JP4 (LFY), XU7JP4/L3 (LFY) 2.0: XU10J/C/Z (RFU), (RGX), XU10J2E/V (RGX), XU10J2U (RFL), XU10J4R (RFR/RFV), XU10J4R/L3 (RFV), XU10J4RS/L3 (RFS)

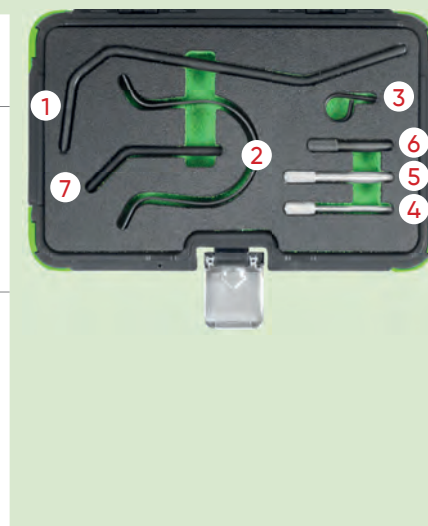

53293

134,00€

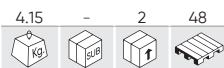

COFFRET DE CALAGE POUR FORD

MARQUES	B-MAX (12-17), C-MAX (07-17), COUGAR (98-01), COURIER (00-02), ESCORT (94-98), FIESTA (95-17), FOCUS (98-17), FOCUS C-MAX (03-07), FUSION (02-12), GALAXY (06-15), GRAND C-MAX (10-17), KUGA (08-15), MAVERICK (01-07), MONDEO (93-15), ORION (94-94), PUMA (97-02), S-MAX (06-15), TOURNEO CONNECT (02-15), TRANSIT (06-11), TRANSIT CONNECT (02-16), ECOSPORT (13-15), TOURNEO COURIER (14-15), GRAND TOURNEO COURIER (13-15).
OUTILS OEM	303-376 (21-162B) (1), 303-1059 (2), 303-193 (21-104) (3), 303-393-01 (4), 303-1054 (5), 303-1097 (6), 303-748 (7), 303-734 (21-262) (8), 303-651 (21-229) (9), 303-393A (21-168) / 303-393-02 / 303-507 (21-210) / 303-620 (21-163)/ 303-732 (21-260) / 303-735 (21-263).
CODES MOTEUR	PETROL: AODA/B, ASDA, ASDB, CFBA, CGBA/B, CHBA/B, CJBA/B, CSDA/B, DHA, DHB, DHC, DHD, DHE, DHF, DHG, EDBB, EDBD, EDDB, EDDC, EDDD, EDDF, EYDB, EYDC, EYDD, EYDE, EYDF, EYDG, EYDI, EYDJ, EYPA, EYPC, F8JA, F8JB, FHA, FHD, FHE, FHF, FUJA, FUJB, FXDA/C, FXDB/D, FXJA, FXJB, FYDA/C, FYDB/D, FYJA, FYJB, HWDA, HWDB, L1F, L1J, L1L, L1N, L1Q, L1T, L1V, L1W, M7JA, M7JB, MHA, MHB, NGA, NGB, NGC, NGD, QQDA/B/C, QQDB, RKA, RKB, RKF, RKH, RKJ, RKK, HXDA. GASOIL: F6JA, F6JB, F6JC, HHJA, HHJB, G8DA, HHDA, HHDB, RTN, RTQ, RTP, C9DC, BHDA/B, BHPA, C9DA/B, F9DA/B, FFBA, FFDA, HCPA, HCPB, KKDA, P7PA, P9PA, QYWA, R2PA, R3PA, RWPA, G6DA, G6DB, G6DC, AZWA, QXWA.

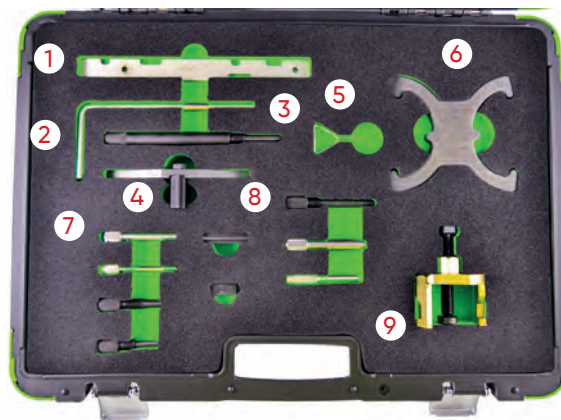

53294

119,00€



COFFRET DE CALAGE POUR FORD MAZDA

MARQUES	FORD: COURIER (00-02), C-MAX (03-10), FIESTA (02-11), FOCUS (98-11), FUSION (02-11), GALAXY (06-10), KUGA (06-10), MONDEO (07-10), S-MAX (06-10), TOURNEO CONNECT (02-13), TRANSIT CONNECT (02-13) PEUGEOT: BIPPER (08-10) DISPATCH/JUMPY III (07-12) EXPERT III (07-12) NEMO (08-10) PARTNER I/II (05-11) PARTNER III (08-16) 107 (05-10) 1007 (05-10) 206 (01-12) 206+ (09-13) 206 CC (05-07) 207 (06-13) 207 CC (07-15) 208 (11-15) 307 (01-08) 308 (07-15) 308 CC (09-15) 407 (05-11) 508 (04-15) 2008 (13-15) 3008 (09-15) 4008 (12-15) 5008 (09-15). MAZDA: 2 (02-15), 3 (09-14) CITROËN: C1 (05-10), C2 (03-10), C3 I/II (02-10), C3 III (10-15), C3 PLURIEL (04-10), C3 PICASSO (09-12), C4 (04-11), C4 II (11-15), C4 PICASSO (06-12), C4 GRAND PICASSO (10-12), DS3 (09-12), DS4 (11-12), DS5 (12-15), C5 II (04-08), C5 III (04-12), XSARA II (02-04), XSARA PICASSO (04-10)
OUTILS OEM	FORD: 303-376B (1), 303-193 (2), 303-393 (3), 303-732 (4), 303-651 (5), 303-393/01, 303-1059, 303-734, 303-735, MAZDA: 303-732, 303-734, 303-735. PSA: 0194-A, 0194-C, 0194B.
CODES MOTEUR	1.4D TDCi/Hdi: DV4TD(8HT), DV4TD(8HX), DV4TD(8HZ), DV4TD(8HW), DV4TED4(8HX), DV4TED4(8HV), DV4TED4(8HY), DV4C(8HP), DV4C(8HR), DV4TED(8HS), F6JA, F6JB, F6JC. 1.6D TDCi/HDi: DV6TED4(9HZ), DV6ATED4(9HX), DV6TED4(9HY), DV6DTE4(9HP), DV6C(9HR), DV6CATED(9HX), DV6C(9HL), DV6TED(9HP), DV6ATED(9HY), DV6TED4(9HV), DV6TED4(9HX), DV6C(9HD), DV6C(BHX), DV6C(BHZ), DV6(9HR), DV6BTED4(9HW), DV6DTED(9HJ), DV6ETED(9HN), DV6ATED4BU(9HS), DV6BTED4(9HT), DV6BUTED4(9HT), DV6TED4B(9HV), DV6UTED4(9HX), DV6TED(9HD), DV6UTED4(9HU), DV6D(9HP), DV6TED4(9HV), DV6C (9HD), DV6TED4(9HW), DV6AT(9HX), DV6ATED(9HX), DV6CTED(9HC), DV6AUTED4(9HX), DV6TED4B, DV6DTE4(9HF), HHJA, HHJB, G8DA, G8DB, HHDA, HHDB, MZ-CD, Y6. 1.8D TDCi/HDi: BHPA, C9DA/B, FFBA, G6DA, G6DB, G6DC, HCPA, HCPB, KKDA, P7PA, P9PA, R2PA, R3PA, RWPA. 1.8d: C9DC, RTN, RTQ. 1.8D Td: C9DA/B, C9DC. 2.0D TDCi/HDi: AZWA, G6DA, G6DB, G6DC, RHE(DW10CTED4), QXWA, QXWB.

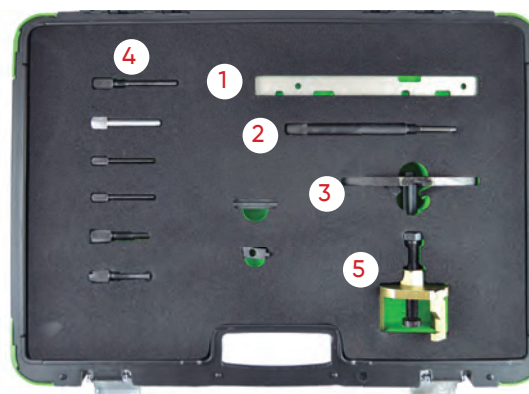

53318

24,00€



EXTRACTEUR DE PIGNON POUR ARBRE À CAME FORD

MARQUES	FORD
OUTILS OEM	F8M, F8Q, S8U, S9U.



53295

77,00€

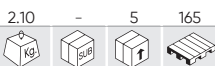

COFFRET DE CALAGE POUR FORD 1,8TDDI, TDCI

MARQUES	C-MAX (07-10), COURIER (00-02), FIESTA (00-02), FOCUS (98-11), FOCUS C-MAX (03-07), GALAXY (06-10), MONDEO (07-10), S-MAX (06-14), TOURNEO CONNECT (02-13), TRANSIT CONNECT (02-13).
OUTILS OEM	303-193 (21-104) (1), 303-393 (21-168) (2), 303-376 (21-162B) (3), 303-652 (21-230) (4), 310-095 (23-067) (5)
CODES MOTEUR	1.8D TDCI: BHPA, F9DA, F9DB, FFBA, FFDA, FFWA, HCPA, HCPB, KHBA, KKDA, KKDB, P7PA, P9PA, P9PB, QYBA, QYWA, R2PA, R3PA, RWPA, RWPC. 1.8D TDCI ECONETIC: KHBA. 1.8D TDI: BHDA, BHDB, BHPA, C9DA, C9DB, C9DC. 1.8D TURBO: C9DC, RTN, RTP, RTQ.



53296

60,00€

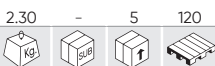

KIT DISTRIBUTION POUR POMPE INJECTION DE FORD/JAGUAR DURATORQ

MARQUES	FORD: MONDEO (00-07), TRANSIT (00-14). CITROËN: RELAY, JUMPER III (06-13). FIAT: DUCATO (06-11).	JAGUAR: X-TYPE (03-10). PEUGEOT: BOXER III (06-12). LAND ROVER: DEFENDER TD4 (06-11). LDV: CONVOY (02-06).
OUTILS OEM	303-1151 (1), 303-679A/21-238 (2), 303-732 (3), 303-675/21-234 (4), 303-698/21-251 (5)	
CODES MOTEUR	1.2D DI/TDDI/TDCI: ABFA, D3FA, F3FA, D5BA, D6BA, F1FA, FMBA, FMBB, HJBA, HJBB, HJBC, HJBE, N7BA, N7BB. 2.2D TDCI/ECONETIC: BG, CYFA, CYFB, CYFC, DRFA, DRFB, DRFC, P8FA, P8FB, PGFA, PGFB, QJBA, QJBA (BG), QJBB, QJBC, QJBD, QVFA, QWFA, SRFA, SRFB, SRFC, SRFD, SRFE, UHFA. 2.2D HDI/JTD: P22DTE (4HM), P22DTE (4HU), P22DTE (4HV). 2.4D DI/TDCI: DOFA, D2FA, D2FB, D4FA, F4FA, FXFA, H9FA, H9FB, H9FD, JXFA, JXFC, PHFA, PHFC. 2.4D TD/TDI: ZSD 424. 2.4D TD4: 244DT.	

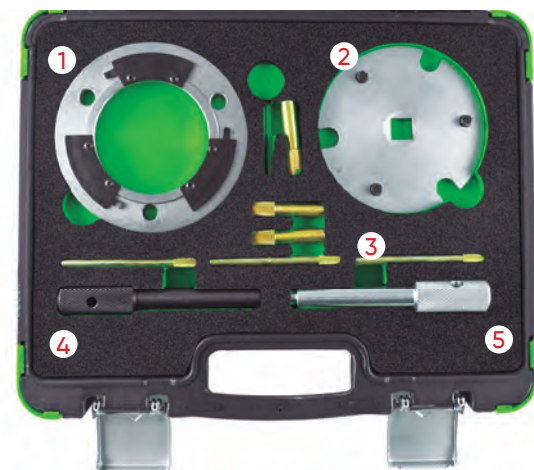

54419

57,00€

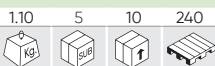

EXTRACTEUR / BAGUE DE POSE DE JOINT AVANT DE VILEBREQUIN FORD DURATORQ 2.0, 2.2, 2.4, 3.2

MARQUES	FORD MONDEO 2000 - 2007 RANGER 2011 - ON TRANSIT 2000 - 2006 TRANSIT 2006 - 2014 TRANSIT 2014 - 2019 TRANSIT/TOURNEO CUSTOM 2012 - 2016
OUTILS OEM	21 238 (1), 303-679A (1), 303-682 (2)
CODES MOTEUR	2.0 Di ABFA D3FA F3FA 2.0 TDCI FMBA FMBB HJBA HJBB HJBC N7BA N7BB SDBA F1FA 2.0 TDDi D5BA D6BA 2.2 TDCI QJBA QJBB QJBC QJBD GBVAJQF GBVAJQJ GBVAJQW CVRA CVRB CYFA CYFB CYFC CYRA CYRB DRFA DRFB DRFC DRFE DRRB DRRB P8FA P8FB PGFA PGFB QVFA QWFA SRFA SRFB SRFC SRFD SRFE UHFA UHFB 2.4 Di D2FA D2FB D4FA DOFA F4FA FXFA 2.4 TDCi H9FA H9FB H9FD JXFA JXFC 3.2 TDCi SAFA SA2R SA2S SA2W SAFA SAFB



54420

102,00€



N

KIT DE RÉGLAGE DU CARBURANT - FORD / VOLVO 2.5 (EURO 4)

MARQUES	FORD: FOCUS 2.5 RS / ST, MONDEO 2.5, S-MAX 2.5, GALAXY 2.5 ST (2005-) VOLVO: C30 (06-10), C70 (98-10), S40 (96-10), S60 (00-09), S70 (97-07), S80 (98-06), V40 (96-10), V50 (04-10), V70 (97-07), XC70 (02-07), XC90 (02-10)
OUTILS OEM	303-1178 (1), 999 5452 (1), MOT 1337 (1) 303-1182 (2), 999 5451 (2), MOT 1340 (2) 303-1179 (3), 999 5433 (3) 303-1183 (4)
CODES MOTEUR	FORD: 2.5 Turbo (Euro 4), HUBA / HUWA / HYDA / JZDA VOLVO: 1.6 (B4164S), 1.8 (B4184S), 1.9T (B4194T), 2.0 (B4204S / B4204T), 2.0T (B5204T3 / B5204T4 / B5204T5), 2.3 (B5234FS), 2.3T (B5234T3 / B5234T7 / B5234T9) VOLVO: 2.4 (B5244S / B5244S2 / B5244S4 / B5244S5 / B5244S7), 2.4T (B5244T / B5244T3 / B5244T4 / B5244T5 / B5244T7), 2.5R (B5254FS), 2.4D (D5244T9 / D5244T8 / D5244T13)

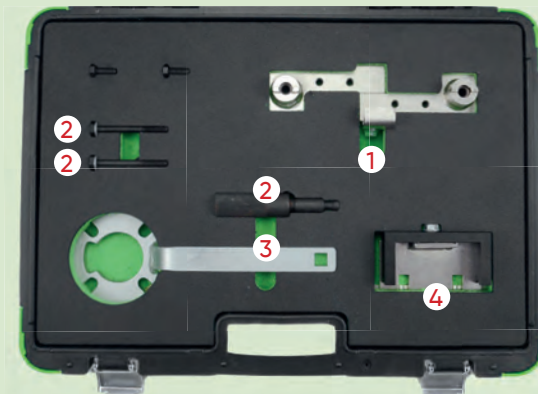

54421

52,00€



N

OUTIL DE POSE DE COURROIE AUXILIAIRE FORD/VOLVO 1.4 / 1.6

MARQUES	FORD 1.4, 1.6 (FOCUS, C-MAX, MONDEO) VOLVO 1.6 (S40, C30, V50)
OUTILS OEM	303-1179
CODES MOTEUR	B4164S3, FUJA, FXJA, FYJA C12HM7AD, C12LM7AA, ZH12FUJA, ZH12FUJB, ZH12M7JB C14HDEZ, C14HHADB, ZH14ASDA, ZH14FXDA, ZH14FXDB, ZH-14FXDC, ZH14FXDD, ZH14FXJA, ZH14FXJB 16HDEZ, CH16HDEZ, C16HHDEY, ZH16FYDA, ZH16FYDB, ZH16FY-DC, ZH16FYDD, ZH16FYDH, ZH16FYJA, ZH16FYJB, ZH16HWDA, ZH16HXDA



54424

64,50€



N

KIT DE DISTRIBUTION POUR FORD 2.0 ECOBOOST

MARQUES	FOCUS, GALAXY, MONDEO, S-MAX
OUTILS OEM	303-1504 (1) 303-1600 (2), 300-1565 (2) 303-1521 (3) 303-748 (4) 303-1595 (5) 2MM TENSIONER (6)
CODES MOTEUR	MGDA, R9CB, R9CD, R9CF, R9CH, R9DA, R9DB, R9DC, R9DD, TNBA, TNBB, TNCC, TNCD, TNCF, TNWA, TNWB, TPBA, TPWA, TVDA, XQDA

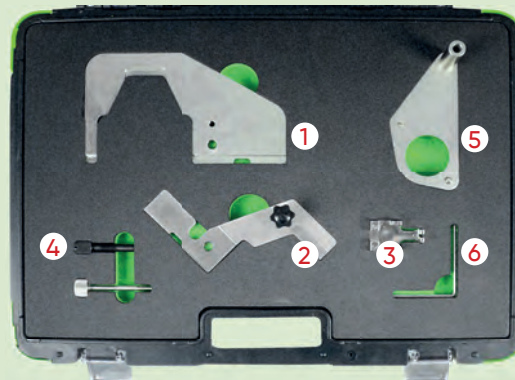

53324

12,50€

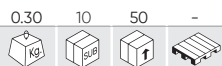

COFFRET DE CALAGE POUR FORD

MARQUES	FORD: B-MAX (15-17), C-MAX (07-10), COUGAR (98-01), FIESTA (95-17), FOCUS (98-11), FOCUS C-MAX (03-07), FUSION (02-12), GALAXY (06-15), MAVERICK (01-07), MONDEO (93-15), PUMA (97-02), S-MAX (06-15), TOURNEO CONNECT (02-06), TRANSIT (06-12), TRANSIT CONNECT (02-06). MAZDA: 121 ZG (95-00), 2 DY (02-07), 3 BK (03-09), 3 BL (09-15), 5 CR (05-10), 5 CW (10-12), 6 GG/GY (02-07), 6 GH (07-15), MPV LW (02-05), MX-5 NC (05-16), TRIBUTE EP (04-06). VOLVO: C30 (06-13), S40 (06-12), S80 (07-11), V50 (04-12).
OUTILS OEM	FORD: 303-1054, 303-507 (21-210), 303-620 (21-163), 303-574, 303-748, 303-376 (21-162B), 303-376B MAZDA: 49 JE01 061, 303-574, 49 JE02 061, 303-465, 49 JE01 054 VOLVO: 999 7152, 999 7151.
CODES MOTEUR	1.4 / 1.6

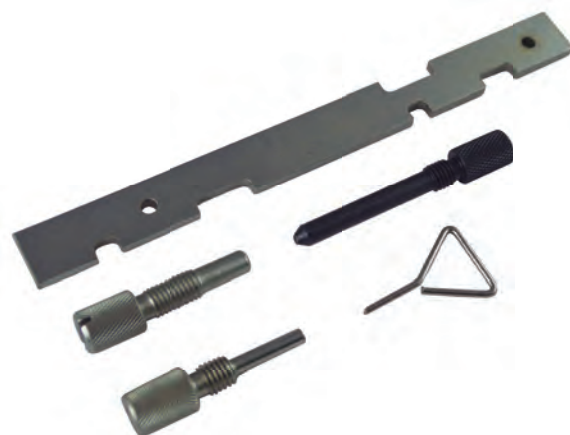

53653

207,00€

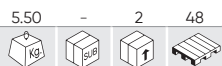

COFFRET DE CALAGE POUR FORD

MARQUES	FORD: FIESTA, FOCUS, B-MAX, ECOSPORT.
OUTILS OEM	303-1605 (1), 303-1606 (2), 303-1604 (3), 303-1602 / 503-393A / (21-168) (4), 303-1054 (5), 303-732 (6)
CODES MOTEUR	M1DD, M1JA, M1JC, M1JE, M1JHM1JJ, M1DA, M2DA, M2DB, M2DC, SFDBSFJA, SFJB, SFJC, SFJD

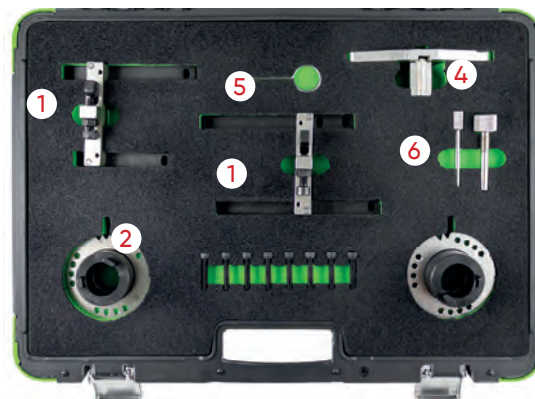

54201

37,60€

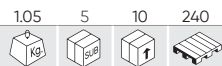

COFFRET DE CALAGE FORD

MARQUES	FORD: C-MAX(07 - 10), C-MAX/GRAND C-MAX(10-18), FIESTA(08-18), FOCUS/FOCUS C-MAX(04-11), FOCUS(11-18), MONDEO(07-15)
OUTILS OEM	303-1097 (1), OEM 303-1054 (2), OEM 303-1059, 303-1270, 0188X, 999-7121 (3), OEM 303-748, 999-7152, 21-259 (4), OEM 303-735, 999 7122, 0187B, 0189B, 0132AJ1, 21-263, 0188M, MOT 1430, 303-1277, 0194B (5)
CODES MOTEUR	11.6 TI-VCT HXDA (2003-2007) ,2.0 TDCI , G6DA, G6DB, G6DC 2003-2007



54204

124,00€

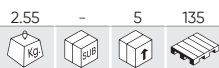

COFFRET DE CALAGE POUR FORD 2.0 ECOBLUE

MARQUES	FORD EDGE, FOCUS, GALAXY, S-MAX (FROM 2018); KUGA, MONDEO, RANGER (DESDE 2019); TRANSIT, TRANSIT CUSTOM AND TOURNEO CUSTOM (DESDE 2016); TODOS CON MOTOR ECOBLUE TDCI ; AWD, FWD Y RWD.
OUTILS OEM	303-1637 (1), 303-1650 (2), 303-1643 (3).
CODES MOTEUR	BCCC,YLCB,YLDA,YLF6,YLFA,YLFB,YLFS,YLR6,YLRA,YMCB,YM-F6,YMFA,YMFB,YMFS,YMHA,YMRA,YNCA,YNF6,YNFA,YNFB,YNFS,Y-NR6,YNRA

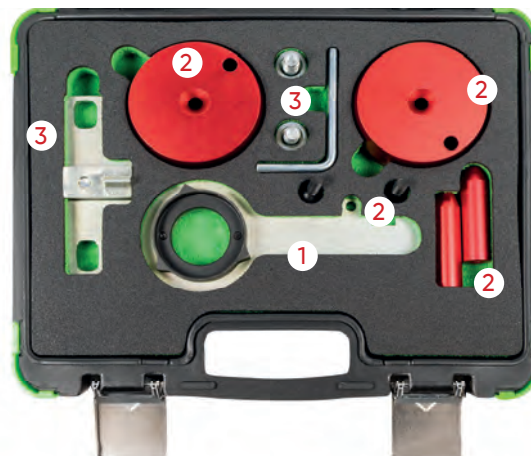

54208

76,00€

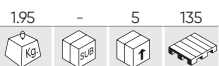

COFFRET DE CALAGE POUR FORD 2.0 ECO BOOST SCTI, TI-VCT

MARQUES	FORD: GALAXY(2010)MONDEO (2010) S MAX (2010) FOCUS(2011)
OUTILS OEM	303-748 (1), 303-1504 (2), 303-1565 (3), 303-1521 (4)
CODES MOTEUR	TNWA, TNWB, TPWA, TNBA, TPBA, MGDA, XQDA

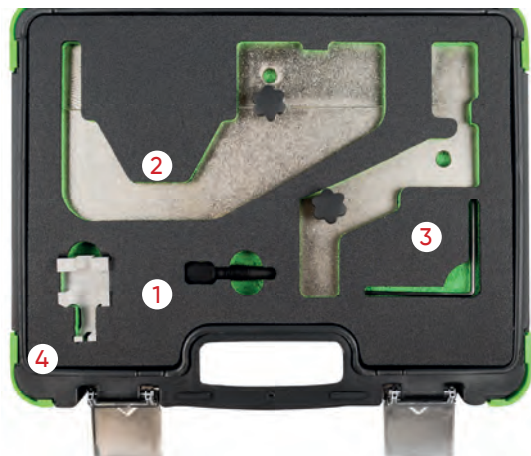

54209

29,70€



COFFRET DE CALAGE POUR FORD/MAZDA 2.2, 3.2 TDCI

MARQUES	FORD_RANGER 3.2L (2011-2016) FORD_RANGER 2.2L (2011-2015) FORD_TRANSIT 2.2L (2006-2016) FORD_EVEREST 3.2L (2015) FORD_RANGER 3.2L (2011) MAZDA BT-50 (2011) MAZDA BT-50 3.2L (2011-2016)
OUTILS OEM	303-675/21-234,303-698/21-251 (1), 303-1587 (2)
CODES MOTEUR	CYFA,CYFB,DRFA,DRFB,P8FA,P8FB,PGFA,PGFB,QVFA,QWFA,SR-FA,SRFB,SRFC,SRFD,SEFE,UHFA,CYFC,DRFC,USRA



54223

149,00€

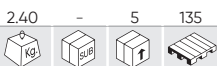

OUTIL DE BLOCAGE DU PIGNON DE L'ARBRE À CAMES POUR FORD 1.5T

MARQUES	FORD_1,5L DURATEC, ECOSPORT, FIESTA, FOCUS
OUTILS OEM	303-1639 (1), 303-1643 (2), 303-1647 (3), 303-1648 (4)
CODES MOTEUR	2.2 / 2.5

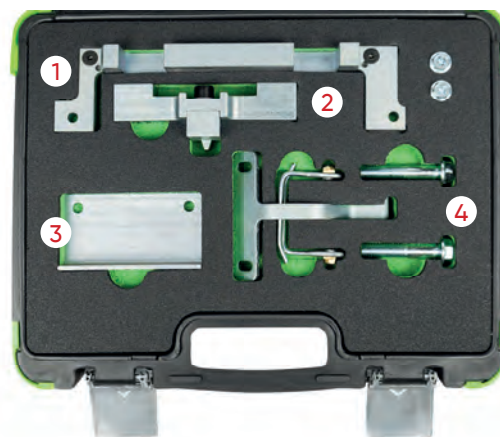

54224

64,50€

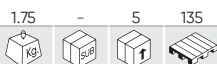

KIT D'INSTALLATION ET DE DÉMONTAGE DE POMPE À INJECTION POUR FORD 2.0

MARQUES	FORD: TRANSIT (17-18), TOURNEO CUSTOM (16-18), TRANSIT CUSTOM (16-18)
OUTILS OEM	303-1635 (1)/3, 3.3--1635 (2)/1, 303-1635 (3)/2, 303-1635/6 (4)
CODES MOTEUR	YLFS, YMFS, YNFS, YLF6, YMF6, YNF6, YLR6, YMR6 AND YNRS.

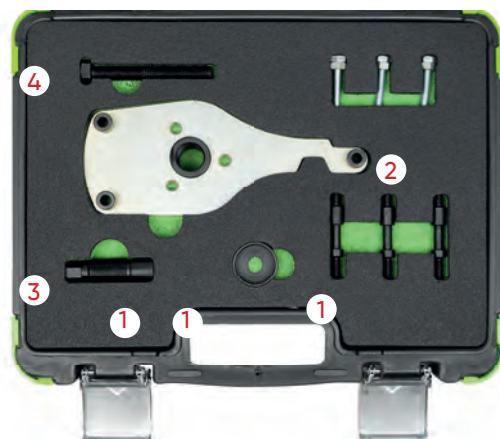

54260

277,00€

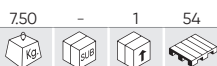

JEU DE MULTIPLICATEURS DE COUPLE 5:1 DESTINÉ AUX MOTEURS ECOBOOST DE FORD



1.0 Ecoboost
1.0 Duratec
2.0 Duratec

2.0 Durator-TDCi
2.0 EcoBlue Diesel



53297

45,00€

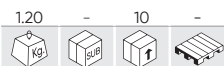

COFFRET DE CALAGE POUR JAGUAR/LAND ROVER

MARQUES	JAGUAR: MS TYPETDVI. LAND ROVER: DISCOVERY 2.7 TDV6. RANGE ROVER: SPORT 2.7 TDV6.
OUTILS OEM	303-1117 (1), 303-1116 (2), 303-1132 (3), 303-1126 (4) (5)
CODES MOTEUR	276DT, 306DT.

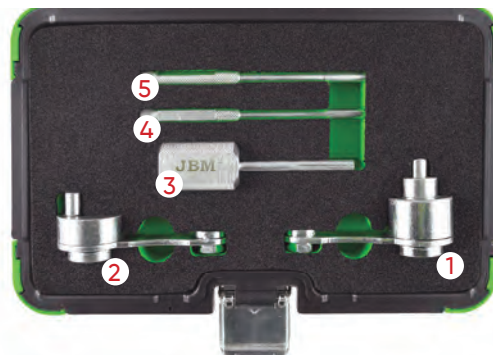

53298

91,00€

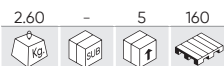

COFFRET DE CALAGE POUR LAND ROVER

MARQUES	MOTEURS DIESEL: 200 TDI. 300 TDI. 2.5
---------	---------------------------------------

- Goupille de calage de transmission manuelle EDC.
- 200 TDI. 300 TDI. 2.5 Moteurs diesel.
- Extracteur d'amortisseur à vilebrequin.
- Outil de blocage de pompe d'injection.
- Boulon de synchronisation de la pompe d'injection 200/300 TDI.
- Outil de synchronisation de volant moteur 200/300 TDI.
- Outil de synchronisation de pompe DPS 2.5.
- Outil de synchronisation du volant moteur 2.5.



54422

140,00€



KIT D'AJUSTEMENT DE L'AXE DE BALANCIER JAGUAR/LAND ROVER 2.0 D

MARQUES	JAGUAR: E-PACE D150, D180, D240 (X540) (2017-), F-PACE 20D, 25D, E-PERFORMANCE (X761) (2016-), XE 20D, 25D, E-PERFORMANCE (X760) (2015-), XF 20D, 25D, E-PERFORMANCE (X260) (2015-) LAND ROVER: DEFENDER SD4 D200, SD4 D240 (L663) (2019-2021), DISCOVERY SPORT ED4, SD4, TD4, D150, D180, D240 MHEV (L550) (2015-), DISCOVERY SD4, TD4 (L462) (2017-2021) RANGE ROVER: EVOQUE ED4, SD4, TD4 (L538) (2015-2019), EVOQUE D150, D180, D240 MHEV (L551) (2019-), SPORT SD4 (L494) (2016-2018), VELAR D180, D240 (L560) (2017-)
OUTILS OEM	JLR-303-1662 (1) JLR303-1663-1 (2) JLR303-1663-2 (3) JLR303-1663-3 (4) JLR-303-1664 (5) JLR-303-1665 (6)
CODES MOTEUR	2.0: AJ200D,AJ200/204DTA,AJ200/2004DTD 2.0: AJ-200D/204DT, AJ-200D/204DTA



54423

108,00€



N

KIT DE DISTRIBUTION POUR LAND ROVER 3.6D

MARQUES	RANGE ROVER SPORT: 3.6 (TDV8) DIESEL (2006-2011) RANGE ROVER: 3.6 (TDV8) DIESEL (2006-2011)
OUTILS OEM	303-1236 (1) 303-1243 (2) 303-1239 (3) 303-1238 (4)
CODES MOTEUR	368DT

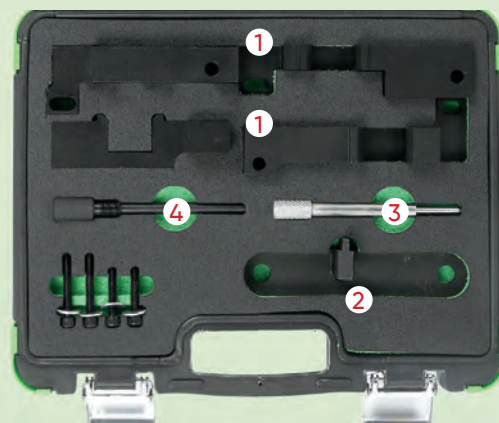

54425

124,00€



N

KIT DE DISTRIBUTION POUR LAND ROVER FREELANDER V6/ROVER KV6 2.0L, 2.5L

MARQUES	LAND ROVER: FREELANDER (2000-2006) MG: ZR (2004-2005), ZS (2001-2005), ZT (2001-2005) ROVER: 45 (1999-2005), 75 (1999-2005), 825 (1996-1999)
OUTILS OEM	LRT 12-175 (1) LRT 12-187 (2) LRT 12-195 (3) LRT 12-196 (4) LRT 12-198 (5) LRT 12-232 (6)
CODES MOTEUR	LAND ROVER: 2,5 KV6 MG: 2,0 KV6, 2,5 KV6 ROVER: 2,0 KV6 2,5 KV6

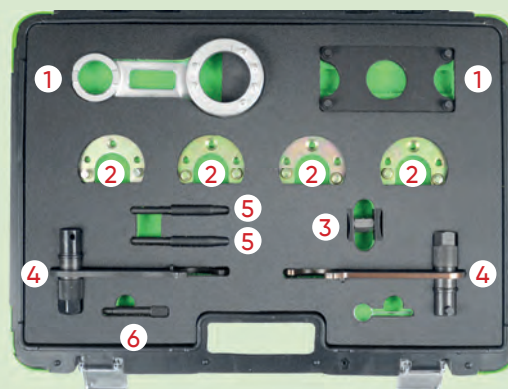

54426

69,00€



N

KIT DE DISTRIBUTION POUR JAGUAR/LAND ROVER 3.2, 3.5, 4.0, 4.2, 4.4

MARQUES	DAIMLER: V8 (97-03), SUPER V8 (97-03), SUPER EIGHT (05-10). JAGUAR: S-TYPE (99-08), XF (08-09), XJR (97-10), XJ8 (97-10), XKR (98-09), XK8 (96-09) LAND ROVER: DISCOVERY III (04-09) RANGE ROVER (05-09), RANGE ROVER SPORT (05-09)
OUTILS OEM	303530 (1) 303531 (2) 303532 (3) 303533 (4) 303645 (5) 303654 (6) T40011 (7)
CODES MOTEUR	3.2: AC,KB,KC 3.5: RB 4.0: BC, CC,CE,DC,EC,GB,GC,LB,LC,MA,MB,NB,NC,PA,PB 4.2: 1B,2B,3B,1G,5G,9G,HB,HG,SB,TB,PC,428PS 4.4: 448PN

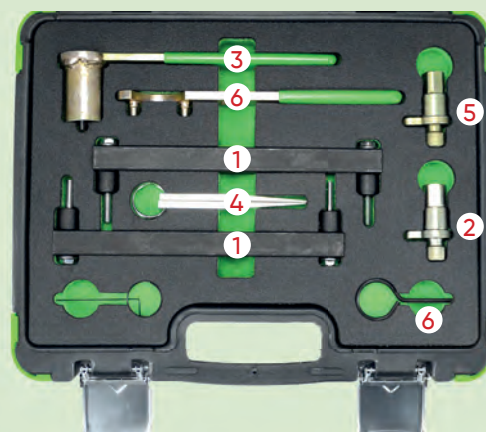

54427

113,00€



N

OUTIL DE BLOCAGE DE LA POULIE DU VILEBREQUIN JAGUAR/LAND ROVER 4.0, 4.2, 4.4

MARQUES	DAIMLER: V8; 4.0 (97-98) JAGUAR: S-TYPE; 3.2, 3.5, 4.2 V8 (99-08), XF; 3.2, 3.5, 4.2 V8 (08-09), XJ; 3.2, 3.5, 4.2 V8 (97-08), XJ8; 4.0 (97-98), XK; 3.2, 3.5, 4.2 V8 (97-08), XK8; 4.0 (97-98) LAND ROVER: DISCOVERY3; 4.2, 4.4 LA V8 (05-09) RANGE ROVER; 4.2, 4.4 SPORT LS V8 (05-09), RANGE ROVER; 4.2, 4.4 LM V8 (06-08)
OUTILS OEM	LRT 12 080 18G 1437 18G 1437 2 303 191 303 191 03 303 191 04 303 588 303 893
CODES MOTEUR	AJ26, AJ27, AJ28, AJ34 30G,36D,42D,56D,58D,94D,428PS,448PN



54428

31,00€



N

KIT DE DISTRIBUTION POUR CHRYSLER/JEEP 2.8 CRD

MARQUES	CHRYSLER GRAND VOYAGER 2008 - 2015 DODGE NITRO 2007 - 2011 JEEP CHEROKEE 2008 - 2013, WRANGLER 2007 - 2018
OUTILS OEM	VM 9991 (1) VM 9992 (2)
CODES MOTEUR	VM64C, ENS, ENS (51C), 49C, 50C, ENS VM10D, ENS VM11D



54429

55,00€



N

KIT DE DISTRIBUTION POUR CHRYSLER/JEEP 3.0D

MARQUES	CHRYSLER 300 C 2012 - 2015 JEEP GRAND CHEROKEE 2011 - ON
OUTILS OEM	VM 10338 1 (1) VM 10338 2 (2) VM 10359A (3), VM 10359 (3) VM 10339 (4), VM 10359 (4)
CODES MOTEUR	3.0 CRD: EXF 3.0 CRD/MULTIJET: EXF VM23D, EXF VM44D, EXF VM44D, EXF VM63D

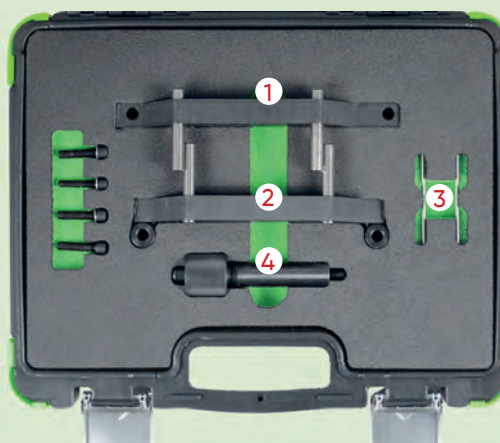

54207

38,90€

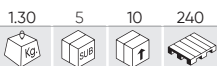

COFFRET DE CALAGE POUR CHRYSLER/ JEEP LDV 2.5 CRD

MARQUES	CHRYSLER: VOYAGER (01-08), GRAND VOYAGER (01-08) JEEP: CHEROKEE (01-08) LDV: MAXUS (05-09)	
OUTILS OEM	VM 9660 (1), VM1052 (2), VM1053 (3), VM1068 / VM1089 (4), VM1080 (5), VM8873 (6)	
CODES MOTEUR	2.5D CRD: R2516C, R2516K, R2516LVM39/40B.	2.8D CRD: R2816C5.05A, R2816K4.

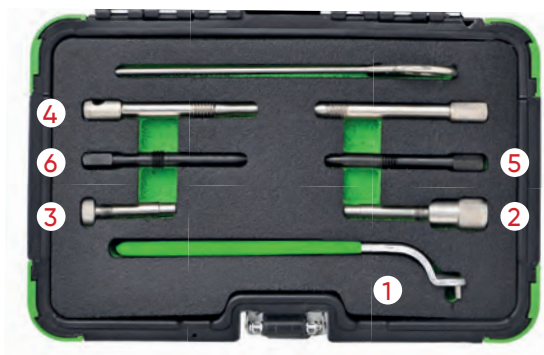

53270

70,00€

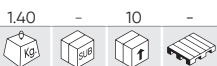

COFFRET DE CALAGE POUR MERCEDES/CHRYSLER/ JEEP

MARQUES	MERCEDES CHRYSLER JEEP
OUTILS OEM	112589034000 (1), 601589024000 (2), 111589031500 (3)
CODES MOTEUR	HERR.: 112 589 03 40 00; 112, 113, 137, 155, 156, 272/979, 273, 629, 642/992. HERR.: 601 589 02 40 00: 102, 103, 104, 111, 601, 602.91/93/94/96/983, 603.91/93/96/97, 604, 605, 606, 611, 612/965/966, 613. HERR.: 111 589 03 15 00: 111, 119, 604, 605, 606, 611/980, 612, 613, 628, 629, 640, 642/922, 612.965/966, 646, 647, 648 .

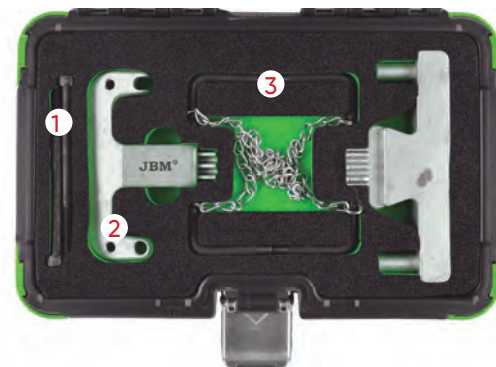

53271

227,00€



COFFRET DE CALAGE POUR MERCEDES BENZ M271

MARQUES	MERCEDES
OUTILS OEM	271 589 003100 (1), 271589014000 (2), 271589001500 (3), 156589006100 (4)
CODES MOTEUR	M271. E18ML 2002. DE18ML 2003 - 2005. E16ML 2008. DE18LA 2009.

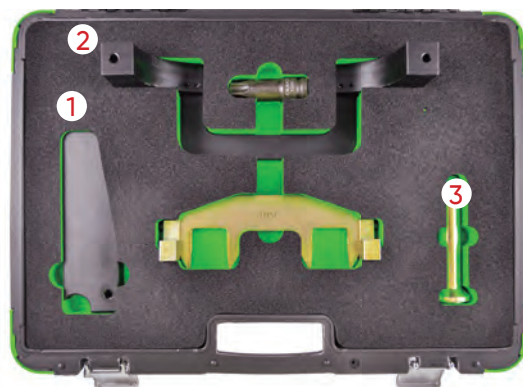

53272

195,00€

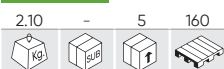

COFFRET DE CALAGE POUR MERCEDES AMG 156

MARQUES	MERCEDES
OUTILS OEM	156589006100 (1), 156589003200 (2), 156589016300 (3), 156589006900 (4)
CODES MOTEUR	BENZ AMG 156.ML 63 AMG.S 63L AMG.S 63. AMG. R 63 AMG L 4MATIC. R63 AMG 4MATIC. E 63 AMG. CLS 63 AMG. CLK 63 AMG. CLK 63 AMG BLACK SERIES. CLK 63 AMG CABRIO. CL 63 AMG.

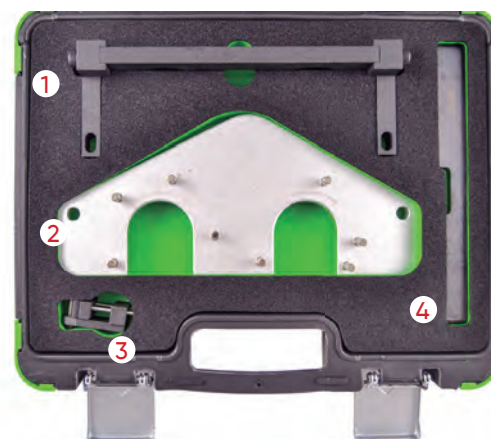

53273

75,00€



COFFRET DE CALAGE POUR MERCEDES M276, M157, M278

MARQUES	MERCEDES		
OUTILS OEM	27658901400		
CODES MOTEUR	<table border="0"> <tr> <td>CL 500 / 63 AMG (C 216) 2010-2013. S 500 / 63 AMG (C 217) 2014. CLS 300 (C 218) 2012. E 300 / 350 / 400 (C/A 207) 2011. CLS 350 / 400 / 500 / 63 AMG (C/X 218) 2011-2014. SLK 350 (R 172) 2011. SL 350 / 400 / 500 / 63 AMG (R 231) 2012. S 500 PLUG-IN HYBRID (V 222) 2014. ML 300 / 350 / 500 / 63 AMG (W 166) 2011.</td> <td>C 400 (W 205) 2014. E 400 HYBRID (W 212) 2012. G 63 AMG (W 463) 2012. E 300 / 350 / 400 / 500 / 63 AMG (W/S 212) 2011. C 350 (W/S/C 204) 2011. S 350 / 500 / 63 AMG (W/V 221) 2010. S 400 / 63 AMG (W/V 222) 2013. R 350 BlueEFFICIENCY (W/V 251) 2012. GL 450 / 500 (X 166) 2012. GLK 350 (X 204) 2011.</td> </tr> </table>	CL 500 / 63 AMG (C 216) 2010-2013. S 500 / 63 AMG (C 217) 2014. CLS 300 (C 218) 2012. E 300 / 350 / 400 (C/A 207) 2011. CLS 350 / 400 / 500 / 63 AMG (C/X 218) 2011-2014. SLK 350 (R 172) 2011. SL 350 / 400 / 500 / 63 AMG (R 231) 2012. S 500 PLUG-IN HYBRID (V 222) 2014. ML 300 / 350 / 500 / 63 AMG (W 166) 2011.	C 400 (W 205) 2014. E 400 HYBRID (W 212) 2012. G 63 AMG (W 463) 2012. E 300 / 350 / 400 / 500 / 63 AMG (W/S 212) 2011. C 350 (W/S/C 204) 2011. S 350 / 500 / 63 AMG (W/V 221) 2010. S 400 / 63 AMG (W/V 222) 2013. R 350 BlueEFFICIENCY (W/V 251) 2012. GL 450 / 500 (X 166) 2012. GLK 350 (X 204) 2011.
CL 500 / 63 AMG (C 216) 2010-2013. S 500 / 63 AMG (C 217) 2014. CLS 300 (C 218) 2012. E 300 / 350 / 400 (C/A 207) 2011. CLS 350 / 400 / 500 / 63 AMG (C/X 218) 2011-2014. SLK 350 (R 172) 2011. SL 350 / 400 / 500 / 63 AMG (R 231) 2012. S 500 PLUG-IN HYBRID (V 222) 2014. ML 300 / 350 / 500 / 63 AMG (W 166) 2011.	C 400 (W 205) 2014. E 400 HYBRID (W 212) 2012. G 63 AMG (W 463) 2012. E 300 / 350 / 400 / 500 / 63 AMG (W/S 212) 2011. C 350 (W/S/C 204) 2011. S 350 / 500 / 63 AMG (W/V 221) 2010. S 400 / 63 AMG (W/V 222) 2013. R 350 BlueEFFICIENCY (W/V 251) 2012. GL 450 / 500 (X 166) 2012. GLK 350 (X 204) 2011.		



54318

105,00€

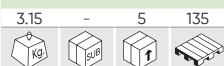

OUTIL A RIVETER LA CHAÎNE DE DISTRIBUTION

MARQUES	CHRYSLER JEEP MERCEDES
OUTILS OEM	112 589 026 300 (1) 103 589 016 300 (2) 602 589 026 300 (3) 602589023300 (4) 602589003900 (5) 602589046301 (6)
CODES MOTEUR	CHRYSLER/JEEP: 2.2D, 2.7D, 3.0D CRD (DIESEL). MERCEDES: 1.7D, 2.1D, 2.2D, 2.7D, 3.0D, 3.2D, 3.9D, 4.0D CDI (DIESEL)

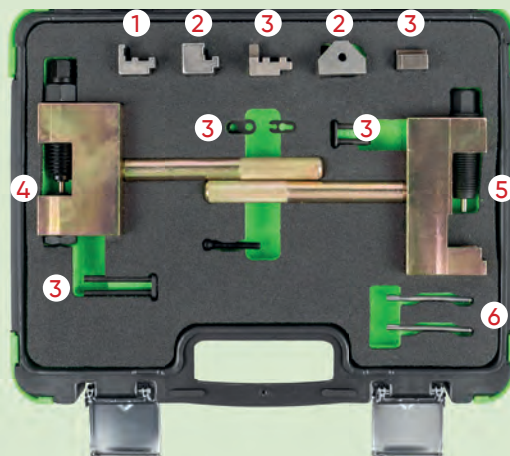

54414

97,50€



N

KIT DE DISTRIBUTION POUR MERCEDES M651

MARQUES	A CLASS (2012-2018), B CLASS (2012-2019), C CLASS (2009-2015), C CLASS (2014-2018), CLA COUPE (2013-2019), CLS (2011-2018), E CLASS (2009-2016), GLA (2014-2020), GLC (2015-2019), GLE (2015-2019), GLK (2008-2015), M CLASS (2011-2015), S CLASS (2010-2013), S CLASS (2013-2017), SLC (2016-2017), SLK (2012-2016), SPRINTER (2009-2018), SPRINTER (2018-), V CLASS (2014-), VIANO (2010-2015), VITO (2010-2015), VITO (2014-) MERCEDES-BENZ
OUTILS OEM	608 31 800 (1) 608 31 830 (2) 608 31 810 (3) 608 31 820 (4) 651 589 00 40 00 (5)
CODES MOTEUR	1.8: 651.901 2.1: 651.900, 651.910, 651.911, 651.912, 651.913, 651.916, 651.921, 651.922, 651.924, 651.930, 651.940, 651.950, 651.955, 651.956, 651.957, 651.958, 651.960, 651.961, 651.980 2.2: 651.925

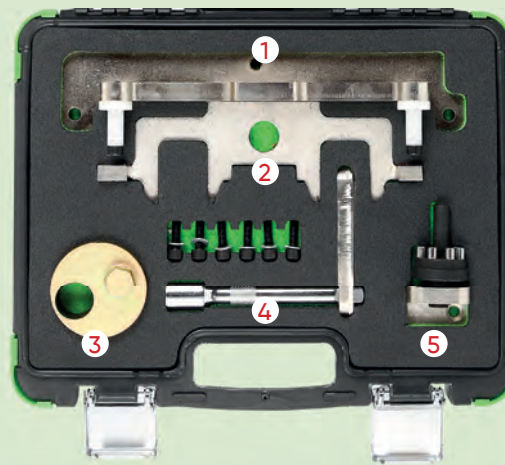

54415

60,00€



N

KIT DE DISTRIBUTION POUR MERCEDES M651

MARQUES	GLA X156 200/220 CDI, GLK X 204 200/220/250 CDI, ML W166 250, SLK R172 250 CDI, SPRINTER W906 210/310/510/213/313 CDI, SPRINTER W906 513/216/316/416/516 CDI, V-CLASS W/V 639 2.0/2.2 CDI, VITO W/V 639 110/113/116 CDI MERCEDES-BENZ: A-CLASS W176 180/200/220 CDI, B-CLASS W246 200/220 CDI, C-CLASS W/S/C 204 180/200/220/250 CDI, CLA C117 200/220 CDI, CLD C/X 218 220/250, E-CLASS W/S 212 200/220/250 CDI E-CLASS C/A 207 220/250 CDI, E-CLASS W212 250/300 BLUETEC
OUTILS OEM	651589004000 (1) 651589014000 (2)
CODES MOTEUR	1,8 651.901 2,1 651.900 651.910 651.911 651.912 651.913 651.916 651.921 651.922 651.924 651.925 651.930 651.940 651.950 651.955 651.956 651.957 651.958 651.960 651.961 651.980

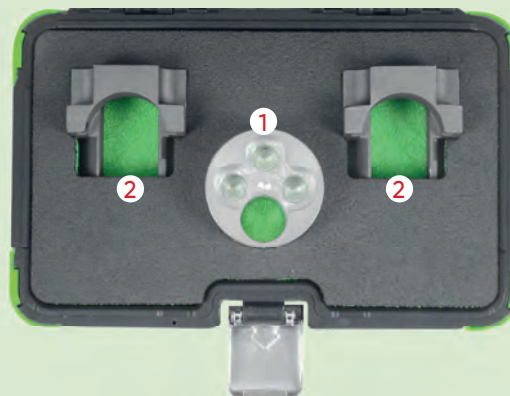

54416

31,00€



N

KIT DE DISTRIBUTION POUR MERCEDES M642

MARQUES	G-CLASS (461/463) 2007-2015, GL-CLASS (164/166) 2006-2016, GLE/GLE COUPE (166/292) 2020 GLK (204) 2008-2015, GLS (166) 2016-2019, M-CLASS (164/166) 2005-2015, R-CLASS (251) 2005-2013, S-CLASS (221/222) 2005-2017, SPRINTER (906) 2006-2018, VIANO (639) 2005-2015, VITO (639) 2006-2015 MERCEDES-BENZ: C-CLASS (203/204) 2004-2014, CLK (209) 2005-2009, CLS (219/218) 2005-2018, E-CLASS (211/212/213) 2005-2018, E-CLASS COUPE/CABRIOLET (207) 2009-2017
OUTILS OEM	642589003100 (1)
CODES MOTEUR	642.820 642.822 642.826 642.830 642.832 642.834 642.835 642.836 642.838 642.850 642.852 642.853 642.854 642.855 642.856 642.858 642.861 642.862 642.867 642.868 642.870 642.872 642.884 642.886 642.890 642.896 642.910 642.920 642.921 642.922 642.930 642.932 642.940 642.950 642.960 642.961 642.970 642.975 642.990 642.992 642.993

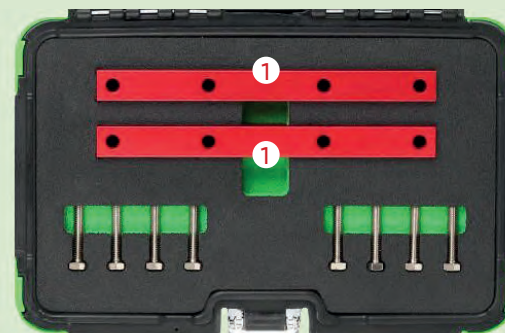

54417

153,00€



N

KIT DE DISTRIBUTION POUR MERCEDES M133, M270, M274

MARQUES	MERCEDES.BENZ A -CLASS (W176) (2012), MODEL A180/A200 MERCEDES.BENZ B CLASS (W246) AS OF 2011, MODEL B180/B200
OUTILS OEM	270589006100 (1)
CODES MOTEUR	M133 M270 M274

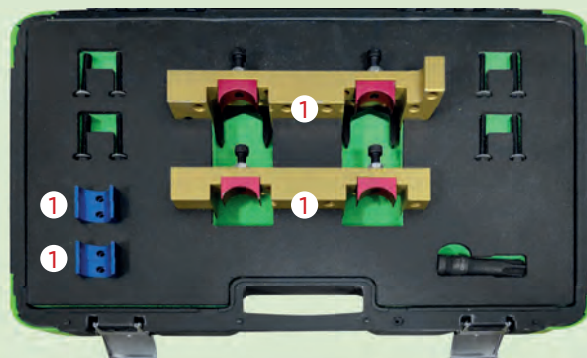

54418

37,00€



N

KIT DE DISTRIBUTION POUR MERCEDES M112, M113

MARQUES	C-CLASS (202) 2.4/2.6/2.8/3.2/4.3 - 1998-00, CLK (208) 3.2/4.3/5.4 - 1997-03, E-CLASS (210) 2.4/3
OUTILS OEM	112589003200 (1) 112589013200 (2) 112589000100 (3)
CODES MOTEUR	MERCEDES.BENZ: M112, M113

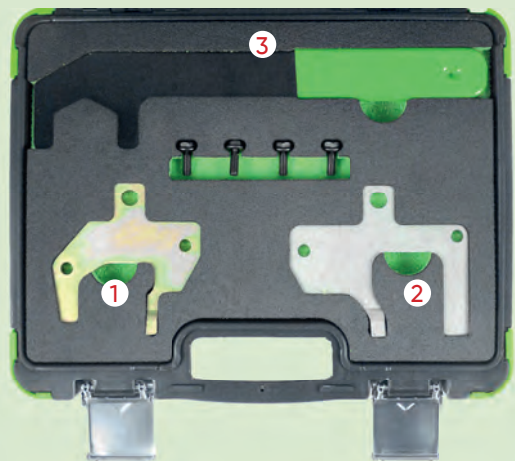

51488

16,00€

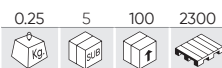

CALAGE POUR RENAULT/NISSAN/DACIA/SUZUKI

MARQUES	RENAULT: CAPTUR, CLIO II,III,IV, ESPACE/GRAND ESPACE III,IV, FLUENCE, KADJAR, KANGOO, LAGUNA I,II,III, LOGAN/ LOGAN MCV, MEGANE I,II,III,IV, MODUS/GRAND MODUS, SCENIC/ GRAND SCENIC I,II,III,IV, TWING II, TRAFIC II, MASTER II 1.5DCI & 1.9 DCI. DACIA: DOKKER, DUSTER, LODGY, LOGAN, SANDERO 1.5DCI NISSAN: ALMERA, CUBE, JUKE, KUBISTAR, MICRA, NOTE, NV200/EVALIA, PRIMERA, TIIDA, INTERSTAR, PRIMASTAR 1.5DCI & 1.9 DCI SUZUKI: GRAND VITARA, JIMNY 1.5DDIS & 1.9DDIS
OUTILS OEM	MOT1489, MOT1430, MOT1054.
CODES MOTEUR	K9K, F8Q, F9Q - Essence, Clio, R19, Laguna 1.8/2.0 F3R F3P



53289

45,00€

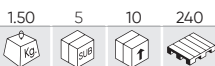

COFFRET DE CALAGE POUR RENAULT 1.4, 1.6, 1.8, 2.0 16V

MARQUES	<p>RENAULT: ESPACE/GRAND ESPACE (98-02), ESPACE/GRAND ESPACE IV (02-10), KANGOO/TREKKA (01-09), LAGUNA (98-01), LAGUNA II (01-07), LAGUNA III (07-13), MEGANE (99-03), MEGANE II (02-10), MEGANE III/SPORT (08-13), MEGANE/SCENIC (99-00), SCENIC/RX4 (99-03), SCENIC/GRAND SCENIC II (03-09), TRAFIC II (01-11), TWINGO II (08-14), VEL SATIS (00-10), WIND (10-14)</p> <p>DACIA: LOGAN/MCV (05-11).</p> <p>NISSAN: KUBISTAR X76 (03-09), PRIMASTAR (02-11).</p> <p>VAUXHALL/OPEL: JETTA, TOURAN, GOLF, GOLF PLUS, POLO, PASSAT, TIGUAN, SCIROCCO.</p>
OUTILS OEM	MOT1489 (1), MOT1054 (2), MOT1496 (3)
CODES MOTEUR	<p>1.4 16V K4J: 730, 732, 740.</p> <p>1.6 16V K4M: 752, 753, 760, 761, 764, 788, 812, 813, 854, 856.</p> <p>1.8 16V F4P: 720, 722, 760, 770, 771, 772, 773, 774, 775.</p> <p>2.0 16V F4R: 700, 701, 712, 713, 714, 715, 720, 722, 730, 732, 736, 738, 740, 741, 744, 746, 747, 762, 763, 764, 765, 766, 767, 770, 771, 780, 790, 791, 792, 820, 830, 832, 867.</p> <p>2.0 16V F4R(TT): 720, 722, 764, 765, 774, 776, 784, 786, 787, 794, 795, 796, 797, 800, 802, 810, 811, 870, 872, 874, 886, 887, 896, 897.</p>

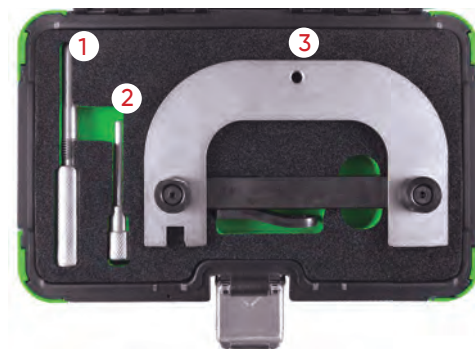

53290

51,00€



COFFRET DE CALAGE POUR RENAULT/VOLVO 16V, 20V

MARQUES	<p>RENAULT: LAGUNA 2.0 16V / 2.5 20V (1996-1999), SAFRANE 2.0 16V / 2.5 20V (1996-2001)</p> <p>VOLVO: 850 (1992-1997), C70 (1998-2002), S40 (1996-2004), V40 (1996-2004), S60 (2001-2005), S70 (1997-2000), S80 (1999-2005).</p>
OUTILS OEM	MOT1348 (1), MOT1337 (2), MOT1340 (3)
CODES MOTEUR	<p>RENAULT: N7Q 704/710/711(2.0 16V), N7U 700/701(2.5 20V).</p> <p>VOLVO: B4164S, B4164S2, B4184S, B4184S2, B4184S3, B4184S9, B4184S10, B4194T, BS194T2, B420S4, B4204S2, B4204T, B4204T2, B4204T3, B4204T5, B5202FS, B5204FT, B5204T2, B5204T3, B5204T4, B5204T5, B5234FS, B5204FT, B5234T3, B5234T4, B5234T5, B5234T6, B5234T7, B5234T8, B5234T9, B5244S, B5244S2, B5244SG, B5244SG2, B5244T, B5244T3, B5244T4, B5244T5, B5244T7.</p>

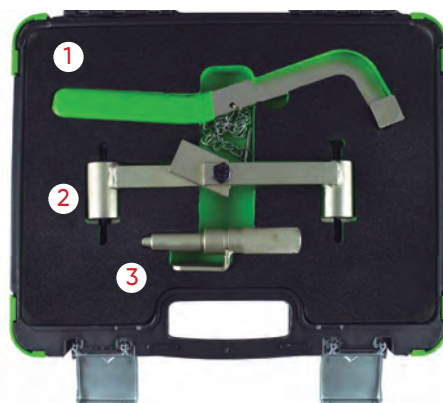

53291

68,00€



COFFRET DE CALAGE POUR RENAULT

MARQUES	RENAULT: CLIO, LAGUNA, MEGANE
OUTILS OEM	MOT1496 (1), MOT1489 (2), MOT861/1863 (3), MOT1490(4)
CODES MOTEUR	K4J, K4M, F4P, F4R.

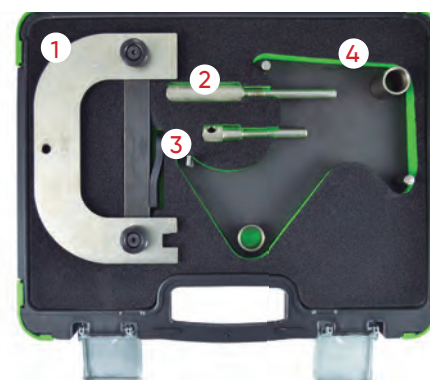

53292

116,00€



COFFRET DE CALAGE POUR RENAULT/OPEL 2.2, 2.5 TDI DCI

MARQUES	RENAULT: LAGUNA II, ESPACE, MASTER, TRAFIC, 2.2 / 2.5 DCI OPEL: VIVARO, MOVANO, DIESEL: 2.2 / 2.5 DTI, ASTRA B, VECTRA B, SIGNUM, ZAFIRA, 2.2 16V
OUTILS OEM	KM6205 (1), KM6204 (2), KM6077 (3)
CODES MOTEUR	2.2 / 2.5

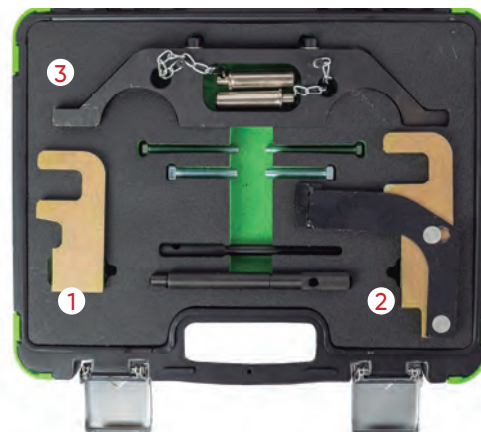

53311

97,00€



COFFRET DE CALAGE POUR RENAULT/NISSAN/OPEL/VAUXHALL 2.0, 2.3 DCI, CDTI, M9R, M9T

MARQUES	NISSAN: PRIMASTAR X83 (06-15), QASHQAI/QASHQAI+2 J10 (07-14), X-TRAIL T31 (07-14). VAUXHALL/OPEL: MOVANO-B (10-17), VIVARO (06-15). RENAULT: ESPACE/GRAND ESPACE IV (06-10), KOLEOS (08-15), LAGUNA LL (05-07), LAGUNA LLL (07-14), MASTER LLL (10-15), MEGANE LL (06-10), SCENIC/GRAND SCENIC LL (06-09), SCENIC/GRAND SCENIC LLL (09-15), TRAFIC LL (06-14), VEL SATIS (05-10)
OUTILS OEM	MOT1769 (1), EN-48334 (2), MOT1766 (3), EN-48330 (3), KM-6130 (4), EN-48332 (5), MOT1773 (6), EN-48831 (6)
CODES MOTEUR	2.0D DCI M9R: 630, 780, 782, 784, 786, 788, 830, 832, 833, 834, 835, 836, 838, 855, 856. 2.0D CDTI M9R: 630, 780, 782, 784, 786. 2.3 BI-CDTI: LP6/M9T706, LW7/M9T706. 2.3D DCI M9T: 670, 672, 676, 678, 680, 686, 690, 692, 694, 698.



53523

91,00€



COFFRET DE CALAGE POUR MOTEUR DIESEL RENAULT/NISSAN/OPEL 1.6 DCI

MARQUES	RENAULT: ESPACE/GRAND ESPACE IV (06-10), KALEOS (08-11), LAGUNA LL (05-07), LAGUNA LLL (07-12), MASTER LLL (10-12), MAGANE LL (06-10), SCENIC/GRAND SCENIC LL (06-09), SCENIC/GRAND SCENIC LLL (09-12), TRAFIC LL (06-12), VEL SATIS (05-10) NISSAN: PRIMASTAR X83 (06-10), QASHQAI/QASHQAI+2 J10 (07-10), X-TRAIL T31 (07-12). VAUXHALL / OPEL: MOVANO-B (10-12), VIVARO (06-12).
OUTILS OEM	MOT1969 (1), MOT1970 (2), MOT1770, MOT1773, EN-48330, EN-48332, EN-48334, EN-48831, KM-6130
CODES MOTEUR	M9R 2.0DCI: 610, 615, 630, 700, 721, 740, 742, 760, 761, 762, 763, 780, 782, 784, 786, 788, 800, 802, 803, 805, 808, 816, 830, 832, 833. M9T 2.3DCI: 670, 672, 676, 678, 680, 686, 690, 692, 694, 698.



54210

84,00€

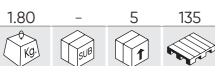

COFFRET DE CALAGE DU PIGNON DE L'ARBRE À CAMES POUR RENAULT 1.8, 2.0 16V

MARQUES	RENAULT LAGUNA II (2001 - 2009), MEGANE II (2002 - 2009), Scenic (2002 - 2009)
OUTILS OEM	MOT 1509-01 (1), 1509 (2)
CODES MOTEUR	700, 701, 712, 713, 714, 715, 720, 721, 722, 722, 730, 732, 736, 738, 740, 741, 744, 746, 747, 760, 761, 762, 763, 764, 765, 766, 767, 770, 771, 773, 774, 774, 775, 776, 784, 786, 787, 790, 792, 794, 797, 830, F4P, F4R



54225

133,00€

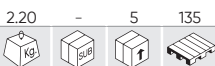

COFFRET DE CALAGE DU VOLANT/DE LA POULIE DU VILEBREQUIN POUR RENAULT/NISSAN

MARQUES	NISSAN: PRIMASTAR (06-15), QASHQAI/QASHQAI+2 (07-14), X-TRAIL (07-14), NAVARA (15-16), NV400 (11-16) RENAULT: ESPACE V (15-16), CLIO (06-16), FLUENCE (09-15), LAGUNA (05-15), LATITUDE (10-15), MEGANE (06-15), SCENIC/ GRAND SCENIC (06-15), ESPACE/GRAND ESPACE IV (02-15), KOLEOS (08-16), TRAFIC II (07-15), VEL SATIS (00-10), MASTER III (10-16)
OUTILS OEM	MOT 1431(1), MOT 1716(2), MOT 2019(2), MOT 1789(3), MOT 919-02(4)
CODES MOTEUR	1.4: H4 JT700 1.6: M5M400, M5M450 2.0: M4R700, M4R701, M4R704, M4R711, M4R713, M4R714, 2.0D: M9R726, M9R730, M9R735, M4R737, M9R740, M4R746, M9R742, M9R744, M9R746, M9R748, M4R750, M4R751, M4R752, M4R753, M4R754, M9R610, M9R613, M95615, M9R630, M9R750, M9R760, M9R761, M9R762, M9R762, M9R763, M9R700, M9R721, M9R722, M9R724, M9R756, M9R780, M9R782, M9R800, M9R802, M9R803, M9R804, M9R805, M9R806, M9R808, M9R809, M9R811, M9R812, M9R814, M9R815, M9R816, M9R817, M9R820, M9R824, M9R828, M9R830, M9R832, M9R833, M9R834, M9R835, M9R836, M9R838, M9R839, M9R844, M9R845, M9R846, M9R849, M9R854, M9R855, M9R856, M9R857, M9R858, M9R859, M9R865, M9R866, M9R784, M9R786, M9R788 2.3D: M9T670, M9T672, M9T676, M9T678, M9T680, M9T686, M9T690, M9T692, M9T694, M9T696, M9T698, M9T700, M9T702, M9T706, M9T708, M9T870, M9T880, M9T890, M9T896, M9T898, M9T899, YS23DDT, YS23DDTT 2.5: 2TR700, 2TR702, 2TR703, 2TR704, 2TR705, 2ZV604, V4U604, VQ25 3.5: V4Y701, V4Y711, V4Y713, V4Y715



VOTRE JEU D'OUTILS DE CHRONOMÉTRAGE ENCORE PLUS PRÉCIS

ENTREZ LE CODE DE L'OUTIL OEM OU LE CODE DU MOTEUR DE VOTRE VOITURE DANS VOTRE NAVIGATEUR WEB ET TROUVEZ VOTRE OUTIL DE CHRONOMÉTRAGE COMPATIBLE

54289

38,00€

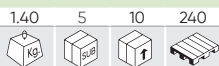

N

KIT DE VERROUILLAGE DU VOLANT D'INERTIE MOTEUR POUR MERCEDES/RENAULT/DACIA/NISSAN

MARQUES	DACIA DOKER 2015 + DACIA DUSTER 2015+ DACIA LODGY 2015+ DACIA LOGAN 2013/-2020 DACIA SANDERO 2013+ MERCEDES-BENZ A-CLASS 2018+ MERCEDES-BENZ B-CLASS 2019+ MERCEDES-BENZ CLA 2019+ MERCEDES-BENZ GLA 2019+ MERCEDES-BENZ GLB 2019+ RENAULT ARKANA 2019+ RENAULT CAPTUR 2018+ RENAULT CLIO V 2019 + RENAULT KADJAR 2018+ RENAULT MEGANE IV 2017+ RENAULT SCENIC/GRAND SCENIC IV 2018+ RENAULT TALISMAN 2018+
OUTILS OEM	MOT.2188 (1)
CODES MOTEUR	HR13DDT, H4Bt 400, H4Bt 408, H4Bt 410, H4Bt 411, H4M 730, H4M 738, H4M 740, H5H 450, H5H 470, H5H 480, 282.914



54438

40,00€



N

KIT DE DISTRIBUTION POUR RENAULT/NISSAN 3.0DCI

MARQUES	NISSAN: NAVARA PICK UP, PATHFINDER, INFITI RENAULT: LAGUNA, LATITUDE
OUTILS OEM	MOT 1880 (1) MOT 1970 (2) MOT 1874 (3)
CODES MOTEUR	V9X, V9X 791, 891

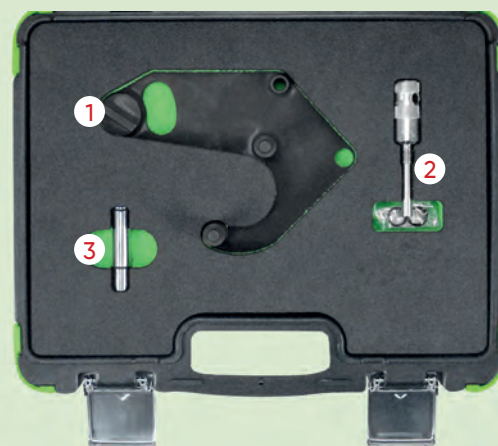

54439

32,50€



N

POULIE DE VILEBREQUIN RENAULT/DACIA 0.9, 1.0, 1.2, 1.6 TCE

MARQUES	DACIA DOKKER 2012 - 2019, PLUMERO 2013 - 2018, LOGIA 2012 - 2018 RENAULT CAPTURAR 2013 - 2019, CLIO IV 2012 - 2019, KADJAR 2015 - 2018, KANGOO II 2013 - EN, MEGANE III 2012 - 2017, MEGANE IV 2016 - 2020, ESCENICO/GRAN ESCENICO III 2012 - 2017, ESCENICO/GRAN ESCENICO IV 2016 - 2018, TWIN-GO III 2014 - EN
OUTILS OEM	MOT. 2006 (1) MOT. 2054 (1) 281589004000 (1)
CODES MOTEUR	0.9TCE: H4B 453, H4Bt 400, 401, 408, 410, 411, 451. 1.0TCE: H4D, H4D 400, 450, 460, 470 1.2TCE: H5Ft 400, 403, 404, 405, 408, 410, 412. 1.6TCE: H4M 429, 438, 440, 729, 730, 738, 740, 748, 749

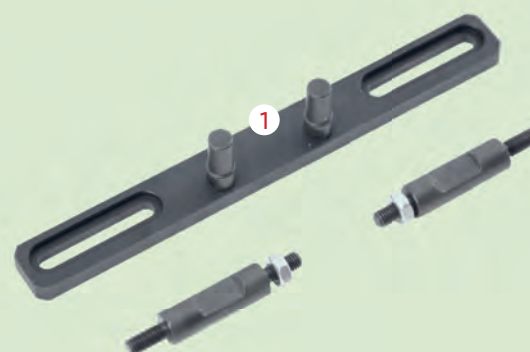

53299

291,00€

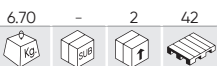

COFFRET DE CALAGE DE CHAINES POUR OPEL/VAUXHALL

MARQUES	OPEL / VAUXHALL
OUTILS OEM	EN-46788 (1), KM927 (2), EN-46789 (3), KM929 (4), EN-46785 (5), EN-46788 (6), 1 860 985 000 (7), KM932 (8), KM933 (9), EN-49978 (10), KM933 (11)
CODES MOTEUR	1.3 CDTI 16V, 1.9 CDTI, 2.0 DTI, 2.2 DTI.

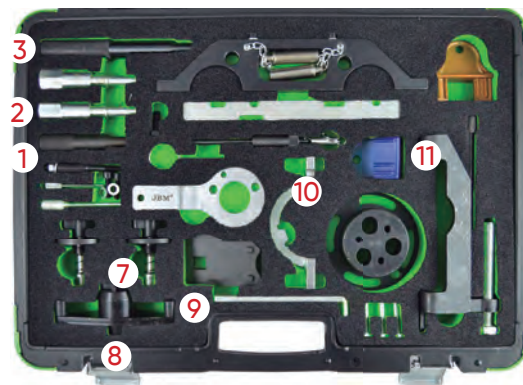

53300

41,00€

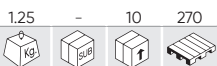

COFFRET DE CALAGE POUR OPEL/VAUXHALL/CHEVROLET 2,0CDI

MARQUES	OPEL VAUXHALL CHEVROLET
OUTILS OEM	EN-48245 (1), EN-48246 (2), 205083060 (3) (4) (5) (6)
CODES MOTEUR	OPEL / VAUXHALL: Z20DM, Z20DMH CHEVROLET: LLWZ20DMH, RA 420 , Z20SI, Z 20S3, Z 20S4, Z 20S5

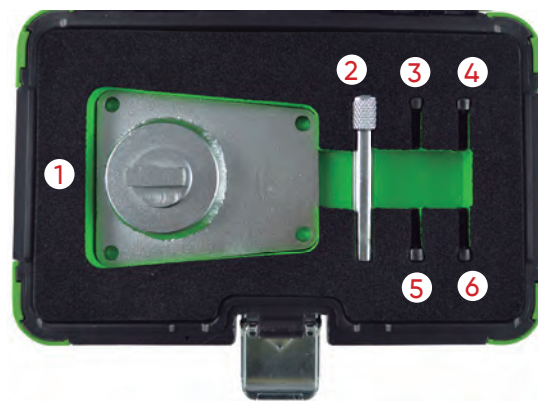

53301

44,00€



COFFRET DE CALAGE POUR SUZUKI/OPEL 1.0, 1.2, 1.4

MARQUES	SUZUKI: WAGON R (05-08). VAUXHALL / OPEL: AGILA (00-08), ASTRA-G (98-06), ASTRA G CLASSIC II (03-10), ASTRA-H (04-11), COMBO (04-12), CORSA-B (97-00), CORSA-C (00-07), CORSA-D (06-12), MERIVA-A (04-10), TIGRA-B (04-10).
OUTILS OEM	KM-953/09919-58310 (1), KM-952/09912-38310 (2), KM-954/09919-08310 (3), KM-6130 (4), KM-955/09919-58320 (5)
CODES MOTEUR	1.0 12V: X10XE, Z10XE, Z10XEP. 1.2 16V: X12XE, Z12XE, Z12XEP. 1.4 16V/ECOFLEX: Z14XEL, Z14XEP.

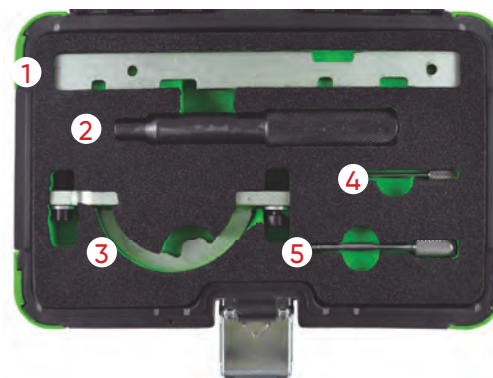

53302

44,00€

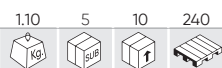

COFFRET DE CALAGE POUR FIAT/ALFA ROMEO/VAUXHALL/OPEL/SAAB JTD

MARQUES	SAAB: 9-3 (04-08), 9-5 (05-08). VAUXHALL / OPEL: ASTRA-H, VECTRA-C, SIGNUM (04-07), ZAFIRA-B (05-07).
OUTILS OEM	EN46789/32 025 008 (1) (3), EN46788/32 025 009 (2), KM6349 (4)
CODES MOTEUR	Z19DT, Z19DTH, Z19DTL.



53305

136,00€

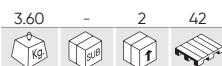

COFFRET DE CALAGE POUR SAAB/OPEL/VAUXHALL

MARQUES	VAUXHALL / OPEL: ANTARA (06-10), CALIBRA (93-98), CAVALIER/VECTRA-A (93-95), OMEGA-B (94-03), SIGNUM (03-05), SINTRA (96-99), VECTRA-B (95-02), VECTRA-C (02-05). SAAB: 900 (93-98), 9000 (95-97), 9-5 (98-03)
OUTILS OEM	KM-800-1 (1), KM-800-2 (2), KM-800-20 (3), KM-800-10 (4), 83 95 006 (5), KM-800-30 (6), MKM-6038, 83 95 006 (7)
CODES MOTEUR	2.5 V6: SAAB: B2581, VAUXHALL/OPEL: C25XE, X25XE. 2.6 V6: VAUXHALL/OPEL: Y26SE. 3.0 V6: SAAB: B308E, B308I, VAUXHALL / OPEL: X30XE. 3.2 V6: VAUXHALL/OPEL: Y32SE, .



53307

38,50€



COFFRET DE CALAGE POUR ALFA/OPEL/VAUXHALL 1.6, 1.8 16V

MARQUES	OPEL / VAUXHALL: CORSA-D, AGILA, ASTRA-G-H, MERIVA, ZAFIRA-B, VECTRA-C, SIGNUM, INSIGNA	1.6, 1.8
	CHEVROLET: AVEO, CRUZE, ORLANDO	1.4, 1.6, 1.8
	ALFA ROMEO: 159 FIAT: CROMA	1.8
OUTILS OEM	E10290 (1), 23056-06 (2) (3), E10230 (4), 23164-04 (5), 23174-01 (6), 23056-05 (7)	
CODES MOTEUR	OPEL / VAUXHALL: Z16LEL, Z16LER, Z16LET, Z16XE1, Z16XEP, Z16XER, A16XER, 18XER, A18XER, 2HO/A18XEL. CHEVROLET: G14D, LDD, LXV (F16D4), 2HO(Z18XER). ALFA / FIAT: 939A4.000.	

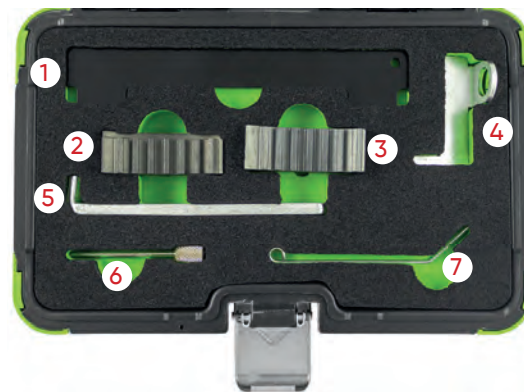

53316

34,00€

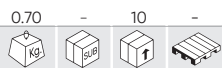

COFFRET DE CALAGE POUR FIAT/OPEL/VAUXHALL 2.2 16V CHAÎNE

MARQUES	OPEL: ASTRA-G (2000-2006), ASTRA-H (2006-2011), SIGNUM (2003-2008), VECTRA-B (2000-2002, VECTRA-C (2002-2008), ZAFIRA-A (2000-2005), ZAFIRA-B (2005-2012), SPEEDSTER (2000-2006). VAUXHALL: VX220 (2000-2006). FIAT: CROMA (2005-2009).
OUTILS OEM	VAUXHALL / OPEL: Z22SE, Z22YH FIAT: 194A1.000.



53317

34,00€

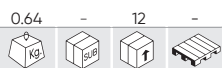

OPEL/VAUXHALL 2.2 BLOQUEUR DE POMPE À ANTIGEL

MARQUES	OPEL 2.2 Chaîne VAUXHALL 2.2 Chaîne
---------	--



53452

26,50€



COFFRET DE CALAGE POUR OPEL/FORD/FIAT/ ALFA ROMEO/LANCIA/SUZUKI

MARQUES	VAUXHALL/OPEL 1.3 CDTI: AGILA, CORSA, COMBO (03-08), ASTRA-H(05-08), MERIVA, TIGRA-B(04-08) SUZUKI 1.3 DDIS: IGNIS, WAGON R(03-08), SWIFT(04-08) FORD: 1.3 TDCI FIAT/ALFA ROMEO/LANCIA: 1.3 JTD MULTIJET
OUTILS OEM	104-A EN 46781 (1) , EN 46785 (2)

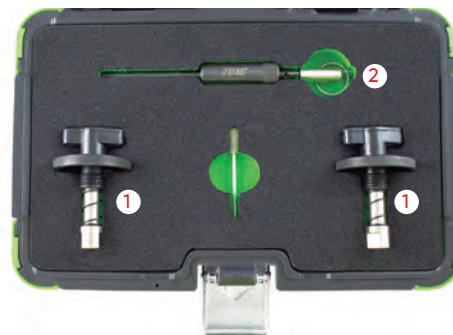

53651

91,00€



COFFRET DE CALAGE POUR OPEL/VAUXHALL 1.0, 1.2, 1.4 TURBO

MARQUES	OPEL: ADAM, AMPERA, ASTRA-J, AVEO, CORSA-D, INSIGNIA, MERIVA-B, MOKKA, ZAFIRA-C TOURER
OUTILS OEM	EN 49977-100 (1), EN 49977-200 (2), EN 49978 (3), KM 952 (4), KM 953-A (5), KM 955-1 (6), KM 955-2 (7).
CODES MOTEUR	1.0: A10XEP (LDB) 1.2: A12XEL (LWD), A12XER (LDC) 1.4: A14XEL (L2Z), A14XER (LDD), LDU A14NEL (LUH), A14NET (LUJ), TWINPORT / ECOFLEX ENGINES A14XFL (LUU), A14NEL (LDD), A14NEL (LUJ), A12XEL (L2Q)



54205

49,00€



COFFRET DE CALAGE POUR AUXHALL/OPEL 1.6 CDTI

MARQUES	VAUXHALL/OPEL: Astra J (13-18), Astra K, (15-19), GTC (15-18), Insignia A (15-17), Insignia- B (17-20), Meriva B (13-17), Mokka (14-16), Mokka X (16-20), Zafira C Tourer (13-19).
OUTILS OEM	EN-6349, EN-6130 (1), EN-51143 (2), EN-51140 (3), EN-50513 (4), EN-51188 (5)
CODES MOTEUR	B16DTC, B16DTE, B16DTH, B16DTJ, B16DTL, B16DTN, B16DTR and B16DTU. D16DTH,D16DTI,D16DTJ,D16DTN, D16DTR,D16DTU

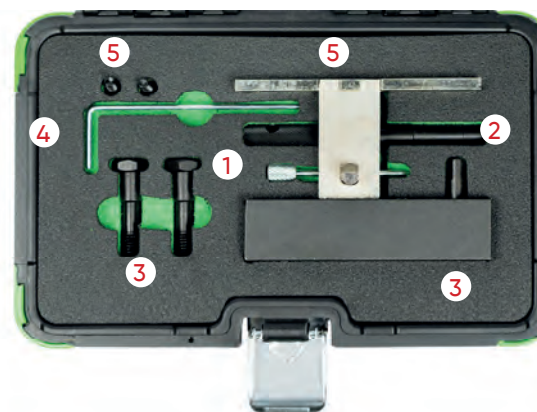

54214

96,00€



COFFRET DE CALAGE OPEL/ISUZU 1.6D, 1.7D

MARQUES	ASTRA, CAVALIES, VECTRA-A(87-00), ISUZU, NOVA, CORSA / COMBO, STRA, CAVALIER, VECTRA, FRONTERA, MONTEREY, MIDI, BRAVA (88-04)
OUTILS OEM	VAS 6079 (1), KM 951 (2), KM 851 (3), 23-029 (4), KM 661-2 (5), KM 661 (6)
CODES MOTEUR	OPEL : 16DA, 17D, 17DR, X17DTL ISUZU : 4EC1, 4EE1, 4JB1, 4XJ1, 4JA1, 4JG1, 4FC1, 4FD1, 4FG1, Z17DT, Y17DT/DTL

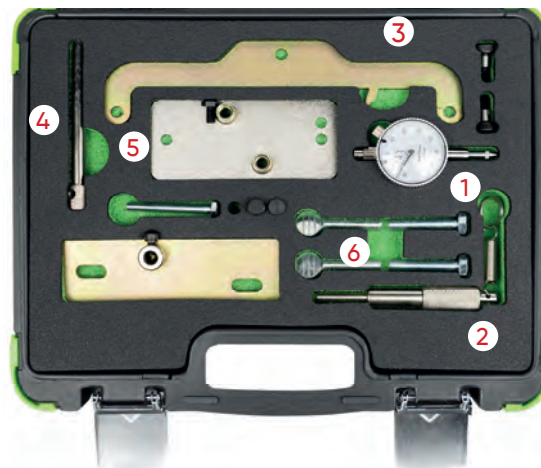

54217

104,00€



COFFRET DE CALAGE POUR VAUXHALL/OPEL/SAAB 2.0, 2.2 DTI

MARQUES	VAUXHALL/OPEL: ASTRA-G (98-06), FRONTERA-B (98-04), OMEGA-B, (98-03), SIGNUM (03-05), SINTRA (98-99), VECTRA-B (97-02), VECTRA-C (02-05), ZAFIRA-A (99-05), SAAB: 9-3 (98-04), 9-5 (02-06)
OUTILS OEM	SAAB: 83 95 394 (1), 83 95 337 (2), 83 95 352 (3), 83 95 386 (4) VAUXHALL/OPEL/SAAB: KM-927 (2), KM-929 (3), KM-932 (4), KM-933 (1)
CODES MOTEUR	OPEL: X20DTH,X20DTL,Y20DTH, Y20DTL, X22DYH,Y22DTH, Y22DTR SAAB: D223L



54221

111,00€



COFFRET DE CALAGE POUR VAUXHALL/OPEL 1.3 CDTI

MARQUES	VAUXHALL/ OPEL 1.3 CDTI Corsa E Diesel Engine From 2015
OUTILS OEM	KM-662-C (1), EN-50515 (2), EN-51500 (3), EN-46775 (4), KM-955-1 (5), EN-46785 (6)
CODES MOTEUR	LKU B13DTE, LKU B13DTR



54434

48,50€



KIT DE DISTRIBUTION POUR OPEL 1.0, 1.4

MARQUES	VAUXHALL/OPEL ADAM 2014 - 2019, ASTRA-K 2015 - 2019, CORSA-E 2015 - 2019, INSIGNIA-B 2017 - 2020, MOKKA X 2016 - 2019, VIVA (KARL) 2015 - 2020
OUTILS OEM	EN-51367 (1) EN-51298 (2) EN-51632 (3)
CODES MOTEUR	1.0 L5Q/B10XE, L5Q/D10XE, LE1/B10XFL, LE1/B10XFT, LE1/B10XFL, LE1/D10XFL, LE1/D10XFT, LE1/F10XFL, LE1/F10XFT, LWT/B10XL 1.4 LE2/B14XFL, LE2/B14XFT, LE2/D14XFL, LE2/D14XFT, LFE/B14XNT, LFE/D14XNT, LV7/B14XE 1.5 Lfv/B15XHT, Lfv/D15XHL, Lfv/D15XHT

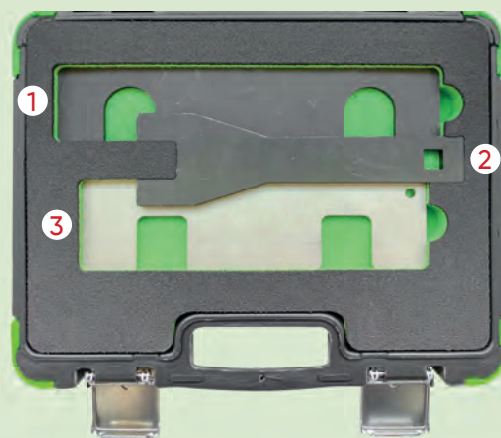

54435

14,50€



KIT DE DISTRIBUTION POUR OPEL/CHEVROLET/SAAB 1.4, 1.6, 1.8 ECOTEC

MARQUES	CHEVROLET: LACETTI (2005-2010), NUBIRA (2005-2010) OPEL/VAUXHALL: ASTRA-G (1998-2004), ASTRA-H (2004-2007), COMBO-C (2005-2012), CORSA-C (2000-2007), MERIVA-A (2003-2010), SIGNUM (2003-2007), TIGRA-B (2004-2010) VECTRA-B (1995-2002), VECTRA-C (2002-2008), ZAFIRA-A (1999-2005), ZAFIRA-B (2006-2013) SAAB: 9-3 (2003-2010)
OUTILS OEM	KM-911 (1) KM-6130 (2) KM-852 (3), EN-852 (3)
CODES MOTEUR	1.4: X14XE, Z14XE 1.6: X16SEJ, X16XEL, Y16XE, Z16XE, Z16YNG 1.8: F18D3 1.8: X18XE1, Z18XE, Z18XEL, X18E1 1.8: Z18XE

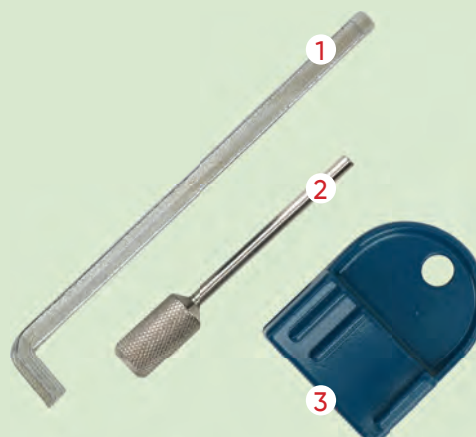

54436

124,00€



N

KIT DE DISTRIBUTION POUR OPEL 1.6 SIDI

MARQUES	VAUXHALL ASTRA-J 2013 - 2017,ASTRA-K 2015 - 2019,CASCADA 2013 - 2019,GTC 2015 - 2019,INSIGNIA 2013 - 2017,INSIGNIA-B 2018 - 2020,ZAFIRA-C TOURER 2014 - 2019
OUTILS OEM	EN 51153 (1) EN 50513 (2) EN 51148 (3) EN 51147 (4)
CODES MOTEUR	1,6 LWC/A16SHT LVP/A16XHT LWC/B16SHL LWC/B16SHT LVP/B16XHT LWC/D16SHJ LWC/D16SHL LWC/D16SHT

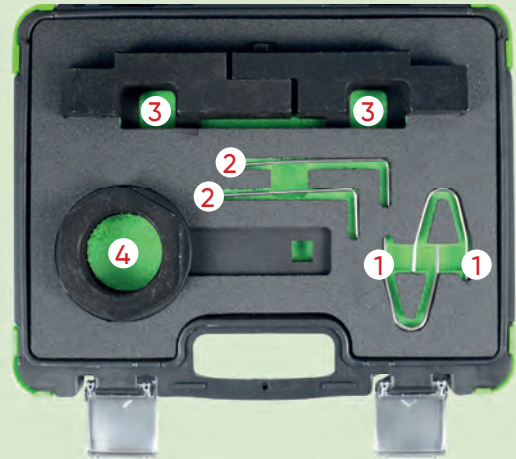

54437

110,00€

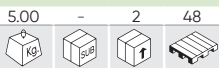

N

KIT DE DISTRIBUTION POUR OPEL/CHEVROLET/SAAB 2.0, 2.4

MARQUES	CHEVROLET CAPTIVA 2011 - 2015,HHR 2008 - 2009, MALIBU 2012 - 2015 SAAB 9-3 (02-12) 2010 - 2012,9-5 (10-12) 2010 - 2012 VAUXHALL/OPEL ANTARA 2011 - 2016,ASTRA-J 2012 - 2017,GTC (15-19) 2015 - 2019,INSIGNIA-A (08-17) 2008 - 2013
OUTILS OEM	EN-48585 (1) EN 43653 (2), J 43653 (2) EN 955 10 (3), KM 955 (3) EN-955-20 (4), KM 955-20 (4) EN 45027 1 (5), J 45027 1 (5) EN 45027 (6), EN45027 2 (6), J 45027 2 (6) EN 49212 (7), EN 49212 1 (7) EN 49212 (8), EN 49212 2 (8) EN 48953 (9)
CODES MOTEUR	LHU/A20NFT 2,0: LDK/A20NHT 2,0: LDK/A20NHT, LHU/A20NET, LHU/A20NFT, LHU/B20NFT 2,4: A24XE (LE5), A24XF (LE9) 2,4: LE5,LE9

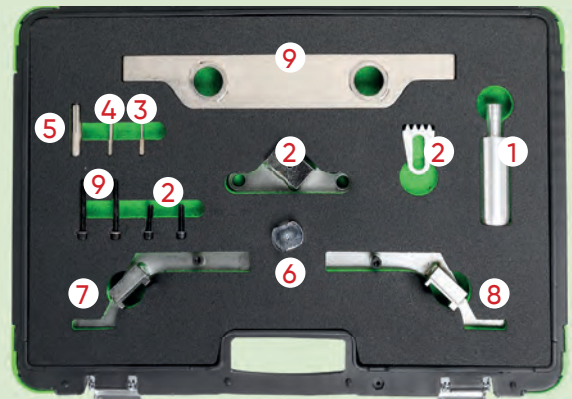

52271

18,00€

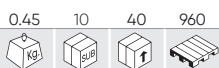

CALAGE DISTRIBUTION VAG

MARQUES	AUDI: A2 1.4TDI (02-06), A3 1.9, 2.0TDI (02-08), A4 1.6TDI (02-05), A4 1.9, 2.0TDI (04-08), A6 1.9TDI (02-05). SEAT: ALTEA 1.9SDI/TDI (05-08), LEON 1.9,2.0TDI (05-08), TOLEDO 1.9SDI/TDI (05-08). SKODA: FABIA 1.4TDI (03-06), OCTAVIA II 2.0TDI (03-06) VW :BEETLE 1.9TDI (02-08), BORA 1.9TDI (02-08), FOX 1.4TDI (02-08), GOLF 1.9, 2.0TDI (02-08), LUPO 1.4TDI (02-08), POLO 1.4, 1.9TDI (02-08), SHARAN 1.9TDI (02-08).
OUTILS OEM	AUDI: AMF, ASZ, ATD, AVB, AVF, AWX, AXR, AZV, BHC, BKC, BKD, BKE, BLB, BMN, BNA, BPW, BRB, BR, BRD, BRE, BRF, BUY, BVA, BVF, BVG. SEAT: BJB, BKC, BLS, BMM, BXE SKODA: AMF, AZV, BKD VW: AJM, AMF, ANU, ARL, ASZ, ATD, AUJ, AVB, AVF, AWX, AXR, BAY, BMS, BNM, BNV, BWB



51489

12,00€

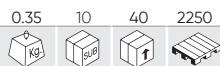

SET BLOCAGE ARBRE À CAMES VAG 1.4, 1.6



MARQUES	VW: LUPO 99 , POLO 95, CADDY 96, POLO CLASSIC, VARIANT 96, BEETLE 1.4L 99, GOLF 1.4L, 1.6L 98 Y 1.4L, BORA, 1.6L 99. AUDI: A2.
OUTILS OEM	T10016
CODES MOTEUR	1.4 / 1.6 16V

53274

30,50€



COFFRET DE CALAGE POUR VOLKSWAGEN/SEAT/SKODA 1,2L



MARQUES	VOLKSWAGEN 1.2: LUPO / POLO / EOS / FOX. SEAT 1.2: IBIZA / CORDOBA SKODA 1.2: FABIA
OUTILS OEM	T10123 (1) (2), T10120 (3), T10121 (4)
CODES MOTEUR	AWY / BMD / AZQ / BME.

53275

35,50€

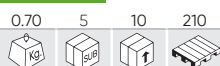

COFFRET DE CALAGE POUR VW-AUDI

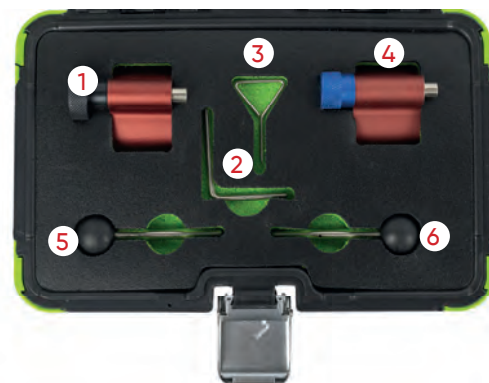

MARQUES	DODGE: CALIBER (06-11) FORD: GALAXY (02-06) MITSUBISHI: GRANDIS (05-10), LANCER (05-10), OUTLANDER (07-10). SEAT: ALHAMBRA (00-15), ALTEA/ALTEA XL (04-15), CORDOBA (02-09), IBIZA (02-15), LEON (00-13), TOLEDO (04-11). SKODA: FABIA (00-14), FABIA II (07-15), OCTAVIA (00-10), OCTAVIA II (04-15), PRACTIK (10-15), RAPID (11-15), ROOMSTER (07-15), SUPERB (02-08), SUPERB II (08-15), YETI (09-14). AUDI: A1 (10-15), A2 (00-06), A3 (01-13), A4/ALLROAD (01-16), A5 (08-15), A6 (11-14), TT (08-14), Q3 (11-15), Q5 (08-15), A6 (10-14). VOLKSWAGEN: AMAROK (10-16), BEETLE (02-15), BORA (02-08), CADDY/MAXI (03-15), EOS (06-15), FOX (05-11), GOLF (02-15), GOLF PLUS (05-14), JETTA (05-15), LUPO (02-05), PASSAT/CC (02-15), POLO (99-14), SCIROCCO (08-14), SHARAN (02-15), TIGUAN (07-15), TOURAN (03-15), TRANSPORTER (03-17).
OUTILS OEM	DODGE: 9882, 9883. FORD: 310-085/23-059, 303-1054. MITSUBISHI: MB995206, MB995208, MB995209. VAG: T10100 (4), T10050 (1), 3359 (3/6)/T20102, T10115 (3), T10060A (2)/T40098, T20167.
CODES MOTEUR	1.2D TDi CR: CFWA. 1.4D TDi PD: AMF, BAY, BMS, BNM, BNV, BWB. 1.6D TDi CR: CAYA, CAYB, CAYC, CAYD, CAYE, CLNA. 1.9D TDi PD: AJM, ANU, ARL, ASZ, ATD, AUY, AVB, AVF, AVQ, AWX, AXB, AXC, AXR, BJB, BKC, BLS, BLT, BMT, BPZ, BRM, BRR, BRS, BRU, BSU, BSV, BSW, BTB, BVK, BXE, BXF, BXJ. 2.0D TDi CR/TDi PD: AZV, BDJ, BDK, BEW, BGW, BHW, BKD, BKP, BKQ, BLB, BMA, BMM, BMN, BMP, BMR, BNA, BPW, BRA, BRC, BRD, BRE, BRF, BRT, BSS, BST, BSY, BUJ, BUZ, BVA, BVE, BVF, BVG, BVH, BWC, BWV, CAAA, CAAB, CAAC, CAAD, CAE, CAG, CAGB, CAGC, CAHA, CAHB, CBAA, CBAB, CBAC, CBBA, CBBD, CBDA, CBDC, CBEA, CCHA, CCHB, CDBA, CDCA, CEGA, CFCA, CFFA, CFFB, CFFD, CFFE, CFGB, CFGC, CFHA, CFHB, CFHC, CFHD, CFHE, CFHF, CFJA, CGLA, CGLB, CGLC, CGLD, CJAA, CJCA, CJC, CJCC, CLCA, CLCB, CLJA, CLLA, CNEA, ECD, ECD/BSY, ECD/BYL, ECE/BWD.

53276

160,00€



COFFRET DE CALAGE POUR AUDI SKODA

MARQUES	MOTOR AUDI, VW: V6 2.0, 2.8, 3.0T FSI. AUDI QS: 2.0, A6L 2.8, 3.0T.
OUTILS OEM	3418 (1), 3458 (2), T10100 (3), T10123 (4), T10121 (5), 3242 (6), 3551 (8), T10020 (9), T10098 (10), 3078 (12), 2064 (13), 3369 (14), T10092 (15), T40011 (17), 2065A (18), T10016 (19), 3359 (20), T10008 (21), T10050 (22) T10265 (23), T10264 (24), T10060A (25), T10120 (27), 3366 (28)
CODES MOTEUR	2.0, 2.8, 3.0



53277

45,00€



COFFRET DE CALAGE POUR COURROIE DE DISTRIBUTION VW-AUDI

MARQUES	ESSENCE	AUDI: 80, 100, A3, A4, A6 1.6, 1.8/TURBO, 2.0, 2.0 16V, A3, A4 1.6 (96-). SEAT: IBIZA/CORDOBA, TOLEDO, ALHAMBRA, INCA 1.6, 1.8, 1.8 16V, 2.0, 2.0 16V, IBIZA/ CORDOBA, LEON, TOLEDO 1.6 (99-), ALHAMBRA 2.0 (00-). VOLKSWAGEN: POLO CLASSIC, SCIROCCO, CORRADO, GOLF, JETTA, VENTO, PASSAT, SHARAN, TRANSPORTER 1.6, 1.8/TURBO, 1.8 16V, 2.0, 2.0 16V, POLO CLASSIC, GOLF, BORA, BEETLE 1.6 (97-), 2.0 (99-). SKODA: OCTAVIA 1.6 (97-), 2.0 (99-).
	DIESEL	AUDI: 80, 100, A3, A4, A6 1.9 TURBO D, 1.9TDI, 2.5TDI, A3, A4, A6 2.0TDI, A2, A3, A4, A6 1.2TDI, 1.4TDI, 1.9TDI (99-). SEAT: IBIZA/CORDOBA, LEON, TOLEDO, ALHAMBRA, INCA 1.7SDI, 1.9D/TD /SDI/TDI. EQRD: GALAXY (02-06). SKODA: FELICIA, OCTAVIA 1.9D/TDI. VW: POLO, POLO CLASSIC, GOLF, JETTA, VENTO, BORA, BEETLE, PASSAT, SHARAN, CADDY, TRANSPORTER 1.5D, 1.6D/ TURBO, 1.7D/SDI, 1.9SDI/TDI, GOLF, PASSAT 2.0TDI.
OUTILS OEM	T10020 (1), 3387 (2), V159 (3), T10060/T100604 (4), T10115 (5), T40011 (6)	
CODES MOTEUR	2.0, 2.8, 3.0	



53278

143,00€



COFFRET DE CALAGE POUR AUDI 2.8, 3.2 FSI, 3.0 TFSI

MARQUES	A2, A4, A4 QUATTRO, A6 (2004-2007) A2, A3, A4, A3 FSI (2004-2007) A4, A6, A8 3.2 FSI A6 L QUATTRO 2.4 A6 2.4, A6 2.4 QUATTRO (2004-2007) A4 3.2 FSI (2004-2007) A6 3.2 FSI (2004-2007) A8 3.2 FSI (2005-2007)
OUTILS OEM	T10172 (1), 3212 (2), T40070 (3), T40069 (4), T40071 (5), T10172/2 (6)
CODES MOTEUR	AUK / BDW / BDx / BKH / CAJA / CALA

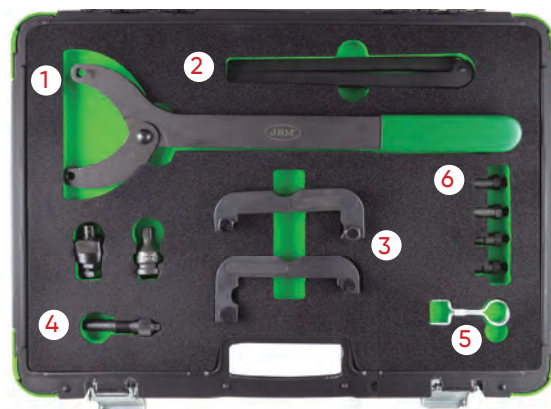

53279

97,00€

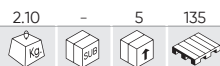

COFFRET DE CALAGE POUR VW/AUDI 1.8, 2.0, TSI, TFSI

MARQUES	AUDI: A3 (96-09), A4 (94-09), A6 (95-11), S3 (99-13), TT (98-14). SEAT: ALHAMBRA (97-10), ALTEA/ALTEA XL (06-09), CORDOBA (99-02), EXEO (09-10), IBIZA (99-02), LEON (99-13), TOLEDO (99-09). SKODA: OCTAVIA/OCTAVIA TOUR (98-10), OCTAVIA II (04-09). VOLKSWAGEN: BEETLE (99-11), BORA (97-04), EOS (06-10), GOLF (97-12), GOLF PLUS (05-09), JETTA (05-09), PASSAT (96-10), SCIROCCO (09-14), SHARAN (97-10), TOURAN (03-09).
OUTILS OEM	T10020 (1), T10252 (2), T10092 (3), T10115 (4), T40011 (4), 3366 (5), T10060 (6)
CODES MOTEUR	1.8: ADR, AFY, AGN, AJP, APG, APT, AQE, ARG, ARH, AVV. 1.8T: AEB, AGU, AJH, AJL, AJQ, AMK, AMU, ANB, APP, APU, APX, APY, AQA, AQX, ARX, ARY, ARZ, AUM, AUQ, AVC, AWC, AWT, AWU, AYP, BAM, BFV, BVP, BVR. 2.0 TSI: AXW, BHD, BLR, BLX, BLY, BMB, BVX, BVY, BVZ. 2.0 TFSI/S/R/TSI: AXX, BPY, BWA, BGB, BPG, BPJ, BUL, BWE, BWT, BYK, BHZ, BZC, BWJ, BYD, CDLA, CDLB, CDLC, CDLD, CDLF, CDMA.



53280

112,00€

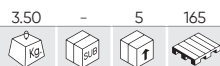

KIT ALIGNEMENT ARBRE À CAMES VW/AUDI 3.0 V6

MARQUES	AUDI: A4 (01-08), A6 (01-08), A8 (03-10).
OUTILS OEM	3387 (1), T40030 (2) (4), T40026 (3), T40028 (5)
CODES MOTEUR	3.0 V6 30V: ASN, AVK, BBJ, BGN.



53281

55,00€



COFFRET D'ALIGNEMENT ARBRE À CAMES VW/AUDI

MARQUES	VOLKSWAGEN: 2.5 TDi V6 AUDI: A4, A6, A8
OUTILS OEM	3369 (1), 3242 (2), 3458 (3)
CODES MOTEUR	AFB/AKN



53282

48,00€

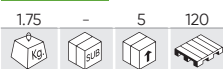

KIT FRETWORK GROUPE VAG 1.2, 1.4, 1.6

MARQUES	SEAT: ALHAMBRA (10-15), ALTEA/ALTEA XL (08-15), IBIZA/ CORDOBA (08-12), LEON (07-13), TOLEDO (07-15). VOLKSWAGEN: BEETLE (11-15), CADDY/CADDY MAXI (10-15), EOS (06-12), GOLF (03-12), GOLF PLUS (03-14), GOLF V ESTATE (07-13), GOLF VI CABRIOLET (10-15), JETTA (06-14), PASSAT (05-11), POLO (02-14), SCIROCCO (08-12), TIGUAN (07-12), TOURAN (03-15). SKODA: FABIA II (07-15), OCTAVIA II (04-15), PRAKTIK (10-15), RAPID (12-15), ROOMSTER (06-15), SUPERB II (09-14), YETI (09-14). AUDI: A1 (10-15), A3 (03-13).
OUTILS OEM	T10171 (1), T10170 (2), T40011 (3)
CODES MOTEUR	1.2 TFSI: CBZA, CBZB, CBZC. 1.4 FSI: AXU, BKG, BLN. 1.4 TFSI: BLG, BMY, BWK, CAVA, CAVB, CAVC, CAVD, CAVE, CAVF, CAXA, CAXC, CDGA, CSMA. 1.6 FSI: BAG, BLF, BLP, BTS.



53283

92,00€



KIT DE CALE GROUPE VAG 2.7, 3.0 TDI

MARQUES	VOLKSWAGEN: TOUAREG, PHATEON VAG: DIESEL 2.7 / 3.0 V6 AUDI: A4, A5, A6
OUTILS OEM	3242 (1), T40060 (2) (3), 3359 (4), T40058 (5), T40061 (6), T40062 (7), T40049 (8)
CODES MOTEUR	ASB, BKN, BKS, BWZ, BNG, BPP, BSG, BUG, BUN, CAWA, CAMB, CANA, CANB, CANC, CAND, CAPA, CARA, CARS, CASA, CASE, CASC, CAM, CC/HA, CCWA, CCWB, CDYA, CDVB, CDVC, CEXA, CGKA, CGKB.

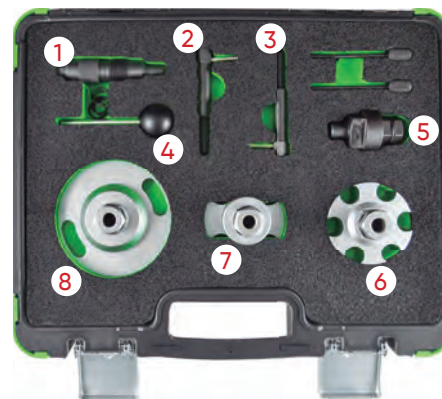

53284

306,00€



KIT FRETWORK GROUP VAG 2.5 TDI

MARQUES	VOLKSWAGEN: TOUAREG (03-10), TRANSPORTER (03-09).
OUTILS OEM	T10225 (1), T10199 (2), T10234 (3), T10226 (4), T10193 (5), T10194 (6), T10199/01 (7), T10226 (8)
CODES MOTEUR	2.5D TDI PD: AXD, AXE, BAC, BLJ, BLK, BNZ, BPC, BPD, BPE.

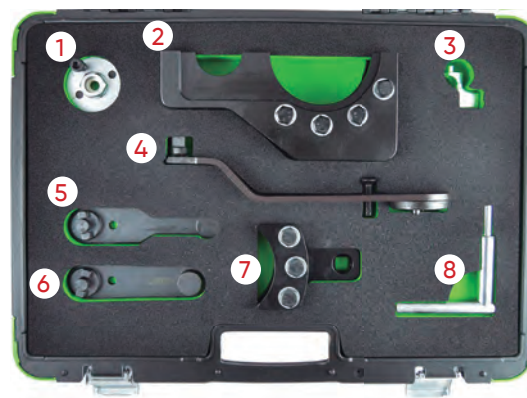

53285

56,00€

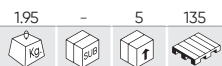

COFFRET DE CALAGE POUR VAG 2.4, 2.5, SDI, TDI

MARQUES	VOLKSWAGEN: CRAFTER (06-13), LT (96-06), TRANSPORTER (90-03).
OUTILS OEM	2065A (1), T50009 (2), T10025 (3), 3248/3419 (4), 2064 (5), 3355 (6)
CODES MOTEUR	2.4D: AAB, AJA. 2.5D SDI: AGX. 2.5D TDI: ACV, AHD, AHY, AJT, ANJ, APA, AUF, AVR, AXG, AXL, AYC, AYY, BBE, BBF. 2.5D TDI CR: BJJ, BJK, BJL, BJM.



53286

87,00€



COFFRET DE CALAGE POUR VAG 1.8, 2.0 TSI, TFSI

MARQUES	VOLKSWAGEN: 1.8 / 2.0 TSI / TFSI.
OUTILS OEM	T10368 (2), T10354 (3), T40271 (1)(4), T10352/2 (5), T10352/1 (6), T10352 (7), T40196 (8) (9) (10) (11), T40267(12) (13), T40098 (14), T10060A (15), T40011 (15)
CODES MOTEUR	BYT, BZB, CABA, CABB, CABD, CADA, CAEA, CAEB, CAWA, CAWB, CBFA, CCTA, CCZA, CCZB, CCZC, CDAA, CDAB, CDHA, CDHB, CDNB, CDNC, CDND, CESA, CETA, CFKA, CGYA, CJEB, CJBA, CJSB.

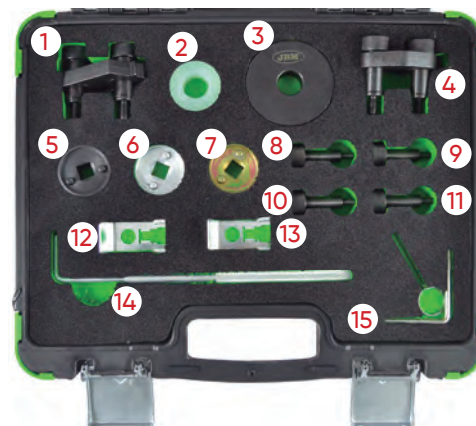

53287

245,00€



COFFRET DE CALAGE POUR VW/AUDI 1.8, 2.0 TURBO

MARQUES	VOLKSWAGEN AUDI	1.8 / 2.0 TURBO
OUTILS OEM	T10355 (1), T40196 (2), T40271 (3) (4), T10352 (5), T10352/1 (6), T10352/2 (7), T10368 (7), T40267 (8), T10354 (9), T40265 (10), T40011 (11) (14), T40098 (12), T10060A (13)	
CODES MOTEUR	BYT, BZB, CABB, CABD, CADA, CAEA, CAEB, CAWA, CAWB, CBFA, CCTA, CCZA, CCZB, CCZC, CDAA, CDAB, CDHB, CDNB, CDNC, CDND, CESA, CETA, CFKA, CGYA, CJEB, CJSB, CJSB.	

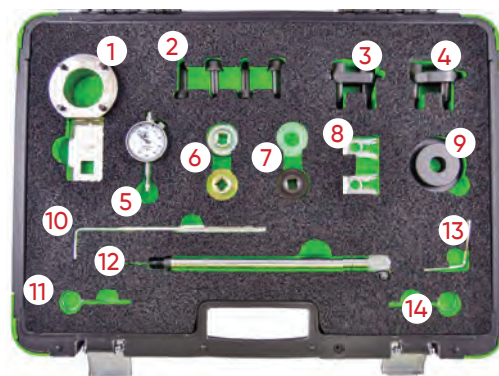

53288

72,00€



COFFRET DE CALAGE POUR VAG 1.6, 2.0 TDI COMMON RAIL

MARQUES	SEAT: EXEO, LEON, ALTEA, TOLEDO, IBIZA. VOLKSWAGEN: JETTA, TOURAN, GOLF, GOLF PLUS, POLO, PASSAT, TIGUAN, SCIROCCO. SKODA: ROOMSTER, FABIA, PRAKTIK, OCTAVIA, YETI, SUPERB. AUDI: A1, A3, A4, A5, Q5, A6, TT.
OUTILS OEM	T10264 (1), T10265 (2), T20102 (3), T10052 (4), T10051 (5), T10255 (6), T10050 (7), T10100 (8), T40098 (9)
CODES MOTEUR	1.2 TDI CR, 1.6 D TDI CR, 2.0 D TDI CR CAGA, CAGB, CAGC, CAHA, CAHB, CFHC, CBAA, CBAB, CFFB, CGLA, CGLB, CJCA, CJC B, CAAA, CBAA, CBAB, CBAC, CBBA, CBBB, CBDA, CBDB, CBD C, CCHA, CEGA, CJAA, CAAB, CAAC, CFJA, CFWA, CAYB, CAYC, CAYA.



53320

12,00€

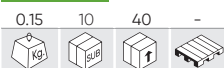

OUTIL BLOQUAGE ARBRE A CAME GROUPE VAG

MARQUES	SEAT: ALHAMBRA, ALTEA, AROSA, CORDOBA, IBIZA, LEON, TOLEDO 1.4/1.9/2.0 TDI. VW: PASSAT 1.9. AUDI: A4/A6 1.9.
OUTILS OEM	T10008, T20102, T10100.



53321

10,50€

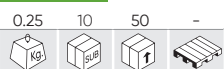

OUTIL RÉGLAGE DE TENSION POUR COURROIE VAG

MARQUES	AUDI: A4/1.8T, 2.0 1999-2004 A6/1.8T 2002-2004 A4/3.0 (2002 -), A6/3.0 (2002 -), A8/7.0 (2003 -). VW: GOLF PASSAT 2.0 TDI DIESEL, GOLF 88-97, PASSAT 92-97, VW T4/2.0 1992-2004.
OUTILS OEM	T10020



53325

7,50€

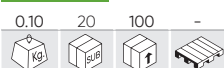

OUTIL POUR SYNCHRONISATION DE POULIE VW AUDI 35MM

MARQUES	AUDI: 100 ('91-), A6 (2.5 TDI) 2.3, 2.4, 2.5, 2.8, 2.9D TDI (1991-2003) VW: LT, TRANSPORTER
OUTILS OEM	3355
CODES MOTEUR	AAB, AAT, ACU, ACV, AEL, AET, AGX, AHG, AHY, AJA, AJT, ANJ, APA, APL, AUF, AVT, AXG, AXL, AYC.



53326

16,00€

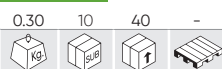

KIT DE VÉROUILLAGE DE CHAINES POUR VW/AUDI

MARQUES	VW: V6 2.5TDi. AUDI: V6 2.5TDi, V8 3.3TDi.
OUTILS OEM	3458 (1), 3242 (2)



53327

11,00€

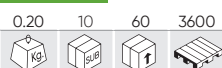

KIT DE VÉROUILLAGE DE CHAINES POUR VAG 1.2

MARQUES	SEAT: IBIZA 1.2 6V/3CYL (2002-09), CORDOBA 1.2 12V/3CYL (2002-13). VW: POLO 1.2 6V-12V/3CYL (2002-14). SKODA: FABIA 1.2 6V-12V/3CYL (2002, 2003-), FABIA II 1.2 6V/3CYL (2007-13), ROOMSTER 1.2 12V/3CYL (2006-13), PRAKTIK 1.2 6V/3CYL (2007-13).
OUTILS OEM	T10123
CODES MOTEUR	1.2 6V: AWY, BMD, BBM, CHFA, CHFB 1.2 12V: AZQ, BME, BVX, BZG, CEVA, CGPA, CGPB, CGPC.



53648

107,00€



COFFRET DE CALAGE POUR VAG 1.0, 1.2, 1.4 TSI

MARQUES	AUDI: A1 (12-15), A1 SPORTBACK (12-15), A3 (13-15), A3 SPORTBACK (12-15). SEAT: IBIZA (12-15), LEON (12-15), TOLEDO (12-15). SKODA: FABIA (10-13), OCTAVIA II (10-13), OCTAVIA III (10-15).
OUTILS OEM	T10060A (1), T10340 (2), T10476 (3), T10494 (4), T10499 (5), T10504/1 (6), T10504 (7), T10504/2 (8).
CODES MOTEUR	1.2 TSI: CJZA, CJZB. 1.4 TSI: CGGA, CHPA, CMBA, CPVA, CRJA, CXSA. 1.4 TSI ACT: CPTA.

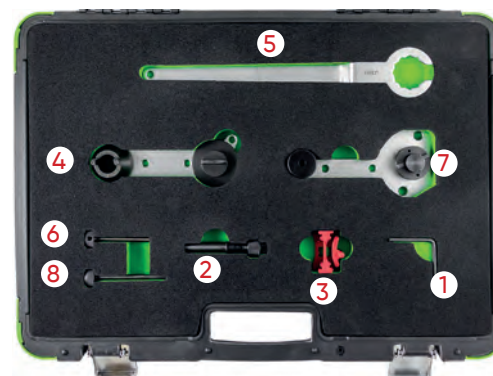

53649

89,00€



COFFRET DE CALAGE VAG GROUP

MARQUES	AUDI SEAT	SKODA VW
OUTILS OEM	T10340 (1), T10476 (2), T10477 (3), T10487 (4), T10494 (5), T10499 (6)	
CODES MOTEUR	1.0 MPI: CHYA. 1.0 TSI: CHZE, CHZC, CHZA, CHZB, CHZC, CHZD, CHZJ. 1.2 TSI: CJZB, CJZC, CYVA, CJZA, CJZD, CYVB. 1.4 TSI: CZCC, CMBA, CZCA, CHPA, CPTA (ACT), CZDA, CVNA, CZEA (ACT).	

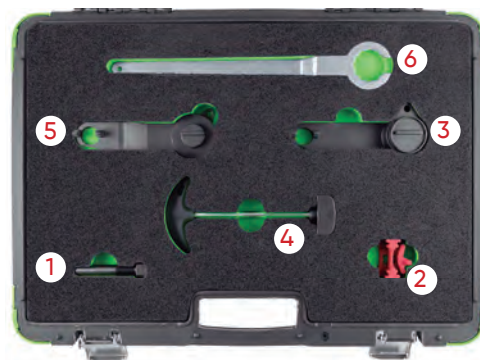

53706

98,00€

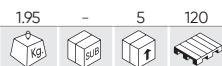

COFFRET DE CALAGE L'ARBRE DE DISTRIBUTION VAG 1.4, 1.6, 2.0 TDI COMMON RAIL

MARQUES	VOLKSWAGEN: GOLF ALLTRACK, GOLF SPORTSVAN, GOLF VII, GOLF VII KOMBI, PASSAT, POLO. AUDI: A1, A1 SPORTBACK, A3, A3 CABRIOLET, A3 LIMOUSINE, A3 SPORTBACK, TT, TT ROADSTER. SEAT: IBIZA, IBIZA V SPORTCOUPE, IBIZA V ST, LEON, LEON SC, LEON ST, TOLEDO IV. SKODA: FABIA, FABIA KOMBI, OCTAVIA, OCTAVIA COMBI, RAPID, RAPID SPACEBACK.
OUTILS OEM	OEM 3204 (1), OEM 3359 (2), OEM T10490 (3), OEM T10051 (4), OEM T10060A (5), OEM T10264 (6), OEM T10265 (7), OEM T10492 (8), OEM T40098 (9).
CODES MOTEUR	1.4, 1.6, 2.0 TDI CR CXXB, DBKA, DCXA, CGLE, CKFB, CKFC, CLHA, CLHB, CNHA, CNHC, CRBD, CRFA, CRFC, CRKA, CRKB, CRLB, CRLC, CRMB, CRUA, CRVA, CRVC, CSUA, CSUB, CUNA, CUPA, CUSA, CUSB, CUTA, CUUD, CXEB, DBKA, DCXA, DCZA, DFSD.

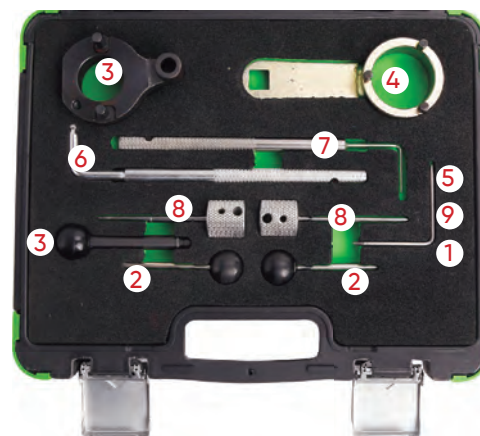

54092

24,00€



COFFRET DE CALAGE POUR MOTEUR 1.2 TFSI PAR VAG

MARQUES	AUDI: A1, A3, A3 SPORTBACK, A3 CABRIO SEAT: ALTEA, ALTEA XL, IBIZA, LEON, TOLEDO SKODA: FABIA II, OKTAVIA II, PRAKTIK, RAPID, RAPID SPACEBACK, ROMMSTER, YETI VW: BEETLE, CADDY, CADDY MAXI, GOLF PLUS, GOLF VI, GOLF VI CABRIO, GOLF VI ESTATA, JETTA, POLO, TOURAN
OUTILS OEM	T10340(1), T10414(2), T10341(3)
CODES MOTEUR	CBZA, CBZB, CBZC



54199

94,00€

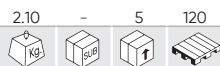

COFFRET DE CALAGE POUR VAG TFSI, FSI

MARQUES	AUDI: A1 (10-15), A1 SPORTBACK (10-15), A3 CABRIOLET (10-13), A3 (10-15), A3 SPORTBACK (03-13) SEAT: ALTEA/ALTEA XL (10-15), IBIZA (10-15), LEON (10-13), TOLEDO (12-15) SKODA: FABIA II (10-15), PRAKTIK (10-15), RAPID (12-15), RAPID SPORTBACK (12-15), OCTAVIA II (04-13), YETI (09-15), YETI OUT-DOOR (13-15) VW: BEETLE (11-15), CADDY/CADDY MAXI (10-15), EOS (07-15), GOLF V (03-13), GOLF V ESTATE (07-09), GOLF VI (10-13), GOLF VI ESTATE (10-13), GOLF VI CABRIOLET (11-15), GOLF PLUS (05-14), JETTA (05-14), PASSAT (05-15), POLO (09-14), SCIROCCO (08-14), TIGUAN (07-15), TOURAN (03-15)
OUTILS OEM	T10414 (1), VAS 6079 (2), T10170 (3), T10171/ T10171A (4), T40011 (5), T10340 (6), T10341 (7)
CODES MOTEUR	1.2 TFSI: CBZA, CBZB, CBZC 1.4 FSI/TFSI: BLG, BMY, BWK, CAVA, CAVB, CAVC, CAVD, CAVE, CAVF, CAXA, CAXC, CDGA, CSMA 1.6 FSI: BAG, BLF, BLP



54218

142,00€



COFFRET POUR AMORTISSEUR DE VIBRATIONS DU GROUPE VAG

MARQUES	AUDI, SEAT, SKODA, VOLKSWAGEN
OUTILS OEM	T10531/1 (1), T10531/2 (2), T10531/3 (3), T10531/4 (4)
CODES MOTEUR	1.8L TFSI: BZB, CDAA, BPU, BYT, CABA, CABB, CDHA, CDHB, CABD, DAJB, CJSJA, CJSB, CJEB, CJEE, CJED, CYGA, CDAC, CJSC, CGYA, DAJA 2.0L TFSI: CAWB, CCZA, CBFA, CCTA, CDNB, CDNC, CDND, CJXA, CJXE, CJXH, CHHB, CHHA, CULA, CFKA, DEDA, CHJA, CAWA, CCZC, CCZD, CPSA, CJK, CJKB, CESA, CETA, CFPA, CNCD, CPLA, CYRB, CYRC; CNCE, CYNB, CYP, CULB, CULC, CNCB, CWZA, CJXF, CJXC, CJXB, CJXG, CHHC, CCZB



54407

397,00€



KIT D'OUTILS DE MONTAGE D'ARBRE À CAMES POUR VAG/PORSCHE

MARQUES	AUDI, PORSCHE, SEAT, SKODA, VOLKSWAGEN 1.2 - 1.6 - 2.0 - 2.7 - 3.0 - 4.0 - 4.2 COMMON RAIL
OUTILS OEM	T40094, T40094/1 (1), T40094/2 (2), T40094/3 (3), T40094/4 (4), T40094/5 (5), T40094/6 (6), T40094/7 (7), T40094/8 (8), T40094/9 (9), T40094/10 (10), T40094/11 (11), T40094/12 (12), T40095 (13), T40096 (14), T40096/1 (15)
CODES MOTEUR	ASB, ASE, BKN, BKS, BMK, BNG, BPP, BSG, BTR, BUG, BUN, BVN, CAAA, CAAB, CAAC, CAAD, CAAE, CAGA, CAGB, CAGC, CAHA, CAHB, CAMA, CAMB, CANA, CANB, CANC, CAND, CAPA, CARA, CASA, CASB,CASC, CASD, CATA, CAYA, CAYB, CAYC, CAYD, CAYE, CBAA, CBAB, CBAC, CBBA, CBBB, CBDA, CBDB, CBDC, CCEA, CCFB, CCHA, CCHB, CCLA, CCMA, CCWA, CCWB, CDBA, CDCA, CDSB, CDTA, CDTB, CDUC, CDUD, CDYA, CDYB, CDYC, CEGA, CEXA, CFCA, CFFA, CFFB, CFFD, CFFE, CFGB, CFGC, CFGD, CFHA, CFHB, CFHC, CFHD, CFHE, CFHF, CFJA, CFWA, CGKA, CGKB, CGLA, CGLB, CGLC, CGLD, CGLF, CGQB, CJAA, CJCA, CJCB, CJCC, CJCD, CJGA, CJGC, CJGD, CJMA, CKDA, CKTB, CKTC, CKUB, CKUC, CKVB, CKVC, CLAA, CLAB, CLCA, CLCB, CLJA, CLLA, CLNA, CLZB, CMEA, CMFA, CMFB, CMGB, CMHA, CNEA, CNFA, CNRB, CRCA,CSHA, M05/9D(CAS), M05/9E, M05/9E(CRCA), M05/9E(CRCB)

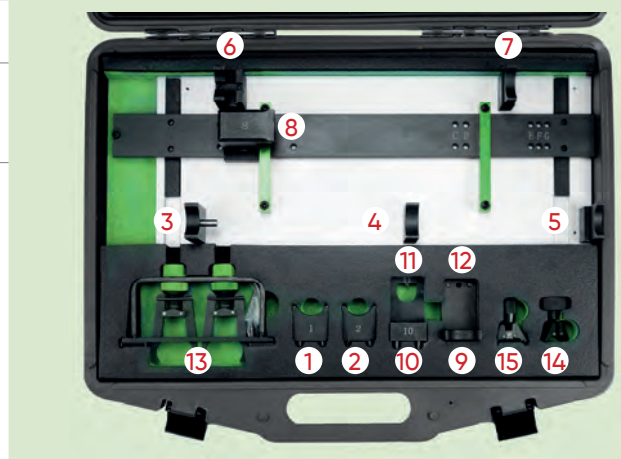

54408

46,00€



N

JEU D'OUTILS DE CALAGE DU MOTEUR VAG DIESEL 1.7, 1.9, SDI, TDI

MARQUES	AUDI: A3, A4, A6, CABRIOLET, SEAT: ALHAMBRA, AROSA, CORDOBA, IBIZA, INCA, LEON, TOLEDO, SKODA: FELICIA, OCTAVIA VW: BORA, CADDY, FOX, GOLF, LT, LUPO, PASSAT, POLO, SHARAN, TRANSPORTER, VENTO
OUTILS OEM	T1020 (1), 2587 (2), 2065A (3), T20044 (4), T10098 (5), T40011 (6), 2064 (7), T3359 (8), T10092 (9), M5x60M (10)
CODES MOTEUR	1.7TDi/SDi: AHB, AHG, AKU, AKW 1.9TDi/SDi: 1X, 1Y, 1Z, ABL, AAZ, AEF, AEY, AFF, AFN, AGD, AHF, AHH, AHU, AGP, AGR, ALE, ALH, AQM, ASV, ASY, ASX, AVG, AYQ 2.4D: 1G, 1S, DW, DV, ACL, ACT

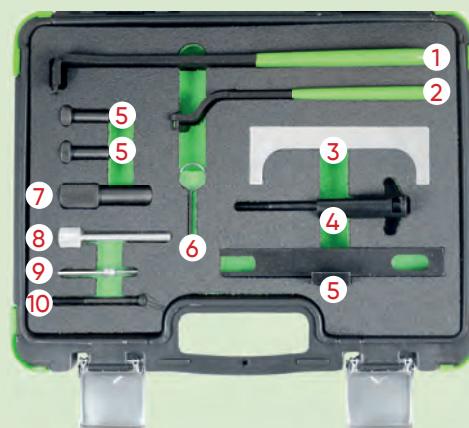

54409

32,00€



N

KIT DE DISTRIBUTION POUR VAG 1.4 TSI

MARQUES	ATECA (2016-) A3 (2012-) SUPERB (2015-) A1 SPORTBACK (2012-2018) LEON/LEON ST (2012-2020) MK5 (2012-2018) Q2 (2016-) Q3 (2015-2018)
OUTILS OEM	T10340 (1) T10504 (2) T10504/1 (3) T10504/2 (4)
CODES MOTEUR	1.4 TFSI (CoD)-CPTA, CZEA 1.4 TSI (ACT)-CPTA, CZEA



54410

33,50€



N

KIT DE DISTRIBUTION POUR VAG 2.4, 3.2 FSI

MARQUES	AUDI: A4, A5, A6, A7, A8, Q5, Q7, R8, RS4, RS5, RS6, S4, S5, S6, S8 VW: TOUAREG
OUTILS OEM	T40058 (1) T40069 (2) T40071 (3) T40133 (3) T40133/1 (3) T40133/1/2 (3) T40133/2 (3) 40071 (4)
CODES MOTEUR	2.4: BDW 3.2: AUK, BKH, BPK 4.2: BAR, BNS, BVJ, CAUA, CDRA, CFSA, BYH, CNDA 5.0: BUH 5.2: BSM, BUJ, BXA, CMPA, CTPA, CTYA

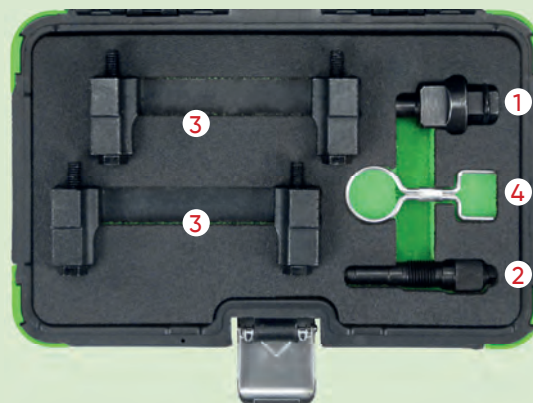

54411

36,00€



N

KIT DE DISTRIBUTION POUR VAG/PORSCHE 2.4, 2.8, 3.0 TFSI

MARQUES	AUDI: A4 (2011-2015) A5 (2007-2017) A6 (2007-2018) A7 (2010-2018) A8 (2010-2018) A8 (2010-2018) Q7 (2010-2018) S4 (2009-2017) S5 (2010-2017) S5 (2010-2017) Q5 (2008-2017) SQ5 (2013-2018) PORSCHE: CAYENNE (2010-2014) PANAMERA 2011-2013 VAG: TOUAREG (2010-2014)
OUTILS OEM	T40133/1 (1) T40133/2 (2) T40058 (3) T40069 (4) T40071 (5)
CODES MOTEUR	AUDI: 2,5 CLXB, CAAA 2,8 BDX, CCDA, CCEA, CHVA, CJBA, CNYA 3,0 CAJA, CAKA, CCAA, CGEA, CGWA, CGWB, CGWC, CGWD, CGXB, CGXC, CHMA, CHMB, CJTB, CJTC, CJWC, CMDA, CMUA, CNA, CREA, CREC, CRED, CTTA, CTUA, CTUD, CTVA, CTWA, CTXA 3,2 CALA, CALB PORSCHE: 3,0 M06/EC VAG: 3,0 CJTA, CGFA

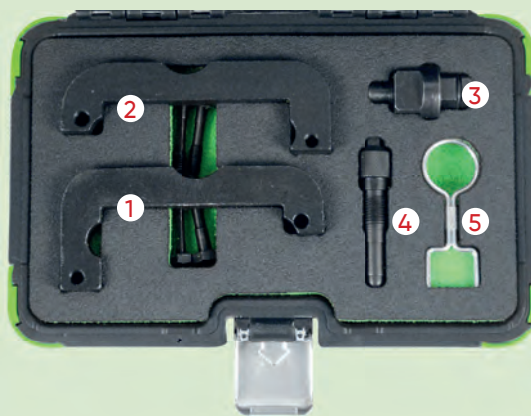

54412

57,00€



N

KIT DE DISTRIBUTION POUR AUDI 2.5 TFSI

MARQUES	AUDI: RSQ3 (2013-2015), RSQ3 (2015-2018), RS3 (2010-2013), RS3 (2015-2017), TT (2009,2014)
OUTILS OEM	T03003 (1) T40264/1/2 (2), T40264/2A (2) T40069 (3) T40011 (4) T40297 (5)
CODES MOTEUR	2,5 TFSI/RS CEPA, CEPB, CTSA, CZGA, CZGB

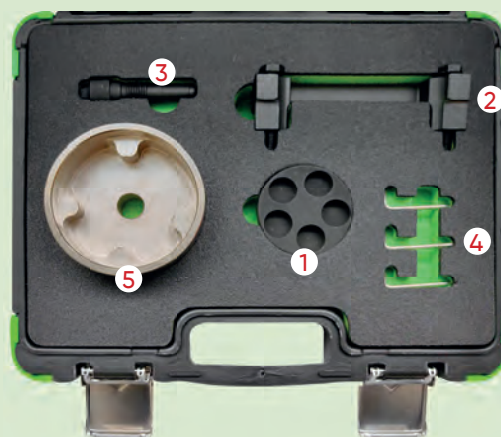

54413

115,00€



N

KIT DE DISTRIBUTION POUR AUDI 4.0 FSI, TFSI

MARQUES	AUDI: A8, RS6, RS7, S6, S7, S8 (2012-2018)
OUTILS OEM	T40071 (1) T40257 (2) T40264/1 (3) T40264/2 (4) T40264/3 (5) T40269 (6) T40272 (7)
CODES MOTEUR	CEUA CEUC CGTA CRDB CTFA CTGA CTGE CWUB CWUC DDTA

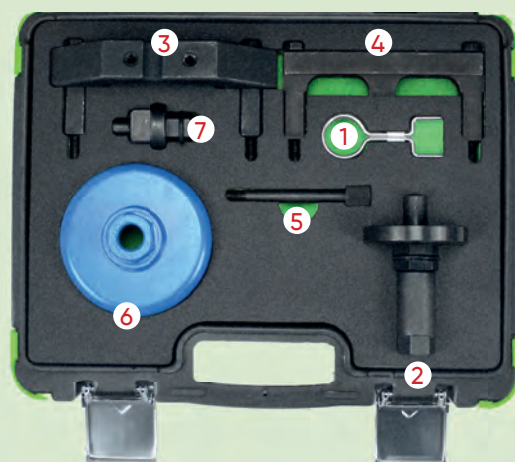

54431

184,00€



N

KIT DE DISTRIBUTION POUR ALFA ROMEO/MASERATI 2.9

MARQUES	ALFA ROMEO: GIULIA, STELVIO MASERATI: 3,8T
OUTILS OEM	1860815000 (1) 2024000090 (2) 2024100000 (3)
CODES MOTEUR	2.9: 670050436,670051007 ,670052721 ,670052722



53315

285,00€



COFFRET DE CALAGE POUR VOLVO 3.0, 3.2T6 / LAND ROVER 3.2

MARQUES	VOLVO: S60 (10-16), S80 (07-15), XC60 (08-15), XC70 (06-15), XC90 (10-14), V60 (10-15), V70 (10-15). LAND ROVER: FREELANDER II (11-14).
OUTILS OEM	VOLVO: 999-7263 (3), 999-7264 (1), 999-7272 (5), 999-7257 (2), 999-7261 (4). LAND ROVER: 303-1225 (3), 303-1226 (1), 303-1219 (2), 303-1223 (4).
CODES MOTEUR	3.0 TURBO: B6304T2, B6304T4. 3.2: B6324S, B6324S5. 3.2i6: B6324S.

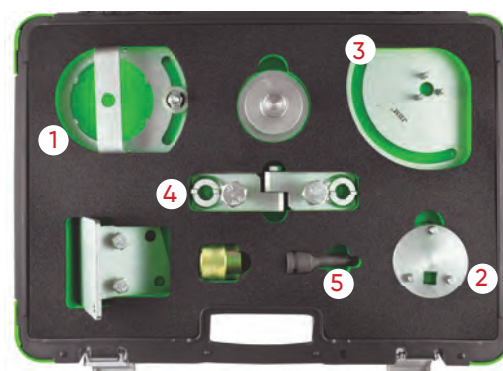

54226

71,00€



ENSEMBLE D'EXTRACTION POUR POULIE DE POMPE HAUTE PRESSION POUR HYUNDAI/KIA

MARQUES	HYUNDAI: ACCENT (11-15), ELANTRA (07-10), I20 (09-18), I20 (10-18), I20 COUPE (15-17), I30 (07-19), IX35 (10-16), I40 (11-18) KIA: CARENS (13-18), CEED (07-18), OPTIMA (11-15), PRO-CEED (08-19), RIO (09-17), CERATO (05-07), SOUL (09-14), SPORTAGE (10-18), VENGA (09-18)
OUTILS OEM	09331-2A000/2A010 (1), 09331-2A010 (1)
CODES MOTEUR	1.1D CRDI: D3FF 1.4D CRDI: D4FC(U1), D4FC(U2) 1.6D CRDI: D4FB(U1), D4FB(U2), D4FB-H(U1), D4FB-H(U2), D4FB-L(U1) 1.7D CRDI: D4FD(U2), D4FD-H(U2), D4FD-L, D4FD-L(U2)



54200

56,00€



KIT DE CALAGE POUR PORSCHE

MARQUES	911 (2001 - 2008), BOXSTER (2002 - 2011), CAYMAN (2006 - 2009)
OUTILS OEM	9685 (1), 9686 (2), 9595 (3), 9595/1 (4)
CODES MOTEUR	M96/03, M96/05, M96/23, M96/25, M97/20, M96/24, M96/26, M97/01, M97/21, M97/22.



51927

25,00€



KIT DE DÉMONTAGE ET TENSION DE COURROIES EN POLY-V



51340

39,30€



CLÉ UNIVERSELLE POUR ARBRE À CAMES + ADAPTATEURS



52616

44,00€

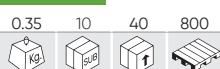

TENSIOMÈTRE POUR COURROIE DE DISTRIBUTION

- Deux échelles réglables (daN) avec lecture frontal et arrière.

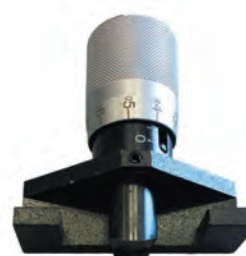

53769

178,00€

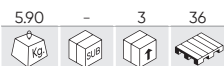

COFFRET DE CALAGE POUR RENAULT/NISSAN/OPEL/VOLVO

MARQUES	<p>RENAULT: AVANTIME, CLIO, ESPACE, KANGOO, LAGUNA, MASTER, MEGANE, MODUS, SCENIC, TWINGO, TRAFFIC. OPEL/VAUXHALL: MOVANO, VIVARO. DACIA: DOKKER, DUSTER, LOGAN, SANDERO. NISSAN: ALMERA, INTERSTAR, KUBISTAR, MICRA, NOTE, PRIMERA, QASHQAI. VOLVO: S40, V40</p>
OUTILS OEM	<p>MOT 1312 (1), MOT 1135-01 (2), MOT 1384 (3), MOT 1340 (4), MOT 1543 / KM-6234 / KV113 B0360 (5), MOT 1489 / KV113 B0130 (6), MOT 1536 / KM-6203 (7), MOT 1489 (8), MOT 1054 / KM-6031 / KV113 / B0280 (10), MOT 1318 (11), MOT 910 (12), MOT 910 (14), MOT 1386 (15), MOT 1534 / KM-6205 (16), MOT 1543 / KM-6234 / KV113 B0360 (17), MOT 1543 / KM-6234 / KV113 B0360 (18), MOT 1543 / KM-6234 / KV113 B0360 (19), MOT 1543 / KM-6234 / KV113 B0360 (20), MOT 1386 (22), MOT 1537 / KM-6204 (23), MOT 1348 (24), MOT 1538 (25), MOT 1337 (26), MOT 1496 / MOT 1750 (27), MOT 1490-01 (28), MOT 1200-01 (29)</p>
CODES MOTEUR	<p>PEROL: 2.0 16V, 2.5 20V, 1.4, 1.6 16V, 1.8, 2.0 16V, 1.2, 1.7, 1.8, 2.0 16V, 2.2 GASOIL: 1.9, 2.5, 2.8</p> <p>D4F702/706/708/712/714/716/722/728/730/740/764, D7F700/701/710/720/722/726/730/744/746/764/766, E7F700/704/706/750, E7J601/624/626/634/635/680/700/706/710/711/716/718/719/720/724/726/728/740/742/745/754/756/757/764/770/771/773/780, F3P670/682/700/704/706/708/710/712/714/720/724/755/758/760, F7P704/722, F3R611/722/723/728/729/750/751/752/791/796/797/798, F5R700/701/740, J7R732/733/734/735/768, F7R710/714, J7T600/760/761/762/766/772/780/782, N7Q704/710/711, N7U700/701, K4J700/710/711/712/713/714/715/730/732/740/750/770/780, K4M700/701/704/706/707/708/709/710/711/712/714/716/718/720/724/730/732/734/736/740/742/743/744/745/746/748/750/752/753/754/760/761/762/764/765/766/768/776/782/788/790/791/794/800/801/802/804/812/813/830, K9K700/702/704/706/710/712/714/716/718/722/724/728/729/732/734/740/750/752/760/762/764/766/768/802/804/806, F9Q610/650/664/670/674/711/716/717/718/720/722/730/731/732/733/734/736/738/740/744/748/750/752/754/758/759/760/768/762/770/772/774/780/782/784/786/788/790/799/800/803/804/808/812/816/818/820, G9T600/605/700/702/703/706/707/710/712/720/722/742/743/750, G9U720/724/726/730/750/754, F8M736/760, F8Q600/610/606/620/622/624/630/632/640/644/646/648/662/672/678/680/682/684/692/696/706/714/720/722/730/732/740/742/744/764/768/706/776/784/786/788, J8S620/621/622/758/760/776/778, G8T714/716/740/752/760/790/792/794, S8U720/722/730/731/742/748/750/752/770/772/780/782, S9U700/702/704/714/740, S9W700/702/206/208/212, E5F, E6J, K7M, F4P/F4R, FIN, F2N, F3N, F2R, F3P, F4P, F3R, J5T, J6R, J7R</p>

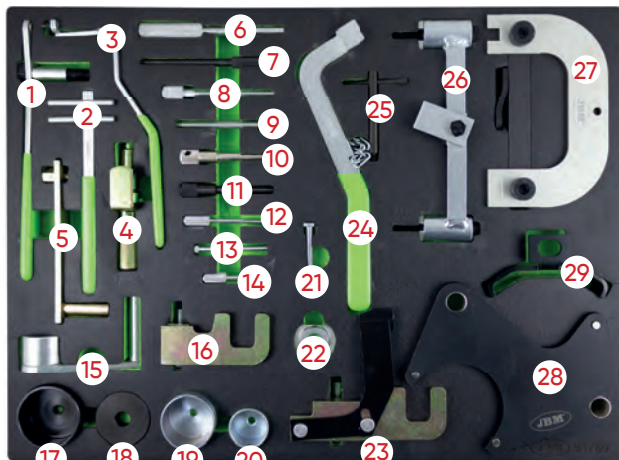

53773

298,00€



COFFRET DE CALAGE POUR FIAT/ ALFA/LANCIA/OPEL/SUZUKI/FORD

MARQUES	<p>ALFA: ROMEO 145, 146, 147, 155, 156, 159, 166, SPIDER, GTV, TS, GT, CROSSWAGON Q4 FIAT: PUNTO, GRANDE PUNTO, BRAVA, BRAVO, MAREA, WEEKEND, STILO, DOBLO, CARGO, IDEA, PANDA, MULTIPLA, PALIO, STILO, 500 LANCIA: LYBRA, YPSILON, THESIS, MUSA OPEL: CORSA, AGILA, MERIVA, COMBO, VECTRA, ZARA, ASTRA, INSIGNA, SIGNUM 19 CDTI SUZUKI: IGNIS, SWIFT, WAGON R+ FORD: KA</p>
OUTILS OEM	<p>1860874000 (1), 1860874000 (2), 2000004400 / 2190754400 (3), 1860863000 (4), 1860898000 (5), 2190754500 (6), 2000004300 (7), 1870900400 (8), 1860703000 (9), 1860933000 (10), 1860845000 (11), 1870900300 (12), 1860905000 / EN-46788 (13), 1895443000 (14), 1860992000 (15), 1870896900 (16), 1860987000 (17), 1860905000 (18), 1860771000 (19), 1860161000 (20), 1860876000 (21), 1860876000 (22), 1871000900 (23), 1860985000 (24), 2000004200 / 2190754200 (25), 1860965000 (29)</p>
CODES MOTEUR	<p>176B9.000, 182B2.000, 188A5.000, 843A1.000, 323.02, 371.01, 182B4.000, 182B9.000, 186A6.000, 188A2.000, 188A7.000, 188B2.000, 192A1.000, 192A3.000, 937A2.000, 939A1.000, 192A5.000, 192B1.000, 198A5.000, 937A5.000, 939A2.000, 325.01, 342.02, 362.02, 185A6.000, 841C.000, 841G.000, 939A3.000, 940A3.000, 940A4.000, 940A5.000, Z19DT/DTH/DTR/DTJ/DTL, 169A1.000, 955A4.000, 350A3.000, 192B4.000, 198A2.000, 350A2.000, 955A3.000, 192A8.000, 198A6.000, 198A3.000, 199B1.000, 199B2.000, 199A2.000, 199A3.000, 199A9.000, 188A3.000, 188A8.000, 188A9.000, 192A9.000, 186A8.000, 186A9.000, 199A5.000, 223A7.000, 223A9.000, 841H.000, 841P.000, 185A2.000, Z13DT, Z13DTJ, Z13DTH, 182A4.000, 182A6.000, 182B6.000, 178B3.000, 186A3.000, 186A4.000, 350A1.000, 169A4.000, 188A4.000, 199A4.000, 199A7.000</p>

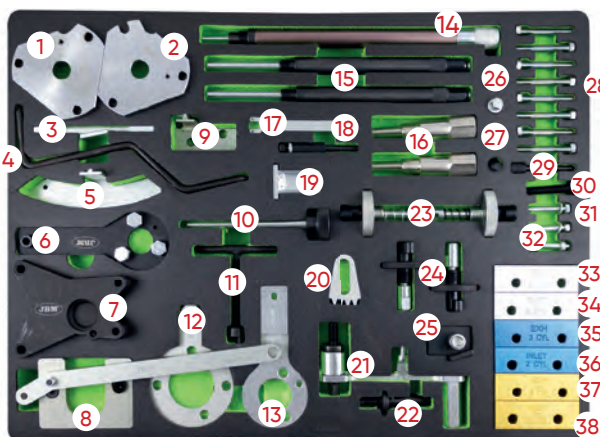

53770

198,00€

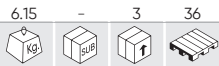

COFFRET DE CALAGE POUR FORD/SEAT/VOLKSWAGEN/MAZDA/VOLVO

MARQUES	FORD: FIESTA, FUSION, COURIER, ESCORT, FOCUS, FOCUS C MAX, PUMA, MONDEO, SIERRA, COUGAR, GALAXY, C-MAX, ORION, TOURNEO CONNECT, TRANSIT, TRANSIT CONNECT. VW: SHARAN. SEAT: ALHAMBRA. MAZDA: 121. VOLVO: S40, V50.
OUTILS OEM	303-1061 (1), 303-1054 (2), 23-059 / 310-085 (3), 21-105 (4), 323-029 (6), 0194-B / 21-263 / 303-735 / 49 JE 02 021 (7), 0132-AB / 0178-D / 21-151 (9), 0194-C, 21-262, 303-734, 49 JE 02 020 (10), 21-238 / 303-679A / 303-1151 (11), 21-238 / 303-679A / 303-1151 (12), 303-1054 (13), 303-1151 (14), 21-238 / 303-679A (15), 303-393 / 303-393-02 (16), 303-1097 (17), 21-168 / 303-393 (18), 303-0985 (20), 2064 / 23-047 / 310-055 / U20003 (21), 303-652 (22), 21-229, 303-651 (23), 303-748 (24), 21-210 (25), 21-260, 303-732 (26), 21-163, 303-620 (27), 21-234 / 21-251 (28), 303-675 / 303-698 (29), 21-104 / 303-193 (30) / 21-162B / 303-367 / 303-376 (31), 21-162B / 303-376 / 303-376B (32), 23-019 (33), 23-058 / 310-084 (34), 0153-M / 0178-C / 0178-D (35), 0178-B / 5711-TB (36), 21-123 (37), 23-020 (38), 21-234 / 21-251 (39), 303-1059 (40), 23-019 (41), 303-1060 (42), 303-393 / 303-393-01 (43)
CODES MOTEUR	FUJA, FUJB, FXJA, FXJB, FYJA, FYJB, F8JA, F8JB, M7JA, M7JB, DHA, DHB, DHC, DHD, DHE, DHF, DHG, FHA, FHE, LIT, LIV, LIE, LIG, LIH, LIK, RDA, RDB, RKC, RQB, RQC, FXDA/C, FXDB/D, FYDA/C, FYDB/D, FYDH, HWDA1Z, AHU, AVG, AFN, D24, D24T, D24TIC, RFN, RTJ, RTK, RVA, RFK, RKD, B4164S3, DV4TD (8HW/8HX/8HZ), DV4TED4(8HV/8HY), DV6ATED4 (9HX/9HY/9HZ) F6JA, F6JB, F6JC, G8DA, G8DB, KKDA, SNJA, SNJB, STJA, STJB, ASDA, ASDB, FXJC, SPJA, SPJC, FYJC, HWDA, HWDB, SHDA, SHDB, SHDC, JQDA, LQDB, JTDA, JTDB, HXDA, HXJA, HXJB, IQDA/B, IQDB, PNBA, PNDA, RHBA, SIDA, F6JD, TZJA, TZJB, HHDA, HHDB, HHJA, HHJC, HHJD, HHJE, HHJF, RTA, RTB, RTC, RTD, RTE, RTF, RTH, RTJ, RTK, RFN, BHPA, HCPA, HCPB, KKDA, P7PA, P9PA, P9PB, R2PA, R3PA, RWPA, RWPC, F9DA/B, FFBA, FFWA, KHBA, QYBA, QYWA, KKDB, C9DC, RVA, 1Z, AFN, AHU, ANU, AUY, G6DA, G6DB, G6DC, G6DD, G6DE, G6DF, G6DG, UFDB, TXDB, TYDA, UKDB, QXBA, AZBA, KLBA, QXBB, LPBA, AZBC, TYBA, UKBA, UFBA, TXBA, IXDA, QXWA, QXWB, AZWA, KLWA, AZWC, TYWA, UKWA, TXWA, UFWA, UFDA, TXDA, UKDA, Q4BA, KNBA, 4BA, 4BB, 4BC, 4CC, 4FA, 4CA, 4CB, 4DA, 4EA, 4FA, 4FB, 4FC, 4FD, 4GA, 4HB, 4HC, 4EB, 4EC, 4ED, 4GA, 4GB, 4GC, 4GD, 4GE, 4GF, 4HA, 4HD, FMBA/B, D5BA, ABFA, D3FA, D6BA, HJBA/B, F3FA, D2FA, D4FA, F4FA, F1FA, DOFA, QJBA, QJBB, QJBC, QJBD, FXFA, H9FA, H9FB, N7BA, N7BB, MZ-CD 1.6, Y6

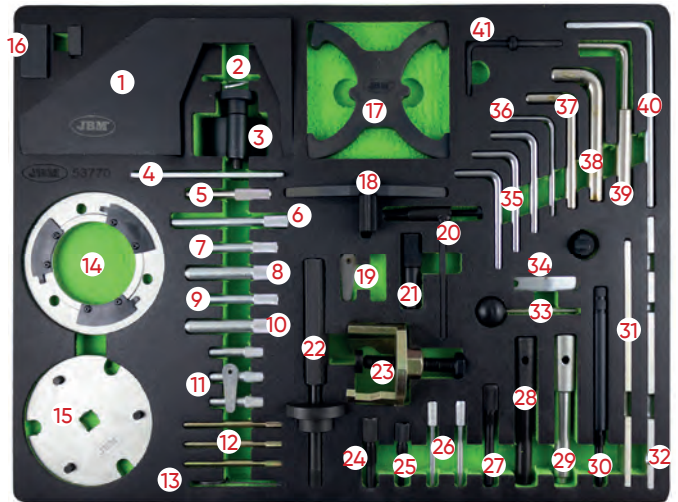

53774

190,00€

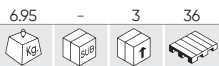

COFFRET DE CALAGE POUR OPEL/CHEVROLET/SAAB/FIAT/LANCIA/SUZUKI/FORD

MARQUES	ALFA: 145, 146, 147, 156, 159, 166, GT, CROSSWAGON Q4 FIAT: PUNTO, GRANDE PUNTO, BRAVO, BRAVA, MAREA WEEKEND, STILO, DOBLÒ, CARGO, MULTIPLA IDEA, PANDA LANCIA: YPSILON, MUSA, LYBRA, THESIS OPEL: CORSA B/C, COMBO, TIGRA, AGILA, TIGRA B, MERIVA, ASTRA F/G/H, ASTRAVAN, SPEEDSTER VX220, ZAFIRA A/B, VECTRA B/C, SIGNUM, OMEGA B, SINTRA, FRONTERA A/B, ASTRAVAN, KADETT, ASCONA, OMEGA, MONTEREY, ANTARA, CROMA, SPEEDSTER VX220 SUZUKI: IGNIS, SWIFT, WAGON R+ FORD: KA CHEVROLET & DAEWOO: EPICA, CAPTIVA, NUBIRA, LACETTI, EVANDA SAAB: 9-3, 9-5 (98-04)
OUTILS OEM	1860905000 / 1860905010 / EN-46788 (1), KM-6148 (2), KM-6148 (3), 1870900400 / 1871000200 (4), KM-954 (5), KM-J-43651 (6), 1860905000 / 1860905010 / EN-46788 (7), KM-852 (8), KM-853 (9), 1870900300 / 303-1468 (10), EN-46785 / KM-951 (11), KM-932 (12), 1860703000 (13), KM-955 (14), KM-6130 / KM-6349 / KM-6349 (15), KM-927 (16), EN-48245 (17), KM-933 (18), EN-46785 (19), 1860985000 / 1871000900 / EN-46781 (20), 1860985000 / 1871000900 / EN-46781 (21), EN-48246 (22), KM-929 (23), 1870896900 / EN-46789 (24), KM-952 (25), 21-162B / 303-376 / 303-376B (26), KM-933 (27)
CODES MOTEUR	X14XE, Z14XE, X16SEJ, X16XE, X16XEL, Y16XE, Z16XE, Z16YNG, C18XEL, X18XE, X18XE1, Z18XE, Z18XEL, C20SEL, C20XE, X20XE, Z20LEH, Z20LEL, Z20LER, Z20LET, X22SE, X22XE, Y22SE, Y22XE, Z22XE, D223L, X10XE, Z10XE, Z10XEP, X12XE, Z12XE, Z14XEP, X20DTL, X20DTH, X22DTH, Y20DTL, Y20DTH, Y22DTH, Y22DTR, 169A1.000, 955A4.000, 350A3.000, 192B4.000, 198A2.000, 350A2.000, 955A3.000, 192A8.000, 198A6.000, 198A3.000, 199B1.000, 199B2.000, 199A2.000, 199A3.000, 199A9.000, 940A3.000, 188A3.000, 939A2.000, 188B2.000, 188A8.000, 188A9.000, 323.02, 371.01, 937A2.000, 182B4.000, 182B9.000, 188A2.000, 188A7.000, 192A9.000, 186A6.000, 186A8.000, 192A1.000, 192A3.000, 192B1.000, 192A5.000, 186A9.000, 939A1.000, 199A5.000, 223A7.000, 223A9.000, 342.02, 362.02, 84TG.000, 84TH.000, 84IP.000, 939A3.000, 185A2.000, 185A6.000, Z13DT, Z13DTJ, Z13DTH, Z19DT, Z19DTH, Z19DTJ, Z19DTL, X10XE, Z10XE, Z10XEP, Z12XE, Z14XEP, X16S2R, Z16SE, 4EC1/T, 4EC1, 4EE1/T, 4EE1, X17DT, Y17DT, Y17DTI, Y17DTL, 16DA, 17D, 17DR/X, 7DTL, X17DTL, 4JX1/4, JG2T, 4FC1/T, 4FD1, X20DTL, Y20DTL, D223L Z20DMH, Z20DM, RA420, Z20S1, 194A1.000, Z22SE, Z22YH

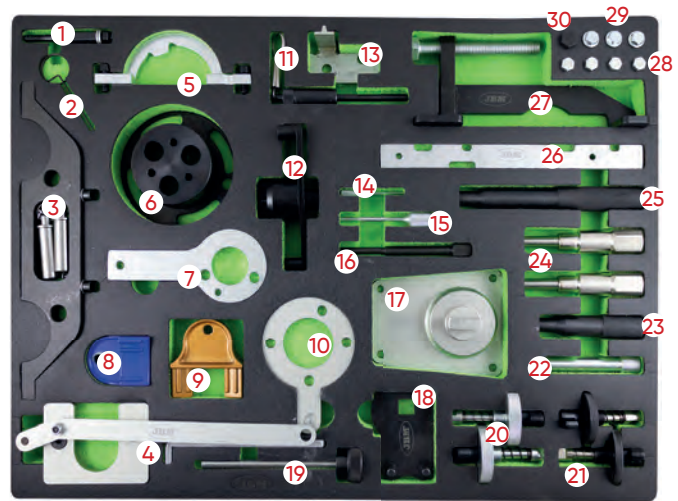

53771

158,00€

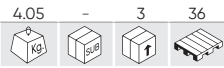

KITDE CALAGE POUR FIAT/FORD/CITROËN/PEUGEOT

MARQUES	<p>FIAT: ULYSSE, SCUDO, DUCATO LANCIA: ZETA, PHEDRA FORD: FIESTA, FUSION, FOCUS, FOCUS C-MAX CITROËN: C15, C1, C2, C3 PLURIEL, C4, C4 PICASSO, C5, C6, C8, DS3, DS4, DS5, XANTIA, XSARA, XSARA PI-CASSO, EVASION, BERLINGO, JUMPY, JUMPER, SAXO, ZX, XM, EVASION, AX PEUGEOT: 107, 1007, 206 CC, 207, 208, 306, 307 CC, 308, 406, 407, 508, 607, 806, 807, PARTNER, EXPERT, BOXER, 206, 106, 605, 205, 405</p>	
OUTILS OEM	<p>4200-TH (1), 0117-AR (2), 0188-X (3), 0606-A1.A2 (4), 0188-Q2 (5), 0189-S1 (6), 7017-TR (7), 0132-P / 4507-TL (8), 0189-C (9), 0188-J1 (10), 0188-J2 (11), 0178-E (12), 0189-R (13), 0132-AK / 0188-AK / 0189-K / 0153-AK / 4533-TAD / MOT 1436 (14), 0188-AH (15), 0189-S2 (16), 0153-AB / 9041-TZ (17), 0153-M / 0178-C / 0178-D / 7014-TM / 9767-94 (18), 0189-A (19), 4527-TS1 (20), 0153-AB / 9041-TZ (21), 0189-B / 21-163 (22), 0132-AJ1 / 0153-G / 0188-M / 0189-J / 4533-TAC1 / 5711-TA (24), 0189-L (25), 0188-D / 7017-TM (26), 0132-X / 0188-Q1 / 4507-TJ / 9767-89 (27), 0194-B (28), 0132-AB / 0194-A (29), 0194-C / 21-262 / 303-734 (30), 4527-TS2 (31), 0188-E (32), 0153-A / 6012-T / 9765-54 (33), 0134-AF / 0134-Q / 0188-F / 9004-T (34), 0188-P2 / 0188-P / 174 / 7015-T (35), 0153-U 7019-T (36), 0153-N / 0188-Y / 7014-TJ / 7099-TM / 9797-34 (37)</p>	
CODES MOTEUR	<p>F6JA, F6JB, F6JC, G8DA, G8DB, HHDA, HHDB, HHJA, HHJB CITROËN, PEUGEOT: 1.0 / 1.1 / 1.4 / 1.6 / 1.6 16V, 1.4 / 1.6HDI / 1.8 / 1.8 16V / 2.0 / 2.0 TURBO, 1.9D / 2.0HDI / 2.2HDI / 1.8 16V / 2.0 16V TU9 (CDY/CDZ), TU1 (HDY/HDZ/HFX/HFY/HFZ), TU3 (KDX/KDY/KDZ/KFX/KFZ), TU5JP4 (NFU/NFX), TU5 (BDY/BFZ/NFT/NFV/NFW/NFY/NFZ), XU7 (LFW/LFX/LFZ), EW7J4 (RLZ), XU7JP4 (LGY), XU10 (RFL/RFU/RFW/RFX/RGX/RGY), XU10JP4 (RGX/RGY), EW10A (RFJ), EW10J4S (RFK), EW10D (RLZ), EW12J4 (3FZ), ET3JE (KFU), TU3A/JP (KFV/KFW), DV4TD (8HW/8HX/8HZ), DV4TED4 (8HV/8HY), DV6ATED4 (9HX/9HY/9HZ), EW10-CVI (RLZ), EW12 (3FZ), DW8 (WJZ/WJY), DW10 (RHY/RHV/RHZ/RHS/RHM/RHW/RHT/RHR/RHX), DW12 (4HX/4HZ/4HW/4HY), EW7J4 (6FZ), EW10J4 (RFR), EW10J4D (RLZ), DW12TED4 (4HW), DW10ATED (RHT/RHV/RHW/RHX/RHZ) FORD 1.4 / 1.6 DURATORQ TDCI</p>	

53772

229,00€

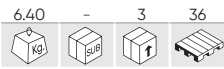

COFFRET DE CALAGE POUR FORD/VAG/MAZDA/VOLVO

MARQUES	<p>AUDI: 80, A1, A2, A3, S3, A4, A5, A6, TT, Q5 SEAT: AROSA, IBIZA, CORDOBA, LEON, TOLEDO, ALHAMBRA, ALTEA, INCA (99-04) SKODA: FABIA, OCTAVIA, SUPERB VW: LUPO, POLO, FOX, GOLF, BORA, JETTA, GOLF PLUS, PASSAT, BEETLE, TOURAN, SHARAN, CADDY, CADDY MAXI, TRANSPORTER, GOLF VI CABRIO, TIGUAN FORD: GALAXY</p>	
OUTILS OEM	<p>T10252 (1), VAS6079 (2), T10121 (3), MP1-1312 / T10098 / T20038 / T20038 (4), T10123 (5), 23-058 / 310-084 / T10008 (6), 2065A / T10008 / U40021 (7), 3418 (8), T10171 (9), 23-059 / 23-059 / 310-085 / T10050 / T10050 (10), 3458 / T30094 (11), T10016 / T10074 / T10074 (12), T10100 (14), T10414 (15), 3366 / T20018 / T20044 (16), 3411 (17), 3369 / T30092 (18), T10341 (19), 3242 / T40069 / T30052 (20), T 40026 (21), 3359 / MP1-301 / T20102 (22), 2064 / U20003 (23), T10120 (24), MP1-1312 / T10098 / T20038 (25), T10170 (26), T00115 / T10264 / T40098 (27), T10092 (28), T00115 / T10264 / T40098 (29), 303-1054 / T10115 (30), T10060 / T10060A (31), 3359 / MP1-301 / T20102 (32), T10340 (33), 2587 (34), 3387 / U30009A (35), 3387 / T10020 (36)</p>	
CODES MOTEUR	<p>ARC, ATN, AUS, AVY, AZD, AFH, BCA, AJV, AKQ, AUA, AUB, AXP, AFH, AFN, AFK, AHW, AHU, APE, AQQ, AUS, AXP, AZD, BBY, BBZ, BCB, ANY, AYZ, AMF, ATL, BAY, BHC, BMS, BNM, BNV, BWB, AJM, AMG, ANU, ARL, ASZ, ATD, ATJ, AUJ, AVB, AVF, AVQ, AWX, AXB, AXC, AXR, BEW, BJB, BKC, BKE, BLS, BLT, BMT, BPX, BRB, BRM, BRR, BRU, BSU, BSW, BTB, BUK, BVK, BXE, BXF, AZV, BDJ, BDK, BGV, BHW, BKD, BKP, BLB, BMA, BMM, BMN, BMP, BMR, BNA, BPW, BRC, BRE, BRF, BRT, BUZ, BE, BVF, BVG, BVH, BWK, BTS, BMY, BLF, BWV, AZV, BKD, AWY, AZQ (55 - 64 PF), AXU, BAG, BKG, BLF, BLN, BLP, BVF, BKF, BNU, BVP, BVR, IZ, CBZA, CBZC, CBZB, CAXA, CAGA, CAGB, CAGC, CAHA, CAYA, CAYB, CAYC, CBAA, CBAB, CBAC, CBBA, CBBB, CBDA, CBDB, CBDC, CBEA, CEGA, CKUB, AZV, BDJ, BHP, BKD, BLB, BMA, BMM, BMN, BMP, BMR, BNA, BPW, BRC, BRE, BRF, BRT, BSS, BUJ, BUZ, BVA, BVE, BVF, BVG, BVH, BWV, ACV, AFB, AGX, AHD, AHY, AHY, AJT, AKE, ANJ, APA, AUF, AXG, AXG, AXL, AYC, AYM, AYY, BAU, BBE, BBF, BCZ, BDG, BDH, BFC, BJJ, BJK, BJL, BJM</p>	

SERVANTE D'OUTILS 7 TIROIRS AVEC JEU D'OUTILS POUR RÉGLER LA SYNCHRONISATION

53951 1.794,00€

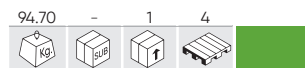

COMPLETE

53952 1.794,00€

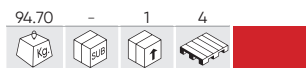

COMPLETE

54501 1.794,00€

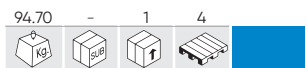

COMPLETE

54502 1.794,00€

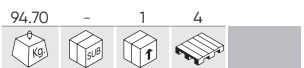

COMPLETE

DIMENSIONS INTERIEUR

PETITS TIROIRS (X5)

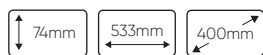

GRANDS TIROIRS (X2)



CAPACITÉ DE CHARGE DU TIROIR: 30KG.
CAPACITÉ DE CHARGE TOTALE: 70KG.

DIMENSIONS GÉNÉRALES

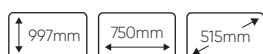

AVEC MODULES EVA:

JEU DE 6 OUTILS POUR SYNCHRONISATION DU MOTEUR

53775 1.109,00€



GASOLINA/PETROL DIESEL/GASOIL

CONTIENT

REF.	Box	Sub	1	6	€
53769	5.90	-	3	36	178,00€
53770	6.15	-	3	36	198,00€
53771	4.05	-	3	36	158,00€
53772	6.40	-	3	36	229,00€
53773	6.60	-	3	36	298,00€
53774	6.95	-	3	36	190,00€

53769



RENAULT / NISSAN / OPEL / VOLVO

53770



FORD / SEAT / VOLKSWAGEN / MAZDA / VOLVO

53771



FIAT / FORD / CITROËN / PEUGEOT

53772



FORD / VAG / MAZDA / VOLVO

53773



FIAT / ALFA / LANCIA / OPEL / SUZUKI / FORD

53774



OPEL / CHEVROLET / SAAB / FIAT / LANCIA / SUZUKI / FORD

POUR PLUS D'INFORMATION

PAGE 297

ACCÉSSOIRES ET PIÈCES DE RECHANGE

PAGE 90

ACCESSOIRES POUR LUBRIFIANTS

- 302 POMPES D'ALIMENTATION EN CARBURANT DIESEL
- 303 POMPES D'ALIMENTATION EN URÉE
- 304 POMPES D'EXTRACTION/DE REMPLISSAGE
- 307 COLLECTEURS D'HUILE
- 308 PISTOLETS D'ASPIRATION
- 309 SEAUX COLLECTEURS D'HUILE
- 310 AUTRES



53697

398,00€

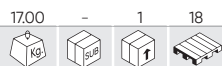

POMPE À CARBURANT DIESEL AVEC DOSEUR ET INDICATEUR (200 À 240 V)



- Tension nominale: 200 à 240 V
- Puissance nominale: 550 W
- Débit max.: 60 l/min
- Longueur du câble: 2 m.
- Longueur du tuyau d'aspiration: 2 m.
- Longueur du tuyau en charge: 4 m.

AVEC ARRÊT AUTOMATIQUE



PIÈCES DE RECHANGE

53610

294,00€



POMPE DISTRIBUTEUR DIESEL AVEC PISTOLET (230 V)



- Longueur du tuyau d'entrée: 2m.
- Longueur du tuyau de sortie: 4m.
- Électrique.
- Fourni avec pistolet et tuyaux.

AVEC ARRÊT AUTOMATIQUE



PIÈCES DE RECHANGE

53609

182,50€



POMPE DISTRIBUTEUR DIESEL AVEC PISTOLET (12 V)



- Longueur du tuyau d'entrée: 2m.
- Longueur du tuyau de sortie: 4m.

AVEC ARRÊT AUTOMATIQUE



PIÈCES DE RECHANGE

54100

265,00€



POMPE À DIESEL ÉLECTRIQUE



- Longueur du tube d'aspiration : 850-1245 mm
- Longueur du tuyau : 2 m
- Température de travail : 5° - 40°C (41° à 104°F)
- Tension CC : 12 V
- Courant alternatif : 100-240 V
- Longueur du câble : 4 m



53645

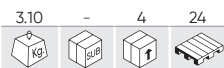

POMPE ÉLECTRIQUE POUR UREA AUS32

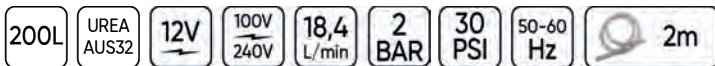

- La pompe électrique rotative est conçue pour fonctionner avec les agents à base d'eau, Urea AUS32 DEF et permet de pomper le contenu des réservoirs IBC de 205 l ou de 1000-1250l.
- Design compact et léger.
- Fusible intégré pour la protection contre la surcharge et le moteur silencieux.
- Filtre intégré dans le tube d'aspiration en acier inoxydable, empêchant les contaminants de pénétrer et, par conséquent, excluant des pannes.

268,00€



53644

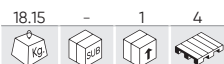

RÉSERVOIR POUR UREA AUS32 (75 L)

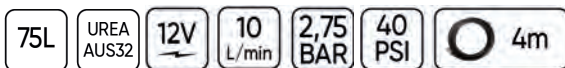

- Une conception autonome et entièrement mobile de 75l de volume avec une pompe alimentée en 12V (on pourra atteindre une productivité de 10l/min), équipée d'un tuyau et d'une vanne d'arrêt automatique.
- Le réservoir en polyéthylène est compact, résistant à la corrosion et aux rayons UV.
- Les roues de grand diamètre (200mm) offrent une grande maniabilité, même sur un sol accidenté.

1.238,00€



15631

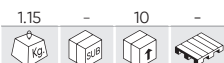

PISTOLET AUTOMATIQUE POUR ALIMENTATION EN URÉE AUS32 (RÉF.53645)



98,00€



52329



POMPE A LEVIER PLASTIQUE



- Pour fûts de 25, 50, 200L
- Pompage de 350ml
- Corps et piston en polypropylène
- Poignée en plastique ABS
- Applications: alcools, huiles, lubrifiants, essence, diesel, kérosène, etc.
- Conduit: Larg. min.: 320mm, Larg. max.: 900mm

36,40€



13982

4,00€



ADAPTATEUR FILETÉ POUR TAMBOURS EN PLASTIQUE

- Prévoit le réglage et la compensation de divers filetages de réservoirs, de fûts et de pompes.



52601

397,00€

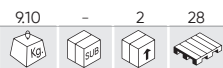

200L

POMPE À HUILE

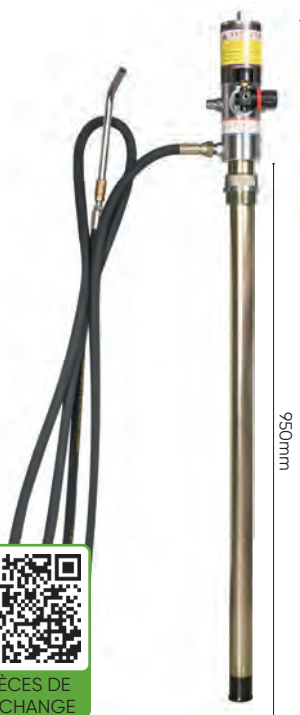

1242mm
950mm

50918

341,00€



200L

POMPE À HUILE

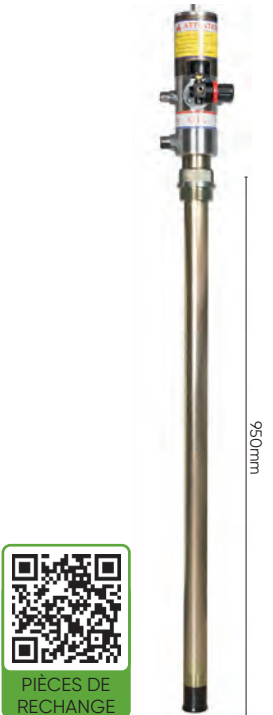

1242mm
950mm

50935

595,00€

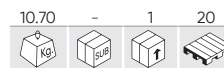

200L

COMPTEUR DIGITAL



1242mm
950mm

- Pression Rapport: 5: 1.
- Entrée d'air: 1/4".
- Sortie d'air: 1/4".
- Pression de travail: 6-8 bar.
- Pression Max.: 8 bar.
- Consommation d'air: 250 L/min.
- Capacité relative à 6 bar: 18 L/min.
- Plage de temp. de l'huile: -10~50 °C.
- Viscosité maximale: 240 SAE.
- Longueur du tube: 950 mm.

- Pression Rapport: 5: 1.
- Entrée d'air: 1/4".
- Sortie d'air: 1/2".
- Pression de travail: 6-8 bar.
- Pression Max.: 8 bar.
- Consommation d'air: 250 L/min.
- Capacité relative à 6 bar: 18 L/min.
- Plage de temp. de l'huile: -10~50 °C.
- Viscosité maximale: 240 SAE.
- Longueur du tube: 950 mm.

- Longueur du tuyau: 2 m.
- Longueur du tube: 950 mm.
- Viscosité maximale: 240 SAE.
- Consommation d'air: 250 L/min.
- Capacité relative à 6 bar: 18 L/min.
- Plage de temp. de l'huile: 10~50 °C.
- Pression Rapport: 5: 1.
- Entrée d'air: 1/4".
- Sortie d'air: 1/2".
- Pression de travail: 6-8 bar.
- Pression Max.: 8 bar.

53566

32,00€

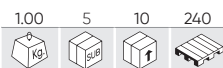

POMPE D'ASPIRATION D'HUILE - 12V



- La pompe d'aspiration d'huile (l'extracteur) est un dispositif idéal pour une vidange d'huile rapide et de grande qualité.
- Elle fonctionne à partir d'une batterie de voiture (12 V) à travers les clips fournis.
- L'huile est extraite du moteur par le trou pour la jauge.
- N'utilisez l'extracteur que pour pomper de l'huile mo-tueur, de l'huile pour moteurs diesel et du liquide de refroidissement.



51253

41,00€

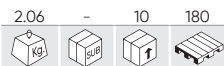

POMPE A LEVIER POUR HUILE

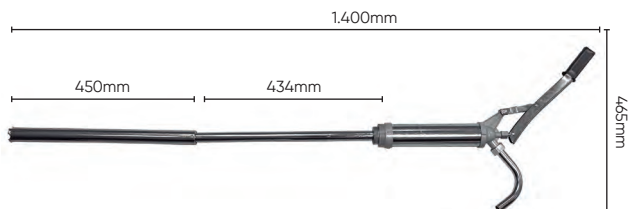

52428

40,00€

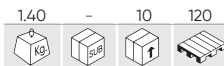

POMPE ROTATIVE

- Pour les fûts de 50 à 200L
- Flux de 400ml par pompage.
- Capacité de pompage: 32l x min.
- Adaptateur 2" inclus.
- Tuyau d'aspiration de 101cm avec entré de 1 1/4" et sortie de 1".
- Pas valable pour les acides forts, eau de javel.
- Applications: huiles, lubrifiants, diesel, fluides à base d'huile.
- Recommandé pour: Diluant, laque, liquide de frein, de détergents, glycérine, acides légers, fluides à base de pétrole.



50917

271,00€

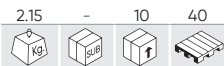

PISTOLET À POMPE AVEC DÉBITMÈTRE POUR HUILE

- Entrée d'air : 1/2" BSPF
- Débit: 1-35 L/min
- Pression de travail : 6-8 bar
- Pression de travail maximale : 100 Bar
- Plage de température de l'huile : -10~60°C
- Viscosité maximale : 240 SAE
- Batterie : 2x1.5V (batterie incluse)
- Précision du débitmètre : ±0,5%
- Répétabilité du débitmètre : 0,2%
- Débit de décharge par tour : 25ml/R



53627

22,50€

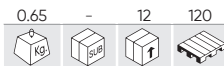

KIT D'EXTRACTION D'HUILE ET DE CARBURANT

- 1,6L
- L'appareil est conçu et fabriqué pour une évacuation rapide de l'huile, du carburant, ainsi que de l'huile de transmission / huile différentielle des réservoirs de générateurs, des nettoyeurs haute pression, des compresseurs à air, des tracteurs de jardin ou des véhicules tout terrain.



REF. DESCRIPTION

REF.	DESCRIPTION	kg	L	mm	€
10000	MONTRE DIGITALE POUR REF. 50917	2.10	-	7,00€	

52797

198,00€

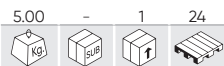

SYSTÈME DE REMPLISSAGE DE BOÎTE À VITESSE

- Capacité: 7,5L.
- Débit: 80cc cycle.
- Viscosité max. de huile débitée SAE 140.
- Permet de remplir et de vider



REF. DESCRIPTION

REF.	DESCRIPTION	kg	L	mm	€
13234	POMPE DE REMPLISSAGE DE SYSTÈME DE TRANSMISSION SANS ACCESSOIRES P/52797	3.75	24	224,50€	

12044

147,00€

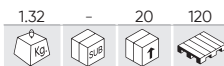

SET DE 15 ADAPTATEURS POUR POMPE DE REMPLISSAGE DE SYSTÈME DE TRANSMISSION (15 ACCESSOIRES)

- ATF101: FORD 1/8 - 27 (NPT).
- ATF102: Universal BMW, Honda, Nissan, etc.
- ATF103: VW/Audi. Skoda.
- ATF104: VW/Audi. Porsche.
- ATF105: VW/Audi, Mini cooper M10x1.0
- ATF106: VW/Audi DSG M24 x 1.5
- ATF107: VW/Audi CVT M22x1.5
- ATF108: Mercedes M12 x 1.5
- ATF109: V/W. Skoda M18x1.5
- ATF110: Audi/VW, Skoda M30x1.5
- ATF111: Universal flexible 300mm. Honda. Hyundai. KIA...
- ATF112: Volvo 5/16 - 24 (UNF)
- ATF113: Toyota, Lexus M18 x 1.5
- ATF114: Nissan, Infinity M8 x 1.0
- ATF115: ATF-Adapter VW Passat



54290

4.307,00€

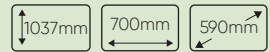
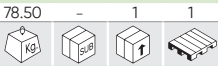

N

MACHINE DE CHANGEMENT D'HUILE DE TRANSMISSION AUTOMATIQUE



Error de intercambio equivalente
Equivalent exchange error **±100ml**

- Remplissage de liquide de transmission automatique
- Identification automatique de la direction du liquide
- Nettoyage automatique
- Changement automatique de fluide neuf/utilisé.
- Affichage des niveaux de pression liquide
- Affichage précis de la température du liquide
- Commande électronique intelligente
- Base de données actualisable
- Comprend des adaptateurs pour différentes marques
- Améliore les performances du système de transmission automatique



TUTORIEL VIDÉO



PIÈCES DE RECHANGE

54367

729,00€



N

SET D'ADAPTATEURS POUR REF.54290 (105 PCS)

CONTIENT



INFORMATIONS TECHNIQUES

54050

895,00€

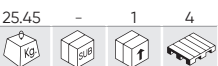

MACHINE D'ÉCHANGE D'HUILE DE TRANSMISSION AUTOMATIQUE

- Source d'alimentation : 12 V (batterie de voiture)
- Puissance de la pompe : 70 W
- Diamètre du manomètre d'huile : 70 mm (les deux manomètres d'huile)
- Plage de mesure des manomètres d'huile : 0-10 bar (0-150 psi)
- Capacité du réservoir d'huile fraîche : 30 l
- Capacité du réservoir d'huile usée : 30 l



TUTORIEL VIDÉO



PIÈCES DE RECHANGE

53874

398,00€

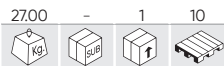

RECUPÉRATEUR D'HUILE 90L AVEC SYSTÈME D'ASPIRATION

90L 8-10 BAR



PIÈCES DE RECHANGE



POUR CAMIONS/VÉHICULES

- Pression d'air de fonctionnement 8 ~ 10 bar
- Niveau de vide: négatif 0 ~ 0,8 bar
- Capacité du réservoir: 70 l
- Capacité de la crépine de collecte 10 l
- Capacité de la tasse doseuse: 10 l
- Vitesse d'aspiration d'huile en fonction du diamètre de la sonde: 0,8 l/min (Ø5x3,5 mm); 1 l/min (Ø6x4,5 mm); 1,6 l/min (Ø8x6,5 mm)
- Dimensions: 43x49x163 cm
- Milieu: huile de moteur et huile de transmission
- Température d'huile de fonctionnement recommandée: 40 ~ 60 °C
- Avec vide d'EXTRACTION.
- Système de mesure intuitif.
- Grand réservoir.
- Poignée pour contrôler l'utilisation.
- Roulettes pour un transport facile

53873

285,00€

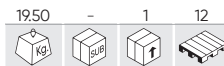

RECUPÉRATEUR D'HUILE 80L

80L 1-3 BAR



PIÈCES DE RECHANGE



POUR CAMIONS/VÉHICULES

- Pression d'air de fonctionnement 1 à 3 bar
- Capacité du réservoir: 70 l
- Capacité de la crépine de collecte 10 l
- Dimensions: 35x48x163 cm
- Milieu: huile de moteur et huile de transmission.
- Grand réservoir.
- Poignée pour contrôler l'utilisation.
- Roulettes pour un transport facile.
- Peut être utilisé pour les huiles haute température (sans limites).

15084

68,00€

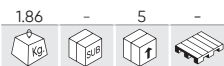

BLOC D'EXTRACTION DE BOUCHONS DE CARTER

	x2	5/16", 3/8"		x7	8, 9, 10, 12, 13, 14, 17mm
	x7	7, 8, 10, 11, 12, 13, 14mm		x1	T45
	x1	10mm		x1	M16
	x1	10mm		x1	200mm
				x1	150mm



53215

19,00€

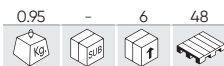

185mm Ø380mm

BAC DE VINDAGE ANTIGEL CAP. 18L

18L



53144

18,00€



185mm Ø380mm

RECUPÉRATEUR D'HUILE 18L

18L



54051

39,00€

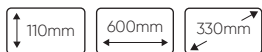

PLATEAU D'HUILE 8 L

8L PE



51356

48,00€



BAC EN ACIER POUR LIQUIDES

23L



52498

58,00€



SERINGUE 1.5L TRANSPARENTE



- Fabriqué en polypropylène.
- Corps transparent.
- Valable pour huiles de transmission et différentielles.
- Resiste au liquide de frein et antigel.

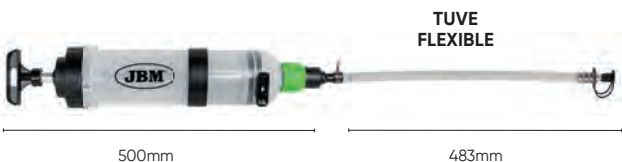

52628

26,50€



SERINGUE TRANSPARENTE 200ML



- Pour liquide de frein.
- Conecteur rapide a l'extremite.



REF. DESCRIPTION

11867 DEUX JOINTS TORIQUES POUR REF. 52498

kg	sub	unit	pallet	€
0.02	-	100	-	9,00€

51928

14,00€

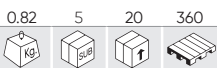

SERINGUE A HUILE

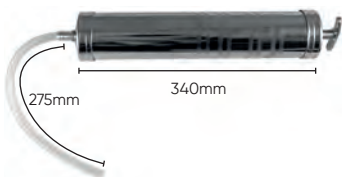

52789

15,20€



POMPE MANUEL EXTRACTION GASOIL



- Tuyau 90cm longue pour chaque extrémité.

50924

342,00€

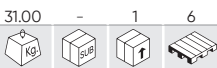

CHARIOT PORTE BIDONS SPÉCIAL GRAISSAGE

200L



BACS DE RETENTION

52804
14.50 - 1 5
Kg SUP

343,00€
230L 400Kg

APPROUVÉ DIBT
1 FÛT VERTICAL

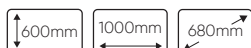

52805
13.35 - 1 6
Kg SUP

426,00€
250L 650Kg

APPROUVÉ DIBT
2 FÛTS VERTICAUX



52806
17.50 - 1 5
Kg SUP

742,00€
250L 1250Kg

APPROUVÉ DIBT
NE CONVIENT PAS POUR LES TRANSPALETTES
4 FÛTS VERTICAUX



53214
16.50 - 1 12
Kg SUP

285,00€
380mm 1310mm 910mm

RÉSERVOIR POUR 2 FÛTS VERTICAUX
SPECIAL EUROPALLET

230L 650Kg

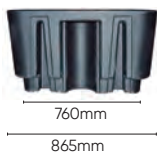

52807
30.00 - 1 7
Kg SUP

1.714,00€
700mm 1680mm 1680mm

RÉSERVOIR CONTENEUR 1000L IBC

1000L 2500Kg



APPROUVÉ DIBT



54498
221.00 - 1 -
Kg SUP

IBC HARDCOVER

Permet le stockage de conteneurs IBC. Assure une protection maximale du conteneur contre les intempéries. Avec bac de récupération des liquides d'une capacité de 2 litres, bac de rétention intégré et fentes d'aération.

CAPACITÉ DU CONTENEUR DE 1000 LITRES : 1 UNITÉ

CAPACITÉ D'UN FÛT DE 200 LITRES : 4 UNITÉS

CAPACITÉ DE CHARGE TOTALE : 2500 KG.

2500Kg 2500mm 1775mm 1770mm

6.090,00€



CONTENEUR IBC NON INCLUS

53612

96,00€

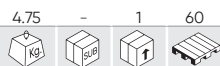

PINCE POUR BIDONS (CAPACITÉ DE CHARGEMENT 500 KG)



- Pour manipuler des bidons d'huile.
- Capacité: 500kg.
- Type de prise verticale de conteneur
- Bidons spéciaux 200 litres.

JERRICAN BIDON EN MÉTAL

REF.	L/mm				€
54181	5L - 550x260x350mm	1.45	4	72	25,10€
54182	10L - 570x350x425mm	2.55	4	48	34,70€
54184	20L - 760x370x500mm	4.10	4	24	44,00€



54183

38,20€



JERRICAN ANTI-RENVERSEMENT 10L



REF. DESCRIPTION

15874 TUYAU DE REMPLISSAGE SOUPLE POUR JERRICAN (RÉF.54181, 54182, 54183, 54184)

			€	
0.30	-	50	800	6,50€

52452

8,00€

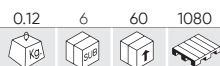

PINCE POUR OUVERTURE DE FUT



- Matière: Nylon.
- Anti-étincelles et anti-poussière.
- Relief de 3/4" et 2".
- Utile pour bidons de 200L.

53078

18,00€

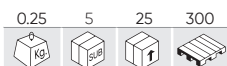

ROBINET POUR BIDON DE 200L



- Permet de vider rapidement les fûts de 200 litres.
- Convient à l'eau, à tous les types d'huiles, à l'ALCOHOL ou à la cétone, ainsi qu'aux acides faiblement concentrés et aux liquides légèrement alcalins.
- Matériel: PE.
- Joint EPDM.
- Ressort en acier inoxydable.

53518

3,50€



ROBINET DE PLASTIQUE POUR FUT DE 3/4"



- Convient à tous les types de fluides.
- Filetage extérieur 3/4".

52453

21,00€

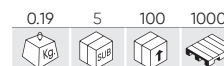

ROBINET POUR FUT DE 3/4"



- Robinet de sécurité.
- Vise de 3/4".
- En Alliage.
- Joint en Nylon.
- Applications: huiles, lubrifiants, essence, diesel, querosene, etc.
- Validé pour Urea AUS32.

52242

12,00€

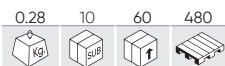

BURETTE 500ML

500ml



52243

8,50€

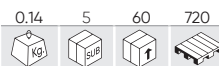

BURETTE 250ML

250ml



52991

10,50€



BROCS VERSEUR GRADUÉS AVEC FLEXIBLE ET COUVERCLE

2L



52992

18,00€



CARAFE AVEC GOULOT FLEXIBLE 5L

5L



53187

39,00€

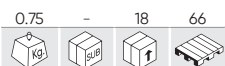

ENTONNOIR POUR BIDON 200L AVEC BOUCHON ET FILTRE

4,5L



- Ø Intérieur: 245mm.
- Ø Extérieur: 255mm.

53188

7,00€



SET DE 3 ENTONNOIRS

Ø 90,130,180mm



52391

5,00€

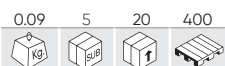

ENTONNOIR FLEXIBLE

950ml



140x15mm



53198

9,50€



ENTONNOIR AVEC TUBE FLEXIBLE

1,8L



Ø 180mm



53849



PISTOLET À GRAISSE MINI



16,10€

50852

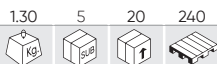

POMPE A GRAISSE MANUELLE AVEC TUYAU FLEXIBLE

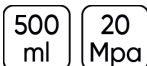

24,50€

50751

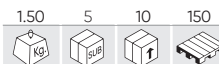

POMPE A GRAISSE PNEUMATIQUE

- Tube rigide.
- Tube flexible.
- Pression : 30 Mpa



43,00€

53592

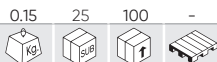

ACCOUPLMENT À DÉGAGEMENT RAPIDE



25,00€

54255



ENSEMBLE D'ACCÉSSOIRES POUR PISTOLET À GRAISSE



68,00€

Il est recommandé de l'utiliser avec les pistolets graisseurs JBM réf. 50751 et 50852, bien qu'il convienne à la plupart des pistolets.

60038



SERINGUE DE GRAISSE BATTERIE

BATTERIE NON INCLUSE.

Cet outil est un pistolet graisseur. Grâce à l'alimentation par batterie, l'outil est facile à utiliser et à transporter.

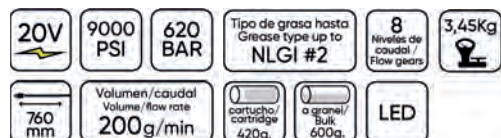

255,00€

OUTILS HYDRAULIQUES

- 314 CRICS À ROULETTES
- 316 CRICS À BOUTEILLES
- 317 CRICS GRIFFÉS
- 317 CRICS HYDRAULIQUE TÉLESCOPIQUE
- 318 BÉQUILLES POUR CRIC DE VOITURE
- 318 AUTRES
- 320 TRANSPALETTE MANUELLE
- 321 PRESSES
- 322 GRUES
- 323 TABLES ÉLÉVATRICES
- 325 TAMPON EN CAOUTCHOUC POUR ÉLÉVATEUR



53725

248,00€

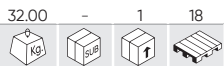

CRIC ROULEUR 3T - SYSTÈME RAPIDE



MAX: 465mm
MIN: 133mm



PIÈCES DE RECHANGE

RENCONTRE AVEC: EN 1494:2001

50818

198,00€

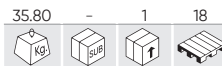

CRIC ROULEUR 3,5T



MAX: 495mm
MIN: 133mm



PIÈCES DE RECHANGE

RENCONTRE AVEC: EN 1494:2001

53422

368,00€

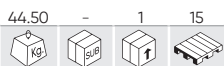

CRIC HYDRAULIQUE 3T AVEC LEVIER D'ÉLEVATION



MAX: 533mm
MIN: 100mm



PIÈCES DE RECHANGE

50815

88,00€

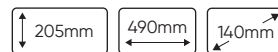

CRIC ROULEUR 2T



MAX: 355mm
MIN: 130mm



PIÈCES DE RECHANGE

53112

298,00€

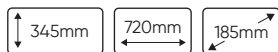
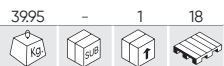

CRIC ROULEUR AVEC PÉDALE D'APPROCHE 3T



MAX: 520mm
MIN: 140mm



PIÈCES DE RECHANGE

53968

49,00€

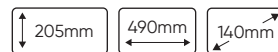
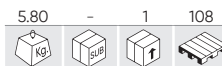

CRIC ROULEUR 2T



MAX: 300mm
MIN: 130mm



PIÈCES DE RECHANGE

RENCONTRE AVEC: EN 1494:2001

51895

99,00€

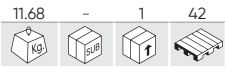

CRIC ROULEUR DANS MALLETTE PLÁSTIQUE 2T



↑ MAX: 355mm
↓ MIN: 130mm



PIÈCES DE RECHANGE

50816

88,00€

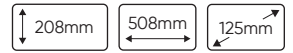

CRIC ROULEUR 2T SPÉCIAL VOITURES BASSES



↑ MAX: 340mm
↓ MIN: 90mm



PIÈCES DE RECHANGE

53421

298,00€

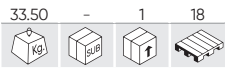

CRIC ROULEUR 2T SPÉCIAL VOITURES BASSES



↑ MAX: 505mm
↓ MIN: 75mm



PIÈCES DE RECHANGE

54137

288,00€

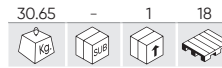

CRIC ROULEUR 2,5T SPÉCIAL VOITURES BASSES



↑ MAX: 505mm
↓ MIN: 78mm

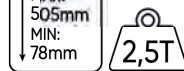

DOUBLE PISTON

TUTORIEL DE MAINTENANCE



CRICS HYDRAULIQUES POUR VOITURES BASSES

ILS OFFRENT UNE ADAPTATION OPTIMALE AUX VÉHICULES À PROFIL BAS, GRÂCE À LEUR HAUTEUR RÉDUITE ET LEUR CONCEPTION INCURVÉE.

CRIC BOUTEILLE

50819 28,00€



MAX: 345mm
MIN: 181mm



50820 34,50€

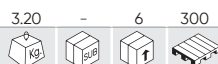

MAX: 372mm
MIN: 194mm



50821 47,00€



MAX: 413mm
MIN: 216mm



50822 59,00€



MAX: 460mm
MIN: 230mm



52304 84,00€



MAX: 365mm
MIN: 225mm



50823 94,00€

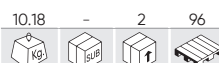

MAX: 452mm
MIN: 242mm



50824 88,00€

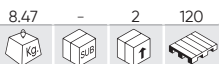

MAX: 355mm
MIN: 190mm



SPÉCIAL VOITURES BASSES



50825 154,00€

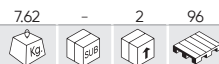

MAX: 465mm
MIN: 285mm



CRIC BOUTEILLE DANS MALETTE PLASTIQUE

51905 34,50€



MAX: 340mm
MIN: 185mm



51906 39,00€



MAX: 385mm
MIN: 195mm



51907 48,00€



MAX: 450mm
MIN: 215mm



CRIC À CRÉMAILLÈRE 3T

REF.	Min.	Max.	mm				€
53895	130mm	330mm	510x265x140	9.15	1	42	107,00€
53896	130mm	645mm	840x265x140	11.60	1	28	127,00€
53897	130mm	1045mm	1220x265x140	13.85	1	21	140,00€
53898	130mm	1320mm	1520x265x140	15.65	1	21	148,00€



ACCÉSSOIRES

REF.	DESCRIPTION				€
15093	PIVOT DE SUPPORT DE ROUE	3.65	1	50	38,00€
15094	CALE DE CRIC	1.35	5	140	39,50€
15095	FIXATEUR DE POIGNÉE	0.10	50	-	13,00€
15096	DISPOSITIF POUR SOULÉVER PAR ROUE	2.00	10	560	40,00€



54001

285,00€

28.50	-	1	20

VÉRIN DE FOSSE 0,5T

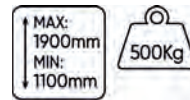

- Plage de levage de 116 à 197 cm.
- Support double position.
- Élévation confortable et rapide avec pédale.
- Soupape avec ressort pour descente contrôlée.
- Permet de souLÉVER et de déplacer des boîtes de vitesses, des différentiels, des réservoirs, etc. de façon sûre et stable.



50830

560,00€

52.10	-	1	6

VÉRIN HYDRAULIQUE DE TRANSMISSION 0,5 TON.

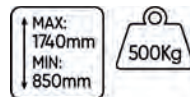

- Avec poignée.
- Rapide.
- Double piston.



OUTILS HYDRAULIQUES

JEU DE CHANDELLES À CREMAILLÈRE

REF.	DESCRIPTION					€
53779	3T 290-430mm	5.05	-	1	72	36,00€
53845	6T 370-610mm	9.35	-	1	30	64,00€
54143	12T 500-770mm	35.50	-	1	12	249,00€



CHANDELLES À CRÉMAILLÈRE 10 TONNES

REF.	DESCRIPTION					€
54145	10T 482-775mm	37.90	-	1	4	377,00€
54146	10T 736-1212mm	2.00	-	1	4	492,00€



54147

198,00€

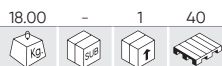

SUPPORT ÉLEVATEUR 1,8 TONNE (1220-2146 MM)

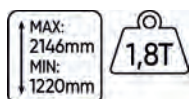

54144

298,00€



JEU DE 2 CHANDELLES À CRÉMAILLÈRE 22 TONNES (338-500 MM)

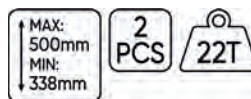

53200

69,00€

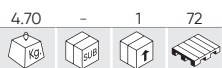

CHANDELLES ALUMINIUM 3T

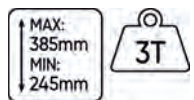

53218

26,00€

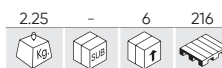

CRIC EN CISEAUX 1.5T

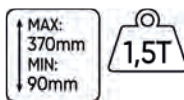

51901 999,00€



CHARIOT PORTE ROUE CAP 1T.



- Longueur: 1040 mm
- Largeur: 1090 mm
- Hauteur: 890 mm
- Plage de levage: 50 à 100 mm
- Diamètre max. de roue: 1320 mm

SPÉCIAUX POUR CAMIONS



52241 1.690,00€



CHARIOT PORTE ROUE HYDRAULIQUE 1.5T. SPECIAL ROUE TRACTEURS



- Capacité de charge: 1,5 T
- Plage de levage: 0 à 770mm
- Longueur d'encombrement: 1270mm
- Largeur d'encombrement: 990mm
- Hauteur d'encombrement: 1340mm
- Diamètre maximal des roues: 2200mm (86")
- Diamètre minimal des roues: 1000mm (39")
- Largeur maximale des roues: 800mm



54257 318,00€

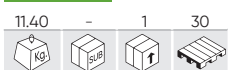

POMPE HYDRAULIQUE À MAIN

10000 PSI
3/8" NPT

PRESSION DE TRAVAIL:
- Étape 1 : 0 à 20 kg/cm³
- Étape 2 : 20 à 700 kg/cm³

1,8m

FLUX:
- Étape 1 : 13cc
- Étape 2 : 2.3cc



50835 290,00€



CINTREUSE HYDRAULIQUE 12T



- Coins ajustable.
- Pression d'air 0,75 - 0,75mpa.
- Permet de plier des tubes de 2"(50mm).
- Taille coins: 1/2", 3/4", 1", 1-1/4", 1-1/2", 2".

OUTILS HYDRAULIQUES

53880

598,00€

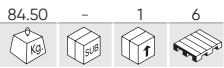

TRANSPALETTE LEVAGE RAPIDE

- Capacité de charge: 2500kg
- Longueur du poussoir: 1150mm
- Poignée: Carrée, caoutchoutée
- Roue de direction (rotative): PU (200x50mm)
- Roue fixe: Double, PU (80x70 mm)
- Hauteur min. des fourches: 85mm
- Hauteur max. des fourches: 200mm
- Nombre de parcours du piston de pompe: 8

À ACTION RAPIDE
(ACIER COULÉ)



PIÈCES DE RECHANGE

54396

2.250,00€

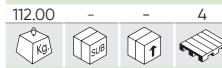

N

TRANSPALETTE ÉLECTRIQUE



PIÈCES DE RECHANGE



INFORMATIONS TECHNIQUES

50839

180,00€

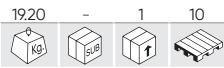

CHARIOT HYDRAULIQUE 680 KG



PIÈCES DE RECHANGE



50923

454,00€

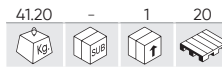

CHARIOT CARROSSERIE



PIÈCES DE RECHANGE



52514

84,00€

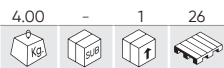

SUPPORT AVANT ÉLÉVATEUR POUR MOTO 200KG



PIÈCES DE RECHANGE



51751

99,00€

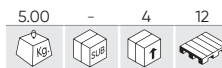

BEQUILLE MOTO



PIÈCES DE RECHANGE



53684

1.880,00€

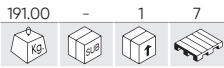

PRESSE HYDRAULIQUE SUR PIEDS DE 30 TONNES

- Capacité (T): 30.
- Trait (mm): 160.
- Plaque de travail (mm): 166-1126.
- Largeur de la base (mm): 540.
- Course latérale (mm): 200.
- Parcours: 150 mm.
- Actionnement manuel et au pied.



53590

1.190,00€

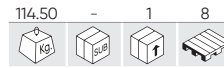

PRESSE HYDRAULIQUE SUR PIEDS DE 20 TONNES

- Capacité (T): 20.
- Trait (mm): 145.
- Plaque de travail (mm): 58-1018.
- Largeur de la base (mm): 540.
- Largeur intérieure (mm): 536.
- Course latérale (mm): 180.

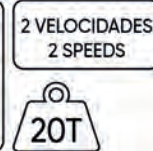
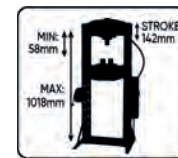

REF. DESCRIPTION

14616 GRILLE DE PROTECTION POUR PRESSE HIDRAULIQUE 20 T/30 T (RÉF. 53590/53684)



€

96,00€



52999

178,00€

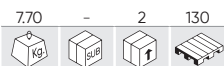

SUPPORT POUR PRESSE

GRAND BLOC



TAILLE BLOC



50827

387,00€

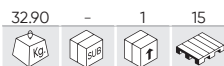

COMPRESSEUR DE RESSORTS

- Capacité : 1T (2200 lbs)
- Diamètre du ressort comprimé : 200 mm
- Longueur de compression : 200-500mm



50831

460,00€

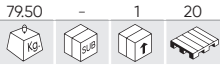

GRUE 2 TONNES PLIANTE



PIECES DE RECHANGE

52985

598,00€

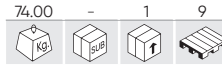

GRUE PLIANTE 1T



PIECES DE RECHANGE

50631

68,00€

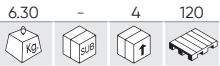

EQUILIBREUR DE CHARGE CAP. 750KG



50840

138,00€

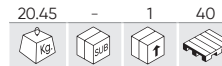

TRAVERSE SUPPORT MOTEUR 500KG (1750MM)



REF.	DESCRIPTION	kg	box	unit	€
51452	ATTELAGE ET MANIVELLE POUR REF.50840	3.43	-	1 50	69,00€

53682

98,00€

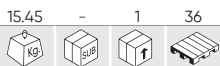

TRAVERSE SUPPORT MOTEUR 500KG (1480MM)



52055

139,00€

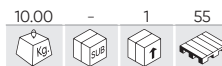

TRAVERSE SUPPORT MOTEUR UNIVERSEL



50836

148,00€

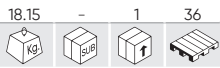

SUPPORT MOTEUR 340KG



50838

299,00€

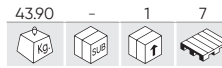

SUPPORT MOTEUR 900KG



- Dimensions pliée:
1000x500x440mm.



CHARIOT EN ACIER

54262

88,00€

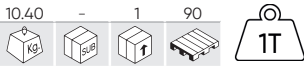

54263

130,00€

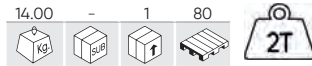

54264

240,00€

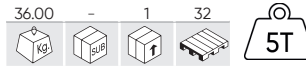

	54262	54263	54264
HAUTEUR DE LEVAGE	2,8m	2,8m	2,8m
CHUTES DE CHAÎNES	1	2	2
MESURES DE LA CHAÎNE		Chaîne de charge: 6x30mm Chaîne manuelle: 4,5x25mm	
LONGUEUR		Chaîne de charge: 3m Chaîne manuelle: 2,5m	
EFFORT CHARGE MAXIMALE	304N	310N	361N
MATÉRIEL		Chaîne de charge: Acier 20Mn2 Chaîne manuelle: Acier Q235	



52845

170,00€

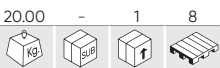

SET DE 2 RAMPES ÉLÉVATRICE 1 TON

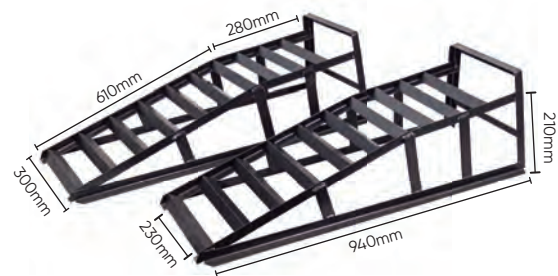

53423

199,00€

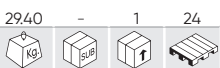

CRIC ÉLÉVATION QUAD



53969

96,00€

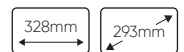
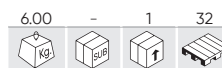

SUPPORT ÉLÉVATEUR DE MOTO



54386

5.839,00€

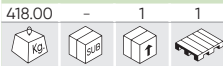

N

ASCENSEUR D'ASSEMBLAGE DE BATTERIES DE VÉHICULES ÉNERGÉTIQUES

Ce véhicule électrique à ciseaux offre les avantages ci-après : levage libre, marche flexible, fonctionnement pratique, style élégant et pas de pollution. Il peut être largement utilisé comme plate-forme de travail temporaire pour la manutention des marchandises dans les ateliers, les entrepôts, les cours de marchandises et autres petits sites. Il s'agit ainsi d'un outil idéal pour réduire la fatigue, améliorer l'efficacité de la production et assurer la sécurité du chargement et du déchargement.

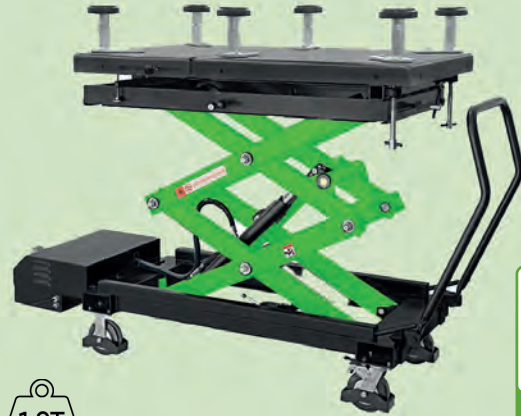

PIÈCES DE RECHANGE

Caractéristiques de chargement	Charge distribuée
Temps de levage (sans charge)	60"
Temps de descente (sans charge)	45"
Plate-forme	1290 - 1400x768mm

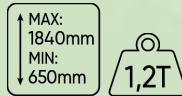

52692

129,00€

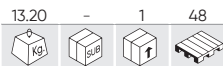

LEVAGE AUXILIERE POUR MOTO



50911

788,00€



TABLE ÉLEVATRICE HYDRAULIQUE POUR MOTO 365KG



PIÈCES DE RECHANGE

53246

1.144,00€

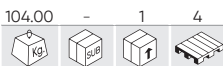

TABLE HYDRAULIQUE 360KG



50630

590,00€



TABLE ÉLEVATRICE 400KG



PIÈCES DE RECHANGE

TAMPON EN CAOUTCHOUC POUR ÉLÉVATEUR

<p>54349 8,00€</p> <p>0.48 - 68 -</p> <p>A 160mm B 120mm C 20mm</p>	<p>54350 12,50€</p> <p>0.67 - 48 -</p> <p>A 160mm B 120mm C 30mm</p>	<p>54351 14,00€</p> <p>0.97 - 32 -</p> <p>A 160mm B 120mm C 40mm</p>	<p>54352 18,00€</p> <p>1.43 - 20 -</p> <p>A 160mm B 120mm C 60mm</p>
<p>54353 23,50€</p> <p>1.85 4 12 -</p> <p>A 160mm B 120mm C 80mm</p>	<p>54354 34,50€</p> <p>2.91 - 8 270</p> <p>A 160mm B 120mm C 120mm</p>	<p>54483 14,00€</p> <p>0.70 - 40 -</p> <p>A 160mm B 120mm C 35mm</p>	<p>54484 26,00€</p> <p>1.75 - 20 -</p> <p>A 160mm B 120mm C 70mm</p>
<p>54485 36,00€</p> <p>2.40 - 8 -</p> <p>A 160mm B 120mm C 100mm</p>	<p>54355 12,00€</p> <p>0.20 - 60 -</p> <p>RAVAGLIOLI/SIRIO/SPACE A 123mm D 108mm B 26mm E 10mm C 104mm</p>	<p>54360 14,00€</p> <p>0.19 - 72 -</p> <p>RAVAGLIOLI/SIRIO/SPACE A 130mm D 125mm B 23mm E 10mm C 121mm</p>	<p>54486 9,50€</p> <p>0.10 - 120 -</p> <p>RAVAGLIOLI/SIRIO/SPACE A 100mm D 85mm B 22mm E 8,5mm C 81mm</p>
<p>54488 15,00€</p> <p>0.25 - 40 -</p> <p>RAVAGLIOLI A 150mm D 135mm B 25mm E 10mm C 128mm</p>	<p>54493 13,50€</p> <p>0.20 - 60 -</p> <p>RAVAGLIOLI A 120mm B 110mm C 27mm</p>	<p>54494 14,00€</p> <p>0.30 - 48 1152</p> <p>RAVAGLIOLI A 145mm B 135mm C 26mm</p>	<p>54357 15,00€</p> <p>0.29 - 60 -</p> <p>TWIN BUSCH A 120mm D 105mm B 30mm E 8,5mm C 100mm F 66mm</p>
<p>54358 18,50€</p> <p>0.36 - 44 -</p> <p>TWIN BUSCH A 140mm D 125mm B 25mm E 10mm C 116mm F 66mm</p>	<p>54361 14,00€</p> <p>0.25 - 52 -</p> <p>TWIN BUSCH A 140mm D 125mm B 28mm E 8mm C 120mm</p>	<p>54363 14,00€</p> <p>0.30 - 44 -</p> <p>ISTOBAL/VELYEN A 155mm D 147mm B 24mm E 6mm C 140mm</p>	<p>54365 12,50€</p> <p>0.20 - 108 -</p> <p>ISTOBAL/VELYEN A 145mm B 10mm C 60mm</p>

TAMPON EN CAOUTCHOUC POUR ÉLÉVATEUR

54359 14,00€

0.31 - 48 1440



OMCN

A 140mm
B 133mm
C 27mm

54491 17,50€

0.30 - 44 -

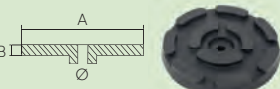

OMCN

A 145mm
B 25mm

54366 18,50€

0.30 - 80 -



NASSBAUM/AMI

A 125mm D 120mm
B 24mm
C 90mm

54362 14,00€

0.25 - 48 -

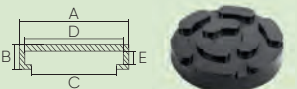

CASCOS

A 138mm D 130mm
B 25mm E 9mm
C 120mm

54487 15,00€

0.15 - 80 -



ROTARY

A 123mm D 112mm
B 22mm E 8mm
C 90,5mm

54495 18,00€

0.25 - 108 3240

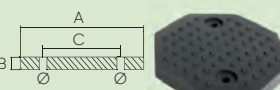

ROTARY

A 125mm
B 15mm
C 90mm

54496 16,50€

0.10 - 400 2400

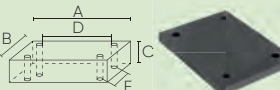

ROTARY

A 104mm D 80mm
B 82mm E 56mm
C 8mm

54497 12,50€

0.15 - 88 2700



MAHA

A 120mm D 113mm
B 22mm E 8mm
C 102mm F 83mm

54492 19,50€

0.35 - 60 -



SLIFT/IME

A 125mm D 110mm
B 25mm E 9mm
C 120mm F 83mm

54356 19,50€

0.44 - 48 1152



500E/500X/JEEP RENEGADE

A 55mm
B 100mm

54364 14,00€

0.29 - 52 -

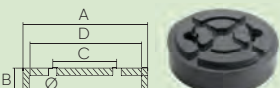

LAUNCH/TWIN BUSCH/RP TOOLS

A 120mm D 108mm
B 32mm
C 70mm

54489 19,50€

0.35 - 28 -

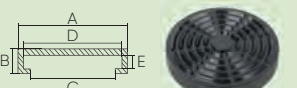

KONI/ROMERICO/CAR-O-LINER

A 160mm D 153mm
B 29mm E 10mm
C 140mm

54490 15,00€

0.20 - 88 -



ATH/HOFMANN/
HERMANN/J.A.B. BECKER

A 120mm D 110mm
B 19mm E 4mm
C 130mm

54175 34,00€

0.80 5 20 360



JEU DE 4 COUSSINS DE LEVAGE
TESLA

NR TESLA 3/X/S/Y



OUTILLAGE ELECTRIQUE

- 328 DÉMARREUR DE SAUT
- 329 ENTRETIEN DE LA BATTERIE
- 330 MULTIMETRES
- 332 INSPECTION VISUELLE
- 332 SOUDURE
- 334 ÉQUIPEMENT D'ATELIER
- 337 CLIMATISATION
- 338 THERMOMÈTRES
- 338 AUTRES



CABLES DE DÉMARRAGE

PINCE MASSIVE EN LAITON

REF.	Ø CORD	LONGUE	A	SECTION					€
51238	17mm	5m	700	70mm ²	4.95	-	2	84	138,00€
51239	15mm	7m	700	70mm ²	5.90	-	2	72	159,00€

PINCE EN LAITON

REF.	Ø CORD	LONGUE	A	SECTION					€
52069	11mm	2,5m	250	25mm ²	1.55	-	10	240	29,50€
52070	12mm	3m	350	35mm ²	1.95	-	5	160	40,00€
52071	13mm	3m	500	50mm ²	2.35	-	5	90	47,00€

PINCE MASSIVE EN LAITON AVEC PROTECTEUR SURCHARGE

REF.	Ø CORD	LONGUE	A	SECTION					€
51363	12mm	3m	350	35mm ²	2.63	-	5	120	114,00€
51365	12mm	3m	600	50mm ²	3.10	-	5	90	118,00€



REF.	DESCRIPTION					€
14145	COLLIERS DE CÂBLE DE DÉMARRAGE EN CUIVRE	0.20	-	30	-	8,50€
14146	COLLIERS DE CÂBLE DE DÉMARRAGE EN CUIVRE	0.20	-	30	1920	8,00€
14147	PINCES EN LAITON	0.35	-	15	-	25,00€
14148	PINCES EN LAITON	0.35	-	15	-	25,00€

53687 **298,00€**

11.35 - 1 14

↑ 370mm ← 370mm ↘ 209mm

DÉMARREUR DE VÉHICULES 12V

- Tension: 12V
- Batterie: 22Ah, plomb-acide (1 pièce)
- Courant de démarrage: 750 A
- Courant de crête: 1500 A



PIÈCES DE RECHANGE

- A BOUTON DE VÉRIFICATION DE LA TENSION DE LA BATTERIE INTERNE
- B MESUREUR DE TENSION DE BATTERIE INTERNE
- C INTERRUPTEUR ALLUMÉ / ÉTEINT
- D ÉCLAIRAGE LED INTÉGRÉ: AUGMENTE LA VISIBILITÉ DE LA ZONE DE TRAVAIL

53688 **495,00€**

18.05 - 1 14

↑ 370mm ← 370mm ↘ 209mm

DÉMARREUR DE VÉHICULES 12/24V

- Tension: 12V/24V.
- Batterie: 22Ah plomb-acide AGM (2 pièces).
- Courant de démarrage: 12V: 1500A/3000A.
- Courant de crête: 24V: 750A/1500A.
- Temps de charge de la batterie : Charge complète de la batterie : 40 h
- Charge jusqu'à 10-20%: 6 h



PIÈCES DE RECHANGE

- A BOUTON DE VÉRIFICATION DE LA TENSION DE LA BATTERIE INTERNE
- B MESUREUR DE TENSION DE BATTERIE INTERNE
- C INTERRUPTEUR ALLUMÉ / ÉTEINT
- D ÉCLAIRAGE LED INTÉGRÉ: AUGMENTE LA VISIBILITÉ DE LA ZONE DE TRAVAIL

51816 58,00€



TESTEUR DE BATTERIE NUMÉRIQUE

- 150Ah.
- Applicable à des batteries de 12 V.
- Mesure en SAE (CCA), EN, IEC, DIN, CA.
- Plage : 200~1 200 CAA (SAE).
- Mesureur de volt : 7 V~15 V.
- Écran 4 + 3 Leds (vert, rouge, jaune).



51235 49,00€



TESTEUR DE BATTERIE

- Pour des batteries de 6 V et 12 V.
- Charge jusqu'à 100 Ah.
- Test d'état de charge.
- Test de consommation de démarrage.
- Test de tension de charge.
- Test condition de la batterie.



52884 73,00€

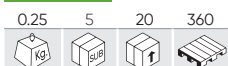

MAINTIEN DE TENSION POUR CHANGEMENT DE BATTERIES



- Utile pour se tenir au courant dans le système électrique du véhicule pendant le changement de la batterie.
- Connexion par Cable OBDII ou l'allume-cigare.



53209 8,50€



HYDROMÈTRE POUR BATTERIES

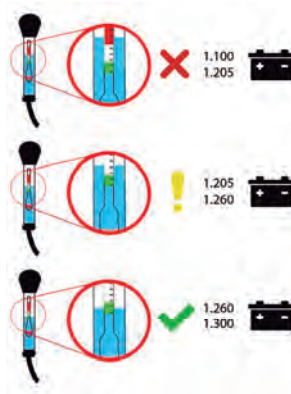

CHARGEURS DE BATTERIE

Compatible avec les types batteries plomb-acide: liquide, hélium, MF et AGM

53927 66,00€



53929 95,00€



52233

328,00€



TESTEUR DE BATTERIE ET ALTERNATEURS AVEC IMPRIMANTE

- Applicable à des batteries de 6V et 12V.
- Système de charge en allumage de 12V et 24V.
- Rang: 40 - 2000 CCA (SAE).
- Voltimetre: 1.5V - 30V.
- Jeu de Cables de 180cm.
- Contient: 1 rouleau papier thermique.



AGM, GEL, VRLA, SLI



54040

240,00€

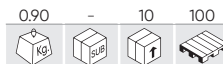

APPAREIL DE TEST AVEC FONCTION D'IMPRESSION

- Applicable aux batteries 12 V, AGM (tapis de verre absorbant), GEL (gel), VRLA (plomb-acide scellé), SLI (à électrolyte liquide).
- Applicable aux systèmes de démarrage 12/24 V.
- Plage de fonctionnement : 100 à 2 000 ampères de démarrage à froid CCA (SAE)
- Testeur de démarreur et d'alternateur.
- Langues du système disponibles : Espagnol (ES) Anglais (EN) Français (FR) Allemand (DE) Italien (IT) Portugais (PT) Roumain (RO)
- Contient: Une batterie CR2032



REF.	DESCRIPTION				€
51842	PAPIER THERMIQUE POUR IMPRIMANTE REF. 52233-54040	0.10	6	72	6,90€

54256

48,00€



PROTECTEUR DE SURTENSION AUTOMATIQUE 12/24V



52231

49,00€

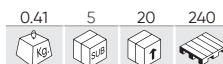

SET D'ACCESSOIRES POUR MULTIMETRE

- Ce kit est approprié pour la plupart des multimètres.

- CONTIENT**
- 2 sondes.
 - 2 pinces petites
 - 2 pinces longues.
 - Câbles d'extension.



54114

248,00€

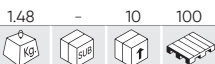

MESUREUR DE RÉSISTANCE D'ISOLATION



Catégorie d'installation :	2	Température de fonctionnement :	00 - 400C (320F - 1040F), humidité de l'air relativement inférieure à 80%
Catégorie de mesures :	CAT III	Température de stockage :	-100C - 600C (140F - 1400F), humidité de l'air relativement inférieure à 70%
Altitude :	Jusqu'à 2000 mètres	Source d'alimentation :	DC9V (6 piles "AA" de 1,5V)
Double affichage avec	afficheur LCD	Dimensions (longueur x largeur x hauteur) :	200 x 92 x 50mm
Tension AC :	0 - 750V		
Tension DC :	0 - 1000V		
Résistance :	0 - 200Ω / 200 - 2000 Ω		
Résistance d'isolement :	0 - 200MΩ / 200 - 2000 MΩ		
Taux d'échantillonnage :	2,5 fois par seconde		
Réglage du zéro :	Réglage automatique		



50942

28,00€

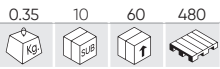

MULTIMETRE NUMERIQUE

- Digits: 3 1/2.
- Mesure: 2.000.
- Données instantanées.
- Auto déconnexion.
- Indicateur de batterie.
- Batteries de 9 V.
- Sonde de température.
- Température de -40°C a 1000°C.



AC	AC
200mV, 2V, 20V, 200V, 1000V	20mA, 200mA, 20A
DC	DC
200mV, 2V, 20V, 200V, 750V	20mA, 200mA, 20A
Ω	F
200Ω, 2KΩ, 20KΩ, 200KΩ, 2MΩ, 20MΩ, 2000MΩ	2nF, 20nF, 200nF, 2μF, 20μF, 200μF

52439

227,00€



COFFRET DE CONECTEURS ET ACCESSOIRES POUR MULTIMETRE

- 2 mesureurs de resistance variable.
- 2 lumieres led de verification.
- 2 SRS substitution et des dispositives de test.
- 2 pinces de cocodrille.
- 2 prises de raccord rapide.
- 4 sondes.
- 24 connecteurs forme ronde.
- 48 connecteurs forme plate.



52382

19,50€

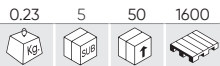

PINCE AMPEROMETRIQUE

- Instrument idéal pour les électriciens.
- Il peut mesurer la tension: AC, DC, courant AC, résistance, diode, fréquence.
- Environnement d'exploitation: 0°C a 40°C, α <80%RH.
- Environnement de stockage: -10°C a 40°C, α <85"RH.
- Alimentation: 2 piles AAA.
- Indicateur de baterie faible.
- Ecran de 3,5" avec 4 digits.
- Fonction de courant continue.
- Mesure de voltage AC/DC.



DCB 600V	FONCTIONS Test du fil en direct.
ACB 600V	
DCA -	
ACA 20A, 200A, 600A	
OHM 2KΩ, 200KΩ, 2MΩ	

52952

74,00€

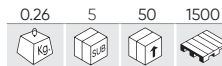

PINCE AMPEROMETRIQUE PROFESSIONNELLE

- Instrument idéal pour les électriciens.
- Il peut mesurer la tension: AC, DC, courant AC, résistance, diode, fréquence.
- Environnement d'exploitation: 0°C a 40°C, α <80%RH.
- Environnement de stockage: -10°C a 40°C, α <85"RH.
- Alimentation: 2 piles AAA.
- Indicateur de baterie faible.
- Ecran de 3,5" avec 4 digits.
- Fonction de courant continue.
- Mesure de voltage AC/DC.



DCB 20V, 600V	FONCTIONS Test du fil en direct. Test de diode. Test de continuité. Fonction ADP. Fonction de détection de phase. Commutateur ZERO.
ACB 600V	
DCA 200A	
ACA 200A	
OHM 2000Ω	

53028

5,80€

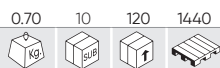

TESTEUR POUR CIRCUIT AUTOMOBILE 1,8X190MM

6-12-24V
1,8 x 190mm



- Convient pour vérifier la polarité

53029

6,80€

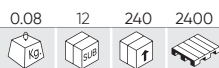

TESTEUR POUR CIRCUIT AUTOMOBILE 2X115MM

6-12-24V
2 x 115mm



53030

12,00€



TESTEUR POUR CIRCUIT AUTOMOBILE 3X142MM

6-12-24V
3 x 142mm
LED



53724

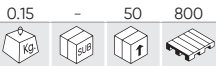

VIDÉOSCOPE WIFI

- Endoscope avec fonction de transfert d'image par Wi-Fi. Possibilité de se connecter à n'importe quel smartphone. Possibilité de travailler avec une tablette ou un ordinateur.

- Le lot de livraison comprend:
Caméra endoscopique.
Émetteur Wi-Fi.
Buse crochet.
Buse aimant.
Buse rétroviseur.

CÂBLE SEMI-RIGIDE DE 1M



Fonctionne avec JBM APP:



46,00€

53484

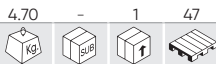

DÉTECTEUR DE LA FUITE DE GAZ

- HUILE NON COMPRISE.



CONTIENT



PIÈCES DE RECHANGE

615,00€

53977

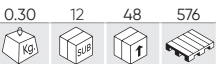

FER A SOUDER 40W

- Tension 220 à 240 V
- 40 W
- Fréquence: 50Hz
- Longueur: 240mm
- Câble: 1,3 m
- Température maximale de travail: 450°+/-10%



17,50€



53111

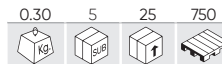

FER À SOUDER D'ÉTAIN 100W

- Voltage: 220-240V.
- Temp.: 420°C + / - 10%.
- Long: 250mm.
- Cable: 1,5m.



19,00€



53145



DÉCAPEUR THERMIQUE 2000W

- 220V-240V.
- 50Hz-60HZ.
- 2000W.
- Température de sortie d'air: 50-600°C.
- Débit d'air: 220-480L/min.
- 2 options de température: 300 et 600°C.



39,20€

53162



DECAPEUR TERMIQUE DIGITAL 2000W

- 220V-240V.
- 50Hz-60HZ.
- 2000W.
- Température de sortie d'air: 100-600°C.
- Débit d'air: 280-480L/min.



60,00€

53981

143,00€

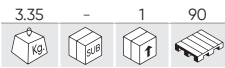

DISPOSITIF POUR SOUDAGE À L'ARC ÉLECTRIQUE MANUELLE AVEC ONDULEUR DE COURANT CONTINU 100 A

COMPREND

Porte-électrode avec câble de 2m.
Pince de mise à la terre avec câble de 1,5m.
Brosse marteau.
Écran facial manuel.



- ✓ ONDULEUR AVEC TECHNOLOGIE IGBT
- ✓ SOUDAGE À L'ARC MANUEL AVEC COURANT CONTINU
- ✓ PROTECTION CONTRE LES BRÛLURES
- ✓ PUISSANCE DE L'ARC
- ✓ AMORÇAGE DE L'ARC CHAUD



PIÈCES DE RECHANGE

53982

219,00€

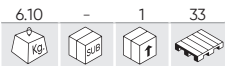

DISPOSITIF POUR SOUDAGE À L'ARC ÉLECTRIQUE MANUELLE AVEC ONDULEUR DE COURANT CONTINU 160 A

COMPREND

Porte-électrode avec câble de 2m.
Pince de mise à la terre avec câble de 1,5m.
Brosse marteau.
Écran facial manuel.



- ✓ ONDULEUR AVEC TECHNOLOGIE IGBT
- ✓ SOUDAGE À L'ARC MANUEL AVEC COURANT CONTINU
- ✓ PROTECTION CONTRE LES BRÛLURES
- ✓ PUISSANCE DE L'ARC
- ✓ AMORÇAGE DE L'ARC CHAUD



PIÈCES DE RECHANGE

53414

49,00€



CASQUE À SOUDER AVEC RÉGULATEUR MANUEL



MÉCANISME DE RÉGLAGE DE SENSIBILITÉ ET D'ASSOMBRISSEMENT

53415

188,00€



CASQUE À SOUDER AVEC RÉGULATEUR DIGITAL



RÉGULATEUR DIGITAL

CARRÉ MAGNÉTIQUE 45°, 90°, 135°

REF.	↔	📦	📦	📦	📦	€
54111	75mm	0.35	10	40	1680	4,75€
54113	100mm	0.60	10	20	1100	7,65€



54482



677,00€

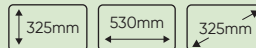

N

NETTOYEUR ULTRASONIQUE 30L

Cette machine permet de nettoyer des pièces en émettant des ultrasons. Elle est particulièrement indiquée pour le nettoyage de pièces aux formes complexes.

PUISSANCE ULTRASONIQUE : 600W	ALIMENTATION ÉLECTRIQUE : 200~240V (50HZ)
PUISSANCE DE CHAUFFAGE : 500W	NOMBRE DE TRANSDUCTEURS : 10
CAPACITÉ DU RÉSERVOIR : 30L	RÉCHAUFFEMENT : 0~80°C
FRÉQUENCE ULTRASONIQUE : 40KHZ	MATÉRIAU : ACIER INOXYDABLE SUS304
MINUTEUR: 1~30 MIN.	DIMENSIONS DU RÉSERVOIR : 500x300x200mm



53220

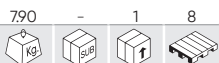

260,00€

APPAREIL DE NETTOYAGE PORTATIL

- FORMAT PORTABLE.
- Fermeture hermétique pour éviter les pertes durant le transport.
- Utiliser avec un dissolvant de base aqueuse.
- Interrupteur d'allumage latéral.
- Filtre de nettoyage de liquide inclus.
- Crochet pour outils et tuyau inclus.
- Compartiments de rangements.
- Séparation de zones de travail, zone de nettoyage et zone de séchage, permet un travail de plusieurs pièces à la fois.
- Capacité maximale: 27.5L.
- Connexion a 220V.
- Capacité de pompage: 1.000 L/h.
- Capacité de travail: 20L.
- Tuyau de 1,10m de long.



TOURET A MEULER

REF.	W	V/W	RPM	HZ	Ø I	Ø II	Ø III	Icon 1	Icon 2	Icon 3	Icon 4	€
53656	450W	230V/450W	2950RPM	50Hz	ø 150mm	ø 20mm	ø 12,7mm	11.05	-	1	50	198,00€
53657	600W	230V/600W	2950RPM	50Hz	ø 200mm	ø 25mm	ø 15,88mm	16.35	-	1	24	248,00€
53658	250W	230V/250W	2950RPM	50Hz	ø 150mm	ø 20mm	ø 12,7mm	6.95	-	1	60	99,00€
53659	250W	230V/250W	2950RPM	50Hz	ø 150mm ø 200mm	ø 20mm ø 40mm	ø 12,7mm ø 20mm	9.70	-	1	15	121,00€



53656
53657



53658



53659

52195



170,00€

TOURET A MOLET 150MM

- Puissance nominale d'entrée: 250W.
- Tension nominale: 230V / 50Hz.
- Vitesse sans charge: 2.950Rpm.
- Ø de rue: 150 x 20 x 12.7mm.
- Poids net: 8,5Kg.



53660



146,00€

BASE EN ACIER POUR MEULEUSE DE BANC

- Hauteur: 790mm.
- Dimensions de la plaque de fixation: 250x280mm.
- Poids: 8kg.



54342 858,00€

49.50 - 1 4

N

FOINTAINE DE NETTOYAGE AVEC THERMOSTAT

70-120 PSI 0,8 L/min
 MAX 50°C 8-14L
 5 CFM 740mm 560mm 452mm

1710mm
 790mm
 610mm



Équipement conçu pour un lavage parfait des pièces sales. Il comprend un pistolet pneumatique pour le nettoyage avec solvant et peut également s'utiliser pour sécher les pièces à l'aide d'air comprimé.

Grâce à sa cabine fermée, l'opérateur est totalement protégé des éclaboussures et des odeurs de solvant. Il dispose d'un thermostat avec lequel vous pouvez régler le niveau de température du liquide de nettoyage et de la lumière à l'intérieur du réservoir pour une meilleure visualisation.

PIÈCES DE RECHANGE

54341 643,00€

51.00 - 1 7

N

MACHINE DE SABLAGE 220L

100V 40-120 PSI
 240V
 15-25 PSI 33L
 860mm 560mm 560mm

390mm
 905mm
 632mm



Cette machine de sablage est facile à utiliser, portable et offre un environnement sûr, prêt à l'emploi avec le média abrasif de votre choix avec la possibilité de nettoyer les pièces oxydées, les taches, etc.

PIÈCES DE RECHANGE

52980 480,00€

45.00 - 1 4

150L

FONTAINE DE NETTOYAGE 150L ÉLECTRIQUE

MESURES TOTALES MACHINE
 890mm 1.090mm 520mm

MESURES INTÉRIEURES DÉPÔT
 270mm 1.060mm 490mm



PIÈCES DE RECHANGE

50632 298,00€

24.20 - 1 6

100L

FONTAINE DE NETTOYAGE 100L ÉLECTRIQUE

MESURES TOTALES MACHINE
 890mm 780mm 540mm

MESURES INTÉRIEURES DÉPÔT
 260mm 725mm 490mm



PIÈCES DE RECHANGE

- Débit: 25L.
 - Fonctionne avec des solutions de nettoyage de moteur solubles dans l'eau.

- Débit: 25L.
 - Fonctionne avec des solutions de nettoyage de moteur solubles dans l'eau.

51837

195,00€

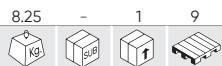

ASPIRATEUR INDUSTRIEL DE 30 LITRES SEC

30L

Capacité (l)	30
Volume d'aspiration par seconde (l/s)	26
Puissance	1x1.200W
Tension	230V
Fréquence	50Hz
Aspiration	> 17Kpa
Ø du tuyau	32mm
Longueur du tuyau	1,5m
Longueur de câble	4,5m
Étanchéité	IPx4



CONTIENT



PIÈCES DE RECHANGE

* Cet aspirateur est doté d'un système qui permet une mise en marche automatique s'il est raccordé à un broyeur.

51838

667,00€



ASPIRATEUR INDUSTRIEL DE 80 LITRES (SEC ET HUMIDE)

80L

Capacité (l)	80
Volume d'aspiration par seconde (l/s)	50
Puissance	3x1.000W
Tension	230V
Fréquence	50Hz
Aspiration	> 20Kpa
Ø du tuyau	48mm
Longueur du tuyau	2m
Longueur de câble	4,5m
Étanchéité	IPx4



CONTIENT



PIÈCES DE RECHANGE

53947

145,00€

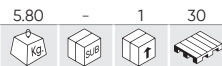

LAVEUSE HAUTE PRESSION 1400 W

230V	1400W	MAX 105 Bar	MAX AGUA WATER 50°C	5,0Kg
MAX 6,8L/min	5m	3m	50 Hz	IP X5

CONTIENT



PIÈCES DE RECHANGE

- A PISTOLET DE DISTRIBUTION
- B CORDON D'ALIMENTATION
- C SORTIE D'EAU
- D TUYAU HAUTE PRESSION

53948

324,00€

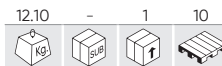

LAVEUSE HAUTE PRESSION 2400 W

230V	2400W	MAX 180 Bar	MAX AGUA WATER 50°C	10,0Kg
MAX 8L/min	5m	8m	50 Hz	IP X5

CONTIENT



PIÈCES DE RECHANGE

- A TUYAU HAUTE PRESSION
- B PISTOLET DE PULVÉRISATION
- C SORTIE D'EAU
- D CORDON D'ALIMENTATION

53189 128,00€

7.10 - 1 12

1325mm 480mm Ø565mm

VENTILATEUR SUR PIED

230V 50 Hz
120V

X3 SPEED RPM 1050/1150/1300 CFM 2700/3000/3400



54125 152,00€

8.25 - 1 14

1250mm 400mm Ø430mm

VENTILATEUR PULVÉRISATEUR D'EAU

3,2L 75W
220V 50 Hz
240V
0.5-7.5H
moteur de cuivre / copper engine
mando / remote

QR code and remote control image.

PIÈCES DE RECHANGE



53543 13,80€

0.75 5 20 160

VENTILATEUR D'AUTOMOBILE - 12 V

Icons for car, bus, and truck.

12V 15,20cm

X2 VITESSES



53190 98,00€

6.10 - 1 16

575mm 230mm Ø620mm

VENTILATEUR SUR SOL

230V 50 Hz
120V
X3 SPEED RPM 1050/1150/1300 CFM 2700/3000/3400



54229 48,00€

1.76 - 4 80

CHAUFFAGE 2 KW

2Kw 220V 240V 1000-3000 RPM 20m²
SPCC PTC 197m³/h 210-160 -217mm



54229
54230

54230 68,00€

3.10 - 1 56

CHAUFFAGE 3 KW

3Kw 220V 240V 1000-3000 RPM 30m²
SPCC PTC 197m³/h 210-160 -217mm

54231 138,00€

4.80 - 1 27

CHAUFFAGE 5 KW

5Kw 380V 400V 1000-3000 RPM 48m²
SPCC PTC 588m³/h 300-235 -345mm
1,4m

54231
54232

54232 248,00€

7.90 - 1 12

CHAUFFAGE 9 KW

9Kw 380V 400V 1000-3000 RPM 80m²
SPCC PTC 1180m³/h 395-307 -455mm
1,4m



OUTILLAGE ELECTRIQUE

52162

38,00€

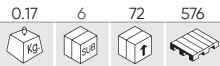

TERMOMETRE LASER -50°C A 550°C

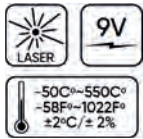

52450

105,00€

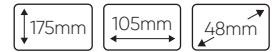
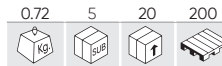

THERMOMETRE LASER -50°C A 1.000°C

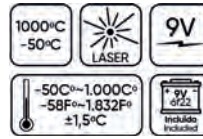

53503

12,00€

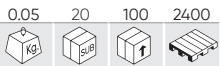

THERMOMETRE NUMERIQUE DE CONTACT



53585

168,00€

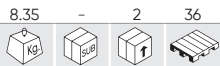

ENROULEUR CABLE ELECTRIQUE

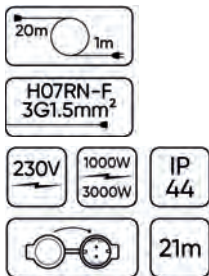

53586

168,00€

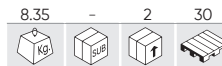

ENROULEUR CABLE ELECTRIQUE 21M

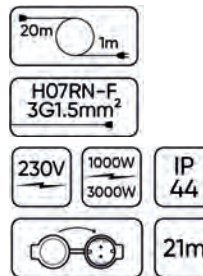

REF. DESCRIPTION

14771 SUPPORT MURAL POUR ENROULEURS DE TUYAUX FLEXIBLES RÉF. 53532, 53581, 53585, 53586

0.35 - 30 - 10,50€

53584

119,00€



ENROULEUR CABLE ELECTRIQUE - 12M

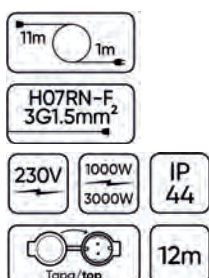

53526

119,00€



ENROULEUR CABLE ELECTRIQUE 12M

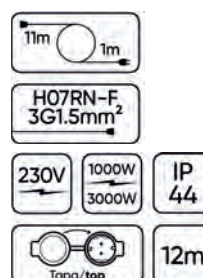

REF. DESCRIPTION

14774 SUPPORT MURAL POUR ENROULEURS DE TUYAUX FLEXIBLES RÉF. 53526, 53584

0.40 - 10 - 10,50€

51831 24,00€

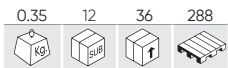

PISTOLET A COLLE

- Voltage: 100~ 230 V.
- Température: 190~230 °C.
- Consommation: 60~150 W.
- Diám. de bec: 2.0~2.3 mm.
- Plage: de 8 à 16g de produit/minute.



REF.	DESCRIPTION					€
51859	CLOQUE 10BÂTONNETS DE COLLE	0.12	8	32	1520	3,80€

51033 98,00€

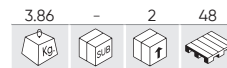

ENROULEUR ÉLECTRIQUE D'ATELIER 25M



- Protection de surcharge.
- Protection pour enfants.



EXTENSION DU CABLE ÉLECTRIQUE

REF.	m					€
53166	3m	0.45	5	30	600	10,50€
53167	5m	0.65	5	20	600	12,50€
53168	10m	1.20	-	10	300	19,00€



52643 596,00€

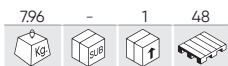

RESCULPTEUR DE PNEUS

GRADABLE NUMÉRIQUEMENT

REF.	DESCRIPTION				€
11974	RECHANGE R1 POUR RESCULPTEUR DE PNEUS REF. 52643	0.01	20	500	1,80€
11975	RECHANGE R2 POUR RESCULPTEUR DE PNEUS REF. 52643	0.01	20	500	1,80€
11976	RECHANGE R3 POUR RESCULPTEUR DE PNEUS REF. 52643	0.01	20	500	1,80€
11977	RECHANGE R4 POUR RESCULPTEUR DE PNEUS REF. 52643	0.01	20	500	1,80€
11978	RECHANGE R5 POUR RESCULPTEUR DE PNEUS REF. 52643	0.04	20	100	1,80€
11979	RECHANGE W1 POUR RESCULPTEUR DE PNEUS REF. 52643	0.04	20	500	1,80€
11980	RECHANGE W2 POUR RESCULPTEUR DE PNEUS REF. 52643	0.04	20	500	1,80€
11981	RECHANGE W3 POUR RESCULPTEUR DE PNEUS REF. 52643	0.01	20	500	1,80€
11982	RECHANGE W4 POUR RESCULPTEUR DE PNEUS REF. 52643	0.01	20	200	1,80€
11983	RECHANGE W5 POUR RESCULPTEUR DE PNEUS REF. 52643	0.04	20	500	1,80€



RECHANGES

REF.	11974	11975	11976	11977	11978
TYPE DE LAME	R1	R2	R3	R4	R5
LAME ARRONDIE	mm	mm	mm	mm	mm
	A 3	5	6	8	10
	B 7	7	10	12	12
	C 5	8	15	16	18
	D 21	21	23	25	24

REF.	11979	11980	11981	11982	11983
TYPE DE LAME	W1	W2	W3	W4	W5
LAME CARRÉE	mm	mm	mm	mm	mm
	A 3	5	7	9	11
	B 7	7	10	12	12
	C 5	6	10	13	15
	D 21	21	22	24	23

52598

1.080,00€

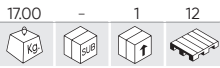

ROBOT TONDEUSE



PIÈCES DE RECHANGE

Robot tondeuse moderne et fonctionnelle, parfait pour l'entretien et le bien être de votre pelouse et de vos espaces verts. Il est équipé d'un moteur brushless, alimenté par une puissante batterie de 5200 Ah, pour une autonomie d'environ 150 minutes. Le plateau de coupe à trois lames en acier qui effectue une coupe mulching. Ce système de coupe broie très finement l'herbe, puis la dépose directement sur le sol, donnant à la pelouse un aspect impeccable sans procéder à l'enlèvement des restes. De plus, avec cette coupe, l'herbe déposée sur la pelouse va se décomposer et devenir un nutriment pour le sol, créant un cycle biologique totalement naturel. Le câble périphérique et les piquets fournis permettent une installation facile et sans outil.



CONNEXION DE L'APPLICATION



- A MOTOR BRUSHLESS
- B BOUTON STOP
- C STATION DE CHARGE
- D ROUE ARRIÈRE
- E COUVERCLE DE LA POIGNÉE

54252

199,00€



BALAYEUSE À POUSSÉE MANUELLE

- A RÉCIPIENT DE RÉCUPÉRATION DES SALETÉS
- B CORPS PRINCIPAL
- C BROSSE À DISQUE GAUCHE
- D BROSSE À DISQUE DROITE
- E CAPUCHON SUPÉRIEUR
- F POUSSER LA POIGNÉE SUPÉRIEURE
- G POIGNÉE DE POUSSÉE INFÉRIEURE
- H POIGNÉE DE TRANSPORT

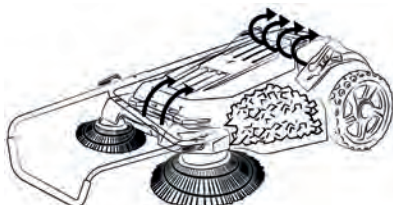
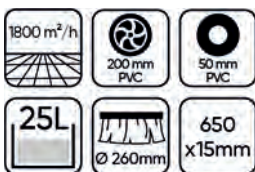

PIÈCES DE RECHANGE

ÉNERGIES RENOUVELABLES ET MOBILITÉ DU FUTUR

342 CÂBLES DE RECHARGE POUR VOITURES ÉLECTRIQUES

342 CHARGEURS POUR VOITURES ÉLECTRIQUES

343 GÉNÉRATEUR D'ÉLECTRICITÉ

344 OUTILS ISOLÉS



CÂBLE DE CHARGE

TIPO 1-2 TYPE 1-2

REF.	DESCRIPTION					€
54053	CÂBLE DE CHARGE POUR VOITURE ÉLECTRIQUE, 3,6KW, 16 A, DU TYPE 1 AU TYPE 2 (SINGLE-PHASE)	2.15	-	5	-	248,00€
54054	CÂBLE DE CHARGE POUR VOITURE ÉLECTRIQUE, 7,5KW, 32 A, DU TYPE 1 AU TYPE 2 (SINGLE-PHASE)	2.90	-	5	100	268,00€

-25°
+55°

Tipo
1-2

IP66

5m



TIPO 2-2 TYPE 2-2

REF.	DESCRIPTION					€
54055	CÂBLE DE CHARGE POUR VOITURE ÉLECTRIQUE, 3,6KW,16 A, DU TYPE 2 AU TYPE 2 (SINGLE-PHASE)	2.15	-	5	100	220,00€
54056	CÂBLE DE CHARGE POUR VOITURE ÉLECTRIQUE, 11KW, 16 A, DU TYPE 2 AU TYPE 2 (TRIPHASÉ)	2.85	-	5	102	260,00€
54057	CÂBLE DE CHARGE POUR VOITURE ÉLECTRIQUE, 7,5KW, 32 A, DU TYPE 2 AU TYPE 2 (SINGLE-PHASE)	2.95	-	5	102	248,00€
54058	CÂBLE DE CHARGE POUR VOITURE ÉLECTRIQUE, 22KW, 32 A, DU TYPE 2 AU TYPE 2 (TRIPHASÉ)	3.85	-	5	100	348,00€

-25°
+55°

Tipo
2-2

IP66

5m



CHARGEUR SECTEUR

REF.	DESCRIPTION					€
52600	CHARGEUR SECTEUR 3,6 KW, 16 A, POUR VOITURES ELECTRIQUES (SINGLE-PHASE)	4.65	-	4	80	884,00€
52902	CHARGEUR SECTEUR 7,5 KW, 32 A, POUR VOITURES ELECTRIQUES (SINGLE-PHASE)	4.90	-	4	40	970,00€
52903	CHARGEUR SECTEUR 11 KW, 16 A, POUR VOITURES ELECTRIQUES (TRIPHASÉ)	5.25	-	1	40	1.100,00€

295mm

195mm

65mm

IP66

-25°
+55°

Tipo
2



54265

1.290,00€

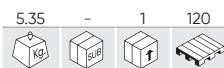

CHARGEUR SECTEUR 22 KW, 32 A, POUR VOITURES ÉLECTRIQUES (TRIPHASÉ)



Trifásico
Three-Phase



Rejoignez le futur, avec notre système de recharge rapide pour votre voiture électrique. Design moderne et minimaliste. Aujourd'hui, avec le chargeur mural JBM, vous pouvez transformer votre garage, terrasse ou parking de bureau en un lieu convivial pour votre VE / PHEV.

REF.	DESCRIPTION	Box	Weight	Volume	Quantity	€
16130	TESTEUR DE COURANT POUR CHARGEUR 54265	0.40	-	15	-	290,00€
16198	CARTE D'IDENTIFICATION RADIO FRÉQUENCE (CARTE RFID) - 54265	0.01	-	-	-	5,00€

54059

428,00€



STATION DE CHARGE PORTABLE 16 A AVEC CÂBLE DE CHARGE TYPE 2



Avec ce chargeur mobile, chargez votre véhicule où que vous soyez, avec une prise de courant normale, plus de frayer sur la route. Egalement une solution rapide et économique pour recharger les voitures électriques dans votre atelier. Écran LCD avec accès aux paramètres les plus importants, câble de type 2 intégré, design compact, boîtier extrêmement résistant et longueur totale de câble de 5 m est un gage de confort d'utilisation et de fiabilité.

REF.	DESCRIPTION	Box	Weight	Volume	Quantity	€
15460	CARTE D'IDENTIFICATION RADIO FRÉQUENCE (CARTE RFID)	0.01	-	250	-	5,00€

53970

3.790,00€

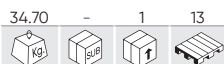

STATION DE PUISSANCE 1920WH/48V 40AH

MPPT	CC-CA	2W(x2) LED	200VAC ±10%	Carga rápida Fast Charging 54V/10A 3-4H	Carga solar Solar Charging 54V/7.5A 4-5H
50-60 Hz	UNIVERSAL	12V 10A			
3000W Salida nominal de CA Rated AC output		1920Wh LiFePO4			
5000W Pico de salida de CA Peak AC output		x2000 Ciclos de carga Battery life cycles			
USB-QC 5V 9V/12V/3A	DC(x2) 12V/10A	Temperatura de descarga Discharging Temperature -10°C/60°C		Temperatura de carga Temperature 0°C/45°C	
USB-Type-C 5V/3A - 9V/2A 12V/1.5A	USB 5V 2.4A*2				

L'usine de force motrice portable est un générateur électrique puissant, portable et alimenté à l'énergie solaire. En l'absence de soleil, il peut également être chargé à partir de n'importe quelle source d'énergie.

CONTIENT

- CHARGEUR DE BATTERIE
- CHARGEUR SOLAIRE PAR PLAQUE SOLAIRE
- CÂBLE CONNECTEUR PAR CHARGEUR MURAL

COMPATIBLE AVEC
54321



54321

898,00€



PANNEAU SOLAIRE 200 W

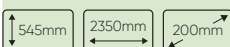

REF.	DESCRIPTION	Box	Weight	Volume	Quantity	€
15448	JEU DE 2 CONNECTEURS MC4 1 000 V 30 A	0.01	-	186	-	5,50€

53940

13,20€



POTEAU DE PLASTIQUE POUR CHAINES - JAUNE / NOIR

- Matériau: PVC.
- Base gonflable.

CHAÎNE NON INCLUS.



SIGNALISATION SPÉCIALE HAUTE TENSION



54326

7,30€



N

CHAÎNE PVC - JAUNE/NOIR
7m



53987

9,50€



RUBAN DE SIGNALISATION JAUNE / NOIR - 200M

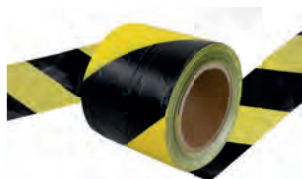

53942

0,50€

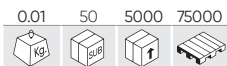

MAILLE DE CHAÎNE EN PLASTIQUE NOIR



54322

19,00€

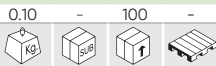

N

JEU DE 2 PANNEAUX D'AVERTISSEMENT HAUTE TENSION



52382

19,50€

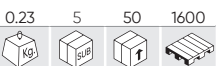

PINCE AMPEROMETRIQUE

DCB	600V
ACB	600V
DCA	-
ACA	20A, 200A, 600A
OHM	2KΩ, 200KΩ, 2MΩ



52952

74,00€



PINCE AMPEROMETRIQUE

DCB	20V, 600V
ACB	600V
DCA	200A
ACA	200A
OHM	2000Ω



50942

28,00€

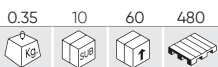

MULTIMETRE NUMÉRIQUE

- Digits: 3 1/2.
- Mesure: 2.000.
- Données instantanées.
- Auto déconnexion.
- Indicateur de batterie.
- Batteries de 9 V.
- Sonde de température.
- Température de -40°C à 1000°C.



54091

441,00€



TROUSSE À OUTILS AVEC ISOLATION VDE - 26 PIÈCES

26PCS
3/8"
CrV
VDE
GS: Geprüfte Sicherheit
1000V
IEC 60900C



54093

441,00€



MODULE D'OUTILS VDE AVEC ISOLATION EVA (ÉTHYLENE VINYLE ACÉTATE) - 26 PIÈCES

26PCS
3/8"
CrV
VDE
GS: Geprüfte Sicherheit
1000V
IEC 60900C



53154

462,00€

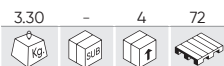

TROUSSE À OUTILS ISOLANTS 20 PIÈCES DE 3/8"

20PCS
3/8"
CrV
VDE
GS: Geprüfte Sicherheit
1000V
IEC 60900C



15162

30,20€

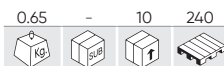

MODULE D'OUTILS VDE EN FIBRE DE CARBONE, PLATEAU EN EVA - 8 PIÈCES

8PCS
VDE
GS: Geprüfte Sicherheit
1000V
IEC 60900C



52519



JEU DE 7 TOURNEVIS ISOLÉS 1000V

7PCS
CrV
VDE
GS: Geprüfte Sicherheit
1000V
IEC 60900:2004

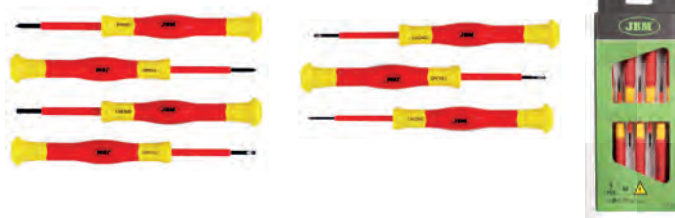

25,50€

GANTS ISOLANTS POUR TRAVAUX SOUS TENSION

REF.	DESCRIPTION	Box	Volume	Weight	Quantity	€
54130	T.9	0.35	-	1	100	58,00€
54131	T.10	0.40	-	1	100	58,00€

AZC
LATEX
CAT III
CLASS 0
1000V AC / 1500V DC
IEC ELECTRICAL SAFETY
GLOVES 60903-2014 CLASS 0



COUPEAU ISOLANT

REF.	DESCRIPTION	Box	Volume	Weight	Quantity	€
53164	DROIT	0.10	6	36	1152	16,50€
53165	COURBÉ	0.10	6	36	1152	19,60€

CrV
VDE
GS: Geprüfte Sicherheit
1000V
IEC 60900C



SERVANTE D'OUTILS 7 TIROIRS

54236 1.856,00€

67.70 - 1 4

54233 1.856,00€

67.70 - 1 4

54234 1.856,00€

67.70 - 1 4

54235 1.856,00€

67.70 - 1 4



CONTIENT

REF.	UNI.	€	REF.	UNI.	€	REF.	UNI.	€			
A	52162	1	38,00€	E	54093	1	441,00€	I	54132	1	190,00€
B	53940	4	13,20€	F	54114	1	248,00€	J	54241	1	120,00€
C	54326	1	7,30€	G	54129	1	110,00€				
D	53942	8	0,50€	H	54130	1	58,00€				

54386

418.00 - 1 1

ASCENSEUR D'ASSEMBLAGE DE BATTERIES DE VÉHICULES ÉNERGÉTIQUES

Caractéristiques de chargement	Charge distribuée
Temps de levage (sans charge)	60"
Temps de descente (sans charge)	45"
Plate-forme	1290 - 1400x768mm



1840mm 770mm 650mm

5.839,00€

1,2T
MAX: 1840mm
MIN: 650mm



54241

1.10 - 1 50

PERCHE DE SAUVETAGE ISOLÉE - 45KV



120,00€

Ø28mm 1650mm 370mm

54129

2.10 - 5 200

TAPIS ISOLANT CLASSE 0

CLASS 0
ENROLLABLE ROLLS
SLIP RESISTANT
OIL RESISTANT
RECYCLABLE
1000V AC / 1500V DC
IEC ELECTRICAL SAFETY
MATTING 60903-2024 CLASS 0

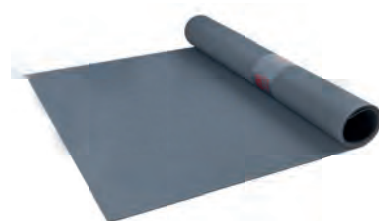

110,00€

1000mm 600mm 2mm

54132

0.70 - 1 72

ÉCRAN FACIAL ISOLANT POUR LES TRAVAUX ÉLECTRIQUES

ANTI-RALLADURAS / SCRACHING PROOF
ANTI-VAHO / ANTI FOG
EN 170:2022
EN 166:2001
ANSI Z87.1
CLASS 1



54114

1.48 - 10 100

MESUREUR DE RÉSISTANCE D'ISOLATION

2000MΩ
1000V
750V
CAT III



ACCESSOIRES D'ATELIER

348 ENROULEURS DE TUYAUX

349 ÉCHELLES

350 CHARIOTS ET PLATEFORMES



ENROULEUR DE TUYAU D'AIR

REF.	m					€
53582	22m	10.85	-	1	14	174,00€
53583	22m	10.75	-	1	14	174,00€
53532	13m	6.60	-	2	30	119,00€
53581	13m	6.70	-	2	30	119,00€
53881	11m	4.50	-	4	48	79,00€
53882	11m	4.50	-	4	48	79,00€

300 PSI
20 BAR

3/8"

Ø 95mm



REMOBINAGE AUTOMATIQUE

ENROULEUR D'EAU RACCORD

REF.	m					€
53872	16,5m	7.50	-	1	21	118,00€

15m + 1,5m

120 PSI
8 BAR

3/4"

Ø 15.8mm
Ø 11.5mm

PVC



PIÈCES DE RECHANGE



ENROULEUR CABLE ELECTRIQUE

REF.	m					€
53586	21m	8.35	-	2	30	168,00€
53585	21m	8.35	-	2	36	168,00€
53584	12m	5.10	-	4	48	119,00€
53526	12m	5.15	-	4	48	119,00€

230V

1000W
3000W

IP44

H07RN-F
3G1.5mm²



REMOBINAGE AUTOMATIQUE



ENROULEUR D'HUILE RACCORD 1/2" 15M

REF.	m					€
50797	16m	26.60	-	1	14	490,00€

- À base d'huile/bobine
- Longueur du tuyau : 15+1 m
- Pression de service max. : 2 450 psi
- Entrée d'air : 1/2" BSPT (filetage conique britannique)
- Sortie d'air : 1/2" (filetage conique britannique)
- Matériau : acier

160
BAR

ÉCHELLE TÉLESCOPIQUE

REF.	DESCRIPTION					€
51982	ÉCHELLE TÉLESCOPIQUE 6 PAS 2M	5.51	-	1	34	120,00€
51983	ÉCHELLES TÉLESCOPIQUE 10 PAS 3.2M	9.41	-	1	34	185,00€
51984	ÉCHELLES TÉLESCOPIQUE 12 PAS 3.8M	9.78	-	1	22	190,00€

RENCONTRE AVEC: EN 131

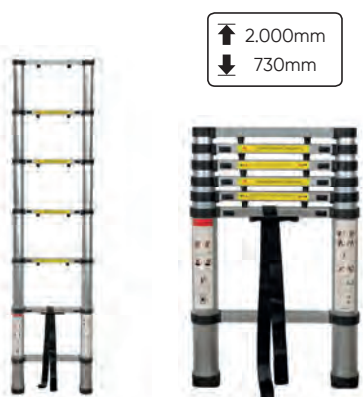

↑ 2.000mm
↓ 730mm

51982

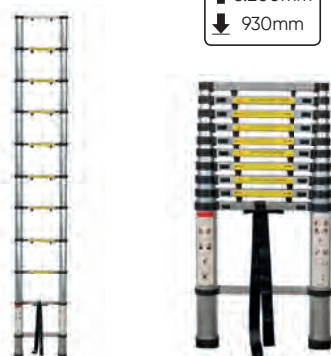

↑ 3.200mm
↓ 930mm

51983

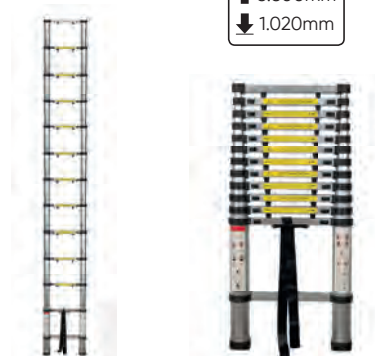

↑ 3.800mm
↓ 1.020mm

51984

52149

Kg				
14.00	-	1	14	

ÉCHELLES TÉLESCOPIQUE TRANSFORMABLE

- Échelle pliante et légère.
- Système de pliage par blocage.
- Fabriqué en aluminium et en plastique.
- Hauteur pliée: 835mm.
- Hauteur étendue: 3800mm.
- Hauteur déployée: 1900mm.



230,00€

RENCONTRE AVEC: EN 131

54176

188,00€

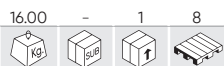

ÉCHELLE MULTIFONCTIONNELLE

- Longueur maximale : 3,7 m
- Capacité : 150 kg
- Matériel : Aluminium
- Épaisseur de l'aluminium : 1,2 mm
- Espace entre deux échelons : 28 cm



RENCONTRE AVEC: EN 131

CONTIENT

REF. DESCRIPTION

15866 JEU DE 2 PLATAFORMES POUR RÉF.54176

5.00	-	1	-	32,00€
------	---	---	---	--------

50517

129,00€

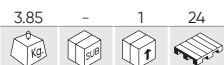

ESCABEAUX À 4 MARCHES

- DE 4 MARCHES
- Hauteur totale: 1,30m.
 - Hauteur max: 0,79m.



50518

169,00€



ESCABEAUX À 6 MARCHES

- DE 6 MARCHES
- Hauteur totale: 1,91m.
 - Hauteur max: 1,31m.



52230

398,00€



PLATE-FORME DE TRAVAIL TÉLESCOPIQUE

RENCONTRE AVEC: EN 131



MIN			MAX		
520mm	1090mm	300mm	900mm	1750mm	300mm

REF. DESCRIPTION

10964 PROTÈGE ANGLES POUR PLATE-FORME AVEC REF. 52230

10965 EBÔUT POUR BARREAUX POUR PLATE-FORME REF. 52230

10966 PIED DE RECHANGE POUR PLATE-FORME AVEC REF. 52230

0.01	-	1	-	9,00€
0.01	-	1	-	6,00€
0.06	-	1	-	13,50€

50656

290,00€

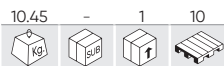

RENCONTRE AVEC: EN 131

JEU DE 2 PLATE-FORME DE TRAVAIL EN ALUMINIUM



REF.	cm					€
11897	100x30x30cm	4.66	-	1	16	155,00€
15552	130x30x55cm	6.80	-	1	18	181,00€

50913

195,00€

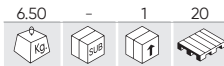

RENCONTRE AVEC: EN 131

PLATE-FORME DE TRAVAIL EN ALUMINIUM



52202

88,00€

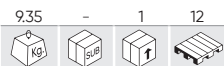

DIABLE ACIER CAP. 200KG



REF.	DESCRIPTION					€
12055	ROUE	1.11	10	160	20,00€	

50924

342,00€



CHARIOT PORTE BIDONS SPÉCIAL GRAISSAGE

200L



52200

88,00€

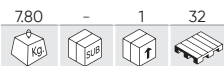

CHARIOT EN ACIER CAP. 130KG



ÉLARGIE

PLIÉ



54305

232,50€



N

CHARIOT A PLATEFORME PLIABLE EN ALUMINIUM 300KG

ÉLARGIE

PLIÉ



54308

89,00€



N

CHARIOT PLIANT EN ALUMINIUM 90KG



ÉLARGIE



PLIÉ

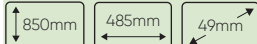

54310

57,00€



N

CHARIOT PLIANT EN ALUMINIUM 75KG



ÉLARGIE



PLIÉ

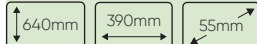

54306

219,50€

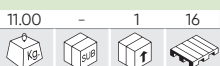

N

CHARIOT PLIANT EN ALUMINIUM 250KG



ÉLARGIE

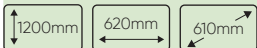

PLIÉ



54309

71,00€



N

CHARIOT MONTE-ESCALIER PLIANT



ÉLARGIE

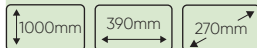

PLIÉ

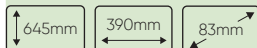

ACCESSOIRES POUR VÉHICULES

- 354 SIGNALISATION
- 355 TROUSSE DE PREMIERS SECOURS
- 357 AMPOULES
- 358 KITS DE PREMIERS SECOURS
- 359 SÉCURITÉ
- 359 JEUX DE SOUFFLETS DE CARDAN ET PINCES
- 361 BALAIS
- 362 ESSUIE-GLACES
- 363 VÉLO
- 364 AUTRES
- 366 CAPTEURS DE STATIONNEMENT
- 366 TUBES FLEXIBLES



ACCESSOIRES POUR VÉHICULES

53778

4,50€

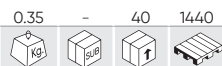

TRIANGLE DE PRESIGNALISATION 27R032736



RENCONTRE AVEC: E4 27R-032736

52795

5,80€



TRIANGLE DE PRESIGNALISATION 27R032738



RENCONTRE AVEC: E4 27R-032738

54298

7,50€



2 TRIANGLE DE PRESIGNALISATION 27R032736



RENCONTRE AVEC: E4 27R-032736

N

GILET FLUE HOMOLOGUE

RENCONTRE AVEC: EN ISO20471:2013

+A1:2016

51817

4,50€

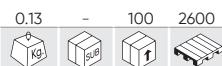

Bande marqué

50654

4,00€



50966

4,00€

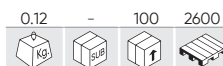

50966C

3,00€

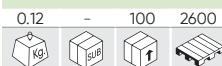

N

BANDE POUR VÉHICULES DE TRANSPORT DE MARCHANDISES

REF.					€
51935		1.04	10	280	135,00€
51936		1.04	10	140	135,00€
51937		1.02	10	280	135,00€

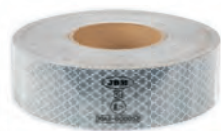

Approbation: RÈGLEMENT CEPE/ONU 104R

- Application à partir du 10 juillet 2011 selon la modification du Règlement Général sur les Véhicules, approuvé par le Royal Décret 2822/1998, du 23 déc. 2010.
- Bobines indivisibles de 50m.

PLAQUE D'AVERTISSEMENT V-20 "FRET SURDIMENSIONNÉ"

REF.					€
53636	FABRIQUÉ EN POLYPROPYLÈNE POUR UNE MAJEURE FLEXIBILITÉ	0.87	25	700	22,00€
53507	PARTIE AVANT EN POLYMÉTHACRYLATE DE MÉTHYLE (PMMA) ET FACE ARRIÈRE EN ALUMINIUM	0.75	25	800	27,00€



KIT D'URGENCE ET DE SÉCURITÉ

POCHETTE AVEC RIVET

REF.						€
51692	550x90x130mm	0.11	-	100	1600	3,55€
51693	550x90x130mm	0.12	-	100	1200	3,55€
51694	550x90x130mm	0.14	-	100	1200	3,55€
51696	550x90x130mm	0.12	-	80	1200	3,55€



SAC NOIR AVEC LISERÉ SPÉCIAL

REF.						€
11328	557x110x70mm	0.12	-	100	1200	4,00€



53721 18,80€

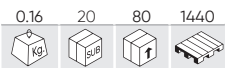

BALISE D'URGENCE LED



KIT DE SÉCURITÉ POCHE PVC

REF.							€
53185	x1	0.69	-	10	200	13,20€	
53186	x2	1.04	-	10	200	13,20€	

* Double triangle, obligatoire uniquement en Espagne.

TARIF PAR QUANTITÉ; NOUS CONSULTER
(IMPRESSION ET SÉRIGRAPHIE EN OPTION)

POCHETTE MINI

REF.						€
53621	550x150mm	0.05	-	100	3200	2,50€
53622	550x150mm	0.05	-	100	3200	2,50€
53623	550x150mm	0.05	-	100	3200	2,50€
53624	550x150mm	0.05	-	100	3200	2,50€



POCHETTE NYLON NOIRE

REF.						€
15619	330x100x80mm	0.09	-	100	1500	4,00€



N

KIT DE SÉCURITÉ

REF.						€
54534	330x100x80mm	0.37	-	10	200	24,00€



N



METTEZ VOTRE LOGO



KIT DE SÉCURITÉ

REF.		△					€
52768	■	x2	MK H1	1.81	-	10 200	13,80€
52772	■	x2	MK H1	1.88	-	10 200	13,90€
52776	■	x2	MK H1	1.81	-	10 200	13,80€
52780	■	x2	MK H1	1.94	-	10 200	13,90€
52769	■	x2	MK H4	1.01	-	10 200	14,50€
52773	■	x2	MK H4	1.01	-	10 200	14,60€
52777	■	x2	MK H4	1.07	-	10 200	15,50€
52781	■	x2	MK H4	1.14	-	10 200	14,60€
52770	■	x2	MK H7	2.55	-	10 200	23,00€
52774	■	x2	MK H7	0.99	-	10 200	14,80€
52778	■	x2	MK H7	0.99	-	10 200	14,60€
52782	■	x2	MK H7	1.11	-	10 200	14,80€
52771	■	x2	MK H7+H1	2.75	-	10 200	23,40€
52775	■	x2	MK H7+H1	1.01	-	10 200	15,20€
52779	■	x2	MK H7+H1	1.13	-	10 200	17,10€
52783	■	x2	MK H7+H1	1.01	-	10 200	15,20€



H1 (12V)
H4 (12V)
H7 (12V)

* Double triangle, obligatoire uniquement en Espagne.

KIT DE SÉCURITÉ POCLETTE AVEC LISERÉ

REF.		△				€
53177	■	x1	0.63	-	10 200	11,90€
53178	■	x1	0.64	-	10 200	12,20€
53179	■	x1	0.65	-	10 200	12,20€
53180	■	x1	0.63	-	10 200	12,20€
53181	■	x2	0.98	-	10 200	11,90€
53182	■	x2	0.99	-	10 200	12,20€
53183	■	x2	0.99	-	10 200	12,70€
53184	■	x2	0.98	-	10 200	12,20€



* Double triangle, obligatoire uniquement en Espagne.

KIT DE SÉCURITÉ POCLETTE AVEC RIVET

REF.		△				€
53087	■	x1	0.58	-	10 200	11,20€
53088	■	x1	0.59	-	10 200	11,50€
53089	■	x1	0.61	-	10 200	11,50€
53090	■	x1	0.59	-	10 200	11,50€



KIT DE SÉCURITÉ POCLETTE

REF.		△				€
53091	■	x1	0.52	-	10 200	10,20€
53092	■	x1	0.52	-	10 200	10,20€
53093	■	x1	0.52	-	10 200	10,20€
53094	■	x1	0.52	-	10 200	10,20€



MINI COFFRET AMPOULES

REF.								€
51613	12V	H1	0.90	10	100	1500		2,90€
51615	12V	H9	0.09	10	100	1500		5,95€
51612	12V	H11	0.09	10	100	1500		5,95€
50523	12V	HB3	0.09	10	100	1500		4,70€
50524	12V	HB4	0.09	10	100	1500		4,70€
50915	12V	H7+H1	0.10	10	100	1800		4,20€
51614	12V	H4	0.10	10	100	1800		3,60€
50431	12V	H7	0.08	10	100	1800		3,80€
52047	24V	H4	0.09	10	100	1500		3,30€
52048	24V	H7	0.10	10	100	1500		3,95€



50551

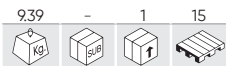

350,00€

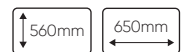

ARMOIRE À AMPOURE POUR VOITURES

STOP À 1 PÔLE
P21W 21 W BA15S UNITÉS 30
P21WA 21 W BA15S ORANGE 10U.
PY21W 21 W BAU15S
AMBO DESC. UNITÉS 10

STOP À 2 PÔLES
R21/5 W 21/5 W BAY15D UNITÉS 40
PLAFONIER
C5W 5 W SV8.5 11X38 UNITÉS 22

LAMPES PILOTES
R5W 5 W BA15S UNITÉS 30
R10W 10 W BA15S UNITÉS 30

LAMPES INDICATRICES
T4W 4 W BA9S UNITÉS 22

LAMPES HALOGÈNES
H1 55 W P14.5S UNITÉS 10
H2 55 W X511 UNITÉS 4
H3 55 W PK22S UNITÉS 4
H4 60/55 W P43T UNITÉS 10
H7 55 W PX26D UNITÉS 10
HB3 65 W P20D UNITÉS 4
HB4 55 W P20D UNITÉS 4
H9 65 W PGJ19-5 UNITÉS 4
H11 65 W PGJ19-2 UNITÉS 4

ACCENT EUROPEEN
T5 1,2 W W2.1X4,6D UNITÉS 20
T10 5 W W2.1X9,6D UNITÉS 12
T10 3 W W2.1X9,6D UNITÉS 12
T13 10 W W2.1X9,6D UNITÉS 10
T15 18 W W2.1X9,6D UNITÉS 10
T20 21 W W5X16D UNITÉS 10
T20A 21 W W5X16D ORANGE 10U.
T20 21/5 W W5X16D 10 UNITÉS



AMPOULES OBN

REF.	DESCRIPTION						€
52365	AMPOULE OBN H7 55W	0.02	10	200	9000		2,46€
52364	AMPOULE OBN H1 55W	0.02	10	200	4400		2,86€
52362	AMPOULE OBN H1 55W	0.01	10	200	14400		1,23€
10766	LAMPE RECHANGE POUR 51960, 51962	0.01	-	200	-		1,59€
52363	AMPOULE OBN H3 12V 55W	0.02	10	200	14400		1,23€
53203	OBN AMBRE LAMPE 12V 21W BA15S	0.01	10	200	-		0,46€
52369	AMPOULE OBN 2POLOS 12V 21/5W S/ T20	0.01	10	1000	18000		1,19€
52368	AMPOULE OBN 12V 21W S/ T20A	0.01	10	1000	18000		1,14€
53007	LAMPE R5W	0.05	10	200	1500		0,42€
52862	LAMPE OBN 21W T20 12V	0.01	10	1000	1500		1,15€
52370	AMPOULE OBN AMBER 12V 21W T20	0.01	10	1000	18000		1,17€
52864	LAMPE OBN 21 / 5W 12V T20	0.01	10	500	1500		1,20€
52865	LAMPE OBN 10W T13 12V	0.01	10	2000	-		0,50€
52866	LAMPE OBN 18W 12V T15	0.01	10	2000	256000		0,25€



54042



TROUSSE DE SECOURS DIN13164:2022

- x1 Sparadrap DIN13019-A 5X2,5
- x4 Sparadraps DIN 13019-E 10X6
- x2 Emplâtres élastiques pour les doigts 4x7 cm
- x2 Emplâtres élastiques pour les doigts 12x2 cm
- x2 Bandes imperméables de sparadrap 1,9x7,2 cm
- x4 Bandes imperméables de sparadrap 2,5x7,2 cm
- x1 Bande stérile DIN 13151-K 6x8 cm
- x2 Bandes stériles DIN 13151-M 8x10 cm
- x1 Bande stérile DIN 13151-G 10x12 cm
- x1 Pansement de premiers secours DIN 13152-BR 60x40 cm
- x1 Pansement de premiers secours DIN 13152-A 60x80 cm
- x2 Bandes stériles DIN 61634FB6 6 cm x 400 cm
- x3 Bandes stériles DIN 61634FB6 8 cm x 400 cm
- x1 Couverture de sauvetage 160x210 cm



13,00€

44 PCS

- x6 Compresses stériles pour plaies 10x10 cm
- x2 Bandes triangulaires DIN 13168-D
- x1 Ciseaux DIN 58279-A145 145 cm
- x4 Gants jetables din en 455-1
- x2 Lingettes humides pour nettoyer le cuir
- x1 Liste des contenus
- x1 Guide de premiers secours

51246

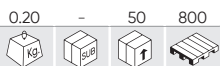

TROUSSE DE SECOURS

- x1 Prospectus premiers secours
- x1 Ciseaux
- x1 Pair de gants
- x2 Lingettes alcoolisées
- x2 Lanières adhésifs
- x1 25g. de coton
- x1 Sac avec 5 bandages
- x1 Voie
- x1 Rol de sparadrap



6,40€

11 PCS

54072

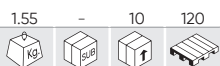

TROUSSE DE SECOURS DIN13157

- x1 Sparadrap 5 x 25 - DIN13019-A
- x1 Jeu de bandes adhésives 10 x 6 cm (8 pièces) - DIN13019-E
- x6 Emplâtres pour les doigts 4 x 6,5 cm
- x6 Emplâtres pour les doigts 120 x 20 mm
- x6 Emplâtres pour les doigts 7,2 x 1,9 cm
- x12 Emplâtres pour les doigts 25 x 72 mm
- x1 Jeu de bandes de premiers secours, compresse stérile 6 x 8 cm - DIN13151-K
- x3 Jeux de bandes de premiers secours, compresse stérile 8 x 10 cm - DIN13151-M
- x1 Jeu de bandes de premiers secours, compresse stérile 10 x 12 cm - DIN13151-G
- x1 Compresse stérile (pansement pour brûlures) 60 x 80 cm - DIN13152-A
- x3 Bandes stériles pour les plaies 100 x 100 mm, 2 pcs/sachet - DIN58953-2
- x2 Cache-œil - 55mm x 75mm 1,5 g
- x1 Compresse froide pour traitement d'urgence, min. 200 Cm2
- x1 Couverture de premiers secours, 160 x 210 cm, 12 microns
- x2 Bandes élastiques, 6 cm par 400 cm - DIN61634 FB6
- x2 Bandes élastiques, 8 cm par 400 cm - DIN61634 FB8
- x2 Bandes triangulaires 96x96x136 cm - DIN13168-D
- x1 Ciseaux métal 190 mm - DIN58279-B190
- x2 Sacs poubelle en plastique, 300 x 400 mm, 45 microns
- x5 Non-tissés 20 x 30 cm, min. 15 G/m2
- x1 Gants jetables en pvc l-aq1,5 (jeu de 4 pièces) - DIN EN 455-1



38,50€

67 PCS

- x1 Brochure d'information
- x2 Masques chirurgicaux DIN EN 14683
- x4 Lingettes nettoyantes pour une peau saine

50644 11,60€

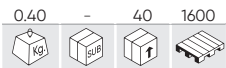

CEINTURE DE SÉCURITÉ DE 2 POINTS POUR AUTOCARS

1250mm



RENCONTRE AVEC: E4-16R-0436213

50717 21,90€

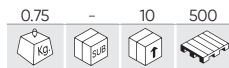

CEINTURE DE SÉCURITÉ DE 2 POINTS ENROULABLE POUR AUTOCARS

1330mm



RENCONTRE AVEC: E4-16R-0436232

51266 28,00€

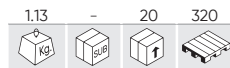

CEINTURES DE SÉCURITÉ AVEC 3 POINTS ENROULABLE POUR AUTOCARS

2900mm



RENCONTRE AVEC: E4-16R-0436232

52259 3,75€

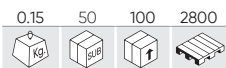

MARTEAU BRISE GLACE ET COUPE CINTURES

135mm
20mm
75mm
Ø 160mm



51861 199,00€

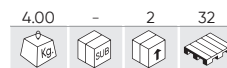

EXPANDEUR SOUFFLETS DE CARDANS PNEUMATIQUE

125 PSI
9 BAR



- Matière: Aluminium.
- Ouverture de 20 à 100mm.

COLLIERS DE CARDANS

REF.	DESCRIPTION					€
11890	ARBRE COLLIER 50-125MM	0.01	100	1000	18000	0,55€
11891	ARBRE COLLIER 15-45MM	0.01	100	5000	90000	0,50€
52633	JEU DE 2 ARBRES COLLIER	0.02	100	800	14400	1,00€



SOUFFLET DE CARDANS UNIVERSEL EN NEOPRENE

REF.	DESCRIPTION				€
51703	SOUFFLETS DE CARDANS UNIV. NEOPRENO - P/CAMIONETTE	0.28	20	320	10,50€
51705	SOUFFLETS DE CARDANS UNIV. NEOPRENO POUR TOURISME	0.23	20	400	8,45€



52644



KIT DE SOUFFLET POUR DIRECTION UNIVERSELLE



8,80€

53693

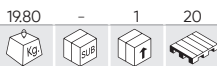

BOÎTE DE 100 SOUFFLETS DE CARDANS

521,00€



x100 52633

x100 13738

x100 13879

53698



BOÎTE DE 100 SOUFFLETS DE CARDANS POUR VAN

717,00€



x100 52633

x100 13739

x100 13880

53695

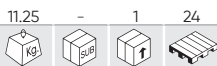

BOÎTE DE 80 SOUFFLET POUR DIRECTION UNIVERSELLE

504,00€



x80 52633

x80 13740

x80 13880

SERIE124



ENSEMBLE SPÉCIAL INTERCHANGEABLE POUR LES JOINTS HOMOCINÉTIQUES

710,00€



x1 51861

x100 52633

x100 13738

x100 13879

PIÈCES DE RECHANGE

REF.	DESCRIPTION	Kg	L	Q	Q	€
13738	RECHANGE POURREF. 51705	0.08	-	150	1800	3,50€
13739	RECHANGE POURREF. 51703	0.15	-	100	1600	5,50€
13740	RECHANGE POURREF. 52644	0.10	-	72	-	5,50€
13879	SAC DE GRAISSE	0.09	-	150	5250	1,38€
13880	SOUFFLET POUR GRAISSAGE DU SYSTÈME DE DIRECTION	0.01	-	600	21000	1,50€

50585

14,70€



JEU DE 4 TAPIS EN CAOUCHEUC - REVERSIBLE

- Caoutchouc de haute qualité.
- Très résistant.
- Adaptable à la plus part des véhicules.

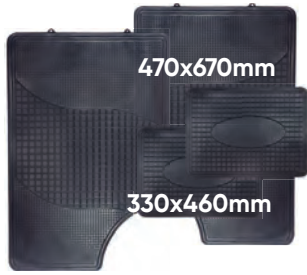

REVERSIBLE!



53241

9,00€

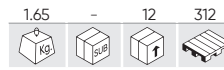

JEU DE 4 TAPIS EN CAOUTCHOUC UNIVERSELLE

- Caoutchouc de haute qualité.
- Très résistant.
- Adaptable à la plus part des véhicules.



52534

15,00€



JEU DE 4 TAPIS EN MOQUETE + TALONETE PLASTIQUE

- 2 Avant (425x660mm).
- 2 Arrière (295x425mm).
- Léger, confortable, avec talonnet plastique.
- Revers anti derrapant.



52535

16,50€



JEU DE 4 TAPIS EN MOQUETE + TALONNETTE MOQUETE

- 2 Avant (425x660mm).
- 2 Arrière (295x425mm).
- Léger, confortable, avec talonnet plastique.
- Revers anti derrapant.



52530

14,00€

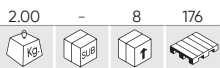

JEU DE 4 TAPIS EN MOQUETE + TALONETE

- 2 Avant (390mm).
- 2 Arrière (365x480mm).
- Léger, confortable, avec talonnet plastique.
- Revers anti derrapant.



METEXP

62,00€



PRESENTOIR POUR TAPIS



BALAI D'ÉSSUIE-GLACE UNIVERSEL



99%

Installation facile de l'adaptateur dans plus de 99% des véhicules.

38dB

L'ergonomie et l'élimination des pièces de poids réduisent le bruit de 38 dB.

30%

Pression de longueur de brosse uniforme grâce au ressort en acier pour une meilleure visibilité que les brosses d'origine et une performance supérieure de 30%.

100%

100% caoutchouc naturel résistant à toutes les conditions météorologiques extrêmes.

160km/h

Conception aérodynamique qui permet une utilisation jusqu'à 160 km/h.

45°

Angle de coupe à 45° et précision du nettoyage transversal qui élimine les plus petites gouttes.

REF.	"	mm					€
53745	11"	280mm	0.20	10	50	800	6,40€
53746	12"	310mm	0.20	10	50	800	6,40€
53747	13"	330mm	0.20	10	50	900	6,40€
53748	14"	350mm	0.20	10	50	800	6,60€
53749	15"	380mm	0.20	10	50	900	6,70€
53750	16"	410mm	0.20	10	50	900	6,70€
53751	17"	430mm	0.20	10	50	900	6,80€
53752	18"	460mm	0.25	10	50	800	6,95€
53753	19"	480mm	0.25	10	50	700	7,10€
53754	20"	510mm	0.25	10	50	900	7,40€
53755	21"	530mm	0.25	10	50	600	7,50€
53756	22"	560mm	0.25	10	50	600	7,90€
53757	24"	610mm	0.25	10	50	600	7,90€
53758	26"	650mm	0.30	10	50	600	8,20€
53759	28"	700mm	0.30	10	50	550	8,50€
53760	30"	750mm	0.30	10	50	500	9,60€

11 ADAPTATEURS DIFFÉRENTS: POUR DES APPLICATIONS MULTIPLES



JBMWBEXP

24,50€

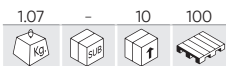

BALAI ESSUIE-GLACES PLATS



53919

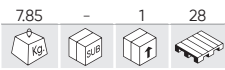

81,00€



SUPPORT DE RÉPARATION DE VÉLO

- Matériau: acier Q195, ABS, nylon
- Dimensions en état assemblé: 198x104 cm
- Hauteur réglable: 107 à 188 cm
- Longueur du tube transversal pivotant: 37 cm
- Longueur du support: 69 cm
- Diamètre du tube transversal pivotant: 35 mm
- Diamètre du tube télescopique: 35 mm
- Diamètre du tube principal: 38 mm
- Diamètre du tube de support: 25 mm
- Capacité maximale: 30 kg

EN ABS RENFORCÉ ET NYLON POUR FAIRE TOURNER LE VÉLO À N'IMPORTE QUEL ANGLE ET SANS ENDOMMAGER LA PEINTURE.

DIMENSIONS DU PLATEAU À OUTILS MULTIFONCTIONNEL 25X13CM

CONCEPTION ANTIDÉRAPANTE 4 PIEDS



POUR TOUS LES TYPES DE VÉLOS
Vélo de ville / route / VTT



Tige réglable de fixation: 50 à 90cm

54166

32,40€

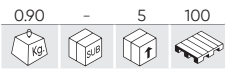

POMPE À PLANCHER POUR BICYCLETTE



54170

16,50€

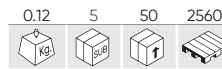

POMPE À MAIN PORTABLE POUR VÉLO



54073

70,00€

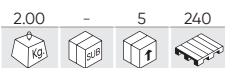

KIT D'OUTILS POUR VÉLO - 20 PCS



54074

18,50€



OUTIL DE RÉPARATION DE VÉLO MULTIFONCTIONNEL



54169

13,80€



ANTIVOL VÉLO À COMBINAISON



ACCESSOIRES POUR VÉHICULES

51858 15,00€

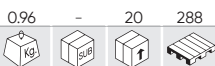

PELE PLIABLE

- Fabriqué en métal résistant.
- Plié: 240mm.
- Déplié: 580mm.



53033 21,50€

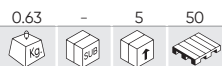

PELLE EXTENSIBLE ALUMINIUM

- Fabriqué en plastique et en aluminium.
- Plié: 85mm.
- Déplié: 119mm.



52187 21,80€

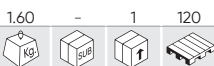

PELLE MÉTALLIQUE DE 215MM



52251 21,80€

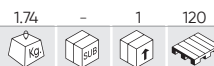

PELLE MÉTALLIQUE DE 215MM



53964 9,65€

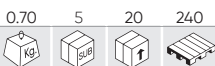

CORDE MULTIUSAGE 30M 1/4"

ø 1/4"
550Kg



53965 25,80€

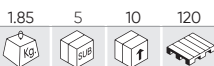

CORDE MULTIUSAGE 30M 1/2"

ø 1/2"
1200Kg



51412 2,10€



PORTE PLAQUE INMATRICULATION

- Dimensions : 53,20 cm x 13,70 cm.
- Zone de marquage : 52 cm x 1,60 cm.

TYPON ET SÉRIGRAPHIE NON INCLUS



51697 0,80€



RACLETTE GIVRE



50526 4,80€

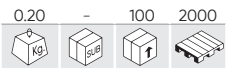

PARAPLUI PLIANT



50525 1,00€



IMPERMÉABLE DE SECOURS



51925 1,00€

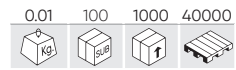

CISEAUX MINI DE 9CM



52618 29,00€

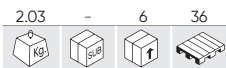

KIT DE RANGEMENT MULTIFONCTION

- Set de 4 pieces:
 - Cofre flexible 37 l avec couvercle (300mm x 490mm).
 - Bidon circulaire avec couvercle de 180mm Ø. (230mm hauteur).
 - Crochet porte objets sans couvercle (90mm hauteur x 260mm longue).
 - Plateau (175mm hauteur x 300mm longue).



53221 4,75€

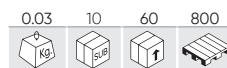

SET DE 3 LAVETTES MICROFIBRE

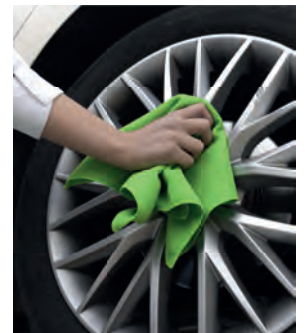

53561 28,00€



ARRÊT ANTI-RETOUR

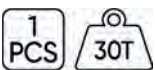

53508 14,00€



JEU DE 2 CALES POUR VEHICULE



REF.	DESCRIPTION	Kg	Unité	Palettes	€
14118	SUPPORT DE L'ARRÊT ANTI-RETOUR	1.25	4	80	26,00€

51863

54,00€

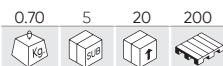

RADAR DE RECUL AVEC TEMOIN VISUEL

- Tension nominale: dc 12 v.
- Puissance: 3,6 w.
- Température de travail: -20° à 70°.
- 4 Capteurs de rapprochement.
- Distance de détection: 0,3-2,0 m.
- Angle de détection: h>60°, v>60°.
- Radiofréquence: 315 mhz / 433 mhz.
- Angle de la chambre: 92 ou 120°.
- Inclut un indicateur de 2 couleurs de marquage de rapprochement.
- Capteurs couleur noir pas peindre.



51973

45,00€

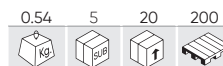

RADAR DE RECUL AVEC TEMOIN ACOUSTIQUE

- Tension nominale: dc 12 v.
- Puissance: 3,6w.
- Température de travail: -20° à 70°.
- 4 Capteurs de rapprochement.
- Distance de détection: 0,3-2,0 m.
- Angle de détection: h>60°, v>60°.
- Radiofréquence: 315 mhz / 433 mhz.
- Angle de la chambre: 92 ou 120°.
- Sans indicateur visuel.
- Inclut une sonnerie de 4cm de diamètre.



TUBES FLEXIBLES INNERBRAID

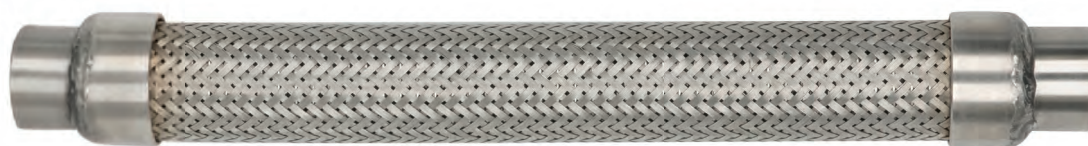

REF.	DESCRIPTION					€
51706	Ø 25mmL x 300mmL	0.35	-	25	1500	22,80€
51707	Ø 45mmL x 100mmL	0.27	-	25	1200	9,05€
51708	Ø 45mmL x 150mmL	0.38	-	25	-	14,20€
51709	Ø 45mmL x 200mmL	0.50	-	25	-	14,70€
51710	Ø 45mmL x 250mmL	0.65	-	25	600	17,80€
51711	Ø 45mmL x 300mmL	0.71	-	25	-	21,20€
51712	Ø 50mmL x 100mmL	0.30	-	25	-	8,65€
51713	Ø 50mmL x 150mmL	0.45	-	25	-	13,10€
51714	Ø 50mmL x 200mmL	0.56	-	25	-	15,80€
51715	Ø 50mmL x 250mmL	0.70	-	25	-	20,30€
51716	Ø 50mmL x 300mmL	0.83	-	25	450	23,60€

REF.	DESCRIPTION					€
51717	Ø 55mmL x 100mmL	0.35	-	25	-	11,20€
51718	Ø 55mmL x 150mmL	0.50	-	25	-	14,80€
51719	Ø 55mmL x 200mmL	0.65	-	25	-	22,00€
51720	Ø 55mmL x 250mmL	0.85	-	25	350	23,50€
51721	Ø 55mmL x 300mmL	1.00	-	25	375	25,00€
51722	Ø 60mmL x 100mmL	0.36	-	25	750	13,10€
51723	Ø 60mmL x 150mmL	0.50	-	25	450	18,70€
51724	Ø 60mmL x 200mmL	0.66	-	25	400	24,40€
51725	Ø 60mmL x 250mmL	0.83	-	25	-	28,30€
51726	Ø 60mmL x 300mmL	0.96	-	25	250	31,40€
51727	Ø 60mmL x 400mmL	1.62	-	25	200	49,00€

DISPONIBLE DANS DES BOXES INDIVIDUELS

ACCESSOIRES POUR PNEUS

368 POIDS DE ROUE

369 RÉPARATION DE CREVAISONS

370 VALVES PNEUMATIQUES

371 DÉMONTAGE ET INSTALLATION

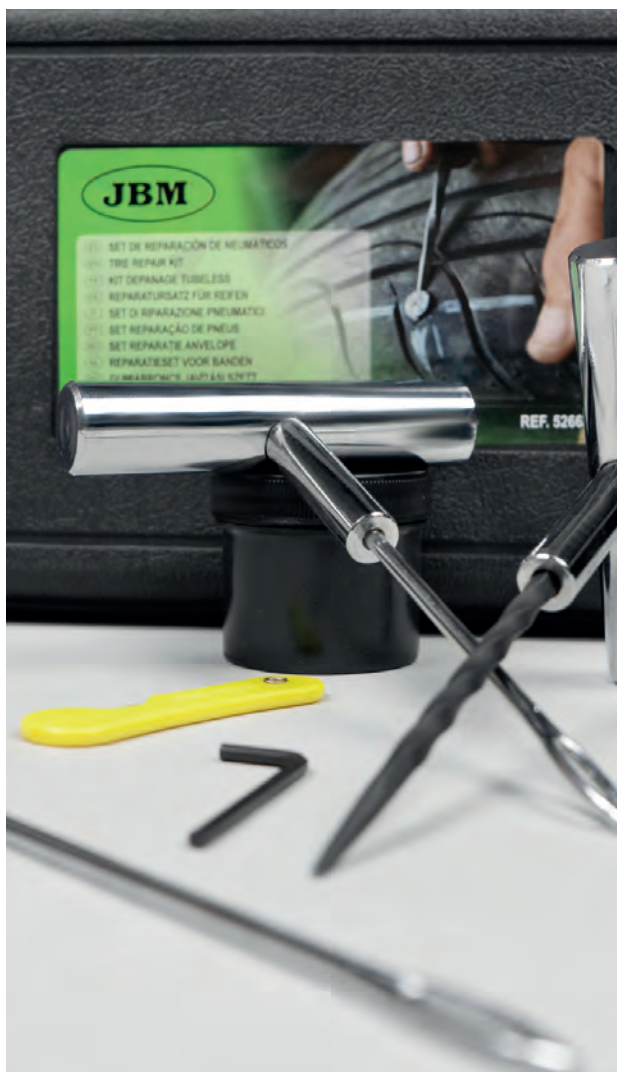

ACCESSOIRES POUR PNEUS

51908

44,00€



ROULEAU DE MASSES AVEC DÉVIDOIRE EN FER 5GRX1.000

- 1.000 pastilles de 5g.
- Autocollantes avec 4 mm d'épaisseur.
- Dimensions du devidoire: 29,5 cm x 29,5cm.



Avec aimant de retenue de reste.

53256

34,00€



ROULEAU DE MASSES AVEC DEVIDOIRE EN FER 5G X 1.000

- 1.000 pastilles de 5g.
- Autocollantes avec 4 mm d'épaisseur.
- Dimensions du devidoire: 29,5 cm x 29,5cm.



MASSE EQUILIBRAGE AUTOCOLLANTE

REF.	g					€
50600	45g: 3x5g/3x10g	0.05	100	400	36000	0,60€
50601	45g: 3x5g/3x10g	0.05	100	400	48000	0,29€



50600
ZINC



50601
FER

MASSE D'EQUILIBRAGE AUTOCOLLANTE

REF.	g					€
52665	60g: 12x5g	0.06	100	400	20000	0,37€
52666	60g: 4x10g/4x5g	0.06	100	400	20000	0,36€



52665



52666

MASSES D'ÉQUILIBRAGE EN ZINC

SPÉCIAL JANTE UNIVERSELLE

REF.	g					€
50760	5g	0.01	100	1600	80000	0,10€
50761	10g	0.01	100	1600	102400	0,19€
50762	15g	0.02	100	800	76800	0,29€
50763	20g	0.02	100	800	64000	0,38€
50764	25g	0.03	100	800	48000	0,49€
50765	30g	0.03	100	600	50400	0,58€
50766	35g	0.04	100	400	32000	0,68€
50767	40g	0.04	100	400	25600	0,78€
50768	45g	0.05	100	400	32000	0,88€
51055	50g	0.05	100	400	2000	0,98€



SPÉCIAL JANTE ALLIAGE

REF.	g					€
50778	5g	0.01	100	1600	80000	0,10€
50779	10g	0.01	100	800	76800	0,19€
50780	15g	0.02	100	1200	60000	0,29€
50781	20g	0.02	100	800	80000	0,38€
50782	25g	0.03	100	600	48000	0,49€
50783	30g	0.03	100	600	30000	0,58€
50784	35g	0.04	100	400	32000	0,68€
50785	40g	0.04	100	400	32000	0,78€
50786	45g	0.05	100	400	32000	0,88€
51604	50g	0.05	100	400	25600	0,98€



MASSES ÉQUILIBRAGE PL

REF.	DESCRIPTION					€
52667	50g	0.05	50	400	25600	0,76€
52668	100g	0.10	25	200	12800	1,49€
52669	150g	0.15	20	160	10240	2,22€
52670	200g	0.20	10	80	5120	2,95€
52671	250g	0.25	10	80	5120	3,70€
52672	300g	0.30	10	80	5120	4,45€



52667



52668



52669



52670



52671



52672

53864

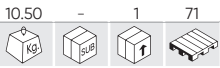

138,00€



COFFRET DE MASSES UNIVERSELLE AUTOCOLLANTES

MASSES ÉQUILIBRAGE EN ZINC AVEC AGRAFE

MASSE D'ÉQUILIBRAGE AUTOCOLLANTES

SPÉCIAL JANTE UNIVERSELLE

SPÉCIAL JANTE ALLIAGE

60gr: 4x10gr 4x5gr - 70u. (ref. 52666)

- 5g - 20 uds (ref. 50760)
- 10g - 20 uds (ref. 50761)
- 15g - 20 uds (ref. 50762)
- 20g - 20 uds (ref. 50763)
- 25g - 20 uds (ref. 50764)
- 30g - 10 uds (ref. 50765)
- 35g - 10 uds (ref. 50766)
- 40g - 10 uds (ref. 50767)

- 5g - 20 uds (ref. 50778)
- 10g - 20 uds (ref. 50779)
- 15g - 20 uds (ref. 50780)
- 20g - 20 uds (ref. 50781)
- 25g - 20 uds (ref. 50782)
- 30g - 10 uds (ref. 50783)
- 35g - 10 uds (ref. 50784)
- 40g - 10 uds (ref. 50785)



51355

19,00€



PINCE SPÉCIALE MASSE D'ÉQUILIBRAGE



- Extrait facilement et remplace le contrepois.
- Coupe et plie facilement.
- Fait en acier renforcé à la chaleur.
- Inclut manche ergonomique.
- Avec ressort automatique en ouvert dans la poignée pour faciliter son opération.



53150

24,00€

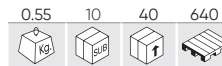

COMPRESSEUR D'AIR



54013

35,00€

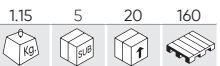

KIT DE RÉPARATION DE CREVAISONS - COMPRESSEUR DE LIQUIDE ET D'AIR

REF.	DESCRIPTION	Kg	SUB	Uds	€
A 15317	SAC POUR KIT 54013 (53150)	0.10	-	220	4,50€
B 15300	LIQUIDE SCELLANT PERFORANT - 500ML	0.50	-	12	5,00€
C 11960	OUTIL POUR VALVES	0.01	10	500	1,50€
D 53150	COMPRESSEUR D'AIR	0.55	10	40	24,00€

- Scelle les crevaisons jusqu'à 6 mm de diamètre.
- Le matériau ne corrode pas le métal et le caoutchouc.
- Liquide non inflammable et résistant au gel avec une longue durée de vie.



51814

8,00€

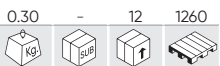

AÉROSOL ANTI-CREVAISONS 300ML

300ml



52653

3,00€

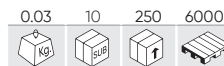

OUTIL POUR VALVES

- Pour monter et démonter les valves.



52652

2,80€

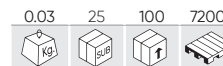

CLÉE MULTIFONCTIONNELLE DE VALVES



ACCESSOIRES POUR PNEUS

52662

36,50€



KIT DEPANAGE TUBELESS



- A 1 x fraise
- B 1 x outil d'insertion
- C 1 x outil de gonflage
- D 4 x compressed air bottles
- E 1 x cutter
- F 10 x meches
- G 1 x outil demonte obus

52663

30,00€



KIT DEPANAGE TUBELESS



- A 1 x outil d'insertion
- B 1 x fraise
- C 1 x recharge outil insertion
- D 1 x cutter
- E 20 x meches
- F 1 x lubrifiant

REF.	DESCRIPTION						€
12973	MÈCHE DE RECHANGE POUR 52662/52663	0.01	10	500	13500		1,00€
13805	OUTIL POUR INSERTION DE MECHES (REF. 52663)	0.50	10	50	-		10,50€
13806	OUTIL DE PERFORATION (REF. 52663)	0.35	5	50	-		10,50€

52673

18,00€

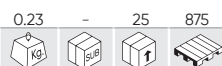

SET DE BOUCHONS ET VALVES POUR PNEUMATIQUES



PIÈCES DE RECHANGE DISPONIBLES

REF.	DESCRIPTION					€
11903	POCHETTE 16U. BOUCHON ALU	0.01	1	100		5,00€
11904	POCHETTE 50U. BOUCHON PLASTIQUE VERD	0.10	10	500		2,00€
11905	POCHETTE 50U. BOUCHON PLASTIQUE NOIR	0.01	-	10		1,50€
11906	POCHETTE 50U. OBUS STANDAR	0.04	-	100		8,50€
11907	POCHETTE 50U. OBUS HAUTE PRESION	0.05	-	100		11,00€
11960	OUTIL POUR VALVES	0.01	10	500		1,50€

EST ÉGALEMENT DISPONIBLE

REF.	DESCRIPTION					€
11900	JEU DE 4 BOUCHONS EN ALUMINIUM POUR VALVES	0.01	4	25	250	3,50€
11901	BOUCHON DE PLASTIQUE VERT POUR VALVES	0.01	4	25	500	2,50€
11902	SET DE 4 BOUCHONS DE PLASTIQUE NOIR P/VALVES	0.01	4	25	300	3,50€

VALVES EN POCLETTE

REF.	DESCRIPTION						€
51741	TR413 45mm	0.01	100	1000	48000		0,50€
51742	TR414 51mm	0.01	100	1000	48000		0,50€
51743	TR418 64mm	0.02	100	1000	48000		0,55€



TIRE VALVES

REF.	DESCRIPTION					€
52649	METAL	0.32	10	50	2250	5,00€
52650	PLASTIQUE	0.15	10	100	2400	5,00€



52657 37,50€

0.18 5 20 800

ONGLE EN PLASTIQUE RECHANGE POUR DÉMONTEUSE DE PNEUMATIQUES



52658 39,70€

0.17 - 20 800

TETE COMPOSITE UNIVERSELLE



52659 39,70€

0.26 - 20 1920

TETE COMPOSITE UNIVERSELLE



54329 37,50€

0.20 10 100 -

TETE COMPOSITE UNIVERSELLE

EUR - MADE IN SPAIN



52655 39,70€

0.39 - 25 1500

PINCE REPOUSE TALON



52656 39,50€

0.40 5 20 1920

PINCE MANUEL REPOUSE TALON



LEVIER DEMONTE PNEUS

REF.	"					€
51362	12" (30,48cm)	0.15	5	60	500	3,00€
51358	16" (40,64cm)	0.47	6	24	1008	7,50€
51359	24" (60,96cm)	0.90	6	30	1440	9,00€



BAGUES DE CENTRAGE POUR JANTES

REF.	mm					€
52645	25x22x2,5mm	0.01	50	1000	38000	0,55€
52646	25x12x2,0mm	0.00	50	1000	80000	0,50€
53037	23x12x2,5mm	0.01	50	1000	35000	0,50€
53038	21x12x2,5mm	0.01	50	1000	35000	0,50€
53039	25x19x2,5mm	0.02	50	1000	35000	0,50€
53040	25x9x2,5mm	0.01	50	1000	35000	0,50€



52664

168,00€

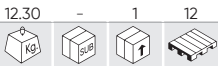

LEVIER DEMONTE PNEUS SPECIALE PL



53605

141,00€

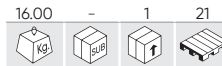

950mm

MACHINE DE MONTAGE MANUELLE DE PNEUS

- Applicabilité: Tous les pneus de 8 pouces jusqu'aux pneus de camion léger (7-1/2 pouces x 16 pouces).
 - Perméabilité: Jusqu'à 12,5 l 16.
 - Complétude: 1 Poignée pour enlever les pneus de 37 pouces de long.
- Outil de montage / démontage.



52660

126,00€

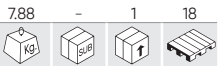

CHARIOT PORTE ROUE, CAP. 200KG



52552

128,00€

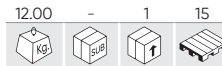

CANON À AIR

- 87-116 PSI
6-8 BAR
- MAX
10 BAR
145 PSI
- 18L
- 20°C
40°C



REF. DESCRIPTION

REF.	DESCRIPTION	Kg	SUB	↑	↓	€
13741	BUSE DE RECHANGE POUR REF. 52552	0.35	-	32	-	21,00€

53542

980,00€



DÉCOLLEUR DE PNEU



54198

59,00€

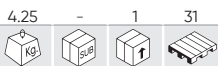

CHARIOT À PNEUS AVEC ROULETTES



54136

107,00€

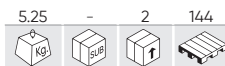

MACHINE DE MONTAGE MANUELLE DE PNEUS



52842

11,00€

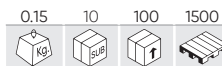

PNEU ROULEAU RÉPARATION



53419

9,70€

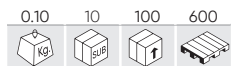

SET DE 3 PROTECTEURS DE JANTES



SÉCURITÉ ET EPI

374 GANTS/EPI

377 MASQUES / DISPENSEURS

379 DELIMITATION

380 MESUREUR D'OZONE

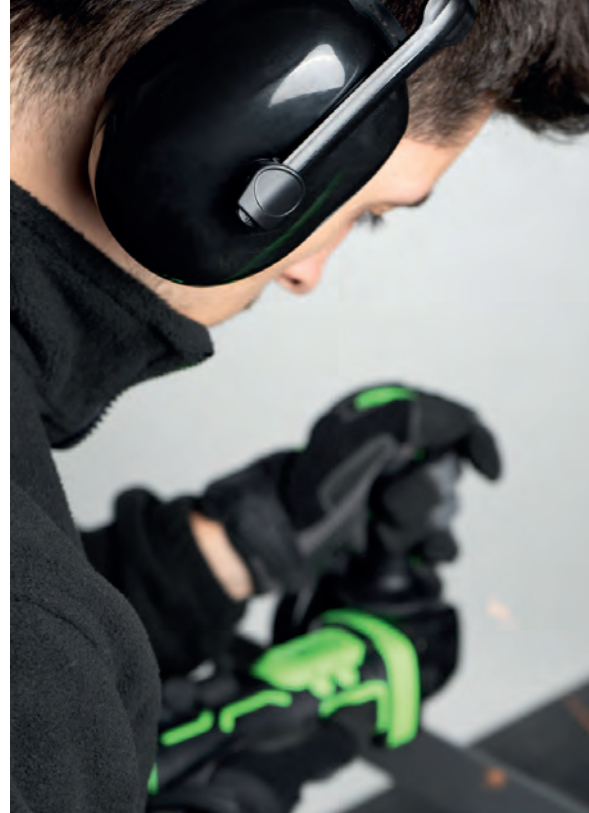



BÔITE DE GANTS 100% NITRILE

BÔITE DE GANTS NITRILE

3.5MIL
4.2g

REF.	UDS.				€	
54294	S	100	0.40	10	500	8,00€
53984	M	100	0.45	10	500	8,00€
53985	L	100	0.50	10	500	8,00€
53986	XL	100	0.55	10	500	8,00€



3.5MIL
4.2g

REF.	UDS.				€	
54155	M	100	0.46	10	570	8,00€
54156	L	100	0.50	10	570	8,00€
54157	XL	100	0.55	10	570	8,00€

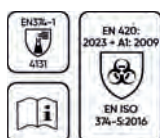

5MIL
5.5g

REF.	UDS.				€	
54151	M	100	0.60	10	500	9,00€
54152	L	100	0.60	10	500	9,00€
54153	XL	100	0.60	10	500	9,00€



BÔITE DE GANTS NITRILE - TEXTURE DIAMANT

7MIL
8.4g

REF.	UDS.				€	
53551	M	100	0.90	10	300	16,00€
53552	L	100	1.00	10	300	16,00€
53553	XL	90	1.00	10	300	16,00€



7MIL
8.4g

REF.	UDS.				€	
54177	M	100	0.92	10	300	16,00€
54178	L	100	0.96	10	300	16,00€
54179	XL	90	0.97	10	300	16,00€

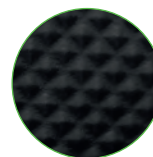

7MIL
8.4g

REF.	UDS.				€	
54369	M	100	0.90	10	300	16,00€
54370	L	100	0.88	10	300	16,00€
54371	XL	100	1.05	10	300	16,00€

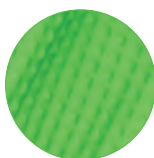

GANTS DE TRAVAIL RENFORCÉS POLYURETHANE

REF.						€	
51640N	T.8		0.05	12	144	3456	1,54€
51642N	T.9		0.01	12	144	3456	1,54€
51636N	T.10		0.05	12	144	3456	1,54€
51638N	T.11		0.05	12	144	3456	1,54€



GANTS DE TRAVAIL RENFORCÉS EN NITRILE

REF.						€	
51633	T.8		0.04	12	144	3456	1,54€
51634	T.9		0.05	12	144	2592	1,54€
51632N	T.10		0.05	12	144	3456	1,54€
51398N	T.11		0.05	12	144	2592	1,54€



GANTS DE TRAVAIL THERMIQUES

REF.						€	
54192	T.8		0.15	12	144	3456	8,90€
54193	T.9		0.10	12	144	3456	8,90€
54194	T.10		0.15	12	144	3456	8,90€
54195	T.11		0.10	12	144	3456	8,90€



GANTS DE TRAVAIL SPÉCIAL ÉCRAN TACTILE

REF.						€	
52570	T.8		0.03	12	144	3456	2,60€
52571	T.9		0.03	12	144	2592	2,60€
52572	T.10		0.03	12	144	2592	2,60€
52573	T.11		0.04	12	144	2592	2,60€



GANTS EN PEAU

REF.						€	
52738	T.9		0.10	12	144	2304	5,00€
52739	T.10		0.12	12	144	2304	5,00€



GANTS EN CUIR ET TOILE

REF.						€
52310	0.20	12	120	1920		3,65€



SÉCURITÉ ET EPI

GANTS TRICOTÉS

REF.						€	
51745	0.05	12	144	4320		0,70€	



GANTS TRICOTÉS ANTIDERAPANT

REF.						€	
51785	0.04	12	300	3600		1,00€	



GANTS DE TRAVAIL

REF.						€
54188	T.8	0.15	12	60	2040	19,00€
54189	T.9	0.15	12	60	720	19,00€
54190	T.10	0.15	12	60	720	19,00€
54191	T.11	0.15	12	60	720	19,00€



POUR ÉCRAN TACTILE



52430 10,90€

0.34	6	24	288

CASQUE ANTI-BRUIT



RENCONTRE AVEC: EN352 - 1:2003

53785 4,80€

0.05	14	112	896

LUNETTES DE PROTECTION AVEC PROTECTION ANTIBUÉE



RENCONTRE AVEC: EN166:2002-04

LUNETTES DE PROTECTION SPORTIVES, AVEC PROTECTION ANTI-BUÉE

REF.					€
53596	0.01	12	144	2016	3,65€
53597	0.01	12	144	2016	3,70€
53598	0.01	12	144	2016	3,95€

RENCONTRE AVEC: EN166:2002-04 / EN166:2003-01



PRÉSENTOIR DE 12 UNITÉS



53596



53597



53598

53794 28,00€

0.15	80	1280	

THERMOMÈTRE INFRAROUGE PROFESSIONNEL

- Mesure la température corporelle en 1 seconde et sans contact physique.
- Arrêt automatique après 1 minute.

TEMPÉRATURE CORPORELLE	32.0°C - 42.2°C (89.6°F - 108°F)
PRÉCISION	±0.2°C (35°C - 42°C)



0123
2 PILES A

53862

6,00€

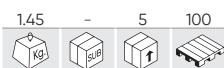

TAPIS AVEC RÉSERVOIR POUR LE LIQUIDE DÉSINFECTANT

- Mesures: 85x55x10cm
- Matériel: TPE
- Capacité maximale recommandée: 3L
- Capacité maximale: 8L

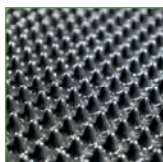

53863

3,00€



TAPIS DE SÉCHAGE

- Mesures: 76x48cm
- Matériel: polyester

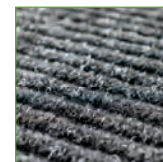

53781

18,00€



DISTRIBUTEUR AUTOMATIQUE DE COUVRE-CHAUSSURES



REF.	DESCRIPTION	kg	Unité	Palettes	€
14781	COUVRE-CHAUSSURES 100PCS	0.25	84	336	990€

53797

0,10€

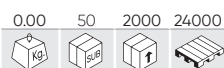

MASQUE DE PROTECTION HYGIÉNIQUE (USAGE UNIQUE)



Présentation en boîte de 5 sacs de 10 unités chacun.

USAGE NON MÉDICAL

EFB EFFICACITÉ À LA FILTRATION BACTÉRIENNE	>98%
RÉSISTANCE À LA RESPIRATION	35-50 Pa

Cet appareil n'est pas un dispositif médical au sens de la directive 93/42 ou du règlement EU / 2017/745, ni un équipement de protection individuelle au sens du règlement EU / 2016/425. POUR UN USAGE PERSONNEL, NON RÉUTILISABLE

53957

0,26€

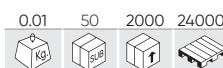

MASQUE NOIR DE PROTECTION HYGIÉNIQUE (USAGE UNIQUE)



Présentation en boîte de 5 sacs de 10 unités chacun.

USAGE NON MÉDICAL

EFB EFFICACITÉ À LA FILTRATION BACTÉRIENNE	>90%
RÉSISTANCE À LA RESPIRATION	63-69 Pa

53946

0,83€

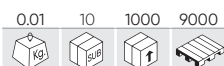

MASQUE DE PROTECTION AUTO-FILTRANT FFP2 - NOIRE



Conforme à la norme EN149:2001+A1:2009
Approuvé selon le règlement UE 2016/425

TVA non comprise

www.jbmfrance.fr

377

53826

16,00€

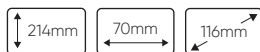
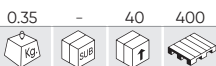

DISTRIBUTEUR AUTOMATIQUE DE GEL - 400 ML

- Compatible avec du savon liquide, de l'alcool, du gel et du désinfectant pour les mains.
- Technologie de capteur infrarouge avec LED.
- Dosage: 1ml.
- Tension: 6 V (4 piles de 1,5 V).
- Piles non incluses.



14793

12,00€



POMPE DOSEUSE POUR BOUTEILLE DE 5L



53902

25,00€

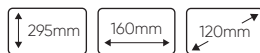
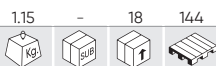

DISTRIBUTEUR AUTOMATIQUE - 1200 ML

- Dosage: 0,7 ml/1,4 ml
- Distance d'activation du capteur: 80 à 120 mm
- Tension: 6 V, 1,5 A (4 piles de taille C de 1,5 V, - incluses)
- Dimensions d'encombrement: 160 x 120 x 295 mm
- Matériau: ABS



53827

32,00€



SUPPORT POUR DISTRIBUTEUR AUTOMATIQUE DE GEL

- Poids: 4,3 kg
- Matériau: acier
- Couleur: noire
- Mesures du plateau: 417x67 mm
- Dimensions du support du distributeur: 480x133 mm
- Diamètre de la base: 395 mm



REF. DESCRIPTION

REF.	DESCRIPTION	Kg	Unités	€
15059	ADAPTATEUR AC/DC 6V 1.5A	0.10	200	10,00€
15062	BATTERIE R14 C1.5V	0.05	24	1,00€

EXTENSIBLE
1.25m - 1.58m

53832

1,81€



GEL HYGIÉNISANT POUR MAINS 60ML



PRÉSENTOIR DE 24 UNITÉS

53791

4,80€



GEL HYDRO-ALCOOLIQUE POUR MAINS 500ML



52493

4,50€

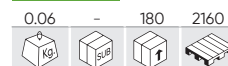

PISTOLET ADAPTABLE POUR AEROSOL



53940

13,20€

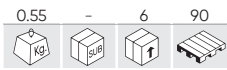

850mm

POTEAU DE PLASTIQUE POUR CHAINES - JAUNE / NOIR

- Matériau: PVC.
- Base gonflable.

CHAÎNE NON INCLUS.



**SIGNALISATION SPÉCIALE
HAUTE TENSION**



54322

19,00€

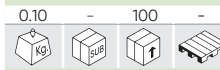

N

JEU DE 2 PANNEAUX D'AVERTISSEMENT HAUTE TENSION

165mm 500mm



53987

9,50€

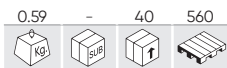

RUBAN DE SIGNALISATION JAUNE / NOIR - 200M

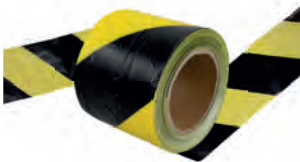

53942

0,50€

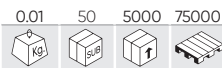

MAILLE DE CHAÎNE EN PLASTIQUE NOIR



54326

7,30€

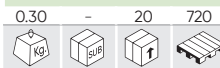

N

CHAÎNE PVC - 7M - JAUNE/NOIR

7m



53808

16,50€

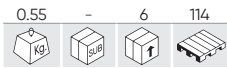

850mm

POTEAU EN PLASTIQUE POUR CHAÎNES

- Matériau: PVC.
- Base gonflable.



53914

75,00€



PÔLE DE SÉPARATION AVEC BANDE RÉTRACTABLE

- Matériel: acier
- Diamètre du tube: 63 mm
- Diamètre de la base: 320 mm
- Hauteur: 910 mm

- Sortie ruban dans 4 directions
- Longueur du ruban: 3 m
- Largeur de ceinture: 48 mm



53811

8,90€

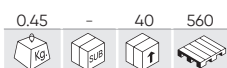

RUBAN DE SIGNALISATION BLANC ET ROUGE - 200M



53839

0,25€

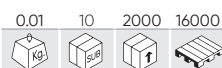

MAILLE DE CHAÎNE EN PLASTIQUE



53809

8,00€



CHAÎNE PVC - 5M

- Longueur: 5m
- Lien: 6 mm
- Couleur: rouge / blanc

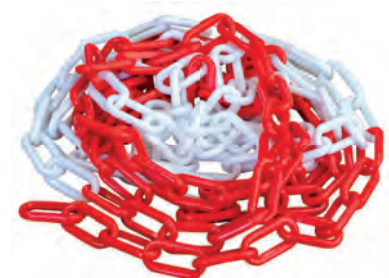

53796

76,00€



GÉNÉRATEUR D'OZONE PORTABLE 600 MG/H (12V/220V)

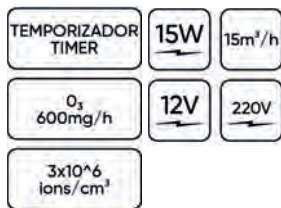

600mg/h

Temporizador/Timer	30/30min	60min	HOLD
--------------------	----------	-------	------

53786

98,00€



GÉNÉRATEUR D'OZONE PORTABLE 5000 MG/H (220V)



5.000mg/h

50m³	20 min
100m³	40 min
150m³	60 min
200m³	80 min
300m³	100 min

53806

250,00€



GÉNÉRATEUR D'OZONE PORTABLE 20000 MG/H (220V)

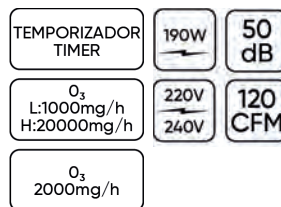

10.000mg/h

50m³	8 min
100m³	16 min
150m³	24 min
200m³	32 min
300m³	48 min
500m³	65 min

20.000mg/h

500m³	30 min
600m³	40 min
700m³	50 min
800m³	60 min
900m³	70 min
1.000m³	80 min

REF. DESCRIPTION

14775	PLAQUE DE RECHANGE POUR GÉNÉRATEUR D'OZONE PORTABLE (REF. 53786)	0.02	-	1	-	30,50€
-------	--	------	---	---	---	--------

REF. DESCRIPTION

14803	PLAQUE DE RECHANGE POUR GÉNÉRATEUR D'OZONE PORTABLE	0.03	-	50	-	43,00€
-------	---	------	---	----	---	--------

53838

38,00€



BOÎTE DE TRAITEMENT À L'OZONE

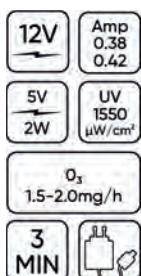

- Longueur d'onde ultraviolette: 254 nm
- Prise de courant: connecteur micro-USB
- La boîte est facilement assemblable et démontable, facilitant ainsi son transport.



ÉLARGIE



PLIÉ



53802

120,00€



OZONOMÈTRE

- Précision: ±5% F.S.
- Plage de mesure: 0-50ppm (0-98mg/m³)
- Alarme basse: 5ppm (9.8mg/m³)
- Alarme haute: 10ppm (19.6 mg/m³)
- Temps de réponse: <30 segundos
- Températures de fonctionnement: -10°C - 55°C
- Protection IP65



DEUX NIVEAUX D'ALARME CONFIGURABLES POUR DIFFÉRENTS NIVEAUX DE CONCENTRATION

TEMPS DE TRAVAIL: >8H
TEMPS DE CHARGE: 4H-6H



CONFORME À: EN61326-1, EN61000-4-2, EN61000-4-3

CONSOMMABLES

- 383** GOUPILLES ET CIRCLIPS
- 384** RONDELLES
- 384** VIS ÉCROU RONDELLES
- 388** RONDELLES POUR CARROSSERIE
- 391** AUTRES
- 391** JOINTS TORIQUES
- 392** CONNECTEURS DE TUYAUX
- 393** ÉLECTRIQUE
- 396** PINCES ET AGRAFES EN PLASTIQUE



52044

19,00€

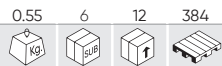

ÉTUI D'ASSORTIMENT GOUPILLES BETA 150U.



REF.	Image	PCS	€
10793		2,3x43	25 0,25€
10794		3,2x52	20 0,40€
10795		3,8x75	8 0,60€
10882		2x32	42 0,25€
10883		1,6x36	30 0,25€
10884		1,6x42	25 0,25€

52027

14,00€

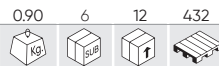

ÉTUI DE GOUPILLES FONDUES 365 PIÈCES



REF.	Image	PCS	€
10796		1,2x25	50 0,07€
10797		1,6x32	50 0,09€
10798		2x40	50 0,12€
10799		2,5x40	50 0,13€
10800		3,2x40	50 0,15€
10801		3,2x50	50 0,17€
10802		4x50	40 0,19€
10803		5x63	10 0,05€
10804		6,3x63	15 0,22€

53348

14,00€

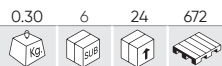

ÉTUI DE E-CLIPS



Image	PCS
M1.5 - 1/16"	15
M3 - 1/8"	15
M5 - 3/16"	20
M6 - 1/4"	25
M9 - 3/8"	25
M12 - 1/2"	20
M15 - 5/8"	10
M19 - 3/4"	10
M22 - 7/8"	10

53350

14,00€

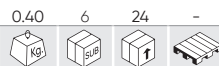

ÉTUI DE BARRETTES ELASTIQUES



1/16" x 3/16"	4	3/16" x 5/8"	5
1/16" x 5/16"	4	3/16" x 1"	5
1/16" x 3/4"	4	3/16" x 1-1/4"	5
5/64" x 1/4"	4	7/32" x 5/8"	4
5/64" x 1/2"	4	7/32" x 1-1/4"	4
5/64" x 1"	4	7/32" x 1-3/4"	4
3/32" x 5/8"	4	1/4" x 5/8"	4
3/32" x 1"	4	1/4" x 1-1/4"	4
3/32" x 1-1/4"	4	1/4" x 1-3/4"	4
1/8" x 5/8"	5	5/16" x 3/4"	4
1/8" x 1"	5	5/16" x 1-1/2"	4
1/8" x 1-1/4"	5	5/16" x 2"	4
5/32" x 5/8"	4	3/8" x 3/4"	2
5/32" x 1"	4	3/8" x 1-1/2"	2
5/32" x 1-1/2"	4	3/8" x 2"	2

53363

34,00€

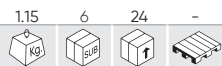

ÉTUI DE GOUPILLES CLEVIS ET DE CLIPS EN R

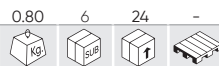

Image	PCS
3.5x44	6
2.5x42	20
2.5x58	7
2x3	7

Image	PCS
8x50	5
9.5x50	18
11x63	5
12.5x50	3

53364

16,00€



ÉTUI DE CLAVETTES



Image	PCS
3x3x25	4
3x3x20	4
5x5x30	5
5x5x25	5
5x5x20	5
6x6x40	5
6x6x30	5
6x6x20	5
8x8x40	5
8x8x30	5
10x10x40	5
10x10x30	5
12x12x40	2

53371

29,00€

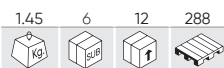

ÉTUI DE GOUPILLES CLIPS

50 PCS



	PCS
5x36	16
6x45	18
8x45	6
11x45	10

53372

26,00€



ÉTUI DE CLAVETTES

144 PCS



	PCS
M3x50	50
M4x60	30
M5x75	20
M6x50	20
M6x75	16
M8x60	8

53373

14,50€

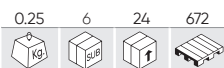

ÉTUI DE GOUPILLES DENTELÉE

260 PCS



	PCS
M3x10	30
M4x12	30
M5x14	40
M6x14	50
M8x18	50
M10x20	40
M12x25	20

53383

11,50€



ÉTUI DE GOUPILLES SEEGER EXTÉRIEUR

300 PCS



	PCS
M4	50
M6	40
M8	45
M10	30
M12	30
M14	25
M16	25
M18	25
M20	15
M22	15

53382

11,00€



ÉTUI DE GOUPILLES SEEGER INTÉRIEUR

300 PCS



	PCS
M4	50
M6	40
M8	45
M10	30
M12	30
M14	25
M16	25
M18	25
M20	15
M22	15

52711

27,50€



ÉTUI D'INSERTS PLASTIQUE

150 PCS



REF.		PCS	€
13674	6x19,3mm	25	0,50€
13675	6x17,8mm	25	0,50€
13676	6x25,5mm	25	0,50€
13677	6x24,5mm	25	0,50€
13678	6x24mm	50	0,50€

52703

22,00€



ÉTUI D'INSERTS TETE PLATE



REF.		PCS	€
13235	M3	50	0,15€
13236	M4	50	0,15€
13237	M5	50	0,15€
13238	M6	40	0,20€
13239	M8	20	0,20€
13240	M10	15	0,40€
13241	M12	10	0,55€

53360

18,00€



ÉTUI DE RIVETS INSERTS



	PCS
3x9	40
4x11	35
5x13	25
6x15	25
8x18	15
10x21	10

53361

24,00€

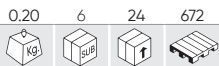

ÉTUI DE RIVETS INSERTS ALUMINIUM



	PCS
3x9	40
4x11	35
5x13	25
6x15	25
8x18	15
10x21	10

52043

16,50€



ÉTUI DE RIVETS 300 PIÈCES



REF.		PCS	€
10877	4,8x16,90mm	50	0,25€
10878	4,8x24,80mm	40	0,30€
10879	3,2x9,70mm	90	0,20€
10880	4,8x12,70mm	70	0,20€
10881	4,80x20mm	50	0,25€

53351

12,50€

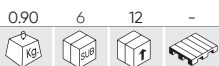

ÉTUI DE VIS ET ÉCROUS



	PCS		PCS
M4x12	10	M4	20
M4x20	10	M5	20
M5x16	10	M6	20
M5x25	10	M8	10
M6x20	10	M10	10
M6x30	10		PCS
M8x25	5	M4	20
M8x40	5	M5	20
M10x16	5	M6	20
M10x40	5	M8	10
		M10	10

53354

14,00€



ÉTUI DE VIS FILETÉS



	PCS
#8x12.5	30
#8x16	30
#8x19	30
#8x25	30
#10x12.5	20
#10x16	20
#10x19	20
#10x25	20

53362

14,00€

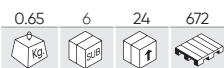

ÉTUI DE VIS ALLEN



	PCS
4x12	25
5x12	25
5x25	20
10x40	3
6x25	10
8x40	5
10x25	3
6x12	10
8x25	5



53365

14,00€

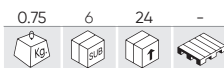

ÉTUI D'ÉCROUS PAPILLON



	PCS
M4	40
M5	40
M6	25
M8	25
M10	20



53366

14,00€

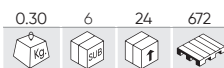

ÉTUI DE VIS ET ÉCROUS TYPE U



	PCS
M3.5x8	40
M4.2x16	20
M5x12	15
M6.35x19	10
M3.5	20
M3.5 Con muesca/with notch	20
M4	20
M5	15
M6.35	10



53369

14,00€



ÉTUI DE CLAVETTES



	PCS
2.8x13mm	65
2.8x16mm	55
3.5x10mm	60
3.5x13mm	65
3.5x16mm	60
3.5x19mm	45
4.2x13mm	50
4.2x16mm	40
4.2x25mm	30
4.2x31mm	20
4.8x19mm	25
4.8x25mm	20
4.8x32mm	15



52029

14,00€

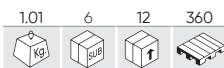

ÉTUI D'ÉCROUS FREIN 228U.



	PCS
M3	50
M4	50
M5	40
M6	30
M8	20
M10	15
M12	10
M14	8
M16	5



52028

15,20€

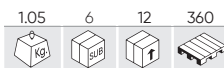

ÉTUI D'ÉCROUS 6 PANS 243 PIÈCES



REF.		PCS	€
10805	M3	50	0,10€
10779	M4	50	0,05€
10780	M5	50	0,05€
10781	M6	30	0,05€
10784	M8	20	0,05€
10785	M10	20	0,10€
10786	M12	10	0,15€
10812	M14	8	0,30€
10813	M16	5	0,30€



52032

28,00€

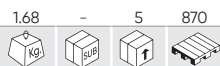

ÉTUI DE RONDELLES GROWER - 1.735U.

1735 PCS



	PCS
3mm	600
4mm	400
5mm	220
6mm	220
8mm	110
10mm	65
12mm	50
14mm	40
16mm	30



53377

20,00€

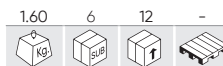

ÉTUI DE RONDELLES ACIER

240 PCS



	PCS
20x6x1.5	20
20x8x1.5	20
20x10x1.5	20
25x6x1.5	20
25x8x1.5	20
25x10x1.5	20
32x2x1.5	20
32x4x1.5	20
32x6x1.5	20
32x8x1.5	20
32x10x1.5	20
32x10x1.5	20



52158

38,50€



ÉTUI DE RONDELLES TRES LARGE GALVANISÉ, 475PCS

475 PCS

	PCS		PCS
5x20x1.5	50	6x30x2	25
6x20x1.5	50	7x30x2	25
7x20x1.5	50	8x30x2	25
8x20x1.5	50	4x11x0.98	50
8x25x1.75	50	12x40x3	25
10x30x2.5	25	4x20x1.5	50



51804

58,00€



ÉTUI MIXTE VISSERIE BOULONNERIE ET RONDELLES

828 PCS

REF.	DESCRIPTION	PCS	€
10772	VIS ZINGUÉE DIN 933 8.8 M4 X 25U.	25	0,05€
10773	VIS ZINGUÉE DIN 933 8.8 M5X50	25	0,10€
10774	VIS ZINGUÉE DIN 933 8.8 M6X50	25	0,10€
10775	VIS ZINGUÉE DIN 933 8.8 M7X50	15	0,15€
10776	VIS ZINGUÉE DIN 933 8.8 M8X50	15	0,20€
10777	VIS ZINGUÉE DIN 933 8.8 M10X50	12	0,20€
10778	VIS ZINGUÉE DIN 933 8.8 M12X60	20	0,35€
10779	ÉCROU ZINGUÉ DIN 934 M4	50	0,05€
10780	ÉCROU ZINGUÉ DIN 934 M5	50	0,05€
10781	ÉCROU ZINGUÉ DIN 934 M6	50	0,05€
10782	ÉCROU ZINGUÉ DIN 934 M7	50	0,05€
10783	RONDELLE ZINGUÉE DIN 125 M12	50	0,05€
10784	ÉCROU ZINGUÉ DIN 934 M8	50	0,05€
10785	ÉCROU ZINGUÉ DIN 934 M10	50	0,10€
10786	ÉCROU ZINGUÉ DIN 934 M12	40	0,15€
10787	RONDELLE ZINGUÉE DIN 125 M4	50	0,05€
10788	RONDELLE ZINGUÉE DIN 125 M5	50	0,05€
10789	RONDELLE ZINGUÉE DIN 125 M6	50	0,05€
10790	RONDELLE ZINGUÉE DIN 125 M7	50	0,05€
10791	RONDELLE ZINGUÉE DIN 125 M8	50	0,05€
10792	RONDELLE ZINGUÉE DIN 125 M10	50	0,05€

REF.	DESCRIPTION	PCS	€
50959	MALLETTE DE RANGEMENT 20+1	1	14,00€



53464

153,00€

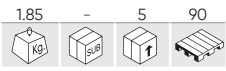

551 PCS

ÉTUI DE RONDELLES EN CUIVRE POUR INJECTEURS 551 PCS

PIÈCES DE RECHANGE DISPONIBLES

REF.	DESCRIPTION	PCS	€
13945	Ø15.0x8.0x1.5 - UNIVERSAL	30	7,40€
13946	Ø15.0x7.0x1.5 - MERCEDES	12	6,70€
13947	Ø13.0x7.5x2.5 - RENAULT	30	5,85€
13948	Ø15.0x7.5x1.5 - IVECO, FORD, BMW, MAN	30	5,00€
13949	Ø15.0x7.5x2.0 - IVECO, FORD, BMW, MAN	30	6,50€
13950	Ø15.45x8.0x2.0 - UNIVERSAL	30	7,80€
13951	Ø13.5x10x2.0 - MAZDA (REF.. 53464)	12	5,15€
13952	Ø15.5x7.5x2.5 - FORD	30	10,90€
13953	Ø15.5x7.5x1.5 - LAND ROVER	12	8,00€
13954	Ø15.0x7.5x3.0 - RENAULT	30	12,70€
13955	Ø13.0x7.0x1.5 - DEUTZ	12	4,95€
13956	Ø13.5x7.5x1.5 - FORD	30	4,30€
13957	Ø15.0x7.5x1.5 - FIAT	12	9,70€
13958	Ø15.5x7.5x1 - MAN ROVER	12	5,45€
13959	Ø16.5x7.5x2 - MERCEDES	30	10,10€
13960	Ø13.7x7.3x3 - KIA	12	9,65€
13961	Ø13.7x7.3x2 - KIA	12	9,25€
13962	Ø10x6.0x1.0	50	1,76€
13963	Ø15.8x7.5x3.0	30	12,40€
13964	SAC DE 30 CONNECTEURS DE TUYAU EN "T"	20	15,00€
13965	Ø8x5.8x1	30	1,50€
13966	SAC DE 30 CONNECTEURS DE TUYAU EN "L"	30	12,90€
13967	SAC DE 30 SPRINGS RETENUE	25	4,65€



52031

44,00€

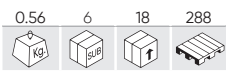

ÉTUI DE RONDELLES EN ALUMINIUM 900 PIÈCES



Ø	PCS
3x7x1.5	50
4x8x1.5	50
5x6x1.5	50
16x22x1.5	50
14x22x1.5	50
14x20x1.5	50
6x10x1.5	50
6x11x1.5	50
7x11x1.5	50
7x12x1.5	50
8x12x1.5	50
8x14x1.5	50
9x12x1.5	50
10x14x1.5	50
11x16x1.5	50
11x17x1.5	50
12x16x1.5	50
12x18x1.5	50



53353

18,00€

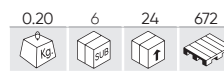

ETUI DE RONDELLES EN CUIVRE



Ø	PCS
M6	30
M8	25
M10	20
M12	15
M14	10
M16	10



52163

95,00€

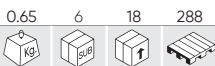

ÉTU DE JOINT DE VIDANGE



PIÈCES DE RECHANGE DISPONIBLES

TU POURRAIS AUSSI AIMER...

REF.	mm	PCS	€
51538	∅ 10mm	100	0,15€
51539	∅ 12mm	100	0,15€
51540	∅ 14mm	100	0,15€
51541	∅ 16mm	100	0,25€
51542	∅ 18mm	100	0,20€
51543	∅ 20mm	25	0,25€

REF.	mm	PCS	€
51544	∅ 22mm	100	0,25€
51545	∅ 26mm	100	0,30€

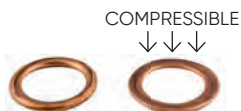

52030

98,00€



MALLETTE RONDELLES PLATES 900 P



PIÈCES DE RECHANGE DISPONIBLES

REF.	mm	PCS	€
10823	3x7x1,5mm	50	0,20€
10824	4x8x1,5mm	50	0,20€
10825	5x6x1,5mm	50	0,20€
10826	16x22x1,5mm	50	0,40€
10827	14x22x1,5mm	50	0,60€
10828	14x20x1,5mm	50	0,45€
10829	6x10x1,5mm	50	0,20€
10830	6x11x1,5mm	50	0,20€
10831	7x11x1,5mm	50	0,20€

REF.	mm	PCS	€
10832	7x12x1,5mm	50	0,20€
10833	8x12x1,5mm	50	0,20€
10834	8x14x1,5mm	50	0,25€
10835	9x12x1,5mm	50	0,25€
10836	10x14x1,5mm	50	0,30€
10837	11x16x1,5mm	50	0,30€
10838	11x17x1,5mm	50	0,30€
10839	12x16x1,5mm	50	0,40€
10840	12x18x1,5mm	50	0,35€



ÉTUI DE RONDELLES EN CUIVRE POUR INJECTEURS

53229

38,70€



PCS	PCS
13,8 x 7,3 x 1,4mm 10	15,0 x 7,5 x 3,0mm 10
14,6 x 7,5 x 1,3mm 10	15,5 x 7,5 x 2,0mm 10
14,6 x 7,5 x 3,0mm 10	16,0 x 7,5 x 1,5mm 10
15,0 x 7,0 x 2,0mm 10	16,0 x 7,5 x 1,7mm 10
15,0 x 7,5 x 1,0mm 10	16,0 x 7,5 x 2,0mm 10
15,0 x 7,5 x 1,5mm 10	16,4 x 7,5 x 2,0mm 10
15,0 x 7,5 x 2,0mm 10	20,0 x 9,4 x 0,9mm 10
15,0 x 7,5 x 2,5mm 10	



53340

86,00€



PCS	PCS
13,8 x 7,3 x 1,4mm 25	15,0 x 7,5 x 3,0mm 25
14,6 x 7,5 x 1,3mm 25	15,5 x 7,5 x 2,0mm 25
14,6 x 7,5 x 3,0mm 25	16,0 x 7,5 x 1,5mm 25
15,0 x 7,0 x 2,0mm 25	16,0 x 7,5 x 1,7mm 25
15,0 x 7,5 x 1,0mm 25	16,0 x 7,5 x 2,0mm 25
15,0 x 7,5 x 1,5mm 25	16,4 x 7,5 x 2,0mm 25
15,0 x 7,5 x 2,0mm 25	20,0 x 9,4 x 0,9mm 25
15,0 x 7,5 x 2,5mm 25	



53229 - 53340 PIÈCES DE RECHANGE DISPONIBLES

REF.	mm	PCS	€
13819	13,8 x 7,3 x 1,4mm	50	6,50€
13820	14,6 x 7,5 x 1,3mm	50	7,00€
13821	14,6 x 7,5 x 3,0mm	50	14,00€
13822	15,0 x 7,0 x 2,0mm	50	11,00€

REF.	mm	PCS	€
13823	15,0 x 7,5 x 1,0mm	50	6,00€
13824	15,0 x 7,5 x 1,5mm	50	8,00€
13825	15,0 x 7,5 x 2,0mm	50	11,50€
13826	15,0 x 7,5 x 2,5mm	50	13,00€

REF.	mm	PCS	€
13827	15,0 x 7,5 x 3,0mm	50	15,00€
13828	15,5 x 7,5 x 2,0mm	50	11,50€
13829	16,0 x 7,5 x 1,5mm	50	10,50€
13830	16,0 x 7,5 x 1,7mm	50	10,50€

REF.	mm	PCS	€
13831	16,0 x 7,5 x 2,0mm	50	12,60€
13832	16,4 x 7,5 x 2,0mm	50	13,00€
13833	20,0 x 9,4 x 0,9mm	50	9,00€

54390

199,00€



N

JEU DE CONNECTEURS ET DE TUBES DE CARBURANT (95 PIÈCES)

PIÈCES DE RECHANGE DISPONIBLES

REF.	mm	PCS	€	REF.	mm	PCS	€
16462	6,3x6mm	3	36,50€	16538	7,5x200mm	3	19,50€
16463	7,89x8mm	3	36,50€	16539	12x200mm	1	18,00€
16464	9,49x8 mm	3	36,50€	16540		1	13,00€
16465	9,89x8 mm	3	39,50€	16541	6x340mm	2	13,00€
16466	11,80x10mm	3	50,00€	16542	8x340mm	6	23,50€
16467	6,3x6 mm	3	36,50€	16543	9,5x340mm	2	13,00€
16468	7,89x8 mm	3	36,50€				
16469	9,49x8 mm	3	36,50€				
16470	9,89x8 mm	3	39,50€				
16471	11,8x10mm	3	50,00€				
16472	6,3x6 mm	5	17,50€				
16473	7,89x8mm	5	17,50€				
16474	9,49x8 mm	5	17,50€				
16475	9,89x8mm	5	17,50€				
16476	11,8x10 mm	5	24,00€				
16477	6x7,5mm	3	24,50€				
16478	8x7,5mm	6	24,50€				
16479	15 - 18mm	12	7,50€				
16480	17-20mm	4	7,50€				

**95
PCS**



JOINTS CAOUTCHOUC À LÈVRE

REF.	DESCRIPTION					€
52719	JOINT AVEC LEVRE CAOUCHOUC 10MM DIAM.	0.00	100	5000	150000	0,19€
51843	JOINT AVEC LEVRE CAOUCHOUC 12MM DIAMÈTRE	0.01	100	5000	200000	0,19€
51554	JOINT AVEC LEVRE CAOUCHOUC GOMME (FORD) 13MM DIAM.	0.00	100	5000	180000	0,28€
51546	JOINT AVEC LEVRE CAOUCHOUC 14MM DIAM.	0.00	100	5000	150000	0,19€
51799	JOINT AVEC LEVRE CAOUCHOUC 16MM DIAM.	0.01	100	120000	120000	0,20€



53599

30,30€

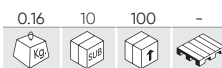

ENSEMBLE DE NOYAUX DE SOUPAPE DE CLIMATISEUR

**134
PCS**

PIÈCES DE RECHANGE DISPONIBLES

REF.	mm	PCS	€	REF.	mm	PCS	€
14594	5x19mm R12	50	2,00€	14599	7x20mm R134A	10	4,50€
14595	5x19mm	30	1,50€	14600	6x22mm	5	9,50€
14596	5x19mm R12	30	2,00€	14601	8x22mm	1	11,00€
14597	6x19mm	3	7,60€	14602	9x22mm	4	11,00€
14598	6x26mm	1	17,80€				



53358

11,50€

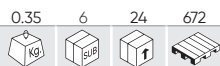

ÉTUI DE RESSORTS



	PCS		PCS
	5/16x1-3/4	12	13/64x13/16
			7/32x1
			1/4x7/8
	9/32x1/2	10	5/16x1-1/8
	1/4x13/32	10	5/16x1-1/4
	7/32x11/16	10	3/16x1-3/4
	7/32x1-1/2	10	9/32x1-1/2
	3/8x5/8	6	11/32x1-7/16
	3/8x3/4	12	11/32x1-27/32
	23/64x1-3/8	8	9/32x2
	9/32x3/4	10	5/32x3-1/8



53352

12,00€

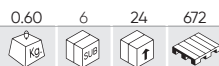

ÉTUI DE VIS CROCHET



	PCS
	2.4x41
	4x64
	4.2x85

	PCS
	2.4x25
	4x45
	4x50



52033

43,00€

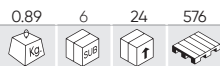

ÉTUI DE RACCORDS DE GRAISSEUR- 135 PIÈCES



REF.	90°	PCS	€
10874	6x1	20	0,30€
10875	8x1	15	0,40€
10876	10x1	10	0,45€

REF.	ANGLE DROIT	PCS	€
10868	6x1	20	0,30€
10869	8x1	15	0,30€
10870	10x1	10	0,45€

REF.	45°	PCS	€
10871	6x1	20	0,30€
10872	8x1	15	0,40€
10873	10x1	10	0,45€



53359

16,00€

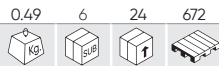

ÉTUI DE RACCORDS DE GRAISSEUR - 110 PIÈCES



	90°
6x1	60
8x1.25	10
10x1.5	10

	ANGLE DROIT
6x1	5
8x1.25	5
10x1.5	5

	45°
6x1	5
8x1.25	5
10x1.5	5



53378

13,00€

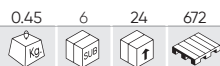

ÉTUI SERRE-TUBES 20 PIÈCES



	PCS
	1"
	2-1/2"
	1-1/4"
	3"
	1-3/4"
	3-1/2"
	2"
	4"



53381

14,50€

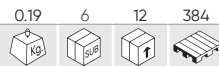

ÉTUI RONDELLES DE FIBRE 600 PIÈCES



	PCS
	10x5.5x1
	16x10x1
	19x12x1
	22x16x1
	22.5x14x1
	32x22x1
	12x6.5x1
	16x8x1
	20x12.5x1
	27x20x1
	25.4x17.5x1
	32x24x1



50651

18,00€

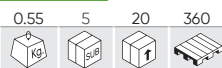

ÉTUI DE JOINTS TORIQUES METRIQUE

386 PCS

	COUVERCLE DE L'ÉTUI						BASE DE L'ÉTUI					
POSITION DANS L'ÉTUI	006	007	008	009	010	011	211	212	213	214	215	216
LARGEUR CAOUTCHOUC (MM)	2	2	2	2	2	2	3	3	3	3	3	3
Ø INTÉRIEUR (MM)	A 3	4	5	6	7	8	D 20	22	24	25	27	28
QUANTITÉ	16	16	16	16	16	16	12	12	12	12	12	12
POSITION DANS L'ÉTUI	113	112	111	110	012	221	220	219	218	217		
LARGEUR CAOUTCHOUC (MM)	B 2.5	2.5	2.5	2.5	2	E 3	3	3	3	3		
Ø INTÉRIEUR (MM)	14	12	11	10	10	36	35	33	32	30		
QUANTITÉ	13	13	13	13	17	12	12	12	12	12		
POSITION DANS L'ÉTUI	114	115	116	210	222	325	326	327				
LARGEUR CAOUTCHOUC (MM)	C 2.5	2.5	2.5	3	F 3	4	4	4				
Ø INTÉRIEUR (MM)	16	17	19	19	38	38	41	44				
QUANTITÉ	13	13	13	10	12	10	9	9				



50652

16,50€



ÉTUI DE JOINTS TORIQUES POUCE

382 PCS

	COUVERCLE DE L'ÉTUI						BASE DE L'ÉTUI					
POSITION DANS L'ÉTUI	006	007	008	009	010	011	211	212	213	214	215	216
LARGEUR CAOUTCHOUC (MM)	1/16	1/16	1/16	1/16	1/16	1/16	D 1/8	1/8	1/8	1/8	1/8	1/8
Ø INTÉRIEUR (MM)	A 1/8	5/32	3/16	7/32	1/4	5/16	13/16	7/8	15/16	1	11/16	11/18
QUANTITÉ	20	20	20	20	20	20	10	10	10	10	10	10
POSITION DANS L'ÉTUI	113	112	111	110	012	221	220	219	218	217		
LARGEUR CAOUTCHOUC (MM)	B 3/32	3/32	3/32	3/32	1/16	E 1/8	1/8	1/8	1/8	1/8		
Ø INTÉRIEUR (MM)	9/16	1/2	7/16	3/8	3/8	17/16	13/8	15/16	11/4	13/16		
QUANTITÉ	13	13	13	13	13	10	10	10	10	10		
POSITION DANS L'ÉTUI	114	115	116	210	222	325	326	327				
LARGEUR CAOUTCHOUC (MM)	C 3/32	3/32	3/32	1/8	F 1/8	3/16	3/16	3/16				
Ø INTÉRIEUR (MM)	5/8	11/16	3/4	3/4	11/2	11/2	15/8	13/4				
QUANTITÉ	13	13	13	10	10	7	7	7				
QUANTITÉ												



50807

38,00€



MALLETTE JOINT POUR CLIM

270 PCS

Ø	PCS	Ø	PCS	Ø	PCS
5.29x1.78	20	8.80x1.90	20	13.95x2.62	10
6.07x1.78	20	10.82x1.78	15	14.0x2.0	10
6.8x1.9	20	10.77x2.62	15	15.0x2.0	10
7.65x1.78	20	11.0x2.0	15	17.0x2.0	10
7.80x1.90	20	12.0x2.0	15	17.17x1.78	10
8.0x2.0	20	13.9x1.80	10	17.04x3.53	10



CONSOMMABLES

53910

19,00€

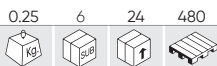

ÉTUI DE CONECTEURS TUYAUX 113 PCS



DROIT

4.8x4.8	10
6.3x6.3	8
7.9x7.9	6
9.5x9.5	6
3.17x3.17	30

RACCORD EN T

3.9x3.9x3.9	8
4.8x4.8x4.8	8
6.3x6.3x6.3	6
9.5x9.5x9.5	3
3.17x3.17x3.17	12

RÉDUCTEUR

9.5x6.3	6
6.3x4.8	10



53434

18,00€

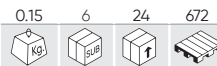

ÉTUI DE CONECTEURS TUYAUX 65 PCS



PCS

4x28.7	10
3.9x30.8	5
10.4x4.4	10
5.6x4.71	5
7.9x3.8	10
4.7x3.8.9	5
5.2x3.3.9	10
7x3.0	10



53992

18,00€



ÉTUI DE MANCHONS DE SOUDURE THERMORÉTRACTABLES 100PCS



Ø1.7mm / 0.25-0.34mm2 / 26-24 AWG	25
Ø2.7mm / 0.5-1.0mm2 / 22-18 AWG	35
Ø4.7mm / 1.5-2.5mm2 / 16-14 AWG	30
Ø6.0mm / 4.0-6.0mm2 / 12-10 AWG	10

53349

14,00€

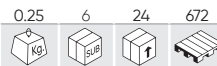

ÉTUI DE PASSES-CABLES EN CAOUTCHOUC



OUVERTS	PCS	FERMÉS	PCS
M19,5x23	2	M25	2
M16x24	3	M22	3
M13x15	3	M19	4
M11,5x19	4	M15	5
M10x20	3	M12	10
M10x12	5	M9	20
M9,8x11,5	6	M7	20
M8x14	3		
M7,5x13	7		
M6x7,5	10		
M3,5x6	15		



53374

10,00€

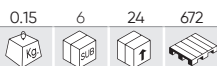

ÉTUI DE TUBES THERMORÉTRACTS



	PCS
M2x40	30
M2.5x40	25
M3.5x40	20
M5x40	20
M7x80	16
M10x80	8
M13x85	8



53376

10,50€



ÉTUI DE GOUPILLES TERMORETRACTILES



	PCS
M2x40	30
M2.5x40	25
M3.5x40	20
M5x40	20
M7x80	16
M10x80	8
M13x85	8



REF. DESCRIPTION

51920 CHALUMEAU

0.14 10 100 400 € 18,00€

53370

26,00€

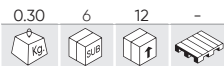

ÉTUI DE PASSE-CABLE CAOUTCHOUC - M2,3,4,5,6,8,10



PCS

M2	25
M3	25
M4	30
M5	30
M6	30
M8	20
M10	20

53355

11,50€

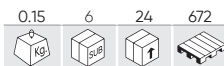

ÉTUI DE FUSIBLES MINI



PCS

5A	20
10A	20
15A	20
20A	20
25A	20
30A	20

53356

11,50€

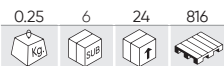

ÉTUI DE FUSIBLES



REF.	PCS	€
10915 5A	20	0,25€
10917 10A	20	0,30€

REF.	PCS	€
10918 15A	20	0,30€

REF.	PCS	€
10919 20A	20	0,30€
10920 25A	20	0,25€
10921 30A	20	0,30€

53367

9,50€

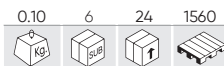

ÉTUI DE FUSIBLES 48 UNITÉS



PCS	
5A	8
10A	8
15A	8

PCS	
20A	8
25A	8
30A	8

53368

9,00€



ÉTUI DE FUSIBLES 50 UNITÉS



PCS	
5A	8
10A	8
15A	8
20A	8
25A	8
30A	10

53380

11,50€



ÉTUI DE FUSIBLES



PCS	
5A	20
10A	20
15A	20
20A	20
25A	20
30A	20

52054

17,00€

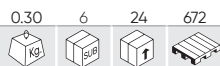

ÉTUI DE FUSIBLE ANFICHABLES 252U.



REF.	PCS	€
10905 3A	20	0,25€
10906 4A	20	0,25€
10907 5A	20	0,25€

REF.	PCS	€
10908 7,5A	20	0,30€
10909 10A	20	0,30€
10910 15A	20	0,30€

REF.	PCS	€
10911 20A	20	0,30€
10912 25A	20	0,25€
10913 30A	20	0,30€

REF.	PCS	€
10914 4A	8	0,25€
10915 5A	8	0,25€
12954 3A	8	0,25€

REF.	PCS	€
10916 7,5A	8	0,30€
10917 10A	8	0,30€
10918 15A	8	0,30€

REF.	PCS	€
10919 20A	8	0,30€
10920 25A	8	0,25€
10921 30A	8	0,30€



52053

45,00€

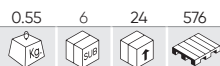

ÉTUI DE COSSES 635U.



REF.	PCS	€
10885 RV1.25-4S	50	0,20€
10886 RV2-4S	50	0,20€
10887 RV2-6S	30	0,25€
10888 RV5.5-6S	20	0,30€
10889 RV5.5-5S	20	0,30€
10893 RV2-5S	40	0,25€

REF.	PCS	€
10894 SV1-4S	50	0,20€
10895 SV2-4S	40	0,20€

REF.	PCS	€
10896 FDD1.25-250	45	0,30€
10898 FDD2-250	40	0,30€
10900 FDD5.5-250	25	0,30€

REF.	PCS	€
10890 BV5.5	15	0,35€
10891 BV2	25	0,25€
10892 BV1.25	30	0,30€

REF.	PCS	€
10897 MDD1.25-250	50	0,30€
10899 MDD2-250	50	0,30€
10901 MDD5.5-250	30	0,25€

REF.	PCS	€
10902 FDFN 1.25-250	25	0,30€



PINCE À SERTIR
VOIR PAGE 61



53357

7,00€



SET DE 2 PINCES CROCODILES



53385

19,30€



PINCE POUR EXTRACTION D'AGRAFES DE CARROSSERIE



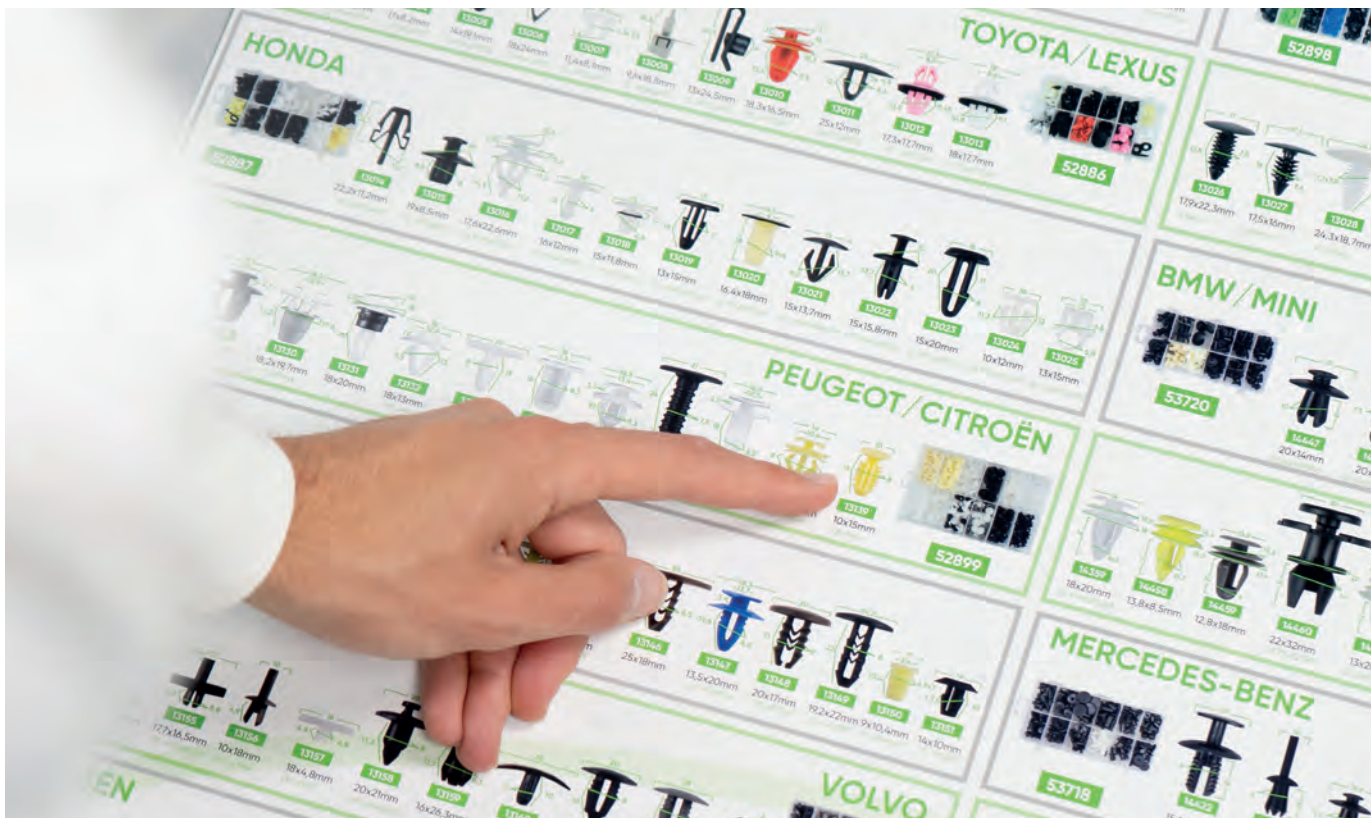

16294

14,00€

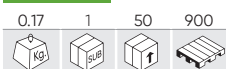

CLIPS D’AFFICHE TAILLE RÉELLE

SPÉCIFICATIONS TECHNIQUES:

Taille du Poster : 1000x640mm
Matériel : Papier de 250g plastifié
Il y a des trous pour l'accrocher.

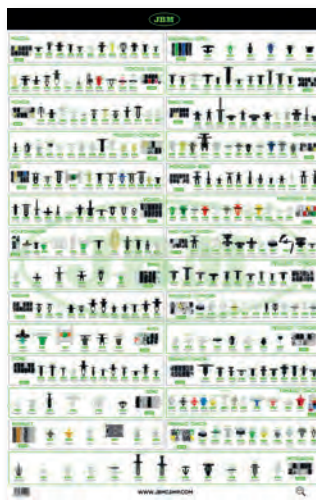

TAMAÑO REAL DE LOS CLIPS
CLIPS REAL SIZE

52851

9,65€



JEU DE 2 LEVIERS



53110

27,30€



SET DE 6 LEVIERS



- 5"x8.5mm
- 5"x10.3mm
- 5"x4.5mm
- 15"x8.5mm
- 15"x10.3mm
- 15"x4.5mm



CONSUMMABLES



UNITÉS
DANS L'ÉTIUI



UNITÉS PAR SAC DE
PIÈCES DE
RECHANGE



PRÉSENTATION
DANS UN ÉCRAN

52896



26,00€



ÉTIUI DE CLIPS EN PLASTIQUE POUR MAZDA 190 PCS

REF.	DESCRIPTION	Kit	Sac	€
13104	OE:2042301	8	8	1,90€
13105	OE:999100402	15	15	2,50€
13106	OE:B0016830200	8	8	2,00€
13107	OE:N30413356A	8	8	2,15€
13108	OE:992640543A	20	20	1,90€
13109	OE:99249051B	30	30	2,90€
13110	OE:6508197AA	15	15	1,85€
13111	OE:B1016825200	10	10	1,20€
13112	OE:B09251833	6	6	1,65€
13113	OE:992640543A	20	20	2,20€
13114	OE:B45556741	20	20	2,20€
13115	OE:G03158762	30	30	2,50€

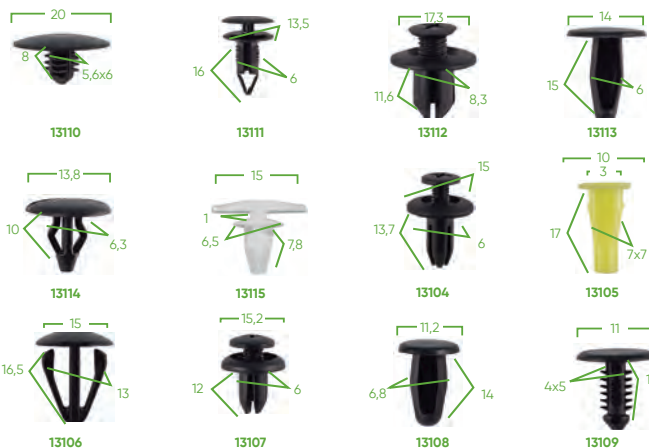

52886



18,00€



ÉTIUI CLIPS EN PLASTIQUE POUR TOYOTA / LEXUS 89 PCS

REF.	DESCRIPTION	Kit	Sac	€
13002	OE:9018906001	8	8	1,45€
13003	OE:9046707138	5	4	1,70€
13004	OE:9046707117	10	10	1,85€
13005	OE:9046709138	10	10	1,25€
13006	OE:9046709101	5	5	1,40€
13007	OE:75521611000	10	10	1,30€
13008	OE:7503933060	8	8	2,25€
13009	OE:9017905060	4	4	1,65€
13010	OE:677711250	8	8	1,75€
13011	OE:9046708124	5	5	1,15€
13012	OE:7539533030	8	8	1,80€
13013	OE:9046711063	8	8	1,75€



52887



22,00€



ÉTIUI DE CLIPS EN PLASTIQUE POUR HONDA 150 PCS

REF.	DESCRIPTION	Kit	Sac	€
13014	OE:75103SJ4003	12	12	1,45€
13015	OE:90675SB003	5	5	1,20€
13016	OE:91566SP0003	6	6	1,15€
13017	OE:91513SE003	25	25	2,60€
13018	OE:91530ST5003	25	25	1,45€
13019	OE:90687SA50030	15	15	1,75€
13020	OE:91620SR2003	8	8	1,70€
13021	OE:38529689A6300	8	8	1,30€
13022	OE:90683SA5003	10	10	2,10€
13023	OE:90672671003	10	10	1,50€
13024	OE:91534SEO000	18	18	2,45€
13025	OE:34355SD2003	8	8	1,50€



52899

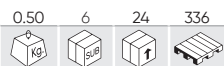

34,00€



ÉTUI CLIPS EN PLASTIQUE POUR PEUGEOT / CITROEN 345 PCS

REF.	DESCRIPTION	kg	box	€
13128	OE:947098	50	50	1,85€
13129	OE:856535	20	20	2,00€
13130	OE:6991W4	20	20	3,75€
13131	-	20	20	3,45€
13132	OE:694143	25	25	2,65€
13133	OE:743707	35	35	3,45€
13134	OE:7703074022	30	30	3,95€
13135	OE:7703077059	35	35	3,45€
13136	OE:698317	15	15	2,60€
13137	OE:699502	25	25	2,25€
13138	OE:6995X3	30	30	2,85€
13139	OE:69945	40	40	3,85€



52900



34,00€



CLIPS EN PLASTIQUE COFFRET POUR FIAT 308 PCS

REF.	DESCRIPTION	kg	box	€
13140	OE:14591784	30	30	2,65€
13141	OE:1459487	20	10	1,80€
13142	OE:1300433650	25	25	3,10€
13143	OE:71717421	8	8	1,95€
13144	OE:82456515	25	25	2,20€
13145	OE:5757139	25	25	3,85€
13146	-	20	8	4,50€
13147	OE:46306526	25	25	3,10€
13148	OE:14591687	25	25	3,30€
13149	OE:14592387	25	25	3,10€
13150	OE:83468473	30	30	2,25€
13151	OE:7677865	50	30	5,35€

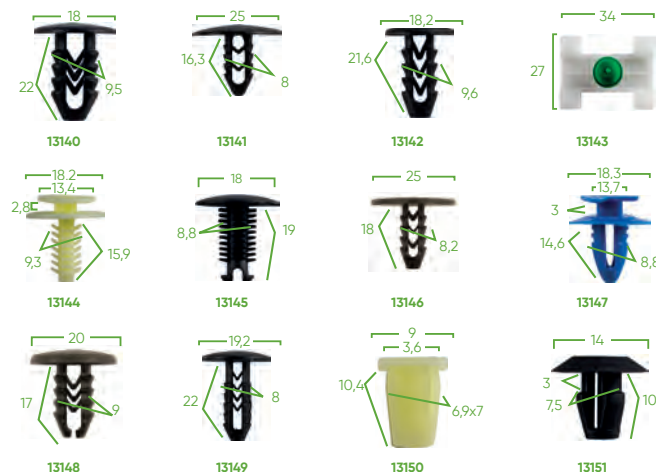

52901

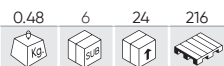

34,00€



ÉTUI DE CLIPS EN PLASTIQUE POUR VOLVO 350 PCS

REF.	DESCRIPTION	kg	box	€
13152	OE:8099905N07	25	25	3,05€
13153	OE:4292906	30	30	3,10€
13154	OE:12681763	20	20	3,20€
13155	OE:51131804205	40	40	5,60€
13156	OE:947098	40	40	3,30€
13157	OE:591740	40	40	3,85€
13158	OE:6384801G00	25	25	3,75€
13159	OE:9133417	20	20	3,20€
13160	OE:9133073	40	40	5,00€
13161	OE:3272075327462B	30	30	3,55€
13162	OE:327462A	20	20	2,60€
13163	OE:3923712	20	20	2,80€

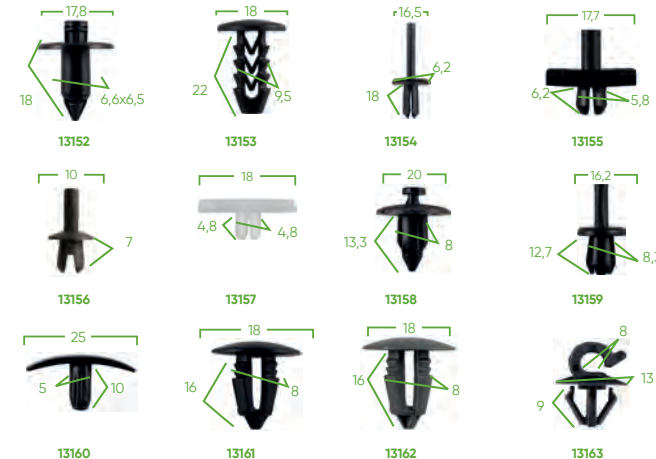

52889

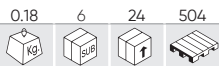

19,00€



ÉTUI DE CLIPS EN PLASTIQUE POUR VOLKSWAGEN 85 PCS

REF.	DESCRIPTION	Q	P	€
13038	OE:1H0868243B	2	2	1,40€
13039	OE:N90833801	10	10	1,65€
13040	OE:3A0853575	8	8	1,80€
13041	OE:4A0853825	5	5	1,55€
13042	OE:6U085733	15	15	1,95€
13043	OE:3B0853576	3	3	1,20€
13044	OE:1H0819055B01C	6	6	1,55€
13045	OE:443853909A	5	5	1,20€
13046	OE:171885767	6	6	1,55€
13047	OE:N9020160H	5	5	1,45€
13048	OE:NO385501	10	10	2,20€
13049	OE:191941142	10	10	2,05€

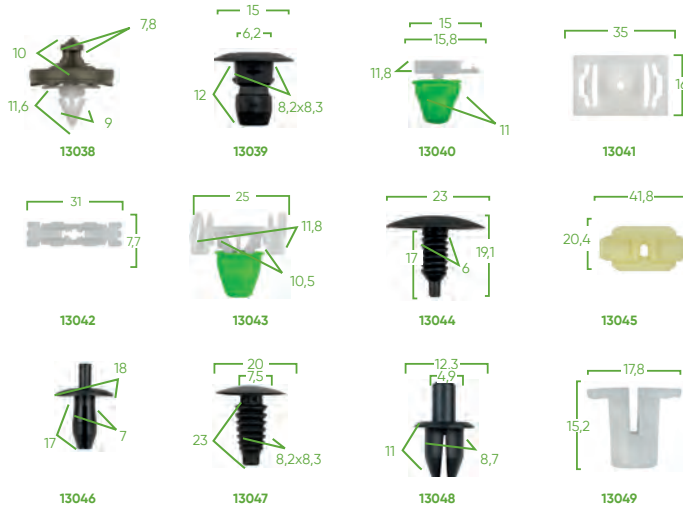

52891

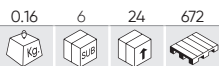

28,00€



ÉTUI DE CLIPS EN PLASTIQUE POUR FORD 169 PCS

REF.	DESCRIPTION	Q	P	€
13056	OE:388577S	8	8	1,55€
13057	OE:N801925S	5	5	1,50€
13058	OE:N806289S	20	20	2,20€
13059	OE:N379830S	20	20	2,35€
13060	OE:1007932	5	5	1,60€
13061	OE:16500308	20	20	2,65€
13062	OE:N803170S	20	20	2,35€
13063	OE:W706713S300	6	6	1,15€
13064	OE:N388246S	20	20	2,60€
13065	OE:F22Z16774A	15	15	2,00€
13066	OE:1673046	5	5	2,25€
13067	OE:F1CZ16674A	25	25	2,55€

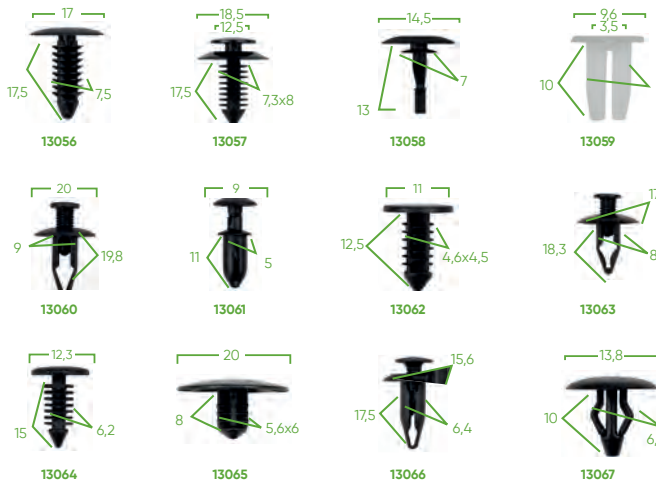

52894

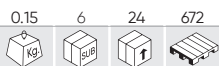

22,00€



ÉTUI DE CLIPS EN PLASTIQUE POUR NISSAN 139 PCS

REF.	DESCRIPTION	Q	P	€
13080	OE:76906T300	15	15	1,75€
13081	OE:0155300172	20	20	2,30€
13082	OE:68425H5000	10	10	1,35€
13083	OE:75521611000	6	6	1,50€
13084	OE:62869N4700	20	20	2,10€
13085	OE:6384401A00	5	5	1,60€
13086	OE:7688257A00	5	5	1,25€
13087	OE:6684101G00	25	25	3,30€
13088	OE:1099830880	10	10	2,40€
13089	OE:8942798070	10	10	1,70€
13090	OE:6384801G00	8	8	1,70€
13091	OE:6385401A00	5	5	1,25€



52890

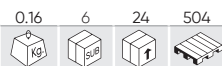

22,00€



ÉTUI DE CLIPS EN PLASTIQUE POUR AUDI 31 PCS

REF.	DESCRIPTION			€
13050	OE:3B0868243	5	15	1,55€
13051	OE:1H0867199A	5	20	1,50€
13052	OE:1H0868243B	3	3	1,25€
13053	OE:357853575	10	10	2,80€
13054	OE:1H0853585A	5	5	2,35€
13055	OE:3A0853575	3	3	3,00€

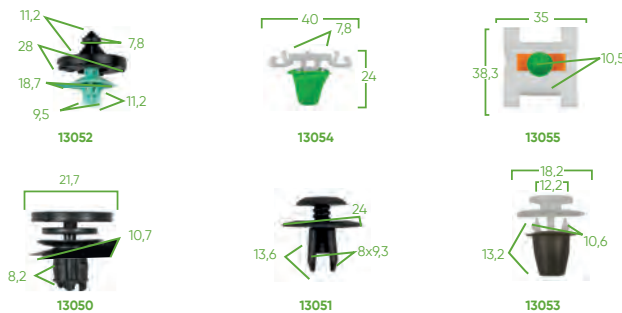

52892

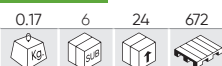

22,00€



ÉTUI DE CLIPS EN PLASTIQUE POUR BMW 95 PCS

REF.	DESCRIPTION			€
13068	OE:51311802258	25	25	2,85€
13069	OE:5131804205	30	30	4,55€
13070	OE:51118174185	10	10	2,15€
13071	OE:51481938725	10	10	2,05€
13072	OE:703867299	15	15	2,75€
13073	OE:51131960054	5	5	2,10€

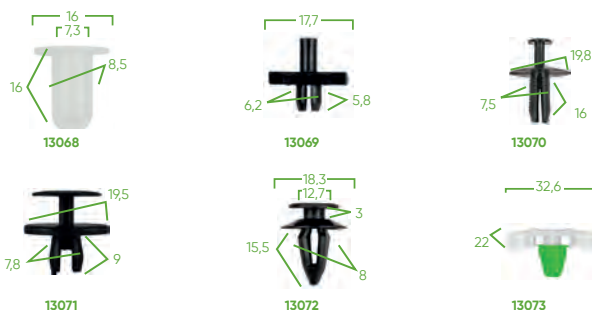

52897

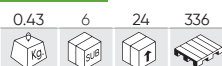

38,00€



ÉTUI DE CLIPS EN PLASTIQUE POUR RENAULT 300 PCS

REF.	DESCRIPTION			€
13116	OE:7703077421	50	50	5,45€
13117	-	50	50	3,65€
13118	OE:7703081184	60	60	15,90€
13119	-	15	15	5,60€
13120	OE:7703074022	60	60	5,50€
13121	OE:7703077059	65	65	8,75€

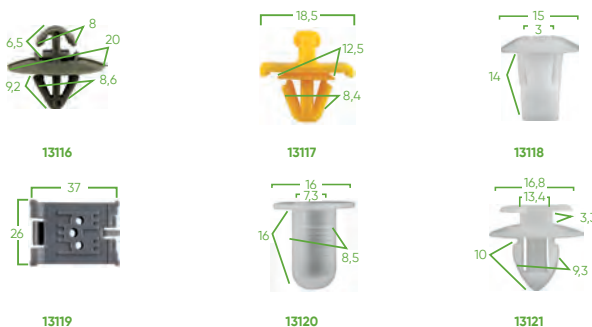

52898



36,00€



ÉTUI DE CLIPS EN PLASTIQUE POUR VAUXHALL / OPEL 300 PCS

REF.	DESCRIPTION			€
13122	OE:90218614	20	20	1,95€
13123	OE:174864	40	40	5,35€
13124	OE:NO385501	100	100	8,20€
13125	OE:2345959	50	50	5,95€
13126	OE:2240582	50	50	1,55€
13127	OE:180942	40	40	5,60€

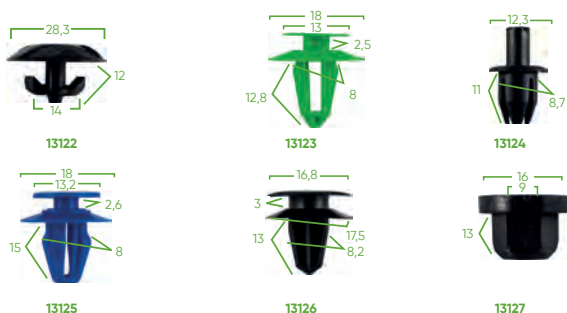

52893

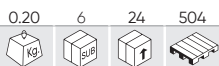

26,00€



ÉTUI DE CLIPS EN PLASTIQUE POUR BENZ 95 PCS

REF.	DESCRIPTION	Q	P	€
13074	OE:A0019884481	30	30	4,65€
13075	OE:A0019882981	20	20	5,35€
13076	OE:A1249900492	15	15	3,90€
13077	OE:A0019888081	4	4	2,55€
13078	OE:A1249880492	6	6	2,55€
13079	OE:A0019880325	20	20	3,35€

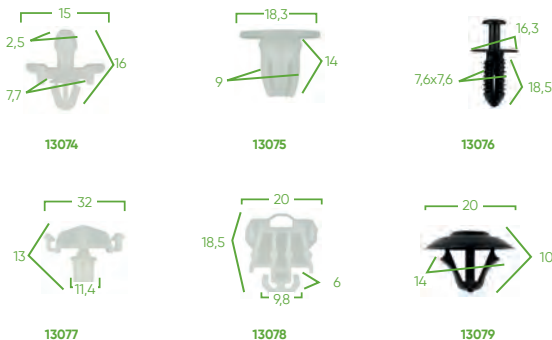

52895



22,00€



ÉTUI DE CLIPS EN PLASTIQUE POUR MITSUBISHI 134 PCS

REF.	DESCRIPTION	Q	P	€
13092	OE:8942180270	15	50	1,65€
13093	OE:9018905013	30	30	2,95€
13094	OE:MU480033	10	10	1,50€
13095	OE:128100231	8	6	1,20€
13096	OE:MU480034	8	8	1,70€
13097	OE:MR138807	3	3	1,20€
13098	OE:MB253964	4	4	1,65€
13099	OE:HB121467	30	30	2,75€
13100	OE:MB271999	3	3	1,20€
13101	OE:MB696120	8	8	1,50€
13102	OE:MR200300	5	5	1,60€
13103	OE:MB846992	10	10	1,80€

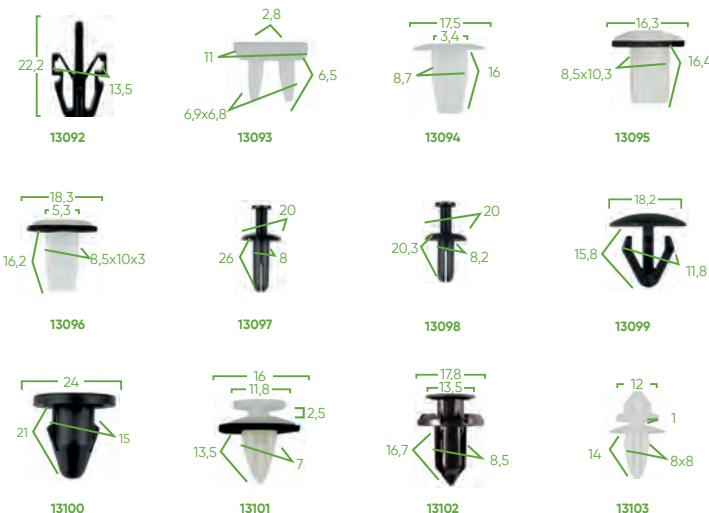

52888



24,00€



ÉTUI DE CLIPS EN PLASTIQUE UNIVERSEL 128 PCS

REF.	DESCRIPTION	Q	P	€
13026	OE:388577S	8	8	1,55€
13027	-	10	10	1,85€
13028	OE:6003423	6	6	1,45€
13029	OE:VW:N989022 CHRYSLER: 6003349 FORD:385661	6	6	1,65€
13030	OE:CHRYSLER: 6502328 GM:20699808	25	25	2,80€
13031	OE:N804379S	4	4	1,85€
13032	OE:FORD:F22Z16774A MAZDA:6508197AA	15	15	2,00€
13033	OE:GM:16674629 FORD:N806113S	10	10	1,60€
13034	OE:0153301781	20	20	2,65€
13035	OE:GM:10124502 BMW:52201964201 LAND ROVER:- DZM10080	6	6	1,65€
13036	OE:VW:N9020160H BMW:51471904317 OPEL:2207713	6	6	1,40€
13037	-	12	12	2,10€

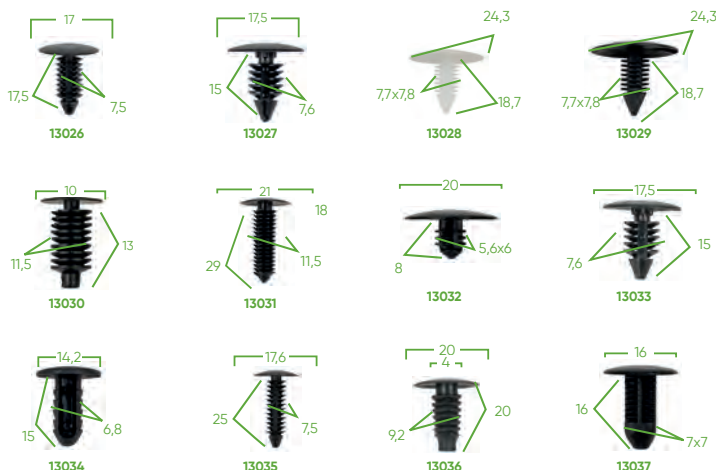

53720

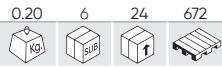

19,00€



ÉTUI DE 112 CLIPS POUR TAPISSERIE BMW MINI

REF.	DESCRIPTION			€
14447	OE: 51471911992	7	6	1,45€
14449	OE: 51717002953	13	10	2,20€
14471	OE: 51489119216	5	5	1,90€
14472	OE: A0009905492	5	5	1,35€
14474	OE: 51118174185	8	8	1,50€
14475	OE: 2019900050	6	6	1,65€
14476	OE: 51481915964	9	9	2,05€
14477	OE: 0009881625	15	15	2,45€
14478	OE: 7146976114	15	15	4,05€
14479	OE: 91503SP0003	6	6	1,65€
14480	-	15	15	2,05€
14481	OE: 51161943122	8	8	1,70€



53719

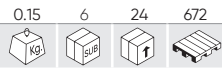

19,00€



ÉTUI DE 92 CLIPS POUR PANNEAUX DE PORTE/MOLDINGS BMW MINI

REF.	DESCRIPTION			€
14359	-	8	8	1,05€
14458	-	6	6	1,70€
14459	OE: 7147122912	2	2	1,45€
14460	OE: 51411973500	8	8	1,15€
14461	-	8	8	1,35€
14462	-	8	8	1,65€
14463	OE: 611769	10	10	1,65€
14464	OE: 7147145753	10	10	1,50€
14465	-	8	8	2,00€
14466	OE: 51418224768	8	4	1,65€
14468	-	8	8	1,30€
14469	OE: 7147133419	8	8	1,45€

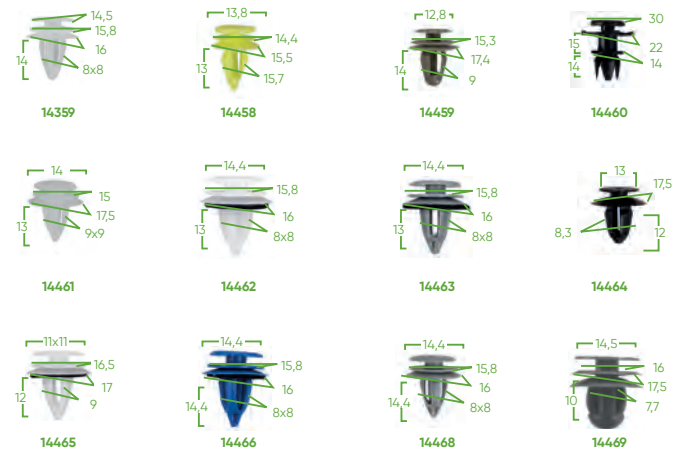

53718

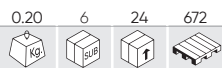

19,00€



ÉTUI DE 151 CLIPS POUR TAPISSERIE MERCEDES-BENZ

REF.	DESCRIPTION			€
14422	OE: A0009913940	20	20	1,50€
14446	OE: 9903492	6	6	2,80€
14447	OE: 51471911992	12	12	1,45€
14448	OE: N105835019B9	10	10	2,05€
14449	OE: A0009905492	12	12	2,20€
14450	OE: N0385012	12	12	2,15€
14451	OE: A1239900092	25	25	2,15€
14452	-	20	20	2,55€
14453	-	6	6	3,05€
14455	-	12	12	2,10€
14456	-	6	6	1,35€
14457	OE: A1249900492	10	10	1,70€

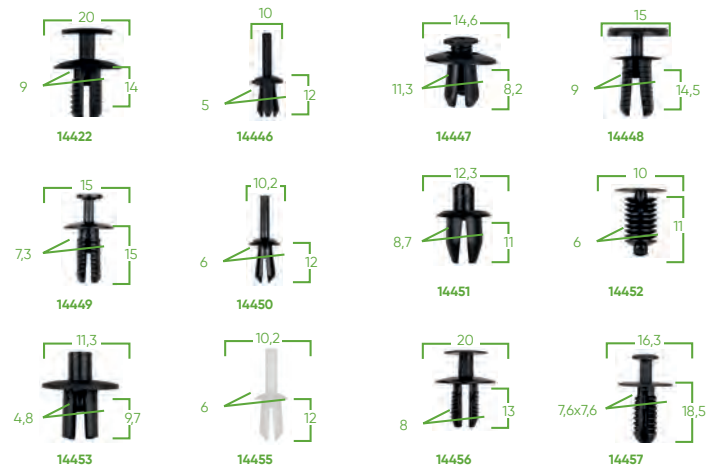

53717



19,00€



ÉTUI DE 96 CLIPS POUR PANNEAUX DE PORTE/MOLDINGS MERCEDES-BENZ

REF.	DESCRIPTION	100g	1kg	€
14434	-	8	8	1,60€
14435	-	6	6	1,45€
14436	OE: A0009910198	8	8	1,70€
14437	OE: A0019912698	6	6	1,45€
14438	OE: A0089880978	8	8	1,35€
14439	OE: 0069884378	8	8	1,75€
14440	-	8	8	1,75€
14441	OE: 0019884981	10	10	1,65€
14442	-	6	6	1,45€
14443	-	8	8	1,45€
14444	OE: 0019886081	10	10	1,90€
14445	-	10	10	1,45€

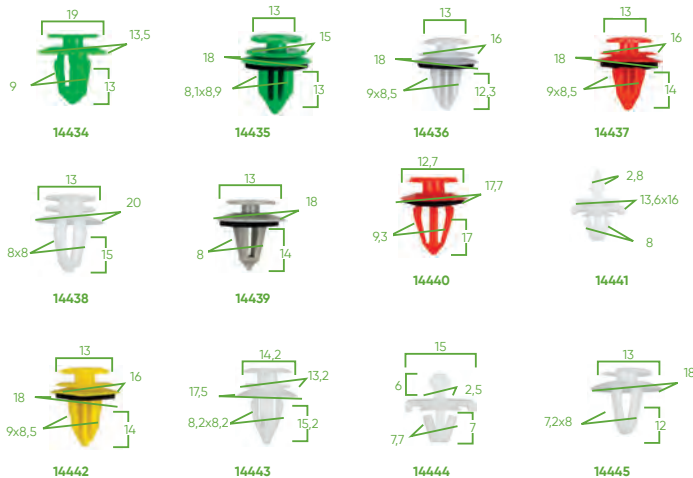

53716



19,00€



ÉTUI DE 79 CLIPS POUR PANNEAUX DE PORTE/MOLDINGS/TAPISSERIE VAG/SIÈGE/SKODA

REF.	DESCRIPTION	100g	1kg	€
14422	OE: A0009913940	6	6	1,50€
14423	OE: 6E0837732	15	15	3,55€
14424	-	7	7	1,85€
14425	OE: 6Q0868243	2	2	2,05€
14426	OE: 171201969	8	8	1,90€
14427	OE: 4D0807300	8	4	1,20€
14428	OE: 251823717	12	12	1,40€
14429	-	6	6	1,80€
14430	OE: 8E0821989A	3	3	2,25€
14431	OE: 3B0868243	2	2	1,45€
14432	OE: 1H0823171	10	10	1,45€

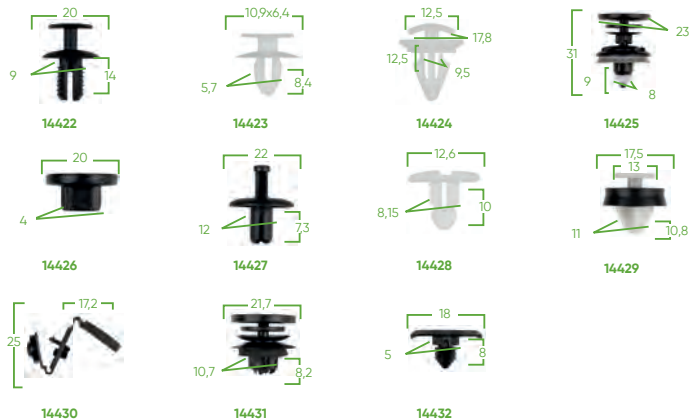

53715



19,00€



ÉTUI DE 110 CLIPS POUR TAPISSERIE PEUGEOT/CITROËN

REF.	DESCRIPTION	100g	1kg	€
14410	-	10	10	1,85€
14411	-	10	5	1,70€
14412	-	10	10	1,70€
14413	-	10	10	3,25€
14414	OE: 2346824	10	10	1,70€
14415	OE: A1249900492	10	10	1,70€
14416	OE: 6992C6	10	5	1,25€
14419	-	15	15	1,95€
14420	-	15	15	1,50€
14421	OE: 14093311	10	10	2,45€



53714

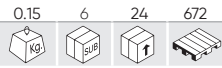

16,00€



ÉTUI DE 80 CLIPS POUR MOLDINGS PEUGEOT/CITROËN

REF.	DESCRIPTION			€
14398	OE: 6995X3	8	8	1,30€
14399	OE: 129943	12	6	1,90€
14402	OE: 856548	8	8	1,50€
14404	OE: 71728806	8	8	2,10€
14405	OE: 968865987703	16	8	1,45€
14406	OE: 856540	10	10	1,55€
14408	OE: 856534	10	10	1,45€
14409	OE: 357853586	8	8	1,35€

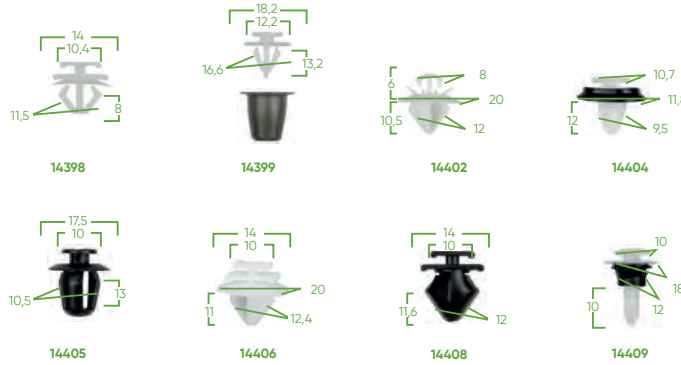

53713

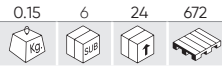

16,00€



KIT DE 93 CLIPS POUR PANNEAUX DE PORTE PEUGEOT/CITROËN

REF.	DESCRIPTION			€
14350	OE: 6991Y8	6	6	1,80€
14358	OE: PG 6991Y8 CT 6991Y8 FIAT 9654280780 RENAULT 703077469	10	10	1,70€
14387	-	8	8	1,45€
14388	OE: 7703077250	8	8	2,05€
14389	OE: 6995A3	6	6	1,25€
14390	-	6	6	1,35€
14391	-	15	15	2,15€
14392	-	6	6	1,35€
14393	-	8	8	1,50€
14395	-	8	8	1,65€
14396	-	6	6	1,20€
14397	-	6	6	1,45€

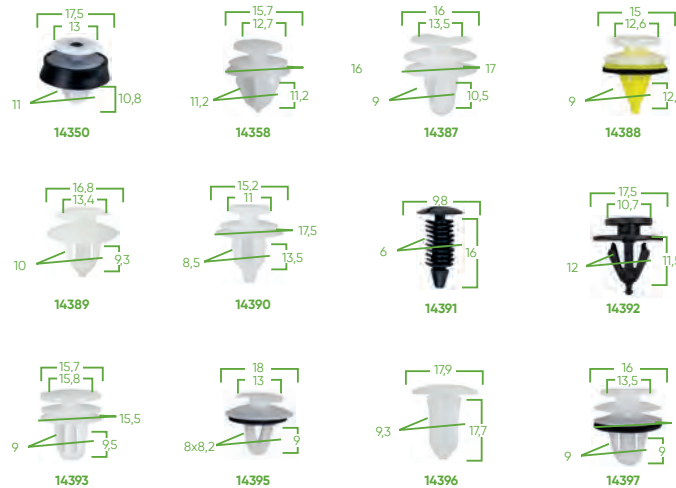

53712

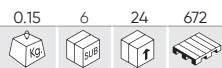

16,00€



ÉTUI DE 109 CLIPS POUR TAPISSERIE RENAULT DACIA

REF.	DESCRIPTION			€
14374	OE: 7703077435	3	3	1,70€
14375	-	15	15	1,85€
14376	OE: 7L6868307	20	20	2,60€
14377	-	10	10	1,90€
14378	OE: 7703077117	12	12	1,90€
14379	-	6	6	1,45€
14381	-	10	10	1,70€
14382	OE: 7703077153	6	6	1,85€
14383	OE: 7703072360	10	10	1,35€
14384	OE: W705956S300	12	12	2,10€
14416	OE: 6992C6	5	5	1,25€



53711

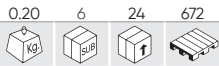

16,00€



ÉTUI DE 90 CLIPS POUR MOLDINGS RENAULT DACIA

REF.	DESCRIPTION		€
14356	OE: RENAULT 7703077368 OPEL 4430858	10 10	1,90€
14358	OE: PG 6991Y8 CT 6991Y8 FIAT 9654280780 RENAULT 703077469	12 10	1,70€
14364	OE: OP 7701470779 NI 7703077421 RENUALT 7703077421 IV 500326896	10 10	1,90€
14365	OE: OP 7701470779 NI 7703077421 RENUALT 7703077421 IV 500326896	10 10	1,90€
14366	OE: PG 6991Y8 CT 6991Y8 FIAT 9654280780 RENAULT 703077469	8 8	1,45€
14367	-	3 3	1,30€
14368	OE: 7L5853994	8 8	1,45€
14369	OE: 7701061797	15 15	4,95€
14370	-	3 3	3,00€
14371	-	3 3	3,00€
14372	-	4 4	1,20€
14373	-	4 4	1,35€



53710

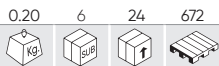

16,00€



ÉTUI DE 85 CLIPS POUR PANNEAUX DE PORTE RENAULT DACIA

REF.	DESCRIPTION		€
14350	OE: 6991Y8	12 6	1,80€
14351	-	8 15	1,65€
14352	OE: 51447780135	7 7	1,30€
14353	OE: 7703077476	8 2	2,10€
14355	OE: 7703077354	8 8	1,70€
14356	OE: RENAULT 703077368 OPEL 4430858	10 4	1,90€
14357	OE: 7703077430	10 12	1,90€
14358	OE: PG 6991Y8 CT 6991Y8 FIAT 9654280780 RENAULT 703077469	10 6	1,70€
14359	OE: 51418224768	4 3	1,05€
14361	-	8 15	1,70€

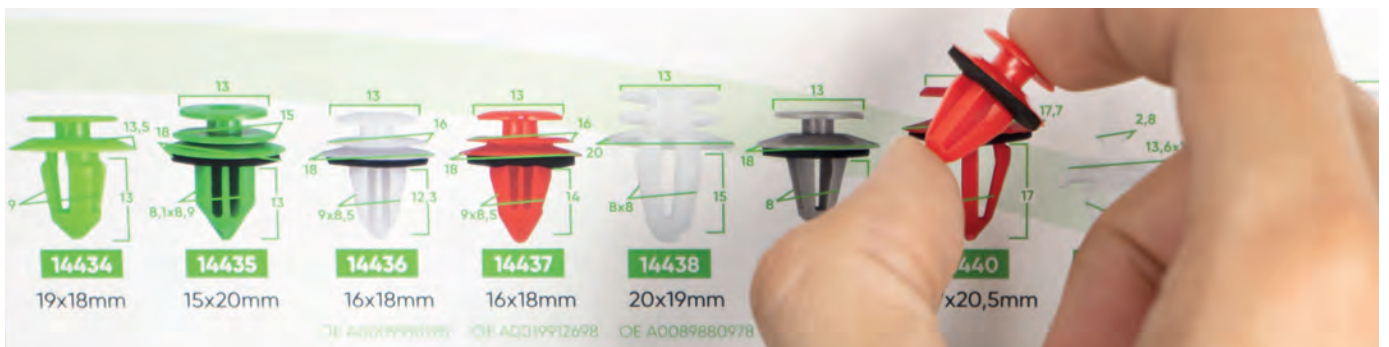
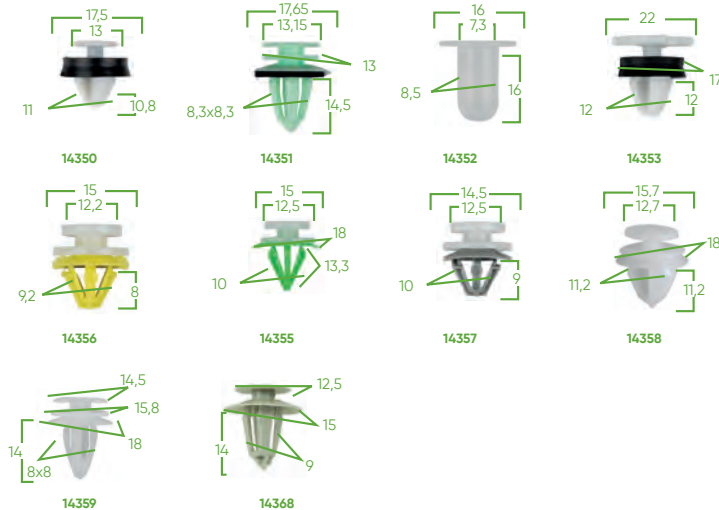

VÊTEMENTS DE TRAVAIL

406 GILETS

406 VESTES

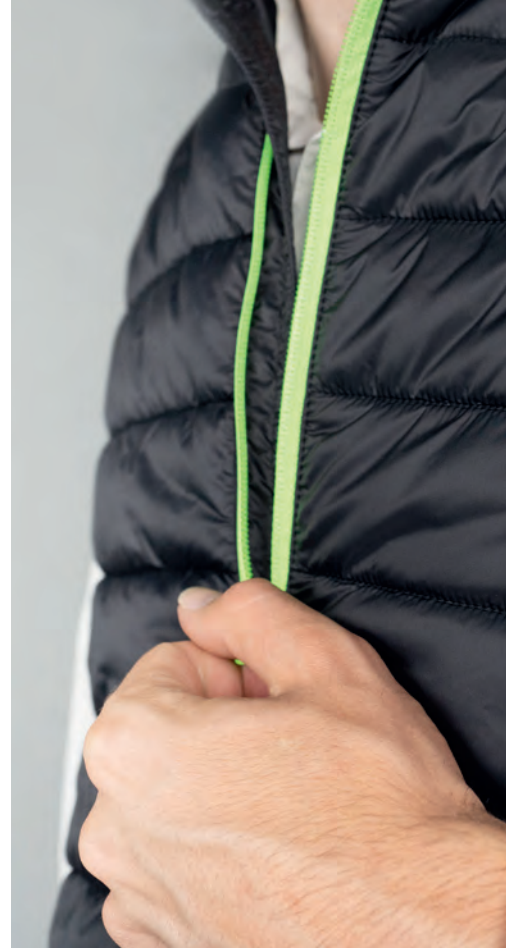



GILET JBM



70001
70002
70003



70013
70014
70015
70016
70017



70009

REF.		■	■	■	📦	📦	📦	🚚	€
70001	M	●			0.30	-	5	200	35,00€
70002	L	●			0.40	-	5	200	35,00€
70003	XL	●			0.40	-	5	200	35,00€
70009	XL		●		0.40	-	5	180	35,00€
70013	S		●		0.30	-	10	240	44,00€
70014	M		●		0.30	-	10	240	44,00€
70015	L		●		0.30	-	10	240	44,00€
70016	XL		●		0.35	-	10	240	44,00€
70017	XXL		●		0.35	-	10	200	44,00€

BLOUSON JBM

70004
70005
70006



70011
70012

REF.		■	■	📦	📦	📦	🚚	€	
70004	M	●			0.60	-	5	140	42,00€
70005	L	●			0.70	-	5	140	42,00€
70006	XL	●			0.70	-	5	140	42,00€
70011	L		●		0.60	-	5	120	42,00€
70012	XL		●		0.70	-	5	120	42,00€

13929

3,45€



CINTRE CLOTHE 49CM



METEXP

62,00€



PRESENTOIR



PROMOTIONNEL

408 PRODUITS PROMOTIONNELS

410 PRÉSENTOIRS / ACCESSOIRES

412 EMBALLAG



PROMOTIONNEL

53956

353,00€

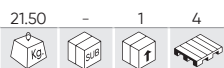

CHAISE ROTATIVE

DIMENSIONS: 70x55x126-136cm

HAUTEUR RÉGLABLE

COUSSIN LOMBAIRE

COUSSIN D'APPUI-TÊTE



Matériau: PU
Épaisseur du cadre en acier: 1,2cm
Assise: Mousse moulée
Dossier: Mousse de polyuréthane
Accoudoir: 2D
Ascenseur à gaz: Classe 3
Base en nylon: 350mm



PIECES DE RECHANGE

54043

48,00€

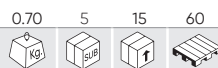

SAC À DOS JBM

Espace de rangement et poches : Grâce à ses deux compartiments, elle permet de ranger, entre autres, des ordinateurs portables jusqu'à 17,3 pouces et des tablettes.

Matériau: Polyuréthane; sac à dos étanche, durable et fiable.

Léger et confortable : une conception confortable et respirant du dos et des sangles en matériau en éponge.



53973

284,00€



TENTE PLIANTE JBM 3X3M

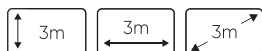

REF.	DESCRIPTION	Icon	Icon	Icon	Icon	€
14347	ÉTUI DE PROTECTION POUR STAND JBM	0.60	-	5	-	36,50€

15152

160,00€



PAROI POUR TENTE COULISSANTE REF. 53973

Il se compose de deux parties :
- Partie latérale qui couvre 3/4 parties de la tente.
- Partie avant qui couvre 1/4 de la tente. Avec fermeture éclair verticale en guise de porte.



54325 22,50€

2.30 - 10 120

N

TAPIS DE PORTE 100X65CM



54278 4,50€

0.10 5 200 1800

N

CASQUETTE JBM



54480 1,00€

0.00 500 2000 40000

N

PORTE-CLÉS JBM



53949 4,50€

0.10 - 15 540

POCHE JBM RÉFRIGÉRATEUR NOIR



53950 4,50€

0.10 - 15 630

POCHE RÉFRIGÉRATEUR JBM VERT



13968 1,35€

0.01 50 200 2400

SAC JBM



53533 1,50€

0.01 50 1000 12000

4 COULEURS PEN PROMOTIONNEL JBM



54076 9,00€

0.50 - 50 700

TASSE JBM



340ml



PROMOTIONNEL

53504

38,00€



SCOOTER



14975

64,00€

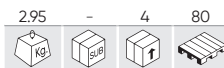

SUPPORT À JAMBON



CROCHETS

REF. POUR	Icon 1	Icon 2	Icon 3	Icon 4	€
14034 Outils PNEUMATIQUES	0.20	20	80	1920	9,00€
14623 REF. 60046, 60044, 60048, 60005, 60006	0.10	-	10	800	8,00€
14626 REF. 60023	0.10	-	10	-	7,00€
11318 CROCHET À UNE POINTE	0.04	20	600	-	2,50€
16364 CROCHET À UNE POINTE 280MM	0.20	-	200	-	3,50€
51315 CROCHET À POINTE FERMÉE	0.02	20	320	44800	2,50€

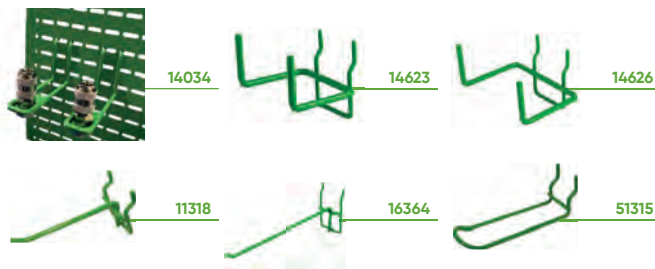

PLATEAU

REF. POUR	Icon 1	Icon 2	Icon 3	Icon 4	€
14622 REF. 60001, 60003, 60004, 60020	0.95	-	10	360	17,00€
14624 REF. 60007, 60010, 60011	0.65	-	10	300	17,00€
14625 REF. 60028, 60009	0.50	-	10	700	14,00€



53492

380,00€



PRÉSENTOIR POUR OUTILS PNEUMATIQUES



LIVRE SANS OUTIL



METEXP

62,00€

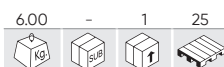

PRESENTOIR



REF.	DESCRIPTION	Icon 1	Icon 2	Icon 3	Icon 4	€
13929	CINTRE CLOTHE 49CM	0.10	-	-	280	3,45€



53877 430,50€

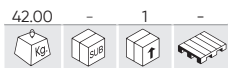

PRÉSENTOIR D'OUTILLAGES

53878 574,00€

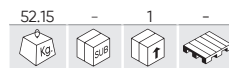

PRÉSENTOIR D'OUTILLAGES +
PORTE-AFFICHAGE D'OUTIL
AVEC ILLUMINATION

53879 838,50€

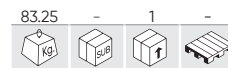

PRÉSENTOIR D'OUTILLAGES
+ PORTE-AFFICHAGE AVEC
ILLUMINATION ET PORTE



CONTIENT

14945	x1
14346	x1
14380	x1
11318	x20

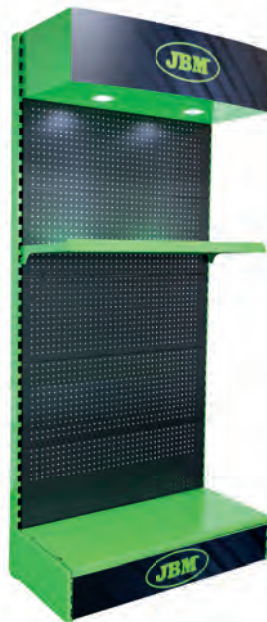

CONTIENT

14945	x1
14947	x1
14380	x1
11318	x20



CONTIENT

14945	x1
14947	x1
14948	x1
14996	x1
11318	x20



PIÈCES DÉTACHÉE AFFICHAGE D'OUTILS

REF.	DESCRIPTION					€
14945	AFFICHAGE D'OUTILS - BASE	37.80	-	1	15	303,50€
14946	TÊTE POUR PRÉSENTOIR D'OUTILS	3.40	-	1	51	58,00€
14947	PORTE-AFFICHAGE D'OUTILS ALLÉGÉ	8.55	-	1	6	201,50€
14948	JEU DE 2 PORTES POUR PORTE-OUTILS	31.10	-	1	40	251,50€
14380	PLATEAU DE PORTE-AFFICHAGE D'OUTILS 53877	5.00	-	1	34	51,00€
14996	PLATEAU DE PORTE-AFFICHAGE D'OUTILS AVEC PORTE	5.00	-	1	33	65,00€

14945



14946



14947



14948



14380



14996



53914

75,00€

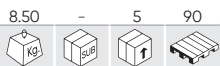

PÔLE DE SÉPARATION AVEC BANDE RÉTRACTABLE

- Matériel: acier
- Diamètre du tube: 63 mm
- Diamètre de la base: 320 mm
- Hauteur: 910 mm
- Sortie ruban dans 4 directions
- Longueur du ruban: 3 m
- Largeur de ceinture: 48 mm



14807

11,00€

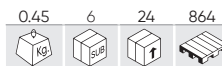

ADHÉSIF DE GARANTIE JBM



TOUTES LES LANGUES DANS LE MÊME ADHÉSIF

- 75mm large x 125m long
- Fabriqué en polypropylène
- Adhésif solvant
- Epaisseur: 28 microns

BOÎTE EN CARTON JBM

BOÎTE À OUTILS À MAINS DE RECHANGE

REF. DESCRIPTION				€
14922 BOÎTE POUR PIÈCES DES OUTILS MANUELS 14,5X9X10CM	0.10	100	-	0,84€
14923 BOÎTE À OUTILS À MAINS DE RECHANGE 17,5 X 9 X 7 CM	0.10	100	-	0,84€
14924 BOÎTE POUR PIÈCES DES OUTILS MANUELS 24X11X7CM	0.10	100	-	0,84€
14925 BOÎTE POUR PIÈCES DES OUTILS MANUELS 31,5X13X4CM	0.10	100	-	0,84€
14926 BOÎTE POUR PIÈCES DES OUTILS MANUELS 32X8,5X7CM	0.10	100	-	1,05€



BOÎTE PROMOTIONNELLE

REF. DESCRIPTION				€
13717 BOÎTE À JAMBON JBM 76X14X29CM	0.90	1	200	7,65€
14083 CARTON VERT PROMO JBM 80X28X49CM	1.80	1	100	13,20€
14976 BOÎTE EN CARTON, PUBLICITAIRE, 80X31X61 CM	2.20	1	80	18,84€
15056 BOÎTE EN CARTON, PUBLICITAIRE, 40X30X61 CM	1.60	1	70	11,70€









BOÎTE JBM

REF. DESCRIPTION				€
11330 PETIT CARTON JBM 19X10X11CM (SOUFFLET)	0.05	50	4200	0,57€
12950 CARTON JBM 60X40X30CM	0.80	15	75	3,45€
12952 CARTON JBM 40X30X20CM	0.40	20	240	1,92€
13217 CARTON 57X30X25CM (KITS D'URGENCE)	0.55	15	150	1,31€
14974 CARTON JBM 54X24X40CM (20 KITS DE SOUFFLETS)	0.65	20	240	2,28€
15051 BOÎTE EN CARTON 40X32X30 CM	0.40	20	160	1,92€
14189 CAISSE PALETTE AMERICAINE TRIPLE CANAL	10.00	1	40	52,00€
14507 PALETTE BOX EUROPÉENNE	8.00	1	40	50,00€



















LÉGENDES











LOGISTIQUE

 POIDS EN KILOGRAMMES	 QUANTITÉ POUR LA BOÎTE INTÉRIEURE	 QUANTITÉ PAR BOÎTE	 QUANTITÉ PAR PALETTES
 QUANTITÉ PAR SAC	 QUANTITÉ PAR SET	 PRÉSENTATION DANS UN ÉCRAN	

GÉNÉRALITÉS

 NOMBRE DE PIÈCES	 PRÉSENTATION SOUS BLISTER	 MAGNÉTIQUE	 TACTILE
 CAPACITÉ DE CHARGE DE LA BATTERIE	 DURÉE DE CHARGE	 POIGNÉE ERGONOMIQUE	 NE PEUT PAS ÊTRE NETTOYÉ
 LE PROTÉGER CONTRE LA PLUIE ET L'HUMIDITÉ	 PRODUIT RECYCLABLE	 INFORMATIONS	 SANS FIL
 VOITURE ÉLECTRIQUE	 PANNEAUX HAUTE TENSION	 RÉGLEMENTATION EUROPÉENNE	 RÉGLEMENTATION AMÉRICAINE
 UNIVERSAL	RÉGLEMENTATION UNIVERSELLE		



















UNITÉS DE MESURE

 LONGUEUR	 MASSE	 DIAMÈTRE	 AUTRES
 CAPACITÉ	 POUCES	 MAXIMUM - MINIMUM	 DEGRÉS
 ZONE	 DEGRÉS CELSIUS	 SON	

UNITÉS DE MESURE POUR DES ÉLÉMENTS SPÉCIFIQUES

 DIAMÈTRE DU DISQUE	 DIAMÈTRE DU TROU DU DISQUE EN "	 DIAMÈTRE DU TUBE	 DIAMÈTRE INTÉRIEUR ET EXTÉRIEUR DU TUBE
 LONGUEUR DU TUYAU	 LONGUEUR DE LA PRISE DE COURANT		

MATÉRIEL

 BOIS	 ACIER	 S2 ACIER	 ALUMINIUM
 CUIVRE	 CHROMÉ	 CHROME VANADIUM	 CHROME MOLYBDENUM
 NÉODYME	 ZINC	 POLYCHLORURE DE VINYLE	 POLYPROPYLÈNE
 POLYÉTHYLÈNE	 POLYÉTHYLÈNE HAUTE DENSITÉ	 ACIER LAMINÉ	 LAITON
 LATEX	 NYLON	 CAOUTCHOUC DE NITRILE-BUTADIÈNE HYDROGÉNÉ	





















VOUS POUVEZ AUSSI TROUVER

 MAÇONNERIE	 BOIS	 ACIER
---	--	---













SPÉCIFICATIONS TECHNIQUES

OUTILS MANUELS

EMBOUTS

 EMBOUTS PLATS	 EMBOUTS PHILIPS	 EMBOUTS POZIDRIV	 EMBOUTS TORQ
 EMBOUTS RIBE	 EMBOUTS FOUR-TIP	 EMBOUTS THREE-TIP	 EMBOUTS ALLEN
 EMBOUTS TORX	 EMBOUTS À 12 POINTS	 EMBOUTS CARRÉE	 EMBOUTS À CINQ POINTS TORX
 POINT DE SPLINE	 EMBOUTS BUTTERFLY	 EMBOUTS TAMPER-PROOF ALLEN	 EMBOUTS TAMPER-PROOF TORX
 EMBOUTS TAMPER-PROOF À 12 POINTS	 EMBOUTS TAMPER-PROOF CARRÉE	 EMBOUTS À CINQ POINTS TAMPER-PROOF	 POINT DE SPLINE INVOLONTABLE
 EMBOUTS TENSOR			

PRISES

 PRISE HEXAGONALE	 PRISE TORX	 PRISE À 12 POINTS	 PRISE CARRÉE
 PRISE À 5 POINTS	 PRISE SPLINE	 PRISE HEXAGONALE TAMPER-PROOF	 PRISE TAMPER-PROOF TORX
 PRISE À 12 POINTS TAMPER-PROOF	 PRISE TAMPER-PROOF CARRÉE	 PRISE TAMPER-PROOF À CINQ POINTS	 PRISE TAMPER-PROOF SPLINE









CLÉS

 CLÉ HEXAGONALE	 CLÉ TORX	 CLÉ DOUZE ARÊTES	 CLÉ CARRÉE
 CLÉ À CINQ POINTS			



















CLIQUET

 24 DENTS	 72 DENTS	 90 DENTS
--	--	--

OUTILS ÉLECTRIQUES

 WATS	 VATIUMS	 HERTZ	 KILOVATIUM
 AMPÈRES	 COURANT ALTERNATIF	 COURANT DIRECT	 RÉSISTANCE ÉLECTRIQUE
 BATTERIE AU LITHIUM-ION	 MICROUSB USB	 PRISE PLUS LÉGÈRE	

OUTILS PNEUMATIQUES

 LIVRES POUR UN POUCE CARRÉ (PRESSION)	 UNITÉS DE MESURE	 PIEDS CUBES PAR MINUTE (DÉBIT)	 HP (PUISSANCE)
 TOURS PAR MINUTE EN GÉNÉRAL	 TOURS INVERSÉS PAR MINUTE	 TOURS PAR MINUTE EN MARCHE AVANT	 MAXIMUM DE NEWTONS PAR MÈTRE
 MAXIMUM DE NEWTONS PAR MÈTRE	 IMPULSIONS PAR MINUTE	 KILOPASCAL	 MEGAPASCAL
 VOLUME D'AIR ÉLEVÉ ET FAIBLE PRESSION	 RETOUR SORTIE	 RACCORDABLE AU TUYAU	 ENTRÉE D'AIR
 CAPACITÉ DE VITESSE	 SYSTÈME À MARTEAUX JUMBO	 MÉCANISME À DOUBLE MARTEAU	

INDEX NUMÉRIQUE

REF.	PAGE	PRIX
10000	305	7,00 €
10054	232	2,90 €
10055	232	3,90 €
10264	53	2,00 €
10485	231	8,10 €
10486	231	8,00 €
10494	231	6,50 €
10495	231	3,00 €
10496	231	3,00 €
10497	231	3,00 €
10498	231	3,00 €
10499	231	3,00 €
10500	231	3,00 €
10501	231	8,10 €
10502	231	3,50 €
10526	57	10,00 €
10531	41	3,00 €
10532	41	2,70 €
10533	41	3,00 €
10534	41	3,25 €
10535	41	3,50 €
10536	41	3,65 €
10537	41	3,90 €
10538	41	4,30 €
10539	41	4,75 €
10540	41	5,25 €
10541	41	5,55 €
10542	41	5,85 €
10543	41	7,00 €
10544	41	8,10 €
10545	41	9,75 €
10546	41	11,60 €
10547	41	13,50 €
10548	41	1,75 €
10549	41	2,00 €
10550	41	2,15 €
10551	41	2,15 €
10552	38	7,10 €
10553	38	7,35 €
10554	38	7,50 €
10555	38	7,80 €
10556	38	8,10 €
10557	38	8,10 €
10558	38	9,35 €
10559	38	9,50 €
10560	38	10,60 €
10561	38	11,00 €
10562	38	12,30 €
10563	38	12,50 €
10564	42	2,50 €
10565	42	3,50 €
10566	42	3,50 €
10567	42	3,50 €

REF.	PAGE	PRIX
10568	42	4,00 €
10569	42	4,50 €
10570	42	4,50 €
10571	42	5,00 €
10579	42	3,00 €
10580	42	3,10 €
10581	42	3,40 €
10582	42	4,00 €
10583	42	4,15 €
10584	42	5,05 €
10585	42	6,75 €
10586	42	7,60 €
10587	42	9,80 €
10588	42	10,50 €
10589	42	2,00 €
10590	42	2,40 €
10591	44	2,50 €
10592	44	2,55 €
10593	44	3,15 €
10594	44	3,20 €
10595	44	3,35 €
10596	44	4,25 €
10597	44	4,50 €
10598	44	4,60 €
10599	44	6,00 €
10600	44	6,25 €
10601	44	6,50 €
10602	44	7,05 €
10603	44	2,10 €
10604	44	2,25 €
10617	46	14,10 €
10618	46	15,10 €
10619	46	15,70 €
10620	46	16,20 €
10621	46	9,50 €
10622	46	10,00 €
10623	46	12,60 €
10624	46	13,50 €
10625	46	15,70 €
10626	46	17,80 €
10627	44	2,80 €
10628	44	3,10 €
10629	44	3,65 €
10630	44	3,90 €
10631	44	4,20 €
10632	44	5,30 €
10633	44	6,60 €
10634	44	7,80 €
10635	44	8,15 €
10636	44	8,80 €
10637	44	12,10 €
10638	44	12,70 €
10642	57	10,00 €

REF.	PAGE	PRIX
10643	57	10,00 €
10644	57	10,00 €
10672	242	9,50 €
10673	242	9,50 €
10674	242	9,50 €
10675	242	9,50 €
10732	89	18,70 €
10735	89	20,30 €
10750	139	13,00 €
10751	139	15,00 €
10766	139, 357	1,59 €
10772	386	0,05 €
10773	386	0,10 €
10774	386	0,10 €
10775	386	0,15 €
10776	386	0,20 €
10777	386	0,20 €
10778	386	0,35 €
10779	385, 386	0,05 €
10780	385, 386	0,05 €
10781	385, 386	0,05 €
10782	386	0,05 €
10783	386	0,05 €
10784	385, 386	0,05 €
10785	385, 386	0,10 €
10786	385, 386	0,15 €
10787	386	0,05 €
10788	386	0,05 €
10789	386	0,05 €
10790	386	0,05 €
10791	386	0,05 €
10792	386	0,05 €
10793	382	0,25 €
10794	382	0,40 €
10795	382	0,60 €
10796	382	0,07 €
10797	382	0,09 €
10798	382	0,12 €
10799	382	0,13 €
10800	382	0,15 €
10801	382	0,17 €
10802	382	0,19 €
10803	382	0,05 €
10804	382	0,22 €
10805	385	0,10 €
10812	385	0,30 €
10813	385	0,30 €
10823	388	0,20 €
10824	388	0,20 €
10825	388	0,20 €
10826	388	0,40 €
10827	388	0,60 €
10828	388	0,45 €

REF.	PAGE	PRIX
10829	388	0,20 €
10830	388	0,20 €
10831	388	0,20 €
10832	388	0,20 €
10833	388	0,20 €
10834	388	0,25 €
10835	388	0,25 €
10836	388	0,30 €
10837	388	0,30 €
10838	388	0,30 €
10839	388	0,40 €
10840	388	0,35 €
10868	390	0,30 €
10869	390	0,30 €
10870	390	0,45 €
10871	390	0,30 €
10872	390	0,40 €
10873	390	0,45 €
10874	390	0,30 €
10875	390	0,40 €
10876	390	0,45 €
10877	384	0,25 €
10878	384	0,30 €
10879	384	0,20 €
10880	384	0,20 €
10881	384	0,25 €
10882	382	0,25 €
10883	382	0,25 €
10884	382	0,25 €
10885	394	0,20 €
10886	394	0,20 €
10887	394	0,25 €
10888	394	0,30 €
10889	394	0,30 €
10890	394	0,35 €
10891	394	0,25 €
10892	394	0,30 €
10893	394	0,25 €
10894	394	0,20 €
10895	394	0,20 €
10896	394	0,30 €
10897	394	0,30 €
10898	394	0,30 €
10899	394	0,30 €
10900	394	0,30 €
10901	394	0,25 €
10902	394	0,30 €
10905	394	0,25 €
10906	394	0,25 €
10907	394	0,25 €
10908	394	0,30 €
10909	394	0,30 €
10910	394	0,30 €

REF.	PAGE	PRIX
10911	394	0,30 €
10912	394	0,25 €
10913	394	0,30 €
10914	394	0,25 €
10915	393, 394	0,25 €
10916	394	0,30 €
10917	393, 394	0,30 €
10918	393, 394	0,30 €
10919	393, 394	0,30 €
10920	393, 394	0,25 €
10921	393, 394	0,30 €
10923	134	1,10 €
10953	229	12,50 €
10955	200	11,00 €
10961	144	13,00 €
10964	190, 350	9,00 €
10965	190, 350	6,00 €
10966	190, 350	13,50 €
11103	139	6,00 €
11106	202	3,00 €
11107	144	4,50 €
11121	168, 169, 176	4,10 €
11122	168, 169, 176	5,45 €
11123	168, 176	6,50 €
11124	176	7,65 €
11125	176	8,50 €
11126	176	11,20 €
11127	176	13,80 €
11128	176	14,10 €
11129	176	14,10 €
11130	176	13,10 €
11131	176	14,10 €
11132	176	13,70 €
11133	176	12,00 €
11134	176	15,00 €
11135	176	17,20 €
11136	176	15,30 €
11137	176	18,20 €
11138	176	18,00 €
11139	176	18,80 €
11140	176	20,40 €
11141	176	18,60 €
11142	176	21,30 €
11143	176	26,40 €
11144	176	33,30 €
11145	176	35,30 €
11146	176	37,30 €
11147	176	41,00 €
11148	176	47,00 €
11149	176	45,00 €
11150	176	55,00 €
11151	176	57,00 €
11152	176	57,00 €
11153	172, 176	23,40 €
11154	176	21,70 €
11155	172, 176	24,40 €

REF.	PAGE	PRIX
11156	176	28,90 €
11157	176	26,60 €
11158	172, 176	28,50 €
11159	176	30,30 €
11160	176	27,00 €
11161	176	32,30 €
11162	176	29,10 €
11163	176	32,70 €
11164	176	30,70 €
11165	176	34,60 €
11166	176	30,90 €
11167	176	38,00 €
11168	176	41,00 €
11169	176	39,20 €
11170	176	40,00 €
11171	176	51,00 €
11172	176	48,00 €
11173	176	47,00 €
11174	176	47,00 €
11175	176	49,00 €
11176	176	56,00 €
11177	176	55,00 €
11178	176	53,00 €
11179	176	65,00 €
11180	176	59,00 €
11181	176	65,00 €
11182	176	73,00 €
11183	176	70,00 €
11184	176	87,00 €
11185	176	97,00 €
11186	176	91,00 €
11187	176	98,00 €
11188	176	103,00 €
11189	176	121,00 €
11190	176	138,00 €
11191	176	149,00 €
11192	176	152,00 €
11193	176	183,00 €
11194	176	176,00 €
11195	168, 169, 176	3,70 €
11212	63	5,00 €
11213	63	10,60 €
11214	63	12,50 €
11244	45	8,50 €
11245	45	9,15 €
11246	45	12,40 €
11247	45	14,00 €
11248	45	14,60 €
11249	45	26,50 €
11258	43	7,30 €
11259	43	8,30 €
11260	43	9,75 €
11261	43	11,35 €
11262	43	13,50 €
11314	173	8,50 €
11315	173	8,50 €
11316	173	8,50 €

REF.	PAGE	PRIX
11318	410	2,50 €
11324	139	17,50 €
11325	139	17,50 €
11328	355	4,00 €
11330	412	0,57 €
11360	32	2,60 €
11361	32	3,20 €
11362	32	5,20 €
11363	32	3,90 €
11364	32	4,50 €
11365	32	9,40 €
11374	200	5,50 €
11375	200	6,50 €
11376	200	5,50 €
11377	200	5,50 €
11378	200	6,50 €
11379	200	6,00 €
11380	200	6,50 €
11381	200	6,50 €
11382	200	6,00 €
11383	200	6,00 €
11384	200	6,00 €
11385	200	5,50 €
11386	200	6,00 €
11387	200	6,00 €
11388	200	6,00 €
11389	200	6,00 €
11390	200	6,00 €
11391	200	6,50 €
11392	200	6,00 €
11393	200	6,00 €
11394	200	6,00 €
11434	226	12,00 €
11435	226	12,00 €
11436	226	12,00 €
11437	226	12,00 €
11438	226	12,00 €
11439	226	12,00 €
11440	226	12,00 €
11441	226	12,00 €
11442	226	12,00 €
11443	227	14,00 €
11444	227	14,00 €
11445	227	15,00 €
11446	227	15,00 €
11447	227	15,50 €
11450	226	12,00 €
11541	180	11,00 €
11542	180	11,00 €
11543	180	11,00 €
11544	180	7,00 €
11545	180	11,00 €
11546	180	12,00 €
11547	180	12,00 €
11613	176	11,00 €
11614	176	13,00 €
11615	176	14,20 €

REF.	PAGE	PRIX
11616	176	18,10 €
11617	176	18,70 €
11618	176	18,80 €
11619	176	19,50 €
11621	176	290,00 €
11622	176	399,00 €
11623	176	489,00 €
11624	176	189,00 €
11625	176	282,00 €
11628	173	9,50 €
11639	43	4,00 €
11640	43	4,50 €
11641	43	5,00 €
11642	43	5,00 €
11643	43	6,00 €
11644	43	7,00 €
11645	43	7,00 €
11646	43	9,45 €
11867	308	9,00 €
11878	214	4,10 €
11879	214	5,10 €
11880	214	10,50 €
11890	359	0,55 €
11891	359	0,50 €
11893	211	7,00 €
11894	211	7,00 €
11895	211	8,65 €
11896	211	8,80 €
11897	190, 351	155,00 €
11900	370	3,50 €
11901	370	2,50 €
11902	370	3,50 €
11903	370	5,00 €
11904	370	2,00 €
11905	370	1,50 €
11906	370	8,50 €
11907	370	11,00 €
11936	202	4,00 €
11937	202	5,00 €
11938	174	47,00 €
11945	53	7,00 €
11946	53	4,50 €
11947	53	19,00 €
11956	152	5,50 €
11957	152	5,50 €
11959	189	10,50 €
11960	369, 370	1,50 €
11962	32, 168, 169, 175	7,50 €
11963	175	9,00 €
11964	32, 175	12,50 €
11965	175	16,00 €
11966	175	18,00 €
11967	175	18,00 €
11971	99	3,60 €
11974	339	1,80 €
11975	339	1,80 €
11976	339	1,80 €

REF.	PAGE	PRIX
11977	339	1,80 €
11978	339	1,80 €
11979	339	1,80 €
11980	339	1,80 €
11981	339	1,80 €
11982	339	1,80 €
11983	339	1,80 €
11989	144	2,00 €
11990	168, 169, 174	15,30 €
11994	89	33,00 €
11996	88	48,00 €
11997	88	39,00 €
11998	88	49,00 €
12009	162	11,00 €
12022	188	33,70 €
12029	35	5,50 €
12030	35	6,50 €
12044	305	147,00 €
12055	351	20,00 €
12060	64	2,50 €
12061	169, 170, 176	9,50 €
12062	169, 170, 176	9,50 €
12063	169, 170, 176	9,50 €
12064	169, 176	9,00 €
12065	169, 170, 176	9,00 €
12066	169, 170, 172, 176	9,00 €
12067	169, 176	9,50 €
12068	169, 170, 172, 176	9,50 €
12069	169, 170, 172, 176	9,50 €
12070	169, 170, 176	10,50 €
12071	169, 170, 176	11,00 €
12072	169, 176	12,00 €
12074	169, 174	11,50 €
12075	168, 169, 174	15,50 €
12093	226	12,00 €
12200	219	14,50 €
12901	207	5,20 €
12926	241	21,50 €
12927	241	21,50 €
12928	241	22,00 €
12929	241	23,00 €
12930	241	23,50 €
12931	171	7,50 €
12932	171	7,50 €
12933	171	8,00 €
12934	171	7,50 €
12935	171	8,00 €
12936	171	8,50 €
12937	168, 169, 174	9,50 €
12938	171	10,00 €
12939	171	10,00 €
12940	171	10,00 €
12941	171	10,00 €

REF.	PAGE	PRIX
12942	171	10,00 €
12943	171	10,00 €
12944	171	10,00 €
12945	171	10,50 €
12950	412	3,45 €
12952	412	1,92 €
12954	394	0,25 €
12955	180	27,80 €
12956	180	27,80 €
12957	180	27,80 €
12958	180	27,80 €
12959	180	27,80 €
12960	180	27,80 €
12961	180	27,80 €
12973	370	1,00 €
12974	196	21,00 €
12975	196	23,00 €
12977	221	36,50 €
12984	176	379,00 €
12987	152	1,50 €
12988	166	12,00 €
12995	53	7,00 €
12996	53	7,00 €
12997	53	7,50 €
12998	53	9,00 €
12999	53	9,50 €
13002	396	1,45 €
13003	396	1,70 €
13004	396	1,85 €
13005	396	1,25 €
13006	396	1,40 €
13007	396	1,30 €
13008	396	2,25 €
13009	396	1,65 €
13010	396	1,75 €
13011	396	1,15 €
13012	396	1,80 €
13013	396	1,75 €
13014	396	1,45 €
13015	396	1,20 €
13016	396	1,15 €
13017	396	2,60 €
13018	396	1,45 €
13019	396	1,75 €
13020	396	1,70 €
13021	396	1,30 €
13022	396	2,10 €
13023	396	1,50 €
13024	396	2,45 €
13025	396	1,50 €
13026	400	1,55 €
13027	400	1,85 €
13028	400	1,45 €
13029	400	1,65 €
13030	400	2,80 €
13031	400	1,85 €
13032	400	2,00 €

REF.	PAGE	PRIX
13033	400	1,60 €
13034	400	2,65 €
13035	400	1,65 €
13036	400	1,40 €
13037	400	2,10 €
13038	398	1,40 €
13039	398	1,65 €
13040	398	1,80 €
13041	398	1,55 €
13042	398	1,95 €
13043	398	1,20 €
13044	398	1,55 €
13045	398	1,20 €
13046	398	1,55 €
13047	398	1,45 €
13048	398	2,20 €
13049	398	2,05 €
13050	399	1,55 €
13051	399	1,50 €
13052	399	1,25 €
13053	399	2,80 €
13054	399	2,35 €
13055	399	3,00 €
13056	398	1,55 €
13057	398	1,50 €
13058	398	2,20 €
13059	398	2,35 €
13060	398	1,60 €
13061	398	2,65 €
13062	398	2,35 €
13063	398	1,15 €
13064	398	2,60 €
13065	398	2,00 €
13066	398	2,25 €
13067	398	2,55 €
13068	399	2,85 €
13069	399	4,55 €
13070	399	2,15 €
13071	399	2,05 €
13072	399	2,75 €
13073	399	2,10 €
13074	400	4,65 €
13075	400	5,35 €
13076	400	3,90 €
13077	400	2,55 €
13078	400	2,55 €
13079	400	3,35 €
13080	398	1,75 €
13081	398	2,30 €
13082	398	1,35 €
13083	398	1,50 €
13084	398	2,10 €
13085	398	1,60 €
13086	398	1,25 €
13087	398	3,30 €
13088	398	2,40 €
13089	398	1,70 €

REF.	PAGE	PRIX
13090	398	1,70 €
13091	398	1,25 €
13092	400	1,65 €
13093	400	2,95 €
13094	400	1,50 €
13095	400	1,20 €
13096	400	1,70 €
13097	400	1,20 €
13098	400	1,65 €
13099	400	2,75 €
13100	400	1,20 €
13101	400	1,50 €
13102	400	1,60 €
13103	400	1,80 €
13104	396	1,90 €
13105	396	2,50 €
13106	396	2,00 €
13107	396	2,15 €
13108	396	1,90 €
13109	396	2,90 €
13110	396	1,85 €
13111	396	1,20 €
13112	396	1,65 €
13113	396	2,20 €
13114	396	2,20 €
13115	396	2,50 €
13116	399	5,45 €
13117	399	3,65 €
13118	399	15,90 €
13119	399	5,60 €
13120	399	5,50 €
13121	399	8,75 €
13122	399	1,95 €
13123	399	5,35 €
13124	399	8,20 €
13125	399	5,95 €
13126	399	1,55 €
13127	399	5,60 €
13128	397	1,85 €
13129	397	2,00 €
13130	397	3,75 €
13131	397	3,45 €
13132	397	2,65 €
13133	397	3,45 €
13134	397	3,95 €
13135	397	3,45 €
13136	397	2,60 €
13137	397	2,25 €
13138	397	2,85 €
13139	397	3,85 €
13140	397	2,65 €
13141	397	1,80 €
13142	397	3,10 €
13143	397	1,95 €
13144	397	2,20 €
13145	397	3,85 €
13146	397	4,50 €

REF.	PAGE	PRIX
13147	397	3,10 €
13148	397	3,30 €
13149	397	3,10 €
13150	397	2,25 €
13151	397	5,35 €
13152	397	3,05 €
13153	397	3,10 €
13154	397	3,20 €
13155	397	5,60 €
13156	397	3,30 €
13157	397	3,85 €
13158	397	3,75 €
13159	397	3,20 €
13160	397	5,00 €
13161	397	3,55 €
13162	397	2,60 €
13163	397	2,80 €
13217	412	1,31 €
13226	67	4,50 €
13227	67	4,50 €
13228	67	4,50 €
13229	67	4,50 €
13230	67	4,50 €
13231	67	4,50 €
13232	67	4,50 €
13234	305	224,50 €
13235	384	0,15 €
13236	384	0,15 €
13237	384	0,15 €
13238	384	0,20 €
13239	384	0,20 €
13240	384	0,40 €
13241	384	0,55 €
13447	40	16,50 €
13448	40	17,50 €
13449	40	20,00 €
13450	40	23,00 €
13451	40	28,00 €
13452	40	29,50 €
13453	39	9,00 €
13454	39	9,50 €
13455	39	10,50 €
13456	39	11,50 €
13457	39	12,00 €
13460	39	15,00 €
13462	39	17,00 €
13463	40	5,30 €
13464	40	5,30 €
13465	38, 39, 40	5,55 €
13466	38, 39, 40	5,55 €
13467	38, 39, 40	6,00 €
13468	38, 39, 40	6,25 €
13469	38, 39, 40	6,25 €
13470	38, 39, 40	6,60 €
13471	38, 39, 40	6,90 €
13472	38, 39, 40	7,25 €
13473	38, 39, 40	8,10 €

REF.	PAGE	PRIX
13474	38, 39, 40	8,70 €
13475	38, 39, 40	9,10 €
13476	38, 39, 40	9,60 €
13477	40	9,85 €
13478	40	12,20 €
13479	40	13,10 €
13480	40	15,50 €
13481	40	15,80 €
13482	40	22,10 €
13483	40	25,50 €
13484	40	27,20 €
13491	40	5,30 €
13492	40	5,35 €
13493	40	5,50 €
13494	40	6,00 €
13495	40	6,40 €
13496	40	6,60 €
13497	40	7,50 €
13498	40	8,50 €
13499	162	12,50 €
13500	162	12,90 €
13667	66, 89	17,60 €
13668	88	18,70 €
13674	68, 383	0,50 €
13675	68, 383	0,50 €
13676	68, 383	0,50 €
13677	68, 383	0,50 €
13678	68, 383	0,50 €
13680	174	15,50 €
13681	174	15,50 €
13682	174	15,50 €
13683	174	15,50 €
13684	174	15,50 €
13685	174	15,50 €
13686	174	15,50 €
13687	174	15,50 €
13688	174	15,50 €
13689	174	15,50 €
13704	69	21,00 €
13707	59	14,00 €
13708	59	14,00 €
13709	59	14,00 €
13710	59	14,00 €
13712	59	14,00 €
13717	412	7,65 €
13723	176	18,50 €
13724	176	19,20 €
13725	176	19,20 €
13726	176	19,00 €
13727	176	18,70 €
13728	176	18,50 €
13729	176	22,00 €
13730	176	22,00 €
13731	176	21,60 €
13732	176	23,80 €
13733	176	24,90 €
13734	176	25,70 €

REF.	PAGE	PRIX
13735	176	25,80 €
13736	176	25,90 €
13738	360	3,50 €
13739	360	5,50 €
13740	360	5,50 €
13741	372	21,00 €
13745	176	25,20 €
13746	176	25,40 €
13747	176	25,40 €
13748	176	24,90 €
13805	370	10,50 €
13806	370	10,50 €
13809	166	18,50 €
13810	166	20,50 €
13813	185	7,00 €
13814	185	11,00 €
13817	151	17,00 €
13818	151	20,50 €
13819	388	6,50 €
13820	388	7,00 €
13821	388	14,00 €
13822	388	11,00 €
13823	388	6,00 €
13824	388	8,00 €
13825	388	11,50 €
13826	388	13,00 €
13827	388	15,00 €
13828	388	11,50 €
13829	388	10,50 €
13830	388	10,50 €
13831	388	12,60 €
13832	388	13,00 €
13833	388	9,00 €
13839	144	8,50 €
13842	180	8,50 €
13843	180	7,00 €
13844	180	9,00 €
13845	180	8,00 €
13856	202	7,80 €
13859	172	16,00 €
13874	172	17,50 €
13875	172	18,50 €
13876	172	18,50 €
13877	172	18,50 €
13879	360	1,38 €
13880	360	1,50 €
13923	89	7,45 €
13929	406, 410	3,45 €
13930	165	1,50 €
13931	165	2,50 €
13932	165	2,50 €
13933	165	2,00 €
13934	165	2,50 €
13935	165	2,50 €
13936	165	3,50 €
13937	165	4,00 €
13938	165	3,50 €

REF.	PAGE	PRIX
13939	165	4,00 €
13945	387	7,40 €
13946	387	6,70 €
13947	387	5,85 €
13948	387	5,00 €
13949	387	6,50 €
13950	387	7,80 €
13951	387	5,15 €
13952	387	10,90 €
13953	387	8,00 €
13954	387	12,70 €
13955	387	4,95 €
13956	387	4,30 €
13957	387	9,70 €
13958	387	5,45 €
13959	387	10,10 €
13960	387	9,65 €
13961	387	9,25 €
13962	387	1,76 €
13963	387	12,40 €
13964	387	15,00 €
13965	387	1,50 €
13966	387	12,90 €
13967	387	4,65 €
13968	409	1,35 €
13969	204	19,00 €
13982	303	4,00 €
14004	171	9,50 €
14005	171	10,50 €
14006	171	9,50 €
14007	171	9,50 €
14008	171	9,50 €
14009	171	9,50 €
14010	171	11,00 €
14011	171	11,00 €
14013	152	3,50 €
14026	53	5,50 €
14027	53	5,60 €
14029	53	8,50 €
14030	53	9,50 €
14031	131, 144	7,90 €
14032	144	12,00 €
14033	144	4,50 €
14034	410	9,00 €
14049	237	8,00 €
14050	237	10,50 €
14051	237	18,00 €
14052	237	19,50 €
14075	165	2,00 €
14076	165	1,50 €
14077	165	4,50 €
14078	165	4,00 €
14083	412	13,20 €
14114	89	19,30 €
14118	365	26,00 €
14120	146	22,00 €
14121	146	26,00 €

REF.	PAGE	PRIX
14122	148	34,00 €
14123	148	33,00 €
14124	150	20,50 €
14125	150	19,50 €
14126	153	54,00 €
14127	155	32,50 €
14129	151	12,50 €
14130	151	21,00 €
14131	149	24,00 €
14133	155	16,50 €
14135	155	12,50 €
14136	152	12,00 €
14137	159	131,00 €
14145	328	8,50 €
14146	328	8,00 €
14147	328	25,00 €
14148	328	25,00 €
14153	149	20,50 €
14154	153	42,00 €
14157	161	8,30 €
14158	161	9,95 €
14159	161	12,60 €
14160	161	12,80 €
14161	161	13,70 €
14162	153	25,50 €
14163	153	25,50 €
14164	153	25,50 €
14165	146	26,50 €
14167	70	2,50 €
14168	160	7,00 €
14169	163	3,00 €
14172	173	8,50 €
14173	173	9,50 €
14177	173	9,50 €
14178	173	9,50 €
14179	58	8,50 €
14180	58	7,90 €
14183	68	31,00 €
14187	219	6,00 €
14188	160	0,50 €
14189	412	52,00 €
14190	165	2,00 €
14191	165	2,00 €
14192	165	4,00 €
14193	165	4,00 €
14195	166	4,00 €
14196	166	4,00 €
14197	166	4,50 €
14198	166	4,00 €
14199	166	4,00 €
14200	166	4,50 €
14201	165	4,00 €
14202	165	4,00 €
14203	165	4,50 €
14204	165	1,50 €
14205	165	1,50 €
14206	165	1,50 €

REF.	PAGE	PRIX
14207	165	1,50 €
14208	165	1,50 €
14209	165	1,50 €
14211	237	11,00 €
14212	237	12,00 €
14213	237	12,00 €
14214	237	14,00 €
14286	153	2,99 €
14287	153	2,99 €
14288	153	6,00 €
14289	153	6,10 €
14296	74, 75, 76, 77, 83	118,00 €
14297	74, 75, 76, 77, 83	87,00 €
14298	74, 75, 76, 77, 83	51,50 €
14299	74, 75, 76, 77, 83	87,00 €
14300	220	19,00 €
14301	220	19,00 €
14314	166	5,00 €
14315	166	4,50 €
14330	153	3,50 €
14336	149	58,00 €
14340	237	10,50 €
14341	237	10,50 €
14342	237	10,50 €
14343	237	10,50 €
14344	237	11,00 €
14345	237	11,00 €
14346	237	11,00 €
14347	408	36,50 €
14348	212	12,50 €
14349	212	20,50 €
14350	403, 404	1,80 €
14351	404	1,65 €
14352	404	1,30 €
14353	404	2,10 €
14354	90	14,00 €
14355	404	1,70 €
14356	404	1,90 €
14357	404	1,90 €
14358	403, 404	1,70 €
14359	401, 404	1,05 €
14361	404	1,70 €
14364	404	1,90 €
14365	404	1,90 €
14366	404	1,45 €
14367	404	1,30 €
14368	404	1,45 €
14369	404	4,95 €
14370	404	3,00 €
14371	404	3,00 €
14372	404	1,20 €
14373	404	1,35 €
14374	403	1,70 €
14375	403	1,85 €
14376	403	2,60 €
14377	403	1,90 €

REF.	PAGE	PRIX
14378	403	1,90 €
14379	403	1,45 €
14380	411	51,00 €
14381	403	1,70 €
14382	403	1,85 €
14383	403	1,35 €
14384	403	2,10 €
14387	403	1,45 €
14388	403	2,05 €
14389	403	1,25 €
14390	403	1,35 €
14391	403	2,15 €
14392	403	1,35 €
14393	403	1,50 €
14395	403	1,65 €
14396	403	1,20 €
14397	403	1,45 €
14398	403	1,30 €
14399	403	1,90 €
14402	403	1,50 €
14404	403	2,10 €
14405	403	1,45 €
14406	403	1,55 €
14408	403	1,45 €
14409	403	1,35 €
14410	402	1,85 €
14411	402	1,70 €
14412	402	1,70 €
14413	402	3,25 €
14414	402	1,70 €
14415	402	1,70 €
14416	402, 403	1,25 €
14419	402	1,95 €
14420	402	1,50 €
14421	402	2,45 €
14422	401, 402	1,50 €
14423	402	3,55 €
14424	402	1,85 €
14425	402	2,05 €
14426	402	1,90 €
14427	402	1,20 €
14428	402	1,40 €
14429	402	1,80 €
14430	402	2,25 €
14431	402	1,45 €
14432	402	1,45 €
14434	402	1,60 €
14435	402	1,45 €
14436	402	1,70 €
14437	402	1,45 €
14438	402	1,35 €
14439	402	1,75 €
14440	402	1,75 €
14441	402	1,65 €
14442	402	1,45 €
14443	402	1,45 €
14444	402	1,90 €

REF.	PAGE	PRIX
14445	402	1,45 €
14446	401	2,80 €
14447	401	1,45 €
14448	401	2,05 €
14449	401	2,20 €
14450	401	2,15 €
14451	401	2,15 €
14452	401	2,55 €
14453	401	3,05 €
14455	401	2,10 €
14456	401	1,35 €
14457	401	1,70 €
14458	401	1,70 €
14459	401	1,45 €
14460	401	1,15 €
14461	401	1,35 €
14462	401	1,65 €
14463	401	1,65 €
14464	401	1,50 €
14465	401	2,00 €
14466	401	1,65 €
14468	401	1,30 €
14469	401	1,45 €
14471	401	1,90 €
14472	401	1,35 €
14474	401	1,50 €
14475	401	1,65 €
14476	401	2,05 €
14477	401	2,45 €
14478	401	4,05 €
14479	401	1,65 €
14480	401	2,05 €
14481	401	1,70 €
14507	412	50,00 €
14534	161	16,50 €
14560	161	8,80 €
14561	166	8,80 €
14563	214	18,00 €
14564	183	9,20 €
14565	183	26,70 €
14566	183	16,70 €
14567	183	38,00 €
14568	183	9,20 €
14569	183	9,20 €
14570	183	4,05 €
14571	183	9,20 €
14573	183	4,05 €
14578	92	12,50 €
14580	92	41,00 €
14583	148	6,00 €
14594	221, 389	2,00 €
14595	221, 389	1,50 €
14596	221, 389	2,00 €
14597	221, 389	7,60 €
14598	221, 389	17,80 €
14599	221, 389	4,50 €
14600	221, 389	9,50 €

REF.	PAGE	PRIX
15069	90	32,80 €
15070	82	0,50 €
15071	82	0,60 €
15072	82	0,70 €
15073	82	1,00 €
15074	82	1,00 €
15075	82	1,20 €
15076	82	3,50 €
15083	88	8,50 €
15084	88, 203, 307	68,00 €
15093	317	38,00 €
15094	317	39,50 €
15095	317	13,00 €
15096	317	40,00 €
15122	39, 75, 85	74,00 €
15138	51	10,50 €
15139	51	12,00 €
15140	51	13,50 €
15144	93	30,00 €
15145	94	20,45 €
15146	94	16,20 €
15147	50	5,00 €
15148	50	5,00 €
15149	50	5,00 €
15152	408	160,00 €
15155	75, 85	59,00 €
15156	43, 85	70,00 €
15157	85	42,00 €
15158	85	59,00 €
15159	85	44,00 €
15160	85	42,00 €
15161	75, 85	62,00 €
15162	36, 87, 345	30,20 €
15206	43	15,00 €
15207	43	16,50 €
15208	43	17,00 €
15209	43	18,00 €
15227	36	3,50 €
15228	36	4,00 €
15229	36	5,00 €
15230	36	5,00 €
15231	36	3,50 €
15232	36	4,00 €
15233	36	5,00 €
15234	36	3,00 €
15253	222, 225	62,00 €
15300	369	5,00 €
15313	90	14,00 €
15315	86	28,20 €
15316	39, 86	58,00 €
15317	369	4,50 €
15328	39	6,00 €
15329	39	5,50 €
15330	39	5,50 €
15331	39	5,50 €
15332	39	6,00 €
15333	39	6,50 €

REF.	PAGE	PRIX
15334	39	7,00 €
15335	39	7,50 €
15336	39	8,00 €
15337	39	8,50 €
15338	39	9,00 €
15339	39	9,50 €
15375	183	28,00 €
15385	135	18,00 €
15448	343	5,50 €
15454	57, 86	35,40 €
15460	343	5,00 €
15494	200	12,50 €
15495	200	12,50 €
15496	200	11,50 €
15497	200	11,00 €
15498	200	11,50 €
15499	200	11,00 €
15500	200	10,00 €
15501	200	10,00 €
15502	200	10,00 €
15503	200	11,00 €
15504	200	10,00 €
15505	200	4,00 €
15506	200	4,00 €
15507	200	4,50 €
15508	200	4,50 €
15509	200	5,00 €
15510	200	5,00 €
15511	200	8,00 €
15514	75, 86	9,35 €
15515	39	15,50 €
15516	39	19,00 €
15517	39	22,50 €
15541	86	27,60 €
15552	190, 351	181,00 €
15564	148	11,90 €
15619	355	4,00 €
15631	303	98,00 €
15632	38	9,00 €
15633	38	9,50 €
15634	38	11,00 €
15635	38	12,50 €
15636	38	14,00 €
15637	38	15,00 €
15681	85	134,00 €
15706	63, 86	31,00 €
15730	78, 84	289,00 €
15731	78, 84	214,00 €
15732	78, 84	293,50 €
15733	78, 84	113,00 €
15734	78, 84	288,50 €
15735	78, 84	152,00 €
15736	78, 84	488,50 €
15737	66, 86	45,00 €
15783	65	3,50 €
15784	65	3,50 €
15785	65	3,50 €

REF.	PAGE	PRIX
15786	65	3,50 €
15787	65	3,50 €
15799	63, 87	28,30 €
15866	350	32,00 €
15874	310	6,50 €
16010	46	4,00 €
16011	46	4,00 €
16012	46	4,00 €
16013	46	4,50 €
16014	46	4,50 €
16015	46	5,00 €
16016	46	5,00 €
16017	46	5,00 €
16018	46	5,50 €
16019	46	6,00 €
16020	41	17,00 €
16021	41	19,50 €
16022	41	23,00 €
16023	41	26,50 €
16024	41	34,50 €
16025	41	37,50 €
16052	137, 144	2,09 €
16053	137, 144	2,85 €
16111	61, 87	19,20 €
16130	343	290,00 €
16161	91	17,50 €
16162	91	35,10 €
16163	91	10,20 €
16188	91	39,60 €
16198	343	5,00 €
16237	237	23,00 €
16238	237	23,00 €
16239	237	23,00 €
16240	237	26,00 €
16241	237	23,00 €
16242	237	26,00 €
16243	237	23,00 €
16273	150	12,50 €
16294	395	14,00 €
16295	206	30,00 €
16300	227	7,60 €
16301	227	7,60 €
16302	227	7,60 €
16304	172	31,00 €
16305	172	31,00 €
16309	220	149,00 €
16316	221	18,50 €
16318	126	0,50 €
16319	126	0,50 €
16320	126	0,50 €
16321	126	1,00 €
16322	126	1,00 €
16323	126	1,00 €
16324	126	1,50 €
16325	126	1,50 €
16326	126	2,00 €
16327	126	2,00 €

REF.	PAGE	PRIX
16328	126	2,50 €
16329	126	3,00 €
16330	126	3,50 €
16331	126	3,50 €
16332	126	4,00 €
16333	126	4,50 €
16334	126	5,50 €
16335	126	6,00 €
16336	126	6,50 €
16341	147	32,50 €
16342	65	2,50 €
16343	65	2,50 €
16344	90	43,00 €
16354	90	1,50 €
16355	90	2,00 €
16356	90	2,50 €
16357	90	2,50 €
16358	90	12,00 €
16359	90	10,00 €
16360	90	12,00 €
16361	90	16,50 €
16362	90	20,00 €
16363	90	14,50 €
16364	123, 410	3,50 €
16366	206	11,00 €
16367	206	10,00 €
16368	206	12,00 €
16369	206	12,00 €
16370	206	12,00 €
16371	206	11,00 €
16372	206	11,50 €
16373	206	12,00 €
16374	206	12,00 €
16375	206	15,00 €
16376	206	15,00 €
16377	206	16,00 €
16378	206	15,00 €
16379	206	15,00 €
16380	206	16,00 €
16381	206	10,00 €
16382	206	10,00 €
16383	206	15,00 €
16384	206	15,00 €
16385	242	10,00 €
16386	242	11,50 €
16387	92	10,50 €
16388	242	11,50 €
16389	242	11,50 €
16391	39	4,60 €
16392	39	4,60 €
16393	39	4,60 €
16394	39	5,10 €
16395	39	5,10 €
16396	39	5,10 €
16397	39	5,50 €
16398	39	5,50 €
16399	39	5,50 €

REF.	PAGE	PRIX
16400	259	6,50 €
16401	39	6,10 €
16402	39	6,10 €
16403	39	6,10 €
16430	233	20,50 €
16431	233	20,50 €
16432	233	20,50 €
16433	233	20,50 €
16434	233	20,50 €
16435	233	21,50 €
16436	233	21,50 €
16448	222	16,50 €
16462	389	36,50 €
16463	389	36,50 €
16464	389	36,50 €
16465	389	39,50 €
16466	389	50,00 €
16467	389	36,50 €
16468	389	36,50 €
16469	389	36,50 €
16470	389	39,50 €
16471	389	50,00 €
16472	389	17,50 €
16473	389	17,50 €
16474	389	17,50 €
16475	389	17,50 €
16476	389	24,00 €
16477	389	24,50 €
16478	389	24,50 €
16479	389	7,50 €
16480	389	7,50 €
16481	93	14,00 €
16482	93	13,50 €
16490	73	650,00 €
16491	73	307,00 €
16492	73	675,00 €
16493	73	436,00 €
16494	73	139,00 €
16496	73	127,00 €
16497	73	77,00 €
16498	73	84,00 €
16499	73	162,00 €
16500	73	463,00 €
16516	73	121,00 €
16538	389	19,50 €
16539	389	18,00 €
16540	389	13,00 €
16541	389	13,00 €
16542	389	23,50 €
16543	389	13,00 €
16546	43	5,00 €
16547	43	5,50 €
16548	43	9,00 €
16549	43	14,00 €
16561	73	36,50 €
16564	147	17,00 €
16565	233	19,50 €

REF.	PAGE	PRIX
16566	233	22,50 €
16571	172	32,00 €
16572	172	33,50 €
16574	172	34,00 €
16575	172	34,50 €
16576	172	35,50 €
16577	172	36,00 €
16583	126	8,50 €
16584	126	10,50 €
16585	126	11,50 €
16586	126	13,00 €
16587	126	14,00 €
16588	126	15,00 €
16600	73	252,00 €
16627	73	225,00 €
16628	73	382,00 €
16629	73	419,00 €
16642	65	1,00 €
16737	226	12,00 €
50400	191	168,00 €
50403	191	98,00 €
50409	192	26,00 €
50410	191	168,00 €
50431	357	3,80 €
50517	350	129,00 €
50518	350	169,00 €
50523	357	4,70 €
50524	357	4,70 €
50525	365	1,00 €
50526	365	4,80 €
50551	357	350,00 €
50562	44	23,50 €
50564	42	30,00 €
50567	57	9,60 €
50577	186	12,60 €
50585	361	14,70 €
50600	368	0,60 €
50601	368	0,29 €
50622	46	64,00 €
50623	21	60,00 €
50630	324	590,00 €
50631	322	68,00 €
50632	335	298,00 €
50644	359	11,60 €
50651	391	18,00 €
50652	391	16,50 €
50654	354	4,00 €
50656	190, 351	290,00 €
50717	359	21,90 €
50724	69	28,00 €
50731	217	68,00 €
50751	156, 312	43,00 €
50760	368	0,10 €
50761	368	0,19 €
50762	368	0,29 €
50763	368	0,38 €
50764	368	0,49 €

REF.	PAGE	PRIX
50765	368	0,58 €
50766	368	0,68 €
50767	368	0,78 €
50768	368	0,88 €
50778	368	0,10 €
50779	368	0,19 €
50780	368	0,29 €
50781	368	0,38 €
50782	368	0,49 €
50783	368	0,58 €
50784	368	0,68 €
50785	368	0,78 €
50786	368	0,88 €
50787	98	8,00 €
50788	98	14,50 €
50789	98	29,00 €
50792	236	105,00 €
50793	236	94,00 €
50797	349	490,00 €
50807	221, 391	38,00 €
50808	99	77,00 €
50815	314	88,00 €
50816	315	88,00 €
50818	314	198,00 €
50819	316	28,00 €
50820	316	34,50 €
50821	316	47,00 €
50822	316	59,00 €
50823	316	94,00 €
50824	316	88,00 €
50825	316	154,00 €
50827	223, 321	387,00 €
50830	317	560,00 €
50831	322	460,00 €
50835	319	290,00 €
50836	323	148,00 €
50838	323	299,00 €
50839	320	180,00 €
50840	322	138,00 €
50843	99	79,00 €
50844	99	65,00 €
50852	312	24,50 €
50901	181	16,00 €
50902	54	13,00 €
50903	181	30,80 €
50910	142	45,00 €
50911	324	788,00 €
50913	190, 351	195,00 €
50915	357	4,20 €
50916	192	0,88 €
50917	305	271,00 €
50918	304	341,00 €
50923	188, 320	454,00 €
50924	308, 351	342,00 €
50935	304	595,00 €
50937	69	10,50 €
50942	331, 344	28,00 €

REF.	PAGE	PRIX
50957	95	22,00 €
50959	95, 386	14,00 €
50966	354	4,00 €
50966C	354	3,00 €
50980	34	22,00 €
50982	34	22,00 €
50983	30	48,00 €
50985	30	59,00 €
51017	56	6,80 €
51018	56	7,05 €
51020	56	6,65 €
51021	56	7,05 €
51028	172	163,00 €
51033	339	98,00 €
51035	94	799,00 €
51050	95	285,00 €
51051	95	34,80 €
51055	368	0,98 €
51059	195	99,00 €
51119	229	62,00 €
51120	213	41,00 €
51121	222	27,30 €
51123	229	91,00 €
51124	241	88,00 €
51125	238	88,00 €
51126	234	18,00 €
51127	52	56,00 €
51127R	52	14,00 €
51131	180	61,00 €
51140	240	64,00 €
51206	146	228,00 €
51207	146	289,00 €
51210	148	650,00 €
51211	148	560,00 €
51212	148	488,00 €
51213	148	690,00 €
51214	150	148,00 €
51215	150	119,00 €
51216	153	650,00 €
51218	155	288,00 €
51220	151	240,00 €
51221	151	199,00 €
51222	149	128,00 €
51226	155	233,00 €
51235	329	49,00 €
51238	328	138,00 €
51239	328	159,00 €
51245	155	99,00 €
51246	358	6,40 €
51253	305	41,00 €
51258	134	0,15 €
51259	231	58,00 €
51260	29	37,00 €
51262	52	51,00 €
51262R	52	14,00 €
51266	359	28,00 €
51272	62	7,50 €

REF.	PAGE	PRIX
51277	157	64,00 €
51283	196	78,00 €
51305	50	28,90 €
51306	50	28,10 €
51307	50	29,70 €
51315	410	2,50 €
51318	38	98,00 €
51326	134	4,40 €
51332	200	98,00 €
51333	32	18,00 €
51336	173	29,30 €
51337	204	50,00 €
51338	52	53,00 €
51338R	52	14,00 €
51340	296	39,30 €
51341	163	35,00 €
51347	230	9,90 €
51349	242	37,30 €
51352	201	9,80 €
51353	201	11,50 €
51354	202	13,20 €
51355	60, 369	19,00 €
51356	308	48,00 €
51358	371	7,50 €
51359	371	9,00 €
51360	181	8,05 €
51361	181	9,80 €
51362	371	3,00 €
51363	328	114,00 €
51364	221	26,00 €
51365	328	118,00 €
51368	224	19,00 €
51369	224	28,00 €
51383	157	11,10 €
51385	162	4,55 €
51386	162	5,95 €
51387	162	3,25 €
51388	153	22,00 €
51389	153	22,00 €
51390	153	22,00 €
51391	153	22,00 €
51392	153	34,00 €
51393	153	34,00 €
51398N	375	1,54 €
51400	204	17,00 €
51401	204	22,00 €
51402	204	20,50 €
51403	204	17,50 €
51405	50	21,10 €
51406	50	29,20 €
51409	33	36,00 €
51410	33	36,00 €
51412	364	2,10 €
51414	224	14,00 €
51416	47	12,00 €
51419	91	2,79 €
51422	91	2,97 €

REF.	PAGE	PRIX
51439	153	26,00 €
51440	153	28,00 €
51441	153	26,00 €
51442	153	28,00 €
51443	162	5,50 €
51444	162	5,05 €
51445	162	5,05 €
51447	53, 87	16,00 €
51448	53, 87	52,00 €
51452	322	69,00 €
51479	53	31,80 €
51488	273	16,00 €
51489	284	12,00 €
51490	225	36,00 €
51491	230	154,00 €
51493	207	68,00 €
51494	205	107,00 €
51495	232	59,00 €
51496	236	8,00 €
51500	240	29,00 €
51501	233	38,00 €
51504	63	8,50 €
51525	62	9,80 €
51526	62	9,80 €
51528	44	49,00 €
51538	388	0,15 €
51539	388	0,15 €
51540	388	0,15 €
51541	388	0,25 €
51542	388	0,20 €
51543	388	0,25 €
51544	388	0,25 €
51545	388	0,30 €
51546	389	0,19 €
51554	389	0,28 €
51573	134	2,50 €
51574	95	52,00 €
51575	96	317,00 €
51576	93	125,00 €
51600	96	109,00 €
51604	368	0,98 €
51612	357	5,95 €
51613	357	2,90 €
51614	357	3,60 €
51615	357	5,95 €
51616	23	378,00 €
51622	192	25,30 €
51632N	375	1,54 €
51633	375	1,54 €
51634	375	1,54 €
51636N	375	1,54 €
51638N	375	1,54 €
51640N	375	1,54 €
51642N	375	1,54 €
51653	91	5,10 €
51654	91	4,80 €
51655	91	4,10 €

REF.	PAGE	PRIX
51656	91	3,65 €
51657	91	5,85 €
51658	91	4,50 €
51659	46	59,00 €
51661	47	12,00 €
51674	63	7,75 €
51692	355	3,55 €
51693	355	3,55 €
51694	355	3,55 €
51696	355	3,55 €
51697	364	0,80 €
51703	359	10,50 €
51705	359	8,45 €
51706	366	22,80 €
51707	366	9,05 €
51708	366	14,20 €
51709	366	14,70 €
51710	366	17,80 €
51711	366	21,20 €
51712	366	8,65 €
51713	366	13,10 €
51714	366	15,80 €
51715	366	20,30 €
51716	366	23,60 €
51717	366	11,20 €
51718	366	14,80 €
51719	366	22,00 €
51720	366	23,50 €
51721	366	25,00 €
51722	366	13,10 €
51723	366	18,70 €
51724	366	24,40 €
51725	366	28,30 €
51726	366	31,40 €
51727	366	49,00 €
51737	94	699,00 €
51738	93	850,00 €
51741	370	0,50 €
51742	370	0,50 €
51743	370	0,55 €
51745	376	0,70 €
51746	34	12,00 €
51751	320	99,00 €
51785	376	1,00 €
51795	47	9,00 €
51796	47	14,00 €
51797	47	18,00 €
51798	47	39,60 €
51799	389	0,20 €
51801	51	62,00 €
51804	386	58,00 €
51805	53, 87	17,00 €
51812	56	46,00 €
51814	369	8,00 €
51816	329	58,00 €
51817	354	4,50 €
51818	18	109,00 €

REF.	PAGE	PRIX
51824	192	36,80 €
51830	52	94,00 €
51831	339	24,00 €
51832	181	18,00 €
51837	336	195,00 €
51838	336	667,00 €
51839	198	24,00 €
51842	330	6,90 €
51843	389	0,19 €
51853	70	18,00 €
51855	23	378,00 €
51858	364	15,00 €
51859	339	3,80 €
51861	159, 359	199,00 €
51863	366	54,00 €
51864	45, 87	64,00 €
51886	142	44,00 €
51889	130	49,00 €
51890	46	92,00 €
51895	315	99,00 €
51896	235	82,00 €
51897	235	122,00 €
51898	235	139,00 €
51899	235	137,00 €
51901	319	999,00 €
51902	229	84,00 €
51905	316	34,50 €
51906	316	39,00 €
51907	316	48,00 €
51908	368	44,00 €
51909	65	2,46 €
51918	63	12,50 €
51919	228	89,00 €
51920	234, 392	18,00 €
51923	201	12,50 €
51925	365	1,00 €
51927	296	25,00 €
51928	308	14,00 €
51929	143	22,00 €
51934	201	11,50 €
51935	354	135,00 €
51936	354	135,00 €
51937	354	135,00 €
51951	70	15,60 €
51958	228	422,00 €
51960	138	34,00 €
51961	138	34,00 €
51962	138	25,00 €
51963	138	29,00 €
51964	138	28,00 €
51965	138	29,50 €
51966	139	18,00 €
51967	144	16,00 €
51968	144	16,00 €
51969	139	14,00 €
51972	60	12,00 €
51973	366	45,00 €

REF.	PAGE	PRIX
51975	91	2,27 €
51976	91	1,63 €
51978	191	84,00 €
51980	156	15,00 €
51981	157	21,50 €
51982	349	120,00 €
51983	349	185,00 €
51984	349	190,00 €
51985	191	84,00 €
51986	234	11,90 €
51989	216	49,00 €
51991	230	54,00 €
51995	58, 59	24,50 €
51998	226	38,00 €
52010	239	80,00 €
52012	228	68,00 €
52016	235	2,10 €
52017	235	2,40 €
52018	235	2,60 €
52019	235	3,20 €
52021	235	3,40 €
52022	235	4,50 €
52023	235	6,60 €
52024	235	10,60 €
52025	235	13,00 €
52026	181	31,80 €
52027	382	14,00 €
52028	385	15,20 €
52029	385	14,00 €
52030	388	98,00 €
52031	387	44,00 €
52032	386	28,00 €
52033	390	43,00 €
52043	384	16,50 €
52044	382	19,00 €
52047	357	3,30 €
52048	357	3,95 €
52049	66	14,00 €
52050	59	98,00 €
52052	57	53,00 €
52053	394	45,00 €
52054	394	17,00 €
52055	322	139,00 €
52056	242	66,00 €
52057	191	6,80 €
52058	191	4,50 €
52059	35	29,00 €
52060	35	32,00 €
52065	191	45,00 €
52066	218	12,00 €
52069	328	29,50 €
52070	328	40,00 €
52071	328	47,00 €
52076	211	111,00 €
52077	183	29,50 €
52148	99	65,00 €
52149	349	230,00 €

REF.	PAGE	PRIX
52152	60	13,50 €
52153	227	46,00 €
52156	149	140,00 €
52157	155	48,00 €
52158	386	38,50 €
52159	151	64,00 €
52160	151	48,00 €
52162	79, 338, 346	38,00 €
52163	388	95,00 €
52165	149	118,00 €
52167	150	48,00 €
52169	55	25,00 €
52170	55	16,00 €
52171	155	39,00 €
52180	63	19,00 €
52181	63	22,50 €
52182	63	24,00 €
52183	63	26,20 €
52184	63	43,00 €
52185	63	55,00 €
52186	63	72,00 €
52187	364	21,80 €
52188	63	15,50 €
52190	216	8,00 €
52191	197	198,00 €
52195	334	170,00 €
52197	50	36,30 €
52198	32	37,70 €
52200	351	88,00 €
52202	351	88,00 €
52207	50	24,20 €
52227	223	247,00 €
52230	190, 350	398,00 €
52231	330	49,00 €
52233	330	328,00 €
52235	48	11,00 €
52236	48	13,30 €
52237	48	18,10 €
52238	48	24,90 €
52241	319	1.690,00 €
52242	311	12,00 €
52243	311	8,50 €
52244	191	84,00 €
52251	364	21,80 €
52254	135	64,00 €
52259	359	3,75 €
52262	185	7,50 €
52263	185	13,50 €
52264	185	18,60 €
52265	185	30,50 €
52269	202	7,00 €
52270	224	109,00 €
52271	283	18,00 €
52272	57	24,60 €
52273	212	44,00 €
52275	198	38,00 €
52293	231	98,00 €

REF.	PAGE	PRIX
52295	185	6,50 €
52296	239	119,00 €
52297	239	172,00 €
52298	239	177,00 €
52302	140	25,40 €
52303	140	26,40 €
52304	316	84,00 €
52305	205	106,00 €
52308	100	440,00 €
52309	100	941,00 €
52310	375	3,65 €
52311	201	19,00 €
52312	201	9,00 €
52313	201	8,00 €
52314	201	26,60 €
52315	198	16,00 €
52316	232	18,90 €
52317	232	19,90 €
52318	69	73,00 €
52319	232	8,80 €
52320	34	22,00 €
52321	186	8,80 €
52327	186	12,00 €
52328	197	99,00 €
52329	303	36,40 €
52330	194	99,00 €
52331	159	201,00 €
52337	168	65,00 €
52338	173	41,00 €
52339	171	61,00 €
52340	171	58,00 €
52341	169	58,00 €
52342	170	63,00 €
52343	173	52,00 €
52344	171	197,00 €
52345	168	109,00 €
52346	169	103,00 €
52347	171	158,00 €
52348	172	179,00 €
52349	48	22,10 €
52350	48	22,60 €
52351	48	25,40 €
52352	48	32,40 €
52353	48	33,40 €
52354	48	34,40 €
52355	48	36,60 €
52357	48	54,00 €
52358	48	63,00 €
52362	357	1,23 €
52363	357	1,23 €
52364	357	2,86 €
52365	357	2,46 €
52368	357	1,14 €
52369	357	1,19 €
52370	357	1,17 €
52373	93	252,00 €
52375	137	38,00 €

REF.	PAGE	PRIX
52378	163	10,00 €
52381	157	20,50 €
52382	331, 344	19,50 €
52384	132	29,00 €
52385	186	251,00 €
52386	186	23,60 €
52390	187	35,20 €
52391	311	5,00 €
52412	59	5,00 €
52414	141	19,00 €
52415	141	19,00 €
52416	203	14,00 €
52417	203	28,00 €
52418	21	179,00 €
52419	89	80,00 €
52420	89	108,00 €
52421	89	172,00 €
52422	213	24,70 €
52424	47	64,00 €
52425	63	33,30 €
52426	63	52,00 €
52427	63	64,00 €
52428	305	40,00 €
52430	376	10,90 €
52432	224	35,00 €
52433	69	4,80 €
52434	197	125,00 €
52439	331	227,00 €
52450	338	105,00 €
52451	43	42,00 €
52452	310	8,00 €
52453	310	21,00 €
52454	238	12,90 €
52455	198	16,00 €
52456	137	36,00 €
52460	63	16,60 €
52461	63	25,70 €
52462	68	25,30 €
52463	67	26,10 €
52464	67	42,00 €
52466	98	11,00 €
52468	62	5,90 €
52472	62	4,90 €
52473	62	9,90 €
52474	187	68,00 €
52475	187	62,00 €
52476	187	50,00 €
52477	187	70,00 €
52478	187	49,00 €
52479	187	24,70 €
52480	187	44,00 €
52481	187	52,00 €
52482	187	44,00 €
52483	187	41,00 €
52484	187	66,00 €
52485	187	51,00 €
52486	187	62,00 €

REF.	PAGE	PRIX
52487	187	63,00 €
52488	211	28,00 €
52489	210	58,00 €
52490	156	6,65 €
52491	156	10,50 €
52493	378	4,50 €
52494	241	227,00 €
52495	216	14,50 €
52497	192	26,80 €
52498	308	58,00 €
52500	54	19,00 €
52502	187	31,40 €
52503	187	32,50 €
52504	187	27,60 €
52505	187	20,80 €
52506	187	16,00 €
52507	187	30,10 €
52508	59	38,40 €
52509	59	36,20 €
52511	187	42,00 €
52512	187	50,00 €
52514	320	84,00 €
52515	70, 216	9,10 €
52516	98	28,00 €
52517	98	6,00 €
52518	201	115,00 €
52519	36, 345	25,50 €
52524	53	51,00 €
52525	53	13,80 €
52526	53	28,40 €
52527	151	82,00 €
52528	155	49,00 €
52530	361	14,00 €
52533	161, 182	10,00 €
52534	361	15,00 €
52535	361	16,50 €
52536	130	57,00 €
52538	31	62,00 €
52539	31	59,00 €
52540	159, 182	221,00 €
52541	222	45,00 €
52542	99	109,00 €
52543	160	182,00 €
52544	175	93,00 €
52545	175	177,00 €
52546	171	39,60 €
52547	168	96,00 €
52550	30	92,00 €
52551	242	151,00 €
52552	372	128,00 €
52555	134	2,38 €
52558	134	2,38 €
52565	63	11,50 €
52566	140	28,00 €
52567	140	29,00 €
52568	141	28,00 €
52569	141	28,00 €

REF.	PAGE	PRIX
52570	375	2,60 €
52571	375	2,60 €
52572	375	2,60 €
52573	375	2,60 €
52574	152	69,00 €
52575	68, 160	119,00 €
52583	69	8,50 €
52587	50	39,90 €
52588	50	45,00 €
52591	214	12,00 €
52592	214	22,00 €
52593	214	34,00 €
52595	68	64,00 €
52596	67	114,00 €
52597	67	146,00 €
52598	121, 340	1.080,00 €
52599	210	230,00 €
52600	342	884,00 €
52601	304	397,00 €
52603	28	74,00 €
52604	28	78,00 €
52605	28	76,00 €
52606	28	88,00 €
52607	203	49,00 €
52608	203	44,00 €
52609	68	29,00 €
52615	201	112,00 €
52616	296	44,00 €
52617	204	7,00 €
52618	365	29,00 €
52619	59	23,10 €
52620	31	8,80 €
52621	232	11,00 €
52624	241	28,00 €
52625	60, 198	9,00 €
52626	238	46,00 €
52627	238	120,00 €
52628	308	26,50 €
52629	208	99,00 €
52633	359	1,00 €
52634	91	5,25 €
52635	91	4,80 €
52636	194	114,00 €
52637	229	48,00 €
52638	69	9,95 €
52639	209	123,00 €
52640	225	52,00 €
52641	225	55,00 €
52642	228	32,00 €
52643	339	596,00 €
52644	360	8,80 €
52645	371	0,55 €
52646	371	0,50 €
52648	158	9,00 €
52649	370	5,00 €
52650	370	5,00 €
52652	369	2,80 €

REF.	PAGE	PRIX
52653	369	3,00 €
52655	371	39,70 €
52656	371	39,50 €
52657	371	37,50 €
52658	371	39,70 €
52659	371	39,70 €
52660	372	126,00 €
52662	370	36,50 €
52663	370	30,00 €
52664	372	168,00 €
52665	368	0,37 €
52666	368	0,36 €
52667	368	0,76 €
52668	368	1,49 €
52669	368	2,22 €
52670	368	2,95 €
52671	368	3,70 €
52672	368	4,45 €
52673	370	18,00 €
52675	154	84,00 €
52676	154	98,00 €
52677	202	17,00 €
52678	202	18,00 €
52685	210	88,00 €
52687	218	168,00 €
52690	215	54,00 €
52691	232	54,00 €
52692	324	129,00 €
52693	213	24,50 €
52694	168	49,00 €
52696	213	12,00 €
52697	213	16,00 €
52699	228	22,00 €
52700	70	20,50 €
52703	384	22,00 €
52711	383	27,50 €
52714	33	15,70 €
52715	33	10,00 €
52716	33	15,90 €
52717	33	11,00 €
52718	152	48,00 €
52719	389	0,19 €
52722	22	87,00 €
52724	151	381,00 €
52725	151	349,00 €
52727	239	34,60 €
52728	239	68,00 €
52729	239	128,00 €
52730	239	288,00 €
52731	239	38,00 €
52732	239	58,00 €
52733	239	98,00 €
52734	213	51,00 €
52735	166	4,85 €
52736	166	5,35 €
52737	166	5,50 €
52738	375	5,00 €

REF.	PAGE	PRIX
52739	375	5,00 €
52740	184	690,00 €
52749	189	79,00 €
52753	30	107,00 €
52754	204	54,00 €
52757	209	16,00 €
52758	154	88,00 €
52760	70, 216	4,10 €
52761	61	8,00 €
52762	61	9,00 €
52765	185	21,70 €
52768	356	13,80 €
52769	356	14,50 €
52770	356	23,00 €
52771	356	23,40 €
52772	356	13,90 €
52773	356	14,60 €
52774	356	14,80 €
52775	356	15,20 €
52776	356	13,80 €
52777	356	15,50 €
52778	356	14,60 €
52779	356	17,10 €
52780	356	13,90 €
52781	356	14,60 €
52782	356	14,80 €
52783	356	15,20 €
52786	64	14,60 €
52787	157	9,00 €
52788	181	39,00 €
52789	308	15,20 €
52791	58, 59	18,00 €
52794	69	28,00 €
52795	354	5,80 €
52796	228	98,00 €
52797	305	198,00 €
52798	156	18,00 €
52801	212	26,00 €
52802	226	54,00 €
52804	309	343,00 €
52805	309	426,00 €
52806	309	742,00 €
52807	309	1.714,00 €
52809	201	8,50 €
52810	170	9,00 €
52811	170	9,90 €
52812	59	65,00 €
52813	212	79,00 €
52814	149	528,00 €
52815	208	110,00 €
52816	232	28,10 €
52817	232	23,50 €
52819	216	22,00 €
52821	212	28,80 €
52822	230	32,00 €
52823	226	124,00 €
52827	138	46,00 €

REF.	PAGE	PRIX
52828	138	43,00 €
52829	222	19,00 €
52830	64	24,00 €
52831	64	18,00 €
52832	215	75,00 €
52833	237	39,30 €
52834	224	195,00 €
52835	224	272,00 €
52836	184	1.100,00 €
52838	142	56,00 €
52839	142	64,00 €
52842	372	11,00 €
52843	139	31,60 €
52845	323	170,00 €
52846	57	37,80 €
52847	57	41,00 €
52849	230	8,50 €
52850	215	7,80 €
52851	181, 395	9,65 €
52852	230	6,80 €
52858	206	298,00 €
52862	357	1,15 €
52864	357	1,20 €
52865	357	0,50 €
52866	357	0,25 €
52869	100	52,00 €
52870	100	100,00 €
52871	100	258,00 €
52873	69	11,00 €
52874	225	82,00 €
52875	225	79,00 €
52876	180	182,00 €
52877	64	15,80 €
52878	64	11,20 €
52879	64	10,10 €
52880	47	42,00 €
52881	47	17,00 €
52882	213	14,00 €
52884	329	73,00 €
52885	64	18,00 €
52886	396	18,00 €
52887	396	22,00 €
52888	400	24,00 €
52889	398	19,00 €
52890	399	22,00 €
52891	398	28,00 €
52892	399	22,00 €
52893	400	26,00 €
52894	398	22,00 €
52895	400	22,00 €
52896	396	26,00 €
52897	399	38,00 €
52898	399	36,00 €
52899	397	34,00 €
52900	397	34,00 €
52901	397	34,00 €
52902	342	970,00 €

REF.	PAGE	PRIX
52903	342	1.100,00 €
52904	69	61,00 €
52905	70	28,00 €
52906	196	38,00 €
52908	34	17,00 €
52909	34	12,50 €
52910	138	39,00 €
52912	45, 87	91,00 €
52913	51	292,00 €
52914	177	223,00 €
52915	177	199,00 €
52916	177	218,00 €
52917	177	122,00 €
52918	177	146,00 €
52919	177	181,00 €
52920	177	155,00 €
52921	177	117,00 €
52922	177	180,00 €
52923	177	59,00 €
52924	177	52,00 €
52925	177	176,00 €
52926	177	201,00 €
52927	177	59,00 €
52928	177	172,00 €
52929	177	185,00 €
52930	178	117,00 €
52931	178	45,00 €
52932	178	45,00 €
52933	178	194,00 €
52934	178	102,00 €
52935	178	94,00 €
52936	178	199,00 €
52937	178	265,00 €
52938	178	199,00 €
52939	178	28,00 €
52940	178	235,00 €
52941	178	70,00 €
52942	178	105,00 €
52943	178	75,00 €
52944	178	110,00 €
52945	178	281,00 €
52952	331, 344	74,00 €
52953	152	38,00 €
52955	61	19,80 €
52956	61	19,60 €
52957	61	23,80 €
52958	61	28,20 €
52959	61	42,00 €
52960	61	46,00 €
52962	226	42,00 €
52963	217	49,00 €
52964	56	9,45 €
52965	56	9,20 €
52966	56	9,45 €
52967	56	9,40 €
52969	172	20,70 €
52973	42	59,00 €

REF.	PAGE	PRIX
52977	182	137,00 €
52980	335	480,00 €
52982	60, 186	53,00 €
52985	322	598,00 €
52987	132	20,00 €
52991	311	10,50 €
52992	311	18,00 €
52998	185	48,00 €
52999	321	178,00 €
53001	217	242,00 €
53007	357	0,42 €
53008	201	15,50 €
53009	209	42,00 €
53010	54	18,00 €
53017	38	57,00 €
53018	40	119,00 €
53025	69	3,50 €
53026	69	5,80 €
53027	69	9,00 €
53028	331	5,80 €
53029	331	6,80 €
53030	331	12,00 €
53031	100	59,00 €
53032	100	126,00 €
53033	364	21,50 €
53037	371	0,50 €
53038	371	0,50 €
53039	371	0,50 €
53040	371	0,50 €
53041	235	37,60 €
53042	69	9,90 €
53043	175	53,00 €
53044	175	121,00 €
53045	140	35,00 €
53046	140	39,00 €
53047	141	330,00 €
53048	141	89,00 €
53049	140	89,00 €
53051	141	158,00 €
53052	140	158,00 €
53053	215	12,00 €
53054	238	6,00 €
53055	236	33,00 €
53056	241	127,00 €
53057	217	149,00 €
53058	241	193,00 €
53059	242	52,00 €
53060	170	34,90 €
53062	240	99,00 €
53063	162	36,70 €
53064	162	37,40 €
53065	162	36,90 €
53066	162	61,00 €
53067	162	61,00 €
53068	162	63,00 €
53069	208	98,00 €
53070	48	16,20 €

REF.	PAGE	PRIX
53071	48	26,10 €
53072	48	31,60 €
53073	48	50,00 €
53074	17	78,00 €
53077	174	62,00 €
53078	310	18,00 €
53079	189	89,00 €
53080	189	99,00 €
53081	52	115,00 €
53082	52	148,00 €
53083	65	64,00 €
53084	34	24,00 €
53085	135	30,00 €
53086	238	9,00 €
53087	356	11,20 €
53088	356	11,50 €
53089	356	11,50 €
53090	356	11,50 €
53091	356	10,20 €
53092	356	10,20 €
53093	356	10,20 €
53094	356	10,20 €
53095	66	20,50 €
53096	209	28,80 €
53108	22	92,00 €
53110	181, 395	27,30 €
53111	332	19,00 €
53112	314	298,00 €
53118	230	231,00 €
53119	213	52,00 €
53120	65	6,00 €
53121	65	7,35 €
53122	65	9,50 €
53124	188	287,00 €
53125	188	477,00 €
53126	189	243,00 €
53127	34	12,00 €
53129	216	84,00 €
53134	189	144,00 €
53137	155	38,00 €
53140	152	98,00 €
53141	155	68,00 €
53144	307	18,00 €
53145	332	39,20 €
53146	239	30,50 €
53147	163	41,00 €
53150	369	24,00 €
53151	143	14,00 €
53154	36, 345	462,00 €
53156	32	26,20 €
53159	25	289,00 €
53162	332	60,00 €
53164	36, 345	16,50 €
53165	36, 345	19,60 €
53166	339	10,50 €
53167	339	12,50 €
53168	339	19,00 €

REF.	PAGE	PRIX
53177	356	11,90 €
53178	356	12,20 €
53179	356	12,20 €
53180	356	12,20 €
53181	356	11,90 €
53182	356	12,20 €
53183	356	12,70 €
53184	356	12,20 €
53185	355	13,20 €
53186	355	13,20 €
53187	311	39,00 €
53188	311	7,00 €
53189	337	128,00 €
53190	337	98,00 €
53191	98	14,80 €
53192	98	52,00 €
53196	192	33,00 €
53197	174	46,00 €
53198	311	9,50 €
53200	318	69,00 €
53202	160	15,70 €
53203	357	0,46 €
53204	160	81,00 €
53205	157	19,00 €
53206	202	38,20 €
53207	225	118,00 €
53208	225	126,00 €
53209	329	8,50 €
53210	48	48,00 €
53211	99	75,00 €
53212	16	174,00 €
53214	309	285,00 €
53215	307	19,00 €
53216	130	49,00 €
53217	132	47,00 €
53218	318	26,00 €
53220	334	260,00 €
53221	365	4,75 €
53224	180	142,00 €
53225	56	3,50 €
53226	192	14,90 €
53227	135	28,00 €
53229	388	38,70 €
53230	183	19,70 €
53232	185	39,00 €
53235	203	10,40 €
53236	203	11,50 €
53237	203	12,90 €
53238	203	18,40 €
53240	234	58,00 €
53241	361	9,00 €
53246	324	1.144,00 €
53249	231	192,00 €
53250	208	85,00 €
53251	213	88,00 €
53253	96	98,00 €
53256	368	34,00 €

REF.	PAGE	PRIX
53259	249	97,00 €
53260	249	168,00 €
53261	249	214,00 €
53262	250	251,00 €
53263	250	57,00 €
53264	250	143,00 €
53265	251	195,00 €
53266	251	224,00 €
53267	251	277,00 €
53268	258	92,00 €
53269	252	50,00 €
53270	270	70,00 €
53271	270	227,00 €
53272	271	195,00 €
53273	271	75,00 €
53274	284	30,50 €
53275	284	35,50 €
53276	285	160,00 €
53277	285	45,00 €
53278	285	143,00 €
53279	286	97,00 €
53280	286	112,00 €
53281	286	55,00 €
53282	287	48,00 €
53283	287	92,00 €
53284	287	306,00 €
53285	288	56,00 €
53286	288	87,00 €
53287	288	245,00 €
53288	289	72,00 €
53289	274	45,00 €
53290	274	51,00 €
53291	274	68,00 €
53292	275	116,00 €
53293	261	134,00 €
53294	261	119,00 €
53295	262	77,00 €
53296	262	60,00 €
53297	267	45,00 €
53298	267	91,00 €
53299	278	291,00 €
53300	278	41,00 €
53301	278	44,00 €
53302	279	44,00 €
53303	244	89,00 €
53304	244	279,00 €
53305	279	136,00 €
53306	244	53,00 €
53307	279	38,50 €
53308	245	55,00 €
53309	245	285,00 €
53310	245	498,00 €
53311	275	97,00 €
53312	246	127,00 €
53313	258	139,00 €
53314	258	98,00 €
53315	295	285,00 €

REF.	PAGE	PRIX
53316	280	34,00 €
53317	280	34,00 €
53318	261	24,00 €
53319	246	18,00 €
53320	289	12,00 €
53321	289	10,50 €
53324	264	12,50 €
53325	289	7,50 €
53326	290	16,00 €
53327	290	11,00 €
53328	226	76,00 €
53330	212	38,00 €
53331	67	31,80 €
53332	67	34,50 €
53339	70	9,50 €
53340	388	86,00 €
53343	149	285,00 €
53346	50	18,00 €
53347	205	100,00 €
53348	382	14,00 €
53349	392	14,00 €
53350	382	14,00 €
53351	384	12,50 €
53352	390	12,00 €
53353	387	18,00 €
53354	384	14,00 €
53355	393	11,50 €
53356	393	11,50 €
53357	394	7,00 €
53358	390	11,50 €
53359	390	16,00 €
53360	384	18,00 €
53361	384	24,00 €
53362	385	14,00 €
53363	382	34,00 €
53364	382	16,00 €
53365	385	14,00 €
53366	385	14,00 €
53367	393	9,50 €
53368	393	9,00 €
53369	385	14,00 €
53370	393	26,00 €
53371	383	29,00 €
53372	383	26,00 €
53373	383	14,50 €
53374	392	10,00 €
53376	392	10,50 €
53377	386	20,00 €
53378	390	13,00 €
53380	393	11,50 €
53381	390	14,50 €
53382	383	11,00 €
53383	383	11,50 €
53384	225	165,00 €
53385	61, 394	19,30 €
53388	233	90,00 €
53389	57	31,50 €

REF.	PAGE	PRIX
53390	58	34,50 €
53391	234	86,00 €
53393	234	118,00 €
53394	223	598,00 €
53395	218	16,00 €
53396	58	18,30 €
53399	92	3,50 €
53400	92	5,70 €
53401	92	7,40 €
53402	92	9,60 €
53403	92	6,50 €
53404	92	6,50 €
53405	92	5,30 €
53406	92	8,55 €
53407	92	12,70 €
53408	92	19,30 €
53409	92	9,00 €
53410	217	92,00 €
53411	60	5,00 €
53412	60	4,00 €
53414	333	49,00 €
53415	333	188,00 €
53416	158	14,10 €
53417	158	26,30 €
53418	158	16,90 €
53419	372	9,70 €
53420	44	72,00 €
53421	315	298,00 €
53422	314	368,00 €
53423	323	199,00 €
53426	217	39,80 €
53427	134	5,00 €
53428	139	18,00 €
53429	139	18,00 €
53430	178	286,00 €
53434	392	18,00 €
53441	201	9,80 €
53444	27	195,00 €
53445	60	17,10 €
53449	158	16,40 €
53450	158	28,30 €
53452	280	26,50 €
53453	218	7,00 €
53456	220	98,00 €
53459	221	66,00 €
53463	242	98,00 €
53464	209, 387	153,00 €
53468	52	8,50 €
53470	171	176,00 €
53472	204	12,00 €
53473	204	36,00 €
53474	234	94,00 €
53477	217	36,10 €
53478	52	4,55 €
53479	52	6,40 €
53480	52	19,90 €
53481	52	27,40 €

REF.	PAGE	PRIX
53484	332	615,00 €
53485	205	140,00 €
53486	183	29,30 €
53487	59	16,70 €
53488	229	61,00 €
53489	211	68,00 €
53490	209	275,00 €
53492	163, 410	380,00 €
53499	220	29,00 €
53500	220	29,00 €
53501	209	24,00 €
53502	236	38,70 €
53503	338	12,00 €
53504	410	38,00 €
53505	135	77,00 €
53506	135	36,00 €
53507	354	27,00 €
53508	365	14,00 €
53517	64	9,50 €
53518	310	3,50 €
53519	130	42,00 €
53520	146	228,00 €
53522	209	24,00 €
53523	275	91,00 €
53524	237	51,00 €
53525	182	12,00 €
53526	338, 348	119,00 €
53531	169	109,00 €
53532	164, 348	119,00 €
53533	409	1,50 €
53536	143	34,00 €
53537	204	14,50 €
53538	204	14,50 €
53539	219	66,00 €
53541	152	168,00 €
53542	159, 372	980,00 €
53543	337	13,80 €
53545	180	35,70 €
53547	56	14,70 €
53548	56	15,60 €
53549	56	14,30 €
53550	56	14,70 €
53551	374	16,00 €
53552	374	16,00 €
53553	374	16,00 €
53561	365	28,00 €
53565	24	258,00 €
53566	304	32,00 €
53567	161	43,00 €
53568	133	12,00 €
53569	133	18,00 €
53570	136	154,00 €
53572	161	348,00 €
53573	151	36,00 €
53574	31	47,00 €
53575	55	16,00 €
53576	153	189,00 €

REF.	PAGE	PRIX
53581	164, 348	119,00 €
53582	164, 348	174,00 €
53583	164, 348	174,00 €
53584	338, 348	119,00 €
53585	338, 348	168,00 €
53586	338, 348	168,00 €
53587	173	44,00 €
53588	146	178,00 €
53589	70	12,00 €
53590	321	1.190,00 €
53591	64	5,50 €
53592	312	25,00 €
53593	160	41,00 €
53594	163	54,00 €
53595	163	61,00 €
53596	376	3,65 €
53597	376	3,70 €
53598	376	3,95 €
53599	221, 389	30,30 €
53602	61	30,50 €
53603	61	45,00 €
53604	61	118,00 €
53605	372	141,00 €
53606	158	55,00 €
53608	148	98,00 €
53609	302	182,50 €
53610	302	294,00 €
53611	156	27,50 €
53612	310	96,00 €
53613	68	19,50 €
53614	68	21,50 €
53615	68	34,60 €
53616	68	10,40 €
53617	68	9,25 €
53618	68	13,90 €
53620	89	88,00 €
53621	355	2,50 €
53622	355	2,50 €
53623	355	2,50 €
53624	355	2,50 €
53625	160	68,00 €
53626	154, 184	18,00 €
53627	305	22,50 €
53629	164	14,30 €
53630	164	18,80 €
53631	164	33,50 €
53632	164	46,00 €
53633	164	46,00 €
53634	164	63,00 €
53635	225	85,00 €
53636	354	22,00 €
53637	215	85,00 €
53638	222	243,00 €
53639	47	28,60 €
53640	47	34,40 €
53641	47	41,00 €
53642	47	54,00 €

REF.	PAGE	PRIX
53643	47	92,00 €
53644	303	1.238,00 €
53645	303	268,00 €
53646	153	69,00 €
53648	290	107,00 €
53649	291	89,00 €
53650	212	47,00 €
53651	280	91,00 €
53652	237	53,00 €
53653	264	207,00 €
53654	47	81,00 €
53655	182	12,00 €
53656	334	198,00 €
53657	334	248,00 €
53658	334	99,00 €
53659	334	121,00 €
53660	334	146,00 €
53661	77	790,00 €
53662	214	89,00 €
53663	235	8,00 €
53664	238	38,00 €
53665	238	19,00 €
53666	238	28,00 €
53667	35	32,00 €
53668	35	34,00 €
53669	215	45,00 €
53670	202	29,50 €
53671	51, 89	41,00 €
53672	82	440,00 €
53673	183	80,00 €
53674	94	447,00 €
53675	186	50,00 €
53676	186	44,00 €
53677	186	55,00 €
53678	186	52,00 €
53681	149	743,00 €
53682	322	98,00 €
53683	196	116,00 €
53684	321	1.880,00 €
53685	189	310,00 €
53686	77	790,00 €
53687	328	298,00 €
53688	328	495,00 €
53689	147	238,00 €
53690	137	34,00 €
53691	137	36,00 €
53693	360	521,00 €
53694	54	18,40 €
53695	360	504,00 €
53696	209	22,00 €
53697	302	398,00 €
53698	360	717,00 €
53701	240	188,00 €
53702	97	28,50 €
53703	97	41,00 €
53704	97	42,00 €
53705	191	80,00 €

REF.	PAGE	PRIX
53706	291	98,00 €
53707	136	153,00 €
53708	74, 76, 77, 83	325,00 €
53710	404	16,00 €
53711	404	16,00 €
53712	403	16,00 €
53713	403	16,00 €
53714	403	16,00 €
53715	402	19,00 €
53716	402	19,00 €
53717	402	19,00 €
53718	401	19,00 €
53719	401	19,00 €
53720	401	19,00 €
53721	355	18,80 €
53724	332	46,00 €
53725	314	248,00 €
53726	148	128,00 €
53727	23	198,00 €
53728	23	198,00 €
53729	184	19,10 €
53733	147	238,00 €
53734	130	23,70 €
53735	203	44,00 €
53736	189	98,00 €
53737	45	12,50 €
53738	45	10,90 €
53739	45	10,50 €
53740	45	9,10 €
53741	204	14,00 €
53742	223	1.325,00 €
53743	32, 175	39,70 €
53744	170	63,00 €
53745	362	6,40 €
53746	362	6,40 €
53747	362	6,40 €
53748	362	6,60 €
53749	362	6,70 €
53750	362	6,70 €
53751	362	6,80 €
53752	362	6,95 €
53753	362	7,10 €
53754	362	7,40 €
53755	362	7,50 €
53756	362	7,90 €
53757	362	7,90 €
53758	362	8,20 €
53759	362	8,50 €
53760	362	9,60 €
53761	77	490,00 €
53762	77	490,00 €
53767	77	790,00 €
53768	77	490,00 €
53769	80, 297, 300	178,00 €
53770	80, 298, 300	198,00 €
53771	80, 299, 300	158,00 €

REF.	PAGE	PRIX
53772	80, 299, 300	229,00 €
53773	80, 297, 300	298,00 €
53774	80, 298, 300	190,00 €
53775	80, 300	1.109,00 €
53776	131	19,10 €
53778	354	4,50 €
53779	318	36,00 €
53780	132	14,50 €
53781	377	18,00 €
53782	96	14,00 €
53784	150	148,00 €
53785	376	4,80 €
53786	380	98,00 €
53791	378	4,80 €
53794	376	28,00 €
53796	380	76,00 €
53797	377	0,10 €
53802	380	120,00 €
53806	380	250,00 €
53808	379	16,50 €
53809	379	8,00 €
53811	379	8,90 €
53826	378	16,00 €
53827	378	32,00 €
53832	378	1,81 €
53838	380	38,00 €
53839	379	0,25 €
53845	318	64,00 €
53849	312	16,10 €
53850	123	14,90 €
53851	125	88,00 €
53852	125	207,00 €
53853	125	14,40 €
53854	125	27,00 €
53855	125	24,80 €
53856	125	62,00 €
53857	126	27,00 €
53858	126	28,80 €
53859	124	67,00 €
53860	124	3,65 €
53861	124	5,45 €
53862	377	6,00 €
53863	377	3,00 €
53864	369	138,00 €
53867	82	1.095,00 €
53868	74	1.090,00 €
53869	75	990,00 €
53870	75	990,00 €
53872	348	118,00 €
53873	307	285,00 €
53874	307	398,00 €
53875	216	134,00 €
53876	259	64,00 €
53877	411	430,50 €
53878	411	574,00 €
53879	411	838,50 €

REF.	PAGE	PRIX
53880	320	598,00 €
53881	164, 348	79,00 €
53882	164, 348	79,00 €
53883	50	18,40 €
53884	50	30,20 €
53885	50	35,70 €
53886	50	20,30 €
53887	50	30,30 €
53888	50	37,90 €
53895	317	107,00 €
53896	317	127,00 €
53897	317	140,00 €
53898	317	148,00 €
53902	378	25,00 €
53903	97	59,00 €
53904	77	790,00 €
53905	56	7,30 €
53906	56	8,65 €
53908	56	7,25 €
53909	56	9,70 €
53910	392	19,00 €
53911	57	8,80 €
53912	75	1.280,00 €
53913	75	1.280,00 €
53914	379, 412	75,00 €
53915	22	65,00 €
53917	54	9,00 €
53919	363	81,00 €
53921	190	39,00 €
53922	190	29,00 €
53927	329	66,00 €
53928	26	278,00 €
53929	329	95,00 €
53932	61	8,00 €
53939	74	1.280,00 €
53940	79, 344, 346, 379	13,20 €
53942	79, 344, 346, 379	0,50 €
53943	54, 86	21,50 €
53944	54, 86	19,50 €
53945	54, 86	18,90 €
53946	377	0,83 €
53947	336	145,00 €
53948	336	324,00 €
53949	409	4,50 €
53950	409	4,50 €
53951	80, 300	1.794,00 €
53952	80, 300	1.794,00 €
53953	20	29,00 €
53954	45	8,50 €
53955	45	10,00 €
53956	408	353,00 €
53957	377	0,26 €
53958	98	6,50 €
53964	364	9,65 €
53965	364	25,80 €
53967	57	10,20 €

REF.	PAGE	PRIX
53968	314	49,00 €
53969	323	96,00 €
53970	343	3.790,00 €
53972	52	550,00 €
53973	408	284,00 €
53974	134	38,00 €
53976	61	9,00 €
53977	332	17,50 €
53978	195	38,90 €
53979	45, 88	34,60 €
53980	45, 88	34,60 €
53981	333	143,00 €
53982	333	219,00 €
53983	188	215,00 €
53984	374	8,00 €
53985	374	8,00 €
53986	374	8,00 €
53987	344, 379	9,50 €
53988	173	101,00 €
53992	392	18,00 €
53993	66	77,00 €
53997	211	48,00 €
53999	127	2,00 €
54000	127	2,50 €
54001	317	285,00 €
54002	127	3,00 €
54003	238	104,00 €
54004	133	16,00 €
54005	46	14,00 €
54006	77	490,00 €
54008	127	3,50 €
54010	127	4,50 €
54011	127	5,00 €
54013	369	35,00 €
54015	57	10,20 €
54016	211	76,00 €
54017	182	12,00 €
54018	49	9,85 €
54019	49	17,90 €
54021	49	13,50 €
54022	49	9,95 €
54023	49	13,50 €
54024	49	17,90 €
54028	49	28,00 €
54029	49	28,00 €
54030	49	18,80 €
54031	49	19,30 €
54032	39, 88	84,00 €
54033	161	49,00 €
54034	9	178,00 €
54035	12	149,00 €
54036	13	99,00 €
54037	14	88,00 €
54038	15	88,00 €
54039	135	154,00 €
54040	330	240,00 €
54041	40	198,00 €

REF.	PAGE	PRIX
54042	358	13,00 €
54043	408	48,00 €
54044	143	99,00 €
54045	9	179,00 €
54046	12	150,00 €
54047	13	100,00 €
54048	14	89,00 €
54049	15	89,00 €
54050	306	895,00 €
54051	308	39,00 €
54053	342	248,00 €
54054	342	268,00 €
54055	342	220,00 €
54056	342	260,00 €
54057	342	248,00 €
54058	342	348,00 €
54059	343	428,00 €
54060	55	6,00 €
54061	55	6,00 €
54066	39, 87	83,00 €
54068	200	120,00 €
54069	221	29,50 €
54070	55	18,00 €
54071	55	26,50 €
54072	358	38,50 €
54073	363	70,00 €
54074	363	18,50 €
54076	409	9,00 €
54078	144	68,00 €
54079	41	83,00 €
54080	96	53,50 €
54081	43	28,00 €
54082	11	189,00 €
54083	49	9,75 €
54084	49	13,10 €
54085	49	17,80 €
54086	49	9,25 €
54087	49	17,30 €
54088	135	132,00 €
54089	65	17,50 €
54090	21	56,00 €
54091	35, 345	441,00 €
54092	291	24,00 €
54093	35, 79, 87, 345, 346	441,00 €
54097	41	38,90 €
54098	47	158,50 €
54099	66	13,80 €
54100	302	265,00 €
54101	38	61,00 €
54105	21	33,00 €
54106	17, 46	89,00 €
54108	18	66,00 €
54109	20	34,00 €
54110	40	46,00 €
54111	333	4,75 €
54112	62	18,00 €
54113	333	7,65 €

REF.	PAGE	PRIX
54114	79, 330, 346	248,00 €
54115	43	26,80 €
54116	18	66,00 €
54117	38	74,00 €
54119	44	78,00 €
54120	41	59,00 €
54122	131	38,00 €
54123	131	40,00 €
54124	131	47,00 €
54125	337	152,00 €
54126	54	39,00 €
54129	79, 346	110,00 €
54130	79, 345, 346	58,00 €
54131	345	58,00 €
54132	79, 346	190,00 €
54133	135	547,00 €
54134	78, 84	1.415,00 €
54135	197	82,00 €
54136	372	107,00 €
54137	315	288,00 €
54139	218	147,00 €
54140	17	36,00 €
54141	22	42,00 €
54142	62	15,20 €
54143	318	249,00 €
54144	318	298,00 €
54145	318	377,00 €
54146	318	492,00 €
54147	318	198,00 €
54149	42	60,00 €
54150	42	23,50 €
54151	374	9,00 €
54152	374	9,00 €
54153	374	9,00 €
54154	29	37,50 €
54155	374	8,00 €
54156	374	8,00 €
54157	374	8,00 €
54158	86	38,00 €
54159	43	47,00 €
54160L	143	17,50 €
54160R	143	17,50 €
54161	142	90,00 €
54162	142	81,00 €
54163	142	80,00 €
54164	29	34,00 €
54166	363	32,40 €
54168	20	49,00 €
54169	363	13,80 €
54170	363	16,50 €
54172	137	81,00 €
54173	137	87,00 €
54174	41	139,00 €
54175	326	34,00 €
54176	350	188,00 €
54177	374	16,00 €

REF.	PAGE	PRIX
54178	374	16,00 €
54179	374	16,00 €
54181	310	25,10 €
54182	310	34,70 €
54183	310	38,20 €
54184	310	44,00 €
54186	206	250,00 €
54187	46	39,30 €
54188	376	19,00 €
54189	376	19,00 €
54190	376	19,00 €
54191	376	19,00 €
54192	375	8,90 €
54193	375	8,90 €
54194	375	8,90 €
54195	375	8,90 €
54198	372	59,00 €
54199	292	94,00 €
54200	296	56,00 €
54201	264	37,60 €
54202	246	68,00 €
54203	247	91,00 €
54204	265	124,00 €
54205	281	49,00 €
54206	252	113,00 €
54207	270	38,90 €
54208	265	76,00 €
54209	265	29,70 €
54210	276	84,00 €
54211	247	74,00 €
54212	247	39,40 €
54213	260	19,80 €
54214	281	96,00 €
54215	248	57,00 €
54216	248	49,00 €
54217	281	104,00 €
54218	292	142,00 €
54219	253	60,00 €
54220	208	197,00 €
54221	282	111,00 €
54222	253	59,00 €
54223	266	149,00 €
54224	266	64,50 €
54225	276	133,00 €
54226	295	71,00 €
54227	253	122,00 €
54228	254	187,00 €
54229	337	48,00 €
54230	337	68,00 €
54231	337	138,00 €
54232	337	248,00 €
54233	79, 346	1.856,00 €
54234	79, 346	1.856,00 €
54235	79, 346	1.856,00 €
54236	79, 346	1.856,00 €
54237	78	1.887,00 €
54238	78	1.887,00 €

REF.	PAGE	PRIX
54239	78	1.887,00 €
54240	78	1.887,00 €
54241	79, 346	120,00 €
54246	182	104,00 €
54247	182	99,00 €
54248	158	58,00 €
54249	158	103,00 €
54250	10	188,00 €
54251	157	43,00 €
54252	340	199,00 €
54253	227	166,00 €
54254	62	43,00 €
54255	156, 312	68,00 €
54256	330	48,00 €
54257	319	318,00 €
54258	19	58,00 €
54260	266	277,00 €
54261	24	321,00 €
54262	323	88,00 €
54263	323	130,00 €
54264	323	240,00 €
54265	343	1.290,00 €
54266	29	39,50 €
54267	133	9,50 €
54269	51	56,00 €
54270	136	42,00 €
54271	136	54,00 €
54273	214	10,10 €
54274	214	11,00 €
54275	214	13,20 €
54277	19	53,50 €
54278	409	4,50 €
54279	58	6,00 €
54280	237	156,50 €
54288	259	72,50 €
54289	277	38,00 €
54290	306	4.307,00 €
54291	220	5.054,00 €
54293	254	17,50 €
54294	374	8,00 €
54295	81	500,00 €
54296	81	520,00 €
54297	81	540,00 €
54298	354	7,50 €
54299	227	227,00 €
54302	53	11,50 €
54304	50	26,00 €
54305	351	232,50 €
54306	352	219,50 €
54308	352	89,00 €
54309	352	71,00 €
54310	352	57,00 €
54311	58	13,00 €
54312	210	191,50 €
54313	126	43,00 €
54314	126	82,00 €
54316	172	182,00 €

REF.	PAGE	PRIX
54317	226	124,00 €
54318	271	105,00 €
54321	343	898,00 €
54322	344, 379	19,00 €
54323	259	119,00 €
54324	257	11,00 €
54325	409	22,50 €
54326	79, 344, 346, 379	7,30 €
54327	72	2.788,00 €
54328	94	199,00 €
54329	371	37,50 €
54330	58	12,50 €
54331	65	27,00 €
54336	150	259,00 €
54338	39	60,00 €
54339	51	273,00 €
54340	147	296,00 €
54341	335	643,00 €
54342	335	858,00 €
54343	53	31,00 €
54344	132	10,50 €
54345	206	15,00 €
54346	127	11,50 €
54347	214	46,00 €
54348	126	291,00 €
54349	325	8,00 €
54350	325	12,50 €
54351	325	14,00 €
54352	325	18,00 €
54353	325	23,50 €
54354	325	34,50 €
54355	325	12,00 €
54356	326	19,50 €
54357	325	15,00 €
54358	325	18,50 €
54359	326	14,00 €
54360	325	14,00 €
54361	325	14,00 €
54362	326	14,00 €
54363	325	14,00 €
54364	326	14,00 €
54365	325	12,50 €
54366	326	18,50 €
54367	306	729,00 €
54368	219	2.329,00 €
54369	374	16,00 €
54370	374	16,00 €
54371	374	16,00 €
54372	198	157,00 €
54373	210	395,00 €
54374	96	75,50 €
54376	58	12,00 €
54379	131	28,00 €
54380	233	119,00 €
54381	233	5,00 €
54382	233	5,00 €
54383	233	5,00 €

REF.	PAGE	PRIX
54384	222	32,50 €
54386	324, 346	5.839,00 €
54388	93	366,00 €
54389	76	790,00 €
54390	389	199,00 €
54391	207	221,00 €
54392	207	1.855,00 €
54393	95	92,00 €
54394	95	64,00 €
54395	95	53,00 €
54396	320	2.250,00 €
54397	147	249,00 €
54398	254	41,00 €
54399	255	56,50 €
54400	255	141,00 €
54401	255	57,00 €
54402	256	201,00 €
54403	256	225,00 €
54404	256	131,00 €
54405	257	111,00 €
54406	257	73,00 €
54407	292	59,50 €
54408	293	46,00 €
54409	293	32,00 €
54410	293	33,50 €
54411	294	36,00 €
54412	294	57,00 €
54413	294	115,00 €
54414	272	97,50 €
54415	272	60,00 €
54416	272	31,00 €
54417	273	153,00 €
54418	273	37,00 €
54419	262	57,00 €
54420	263	102,00 €
54421	263	52,00 €

REF.	PAGE	PRIX
54422	267	140,00 €
54423	268	108,00 €
54424	263	64,50 €
54425	268	124,00 €
54426	268	69,00 €
54427	269	113,00 €
54428	269	31,00 €
54429	269	55,00 €
54430	248	34,00 €
54431	295	184,00 €
54432	260	43,00 €
54433	260	18,00 €
54434	282	48,50 €
54435	282	14,50 €
54436	283	124,00 €
54437	283	110,00 €
54438	277	40,00 €
54439	277	32,50 €
54479	59	36,50 €
54480	409	1,00 €
54482	334	677,00 €
54483	325	14,00 €
54484	325	26,00 €
54485	325	36,00 €
54486	325	9,50 €
54487	326	15,00 €
54488	325	15,00 €
54489	326	19,50 €
54490	326	15,00 €
54491	326	17,50 €
54492	326	19,50 €
54493	325	13,50 €
54494	325	14,00 €
54495	326	18,00 €
54496	326	16,50 €
54497	326	12,50 €

REF.	PAGE	PRIX
54498	309	6.090,00 €
54501	80, 300	1.794,00 €
54502	80, 300	1.794,00 €
54503	76	490,00 €
54534	355	24,00 €
60001	116	88,00 €
60003	116	110,00 €
60004	117	79,00 €
60005	105	132,00 €
60006	106	182,00 €
60007	111	170,00 €
60009	108	168,00 €
60010	111	170,00 €
60011	112	175,00 €
60012	122	48,00 €
60013	122	80,00 €
60015	122	138,00 €
60016	122	49,00 €
60017	122	64,00 €
60019	110	178,00 €
60020	110	175,00 €
60022	112	470,00 €
60023	106	212,00 €
60024	105	190,00 €
60025	105, 122	31,60 €
60026	105, 122	3790 €
60027	118	99,00 €
60028	109	142,00 €
60029	119	240,00 €
60030	119	112,00 €
60031	120	142,00 €
60032	113	123,00 €
60033	108	104,00 €
60035	117	30,00 €
60037	114	222,00 €
60038	113, 312	255,00 €

REF.	PAGE	PRIX
60039	118	265,00 €
60040	120	440,00 €
60041	114	77,00 €
60042	115	106,00 €
60043	115	123,00 €
60044	103	330,00 €
60044C	103	485,00 €
60045	121	298,00 €
60046	102	174,00 €
60046C	102	339,00 €
60047C	107	318,00 €
60048	104	366,00 €
60048C	104	560,00 €
60049C	109	329,00 €
70001	406	35,00 €
70002	406	35,00 €
70003	406	35,00 €
70004	406	42,00 €
70005	406	42,00 €
70006	406	42,00 €
70009	406	35,00 €
70011	406	42,00 €
70012	406	42,00 €
70013	406	44,00 €
70014	406	44,00 €
70015	406	44,00 €
70016	406	44,00 €
70017	406	44,00 €
90003	160	35,20 €
90004	160	25,80 €
JBMW-BEXP	362	24,50 €
METEXP	361, 406, 410	62,00 €
SERIE124	360	710,00 €
SERIE262	154, 184	199,00 €





www.jbmfrance.fr

