



**JBM<sup>®</sup>**

**VOTRE OUTIL 2023**

## COFFRETS D'OUTILS

5

MAIETTES À OUTILS  
MAIETTES EN ALUMINIUM  
AUTOCLÉ  
COFFRETS DE DOUILLES  
COFFRETS DE POINTES  
MAIETTES DE POINTES  
ADAPTATEURS  
COFFRET MINI AVEC CLIQUET  
JEUX DE DOUILLES  
JEUX DE POINTES  
OUTILS ISOLÉS



## OUTILLAGE À MAIN

33

CLÉS  
OUTILS EN POUCHES  
TOURNEVIS  
MESURE  
CADENAS  
MARTEAUX  
SCIES  
BURINS  
RIVETEUSES  
CLIQUETS  
BARRES D'EXTENSION  
OUTILS D'INSPECTION  
COUPE-TUBE  
PINCE À DÉNUDER  
PINCES  
CLÉS À CROCHET / CASSE-ÉCROU  
/ ANGLAISES  
CLÉS STILLSON / SERGENT



## MOBILIER D'ATELIER

65

SERVANTES D'OUTILS  
MODULES D'OUTILS  
ACCÉSSOIRES  
/ RECHANGE POUR SERVANTE  
ARMOIRES  
ACCÉSSOIRES POUR TABLES  
TABLES DE TRAVAIL  
CAISSE À OUTILS  
TABOURETS / BRANCARDS  
ENCLUMES / ÉTAUX



## OUTILLAGE ÉLECTROPORTATIF (À BATTERIE)

87

CLÉS À CHOC  
CLIQUET / VISSEUSE  
PERCEUSE À IMPACT  
MEULEUSE  
SCIES  
MULTI-OUTILS OSCILLANT  
PISTOLETS  
ASPIRATEUR / COMPRESSEUR  
ILLUMINATION LED  
JARDINERIE  
STOCKAGE  
BATTERIES / CHARGEURS  
ACCÉSSOIRES /  
CONSOMMABLES



## ÉCLAIRAGE

113

BALADEUSES D'ATELIER  
BALADEUSES DE LUMIÈRE FRONTALE  
LOUPES LED / LANTERNES  
PROJECTEURS LED / ALLIGNEURS DE PHARES  
/ ALLUME-CIGARE ET TRANSFORMATEURS  
BARRES LED  
LAMPE LED INDUSTRIELLE  
GYROPHARES  
AVISEUR ACOUSTIQUE  
PHARES DE TRAVAIL  
POUR REMORQUE  
AMPOULES VOITURE



## OUTILLAGE PNEUMATIQUE

131

CLÉS À CHOC  
POUR CAMIONS  
PERCEUSES / CLIQUETS  
COUPEUSES / KIT DE POLISSAGE  
MEULEUSES  
DÉMONTÉ PNEUS  
PONCEUSES ORBITALE / PONCEUSES  
MARTEAUX PNEUMATIQUES  
DISQUES DE COUPE / PRÉSENTOIRS  
PISTOLETS DE GONFLAGE / DPF  
FILTRES D'AIR / HUILES LUBRIFIANTES  
MULTIPLS PISTOLETS  
ENROULEUR DE TUYAU D'AIR  
TUYAUX D'AIR / CONNECTEURS  
ADAPTATEURS / CROCHETS



## OUTILLAGE À CHOC

149

SET DE DOUILLES D'IMPACT  
BARRES D'EXTENSION  
/ ARTICULATIONS D'IMPACT  
SETS DE POINTES  
ADAPTATEURS D'IMPACT  
/ DOUILLES D'IMPACT DE 3/4" ET 1"  
OUTILLAGE D'IMPACT  
POUR VÉHICULES LOURDS



## CARROSSERIE

159

POUR CARROSSERIE  
POUR PHARES  
CASQUES POUR SOUDURES / SET DE LEVIERS  
JEU POUR OUVRIR LES VOITURES /  
REMPLACEMENT DE PARE-BRISE  
TENAILLES  
PISTOLET À COLLE / VENTOUSES  
RUBAN DE FIXATION / SERVANTE ET STOCKAGE  
CHANDELLES / SUPPORTS  
MAINTIEN DU VÉHICULE / PRÉSENTOIRS  
TIPS DE SOL  
PLATE-FORME EN ALUMINIUM



## FREINS

173

REPOUSSE PISTON DE FREIN  
RÉPARATION / MAINTIEN  
/ PURGEUR DE FREIN



## OUTILLAGE

177

SYSTÈME DE LUBRIFICATION  
SYSTÈME D'INJECTION  
RÉPARATEUR DE BOUGIES  
COMPRESSIOMÈTRE  
RÉCHAUFFEURS  
EXTRACTEURS  
DINAMOMÉTRIQUES  
MULTIPLACATEURS DE FORCE  
/ EMBRAYAGE  
SYSTÈME AACC  
SYSTÈME DE RÉFÉRIÉRATION  
CROSSE / VALVES  
COMPRESSEUR DE RESSORT  
DIVERS  
ORGANISATEURS / PLATEAUX  
COUPEUSES DE CADENAS /  
BROSSES



## COFFRET DE CALAGE

217

BMW  
MERCEDES  
VAG  
RENAULT / NISSAN  
FORD / MAZDA  
JAGUAR / LAND ROVER  
OPEL / VAUXHALL  
CITROËN / PEUGEOT  
DIVERS  
SERVANTE D'OUTILS AVEC OUTILS  
POUR RÉGLER LA SYNCHRONISATION  
OUTILS SPÉCIAUX



## LUBRIFICATION

247

CRIC ROULEUR  
CRIC BOUTEILLE  
CHANDELLES  
PORTE-ROUES  
PRESSES  
GRUES  
SUPPORT POUR MOTEURS  
POUR MOTO  
TRANSPALETTE



## OUTILLAGES HYDRAULIQUES

259

CRIC ROULEUR  
CRIC BOUTEILLE  
CHANDELLES  
PORTE-ROUES  
PRESSES  
GRUES  
SUPPORT POUR MOTEURS  
POUR MOTO  
TRANSPALETTE



## OUTILLAGE ÉLECTRIQUE

271

BOOSTER DE VÉHICULE  
CHARGEURS / TESTEUR DE BATTERIE  
AMPÈREMÈTRE  
THERMOMÈTRE  
ENDOSCOPE  
SOUDEURS  
MEULEUSE DE TABLE  
NETTOYEURS DE PIÈCES  
ASPIRATEURS  
RÉCHAUFFEURS / TONDEUSE ROBOT  
NETTOYEUR HAUTE PRESSION  
ENROULEUR DE CÂBLE ÉLECTRIQUE  
VENTILATEURS



## ÉNERGIE RENOUVELABLE ET MO- BILITÉ DE DEMAIN

285

STATION D'ÉNERGIE PORTATILE  
Panneaux SOLAIRES  
VOITURE ÉLECTRIQUE / CÂBLES  
ACCESSOIRES  
OUTILLAGES ISOLÉS



## ACCÉSSOIRES

291

ENROULEURS  
ESCALIERS  
SERVANTES  
ORGANISATEURS  
POUR VOITURE  
KIT D'URGENCE / TROUSSES DE  
PREMIERS SOINS  
CAPTEUR DE STATIONNEMENT  
TAPIS  
BALAIS D'ESSUIE-GLACE  
MASSES D'ÉQUILIBRAGE  
VALVES TPMS  
POUR PNEUMATIQUES  
SOUFFLET DE PALIER POUR TOURISME  
UNIVERSEL / OUTIL PNEUMATIQUE DE  
MONTAGE DE SOUFFLET DE PALIER



## SÉCURITÉ ET EPI

315

GANTS / EPIS  
TROUSSES DE PREMIERS SOINS  
MASQUES / DISPENSEURS  
CAMÉRA THERMIQUE /  
THERMOMÈTRES / DÉTERGENTS  
DE SURFACE / NETTOYANTS  
DISTANCE DE SÉCURITÉ  
DÉSINFECTION D'ESPACES /  
OZONEMÈTRE



## CONSOMMABLES

323

PASSE-CÂBLES / GOUPILLES  
LANGUETTES / VIS ET ÉCROUS  
RIVETS  
RONDELLES  
OBUS  
O-RING / TUBES  
THERMORÉTRACTABLE  
RACCORDS DE TUYAU  
/ GRAISSEURS  
PINCES / RESSORTS / FUSIBLES  
COSSES  
CLIPS EN PLASTIQUE



## VÊTEMENTS

345

GILET  
BLOUSON



## PLV

347

APPAREILS  
ÉLECTRONIQUES JBM  
PROMOTIONNELS  
PRÉSENTOIRS ET  
ACCESSOIRES  
EMBALLAGE





**JBM est votre marque d'outils professionnels**  
Entreprise leader spécialisée dans l'industrie et l'automobile

**+5.000** PRODUITS DISPONIBLES

**+20.000** EUROPALETTES EN STOCK

**+450** NOUVEAUX PRODUITS PAR AN

**+55** NOUS EXPORTONS VERS PLUS DE 55 PAYS

**UN SERVICE DE QUALITÉ SOUTENU PAR PLUS DE 11 000 CLIENTS**

▶ **PLUS DE 30 ANS D'EXPÉRIENCE DANS LE SECTEUR**  
Chez JBM, nous sommes des spécialistes de la distribution d'outils et d'équipements automobiles, offrant un service de proximité et de qualité à nos plus de 11 000 clients répartis dans plus de 55 pays.

▶ **EXPERTS EN DISTRIBUTION ET LOGISTIQUE**  
JBM dispose d'un réseau logistique en constante amélioration, qui permet une distribution rapide et efficace non seulement dans la péninsule ibérique mais aussi à tous les clients internationaux.

▶ **LARGE GAMME DE PRODUITS**  
Nous vous proposons une gamme complète de plus de 4 000 références en caisses à outils, mallettes à outils, outillage à main en tous genres, armoires à outils, outillage d'atelier, éclairage, mallettes consommables...



**LIVRAISON EN 24-48H EN PENINSULE IBÉRIQUE ET EN FRANCE**

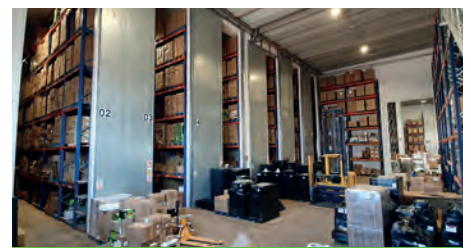

**SIÈGE SOCIAL EN ESPAGNE ET ENTREPÔT DE PLUS DE 6 000 M<sup>2</sup>**





## **COFFRETS D'OUTILS**

- 7 MALETTES À OUTILS OUTILS
- 20 MALETTES EN ALUMINIUM
- 23 AUTOCLÉ
- 24 COFFRETS DE DOUILLES
- 25 COFFRETS DE POINTES
- 27 MALETTES DE POINTES
- 28 ADAPTATEURS
- 29 COFFRET MINI AVEC CLIQUET
- 29 JEUX DE DOUILLES
- 29 JEUX DE POINTES
- 31 OUTILS ISOLÉS

# SURFACES DE QUALITÉ

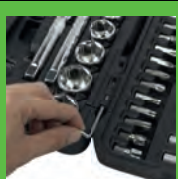

DIVISIBLE EN  
DEUX POUR UNE  
MEILLEURE  
ORGANISATION



JOINTS  
MÉTALLIQUES  
AMÉLIORÉS



POIGNÉE EN  
CAOUTCHOUC  
POUR UN  
TRANSPORT  
FACILE



# COFFRET DE DOUILLES

216 PIÈCES 6 PANS

54034

178,00€



ACIER ZINGUÉ

54045

179,00€



CHROMÉ

ACIER S2

CrV

216 PCS

**54034**

PIÈCES DE RECHANGE DISPONIBLES



**54045**

PIÈCES DE RECHANGE DISPONIBLES



## CONTIENT

	<b>1/2"</b> x14	13, 14, 15, 16, 17, 18, 19, 20, 21, 22, 24, 27, 30, 32mm
	<b>3/8"</b> x10	10, 11, 12, 13, 14, 15, 16, 17, 18, 19mm
	<b>1/4"</b> x13	4, 4.5, 5, 5.5, 6, 7, 8, 9, 10, 11, 12, 13, 14mm
	<b>1/2"</b> x5	16, 17, 18, 19, 22mm
	<b>3/8"</b> x6	10, 11, 12, 13, 14, 15mm
	<b>1/4"</b> x7	4, 5, 6, 7, 8, 9, 10mm
	<b>1/2"</b> x3	E20, E22, E24
	<b>3/8"</b> x6	E10, E11, E12, E14, E16, E18
	<b>1/4"</b> x5	E4, E5, E6, E7, E8
	<b>T2</b> x3	1/2" - 3/8" - 1/4"
	<b>1/2"</b> x2	125, 250mm
	<b>3/8"</b> x1	125mm
	<b>1/4"</b> x2	50, 100mm
	x3	1/2" - 3/8" - 1/4"
	<b>1/2"</b> x1	adaptateur 3/8" H x 1/2" M

	<b>1/2"</b> x1	8mm
	<b>3/8"</b> x1	8mm
	<b>1/4"</b> x1	6mm
	<b>1/2"</b> x2	16, 21mm
	<b>3/8"</b> x1	18mm
	<b>1/2"</b> x12	8, 9, 10, 11, 12, 13, 14, 15, 16, 17, 18, 19mm
	<b>1/2"</b> x7	1.27, 1.5, 2, 2.5, 3, 4, 5mm
	<b>1/4"</b> x1	
	<b>1/4"</b> x1	
	<b>1/4"</b> x1	
	<b>1/2"</b> x1	T70
	<b>1/2"</b> x1	14mm
	<b>1/4"</b>	x3 PH0, PH1, PH2
		x3 PZ0, PZ1, PZ2
		x4 3, 4, 5, 6mm
		x4 SL4, SL5.5, SL6.5, SL7
		x8 T8, T9, T10, T15, T20, T25, T27, T30
		x8 T8, T9, T10, T15, T20, T25, T27, T30

	<b>8mm</b> x4	7, 8, 10, 12mm
	<b>6mm</b> x6	2, 2.5, 3, 4, 5, 6mm
	<b>8mm</b> x3	SL8, SL10, SL12
	<b>8mm</b> x3	PH2, PH3, PH4
	<b>8mm</b> x3	PZ2, PZ3, PZ4
	<b>8mm</b> x5	T40, T45, T50, T55, T60
	<b>6mm</b> x3	T5, T6, T7
	<b>8mm</b> x5	T40, T45, T50, T55, T60
	<b>6mm</b> x1	T7
	<b>8mm</b> x4	M10, M11, M12, M13
	<b>6mm</b> x5	M5, M6, M7, M8, M9
	<b>8mm</b> x2	M10, M12
	<b>6mm</b> x3	M5, M6, M8
	<b>8mm</b> x1	TS50
	<b>6mm</b> x8	TS10, TS15, TS20, TS25, TS27, TS30, TS40, TS45
	x4	0, 1, 2, 3mm
	x3	6, 8, 10mm
	<b>6mm</b> x4	4, 6, 8, 10mm
	x3	1, 2, 3mm
	x4	1, 2, 3, 4mm
	<b>6mm</b> x1	1/4"

# COFFRET DE DOUILLES 216 PIÈCES 12 PANS - ZINGUÉ

54250

188,00€



ACIER S2

CrV

216 PCS



PIÈCES DE RECHANGE DISPONIBLES



## CONTIENT

	<b>1/2"</b> x14	13, 14, 15, 16, 17, 18, 19, 20, 21, 22, 24, 27, 30, 32mm
	<b>3/8"</b> x10	10, 11, 12, 13, 14, 15, 16, 17, 18, 19mm
	<b>1/4"</b> x13	4, 4.5, 5, 5.5, 6, 7, 8, 9, 10, 11, 12, 13, 14mm
	<b>1/2"</b> x5	16, 17, 18, 19, 22mm
	<b>3/8"</b> x6	10, 11, 12, 13, 14, 15mm
	<b>1/4"</b> x7	4, 5, 6, 7, 8, 9, 10mm
	<b>1/2"</b> x3	E20, E22, E24
	<b>3/8"</b> x6	E10, E11, E12, E14, E16, E18
	<b>1/4"</b> x5	E4, E5, E6, E7, E8
	<b>T2</b> x3	1/2" - 3/8" - 1/4"
	<b>1/2"</b> x2	125, 250mm
	<b>3/8"</b> x1	125mm
	<b>1/4"</b> x2	50, 100mm
	x3	adaptateur 3/8" H x 1/2" M
	<b>1/2"</b> x1	

	<b>1/2"</b> x1	8mm
	<b>3/8"</b> x1	8mm
	<b>1/4"</b> x1	6mm
	<b>1/2"</b> x2	16, 21mm
	<b>3/8"</b> x1	18mm
	<b>1/2"</b> x12	8, 9, 10, 11, 12, 13, 14, 15, 16, 17, 18, 19mm
	<b>1/2"</b> x7	1.27, 1.5, 2, 2.5, 3, 4, 5mm
	<b>1/4"</b> x1	
	<b>1/4"</b> x1	
	<b>1/4"</b> x1	
	<b>1/2"</b> x1	T70
	<b>1/2"</b> x1	14mm
	x3	PH0, PH1, PH2
	x3	PZ0, PZ1, PZ2
	x4	3, 4, 5, 6mm
	x4	SL4, SL5.5, SL6.5, SL7
	x8	T8, T9, T10, T15, T20, T25, T27, T30
	x8	T8, T9, T10, T15, T20, T25, T27, T30

	<b>8mm</b> x4	7, 8, 10, 12mm
	<b>6mm</b> x6	2, 2.5, 3, 4, 5, 6mm
	<b>8mm</b> x3	SL8, SL10, SL12
	<b>8mm</b> x3	PH2, PH3, PH4
	<b>8mm</b> x3	PZ2, PZ3, PZ4
	<b>8mm</b> x5	T40, T45, T50, T55, T60
	<b>6mm</b> x3	T5, T6, T7
	<b>8mm</b> x5	T40, T45, T50, T55, T60
	<b>6mm</b> x1	T7
	<b>8mm</b> x4	M10, M11, M12, M13
	<b>6mm</b> x5	M5, M6, M7, M8, M9
	<b>8mm</b> x2	M10, M12
	<b>6mm</b> x3	M5, M6, M8
	<b>8mm</b> x1	TS50
	<b>6mm</b> x8	TS10, TS15, TS20, TS25, TS27, TS30, TS40, TS45
	x4	0, 1, 2, 3mm
	x3	6, 8, 10mm
	<b>6mm</b> x4	4, 6, 8, 10mm
	x3	1, 2, 3mm
	x4	1, 2, 3, 4mm
	<b>6mm</b> x1	1/4"



# COFFRET DE DOUILLES 132 PIÈCES 6 PANS

54082 188,00€

CrV 132 PCS

11.00	-	2	56
Kg	5/8	11	56

**SPÉCIAL  
AUTOMOBILE**



QR CODE  
PIÈCES DE  
RECHANGE  
DISPONIBLES

## CONTIENT

	<b>1/2"</b>	x7	19,21, 22, 24, 27, 30, 32mm
	<b>3/8"</b>	x11	8, 9, 10, 11, 12, 13, 14, 15, 16, 17, 18, 19mm
	<b>1/4"</b>	x10	8, 9, 10, 11, 12, 13, 14, 15, 16, 17, 18, 19mm
	<b>3/8"</b>	x4	13, 14, 15, 17 mm
	<b>1/4"</b>	x4	8, 10, 12, 13mm
	<b>3/8"</b>	x6	E8, E10, E11, E14, E16, E20
	<b>1/2"</b>	x1	
	<b>3/8"</b>	x1	
	<b>1/4"</b>	x1	
	<b>1/2"</b>	x2	125, 250mm
	<b>3/8"</b>	x2	75, 150mm
	<b>1/4"</b>	x1	50mm
		x1	Ø14mm

		x1	3/8"(H)-1/2"(M)
		x1	3/8"(H)-1/2"(M)
		x1	3/8"(H)-1/4"(M)
	<b>1/2"</b>	x1	
	<b>3/8"</b>	x1	
	<b>1/4"</b>	x1	
	<b>1/2"</b>	x3	17, 19, 22mm
	<b>1/4"</b>	x1	6mm
		x1	
		x1	PH2x100
		x1	SL6x100
		x12	8, 9, 10, 11, 12, 13, 14, 15, 16, 17, 18, 19mm
		x1	

	<b>1/2"</b>	x1	H17
	<b>1/2"</b>	x1	21mm
	<b>3/8"</b>	x2	16, 18mm
	<b>1/2"</b>	x1	T52
	<b>1/2"</b>	x1	M16
		x2	5,5, 6,5mm
		x2	PH0, PH3
	<b>3/8"</b>	x2	PZ1, PZ3
		x4	4,5,6,8mm
		x6	T20, T30, T40, T45, T50, T55
		x3	4,5,6,5mm
		x3	PH1, PH2, PH3
	<b>6mm</b>	x3	PZ1, PZ2, PZ3
		x4	3,4,5,6
		x7	T10, T15, T20, T25, T27, T30, T40
		x9	1,5, 2, 2,5, 3, 4, 5, 6, 8, 10mm
		x1	
		x1	

# COFFRET DE DOUILLES

179 PIÈCES 6 PANS

**54035** 149,00€

**54046** 150,00€

ACIER S2

CrV

179 PCS

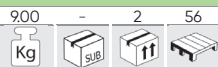

ACIER ZINGUÉ

CHROMÉ

**54035**

PIÈCES DE RECHANGE DISPONIBLES

**54046**

PIÈCES DE RECHANGE DISPONIBLES



## CONTIENT

	<b>1/2"</b> x17	10, 11, 12, 13, 14, 15, 16, 17, 18, 19, 20, 21, 22, 24, 27, 30, 32mm
	<b>3/8"</b> x10	10, 11, 12, 13, 14, 15, 16, 17, 18, 19mm
	<b>1/4"</b> x13	4, 4.5, 5, 5.5, 6, 7, 8, 9, 10, 11, 12, 13, 14mm
	<b>1/2"</b> x5	16, 17, 18, 19, 22mm
	<b>3/8"</b> x6	10, 11, 12, 13, 14, 15mm
	<b>1/4"</b> x7	4, 5, 6, 7, 8, 9, 10mm
	<b>1/2"</b> x2	E20, E24
	<b>3/8"</b> x6	E10, E11, E12, E14, E16, E18
	<b>1/4"</b> x5	E4, E5, E6, E7, E8
	<b>TZ</b> x3	1/2" - 3/8" - 1/4"
	<b>1/2"</b> x1	125mm
	<b>3/8"</b> x1	125mm
	<b>1/4"</b> x2	50, 100mm
	<b>1/2"</b> x1	250mm

	x3	1/2" - 3/8" - 1/4"
	<b>1/2"</b> x2	16, 21mm
	<b>3/8"</b> x1	18mm
	<b>1/2"</b> x1	8mm
	<b>3/8"</b> x1	8mm
	<b>1/4"</b> x1	6mm
	x7	1,27, 1,5, 2, 2,5, 3, 4, 5mm
	x1	1/4"
	x1	1/4"
	x3	PH1, PH2, PH3
	x3	PZ1, PZ2, PZ3
	<b>1/4"</b> x5	2, 3, 4, 5, 6mm
	x3	SL4, SL5.5, SL7
	x8	T8, T9, T10, T15, T20, T25, T27, T30
	x8	T8, T9, T10, T15, T20, T25, T27, T30

	<b>6mm</b> x11	T5, T6, T7, T8, T9, T10, T15, T20, T25, T27, T30
	x9	T7, T10, T15, T20, T25, T27, T30, T40, T45
	x5	M5, M6, M7, M8, M9
	x3	M5, M6, M8
	x2	PH3, PH4
	x2	PZ3, PZ4
	<b>8mm</b> x8	7, 8, 10, 12, 14mm
	x3	SL8, SL10, SL12
	x6	T40, T45, T50, T55, T60, T70
	x6	T40, T45, T50, T55, T60, T70

# COFFRET DE DOUILLES

## 113 PIÈCES 12 PANS

54036 99,00€



ACIER ZINGUÉ

54047 100,00€

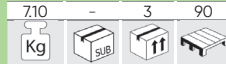

CHROMÉ

ACIER S2

CrV

113 PCS

54036



PIÈCES DE RECHANGE DISPONIBLES

54047



PIÈCES DE RECHANGE DISPONIBLES

ACIER S2



### CONTIENT

	1/2"	x17	10, 11, 12, 13, 14, 15, 16, 17, 18, 19, 20, 21, 22, 24, 27, 30, 32mm
	1/4"	x13	4, 4.5, 5, 5.5, 6, 7, 8, 9, 10, 11, 12, 13, 14mm
	1/2"	x5	14, 15, 17, 19, 22mm
	1/4"	x8	6, 7, 8, 9, 10, 11, 12, 13mm
	1/2"	x8	E10, E11, E12, E14, E16, E18, E20, E24
	1/4"	x5	E4, E5, E6, E7, E8
	T2	x2	1/2" - 1/4"
	1/2"	x2	125, 250mm
	1/4"	x2	50, 100mm

	x2	1/2" - 1/4"
	1/2"	x1 adaptateur 3/8" H x 1/2" M
	1/2"	x1 8mm
	x5	7, 8, 10, 12, 14mm
	x3	SL8, SL10, SL12
	x2	PH3, PH4
	x2	PZ3, PZ4
	x5	T40, T45, T50, T55, T60
	x5	5, 6, 8, 10, 12mm

	1/2"	x2	16, 21mm
	x3	1.5, 2, 2.5mm	
	x1	1/4"	
	x1	1/4"	
	x2	PH1, PH2	
	x2	PZ1, PZ2	
	1/4"	x4	3, 4, 5, 6mm
	x3	SL4, SL5.5, SL6.5	
	x8	T8, T10, T15, T20, T25, T27, T30	

# COFFRET DE DOUILLES

## 108 PIÈCES 6 PANS

**54037** 88,00€



**54048** 89,00€



ACIER S2

CrV

108 PCS

ACIER ZINGUÉ

CHROMÉ

54048



PIÈCES DE RECHANGE DISPONIBLES

54037



PIÈCES DE RECHANGE DISPONIBLES

ACIER S2



### CONTIENT

	<b>1/2"</b> x17	10, 11, 12, 13, 14, 15, 16, 17, 18, 19, 20, 21, 22, 24, 27, 30, 32mm
	<b>1/4"</b> x13	4, 4.5, 5, 5.5, 6, 7, 8, 9, 10, 11, 12, 13, 14mm
	<b>1/2"</b> x5	14, 15, 17, 19, 22mm
	<b>1/4"</b> x8	6, 7, 8, 9, 10, 11, 12, 13mm
	<b>1/2"</b> x8	E10, E11, E12, E14, E16, E18, E20, E24
	<b>1/4"</b> x5	E4, E5, E6, E7, E8
	<b>72</b> x2	1/2" - 1/4"
	<b>1/2"</b> x2	125, 250mm
	<b>1/4"</b> x2	50, 100mm
	x2	1/2" - 1/4"
	<b>1/2"</b> x1	adaptateur 3/8" H x 1/2" M

	<b>1/2"</b> x2	16, 21mm
	<b>1/2"</b> x1	8mm
	x3	1.5, 2, 2.5mm
	x1	1/4"
	x1	1/4"
	x2	PH3, PH4
	x2	PZ3, PZ4
	<b>8mm</b> x5	7, 8, 10, 12, 14mm
	x3	SL8, SL10, SL12
	x5	T40, T45, T50, T55, T60

	x2	PH1, PH2
	x2	PZ1, PZ2
	<b>1/4"</b> x4	3, 4, 5, 6mm
	x3	SL4, SL5.5, SL6.5
	x8	T8, T10, T15, T20, T25, T27, T30

# COFFRET DE DOUILLES

## 94 PIÈCES 6 PANS

54038

88,00€



ACIER ZINGUÉ

54049

88,00€

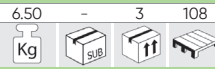

CHROMÉ

CrV

94  
PCS

54049



PIÈCES DE RECHANGE DISPONIBLES

54038



PIÈCES DE RECHANGE DISPONIBLES



ACIER  
S2



### CONTIENT

	1/2" x18	10, 11, 12, 13, 14, 15, 16, 17, 18, 19, 20, 21, 22, 23, 24, 27, 30, 32mm
	1/4" x13	4, 4.5, 5, 5.5, 6, 7, 8, 9, 10, 11, 12, 13, 14mm
	1/2" x4	14, 15, 17, 19mm
	1/4" x8	6, 7, 8, 9, 10, 11, 12, 13mm
	TZ x2	1/2" - 1/4"
	1/2" x2	125, 250mm
	1/4" x2	50, 100mm
	x2	1/2" - 1/4"
	1/2" x1	adaptateur 3/8" H x 1/2" M

	1/2" x1	8mm
	x3	1.5, 2, 2.5mm
	1/2" x2	16, 21mm
	x2	PH3, PH4
	x2	PZ3, PZ4
	8mm x4	8, 10, 12, 14mm
	x3	SL8, SL10, SL12
	x4	T40, T45, T50, T55
	8mm x1	1/4"

	x1	1/4"
	x1	1/4"
	x1	1/4"
	x2	PH1, PH2
	x2	PZ1, PZ2
	1/4" x4	3, 4, 5, 6mm
	x3	SL4, SL5.5, SL7
	x6	T8, T10, T15, T20, T25, T30

# KIT DE DOUILLES HEXAGONALES 303 PIÈCES

53212 149,00€

9,45 Kg 2 48

CHROMÉ



PIÈCES DE RECHANGE DISPONIBLES



CrV 303 PCS

1/2" 1/4"



## CONTIENT

	1/2"	x18	10, 11, 12, 13, 14, 15, 16, 17, 18, 19, 20, 21, 22, 23, 24, 27, 30, 32mm
	1/4"	x13	4, 4.5, 5, 5.5, 6, 7, 8, 9, 10, 11, 12, 13, 14mm
	1/2"	x2	1/2" - 1/4"
	1/2"	x2	125, 250mm
	1/4"	x2	50, 100mm
	1/2"	x1	8mm
	1/4"	x1	6mm
	1/2"	x1	adaptateur 3/8" H x 1/2" M
	1/2"	x2	16, 21mm
		x2	1/2" - 1/4"
		x1	1/4"
		x2	SL3.0 x 50mm, SL2.5 x 50mm
		x3	PH0x50mm, PH00x50mm, PH000x50mm
		x2	SL4.0x100mm, SL6.5x125mm
		x2	PH1x80mm, PH2x100mm

	6mm	x9	1.5, 2, 2.5, 3, 4, 5, 5.5, 6, 8mm
	6mm	x10	1/16, 5/64, 3/32, 7/64, 1/8, 9/64, 5/32, 3/16, 7/32, 1/4
	8mm	x4	H5.5, H6.5, H7, H8
	6mm	x6	5/64, 3/32, 7/64, 1/8, 9/64, 5/32
	6mm	x6	2, 2.5, 3, 4, 5, 6mm
	6mm	x9	SL3, SL4, SL4.5, SL5, SL5.5, SL6, SL6.5, SL7, SL8
	8mm	x4	SL5.5, SL6.5, SL7, SL8
	6mm	x10	PH0 (x2), PH1 (x2), PH2 (x4), PH3 (x2)
	8mm	x2	PH3, PH4
	6mm	x10	PZ0 (x2), PZ1 (x2), PZ2 (x4), PZ3 (x2)
	8mm	x2	PZ3, PZ4
	6mm	x10	T8, T10, T15, T20, T25, T27, T30, T35, T40, T45
	8mm	x8	T25, T27, T30, T35, T40 (x2), T45, T50
	6mm	x9	T8, T10, T15, T20, T25, T27, T30, T35, T40
	6mm	x3	5, 6, 8mm
	8mm	x4	5, 6, 8, 10mm

	6mm	x3	6, 8, 10
	6mm	x3	C1, C2, C3
	6mm	x4	1, 2, 3, 4
	6mm	x4	4, 6, 7, 10mm
	6mm	x4	S0, S1, S2, S3
		x7	1, 2, 2.5, 3, 4, 5mm
		x13	1.5, 2, 2.5, 3, 3.2, 3.5, 4, 4.5, 4.8, 5, 5.5, 6, 6.5mm
		x1	
		x1	
		x10	
		x1	8"
		x1	3m
		x6	SL1.5, SL2, SL2.5, SL3, SL3.5, SL4
		x4	PH000, PH00, PH0, PH1
		x2	PZ0, PZ1
		x8	T5, T6, T7, T8, T9, T10, T15, T20
		x1	
		x23	
		x22	
		x10	
		x10	

# COFFRET DE DOUILLES 82 PIÈCES 6 PANS

53647 96,00€

6,13 Kg 3 108

CHROMÉ



PIÈCES DE RECHANGE DISPONIBLES



CrV 82 PCS

1/2" 1/4"



## CONTIENT

	1/2"	x12	13, 14, 15, 16, 17, 18, 19, 22, 24, 27, 30, 32mm
	1/4"	x13	4, 4.5, 5, 5.5, 6, 7, 8, 9, 10, 11, 12, 13, 14mm
	1/2"	x2	1/2" - 1/4"
	1/2"	x2	125, 250mm
	1/4"	x2	50, 100mm
		x2	1/2" - 1/4"
	1/2"	x1	adaptateur 3/8" H x 1/2" M

	1/2"	x2	16, 21mm
	1/2"	x1	8mm
		x9	8, 10, 11, 12, 13, 14, 17, 19, 22mm
		x1	150mm
		x1	1/4"
		x1	1/4"

	8mm	x2	PH3, PH4
	8mm	x2	PZ3, PZ4
	8mm	x4	8, 10, 12, 14mm
	8mm	x3	SL8, SL10, SL12
	8mm	x4	T40, T45, T50, T55
	8mm	x1	1/4"
	1/4"	x2	PH1, PH2
	1/4"	x2	PZ1, PZ2
	1/4"	x4	3, 4, 5, 6mm
	1/4"	x3	SL4, SL5.5, SL7
	1/4"	x6	T8, T10, T15, T20, T25, T30

# COFFRET DE DOUILLES

## 74 PIÈCES 12 PANS

53074 78,00€

5.09 - 3 108



CHROMÉ



PIÈCES DE RECHANGE DISPONIBLES



74 PCS

CrV

1/2"

1/4"

### CONTIENT

	1/2"	x18	10, 11, 12, 13, 14, 15, 16, 17, 18, 19, 20, 21, 22, 23, 24, 27, 30, 32mm
	1/4"	x10	4, 5, 5.5, 6, 7, 8, 10, 11, 12, 13mm
		x2	1/2" - 1/4"
	1/2"	x2	125, 250mm
	1/4"	x1	100mm
		x1	1/2"

	1/2"	x1	adaptateur 3/8" H x 1/2" M
	1/2"	x1	21mm
		x3	1.5, 2, 2.5mm
		x1	1/4"
	1/4"	x1	6mm

	6mm	x5	PH0, PH1, PH2, PH3, PH4
		x5	PZ0, PZ1, PZ2, PZ3, PZ4
		x6	3, 4, 5, 6, 8, 10mm
		x5	SL3, SL4, SL5.5, SL6, SL7
		x8	T8, T10, T15, T20, T25, T27, T30, T40
		x4	4, 5, 6, 7mm

# COFFRET DE DOUILLES 3/8"

## DE 59 PIÈCES 12 PANS

54168 49,00€

2.60 - 10 180



PIÈCES DE RECHANGE DISPONIBLES



59 PCS

CrV

3/8"

### CONTIENT

	3/8"	x17	6, 7, 8, 9, 10, 11, 12, 13, 14, 15, 16, 17, 18, 19, 20, 21, 22mm
		x1	3/8"
	3/8"	x2	75, 150mm
	3/8"	x1	8mm
	3/8"	x1	8mm

		x1	3/8"
	8mm	x2	PH3, PH4
		x2	PZ3, PZ4
		x5	7, 8, 10, 12, 14mm
		x3	8, 10, 12mm
		x5	T40, T45, T50, T55, T60

		x1	1/4"
	1/4"	x2	PH1, PH2
		x2	PZ1, PZ2
		x4	3, 4, 5, 6mm
		x3	4, 5.5, 6.5mm
		x7	T8, T10, T15, T20, T25, T27, T30

# COFFRET DE DOUILLES DE 56 PIÈCES 6 PANS

54105 33,00€

1.25 - 10 300



PIÈCES DE RECHANGE DISPONIBLES



CrV

56 PCS

### CONTIENT

	1/4"	x13	4, 4.5, 5, 5.5, 6, 7, 8, 9, 10, 11, 12, 13, 14mm
		x1	1/4"
	1/4"	x2	50, 100mm
		x1	1/4"
		x1	1/4"

	6mm	x4	SL4, SL5, SL6, SL7
		x3	M5, M6, M8
		x8	T8, T10, T15, T20, T25, T27, T30, T40
		x8	T8, T10, T15, T20, T25, T27, T30, T40
		x1	1/4"
	1/4"	x1	6mm
	6mm	x3	PH0, PH1, PH2
		x3	PZ0, PZ1, PZ2
		x6	3, 4, 5, 6, 7, 8mm
	6mm	x1	1/4"

# KIT DE DOUILLES ET D'EMBOUS

## 130 PIÈCES

53953 29,00€

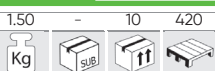

ACIER ZINGUÉ

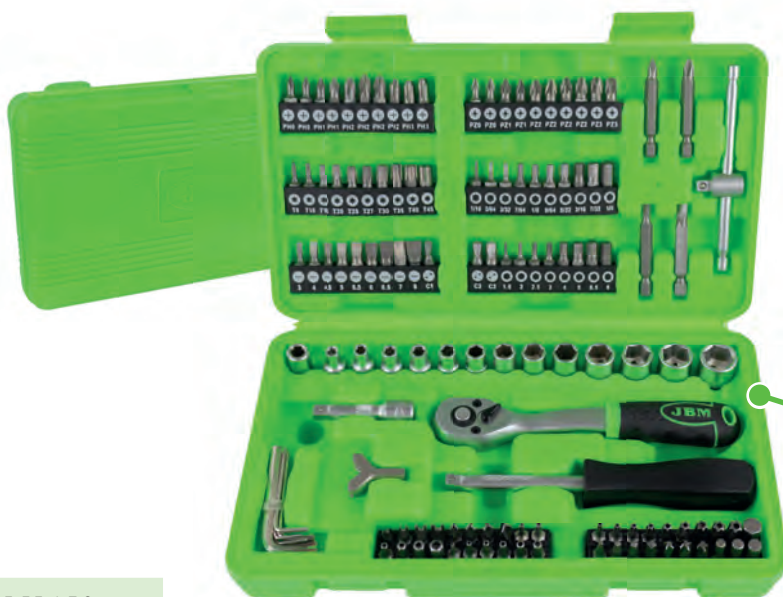
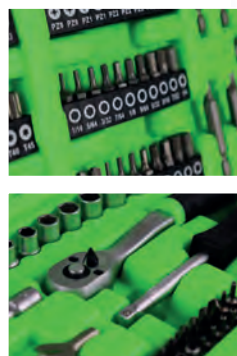

CrV 1/4" 130 PCS



PIÈCES DE RECHANGE DISPONIBLES



PRÉSENTOIR DE 10 UNITÉS

CONTIENT

	1/4" x13	4, 4.5, 5, 5.5, 6, 7, 8, 9, 10, 11, 12, 13, 14mm
	x1	1/4"
	1/4" x1	50mm
	x1	1/4"
	1/4" x1	6mm
	x1	1/4"
	x1	1/4"
	1/4" x7	1.27, 1.5, 2, 2.5, 3, 4, 5mm

	25mm x10	1/16, 5/64, 3/32, 7/64, 1/8, 9/64, 5/32, 3/16, 7/32, 1/4
	x9	1.5, 2, 2.5, 3, 4, 5, 5.5, 6, 8mm
	25mm x6	5/64, 3/32, 7/64, 1/8, 9/64, 5/32
	x6	2, 2.5, 3, 4, 5, 6mm
	25mm x9	3, 4, 4.5, 5, 5.5, 6, 6.5, 7, 8mm
	50mm x2	4, 6mm
	25mm x10	PH0(x2), PH1(x2), PH2(x4), PH3(x2)
	50mm x2	PH1, PH2
	25mm x10	PZ0(x2), PZ1(x2), PZ2(x4), PZ3(x2)

	25mm x10	T8, T10, T15, T20, T25, T27, T30, T35, T40, T45
	25mm x9	T8, T10, T15, T20, T25, T27, T30, T35, T40
	25mm x3	M5, M6, M8
	25mm x3	6, 8, 10mm
	25mm x3	C1, C2, C3
	25mm x4	1, 2, 3, 4mm
	25mm x4	4, 6, 8, 10mm
	25mm x4	0, 1, 2, 3mm

# COFFRET DE DOUILLES 3/8"

## DE 59 PIÈCES 6 PANS

51819 48,00€

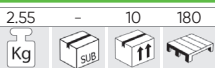

ACIER ZINGUÉ

53219 49,00€



CHROMÉ

CrV 3/8" 59 PCS

51819



PIÈCES DE RECHANGE DISPONIBLES



53219



PIÈCES DE RECHANGE DISPONIBLES

CONTIENT

	3/8" x17	6, 7, 8, 9, 10, 11, 12, 13, 14, 15, 16, 17, 18, 19, 20, 21, 22mm
	x1	3/8"
	3/8" x2	75, 150mm
	3/8" x1	8mm
	3/8" x1	8mm

	x1	3/8"
	x2	PH3, PH4
	x2	PZ3, PZ4
	8mm x5	7, 8, 10, 12, 14mm
	x3	SL8, SL10, SL12
	x5	T40, T45, T50, T55, T60

	x1	1/4"
	x2	PH1, PH2
	x2	PZ1, PZ2
	1/4" x4	3, 4, 5, 6mm
	x3	SL4, SL5.5, SL6.5
	x7	T8, T10, T15, T20, T25, T27, T30



## COFFRET D'OUTILS DE 22 PIÈCES DOUILLES DE 1/2"

54116 66,00€

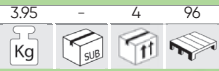

CrV 1/2" 22 PCS



PIÈCES DE RECHANGE DISPONIBLES



12 PANS

CONTIENT

		1/2"	x17	10, 11, 12, 13, 14, 15, 16, 17, 18, 19, 21, 22, 24, 27, 30, 32mm
		1/2"	x1	1/2"
		1/2"	x2	125, 250mm
		1/2"	x1	
		1/2"	x1	3/8"(H), 1/2"(M)

## COFFRET DE DOUILLES DE 46 PIÈCES 6 PANS

54109 34,00€

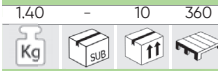

CrV 1/4" 46 PCS



PIÈCES DE RECHANGE DISPONIBLES



CONTIENT

		1/4"	x13	4, 4.5, 5, 5.5, 6, 7, 8, 9, 10, 11, 12, 13, 14mm
		1/4"	x1	
		1/4"	x1	1/4"
		1/4"	x1	1/4"
		2"/4"	x2	
			x4	1.27, 1.5, 2.0, 2.5mm
			x1	
			x1	1/4"

## COFFRET DE DOUILLES 56 PIÈCES

53102 36,00€



1/4" CrV 56 PCS



PIÈCES DE RECHANGE DISPONIBLES



CONTIENT

		1/4"	x13	4, 4.5, 5, 5.5, 6, 7, 8, 9, 10, 11, 12, 13, 14mm
		1/4"	x1	1/4"
		1/4"	x2	50, 100mm
			x1	1/4"
			x1	1/4"

CHROMÉ

		1/4"	x1	
		1/4"	x1	6mm
			x3	PH0, PH1, PH2
		6mm	x3	PZ0, PZ1, PZ2
			x6	3, 4, 5, 6, 7, 8mm
		6mm	x1	1/4"

54140 36,00€



1/4" CrV 56 PCS



PIÈCES DE RECHANGE DISPONIBLES



			x4	SL4, SL5, SL6, SL7
		6mm	x3	M5, M6, M8
			x8	T8, T10, T15, T20, T25, T27, T30, T40
			x8	T8, T10, T15, T20, T25, T27, T30, T40

## COFFRET DE DOUILLES 35 PIÈCES EN POUCE

54106 89,00€

4.70 - 3 108  
Kg SUB



### CONTIENT

	1/2"	x17	5/16", 3/8", 7/16", 1/2", 9/16", 19/32", 5/8", 11/16", 3/4", 13/16", 7/8", 15/16", 1", 1-1/16", 1-1/8", 1-3/16", 1-1/4"
	1/4"	x8	3/16", 7/32", 1/4", 9/32", 5/16", 11/32", 3/8", 7/16"
	1/2"	x2	5", 10"
	1/4"	x1	3"
		x1	1/2"
		x1	1/4"
		x2	1/2" - 1/4"
		x1	1/4"

37 PCS

1/4"

1/2"

CrV



## COFFRET D'OUTILS DE 22 PIÈCES DOUILLES DE 1/2" HEX.

54108 66,00€

3.95 - 4 128  
Kg SUB



### CONTIENT

	1/2"	x16	10, 11, 12, 13, 14, 15, 16, 17, 18, 19, 21, 22, 24, 27, 30, 32mm
	1/2"	x1	
	1/2"	x2	75, 125mm
		x1	3/8"(H)-1/2"(M)

22 PCS

1/2"

CrV



## COFFRET D'OUTILS DE 61 PIÈCES DOUILLES SPLINE DE 1/4" ET 1/2"

52722 87,00€

4.63 - 4 60  
Kg SUB

1/2" 1/4"

ACIER ZINGUÉ



PIÈCES DE RECHANGE DISPONIBLES



53108 92,00€

4.83 - 3 90  
Kg SUB

1/2" 1/4" CrV 61 PCS

CHROMÉ

- Utile pour:



PIÈCES DE RECHANGE DISPONIBLES

### CONTIENT

	1/2"	x11	14, 15, 16, 17, 18, 19, 22, 24, 27, 30, 32mm
	1/4"	x12	4, 4.5, 5, 5.5, 6, 7, 8, 9, 10, 11, 12, 13mm
	1/2"	x2	125, 250mm
	1/4"	x2	50, 100mm
		x2	1/2" - 1/4"
	1/2"	x1	adaptateur 3/8" H x 1/2" M
	1/2"	x2	16, 21mm
	1/4"	x1	6mm
		x3	1.5, 2, 2.5mm
		x1	1/4"
		x1	1/4"

		x3	PH1, PH2, PH3
		x3	PZ1, PZ2, PZ3
	6mm	x5	3, 4, 5, 6, 8mm
		x3	SL4, SL5.5, SL7
		x5	T10, T15, T20, T25, T30
	6mm	x1	1/4"

## COFFRET DE 77 PIÈCES

54258 58,00€

7.50 - 4 -  
Kg SUB

### CONTIENT



	x5	PH0, PH1, PH2, PH2, PH3
	x5	PZ0, PZ1, PZ2, PZ2, PZ3
	x5	3, 4.5, 5.5, 6mm
	x5	T10, T15, T20, T25, T30
	X4	6x7mm, 8x9mm, 10x11mm, 12x13mm
	X9	1.5, 2, 2.5, 3, 4, 5, 6, 8, 10mm
	X10	
	X10	

	X1	
	X1	
	X1	
	X1	
	X1	
	X1	
	X1	
	X1	
	X3	PH2X100, PH00X50, PH000X50, SL6X100
	X3	SL2.5X50, SL3.0X50

CrV 77 PCS

# COFFRET DE DOUILLES 72 PIÈCES 6 PANS

51818

95,00€

7,15	-	3	60

ACIER ZINGUÉ

53106

99,00€

7,20	-	3	60

CHROMÉ



CrV

72  
PCS

1/2"

1/4"



53106



PIÈCES DE RECHANGE DISPONIBLES

51818



PIÈCES DE RECHANGE DISPONIBLES

## CONTIENT

	1/2"	x13	10, 11, 12, 13, 14, 15, 17, 19, 22, 24, 27, 30, 32mm		x2	1/2" - 1/4"		x1	300gr	
	1/4"	x10	4, 5, 6, 7, 8, 9, 10, 11, 12, 13mm		x2	16, 21mm		x1		
	1/4"	x5	5, 6, 7, 8, 9mm		x1	6mm		x1		
	ref. 53106	72	x2	1/2", 1/4"		x3	1,5, 2, 2,5mm		x4	SL3, SL4, SL5, SL6
	ref. 51818	24	x2	1/2", 1/4"		x1	1/4"		x3	PH1, PH2, PH3
	1/2"	x1	125mm		x2	PH6x40mm, PH6x100mm		x7	T10, T15, T20, T25, T27, T30, T40	
	1/4"	x1	75mm		x3	SL6x40mm, SL6x100mm, SL8x200mm				

# COFFRET DE DOUILLES 41 PIÈCES 6 PANS

52713

89,00€

6,30	-	4	96

ACIER ZINGUÉ



CrV

41  
PCS

1/2"



PIÈCES DE RECHANGE DISPONIBLES

## CONTIENT

	1/2"	x11	10, 12, 13, 14, 15, 17, 19, 22, 24, 27, 30mm		x1	6"
	1/2"	x2	16, 21mm		x1	20x200mm
	24	x1	1/2"		x1	6-24V, 110mm
	1/2"	x1	125mm		x1	8"
	1/2"	x1			x2	8x10, 12x13mm
	1/2"	x1	adaptateur 3/8" H x 1/2" M		x1	8x10mm
	1/2"	x8	7, 8, 10, 12, 13, 14, 17, 19mm		x1	75x300mm
	x4	6, 8, 10, 12mm		x1	300gr	
	+	x1	PH2x100mm		x1	6x150mm
	-	x1	SL6x100mm			

# TROUSSES À OUTILS EN ALUMINIUM

## COFFRET DE DOUILLES ALUMINIUM 159PCS

53159 289,00€

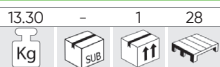

CrV

1/2"

1/4"

159  
PCS

ACIER ZINGUÉ



PIÈCES DE RECHANGE DISPONIBLES



### CONTIENT



	1/2"	x14	14, 15, 16, 17, 18, 19, 20, 21, 22, 23, 24, 27, 30, 32mm
	1/4"	x10	4, 5, 6, 7, 8, 9, 10, 11, 12, 13mm
		x2	1/4" - 1/2"
	1/2"	x2	50, 100mm
	1/4"	x2	125, 250mm
	1/4"	x1	150mm
		x2	1/4" - 1/2"
	1/2"	x1	adaptateur 3/8" H x 1/2" M
		x2	1/4" - 1/2"
	1/4"	x1	250mm
	1/4"	x1	110mm
	1/2"	x2	16, 21mm
		x1	1/4"

		x9	8, 10, 11, 12, 13, 15, 17, 19, 22mm
		x9	1.5, 2, 2.5, 3, 4, 5, 6, 8, 10mm
		x1	100-250V
		x1	
		x2	PH1×80, PH2×10mm
		x4	SL3×75, SL4×100, SL6.5×125, SL8×150mm
		x1	PH00×50mm
		x1	SL2.5×50mm
		x1	250mm
		x1	160mm
		x1	180mm
		x1	160mm
		x1	200mm
		x1	7" (180mm)
		x1	220mm
		x1	160mm

		x1	
		x6	1,5mm
		x1	
		x1	300gr
		x1	3m
		x1	200mm
		x5	
		x1	18mm
		x10	
		x40	6.35mm
		x15	8mm

# TROUSSES À OUTILS EN ALUMINIUM

## COFFRET DE DOUILLES 135 PIÈCES 6 PANS

53928 278,00€

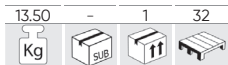

1/2" 1/4" 135 PCS  
CrV



PIÈCES DE RECHANGE DISPONIBLES



### CONTIENT



	x1	250mm
	x1	180mm
	x1	180mm
	x1	200mm
	x1	160mm
	x1	200mm
	x1	
	x3	
	x1	18mm



	1/2"	x10	10, 11, 12, 13, 14, 15, 17, 19, 22, 24mm
	1/4"	x9	4, 5, 6, 7, 8, 9, 10, 11, 12mm
	72	x2	1/2" - 1/4"
	1/2"	x2	125, 250mm
	1/4"	x2	50, 100mm
		x2	1/2" - 1/4"
	1/2"	x1	adaptateur 3/8"Hx1/2"M
		x1	1/4"
	1/4"	x1	6mm
	1/2"	x2	16, 21mm
		x9	8, 10, 11, 12, 13, 14, 17, 19, 22mm
		x1	150mm



	x1	
	x1	
	x1	100-250v
	x1	
	x1	300gr.
	x1	
	x1	5m



	x1	
	x3	SL1.5, SL2, SL3
	x4	PH00, PH00, PH0, PH1
	x8	T4, T5, T6, T7, T8, T10, T15, T20
	x4	TS0.8, TS1.2, TS1.5, TS2.0
	x1	H2.0
	x9	1.5, 2, 2.5, 3, 4, 5, 6, 8, 10mm
	x2	PH1x80mm, PH2x100mm
	x4	SL3.0x75mm, SL4.0x100mm, SL6.5x125mm, 8x150mm
	x5	

	x1	6.35mm
	x4	PH1, PH2, PH2, PH3
	x4	PZ1, PZ2, PZ2, PZ3
	x4	SL3, SL4, SL5, SL6
	x4	H3, H4, H5, H6
	x6	T10, T15, T20, T25, T27, T30, T40
	x7	TT10, TT15, TT20, TT25, TT27, TT30, TT40

# TROUSSES À OUTILS EN ALUMINIUM

## COFFRET DE DOUILLES ALUMINIUM 108PCS

53444 195,00€

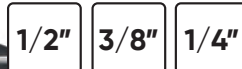

ACIER ZINGUÉ

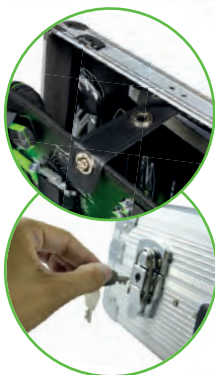

### CONTIENT



	1/4"	x8	4, 4.5, 5, 5.5, 6, 7, 8, 9mm
	3/8"	x9	10, 11, 12, 13, 14, 15, 17, 18, 19mm
	1/2"	x1	1/2"
	3/8"	x2	75, 150mm
	1/2"	x2	75, 150mm
	1/4"	x1	adaptateur 3/8" H x 1/4" M
	1/4"	x1	25mL
	1/4"	x1	1/4"

	3/8"	x1	16mm
		x8	6x7, 8x9, 10x11, 12x13, 14x15, 16x17, 18x19, 20x22mm
		x9	1.5, 2, 2.5, 3, 4, 5, 6, 8, 10mm
	+	x2	PH1x80, PH2x100mm
	+	x4	SL3.5x75, SL4x100, SL6.5x125, SL8x150mm
	+	x1	PH00x50mm
	+	x1	SL2.5x50mm

	x1	100-250V		x1
	x1	250mm		x6
	x1	180mm		x1
	x1	160mm		x31
	x1	160mm		x1
	x1	220mm		x1
	x1	18mm		x1
	x10			x1

## COFFRET MÉTALLIQUE DE DOUILLES 22 PIÈCES CLIQUET DE 1" 6 PANS

**51616** 378,00€

34,60	-	1	24
Kg	Sub	ff	ff



**51855** 378,00€

33,70	-	1	24
Kg	Sub	ff	ff



BOÎTE MÉTALLIQUE

CrV 1" 22 PCS

ACIER ZINGUÉ



### CONTIENT

	1"	x17	36, 38, 41, 46, 50, 54, 55, 58, 60, 63, 65, 67, 70, 71, 75, 77, 80mm
	1"	x1	650mm
	1"	x2	205, 410mm
	x1 1"		
		x1 1"	

**51616**

PIÈCES DE RECHANGE DISPONIBLES

**51855**

PIÈCES DE RECHANGE DISPONIBLES

## COFFRET DE DOUILLES 21 PIÈCES CLIQUET DE 3/4"

**53727** 198,00€

14,65	-	1	40
Kg	Sub	ff	ff



CrV 3/4" 21 PCS

ACIER ZINGUÉ

**53728** 198,00€

14,30	-	1	40
Kg	Sub	ff	ff



### CONTIENT

	3/4"	x16	19, 21, 22, 23, 24, 26, 27, 29, 30, 32, 35, 36, 38, 41, 46, 50mm
	3/4"	x1	495mm
	3/4"	x3	100, 200, 400mm
	3/4"	x1	445mm



**53728**

PIÈCES DE RECHANGE DISPONIBLES

**53727**

PIÈCES DE RECHANGE DISPONIBLES

## COFFRET DE DOUILLES TRAVERSANTES 6 PANS

**52418** 164,00€

3,61	-	5	100
Kg	Sub	ff	ff



CrV 39 PCS

CHROMÉ

### CONTIENT

	13mm	x12	4, 4.5, 5, 5.5, 6, 7, 8, 9, 10, 11, 12, 13mm
	19mm	x10	10, 11, 12, 13, 14, 15, 16, 17, 18, 19mm
	22mm	x5	20, 21, 22, 23, 24mm
	22mm - 1/2"	x3	27, 30, 32mm
		x3	13, 19, 22mm
	1/4"	x1	13mm
	3/8"	x1	19mm
	1/2"	x1	22mm
		x3	13, 19, 22mm



## COFFRET DE DOUILLES 14 PIÈCES TRAVERSANTES

54090 56,00€

14 PCS

2.00	-	10	240
Kg	sub	ff	ff



### CONTIENT

	x11	13, 14, 15, 16, 17, 18, 19, 21, 22, 24, 27mm
	x1	12,5mm
	x1	1/2"
	x1	go-through

## COFFRET DE DOUILLES 17 PIÈCES TRAVERSANTES

50623 60,00€



CrV

1/4"

17 PCS

0,63	-	10	320
Kg	sub	ff	ff

CHROMÉ



SPECIAL POUR ESPACES REDUITS



### CONTIENT

	13mm	x13	4, 4.5, 5, 5.5, 6, 7, 8, 9, 10, 11, 12, 13, 14mm
	13mm	x1	75mm
		x1	1/4"
	13mm	x1	145mm



## JEU D'EMBOUITS TORX 6 PIÈCES 1/2" TYPE E EXTRA LONGS

53915 65,00€

CrV

1/2"

6 PCS

2.10	-	10	240
Kg	sub	ff	ff

### ACIER ZINGUÉ

### CONTIENT

	1/2"	x6	E10, E12, E14, E16, E18, E20
--	------	----	------------------------------

E12 Douille pour culasse de BMW:  
- Moteur M42, 1,8 L, 4 cylindres, 16 V, modèle 318 (1989)  
- Moteur M50, 2,0 L, 2, 5 L, 6 cylindres, 24 V, modèles 520i, 525i (1991)



TÊTE AVEC NOIRCISSEMENT

140mm



## COFFRET DE DOUILLES 28 PIÈCES TORX

51930 39,00€

CrV

1/2"

3/8"

1/4"

28 PCS

2.12	-	10	240
Kg	sub	ff	ff

### CONTIENT

	1/4"	x5	E4, E5, E6, E7, E8
	3/8"	x5	E10, E11, E12, E14, E16
	1/2"	x4	E18, E20, E22, E24
	1/4"	x5	E4, E5, E6, E7, E8
	3/8"	x5	E10, E11, E12, E14, E16
	1/2"	x4	E18, E20, E22, E24

51930



PIÈCES DE RECHANGE DISPONIBLES



ACIER ZINGUÉ

54141 42,00€

CrV

1/2"

3/8"

1/4"

28 PCS

2.15	-	10	240
Kg	sub	ff	ff



PIÈCES DE RECHANGE DISPONIBLES

	1/4"	x5	E4, E5, E6, E7, E8
	3/8"	x5	E10, E11, E12, E14, E16
	1/2"	x4	E18, E20, E22, E24
	1/4"	x5	E4, E5, E6, E7, E8
	3/8"	x5	E10, E11, E12, E14, E16
	1/2"	x4	E18, E20, E22, E24





## JEU DE DOUILLES 12 PIÈCES DE 1/2" TORX

51261 36,00€

1,62 - 10 360



ACIER ZINGUÉ



CHROMÉ

	1/2"	x6 55mmL	T20, T25, T30, T40, T45, T50
		x1 65mmL	T55
		x5 70mmL	T60, T70, T80, T90, T100



PIÈCES DE RECHANGE DISPONIBLES

54154 37,50€

1,85 - 10 320



CrV

1/2"

12 PCS

55 mm

70 mm

ACIER ZINGUÉ



CHROMÉ

	1/2"	x6 55mmL	T20, T25, T30, T40, T45, T50
		x6 70mmL	T55, T60, T70, T80, T90, T100

## JEU DE DOUILLES 12 PIÈCES DE 1/2" 12 PANS

51384 34,00€

1,62 - 10 360



ACIER ZINGUÉ



53104 34,00€

1,75 5 10 240



CHROMÉ

CONTIENT

	1/2"	x6 55mmL	M4, M5, M6, M7, M8, M9
		x1 65mmL	M10
		x5 70mmL	M12, M14, M16, M18, M20

54164 34,00€

1,75 - 10 320



CrV

1/2"

12 PCS



CONTIENT

	1/2"	x6 55mmL	M4, M5, M6, M7, M8, M9
		x6 70mmL	M10, M12, M14, M16, M18, M20

## JEU DE DOUILLES 12 PIÈCES 1/2" 6 PANS

51260 37,00€

1,92 - 10 360



ACIER ZINGUÉ

51260



PIÈCES DE RECHANGE DISPONIBLES



CrV

1/2"

12 PCS

53105 37,00€

2,05 - 10 240



CHROMÉ

CONTIENT

	1/2"	x6 55mmL	H5, H6, H7, H8, H10, H12
		x1 65mmL	H14
		x5 70mmL	H16, H17, H18, H19, H22

## SET DE DOUILLES 6 PIÈCES 1/2" POINTE TORX INVIOLEBLE

51410 36,00€

0,38 5 20 500



T55, T60, T70, T80, T90, T100

1/2"

CrV

6 PCS



## SET DE 6 PIÈCES 1/2" 12 PANS INVIOLEBLE / POINTE XZN

51409 36,00€

0,35 5 20 -



M10, M12, M14, M16, M18, M20

1/2"

CrV

6 PCS



## COFFRET D'EMBOUITS 12 PANS

52603 74,00€



26  
PCS

4,07	-	4	128
Kg	sub	ff	



52606 88,00€



32  
PCS

CrV

1/2"

5,05	-	4	128
Kg	sub	ff	



### CONTIENT

1/2"	x8	M5, M6, M8, M9, M10, M12, M14, M16
	x7	M5, M6, M8, M9, M10, M12, M14
	x7	M5, M6, M8, M9, M10, M12, M14
	x4	M8, M10, M12, M14



PIÈCES DE RECHANGE DISPONIBLES

### CONTIENT

1/2"	x9	M5, M6, M7, M8, M9, M10, M12, M13, M14
	x9	M5, M6, M7, M8, M9, M10, M12, M13, M14
	x7	M7, M8, M9, M10, M12, M13, M14
	x7	M7, M8, M9, M10, M12, M13, M14



PIÈCES DE RECHANGE DISPONIBLES

## COFFRET D'EMBOUITS 6 PANS

52604 78,00€



30  
PCS

4,62	-	4	144
Kg	sub	ff	



52605 76,00€



32  
PCS

CrV

1/2"

4,60	-	4	144
Kg	sub	ff	



### CONTIENT

1/2"	x9	5, 6, 7, 8, 10, 12, 14, 17, 19mm
	x8	5, 6, 7, 8, 10, 11, 12, 13mm
	x7	5, 6, 7, 8, 10, 12, 14mm
	x6	5, 6, 7, 8, 10, 12mm



PIÈCES DE RECHANGE DISPONIBLES

### CONTIENT

1/2"	x10	T20, T25, T27, T30, T40, T45, T50, T55, T60, T70
	x10	T20, T25, T27, T30, T40, T45, T50, T55, T60, T70
	x6	T40, T45, T50, T55, T60, T70
	x6	T40, T45, T50, T55, T60, T70



PIÈCES DE RECHANGE DISPONIBLES

# COFFRET D'EMBOUS DE VISSAGE 55 PIÈCES HEAVY DUTY

**52753** 107,00€

2,96 - 4 184



S-2 3/8" 1/2" 55 PCS

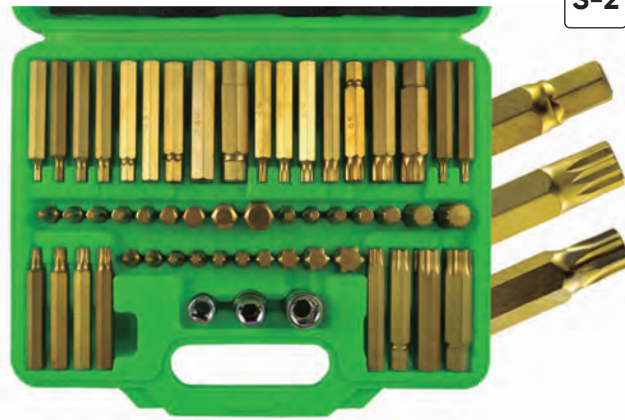

## CONTIENT

	<b>3/8"</b>	x1	10mm
	<b>1/2"</b>	x2	10, 14mm
	30mm	x9	4, 5, 6, 7, 8, 10, 12, 14, 16mm - ISO 2136
	75mm	x9	4, 5, 6, 7, 8, 10, 12, 14, 16mm - ISO 2136
	30mm	x10	T20, T25, T30, T40, T45, T50, T55, T60, T70, T80 - DIN 2325
	75mm	x10	T20, T25, T30, T40, T45, T50, T55, T60, T70, T80 - DIN 2325
	30mm	x7	M5, M6, M8, M10, M12, M14, M16 - DIN 2325
	75mm	x7	M5, M6, M8, M10, M12, M14, M16 - DIN 2325

# COFFRET 42 EMBOUTS DE VISSAGE TORX, 12 ET 6 PANS

**50983** 48,00€

1,77 - 5 275



## CONTIENT

	<b>3/8"</b>	x1	10mm
	<b>1/2"</b>	x1	10mm
	30mm	x7	4, 5, 6, 7, 8, 10, 12mm
	75mm	x7	4, 5, 6, 7, 8, 10, 12mm
	30mm	x8	T20, T25, T30, T40, T45, T50, T55, T60
	75mm	x8	T20, T25, T30, T40, T45, T50, T55, T60
	30mm	x5	M5, M6, M8, M10, M12
	75mm	x5	M5, M6, M8, M10, M12

**50985** 59,00€

1,74 - 5 275



INVIOLEBLE



## CONTIENT

	<b>3/8"</b>	x1	10mm
	<b>1/2"</b>	x1	10mm
	30mm	x7	4, 5, 6, 7, 8, 10, 12mm
	75mm	x7	4, 5, 6, 7, 8, 10, 12mm
	30mm	x8	T20, T25, T30, T40, T45, T50, T55, T60
	75mm	x8	T20, T25, T30, T40, T45, T50, T55, T60
	30mm	x5	M5, M6, M8, M10, M12
	75mm	x5	M5, M6, M8, M10, M12

# COFFRET DE 75 EMBOUTS DE VISSAGE

**52550** 92,00€

3,61 - 4 96



S-2 3/8" 1/2" 75 PCS

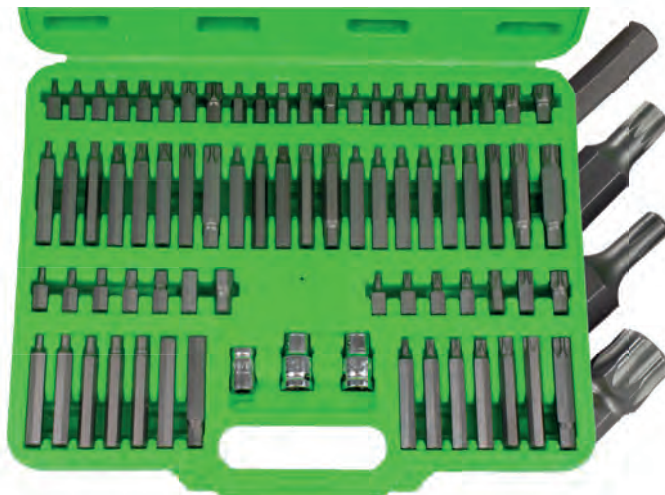

## CONTIENT

	<b>3/8"</b>	x1	10mm
	<b>1/2"</b>	x2	10mm
	30mm	x7	4, 5, 6, 7, 8, 10, 12mm
	75mm	x7	4, 5, 6, 7, 8, 10, 12mm
	30mm	x8	T20, T25, T30, T40, T45, T50, T55, T60
	75mm	x8	T20, T25, T30, T40, T45, T50, T55, T60
	30mm	x5	M5, M6, M8, M10, M12
	75mm	x5	M5, M6, M8, M10, M12
	30mm	x8	M5, M6, M7, M8, M9, M10, M12, M14
	75mm	x5	M5, M6, M8, M10, M12
	30mm	x8	T20, T25, T30, T40, T45, T50, T55, T60
	75mm	x8	T20, T25, T30, T40, T45, T50, T55, T60

# KIT DE 208 EMBOUTS

53574 47,00€

2,29	-	6	216
Kg	Sub	11	11

CrV 208 PCS



## CONTIENT

25mmL x12	1,5, 2, 2,5, 3, 3,5, 4, 4,5, 5, 5,5, 6, 7, 8mm	25mmL x4	4, 6, 8, 10mm
x10	1/16, 5/64, 3/32, 7/64, 1/8, 9/64, 5/32, 3/16, 7/32, 1/4	50mmL x4	4, 6, 8, 10mm
50mmL x5	2,5, 3, 4, 5, 6mm	25mmL x4	1, 2, 3, 4mm
75mmL x5	2,5, 3, 4, 5, 6mm	50mmL x4	1, 2, 3, 4mm
25mmL x18	PH00, PH0, PH1(x5), PH2(x5), PH3(x5), PH4	25mmL x6	2, 2,5, 3, 4, 5, 6mm
50mmL x3	PH1, PH2, PH3	25mmL x6	5/64, 3/32, 7/64, 1/8, 9/64, 5/32
75mmL x3	PH1, PH2, PH3	25mmL x13	T5, 6, 7, 8, 9, 10, 15, 20, 25, 27, 30, 40, 45
25mmL x17	PZ00, PZ0, PZ1(x5), PZ2(x5), PZ3(x4), PZ4	25mmL x3	1, 2, 3mm
50mmL x3	PZ1, PZ2, PZ3	25mmL x4	0, 1, 2, 3mm
75mmL x3	PZ1, PZ2, PZ3	25mmL x3	M5, M6, M8
25mmL x14	T5, T6, T7, T8, T9, T10, T15, T20, T25, T27, T30, T35, T40, T45	25mmL x9	TS10, TS15, TS20, TS25, TS27, TS30, TS40, TS45, TS50
50mmL x7	T10, T15, T20, T25, T27, T30, T40	25mmL x12	SL2, SL2.5, SL3, SL3.5, SL4, SL4.5, SL5, SL5.5, SL6, SL6.5, SL7, SL8
75mmL x7	T10, T15, T20, T25, T27, T30, T40		
25mmL x3	6, 8, 10mm		
50mmL x3	6, 8, 10mm		

mm	x10	4, 5, 6, 7, 8, 9, 10, 11, 12, 13
"	x10	5/32, 3/16, 7/32, 1/4, 9/32, 5/16, 11/32, 3/8, 7/16, 1/2
6mm	x1	1/4" Adaptateur
	x1	

# MALLETTE D'EMBOUTS DE VISSAGE

52539 59,00€

1,90	-	5	128
Kg	Sub	11	11

ALLEN 8 CrV 85 PCS

## CONTIENT

x2	PH3, PH4
x2	PZ3, PZ4
8mm x5	7, 8, 10, 12, 14mm
x3	SL8, SL10, SL12
x5	T40, T45, T50, T55, T60



# MALLETTE DOUILLES DE TOURNEVIS DE 1/4"

52538 62,00€

2,07	-	16	128
Kg	Sub	11	11

CrV 1/4" 90 PCS

## CONTIENT

x2	PH1, PH2
x2	PZ1, PZ2
1/4" x5	3, 4, 5, 6mm
x3	SL4, SL5.5, SL6.5
x5	T8, T10, T15, T20, T25, T27, T30



# COFFRET DE 6 ADAPTATEURS

51333 18,00€

0,52	5	40	960
Kg	Sub	11	11

CrV 6 PCS

ACIER ZINGUÉ

M	H
1/2"	3/4"
3/8"	1/2"
1/4"	3/8"
3/8"	1/4"
1/2"	3/8"
3/4"	1/2"



## PIÈCES DE RECHANGE DISPONIBLES

REF.	DESCRIPTION	Kg	€
11360	1/4H - 3/8M	0,02	2,60€
11361	1/4M - 3/8H	0,05	3,20€
11362	3/8H - 1/2M	0,13	5,20€
11363	1/4H - 3/8M	0,05	3,90€
11364	1/2H - 3/8M	0,05	4,50€
11365	3/4H - 1/2M	0,14	9,40€



# KIT DE 6 TÊTES À PERCUSSION

53743 39,70€

0,80	5	20	960
Kg	Sub	11	11

CrMo 6 PCS



## PIÈCES DE RECHANGE DISPONIBLES

REF.	mm	Kg	Sub	11	€
14749	1/4" F - 3/8" M	-	20	100	2,00€
14750	3/8" F - 1/4" M	-	20	100	2,00€
14751	3/8" F - 1/2" M	-	20	100	4,00€
14752	1/2" F - 3/8" M	-	10	100	4,00€

M	H
3/4"	1/2"
1/2"	3/4"
3/8"	1/4"
1/4"	3/8"
1/2"	3/8"
3/8"	1/2"

# COFFRET DE 38 PIÈCES AVEC CLIQUET MINI DE 1/4"

**53156** 26,20€

0,48 6 36 1008

Kg SUB ff

**52198** 37,70€

0,45 6 36 1800

Kg SUB ff

CrV 1/4" 38 PCS



## CONTIENT

		1/4"	x11	4, 4.5, 5, 6, 7, 8, 9, 10, 11, 12, 13mm
		T2	x1	1/4"
			x2	PH3, PH4
			x2	PZ3, PZ4
			x5	4, 5, 6, 7, 8mm
		6mm	x3	SL6, SL8, SL10
			x2	T8, T9, T10, T15, T20, T25, T30, T40
			x4	M5, M6, M9, M10
			x1	1/4"

## RAIL A DOUILLES TOURNEVIS 1/2"

**52714** 15,70€

0,65 4 24 576

Kg SUB ff



**52716** 15,90€

0,61 4 24 576

Kg SUB ff



10, 11, 12, 13, 14, 15, 16, 17, 18, 19mm

1/2" 10 PCS

CrV



PRÉSENTÉ IN GUIDE METALLIQUE



PRÉSENTÉ IN GUIDE METALLIQUE



## RAIL A DOUILLES TOURNEVIS 1/4"

**52715** 10,00€

0,35 6 36 1152

Kg SUB ff



**52717** 11,00€

0,27 6 36 1152

Kg SUB ff



4, 4.5, 5, 5.5, 6, 7, 8, 9, 10, 11, 12, 13, 14mm

1/4" 13 PCS

CrV



PRÉSENTÉ IN GUIDE METALLIQUE



PRÉSENTÉ IN GUIDE METALLIQUE



## RAIL A 18 DOUILLES TOURNEVIS 1/4"

**52909** 12,50€

0,35 8 32 1500

Kg SUB ff

S-2 1/4" 18 PCS

CrV



PRÉSENTÉ IN GUIDE METALLIQUE



## RAIL A 30 DOUILLES TOURNEVIS 1/4"

**52908** 17,00€

0,60 8 32 500

Kg SUB ff

S-2 1/4" 30 PCS

CrV



PRÉSENTÉ IN GUIDE METALLIQUE



### CONTIENT

	x2	PH1, PH2		
	x2	PZ1, PZ2		
	x4	3, 4, 5, 6mm		x3
				x7
				T8, T10, T15, T20, T25, T27, T30

### CONTIENT

	x3	PH0, PH1, PH2		x4	SL4, SL5.5, SL6.5, SL7
	x3	PZ0, PZ1, PZ2		x8	T8, T9, T10, T15, T20, T25, T27, T30
	x4	3, 4, 5, 6mm		x8	T8, T9, T10, T15, T20, T25, T27, T30

## RAIL A DOUILLES TORX

3/8" - 1/2"

**53084** 24,00€

0,60	5	20	880
Kg	sub	ff	



1/2" 3/8" 7 PCS

3/8": T30, T40, T45, T50  
1/2": T55, T60, T70

CrV



PIÈCES DE RECHANGE DISPONIBLES



## RAIL A 7 DOUILLES INVIOLENT 1/4"

**53127** 12,00€

0,15	5	100	1800
Kg	sub	ff	



CrV 1/4" 7 PCS

T10, T15, T20, T25, T30, T40, T45



PIÈCES DE RECHANGE DISPONIBLES



## RAIL A DOUILLES TS 5 PANS INVIOLENT

**51746** 12,00€

0,20	5	75	1050
Kg	sub	ff	

PRÉSENTÉ IN GUIDE METALLIQUE



TS10, TS15, TS20, TS25, TS30, TS40, TS45

CrV 1/4" 7 PCS



## RAIL A DOUILLES TOURNEVIS RIBE

**50980** 22,00€

0,76	5	20	300
Kg	sub	ff	



1/2" 100mm: M12, M13, M14  
3/8" 90mm: M6, M7, M8, M10

**50982** 22,00€

0,46	6	36	1080
Kg	sub	ff	

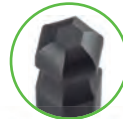

3/8" 3/8" 100mm HB3: 4, 5, 6, 7, 8, 10mm

**52320** 22,00€

0,76	5	20	480
Kg	sub	ff	



1/2" 100mm: M12, M13, M14  
3/8" 90mm: M6, M7, M8, M10



7 PCS

CrV



## DOUILLE POINTE XZN

**12029** 5,50€

0,17	5	100	1500
Kg	sub	ff	

INVIOLENT M16X58MM



**12030** 6,50€

0,25	8	80	-
Kg	sub	ff	

INVIOLENT M16X100MM



CrV 1/2"



## DOUILLE TOURNEVIS EXTRALONGUE 12 PANS - 800MM 1/2"

REF.	DESCRIPTION	Kg	sub	ff	€	
52059	Ø 8mm - 800mm	0,58	-	25	1.750	29,00€
52060	Ø 10mm - 800mm	0,58	-	25	1.750	32,00€
53667	Ø 12mm - 800mm	0,80	10	20	-	32,00€
53668	Ø 14mm - 800mm	1,05	10	20	-	34,00€

800mm

CrV 1/2"

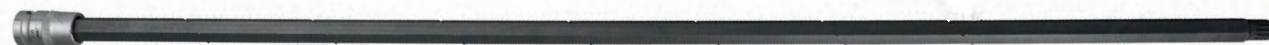





## SET D'OUTILS ISOLANTS 20 PIÈCES DE 3/8"





54091 441,00€

4,20	-	3	72
Kg	SUB	11	

	x2	4x100mm, 5,5x125mm
	x2	PH1x80mm, PH2x100mm

### CONTIENT

	3/8" x10 45mm	8, 10, 11, 12, 13, 14, 16, 17, 18, 19, 21, 22mm
	3/8" x1	200mm
	1/2" x1	125mm
	3/8" x1	200mm

	x1	185mm
	x1	
	x1	185mm
	x6	7x86mm, 8x99mm, 10x109mm, 12x127mm, 14x141mm, 17x156

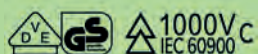





## MODULE D'OUTILS VDE AVEC ISOLATION EVA (ÉTHYLÈNE VINYLE ACÉTATE)

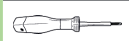



54093 441,00€

3,25	-	4	80
Kg	SUB	11	

	x2	4x100mmL, 5,5x125mmL
	x2	PH1x80mm, PH2x100mm

### CONTIENT

	3/8" x10 45mm	8, 10, 11, 12, 13, 14, 16, 17, 18, 19, 21, 22mm
	3/8" x1	200mm
	1/2" x1	125mm
	3/8" x1	200mm

	x1	185mm
	x1	
	x1	185mm
	x6	7x86mm, 8x99mm, 10x109mm, 12x127mm, 14x141mm, 17x156

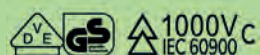



## SET D'OUTILS ISOLANTS 20 PIÈCES DE 3/8"

53154 462,00€

3,30	-	3	72
Kg	SUB	11	

### CONTIENT

	3/8" x12	8, 10, 11, 12, 13, 14, 16, 17, 18, 19, 21, 22mm
	1/2" x1	200mm
	1/2" x2	125, 250mm
	3/8" x1	200mm
	3/8" x4 75mm	4, 5, 6, 8mm



CrV 3/8" 20 PCS

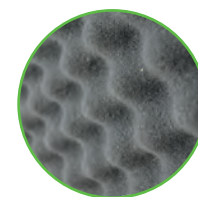

## SET DE TOURNEVIS ISOLÉS À 1000V

**52009** 36,00€

- Optimisé pour le travaille avec de électricité.  
- Outil de sécurité.

0,34 10 50 1200



### CONTIENT

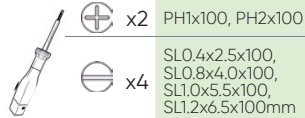

x2 PH1x100, PH2x100  
x4 SL0.4x2.5x100, SL0.8x4.0x100, SL1.0x5.5x100, SL1.2x6.5x100mm



Certifié: DIN EN60900:2005-01 - EN60900:2004

## JEU DE 50 TOURNEVIS ISOLÉS

**52521** 125,00€

1,43 - 6 216



CrV 50 PCS



### CONTIENT

+	x3	PH0, PH1, PH2	⊕	x1	89
⊖	x7	SL0.4x2.0, SL0.4x2.5, SL0.5x3.0, SL0.6x3.5, SL0.8x4.0, SL1.0x5.5, SL1.2x6.5mm	⊗	x1	89
⊙	x3	PZ0, PZ1, PZ2	⊕	Voltage Tester: 3.0 x 70 + Torx 31 x 105	
⊛	x9	T6, T8, T9, T10, T15, T20, T25, T27, T30	⊗	x3	M4x4.0, M5x5.0, M6x5.0
⊕	x5	H2.5, H3, H4, H5, H6	⊗	x4	4, 6, 8, 10mm
⊖	x2	R1, R2	⊗	x2	R1, R2
⊙	x4	1, 2, 3, 4	⊗	x2	6.3 x 89, 8.1 x 89
⊛	x4	4, 6, 8, 10			



## JEU DE 7 TOURNEVIS ISOLÉS 1000V

**52519** 25,50€

0,14 5 10 840



### CONTIENT

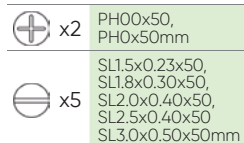

x2 PH00x50, PH0x50mm  
x5 SL1.5x0.23x50, SL1.8x0.30x50, SL2.0x0.40x50, SL2.5x0.40x50, SL3.0x0.50x50mm



CrV 7 PCS

## JEU DE TOURNEVIS AVEC EVA CARBONE MODULE

**15162** 30,20€

0,65 - 10 240



### PIÈCES DE RECHANGE DISPONIBLES

⊖ x4 0.5x3.0x75, 0.8x4.0x100, 1.0x5.5x125, 1.2x6.5x150mm  
+ x3 PH0x75, PH1x80, PH2x100mm

8 PCS

REF.	Ø	Kg	Sub	Box	Pallet	€
15227	0.5x3.0x75mm	0,02	10	50		3,50€
15228	0.8x4.0x100mm	0,05	10	50		4,00€
15229	1.0x5.5x125mm	0,08	5	50		5,00€
15230	1.2x6.5x150mm	0,11	5	50		5,00€
15231	PH0x75mm	0,02	10	50		3,50€
15232	PH1x80mm	0,05	10	50		4,00€
15233	PH2x100mm	0,08	5	50		5,00€
15234	Testeur Pour Circuit Automobile 140mm	0,02	10	50		3,00€

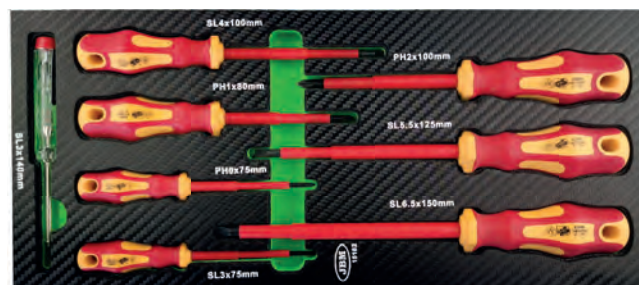

## COUTEAU ISOLANT

### DROIT

**53164** 16,50€

0,10 6 36 1152



### COURBÉ

**53165** 19,60€

0,10 6 36 1152



180mm  
50mm  
CrV







# OUTILLAGE À MAIN

- 34 CLÉS
- 41 OUTILS EN POUCES
- 42 TOURNEVIS
- 44 MESURE
- 45 CADENAS
- 46 MARTEAUX
- 47 SCIES
- 48 BURINS
- 49 RIVETEUSES
- 50 CLIQUETS
- 54 BARRES D'EXTENSION
- 55 OUTILS D'INSPECTION
- 57 COUPE-TUBE
- 57 PINCE À DÉNUDER
- 57 PINCES
- 63 CLÉS À CROCHET  
/ CASSE-ÉCROU  
/ ANGLAISES
- 64 CLÉS STILLSON  
/ SERGENT

# JEU DE CLÉS MIXTES AVEC CLIQUET

54101

61,00€

8x9, 10x11, 12x13, 14x15, 16x18, 17x19mm



6 PCS

0,90	-	10	750
Kg	Sub	ft	mm



## PIÈCES DE RECHANGE DISPONIBLES

REF.	mm	Kg	Sub	ft	mm	€
15632	8x9	0,15	10		9,35€	
15633	10x11	0,16	10		9,50€	
15634	12x13	0,19	10		10,60€	
15635	14x15	0,22	10		11,00€	
15636	16x18	0,26	5		12,30€	
15637	17x19	0,28	10		12,50€	



54117

74,00€

8,9,10,11,12,13,14,15,16,17,18,19mm



12 PCS

1,80	5	10	240
Kg	Sub	ft	mm



## PIÈCES DE RECHANGE DISPONIBLES

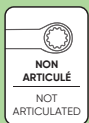

51318

98,00€

8, 9, 10, 11, 12, 13, 14, 15, 16, 17, 18, 19mm



12 PCS

2,15	5	10	240
Kg	Sub	ft	mm



## CHROMÉ



## PIÈCES DE RECHANGE DISPONIBLES



53017

57,00€

8, 10, 11, 13, 14, 17, 19mm



7 PCS

1,30	5	10	330
Kg	Sub	ft	mm



REF.	mm	Kg	Sub	ft	mm	€
10552	8mm	0,06	10		7,10€	
10553	9mm	0,07	10		7,35€	
10554	10mm	0,09	10		7,50€	

REF.	mm	Kg	Sub	ft	mm	€
10555	11mm	0,09	10		7,80€	
10556	12mm	0,11	10		8,10€	
10557	13mm	0,13	10		8,10€	

REF.	mm	Kg	Sub	ft	mm	€
10558	14mm	0,15	10		9,35€	
10559	15mm	0,16	10		9,50€	
10560	16mm	0,19	10		10,60€	

REF.	mm	Kg	Sub	ft	mm	€
10561	17mm	0,22	10		11,00€	
10562	18mm	0,26	5		12,30€	
10563	19mm	0,28	10		12,50€	

# ENSEMBLE DE 7 CLÉS EXTRA LONGUES AVEC CLIQUET

54066

83,00€

2,00	-	5	175
Kg	Sub	ft	mm

MODULE FINITION EN FIBRE DE CARBONE



## CHROMÉ



7 PCS

## PIÈCES DE RECHANGE DISPONIBLES



REF.	mm	Kg	Sub	ft	mm	€
13453	8mm	0,1	6		9,00€	
13454	10mm	0,15	6		9,50€	
13455	12mm	0,21	6		10,50€	
13456	13mm	0,20	6		11,50€	
13457	14mm	0,25	6		12,00€	
13460	17mm	0,4	6		15,00€	
13462	19mm	0,5	6		17,00€	

8mm (23,5mmL)
10mm (29,3mmL)
12mm (32,8mmL)
13mm (34,9mmL)
14mm (36,7mmL)
17mm (41mmL)
19mm (42mmL)

# SET DE 22 CLÉS COMBINÉES AVEC CLIQUET

**54041** 198,00€

900	-	2	42
Kg	Sub	11	11



6, 7, 8, 9, 10, 11, 12, 13, 14, 15, 16, 17, 18, 19, 20, 21, 22, 23, 24, 27, 30, 32mm

90° 22 PCS

PIÈCES DE RECHANGE DISPONIBLES



REF.54041, 54117, 15122, 53871  
PIÈCES DE RECHANGE DISPONIBLES

## MODULE EVA CARBONE DE 12 CLÉS AVEC CLIQUET

REF.	mm	Kg	Sub	11	€	REF.	mm	Kg	Sub	11	€
13463	6mm	0,03	10	5,30€	13474	17mm	0,19	10	8,70€		
13464	7mm	0,04	10	5,30€	13475	18mm	0,22	10	9,10€		
13465	8mm	0,05	10	5,55€	13476	19mm	0,22	10	9,60€		
13466	9mm	0,06	10	5,55€	13477	20mm	0,23	6	9,85€		
13467	10mm	0,1	10	6,00€	13478	21mm	0,37	6	12,20€		
13468	11mm	0,08	10	6,25€	13479	22mm	0,37	6	13,10€		
13469	12mm	0,09	10	6,25€	13480	23mm	0,37	6	15,50€		
13470	13mm	0,1	10	6,60€	13481	24mm	0,53	6	15,80€		
13471	14mm	0,11	10	6,90€	13482	27mm	0,6	6	22,10€		
13472	15mm	0,13	10	7,25€	13483	30mm	0,8	6	25,50€		
13473	16mm	0,15	10	8,10€	13484	32mm	1,12	6	27,20€		

**15122** 74,00€

1,70	-	10	200
Kg	Sub	11	11

8, 9, 10, 11, 12, 13, 14, 15, 16, 17, 18, 19mm

72° 12 PCS

CHROMÉ



PIÈCES DE RECHANGE DISPONIBLES



# SET DE 12 CLÉS COMBINÉES AVEC CLIQUET

**53871** 60,00€

1,60	2	6	288
Kg	Sub	11	11

PIÈCES DE RECHANGE DISPONIBLES



8, 9, 10, 11, 12, 13, 14, 15, 16, 17, 18, 19mm

72° 12 PCS

CHROMÉ



# JEU DE 12 CLÉS MIXTES COURTES ARTICULÉE AVEC CLIQUET

**54032** 84,00€

1,45	-	10	240
Kg	Sub	11	11

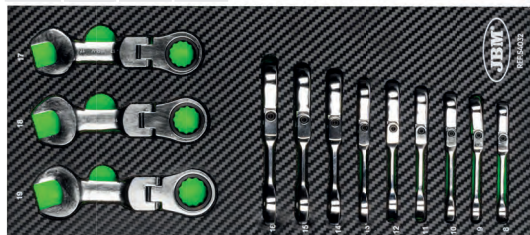

8, 9, 10, 11, 12, 13, 14, 15, 16, 17, 18, 19mm

90° 12 PCS

REF.	mm	Kg	Sub	11	€	REF.	mm	Kg	Sub	11	€
15328	8mm	0,05	12	6,00€	15334	14mm	0,11	12	7,00€		
15329	9mm	0,17	12	5,50€	15335	15mm	0,17	12	7,50€		
15330	10mm	0,22	12	5,50€	15336	16mm	0,22	12	8,00€		
15331	11mm	0,31	12	5,50€	15337	17mm	0,31	12	8,50€		
15332	12mm	0,45	12	6,00€	15338	18mm	0,45	12	9,00€		
15333	13mm	0,47	12	6,50€	15339	19mm	0,47	12	9,50€		

# JEU DE 8 CLÉS MIXTES COURTES AVEC CLIQUET

**54110** 46,00€

0,90	-	10	840
Kg	Sub	11	11



10, 11, 12, 13, 14, 15, 17, 19mm

72° 8 PCS

PIÈCES DE RECHANGE DISPONIBLES

REF.	mm	Kg	Sub	11	€
13491	10mm	0,5	10	5,30€	
13492	11mm	0,6	10	5,35€	
13493	12mm	0,7	10	5,50€	
13494	13mm	0,8	10	6,00€	
13495	14mm	0,9	10	6,40€	
13496	15mm	0,12	10	6,60€	
13497	17mm	0,14	10	7,50€	
13498	19mm	0,19	10	8,50€	

## JEU DE 6 CLÉS AVEC CLIQUET ARTICULÉES

53018 119,00€

2,66 - 5 125



CHROMÉ



8x9,10x11, 12x13,  
14x15, 16x18,  
17x19mm



6  
PCS

### PIÈCES DE RECHANGE DISPONIBLES

REF.	mm	Kg	PCS	€
13447	8x9mm	0,1	6	16,50€
13448	10x11mm	0,15	6	17,50€
13449	12x13mm	0,25	6	20,00€
13450	14x15mm	0,3	6	23,00€
13451	16x18mm	0,35	6	28,00€
13452	17x19mm	0,4	6	29,50€

## JEU DE 4 CLÉS POLIGONALES AVEC CLIQUET ARTICULÉES

50754 98,00€

0,82 - 20 360



CHROMÉ

- Tête articulée de 0° à 180°.
- Vilebrequin à 72 dents avec 5° d'arc.



E6 x E8  
E10 x E12  
E14 x E18  
E20 x E24



4  
PCS

### PIÈCES DE RECHANGE DISPONIBLES

REF.	mm	Kg	PCS	€
10527	E6x8	0,1	10	13,10€
10528	E10x12	0,15	10	15,80€
10529	E14x18	0,25	10	18,00€
10530	E20x24	0,35	10	28,70€

## KIT DE 3 CLÉS TYPE « 4 EN 1 »

15316 58,00€

0,85 - 10 260



CHROMÉ



8-9-10-11-12-13-  
14-15-16-17-18-  
19mm



3  
PCS

### PIÈCES DE RECHANGE DISPONIBLES

REF.	mm	Kg	€
15515	12-13mm x 8-10mm	0,13	15,50€
15516	14-15mm x 9-11mm	0,18	19,00€
15517	18-19mm x 16-17mm	0,37	22,50€

## COFFRET CLÉS A DOUILLES ARTICULÉES 6 PIÈCES 12 PANS

51659 59,00€

1,60 - 10 240



CHROMÉ



8x9, 10x11, 12x13,  
14x15, 16x17,  
18x19mm



6  
PCS

### PIÈCES DE RECHANGE DISPONIBLES

REF.	Ø	Kg	€
10621	XZN 8-9	0,09	9,50€
10622	XZN 10-11	0,13	10,00€
10623	XZN 12-13	0,16	12,60€
10624	XZN 14-15	0,20	13,50€
10625	XZN 16-17	0,29	15,70€
10626	XZN 18-19	0,37	17,80€

## COFFRET CLÉS A DOUILLES ARTICULÉES 4 PIÈCES TORX

50622 64,00€

1,05 - 10 320



CHROMÉ



E6x8, E10x12,  
E14x18, E20x24



4  
PCS

### PIÈCES DE RECHANGE DISPONIBLES

REF.	Ø	Kg	€
10617	E6x8	0,07	14,10€
10618	E10x12	0,11	15,10€
10619	E14x18	0,20	15,70€
10620	E20x24	0,34	16,20€

## JEU DE 21 CLÉS MIXTES

**54079** 83,00€

4,00 - 8 160

Kg SUB 11 160

CrV 21 PCS

6mm, 7mm, 8mm, 9mm, 10mm, 11mm, 12mm, 13mm, 14mm, 15mm, 16mm, 17mm, 18mm, 19mm, 20mm, 21mm, 22mm, 24mm, 27mm, 30mm, 32mm

REF. 54079

## JEU DE CLÉS PLATES MIXTES

14 CLÉS

**50560** 38,60€

1,25 5 20 240

Kg SUB 11 240

CrV 6, 7, 8, 9, 10, 11, 12, 13, 14, 15, 16, 17, 18, 19mm

**54097** 38,90€

1,40 - 10 570

Kg SUB 11 570

CrV 14 PCS

6, 7, 8, 9, 10, 11, 12, 13, 14, 15, 16, 17, 18, 19mm

ACIER ZINGUÉ

PIÈCES DE RECHANGE DISPONIBLES

ACIER ZINGUÉ	mm	Kg	Sub	11	€
10548	6mm	0,03	10	100	1,75€
10549	7mm	0,03	10	100	2,00€
10550	8mm	0,04	10	100	2,15€
10551	9mm	0,04	10	100	2,15€
10531	10mm	0,05	10	100	3,00€

ACIER ZINGUÉ	mm	Kg	Sub	11	€
10532	11mm	0,05	10	100	2,70€
10533	12mm	0,07	10	100	3,00€
10534	13mm	0,08	10	100	3,25€
10535	14mm	0,06	10	100	3,50€
10536	15mm	0,10	10	100	3,65€

ACIER ZINGUÉ	mm	Kg	Sub	11	€
10537	16mm	0,11	10	100	3,90€
10538	17mm	0,14	10	100	4,30€
10539	18mm	0,16	10	100	4,75€
10540	19mm	0,20	10	60	5,25€

## JEU DE 7 CLÉS PLATES MIXTES

**54120** 59,00€

2,89 - 6 252

Kg SUB 11 252

CrV 20, 21, 22, 24, 27, 30, 32mm

7 PCS

PIÈCES DE RECHANGE DISPONIBLES

ACIER ZINGUÉ	mm	Kg	Sub	11	€
10541	20mm	0,21	60	5,55€	
10542	21mm	0,25	50	5,85€	
10543	22mm	0,25	50	7,00€	
10544	24mm	0,33	50	8,10€	
10545	27mm	0,41	50	9,75€	
10546	30mm	0,52	25	11,60€	
10547	32mm	0,59	25	13,50€	

## JEU DE 6 CLÉS PLATES MIXTES

**54174** 139,00€

8,70 - 2 750

Kg SUB 11 750

XL CrV 34, 36, 38, 41, 46, 50mm

6 PCS

PIÈCES DE RECHANGE DISPONIBLES

ACIER ZINGUÉ	mm	Kg	Sub	11	€
16020	34mm	0,21	-	17,00€	
16021	36mm	0,25	-	19,50€	
16022	38mm	0,41	-	23,00€	
16023	41mm	-	-	26,50€	
16024	46mm	-	-	34,50€	
16025	50mm	-	-	37,50€	

## JEU DE 10 CLÉ À PIED-DE-BICHE 3/8"

**54187** 39,30€

0,55 5 20 1800

Kg SUB 11 1800

CrV 10, 11, 13, 14, 15, 16, 17, 18, 19, 22mm

3/8"

# JEU DE 8 CLÉS PLATES MIXTES SÉRIE COURTE

**50564** 30,00€

0,60	5	20	600
Kg	sub	ff	



**8**  
PCS

10, 11, 12,  
13, 14, 15, 17,  
19mm



## CHROMÉ



### PIÈCES DE RECHANGE DISPONIBLES

REF.	mm	Kg	sub	ff	€
10564	10	0,05	10	100	2,50€
10565	11	0,05	10	100	3,50€
10566	12	0,05	10	100	3,50€
10567	13	0,05	10	100	3,50€
10568	14	0,05	10	100	4,00€
10569	15	0,05	10	100	4,50€
10570	17	0,10	10	100	4,50€
10571	19	0,15	10	100	5,00€

## CLÉS PLATES

12 CLÉS

6x7, 8x9, 10x11, 12x13, 14x15, 16x17, 18x19,  
20x22, 21x23, 24x27, 25x28, 30x32mm



**12**  
PCS

ACIER ZINGUÉ

**51529** 59,00€

2,63	-	5	200
Kg	sub	ff	

CHROMÉ

**52973** 59,00€

2,50	-	5	160
Kg	sub	ff	

### PIÈCES DE RECHANGE DISPONIBLES

REF.	mm	Kg	sub	ff	€
10589	6x7	0,03	10	100	2,00€
10590	8x9	0,04	10	100	2,40€
10579	10x11	0,06	10	100	3,00€
10580	12x13	0,07	10	100	3,10€
10581	14x15	0,10	10	100	3,40€
10582	16x17	0,14	10	100	4,00€
10583	18x19	0,19	10	100	4,15€
10584	20x22	0,25	60	100	5,05€
10585	21x23	0,31	-	50	6,75€
10586	24x27	0,35	-	50	7,60€
10587	25x28	0,36	-	50	9,80€
10588	30x32	0,54	-	25	10,50€



7 CLÉS

6x7, 8x9, 10x11, 12x13, 14x15,  
16x17, 18x19mm



**7**  
PCS

ACIER ZINGUÉ

**50561** 19,20€

0,69	5	20	400
Kg	sub	ff	

### PIÈCES DE RECHANGE DISPONIBLES

REF.	mm	Kg	sub	ff	€
10589	6x7	0,03	10	100	2,00€
10590	8x9	0,04	10	100	2,40€
10579	10x11	0,06	10	100	3,00€
10580	12x13	0,07	10	100	3,10€
10581	14x15	0,10	10	100	3,40€
10582	16x17	0,14	10	100	4,00€
10583	18x19	0,19	10	100	4,15€



12 CLÉS

**54149** 60,00€

2,75	-	6	240
Kg	sub	ff	

6x7, 8x9, 10x11, 12x13, 14x15, 16x17, 18x19,  
20x22, 21x23, 24x27, 25x28, 30x32mm

**12**  
PCS

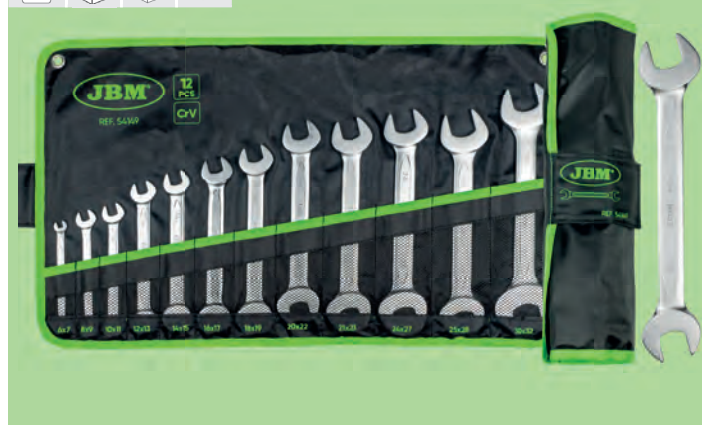

7 CLÉS

**54150** 23,50€

0,75	10	20	720
Kg	sub	ff	

6x7, 8x9, 10x11, 12x13, 14x15,  
16x17, 18x19mm

**7**  
PCS



### PIÈCES DE RECHANGE DISPONIBLES

ACIER ZINGUÉ	mm	Kg	sub	ff	€
10589	6x7	0,03	10	100	2,00€
10590	8x9	0,03	10	100	2,40€
10579	10x11	0,06	5	100	3,00€

ACIER ZINGUÉ	mm	Kg	sub	ff	€
10580	12x13	0,07	10	100	3,10€
10581	14x15	0,10	10	100	3,40€
10582	16x17	0,14	10	100	4,00€

ACIER ZINGUÉ	mm	Kg	sub	ff	€
10583	18x19	0,19	10	100	4,15€
10584	20x22	0,25	-	100	5,05€
10585	21x23	0,31	-	50	6,75€

ACIER ZINGUÉ	mm	Kg	sub	ff	€
10586	24x27	0,35	-	50	7,60€
10587	25x28	0,36	-	50	9,80€
10588	30x32	0,54	-	25	10,50€

## JEU 8 CLÉS TIP C DEMI LUNE 12 PANS

52451 42,00€

0,93	5	20	480
Kg	Sub	ff	ff

CHROMÉ



PIÈCES DE RECHANGE DISPONIBLES



54159 47,00€

1,05	-	10	460
Kg	Sub	ff	ff

6x7, 8x9, 10x11, 12x13, 14x15, 16x17, 18x19, 20x22mm



## JEU DE 4 CLÉS TORX PLATES

54115 26,80€

0,35	-	10	50
Kg	Sub	ff	ff

E6xE8, E10xE12, E14xE18, E20xE24

4 PCS

CHROMÉ



## JEU DE CLÉS PLATES MIXTES 6 PANS

54081 28,00€

0,75	-	10	750
Kg	Sub	ff	ff

10 x 11 HEX, 12 x 13 HEX, 14 x 15 HEX, 16 x 17 HEX, 18 x 19 HEX

5 PCS



## JEU DE CLÉS À OEIL CONTRE COUDÉE 12 PANS

12 CLÉS

CHROMÉ

54119 78,00€

3,20	-	6	168
Kg	Sub	ff	ff

6x7, 8x9, 10x11, 12x13, 14x15, 16x17, 18x19, 20x22, 21x23, 24x27, 25x28, 30x32mm

12 PCS



PIÈCES DE RECHANGE DISPONIBLES

ACIER ZINGUÉ	mm	Kg	Sub	ff	ff	€
10627	6x7	0,04	10	100	2,80€	
10628	8x9	0,06	10	100	3,10€	
10629	10x11	0,08	10	100	3,65€	

ACIER ZINGUÉ	mm	Kg	Sub	ff	ff	€
10630	12x13	0,11	10	100	3,90€	
10631	14x15	0,14	10	100	4,20€	
10632	16x17	0,18	10	100	5,30€	

7 CLÉS

ACIER ZINGUÉ

50562 23,50€

0,87	5	20	560
Kg	Sub	ff	ff

6x7, 8x9, 10x11, 12x13, 14x15, 16x17, 18x19mm

7 PCS



50562



## JEU DE 4 CLÉS FERMÉES DOUBLE FACE PLATEAU EN EVA EN FIBRE DE CARBONE

15156 70,00€

2,05	-	10	180
Kg	Sub	ff	ff

CHROMÉ

PIÈCES DE RECHANGE DISPONIBLES

REF.	mm	Kg	Sub	ff	ff	€
15206	21x23	0,45	5	50	15,00€	
15207	24x27	0,5	5	50	16,50€	
15208	25x28	0,45	5	50	17,00€	
15209	30x32	0,67	10	50	18,00€	



4 PCS

21x23, 24x27, 25x28, 30x32mm



TVA non comprise

JBM / www.jbmfrance.fr

39

## JEUX DE 6 CLÉS PLATES EXTRA LONGUES

**51864** 64,00€

1,87	-	10	210
Kg	SUB	ff	

10x11mm (290mmL),  
12x14mm (330mmL),  
13x15mm (368mmL),  
16x18mm (407mmL),  
17x19mm (407mmL),  
22x24mm (430mmL)



**6 PCS**

**52912** 91,00€

1,62	-	10	210
Kg	SUB	ff	

E6xE7 (200mmL),  
E8xE10 (235mmL),  
E11xE12 (290mmL),  
E14xE16 (370mmL),  
E18xE20 (410mmL),  
E22xE24 (420mmL)

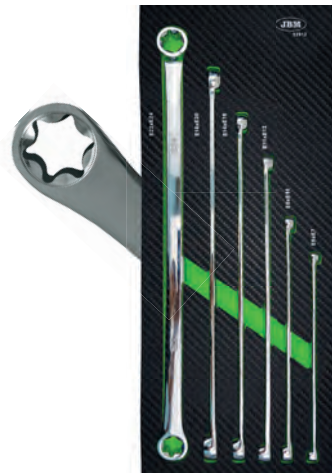

**6 PCS**

CHROMÉ

### PIÈCES DE RECHANGE DISPONIBLES

REF.	Ø	Kg	€
11244	XL XZN 10x11 0,13	5	8,50€
11245	XL XZN 12x14 0,18	-	9,15€
11246	XL XZN 13x15 0,25	6	12,40€
11247	XL XZN 16x18 0,30	6	14,00€
11248	XL XZN 17x19 0,31	6	14,60€
11249	XL XZN 22x24 0,43	6	26,50€

## JEU DE 14 CLÉS PIPE À DOUBLE BOUCHE

**51528** 49,00€

3,55	-	5	270
Kg	SUB	ff	

ACIER ZINGUÉ

REFmm	Ø	Kg	€
10603	8 0,07	2,10€	
10604	9 0,08	2,25€	
10591	10 0,09	2,50€	
10592	11 0,12	2,55€	
10593	12 0,16	3,15€	
10594	13 0,17	3,20€	
10595	14 0,20	3,35€	
10596	15 0,25	4,25€	
10597	16 0,30	4,50€	

REF.	mm	Kg	€
10598	17 0,32	4,60€	
10599	18 0,43	6,00€	
10600	19 0,41	6,25€	
10601	20 0,45	6,50€	
10602	21 0,47	7,05€	

### PIÈCES DE RECHANGE DISPONIBLES



8, 9, 10, 11, 12, 13, 14, 15,  
16, 17, 18, 19, 20, 21mm



**14 PCS**

## SET DE 8 CLÉS EN TUBE

**53420** 72,00€

1,50	-	20	540
Kg	SUB	ff	

ACIER ZINGUÉ

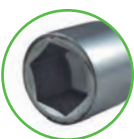

6x7, 8x9, 10x11, 12x13, 14x15,  
16x17, 18x19, 20x22mm



**8 PCS**

## COFFRET DE 8 CLÉS TORX POIGNOTÉE

**53979** 34,60€

1,00	-	10	180
Kg	SUB	ff	

T10x75,  
T15x75,  
T20x100,  
T25x100,  
T30x150,  
T40x150,  
T45x200,  
T50x200mm



## COFFRET DE 8 CLÉS 6 PANS POIGNOTÉE

**53980** 34,60€

1,00	-	10	180
Kg	SUB	ff	

H2x100  
H2.5x100  
H3x100  
H4x150  
H5x150  
H6x200  
H8x200  
H10x200





# KIT DE 9 BUSES



## EXTRA LONGUES

**53737** 12,50€

0,42	10	40	1000
Kg	sub	ff	



90-218mm

## LONGUES

**53739** 10,50€

0,32	10	40	1440
Kg	sub	ff	



86-150mm

## COURTES

**53955** 10,00€

0,25	10	40	1480
Kg	sub	ff	



72-170mm

T10, T15, T20, T25, T27, T30, T40, T45, T50

53737/53739/53955



## EXTRA LONGUES

**53738** 10,90€

0,45	10	40	1000
Kg	sub	ff	



90-220mm

## LONGUES

**53740** 9,10€

0,37	10	40	1200
Kg	sub	ff	



72-170mm

## COURTES

**53954** 8,50€

0,25	10	40	1480
Kg	sub	ff	



43-97mm

1,5, 2, 2,5, 3, 4, 5, 6, 8, 10mm

53738/53740/53954

# OUTILS EN POUCE

## JEU DE 17 CLÉS MIXTES EN POUCE

**51890** 92,00€

ACIER ZINGUÉ

17 PCS

4,45	-	4	168
Kg	sub	ff	



## JEU DE 9 CLÉS ALLEN EN POUCE

**54005** 14,00€

72-170mm

9 PCS

CrV

0,35	10	40	1200
Kg	sub	ff	



1/16", 5/64", 3/32", 1/8", 5/32", 3/16", 1/4", 5/16", 3/8"

## COFFRET DE DOUILLES 37 PIÈCES EN POUCE

**54106** 89,00€

CrV 1/2" 1/4" 37 PCS

4,70	-	3	108
Kg	sub	ff	

### CONTIENT

	1/2"	x17	5/16", 3/8", 7/16", 1/2", 9/16", 19/32", 5/8", 11/16", 3/4", 13/16", 7/8", 15/16", 1", 1-1/16", 1-1/8", 1-3/16", 1-1/4"
	1/4"	x8	3/16", 7/32", 1/4", 9/32", 5/16", 11/32", 3/8", 7/16"
	53076	x2	1/2" - 1/4"
	1/2"	x2	5", 10"
	1/4"	x1	3"
		x1	1/2"



	x1	1/4"
	x2	1/2" - 1/4"
	x1	1/4"

# KIT DE 208 EMBOUTS

**53574** 47,00€

2,29	-	6	216
Kg	Sub	ff	



**208**  
PCS  
**CrV**

## CONTIENT

25mmL	x12	1,5, 2, 2,5, 3, 3,5, 4, 4,5, 5, 5,5, 6, 7, 8mm	25mmL	x4	4, 6, 8, 10mm
	x10	1/16, 5/64, 3/32, 7/64, 1/8, 9/64, 5/32, 3/16, 7/32, 1/4	50mmL	x4	4, 6, 8, 10mm
50mmL	x5	2,5, 3, 4, 5, 6mm	25mmL	x4	1, 2, 3, 4mm
75mmL	x5	2,5, 3, 4, 5, 6mm	50mmL	x4	1, 2, 3, 4mm
25mmL	x18	PH00, PH0, PH1(x5), PH2(x5), PH3(x5), PH4	25mmL	x6	2, 2,5, 3, 4, 5, 6mm
50mmL	x3	PH1, PH2, PH3	25mmL	x6	5/64, 3/32, 7/64, 1/8, 9/64, 5/32
75mmL	x3	PH1, PH2, PH3	25mmL	x13	T5, 6, 7, 8, 9, 10, 15, 20, 25, 27, 30, 40, 45
25mmL	x17	PZ00, PZ0, PZ1(x5), PZ2(x5), PZ3(x4), PZ4	25mmL	x3	1, 2, 3mm
50mmL	x3	PZ1, PZ2, PZ3	25mmL	x4	0, 1, 2, 3mm
75mmL	x3	PZ1, PZ2, PZ3	25mmL	x3	M5, M6, M8
25mmL	x14	T5, T6, T7, T8, T9, T10, T15, T20, T25, T27, T30, T35, T40, T45	25mmL	x9	TS10, TS15, TS20, TS25, TS27, TS30, TS40, TS45, TS50
50mmL	x7	T10, T15, T20, T25, T27, T30, T40	25mmL	x12	SL2, SL2,5, SL3, SL3,5, SL4, SL4,5, SL5, SL5,5, SL6, SL6,5, SL7, SL8
75mmL	x7	T10, T15, T20, T25, T27, T30, T40			
25mmL	x3	6, 8, 10mm			
50mmL	x3	6, 8, 10mm			

mm	x10	4, 5, 6, 7, 8, 9, 10, 11, 12, 13
-	x10	5/32, 3/16, 7/32, 1/4, 9/32, 5/16, 1/2
6mm	x1	1/4"
		x1

# COFFRET DE TOURNEVIS DE PRECISION - COURTES ET LONGUES

**52500** 19,00€

0,33	-	60	720
Kg	Sub	ff	

**8**  
PCS



## COURTES

+	x3	PH00x25, PH0x25, PH1x25
-	x5	SLO.4x2x25, SLO.4x2,5x25, SLO.5x3x25, SLO.5x3,5x25, SLO.8x4x25

**53917** 9,00€

0,20	5	50	950
Kg	Sub	ff	

**7**  
PCS



## LONGUES

+	x3	PH00, PH0, PH1
-	x4	SL1,4, SL2,0, SL2,4, SL3,0

# ETUI DE TOURNEVIS AVEC MANCHE INTERCHANGEABLE

**53010** 18,00€

0,72	5	20	480
Kg	Sub	ff	

**11**  
PCS



POIGNÉE ERGONOMIQUE

## CONTIENT

+	x2	PH1, PH2
-	x2	4x6, 5x7mm
*	x3	T10x15, T20x25, T30x40
*	x3	H4x4mm, Tête sphérique H5x5mm, Tête sphérique H6x6mm, Tête sphérique

# JEU DE 4 TOURNEVIS À FRAPPER PLATS

**50902** 13,00€

0,70	6	42	648
Kg	Sub	ff	

3", 4", 6", 8"

**4**  
PCS



# TOURNEVIS RÉVERSIBLE PLAT-CRUCIFORME

**54060** 6,00€

0,15	10	60	1500
Kg	Sub	ff	

SL6x150mm  
PH2x150mm



**54061** 6,00€

0,10	10	60	1800
Kg	Sub	ff	

SL6x100mm  
PH2x100mm



# TOURNEVIS À FRAPPER DE 1/2"

**53694** 18,40€

1,00	6	24	936
Kg	Sub	ff	

**CrV** **1/2"** **8**  
PCS

## CONTIENT

1/2"	x1	+	x3	PH 2x36mm, 3x36mm, 3x70mm
1/2"	x1	-	x3	SL 7x36mm, 8x36mm, 8x70mm



## JEU DE 6 TOURNEVIS À TRAVERS

**54071** 26,50€

1.10	-	10	270
Kg	SUB	ff	ff



SL8x150mm  
SL6.5x100mm  
SL5.5x75mm  
PH3x150mm  
PH2x100mm  
PH1x75mm

X3 X3

## JEU DE 6 TOURNEVIS

**54070** 18,00€

0.50	-	10	360
Kg	SUB	ff	ff

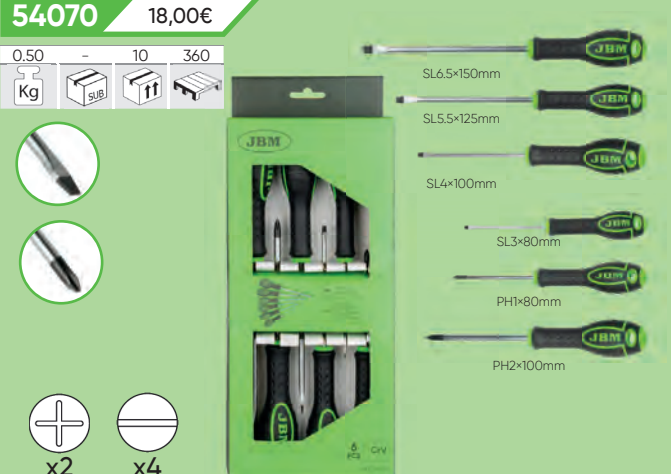

SL6.5x150mm  
SL5.5x125mm  
SL4x100mm  
SL3x80mm  
PH1x80mm  
PH2x100mm

x2 x4

## JEU DE TOURNEVIS À FRAPPER MAGNETIQUE

**54126** 39,00€

2.75	-	4	108
Kg	SUB	ff	ff



12 PCS

x6  
PH0x75mm  
PH1x75mm  
PH2x38mm  
PH2x100mm  
PH3x125mm  
PH4x150mm

x6  
SL3.2x75mm  
SL5x75mm  
SL6x38mm  
SL6x100mm  
SL8x150mm  
SL9.5x200mm

## JEU DE TOURNEVIS AVEC EVA CARBONE MODULE

**53943** 21,50€

0.80	-	10	240
Kg	SUB	ff	ff

180mm 380mm 30mm

x7 PH4x200, PH3x150, PH2x100, PH2x38, PH1x80, PH0x120, PH1x100

**53944** 19,50€

0.80	-	10	240
Kg	SUB	ff	ff

x7 SL9x200, SL4x125, SL5x100, SL5x80, SL6x38, SL6x100, SL8x150mm

**53945** 18,90€

0.60	-	10	240
Kg	SUB	ff	ff

x7 T8x75, T9x75, T10x75, T15x75, T20x75, T25x100, T27x100



## TOURNEVIS FLEXIBLES AVEC EMBOUTS

**52170** 16,00€

0.27	12	48	672
Kg	SUB	ff	ff

1/4" 7 PCS

4, 5, 6, 7, 8, 10mm



## JEU DE 3 TOURNEVIS FLEXIBLES PORTE EMBOUTS

**52169** 25,00€

0.45	12	48	672
Kg	SUB	ff	ff

3 PCS

6, 7, 8mm



## TOURNEVIS FLEXIBLES AVEC EMBOUTS

**53575** 16,00€

0.40	10	40	480
Kg	SUB	ff	ff

CrV 1/4" 4 PCS

500mm

4, 5, 7mm



TVA non comprise

D'ALUMINIUM

**53613** 19,50€

0.55	5	30	1260
Kg	sub	ff	

500mm

**53614** 21,50€

0.60	5	30	840
Kg	sub	ff	

600mm

**53615** 34,60€

0.85	5	20	600
Kg	sub	ff	

800mm



D'ALUMINIUM MAGNETISÉ

**53616** 10,40€

0.30	5	60	1260
Kg	sub	ff	

500mm

**53617** 9,25€

0.30	5	60	840
Kg	sub	ff	

600mm

**53618** 13,90€

0.35	5	30	600
Kg	sub	ff	

800mm

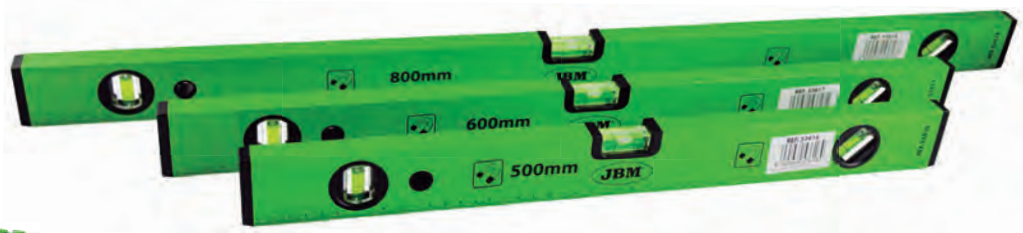

EXPOSANT POUR LES NIVEAUX

**14183** 31,00€

0.80	10
Kg	ff



MÈTRES AUTOBLOQUANTS

**53027** 9,00€

0.40	12	48	1500
Kg	sub	ff	

7,5M x25mm

**53026** 5,80€

0.26	12	48	2016
Kg	sub	ff	

5M x25mm

**53025** 3,50€

0.13	12	48	2016
Kg	sub	ff	

3M x16mm



CUTTER PROFESSIONNEL

**51909** 2,46€

0.07	24	192	2304
Kg	sub	ff	

10cm

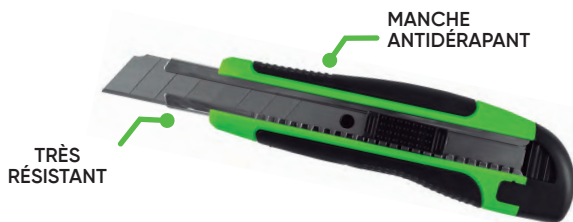

MANCHE ANTIDÉRAPANT

TRÈS RÉSISTANT



PRÉSENTOIR DE 24 UNITÉS

## CADENAS

**53405** 5,30€

0,10	8	96	3168
Kg	Sub	ff	ff

32mm



LONG

**53403** 6,50€

0,15	8	96	3168
Kg	Sub	ff	ff

38mm



**53404** 6,50€

0,15	8	96	3168
Kg	Sub	ff	ff

38mm



**53406** 8,55€

0,30	8	48	3168
Kg	Sub	ff	ff

50mm



**53409** 9,00€

0,30	8	48	3168
Kg	Sub	ff	ff

50mm



**53407** 12,70€

0,35	8	48	3168
Kg	Sub	ff	ff

63mm

**53408** 19,30€

0,48	3	24	840
Kg	Sub	ff	ff

75mm

## CADENAS RESISTANT À L'EAU

**53399** 3,50€

0,90	8	48	3168
Kg	Sub	ff	ff

30mm



**53400** 5,70€

0,20	8	48	499
Kg	Sub	ff	ff

40mm



x2



**53401** 7,40€

0,35	8	48	499
Kg	Sub	ff	ff

50mm



**53402** 9,60€

0,05	10	40	499
Kg	Sub	ff	ff

65mm

AVEC  
COUVERCLE  
PROTECTEUR

**PIÈCES DÉTACHÉS  
OUTRILS MANUELS  
2023**

Téléchargez ici notre  
catalogue de pièces  
détachées 2023

[www.jbmcamp.com](http://www.jbmcamp.com)

## MARTEAU

AVEC MANCHE EN PLASTIQUE

**52182** 24,00€

**2 Kg**

2,20 6 12 504  
Kg SUB ff

297mm

**52184** 43,00€

**4 Kg**

4,31 - 4 128  
Kg SUB ff

880mm

**52185** 55,00€

**6 Kg**

6,97 - 4 72  
Kg SUB ff

895mm

**52186** 72,00€

**8 Kg**

8,68 - 2 78  
Kg SUB ff

900mm



## MARTEAUX

MARTEAU DE MÉCANICIEN

**51674** 7,75€

0,60 6 36 864  
Kg SUB ff

**505 g**



**52565** 11,50€

1,13 6 24 720  
Kg SUB ff

**1 Kg**



MARTEAU À BOULE

**51918** 12,50€

1,25 6 18 432  
Kg SUB ff

**1 Kg**



**51504** 8,50€

0,55 4 40 800  
Kg SUB ff

**454 g**

MARTEAUX ASSORTIS - MODULE EVA CARBONE

**15799** 28,30€

1,35 - 10 200  
Kg SUB ff



## MARTEAU ANTI-REBOND

**52180** 19,00€

**1,45 Kg**

355mm

1,45 6 12 432  
Kg SUB ff

**52183** 26,20€

**2,30 Kg**

405mm

2,30 6 12 288  
Kg SUB ff



**52181** 22,50€

**1,80 Kg**

370mm

1,81 6 12 300  
Kg SUB ff

## MARTEAU EN NYLON ANTI-REBOND

**52425** 33,30€

Ø 40mm

0,70 6 12 768  
Kg SUB ff

**52426** 52,00€

Ø 60mm

1,50 2 12 288  
Kg SUB ff

**52427** 64,00€

Ø 70mm

2,02 2 12 204  
Kg SUB ff



EMBOUTS EN NYLON DE RECHANGE

REF.	Ø	Kg	Sub	ff	€
11212	40mm	0,02	5	100	5,00€
11213	60mm	0,08	5	50	10,60€
11214	70mm	0,11	5	100	12,50€



## HACHE ET HACHETTE AVEC MANCHE EN BOIS

**52188** 15,50€



**52460** 16,60€

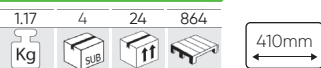

**52461** 25,70€



## SCIE EN ARC AVEC POIGNÉE ERGONOMIQUE

**52830** 24,00€

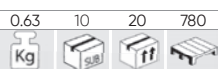

PRÉSENTOIR DE 10 UNITÉS

## SCIE EN ARC

**52831** 18,00€

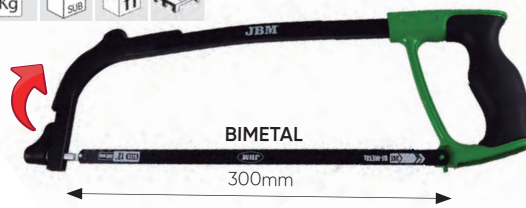
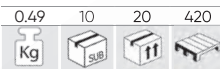

PRÉSENTOIR DE 10 UNITÉS



FEUILLE POUR SCIE POUR REF. 52830 / 52831 / 51675

**12060** 2,50€

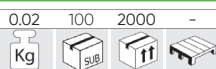

## JEU DE 5 LIMES EN ACIER

**51853** 18,00€



## SET DE 3 SPATULES EN ACIER

**51951** 15,60€

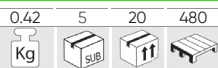

- Poignée ergonomique.



## COFFRET DE 4 SPATULES EN ACIER

**53339** 9,50€

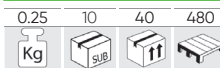

## BURINS

53120 6,00€

0,35 6 24 1200  
Kg SUB ITT

150mm



ACIER  
45C

## JEU DE 4 BURINS

53083 64,00€

1,04 10 20 960  
Kg SUB ITT



ACIER  
SNCRM+V

18x125,  
21x150,  
26x200,  
29x250mm

## SET DE 5 BURINS

54089 17,50€

0,50 10 40 2240  
Kg SUB ITT

10, 11, 12, 14, 16mm



5  
PCS

## PLATEAU POUR CISEAUX ET PERFORATEURS

15737 45,00€

1,70 - 10 200  
Kg SUB ITT

9  
PCS



Contenu :

- Ciseau à bois : 12 x 160, 16 x 175, 19 x 180 mm
- Ciseau à cape : 6 x 180 mm
- Poinçon central : 6 x 180, 8 x 180, 10 x 180 mm
- Poinçon à goupille parallèle : 8 x 180, 10 x 180 mm

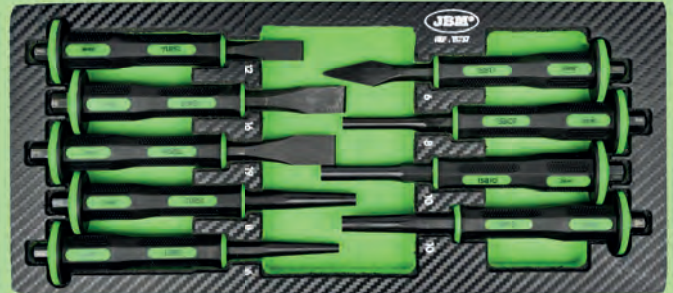

## JEU DE 5 POINTEAUX

52049 14,00€

0,40 10 40 3840  
Kg SUB ITT

3, 4, 5, 6, 7mm



150mm

ACIER  
45C

## JEU DE 6 CHASSES GOUPILES

53095 20,50€

0,75 6 24 1152  
Kg SUB ITT

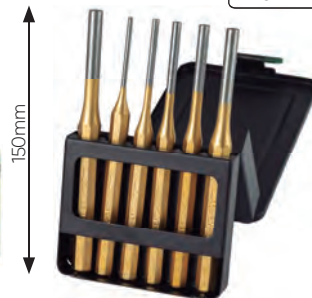

150mm

CrV

3, 4, 5, 6, 7,  
8mm

## JEU DE 5 CHASSES GOUPILES

54099 13,80€

0,45 10 40 2240  
Kg SUB ITT

4, 5, 6, 7, 8mm



## RIVETEUSE ARTICULÉE MULTI-FONCTIONNELLE

53993 77,00€

1,95 5 20 240  
Kg SUB ITT

- Tête rotative à 360°
- Compact, permet de travailler facilement dans de petits espaces
- Conçu pour une utilisation à une main

Comprend :

- Embouts de rivets standards 2,4 mm (3/32") - 3,2 mm (1/8") - 4,0 mm (5/32") - 4,8 mm (3/16")
- Poinçons pour écrous à riveter M3x0,5 - M4x0,7 - M5x0,8 - M6x1
- Poinçons pour rivets M6x1 - M5x0,8 - M4x0,7 - 3 clés 5,5x8,5 mm - 12x17 mm - 15x19 mm
- Porte-broche M6x1 - M5x0,8 - M4x0,7 - M3x0,5



M3x0,5  
M4x0,7  
M5x0,8  
M6x1

2,4mm (3/32")  
4,0mm (5/32")  
4,8mm (3/16")





## RIVETEUSE POUR EMBOUTS FILETÉS COMPACTE 200MM/8"

52595 64,00€

1.30 - 10 280

Kg SUB if

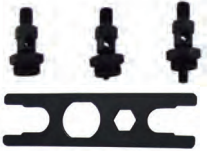

300mm



8"

## RIVETEUSE COMPACTE 200MM / 8"

52462 25,30€

0.55 5 30 600

Kg SUB if



MODULE EVA  
DE RIVETEUSE +  
RIVETS POUR SERVANTE D'OUTILS

13667 17,60€

0.83 - 10 360

Kg SUB if



200mm

8"

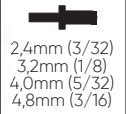

## RIVETEUSE 300MM / 12"

52463 26,10€

0.74 5 20 240

Kg SUB if



300mm

12"



## RIVETEUSE 400MM/16"

52464 42,00€

1.25 5 10 180

Kg SUB if



400mm

16"

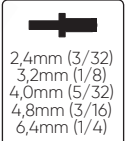

## RIVETEUSE POUR EMBOUTS FILETÉS 400MM / 16"

52596 114,00€

3.07 - 5 60

Kg SUB if



400mm

16"



## RIVETEUSE EMBOUTS FILETÉS AUTOMATIQUE 440MM / 17"

52597 146,00€

3.25 - 5 80

Kg SUB if

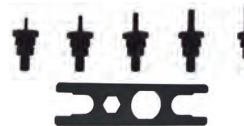

440mm

17"



## PIÈCES DE RECHANGE POUR 52595, 52596, 52597



REF.	CARACTÉRISTIQUES	Kg	if	€
13226	M3	0,03	100	4,50€
13227	M4	0,04	100	4,50€
13228	M5	0,04	100	4,50€
13229	M6	0,04	50	4,50€

REF.	CARACTÉRISTIQUES	Kg	if	€
13230	M8	0,04	50	4,50€
13231	M10	0,05	100	4,50€
13232	M12	0,05	100	4,50€

TVA non comprise

## RIVETEUSE 10"

**53331** 31,80€

0,80	5	20	280
Kg	Sub	ff	

250mm 10"

2,4mm (3/32)  
3,2mm (1/8)  
4,0mm (5/32)  
4,8mm (3/16)  
6,4mm (1/4)



## RIVETEUSE EXTENSIBLE 8"

**53332** 34,50€

1,65	5	10	280
Kg	Sub	ff	

200mm 8"

2,4mm (3/32)  
3,2mm (1/8)  
4,0mm (5/32)  
4,8mm (3/16)



## RIVETEUSE + RIVETS EN PLASTIQUE

**52609** 29,00€

0,45	5	20	300
Kg	Sub	ff	



Ø 6,6mm x 17,2mm (10 u.)  
Ø 6,3mm x 25,2mm (10 u.)  
Ø 5mm x 17,2mm (10 u.)  
Ø 5mm x 15,8mm (10 u.)



### RIVETS EN PLASTIQUE

REF.	Ø	Kg	Sub	ff	€
13674	6x19,3mm	0,01	25	1.000	0,50€
13675	6x17,8mm	0,01	25	1.000	0,50€
13676	6x25,5mm	0,01	25	1.000	0,50€
13677	6x24,5mm	0,01	25	1.000	0,50€
13678	6x24mm	0,01	25	1.000	0,50€

## RIVETEUSE PNEUMATIQUE

**52575** 119,00€

1,75	5	10	140
Kg	Sub	ff	



2,4mm (3/32), 3,2mm (1/8)  
4,0mm (5/32), 4,8mm (3/16)

- Traction: 1586LBS / 720 KGS.
- Longueur tige: 9/16" - 14mm.
- Max. serrer 60FT IB / 23-69NM.
- Entree d'air: 1/4"
- Consommation moyenne d'air: 0.03CFM/0.86L/MIN.

- Inclu:
- 2 Multioutils
  - Crochet rapide
  - Joints torique
  - Recipient arriere

0,50€  
0,50€  
0,50€  
0,50€  
0,50€



INSERTS DISPONIBLES SUR LA PAGE 51,319

## CLIQUET 72 DENTS AVEC DOUILLES

**54030** 18,80€

0,35	6	36	1008
Kg	Sub	ff	

1/4" 4, 5, 6, 7, 8, 9, 10, 11, 12, 13mm

**54031** 19,30€

0,35	6	36	864
Kg	Sub	ff	

1/4" 4, 5, 6, 7, 8, 9, 10, 11, 12, 13mm

**54028** 28,00€

1,30	4	24	432
Kg	Sub	ff	

1/2" 10, 11, 12, 13, 14, 15, 16, 17, 18, 19mm

**54029** 28,00€

1,25	4	24	432
Kg	Sub	ff	

1/2" 10, 11, 12, 13, 14, 15, 16, 17, 18, 19mm



# KIT DE 3 CLIQUETS RACCOURCIS

**53671** 41,00€

0,85 - 10 470

Kg SUB

- Pièces incluses:  
Poignée courte à cliquet 1/4"  
Poignée courte à cliquet 1/2"  
Poignée courte à cliquet 3/8"

PRÉSENTATION À EVA



72 3 PCS



KIT DE RÉPARATION POUR CLÉ À CLIQUET 1/2"			KIT DE RÉPARATION POUR CLÉ À CLIQUET 3/8"			KIT DE RÉPARATION POUR CLÉ À CLIQUET 1/4"		
15140	0,20	50	15139	0,15	50	15138	0,10	50
13,50€	Kg	11	12,00€	Kg	11	10,50€	Kg	11

## CLIQUET 72 DENT

CHROMÉ

**54022** 9,95€

0,15 12 36 2268

Kg SUB

1/4" 145mm

**54023** 13,50€

0,30 12 24 1440

Kg SUB

3/8" 200mm

**54024** 17,90€

0,60 12 24 960

Kg SUB

1/2" 255mm

ACIER ZINGUÉ

**54018** 9,85€

0,15 12 36 2016

Kg SUB

1/4" 145mm

**54021** 13,50€

0,60 12 24 1440

Kg SUB

3/8" 200mm

**54019** 17,90€

0,60 12 24 864

Kg SUB

1/2" 255mm



PRÉSENTOIR DE 12 UNITÉS



PRÉSENTOIR DE 12 UNITÉS

## CLIQUET 72 DENTS ACIER ZINGUÉ

**52207** 24,20€

0,05 12 240 8400

Kg SUB

1/4"  
85mm



PRÉSENTOIR DE 12 UNITÉS

## CLIQUET 72 DENTS ACIER ZINGUÉ

**54083** 9,75€

0,14 12 24 2592

Kg SUB

1/4"

**54084** 13,10€

0,30 12 24 1440

Kg SUB

3/8"

**54085** 17,80€

0,60 12 24 960

Kg SUB

1/2"

PRÉSENTOIR DE 12 UNITÉS

## CLIQUET À MANCHE LARGE DROIT 72 DENTS

**54086** 9,25€

0,10 12 24 2592

Kg SUB

1/4"



**54087** 17,30€

0,50 12 24 1008

Kg SUB

1/2"



PRÉSENTOIR DE 12 UNITÉS

TVA non comprise

# CLIQUET ARTICULÉ 72 DENTS

**52587** 39,90€

0.16 12 144 3456



1/4" 175mm

**51305** 28,90€

0.31 12 48 816



1/2" 170mm



**52588** 45,00€

0.17 12 144 3456



PRÉSENTOIR DE 12 UNITÉS

1/2" 175mm

**51306** 28,10€

0.30 12 48 816



PRÉSENTOIR DE 12 UNITÉS

1/4" 175mm

# CLIQUET À TÊTE PIVOTANTE 72 DENTS

**51405** 21,10€

0.58 12 24 -



1/4" 145mm



**51406** 29,20€

0.66 12 24 864



1/2" 280mm



PRÉSENTOIR DE 12 UNITÉS

# CLIQUET ARTICULÉ EXTENSIBLE 72 DENTS DE 1/2"

**52197** 36,30€

1.04 6 12 480



350-490mm 1/2"



ROTATION DE 180°

POIGNÉE EXTENSIBLE



PRÉSENTOIR DE 6 UNITÉS

# CLIQUET EXTENSIBLE 72 DENTS

**53346** 18,00€

0.25 6 12 -



1/4" 150-200mm

**51307** 29,70€

0.92 6 12 456



1/2" 305-445mm



- Acier forgé avec traitement thermique.

EXTENSIBLE

POIGNÉE EXTENSIBLE



PRÉSENTOIR DE 6 UNITÉS



PRÉSENTOIR DE 6 UNITÉS

## CLIQUET LONG 72 DENTS

**53886** 20,30€

0,27 10 40 1680



1/4" 305mm



RECHANGE 1/4" POUR  
REF. 53886

**15149** 0,05 100

5,00€ Kg 11

**53887** 30,30€

0,68 10 20 700



3/8" 457mm

RECHANGE 3/8" POUR  
REF. 53887

**15147** 0,10 100

5,00€ Kg 11

**53888** 37,90€

1,27 4 16 480



1/2" 609mm

RECHANGE 1/2" POUR  
REF. 53888

**15148** 0,20 100

5,00€ Kg 11

## CLIQUET LONG 72 DENTS

**53883** 18,40€

0,27 10 40 1680



1/4" 305mm



RECHANGE 1/4" POUR  
REF. 53883

**15149** 0,05 100

5,00€ Kg 11

**53884** 30,20€

0,61 10 20 700



3/8" 457mm

RECHANGE 3/8" POUR  
REF. 53884

**15147** 0,10 100

5,00€ Kg 11

**53885** 35,70€

1,25 4 16 480



1/2" 609mm

RECHANGE 1/2" POUR  
REF. 53885

**15148** 0,20 100

5,00€ Kg 11

## CLIQUET FLEXIBLE

72 DENTS DE 3/8"

**51801** 62,00€

0,56 - 40 160



500mm 3/8"

- Très utile pour les endroits difficile d'accès.



## CLÉ EN CROIX CROISEMENT SOUDÉ

**51661** 12,00€

1,17 5 20 480



355mm 17, 19, 21mm 1/2"

**52881** 17,00€

1,40 - 10 420



400mm 17, 19, 21, 22mm 1/2"



**52880** 42,00€

3,75 - 5 100



700mm 24, 27, 32mm 3/4"

## TOURNE-À-GAUCHE

**53478** 4,55€

0.50	5	100	1200
Kg	Sub	ff	ff

1/4" 115mm

**53468** 8,50€

0.35	6	48	600
Kg	Sub	ff	ff

1/2" 250mm

**53481** 27,40€

2.85	-	5	300
Kg	Sub	ff	ff

1" 550mm

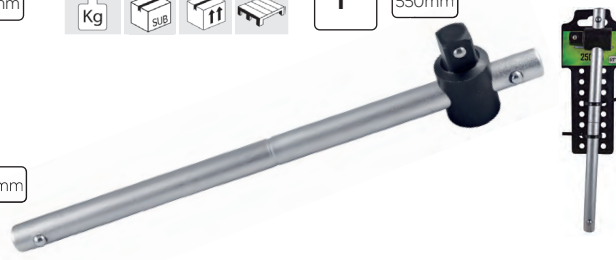

**53479** 6,40€

0.15	5	50	300
Kg	Sub	ff	ff

3/8" 200mm

**53480** 19,90€

1.35	5	10	440
Kg	Sub	ff	ff

3/4" 460mm

## BARRE ARTICULÉ

**52524** 51,00€

3.60	3	6	180
Kg	Sub	ff	ff

3/4"



1020mm



1/2" 11945

**52526** 28,40€

1.65	5	10	400
Kg	Sub	ff	ff

1/2"

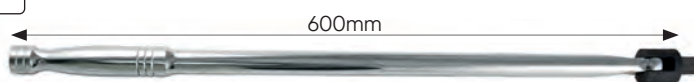

600mm



1/2" 11946



3/4" 11947

**52525** 13,80€

0.85	10	20	1400
Kg	Sub	ff	ff

1/2"



430mm

REF.	"	POUR	Kg	Sub	ff	ff	€
11945	1/2"	52526	0,15	25	100		7,00€
11946	1/2"	52525	0,51	100	300		4,50€
11947	3/4"	52524	0,60	10	40		19,00€

## JEU DE RALLONGES DE 1/4"

**51447** 16,00€

0.34	5	20	960
Kg	Sub	ff	ff



1/4"

50, 75, 100, 152, 227mm

### PIÈCES DE RECHANGE DISPONIBLES

REF.	mm	Kg	Sub	ff	ff	€
14026	50mm	0,03	5	100		5,50€
14027	75mm	0,04	-	50		5,60€
14028	100mm	0,06	5	100		7,00€
14029	152mm	0,08	-	50		8,50€
14030	227mm	0,11	-	50		9,50€



## JEU DE RALLONGES DE 1/4" À TÊTE SPHERIQUE

**51805** 17,00€

0.33	4	20	640
Kg	Sub	ff	ff



1/4"

50, 75, 100, 152, 227mm

### PIÈCES DE RECHANGE DISPONIBLES

REF.	mm	Kg	Sub	ff	ff	€
12995	50mm	0,03	5	100		7,00€
12996	75mm	0,04	20	100		7,00€
12997	100mm	0,06	20	100		7,50€
12998	152mm	0,08	5	100		9,00€
12999	227mm	0,11	5	100		9,50€



## JEU DE RALLONGES DE 1/2" À TÊTE SPHERIQUE

**51448** 52,00€

2.38	-	5	270
Kg	Sub	ff	ff



1/2"

50, 125, 250, 380, 510mm

### PIÈCES DE RECHANGE DISPONIBLES

REF.	mm	Kg	Sub	ff	ff	€
14978	50mm	0,09	5	100		7,50€
14979	125mm	0,21	5	50		9,00€
14980	250mm	0,40	5	25		13,00€
14981	380mm	0,62	5	20		22,50€
14982	510mm	0,83	5	10		27,50€



## RALLONGE TÉLESCOPIQUE DE 1/2" À TÊTE SPHERIQUE

51479 31,80€

0,65	12	24	1056
Kg	Sub	ff	ff

260-410mm 1/2"



PRÉSENTOIR  
DE 12 UNITÉS



6 POSTES

## DOIGT FLEXIBLE À 4 GRIFFES

51526 9,80€

0,10	12	144	2016
Kg	Sub	ff	ff

500mm Ø 20mm



20mm

## AIMANT FLEXIBLE AVEC LED

52473 9,90€

0,18	10	60	1800
Kg	Sub	ff	ff

x1 545mm Ø 15mm

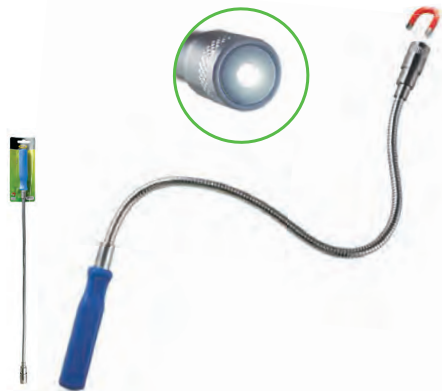

## AIMANT TÉLESCOPIQUE AVEC POINTE MAGNÉTIQUE

52472 4,90€

0,15	12	108	4320
Kg	Sub	ff	ff

Ø 10mm 135-600mm



2,5 Kg

## AIMANT FLEXIBLE AVEC POINTE MAGNÉTIQUE

51525 9,80€

0,14	10	60	1440
Kg	Sub	ff	ff

500mm Ø 7mm



ULTRA COMPACTE

## AIMANT TÉLESCOPIQUE AVEC POINTE LED

51272 7,50€

0,05	12	72	1512
Kg	Sub	ff	ff

90-810mm Ø 15mm

x1



PRÉSENTOIR  
DE 12 UNITÉS

## KIT D'OUTILS DE RAMASSAGE MAGNÉTIQUE – 5 PIÈCES

15706 31,00€

0,55	-	10	240
Kg	Sub	ff	ff

5 PCS LED 360°



## MAGNÉTISEUR / DÉMAGNÉTISEUR

53225 3,50€

0,10	12	96	2880
Kg	Sub	ff	ff

ABS



## MIROIR D'INSPECTION TÉLESCOPIQUE ARTICULÉ

52468 5,90€

0,09	12	48	2688
Kg	Sub	ff	ff

280-445mm



Ø 50MM

# COUPEAU AVEC SYSTÈME COUPE-CEINTURE ET POINTE CASSE VITRE

**52786** 14,60€

0.16 12 60 2100



AVEC SYSTÈME ANTIBLOCCAGE



## COUPE-TUBE

**52878** 11,20€

0.22 10 50 1500



3-32mm

**52879** 10,10€

0.24 10 50 1500



3-35mm

**53517** 9,50€

0.13 10 60 600



Ø max: 30mm

**52877** 15,80€

0.43 6 48 624



Ø max: 42mm



REF.	DÉSCRIPTION	POUR	Kg	€
12964	Roue en acier	52878	0,01	1,50€
12965	Roue en acier	52879	0,01	2,00€

## PINCE À CINTRER POUR TUBES 6-8-10mm

**52905** 28,00€

0.50 6 24 360



6, 8, 10mm

TIUBES EN ALUMINIUM, CUIVRE ET ACIER



DEGRÉS MARQUÉS



## DÉNUDEUR DE FILS

**53591** 5,50€

0.10 10 100 -



↑ 28mm  
↓ 8mm



8-28mm

- Plage de coupe: 8 à 28 mm.
- Longueur du produit: 170 mm.
- Longueur de la lame: 20 mm.
- Profondeur du crochet: 5 mm.



## PINCES PLIABLES MINI

**53411** 5,00€

0.05 12 120 -



127mm



**53411**

**53412** 4,00€

0.05 12 120 -



94mm



**53412**

## PINCE POUR EXTRACTION D'AGRAFES DE CARROSSÉRIE

**53385** 19,30€

0.15 6 54 1026



COUPER



EXTRAIRE



BRIDER



PINCE EN ANGLE

- Conçue pour extraire / couper des agrafes / clips facilement et sans dommage.
- Permet un accès facile aux zones confinées.



# PINCE À BORNES AVEC EMBOUT INTERCHANGEABLE

**54254** 43,00€

1.10	5	20	300
Kg	Sub	ff	ff



# PINCE A DÉNUDER AUTO-AJUSTABLE

**51972** 12,00€ 0,08-6mm

0.25	10	100	1000
Kg	Sub	ff	ff



- Pour dénuder des câbles en plastique ou caoutchouc, individuels ou multiples, avec des sections de 0.25 à 2.5mm<sup>2</sup>.
- Ajustement automatique de l'épaisseur de découpe pour les différentes sections.
- Pour des câbles en cuivre et aluminium, possibilité de dénuder plusieurs câbles à la fois avec section de 2.5mm<sup>2</sup> maximum.
- Possibilité de dénuder des câbles individuels à partir de 0.25 mm<sup>2</sup> de section.
- Ne provoque pas de dommages sur le fil conducteur.
- Grande durabilité.

# PINCE À SERTIR

POUR COSSES ISOLÉES ET NON ISOLÉES

**52761** 8,00€ 9"

0.25	12	72	1800
Kg	Sub	ff	ff



**53932** 8,00€ 9"

0.25	12	72	1296
Kg	Sub	ff	ff



MODULE DÉNUDEUSE + BORNES EVA POUR SERVANTE D'OUTILS

**13669** 18,00€ 0.61 10

0.61	10
Kg	ff



# POUR COSSES NON ISOLÉES

**52762** 9,00€ 8 - 3/4"

0.25	12	72	1800
Kg	Sub	ff	ff



# CISEAUX POURCÂBLE

**52152** 13,50€

0.08	12	96	1920
Kg	Sub	ff	ff



# PINCES MINIS PLIABLES

**53604** 118,00€ Section de coupe max. Ø 550 mm2

3.70	-	5	120
Kg	Sub	ff	ff

800mm

**53603** 45,00€

1.75	-	5	300
Kg	Sub	ff	ff

550mm

**53602** 30,50€

0.60	-	5	300
Kg	Sub	ff	ff

360mm

Section de coupe max. Ø 125 mm2



53602 53603 53604

# COUPE BOULONS

**52955** 19,80€

0.77	-	20	200
Kg	Sub	ff	ff

12" 300mm HRC 30 Ø 4-5mm

**52957** 23,80€

1.47	-	12	360
Kg	Sub	ff	ff

18" 450mm HRC 30 Ø 6-8mm

**52959** 42,00€

3.78	-	5	100
Kg	Sub	ff	ff

30" 750mm HRC 30 Ø 10-13mm

**52960** 46,00€

5.15	-	5	105
Kg	Sub	ff	ff

36" 900mm HRC 30 Ø 12-16mm

**52956** 19,60€

0.95	-	20	200
Kg	Sub	ff	ff

14" 350mm HRC 30 Ø 5-7mm

**52958** 28,20€

2.40	-	8	210
Kg	Sub	ff	ff

24" 600mm HRC 30 Ø 8-10mm



52955 52956 52957 52958 52959 52960

TVA non comprise

**JBM** / [www.jbmfrance.fr](http://www.jbmfrance.fr)

# PINCE CIRCLIPS EMBOUTS DROIT

POUR INTERIEUR

**53549** 14,30€



**13"** 330mm



**52964** 9,45€

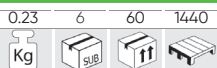

**9"** 225mm

**51018** 7,05€



**7"** 180mm

POUR EXTERIEUR

**53547** 14,70€

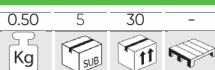

**13"** 330mm



**52966** 9,45€

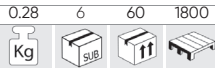

**9"** 225mm

**51017** 6,80€



**7"** 180mm

CrV



# PINCE CIRCLIPS EMBOUTS COUDÉS

POUR INTERIEUR

**53550** 14,70€



**13"** 330mm



**52965** 9,20€



**9"** 225mm

**51021** 7,05€



**7"** 180mm

POUR EXTERIEUR

**53548** 15,60€



**13"** 330mm



**52967** 9,40€



**9"** 225mm

**51020** 6,65€



**7"** 180mm

CrV



# MODULE PINCE SEEGER EVA 8"

**15454** 35,40€

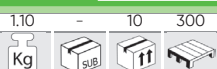

	Ø	Kg	€
15707	PINCE À CIRCLIPS POUR INTERIEUR - EMBOUT DROIT 8"	0,21	10,00€
15708	PINCE À CIRCLIPS POUR EXTERIEUR - EMBOUT DROITE 8"	0,22	10,00€
15709	PINCE À CIRCLIPS POUR INTERIEUR - EMBOUT COURBE 8"	0,21	10,00€
15710	PINCE À CIRCLIPS POUR EXTERIEUR - EMBOUT COURBE 8"	0,22	10,00€



8"

# SET DE PINCES SEEGER AVEC POINTE INTERCHANGEABLE

**53389** 31,50€

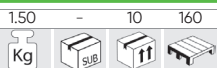

Pincas d'angle: 90° / 45° / 15° / 0° **10"**

- Continent:
- Pincas internes.
- Pincas extérieures.
- 16 pincas d'angles différentes.
- 8 vis.



# PINCE MULTIPRISE

**52052** 53,00€

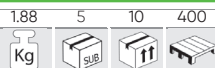

**50567** 9,60€

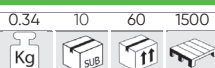

# PINCES EXTRA LONGUES

DROIT

COURBÉ 45°

52846 37,80€

52847 41,00€

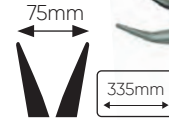
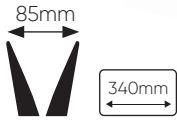
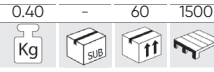
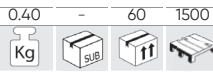

## JEU DE 3 PINCES LONGUES 0°, 45°, 90°

52272 24,60€

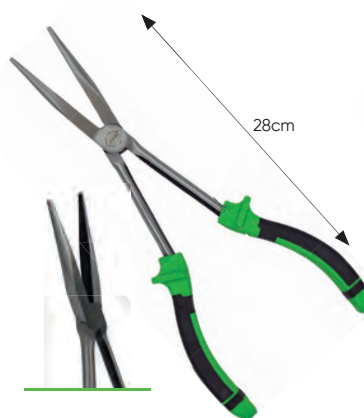
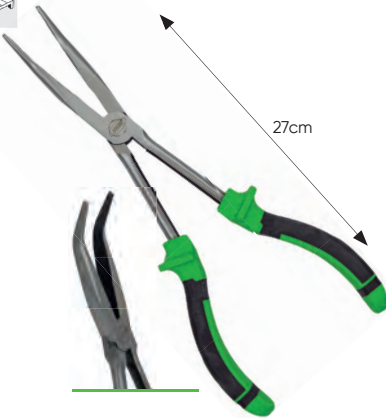
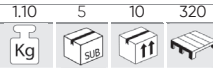

## JEU DE 5 PINCES

51812 46,00€



## PINCE MINI PLIANTE MULTIFONCTION

52412 5,00€



105mm



### CONTIENT

x2	tournevis plat
x1	pointe cruciforme
x1	ouvre-bouteille
x1	ouvre-boîte
x1	lime 25mm
x1	scie 40mm
x1	outil de coupe 40mm

TVA non comprise

# PINCE UNIVERSELLE POUR COLLIER AUTOSERRANT

**53390** 34,50€

1.00	10	20	320
Kg	sub	ff	



JEU DE PIÈCES DE RECHANGE POUR 53390

**14180** 7,90€

0.01	100
Kg	ff

**51995** 24,50€

0.53	5	40	360
Kg	sub	ff	



JEU DE PIÈCES DE RECHANGE POUR 51995

**14179** 8,50€

0.01	100
Kg	ff

## PINCE POUR COLLIER DE SERRAGE DE TUYAUX D'ÉCHAPPEMENT

**53396** 18,30€

0.50	5	50	-
Kg	sub	ff	



## PINCE POUR COLLIERS CLIC-R

**52791** 18,00€

0.25	5	50	1500
Kg	sub	ff	



## PINCE UNIVERSELLE

**53911** 8,80€

0.20	6	60	1440
Kg	sub	ff	

160mm  
**6"**

**53967** 10,20€

0.30	6	60	1440
Kg	sub	ff	

200mm  
**8"**

**54015** 10,20€

0.20	6	60	1920
Kg	sub	ff	

180mm  
**7"**

**CrV**



## PINCE A BEC SPÉCIAL TERMINAUX

**53976** 9,00€

0.20	6	60	1440
Kg	sub	ff	

160mm **6"** **CrV**



## PINCE COUPANTE DIAGONALE

**53905** 7,30€

0.20	6	60	1440
Kg	sub	ff	

**6"** 160mm

**53906** 8,65€

0.20	6	60	1440
Kg	sub	ff	

**7"** 184mm

**CrV**



## PINCE A BEC DROIT

**53908** 7,25€

0.15	6	60	1440
Kg	sub	ff	

**6"** 160mm

**CrV**

**53909** 9,70€

0.20	6	60	1440
Kg	sub	ff	

**8"** 200mm



# COFFRET DE PINCES SPÉCIALE A COLLIERS

**52050** 98,00€

3,24 - 4 60



- Utilisation pour desserrer et rajuster des brides réajustables de type click ou click-R.
- Pinces pour extraction de tubes. Très utiles pour extraire facilement des tubes à vide et de carburant de 5/32" à 1/2".
- Pinces pour brides. Permettent l'extraction d'agrafes auto-ajustables en plastique et/ou métal de diamètres 18 mm à 47mm.
- Pinces pour brides à mâchoire pivotante avec cannelure en "+".
- Pinces pour brides à mâchoire pivotante.
- Pinces pour brides à bande plate. La mâchoire pivote sur 360° pour saisir dans tous les angles.
- Pour des brides modernes.



REF.	DÉSCRIPTION	Kg	SUB	ff	€
13707	pince pour collier de serrage avec pointe rotative	0,25	10	40	14,00€
13708	pince pour collier de serrage élastique	0,25	10	40	14,00€
13709	pince pour collier de serrage avec pointe droite	0,24	10	40	14,00€
13710	pince pour collier de serrage élastique 45°	0,21	10	40	14,00€

REF.	DÉSCRIPTION	Kg	SUB	ff	€
52791	pince pour collier de serrage "clac" et "clac-r"	0,27	10	50	18,00€
13712	pince pour extraction de tubes	0,21	10	40	14,00€
51995	pince universelle pour collier autoserrant	0,59	5	40	24,50€



## PINCE POUR COLLIER A SERTIR

**52619** 23,10€

0,55 6 36 648



0-20mm

- Trou de 1/2" afin de pouvoir utiliser comme clé.



**52812** 65,00€

0,85 5 20 500



- Avec prise femelle pour le serrage à cliquet.

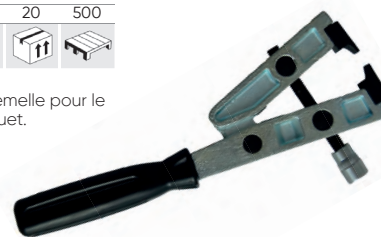

## PINCE PLATE POUR LA CONDUITE DE CARBURANT

**53487** 16,70€

0,30 10 40 960



Audi / VW, Fiat, GM, Mercedes

## PINCE POUR ANNEAU

**52508** 38,40€

0,37 10 50 800



0-38mm



**52509** 36,20€

0,39 10 50 800



22-55mm



240mm

TVA non comprise

**JBM** / [www.jbmfrance.fr](http://www.jbmfrance.fr)

## ENSEMBLE DE CROCHETS, PIOCHES ET LEVIER NON-MARQUÉS

**54142** 15,20€

0.10	6	48	1344
Kg	sub	ff	ff

Outils pour la dépose, le nettoyage et travaille avec des clips en plastique, garnitures d'étanchéité, câbles, connecteurs électriques, etc.  
- Il fonctionne avec des matériaux souples  
- Ne raye pas la peinture

**6 PCS**

Contenu :  
2 embouts crochets  
2 embouts droits  
2 embouts coudés  
6 embouts avec leviers.



## JEU DE 2 CROCHETS

**52852** 6,80€

0.06	25	100	3200
Kg	sub	ff	ff

- Pour l'extraction de joints toriques.

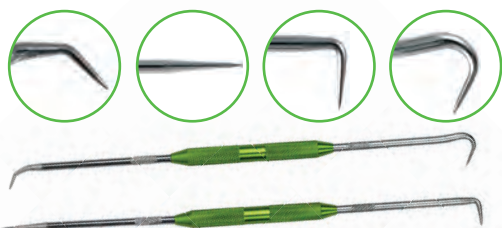

## LOT DE 12 POINCONS CREUX

**52885** 18,00€

1.10	5	20	600
Kg	sub	ff	ff

3, 4, 5, 6, 7, 8, 9, 10, 12, 14, 16, 19mm

**12 PCS**



## BROSSES MÉTALLIQUES

**52760** 4,10€

0.09	6	120	2160
Kg	sub	ff	ff



## PINCE POUR RESSORT DE FREIN

**52625** 9,00€

0.35	6	48	1824
Kg	sub	ff	ff

- Pour extraire et installer les ressorts de retour des freins.



## PINCE MASSES ÉQUILIBRAGE

**51355** 19,00€

0.45	5	50	-
Kg	sub	ff	ff

- Extrait facilement et remplace le contrepoids.  
- Coupe et plie facilement.  
- Fait en acier renforcé à la chaleur.  
- Inclut manche ergonomique.  
- Avec ressort automatique en ouvert dans la poignée pour faciliter son opération.



## AGRAFEUSE INDUSTRIELLE

**53589** 12,00€

0.55	20	40	920
Kg	sub	ff	ff



1008J-1

1000 PCS AGRAFES POUR RÉF. 53589

**14167** 2,50€

0.10	100
Kg	ff

## PINCE EMPORTE PIÈCES REVOLVER

**52638** 9,95€

0.35	5	50	1800
Kg	sub	ff	ff

Ø 2, 2.5, 3, 3.5, 4, 4.5mm



## KIT DE CLÉS À CROCHET

**53654** 81,00€

1.40 - 5 180



- Kit composé de 3 clés à crochet, 3 adaptateurs et 2 goupilles interchangeables.  
- Leur combinaison permet de travailler avec des diamètres de 35 mm à 120 mm.

**8**  
PCS

35-60, 60-90,  
90-120mm

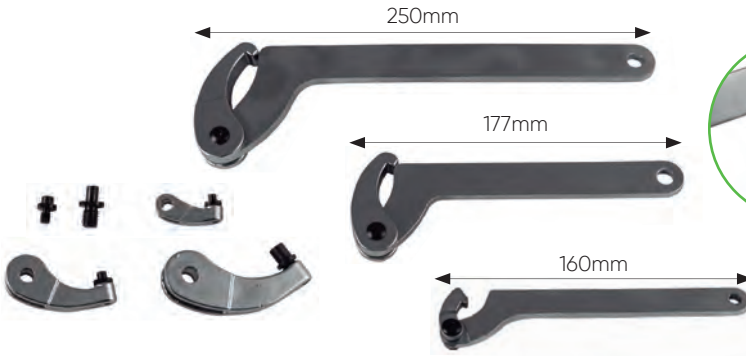

## JEU DE CASSE ÉCROUS

**53524** 51,00€

1.70 5 10 320



9-12, 12-16,  
16-22, 22-27mm

**4**  
PCS



### PIÈCES DE RECHANGE DISPONIBLES

REF.	DÉSCRIPTION	Kg	Sub	Qté	€
14049	9-12mm	0,11	50	8,00€	
14050	12-16mm	0,2	50	10,50€	
14051	16-22mm	0,44	5	20	18,00€
14052	22-27mm	0,65	5	20	19,50€



## CLÉ À MOLETTE

### MODÈLE 3

**53639** 28,60€

0.15 6 96 576



**6"** 150mm

**53640** 34,40€

0.28 6 72 504



**8"** 200mm

**53641** 41,00€

0.50 6 36 1151



**10"** 250mm



**53642** 54,00€

0.83 6 10 1200



**12"** 300mm

**53643** 92,00€

1.53 - 12 336



**16"** 400mm



### MODÈLE 1

**51798** 39,60€

1.90 3 12 480



**18"** 53mm

**52424** 64,00€

3.75 - 5 250



**24"** 62mm



### MODÈLE 2

**51795** 9,00€

0.28 6 60 3600



**8"** 22mm

**51796** 14,00€

0.48 6 36 2400



**10"** 28mm

**51797** 18,00€

0.71 6 24 960



**12"** 37mm



**51795**



**51796**

**51797**

## CLÉ STILLSON SERRE-TUBE

**52235** 11,00€

0,90 6 24 1140



12" 300mm 50mm

**52236** 13,30€

1,09 6 24 760



14" 350mm 60mm

**52237** 18,10€

1,75 4 12 720



18" 450mm 70mm

**52238** 24,90€

2,50 2 8 600



24" 600mm 75mm

**53210** 48,00€

4,95 - 4 96



36" 915mm 100mm



## CLÉ STILLSON ALUMINIUM

**53070** 16,20€

0,68 6 24 900



12" 270mm

**53071** 26,10€

0,92 4 12 900



14" 320mm

**53072** 31,60€

1,35 4 12 900



18" 410mm

**53073** 50,00€

2,05 2 8 1000



24"



## SERRE JOINT

**52349** 22,10€

90x200mm

1,25 - 10 480



**52354** 34,40€

120x500mm

2,41 - 6 300



**52350** 22,60€

90x300mm

1,41 - 10 540



**52355** 36,60€

120x600mm

2,62 - 4 300



**52351** 25,40€

90x400mm

1,60 - 10 480



**52357** 54,00€

150x800mm

4,60 - 5 125



**52352** 32,40€

120x300mm

1,99 - 10 360



**52358** 63,00€

150x1.000mm

5,35 - 5 120



**52353** 33,40€

120x400mm

2,10 - 10 350

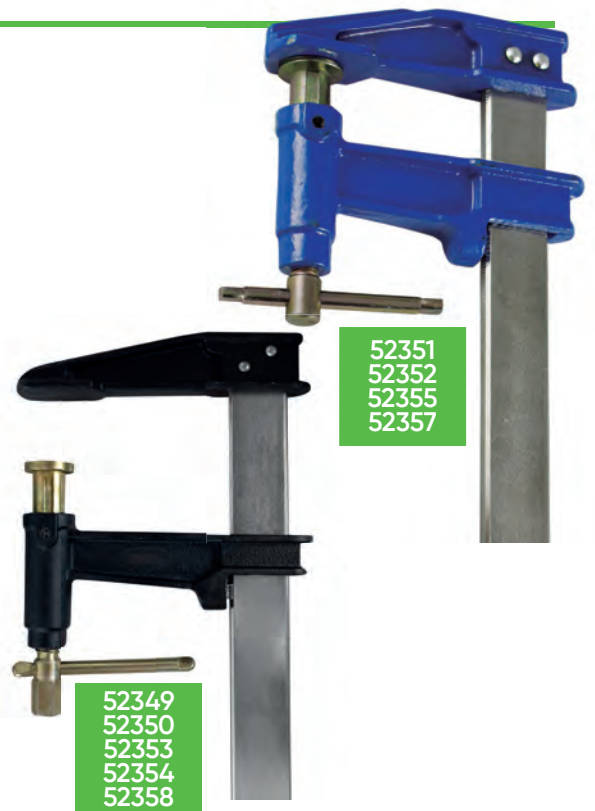

52351  
52352  
52355  
52357

52349  
52350  
52353  
52354  
52358





# **MOBILIER D'ATELIER**

- 68 SERVANTES D'OUTILS
- 76 MODULES D'OUTILS
- 80 ACCESSOIRES  
/ RECHANGE POUR SERVANTE
- 81 ARMOIRES
- 81 ACCESSOIRES POUR TABLES
- 82 TABLES DE TRAVAIL
- 83 CAISSE À OUTILS
- 85 TABOURETS / BRANCARDS
- 86 ENCLUMES / ÉTAUX

# SERVANTE D'OUTILS 12 TIROIRS

53939 1.280,00€

53868 1.090,00€

172 PCS

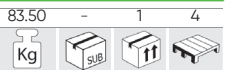

COMPLETE

VIDE

ARMOIRES

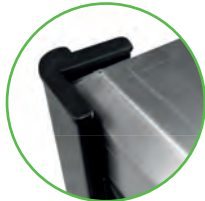

PROTECTEUR LATÉRAL



SYSTÈME DE FERMETURE CENTRALISÉE



LANGUETTE DE FERMETURE INDIVIDUELLE DANS CHAQUE TIROIR

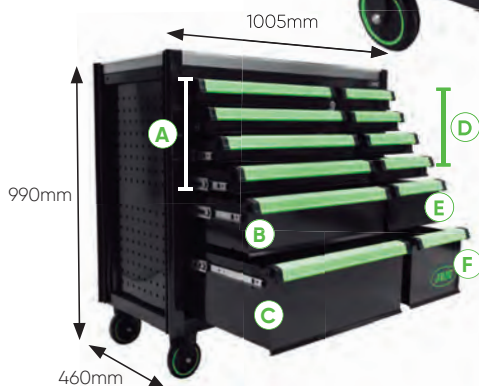

AVEC MODULES EVA:  
4 MODULES FINITION EN FIBRE DE CARBONE

53708 325,00€



ACCÉSSOIRES ET PIÈCES DE RECHANGE  
page 80

## DIMENSIONS INTERIEUR 1A COLONNE

PETITS TIROIRS (x4)



MOYENS TIROIRS (x1)



GRAND TIROIR (x1)



## DIMENSIONS INTERIEUR 2A COLONNE

PETITS TIROIRS (x4)



MOYENS TIROIRS (x1)



GRAND TIROIR (x1)



Module 1: 14296 118,00€

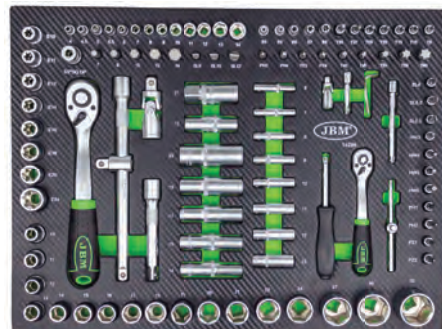

Module 2: 14297 87,00€

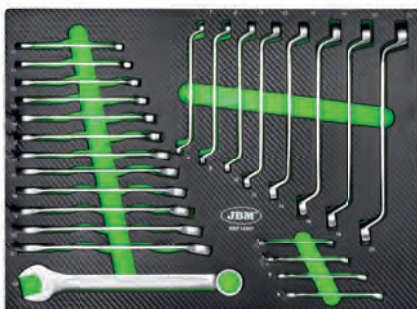

Module 3: 14298 51,50€



Module 4: 14299 87,00€



# SERVANTE MOBILE 7 TIROIRS - XL

<b>53912</b> 1.280,00€	<b>53869</b> 990,00€	<b>53913</b> 1.280,00€	<b>53870</b> 990,00€	<b>199 PCS</b>
74,50 - - 4 COMPLETE	74,50 - 1 4 VIDE	74,50 - - 4 COMPLETE	74,50 - 1 4 VIDE	



## DIMENSIONS INTERIEUR

### PETITS TIROIRS (x5)



### GRANDS TIROIRS (x2)



AVEC MODULES EN MOUSSE:

# XL

ACCESSOIRES ET PIÈCES DE RECHANGE page 80

Module 2: 14296 118,00€

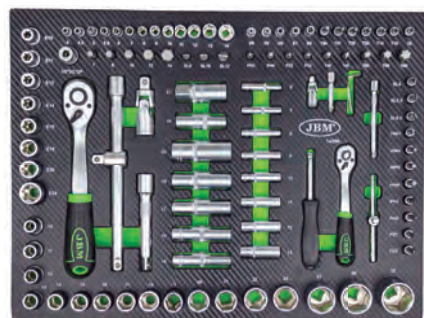

15122 74,00€



Module 1: 14297 87,00€



15161 62,00€



Module 4: 14298 51,50€



15155 59,00€



Module 3: 14299 87,00€



15514 9,35€



ARMOIRES



# SERVANTE D'OUTILS 7 TIROIRS

**53763** 890,00€

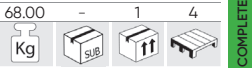

**53764** 680,00€

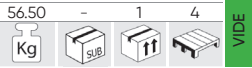

**53765** 890,00€

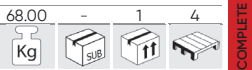

**53766** 680,00€

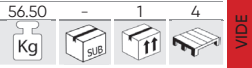

**53900** 890,00€

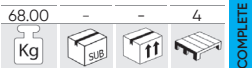

**53901** 680,00€

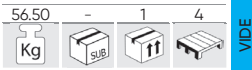

172  
PCS

350Kg



ROUES 5" : 2 FIXES ET 2 PIVOTANTES, UNE AVEC FREIN.

AVEC MODULES EVA:  
4 MODULES FINITION  
EN FIBRE DE CARBONE

**53708** 325,00€



Module 1: 14296 118,00€



## HAUTE QUALITÉ

- ✓ RÉSISTANT AUX CHARGES LOURDES
- ✓ LÉGER ET FACILE À TRANSPORTER
- ✓ DES OUTILS BIEN RANGÉS DANS LES MODULES EVA
- ✓ CONSTRUCTION ROBUSTE ET DURABLE

CÔTÉS PERFORÉS POUR PERMETTRE À L'UTILISATEUR D'AJOUTER UN GRAND NOMBRE D'ACCESSOIRES



LANGUETTE DE FERMETURE INDIVIDUELLE DANS CHAQUE TIROIR



SYSTÈME DE FERMETURE CENTRALISÉ

## ACCESSOIRES ET PIÈCES DE RECHANGE

page 80



PETITS TIROIRS (x6)

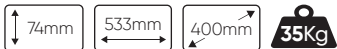

GRAND TIROIR (x1)



CAPACITÉ DE CHARGE DU TIROIR: 40KG.  
CAPACITÉ DE CHARGE TOTALE: 125KG.

Module 2: 14297 87,00€



Module 3: 14298 51,50€



Module 4: 14299 87,00€



# SERVANTE D'OUTILS 7 TIROIRS

<b>53661</b>	890,00€	71,50 Kg	-	1	4	COMPLETE
<b>53761</b>	680,00€	52,50 Kg	-	1	4	VIDE
<b>53767</b>	890,00€	64,00 Kg	-	1	4	COMPLETE
<b>53768</b>	680,00€	56,00 Kg	-	1	4	VIDE

<b>53686</b>	890,00€	72,50 Kg	-	1	4	COMPLETE
<b>53762</b>	680,00€	55,50 Kg	-	1	4	VIDE
<b>53904</b>	890,00€	72,00 Kg	-	1	4	COMPLETE
<b>54006</b>	680,00€	55,00 Kg	-	1	4	VIDE

172 PCS  
300 Kg



ACCÉSSOIRES ET PIÈCES DE RECHANGE  
page 80

## MODULES EN FIBRE DE CARBONE

<b>53708</b>	325,00€	15,20 Kg	-	1	24
--------------	---------	----------	---	---	----

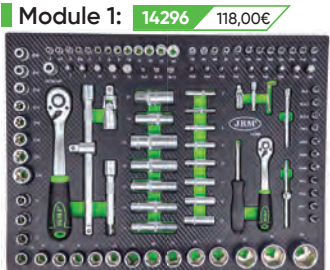

	1/2"	x1	
	1/2"	x1	5/16
	1/2"	x5	14, 15, 17, 19 y 22 mm
	1/2"	x17	10, 11, 12, 13, 14, 15, 16, 17, 18, 19, 20, 21, 22, 24, 27, 30 y 32 mm
	1/2"	x8	E10, E11, E12, E14, E16, E18, E20 y E24
	1/2"	x2	16, 21
	x2		5", 10"
	1/2"	x1	
	x1		3/8" 1/2"
	1/4"		1,2
			1,2
		x18	3,4,5,6 mm
			4,5,5,6,5 mm
			8,10,15,20,25,27,30 mm
	1/4"		2", 3"
	x13		4, 4,5, 5, 5,5, 6, 7, 8, 9, 10, 11, 12, 13 y 14 mm
	1/4"	x8	6, 7, 8, 9, 10, 11, 12, 13 mm
	1/4"	x5	E4, E5, E6, E7 y E8
			7, 8, 10, 12, 14 mm
			8, 10, 12 mm
	8mm	x17	3,4
			3,4
			40, 45, 50, 55, 60 mm
		x3	1,5, 2, 2,5 mm

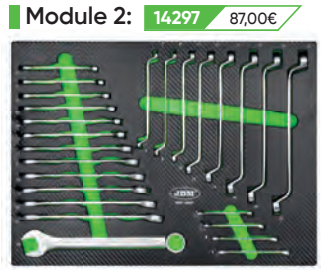

	6x7 8x9 10x11 12x13 14x15 16x17 18x19 20x22 m
	6 7 8 9 10 11 12 13 14 15 16 17 18 19 20 21 22



	x6	PH2x38, PH0x75, PH1x100, PH2x100, PH3x150, PH4x200
	x4	SL6x38, SL3x100, SL8x150, SL10x200
	x9	
	x9	



	450g
	35mm
	10"
	8"
	8"
	10"
	7,5"
	8"
	3m



2 ROUES TOURNANTES

SYSTÈME DE FERMETURE CENTRALISÉE

LANGUETTE DE FERMETURE INDIVIDUELLE DANS CHAQUE TIROIR

PETITS TIROIRS (X5)			
74mm	533mm	400mm	35Kg

GRAND TIROIR (X2)			
151,5mm	533mm	400mm	35Kg

CAPACITÉ DE CHARGE DU TIROIR: 35KG.  
CAPACITÉ DE CHARGE TOTALE: 300KG.



# CHARIOT À OUTILS 7 TIROIRS SPÉCIAL CAMIONS

54240 1.887,00€

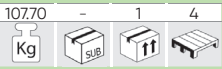

54237 1.887,00€



54238 1.887,00€



54239 1.887,00€



## JEU D'OUTILS POUR LA RÉPARATION DES VÉHICULES

54134 1.415,00€

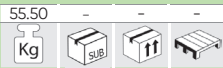

	1kg
	24, 27, 30, 32, 36, 41mm
	500mm
	500mm

15732 293,50€



	10, 13, 17 mm
	10x11, 12x13, 14x17mm
	E10xE12, E14xE18, E20xE24
	8x10, 11x13, 14x15, 16x17, 18x19mm
	27, 30, 32, 36mm
	10, 13, 17, 19mm

15731 214,00€



	6x7, 8x9, 10x11, 12x13, 14x15, 16x17, 18x19, 20x22, 21x23, 24x27, 25x28, 30x32mm
	6, 7, 8, 10, 11, 12, 13, 14, 15, 17, 19, 22, 24mm

15736 488,50€



	1/2"	78mm	13,14,15,16,17,18,19,21,22,24
	3/4"		22,24,27,30,32,33,36,38,46mm
	1/2"	90mm	51,60mm
	1/2"		T40,T45,T50,T60,T70
	1/2"	78mm	H6,H8,H14,H17
	3/4"	100mm	T80,T90,T100
			1/2"(M)x3/4"(H) 3/4"(M) x1/2"(H)
			1/2", 3/4"
			125mm
	1/2"	40mm	M18

15735 152,00€



	250mm
	6" - 160mm
	7" - 180mm
	90° 300mm
	45° 300mm
	0° 300mm
	220mm
	330mm
	330mm
	330mm
	330mm

15730 289,00€



	55mm	H5, H6, H7, H8, H10, H12
	65mm	H14
	70mm	H16, H17, H18, H18, H20
		H4, H5, H6, H7, H8, H10, H12
	30mm	M5, M6, M8, M10, M12
		T20, T25, T30
		T40, T45, T50, T55
	75mm	H4, H5, H6, H7, H8, H10, H12
		M5, M6, M8, M10, M12
		T20, T25, T30
		T40, T45, T50, T55

15733 113,00€



	PH0×75mmL
	PH1×75mmL
	PH2×100mmL
	PH2×38mmL
	PH3×150mmL
	PH4×200mmL
	SL3.5×75mmL
	SL5×75mmL
	SL6×100mmL
	SL6×38mmL
	SL8×150mmL
	SL9.5×200mmL
	10x11, 12x13, 14x15mm
	10x11, 12x13, 14x15, 16x17, 18x19mm

	1/2"		17
	1/2"	X9	E10, E11, E12, E14, E16, E18, E20, E22, E24
	1/2"	X10	10, 11, 12, 13, 14, 15, 16, 17, 18, 19mm
	1/2"	X3	50, 125, 250mm
	1/2"	X1	430mm
	1/2"	X1	10mm
	3/4"	X5	21, 24, 27, 34, 36mm
	3/4"	X4	24, 30, 32, 36 mm
			1/2X10mm 3/8X10mm
			1/2X10mm 3/8X10mm
	3/8"		10mm
	1/4"		300, 380, 450mm
	1/4"		

# SERVANTE D'OUTILS 7 TIROIRS

54236 1.856,00€



54233 1.856,00€

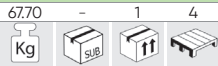

54234 1.856,00€

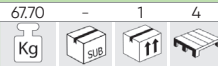

54235 1.856,00€

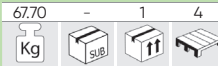

- x1** MODULE D'OUTILS VDE AVEC ISOLATION EVA (ÉTHYLÈNE VINYLE ACÉTATE) -26 PIÈCES
- x1** TERMOMETRE LASER -50°C A 550°C
- x1** ÉCRAN FACIAL ISOLANT POUR TRAVAUX SOUS TENSION
- x1** SERVANTE D'OUTILS 7 TIROIRS SANS OUTILS - VERDWW
- x1** PERCHE DE SAUVETAGE ISOLÉE - 45KV
- x1** MESUREUR DE RÉSISTANCE D'ISOLATION
- x1** GANTS ISOLANTS POUR TRAVAUX SOUS TENSION
- x1** TAPIS ISOLANT CLASSE 0
- x8** MAILLE DE CHAÎNE EN PLASTIQUE NOIR
- x4** CHAÎNE PVC - 5M - JAUNE/NOIR
- x4** POTEAU DE PLASTIQUE POUR CHAINES - JAUNE / NOIR

Servante spécialement configurée afin de couvrir toutes les nécessités basiques du maintien et réparation de véhicules hybrides et électriques, ainsi que pour les travaux de hautes tensions.



ÉCRAN FACIAL ISOLANT POUR TRAVAUX SOUS TENSION

54132 190,00€

54093 441,00€  
MODULE D'OUTILS VDE AVEC ISOLATION EVA (ÉTHYLÈNE VINYLE ACÉTATE) -26 PIÈCES

TERMOMETRE LASER -50°C A 550°C

52162 38,00€

SERVANTE D'OUTILS 7 TIROIRS SANS OUTILS - VERD

54006 680,00€

PERCHE DE SAUVETAGE ISOLÉE - 45KV

54241 120,00€

GANTS ISOLANTS POUR TRAVAUX SOUS TENSION T.9

54130 58,00€

MESUREUR DE RÉSISTANCE D'ISOLATION

54114 248,00€

TAPIS ISOLANT CLASSE 0

54129 110,00€

**x8** MAILLE DE CHAÎNE EN PLASTIQUE NOIR

53942 0,50€

**x4**

CHAÎNE PVC - 5M - JAUNE/NOIR

53941 6,05€

**x4** POTEAU DE PLASTIQUE POUR CHAINES - JAUNE / NOIR

53940 13,20€



ARMOIRES

# SERVANTE D'OUTILS 7 TIROIRS AVEC JEU D'OUTILS POUR RÉGLER LA SYNCHRONISATION

**53951** 1.794,00€

**53952** 1.794,00€

**53775** 1.109,00€



**KIT DE 6 OUTILS POUR SYNCHRONISATION DU MOTEUR**

GASOLINA/PETROL

GASOIL/DIESEL

**Module 1:** 53769 178,00€

RENAULT / NISSAN / OPEL / VOLVO



**Module 2:** 53770 198,00€

FORD / SEAT / VOLKSWAGEN / MAZDA / VOLVO



**Module 3:** 53771 158,00€

FIAT / FORD / CITROËN / PEUGEOT



**Module 4:** 53772 229,00€

FORD / VAG / MAZDA / VOLVO



VOIR DÉTAIL

pg.244



**Module 5:** 53773 298,00€

FIAT / ALFA / LANCIA / OPEL / SUZUKI / FORD



**Module 6:** 53774 190,00€

OPEL / CHEVROLET / SAAB / FIAT / LANCIA / SUZUKI / FORD

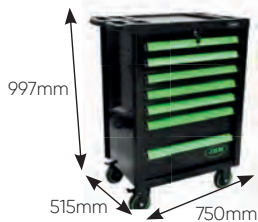

+ INFORMATIONS DE CHAQUE ENSEMBLE DANS COFFRET DE CALAGE, page 238

ARMOIRES







Choisissez la couleur de la servante que vous souhaitez et remplissez-la

# D'OUTILS POUR CARROSSIER OU OUTILS D'ENTRETIEN

## SERVANTE D'OUTILS 7 TIROIRS SPÉCIAL CARROSSIER

<b>53577</b>	990,00€	<b>53579</b>	990,00€	<b>53580</b>	990,00€	<b>53578</b>	990,00€	<b>256 PCS</b>
74,50	-	74,50	-	74,50	-	74,50	-	
1	2	1	2	1	2	-	-	

### Module 1:

**14059** 62,00€ KIT DE LEVIERS EN NYLON



### Module 2:

**14060** 65,00€ KIT DE RECTIFICATION



### Module 3:

**14061** 93,00€ PALETTE AVEC LES PINCES



### Module 4: KIT DE LA POMPE ASPIRANTE ET D'OUTILS POUR ENLEVER LES ESSUIE-GLACES

**14062** 100,00€



### Module 5:

**14063** 119,00€ RÉPARATION DES ENFONCEMENTS



### Module 6:

**14064** 39,50€ OUVERTURE D'URGENCE



## SERVANTE D'OUTILS 7 TIROIRS SPÉCIAL ENTRETIEN

<b>53514</b>	990,00€	<b>53556</b>	990,00€	<b>53557</b>	990,00€	<b>256 PCS</b>
74,50	-	74,50	-	74,50	-	
1	2	1	2	1	2	

**53469** 613,00€

JEU DE 5 AUGES POUR L'ARMOIRE AVEC DES OUTILS POUR LE REMPLACEMENT D'HUILE:

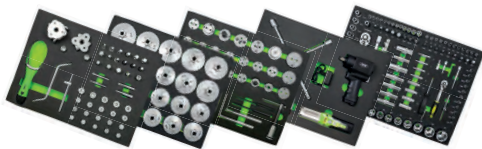

### Module 1:

**14141** 105,00€ EXTRACTEURS DE FILTRE D'HUILE



### Module 2:

**14142** 109,00€ COFFRET REPOUSE PISTON DE FREIN

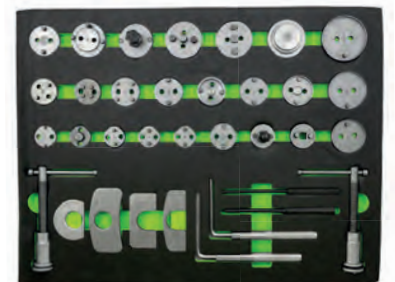

### Module 3: RÉPARATION DE BOUCHONS CARTER ET EXTRACTEURS DE FILTRE D'HUILE AJUSTABLES

**14143** 124,00€

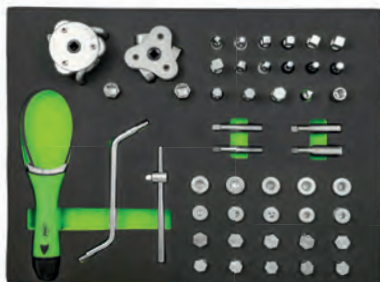

### Module 4:

**14144** 304,00€ CLÉ À CHOC ET DOUILLES



### Module 5:

**14296** 118,00€ 108 PIÈCES AVEC CLÉS HEXAGONALES

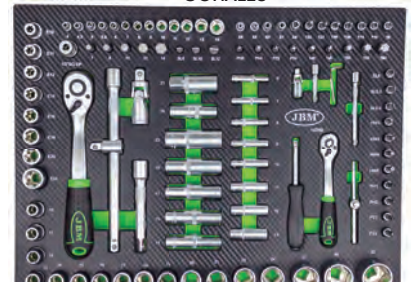

# SERVANTE 7 TIROIRS AVEC OUVERTURE TOTALE DES TIROIRS SUR GLISSIÈRES À BILLES

52393 1.180,00€

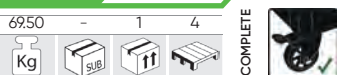

52172 780,00€

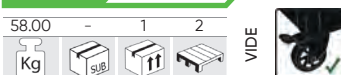

- Roues sans monté.

- Epaisseur du métal:  
Tiroir: 0,8mm  
Cadre: 1mm

179  
PCS



SURFACE EN CAOUTCHOUC ANTIDERRAPANT

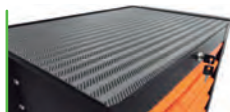

ROUE AVEC SYSTEME DE FREINAGE



125x50mm

SYSTEME DE FERMETURE CENTRALISEE



1010mm



DIMENSIONS INTERIEUR

PETITS TIROIRS (x5)

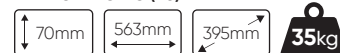

GRANDS TIROIRS (x2)



AVEC MODULES EN MOUSSE:

53708 325,00€

Module 1: 14296 118,00€

Module 2: 14297 87,00€

Module 3: 14298 51,50€

Module 4: 14299 87,00€

4 MODULES FINITION EN FIBRE DE CARBONE

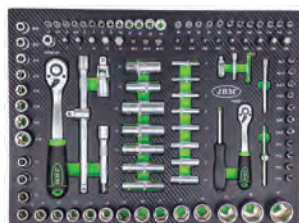

## SERVANTE D'OUTILS 9 TIROIRS

53867 1.095,00€



ACCESSOIRES ET PIÈCES DE RECHANGE

page 80

AVEC SÉPARATEURS



ORGANISATION LIBRE

18  
PCS

INCLUIDAS EN EL CARRO



21  
PCS

INCLUS DANS LE SERVANTE



TU POURRAIS AUSSI AIMER...

REF.	mm	Kg	ft	€
15070	67x53mm	0,05	200	0,50€
15071	103x53mm	0,05	200	0,60€
15072	138x53mm	0,05	200	0,70€
15074	210x53mm	0,10	200	1,00€
15075	280x53mm	0,10	200	1,20€

15076 3,50€

0,30 Kg 50

15073 1,00€

0,05 Kg 200

DIMENSIONS TIROIR INTERIEUR

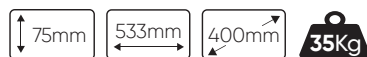

# SERVANTE AVEC 1 TIROIR + GUIDE TÉLESCOPIQUE

53866 424,00€

35.00	-	1	4
Kg	Sub	ff	



350Kg

## ACCESSOIRES ET PIÈCES DE RECHANGE

page 80



PLATEAU / SÉPARATEUR RÉGLABLE

SYSTÈME DE FERMETURE CENTRALISÉ

PLATEAU DE TRAVAIL ABS AVEC CASIERS

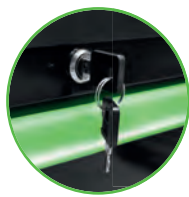
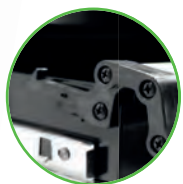
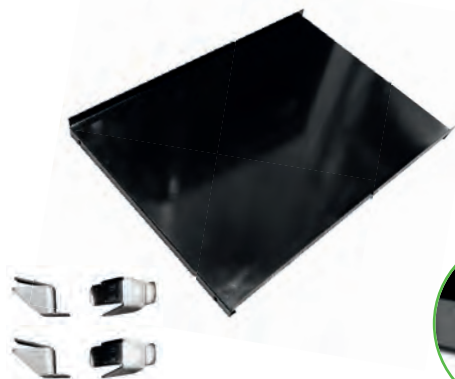

DIMENSIONS TIROIR INTERIEUR

75mm	533mm	400mm	35Kg
------	-------	-------	------



## MODULES D'OUTILS

### MODULE DE DOUILLES DE VIDANGE

15084 68,00€

MODULE FINITION EN FIBRE DE CARBONE

1.70	-	-	-
Kg	Sub	ff	

30mm	380mm	175mm
------	-------	-------

TU POURRAIS AUSSI AIMER...

15018 46,00€ 1.45 Kg 10 ff

MODULE VIDE POUR LE 15018 15083 8,50€

0.05	-	20	480
Kg	Sub	ff	

#### CONTIENT

	x2	5/16", 3/8"
	x7	7, 8, 10, 11, 12, 13, 14mm
	x1	10mm
	x1	10mm
	x7	8, 9, 10, 12, 13, 14, 17mm
	x1	T45
	x1	M16
	x1	200mm
	x1	150mm



Convient également pour les collecteurs d'huile réf. 53873 et 53874.

TVA non comprise

# MODULES EVA 175x30x380mm

MODULES D'OUTILS



15734 288,50€  
pg.70  
18,00 Kg 2 fl 48



15732 293,50€  
pg.70  
12,00 Kg 2 fl 48



15731 214,00€  
pg.70  
12,00 Kg 2 fl 48



15735 152,00€  
pg.70  
10,00 Kg 2 fl 48



15730 289,00€  
pg.70  
20,00 Kg 2 fl 48



15736 488,50€  
pg.70  
29,00 Kg 2 fl 40



15733 113,00€  
pg.70  
7,00 Kg 2 fl 48

## JEU DE 4 MODULES EVA FINITION EN FIBRE DE CARBONE

53708 325,00€

30mm 525mm 380mm

15,20 Kg 1 SUB 1 fl 24



14296 118,00€  
6,05 Kg 4 fl 80



14297 87,00€  
3,30 Kg 4 fl 96



14298 51,50€  
2,10 Kg 4 fl 96



14299 87,00€  
3,25 Kg 4 fl 96

14296		
	1/2" x17	10, 11, 12, 13, 14, 15, 16, 17, 18, 19, 20, 21, 22, 24, 27, 30, 32mm
	1/4" x13	4, 4.5, 5, 5.5, 6, 7, 8, 9, 10, 11, 12, 13, 14mm
	1/2" x5	14, 15, 17, 19, 22mm
	1/4" x8	6, 7, 8, 9, 10, 11, 12, 13mm
	1/2" x8	E10, E11, E12, E14, E16, E18, E20, E24
	1/4" x5	E4, E5, E6, E7, E8
	7Z x2	1/2" - 1/4"
	1/2" x2	125, 250mm
	1/4" x2	50, 100mm
	x2	
	1/2" x1	
	1/2" x2	16, 21mm
	1/2" x1	8mm
	x3	1.5, 2, 2.5mm
	x1	1/4"
	x1	1/4"
	x2	PH3, PH4
	x2	PZ3, PZ4
	8mm x5	7, 8, 10, 12, 14mm
	x3	SL8, SL10, SL12
	x5	T40, T45, T50, T55, T60
	x2	PH1, PH2
	x2	PZ1, PZ2
	1/4" x4	3, 4, 5, 6mm
	x3	SL4, SL5.5, SL6.5
	x8	T8, T10, T15, T20, T25, T27, T30

14298		
	PH0x75, PH1 x 100, PH2 x 100, PH3 x 150, PH4 x 200	
	6, 7, 8, 10, 11, 12, 13, 14, 15, 17, 19, 22mm	
	2x38mm	
	6x38mm	
	1.5, 2, 2.5, 3, 4, 5, 6, 8, 10mm	
	TX10, 15, 20, 25, 27, 30, 40, 45, 50	

14297		
	6x7, 8x9, 10x11, 12x13, 14x15, 16x17, 18x19, 20x22mm	
	6, 7, 8, 10, 11, 12, 13, 14, 15, 17, 19, 22mm	

14299		
	x1	8"
	x1	10"
	10"	7,5"
	8"	3m
	8"	

# MODULES EVA FINITION EN FIBRE DE CARBON

210x50x120mm

**15122** 74,00€

1.70	10	200
Kg	fl	fl

8, 9, 10, 11, 12, 13, 14, 15, 16, 17, 18, 19mm

**15155** 59,00€

2.45	10	180
Kg	fl	fl

8, 10, 11, 12, 13, 14, 15, 16, 17, 18, 19mm

**15156** 70,00€

2.05	10	180
Kg	fl	fl

21x23, 24x27, 25x28, 30x32 mm

**15157** 42,00€

0.95	10	300
Kg	fl	fl

6x8, 10x12, 13c14, 15x17, 19x21, 22x24 mm

**15158** 59,00€

1.30	10	240
Kg	fl	fl

8, 10, 11, 13, 14, 17, 19 mm

**15159** 44,00€

0.75	10	300
Kg	fl	fl

8x10, 11x13, 14x15, 17x19, 20x22 mm

**53943** 21,50€

0.80	10	240
Kg	fl	fl

⊕ PH4x200, PH3x150, PH2x100, PH2x38 PH1x80, PH0x120, PH1x100

**53944** 19,50€

0.80	10	240
Kg	fl	fl

⊖ SL9x200, SL4x125, SL5x100, SL5x80, SL6x38, SL6x100, SL8x150mm

**53945** 18,90€

0.60	10	240
Kg	fl	fl

T8x75, T9x75, T10x75, T15x75, T20x75, T25x100, T27x100

**54158** 38,00€

1.70	8	200
Kg	fl	fl

⊕	3/8"	x1	10mm
⊕	1/2"	x1	10mm
⊕	30mm	x7	4, 5, 6, 7, 8, 10, 12mm
⊕	75mm	x7	4, 5, 6, 7, 8, 10, 12mm
⊕	30mm	x8	T20, T25, T30, T40, T45, T50, T55, T60
⊕	75mm	x8	T20, T25, T30, T40, T45, T50, T55, T60
⊕	30mm	x5	M5, M6, M8, M10, M12
⊕	75mm	x5	M5, M6, M8, M10, M12

**15160** 42,00€

0.80	10	300
Kg	fl	fl

8x9, 10x11, 12x13, 14x15, 16x17, 18x19 mm

**15161** 62,00€

2.10	10	180
Kg	fl	fl

27, 29, 30, 32 mm

**15316** 58,00€

0.85	10	260
Kg	fl	fl

8, 9, 10, 11, 12, 13, 14, 15, 16, 17, 18, 19mm

**15454** 35,40€

1.10	10	300
Kg	fl	fl

8"

**15541** 27,60€

0.95	10	220
Kg	fl	fl

210x50x120mm

15514 9,35€



0.05 10 360  
Kg fl

15162 30,20€

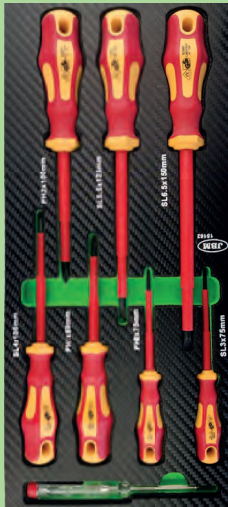

0.65 10 240  
Kg fl

Dimensions : SL 6,5x150 mm Voltmètre  
SL 3x75 mm PH 0x75 mm 140 mm rainure  
SL 4x100 mm PH 1x80 mm SL 0,5x3,0 mm  
SL 5,5x125 mm PH 2x100 mm

15706 31,00€



0.55 - 10 240  
Kg fl

15737 45,00€



1.70 - 10 200  
Kg fl

15315 28,20€



1.05 - 10 260  
Kg fl

175x50x460mm

51864 64,00€

1.87 - 10 210  
Kg fl



10x11mm (290mmL),  
12x14mm (330mmL),  
13x15mm (368mmL),  
16x18mm (407mmL),  
17x19mm (407mmL),  
22x24mm (430mmL)

52912 91,00€

1.62 - 10 210  
Kg fl

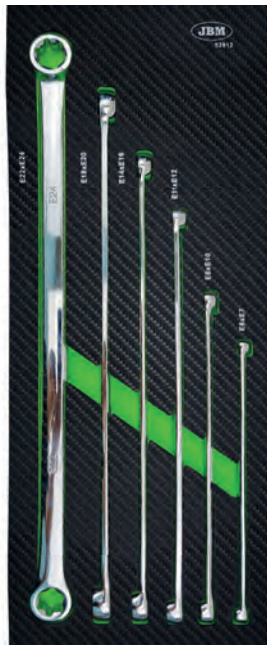

E6xE7 (200mmL),  
E8xE10 (235mmL),  
E11xE12 (290mmL),  
E14xE16 (370mmL),  
E18xE20 (410mmL),  
E22xE24 (420mmL)

54066 83,00€

2.00 - 5 175  
Kg fl



8mm (23,5mmL)  
10mm (29,3mmL)  
12mm (32,8mmL)  
13mm (34,9mmL)  
14mm (36,7mmL)  
17mm (41mmL)  
19mm (42mmL)

72

520x50x390mm

15681 134,00€

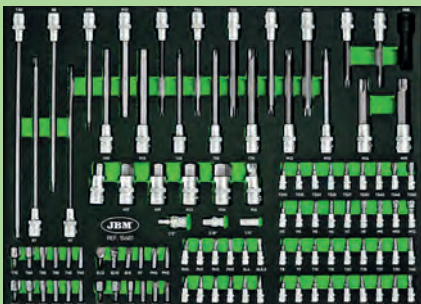

	H3, H4, H5, H6, H7, H8
	M8, M10, M12
	PH0, PH1, PH2, PH3
	PZ0, PZ1, PZ2, PZ3
	1/4" SL4, SL5.5, SL6.5, SL7
	T8, T9, T10, T15, T20, T25, T27, T30, T40
	T8, T9, T10, T15, T20, T25, T27, T30, T40
	TS10, TS15, TS20, TS25, TS27, TS30, TS40, TS45, TS50
	H7 (230mmL), H10, H11, H13 (140mmL), H14, H17, H19, H22, H24 (55mmL)
	M9 (100mmL), M10, M12, M14 (140mmL), M16 (53mmL), M16 (100mmL)
	R7, R8 (240mmL), R9 (100mmL), R10 (140mmL)
	T30 (300mmL), T40, T45, T50, T55, T60, T70 (140mmL), T80 (100mmL)
	HT5 (160mmL)

	1/2"	8mm
	3/8"	8mm
	1/4"	6mm
	1/2"	M18
		7, 8, 10, 12, 14mm
		PH3, PH4
		PZ3, PZ4
		SL8, SL10, SL12
	8mm	T40, T45, T50, T55, T60, T70
		T40, T45, T50, T55, T60, T70

15799 28,30€



1.35	-	10	200
Kg			

16111 19,20€



0.61	-	10	360
Kg			

11996 48,00€



2.10	-	10	300
Kg			

6x7mm - 20x22mm +  
24x27mm + 30x32mm

11997 39,00€



1.92	-	10	360
Kg			

6x7mm - 18x19mm +  
20x22mm

11998 49,00€



1.96	-	10	300
Kg			

6x7mm - 18x19mm -  
20x22mm



11994 33,00€



0.68	-	10	233
Kg			

1/4"

14114 19,30€



0.93	-	10	360
Kg			

13923 7,45€

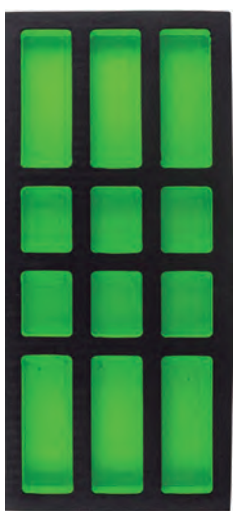

0.05	-	30	1299
Kg			

13667 17,60€



0.83	-	10	360
Kg			

13668 18,70€



0.61	-	10	300
Kg			

MODULES EN PLASTIQUE

10731 17,60€



0.68	-	10	233
Kg			

10732 18,70€



0.70	-	10	220
Kg			

10733 17,50€



0.69	-	10	220
Kg			

10735 20,30€



0.98	-	10	300
Kg			

53671 41,00€



210x50x120mm

72

1/4" - 85 mm  
1/2" - 135 mm  
3/8" - 102 mm

0.85	10	470
Kg		



MODULES D'OUTILS

53620 88,00€



3.52 4 112  
Kg f1 f2  
6x7,8x9,10x11,12x13, 14x15,16x17,18x19,20 x22mm  
6,7,8,9,10,11,12,13, 14,15,16,17,18,19,20, 21,22mm

54093 441,00€



pg.288  
3.52 4 112  
Kg f1 f2

51447 16,00€



0.34 5 20 960  
Kg f1 f2 f3  
50mm, 75mm, 100mm, 152mm, 227mm

53979 34,60€

340x50x390mm

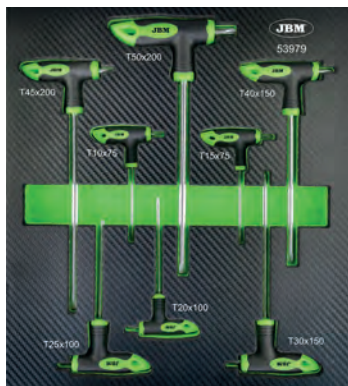

1.00 180  
Kg f1 f2  
H2x100, H2.5x100, H3x100, H4x150, H5x150, H6x200, H8x200, H10x200

53980 34,60€

340x50x390mm



1.00 10 180  
Kg f1 f2  
T10x75, T15x75, T20x100, T25x100, T30x150, T40x150, T45x200, T50x200mm

51805 17,00€



0.33 4 20 640  
Kg f1 f2 f3  
50mm, 75mm, 100mm, 152mm, 227mm

51448 52,00€

130x50x540mm



2.38 - 5 270  
Kg f1 f2 f3  
50mm, 125mm, 250mm, 380mm, 510mm

## ACCESSOIRES POUR SERVANTES

COMPATIBILITÉ

53764 / 53765 / 53766 / 53767 / 53768 / 53769 / 53770 / 53900 / 53901 / 53902 / 53912 / 53913

PORTE-SPRAY

15313 14,00€



PORTE ROULEAU

15068 15,20€

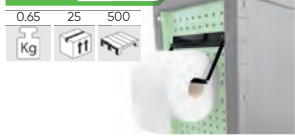

PORTE-SPRAY

14354 14,00€



PORTE DOCUMENTS

15069 32,80€

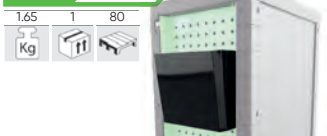

COMPATIBILITÉ

53686 / 53762 / 53661 53761 / 53767 / 53768 / 53904 / 54006

PORTE ROULEAU

16161 17,50€



PORTE DOCUMENTS

16162 35,10€



PORTE-SPRAY

16163 10,20€



16188 39,60€



PIÈCES DE RECHANGE POUR SERVANTES REF. 53661, 53686, 53763, 53764, 53765, 53766, 53866, 53867, 53868, 53869, 53870, 53900, 53901, 53904

REF.	DESCRIPTION	Kg	f1	f2	f3	€	COMPATIBILITÉ
14578	Guide de roulement à billes grand	1,05	1	25		12,50€	53661, 53686, 53904
14580	Couvercle supérieur	2,60	3	39		41,00€	53661, 53686, 53904
14783	Protecteur droit	0,25	1	50		5,50€	53661, 53686, 53904
15023	Roue pivotante	0,65	1	10		12,50€	53765, 53766, 53870
15024	Roue fixe	0,95	1	8		15,00€	53765, 53766, 53870
15025	Roue pivotante	0,65	1	10		12,50€	53900, 53901
15026	Roue fixe	0,95	1	8		15,00€	53900, 53901
15030	Roue pivotante	0,30	1	50		8,00€	53765, 53766
15033	Poignée pour tiroir étroit	0,30	1	50		6,00€	53868
15034	Couvercle supérieur	-	-	-		57,00€	53868
15035	Poignée pour tiroir	0,36	1	20		8,50€	53869
15036	Poignée pour tiroir	0,36	1	20		8,50€	53870
15037	Poignée pour tiroir	-	-	-		8,00€	53900, 53901
15038	Couvercle supérieur	-	-	-		34,50€	53869, 53870
15040	Roue fixe	0,66	1	10		12,50€	53904
15041	Roue pivotante	0,98	1	8		15,00€	53904
15042	Poignée pour tiroir	0,10	1	-		7,50€	53904
15050	Poignée pour tiroir	0,10	1	50		9,50€	53661, 53686
15058	Protecteur latéral	-	-	-		7,50€	53868
15065	Protecteur latéral	0,55	1	12		6,50€	53869, 53870



14580, 15034, 15038



14578



15030, 15035, 15036, 15037, 15042, 15050



15033

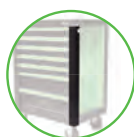

14783

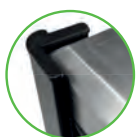

15058, 15065



15023, 15025, 15040



15024, 15026, 15041



## SERVANTE ATELIER 3 PLATEAUX

51576

125,00€

15,00	-	1	24
Kg	SUB	ff	ff



100Kg



## SERVANTE ATELIER 3 PLATEAUX XXL

52373

252,00€

24,70	-	1	12
Kg	SUB	ff	ff



150Kg

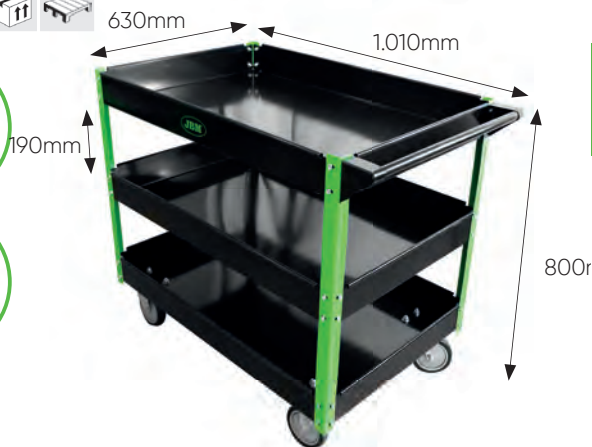

## ARMOIRE DE TRAVAIL MULTIMÉDIA AVEC ROUES

51456

550,00€

42,50	-	1	2
Kg	SUB	ff	ff

- Roues sans montage.

JEU DE 4 ROUES POUR SERVANTE REF. 51456

Ø12cm  
2 Roues avec frein + 2 simples

11313 54,00€

4,11	-	1	104
Kg	SUB	ff	ff



## PANNEAUX PERFORÉ

52419

80,00€

7,07	-	1	30
Kg	SUB	ff	ff

1.000 x 600mm

52420

108,00€

10,80	-	2	35
Kg	SUB	ff	ff

1.500 x 600mm

52421

172,00€

14,00	-	2	38
Kg	SUB	ff	ff

2.000 x 600mm



ATTELAGE CARRÉ

## CROCHETS

### SUPPORT PORTE OUTILS

51657

5,85€

POUR REF.: 52419, 52420, 52421

0,30	-	10	50	1000
Kg	SUB	ff	ff	ff

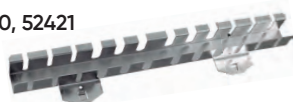

### SUPPORT POUR CLÉS

51653

5,10€

POUR REF.: 52419, 52420, 52421

0,28	-	10	840
Kg	SUB	ff	ff

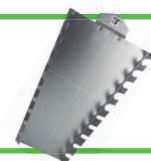

POUR REF. 52419, 52420, 52421

95mm CROCHET BOUCLE  
51654 4,80€

0,09	-	10	100	4000
Kg	SUB	ff	ff	ff

31mm CROCHET DOUBLE  
51655 4,10€

0,07	-	10	100	4000
Kg	SUB	ff	ff	ff

200mm CROCHET DOUBLE EXTRALONG  
52634 5,25€

0,15	-	10	50	1500
Kg	SUB	ff	ff	ff

200mm CROCHET LONG BOUCLE  
52635 4,80€

0,14	-	10	50	1500
Kg	SUB	ff	ff	ff

92mm CROCHET DOUBLE LONG  
51658 4,50€

0,05	-	10	100	1500
Kg	SUB	ff	ff	ff

91mm CROCHET LONG  
51656 3,65€

0,05	-	10	100	1500
Kg	SUB	ff	ff	ff

95mm CROCHET DOUBLE LONG  
51422 2,97€

0,05	-	100	1500
Kg	SUB	ff	ff

POUR REF. 51035, 53661, 53686, 53761, 53762, 53767, 53768, 53904

CROCHET DOUBLE LONG 95mm

CROCHET LONG 90mm  
51419 2,79€

0,03	-	100	2000
Kg	SUB	ff	ff

CROCHET COURT BAS 30mm  
51975 2,27€

0,03	-	100	4000
Kg	SUB	ff	ff

CROCHET DOUBLE LONG 75mm  
51976 1,63€

0,03	-	100	3000
Kg	SUB	ff	ff

51422 2,97€

0,05	-	100	1500
Kg	SUB	ff	ff

# ÉTABLI AVEC PANNEAU PERFORÉ

**51035** 799,00€

DIMENSIONS TIROIR INTERIEUR

**600Kg**

86.50 - 1 5  
Kg SUB IT

142mm 348mm 441mm

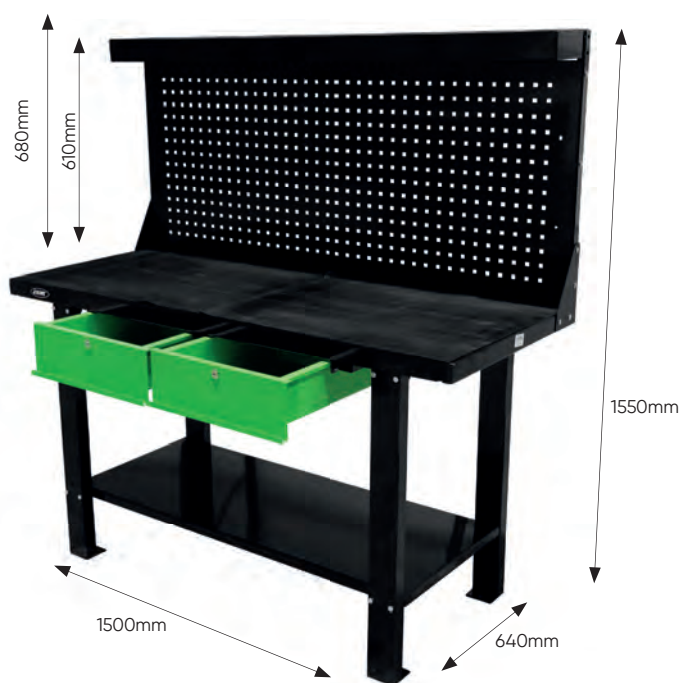

JEU DE 2 TAPIS EN CAOUTCHOUC POUR TABLE DE TRAVAIL RÉF. 51737

**15145** 20,45€

1.90 100 100  
Kg SUB IT

# ÉTABLI 3 TIROIRS

**51738** 850,00€

DIMENSIONS TIROIR INTERIEUR

**1T**

**50Kg**

81.50 - 1 5  
Kg SUB IT

142mm 348mm 441mm

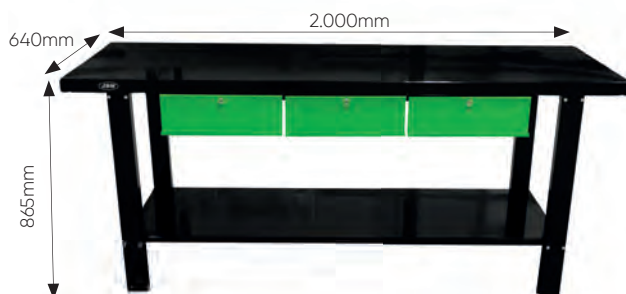

TAPIS DE BUREAU EN CAOUTCHOUC

**15144** 30,00€

2.50 100 100  
Kg SUB IT

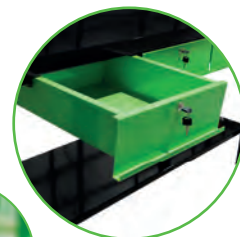

# ÉTABLI 2 TIROIRS

**51737** 699,00€

DIMENSIONS TIROIR INTERIEUR

**800Kg**

65.50 - 1 5  
Kg SUB IT

142mm 348mm 441mm



TAPIS DE BUREAU EN CAOUTCHOUC

**15145** 20,45€

1.90 100 100  
Kg SUB IT

# ÉTABLI DE 1 TIROIR

**53674** 447,00€

DIMENSIONS TIROIR INTERIEUR

**800Kg**

50.00 - 1 5  
Kg SUB IT

142mm 348mm 441mm

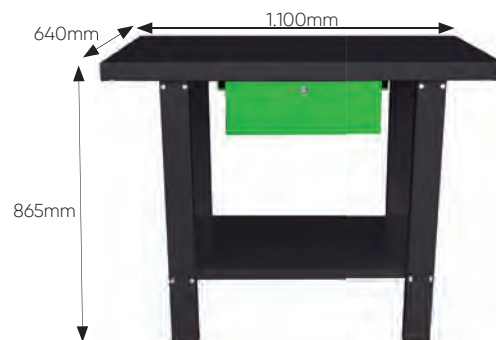

TAPIS DE BUREAU EN CAOUTCHOUC

**15146** 16,20€

1.35 100 100  
Kg SUB IT

# CHARIOT MODULAIRE

53672

440,00€

23,00 - 1 6



90  
PCS



3 COMPARTIMENTS AMOVIBLES ET SÉPARABLES

ILS PEUVENT ÊTRE UTILISÉS INDIVIDUELLEMENT OU ENSEMBLE



POIGNÉE SUPÉRIEURE DANS CHAQUE MODULE POUR FACILITER LE TRANSPORT INDIVIDUEL



VERROUILLABLE AVEC CADENAS (NON INCLUS)

3 MODULES INDÉPENDANTS ÉQUIPÉS DE:



	1/2" x11	8,10,11,12,13,14,16,17,19,21,22mm
	1/4" x13	4,4,5,5,5,5,6,7,8,9,10,11,12,13,14mm
	1/2"	
	1/4"	
	1/2" x2	125,300mm
	1/4" x2	50,100mm

	1/4" x1	
	1/4" x1	
	1/4" x1	
	1/2" x1	
	1/4" x1	
	x8	1,5x8mm
	x1	3m
	1/4" x32	



	x1	180mm
	x1	160mm
	x2	160mm, 180mm
	x2	PH2x125, PH1x100mm
	x2	6x150mm, 5x100mm



	x9	8,9,10,11,12,13,14,17,19mm
	x1	250mm
	x1	300g
	x1	250mm
	x1	200mm



Plateau supérieur amovible

Conteneur pour des outils plus grands

**1** BOÎTE À OUTILS EN MODULES EVA + PLATEAU SUPÉRIEUR AMOVIBLE



**2** 2 TIROIRS AVEC OUTILS EN MODULES EVA

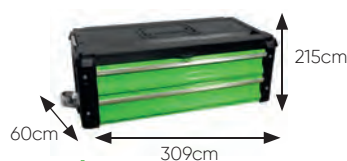

**3** 3 MODULES INDÉPENDANTS ÉQUIPÉS DE:



TVA non comprise

**JBM** / [www.jbmfrance.fr](http://www.jbmfrance.fr)

83

MATÉRIEL D'ATELIER



# KIT DE 64 PIÈCES DANS LE BOÎTIER EN MÉTAL

**53565** 258,00€

16.50 - 1 24



**CrV** **64 PCS**

290mm 495mm 200mm

**ACIER ZINGUÉ**



MATÉRIEL D'ATELIER

**CONTIENT**

	1/2" x18	10, 11, 12, 13, 14, 15, 16, 17, 18, 19, 20, 21, 22, 23, 24, 27, 30, 32mm		1/2" x1	255mm		+	x3	PH1x100mm, PH2x150mm, PH3x200mm
	x1	1/2"		x1	21mm		-	x3	SL5x100mm, SL6x150mm, SL8x200mm
	x1	1/2"		x1	457mm				
	x1	1/2"		x18	6, 7, 8, 9, 10, 11, 12, 13, 14, 15, 16, 17, 18, 19, 20, 21, 22, 24mm				
	x3	1/2"		x9	1, 5, 2, 2, 5, 3, 4, 5, 6, 8, 10mm				



**PIÈCES DE RECHANGE DISPONIBLES**

## BOITE À OUTILS 5 COMPARTIMENTS

**51574** 52,00€

3.20 - 1 28



## COFFRE À OUTILS XL

**53222** 57,00€

6.25 - 1 25



**XL**



## COFFRE À OUTILS 3 TIROIRS FRONTAUX + COMPARTIMENT SUPÉRIEUR

**51600** 109,00€

8.45 - 1 18



**DIMENSIONS TIROIR INTÉRIEUR**

48mm 273mm 570mm

**AVEC POIGNÉE**



## COFFRET À OUTILS 6 TIROIRS + COMPARTIMENT SUPÉRIEUR

**51575** 317,00€

19.75 - 1 8



- Grands tiroirs: 570mm large  
- Petits tiroirs: 180mm large

**SANS POIGNÉE**



## TABOURET ATELIER RÉGLABLE

**50843** 79,00€

5,61 - 1 48  
Kg SUB

520mm  
↑520mm  
↓390mm



## TABOURET ATELIER SUR ROULETTES

**50844** 65,00€

3,50 - 1 60  
Kg SUB



## CHARIOT DE VISITE FIXE

**52148** 82,00€

6,00 - 1 20  
Kg SUB

- Plastique haute densité.
- Caoutchouc roues renforcées.
- Très résistant.

150KG



## CHARIOT DE VISITE PLIABLE

**50808** 77,00€

5,63 - 1 28  
Kg SUB

150KG



## CHARIOT DE VISITE CONVERTIBLE PLIABLE

**53211** 75,00€

5,40 - 1 38  
Kg SUB



**52542** 109,00€

12,70 - 1 19  
Kg SUB

ACIER ET SIEGE EN PVC



7 ROUES



135KG

115KG



## ÉTAU D'ÉTABLI 150MM TYPE RAPIDE

52871 248,00€

24,50 - 1 28

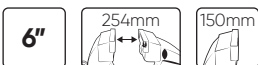

OUVERTURE IMMEDIATE  
AVEC CLEVER +  
EMBASE TOURNANTE



## ÉTAU ÉTABLI D'ACIER AVEC EMBASE TOURNANTE

53031 59,00€

5,70 - 1 128

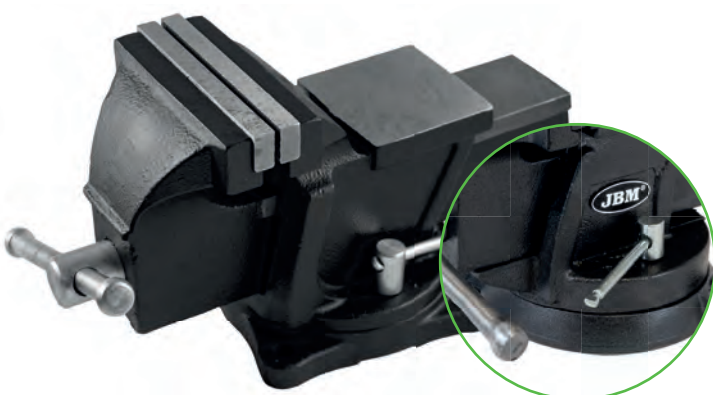

53032 126,00€

13,71 - 1 60



## ÉTAU ÉTABLI D'ACIER

52869 52,00€

4,15 - 4 192



52870 100,00€

12,15 - 1 72

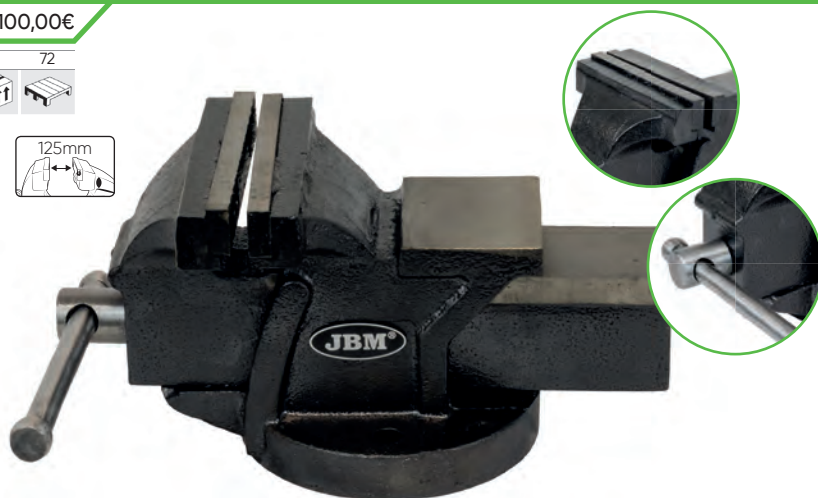

## ENCLUME PROFESSIONNELLE

52308 440,00€

47,00 - 1 24

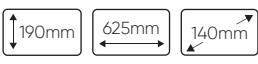

52309 941,00€

100,00 - 1 8



ACIER



## **OUTILLAGE ÉLECTROPORTATIF (À BATTERIE)**

- 88 CLÉS À CHOC
- 91 CLIQUET / VISSEUSE
- 92 PERCEUSE À IMPACT
- 94 MEULEUSE
- 95 SCIES
- 98 MULTI-OUTILS OSCILLANT
- 99 PISTOLETS
- 101 ASPIRATEUR / COMPRESSEUR
- 102 ILUMINATION LED
- 103 JARDINERIE
- 107 STOCKAGE
- 108 BATTERIES / CHARGEURS
- 109 ACCESSOIRES / CONSOMABLES

# Outils électriques sans fil, pour une utilisation plus confortable et illimitée

Avec moteur **BRUSHLESS**: meilleure efficacité, durée de vie plus longue, plus de vitesse et moins de bruit.



## CLÉ À CHOC 1/2" AVEC MOTEUR BRUSHLESS

**1000Nm**

**60018 306,00€**



Batterie non incluse.

Cet outil est conçu pour **visser / dévisser** des fixations.



**BRUSHLESS MOTOR** 20V 1000 Nm 1/2" 0-2300IPM

① 0-900 RPM ② 0-1600 RPM ③ 0-1900 RPM LED

ARBRE DE SORTIE

**14675 17,00€**

INTERRUPTEUR

**14677 9,00€**

BOÎTIER

**14679 9,50€**

CIRCUIT IMPRIMÉ + STATOR

**14648 106,00€**

BLOC DE CHOC

**14676 36,50€**

CIRCUIT IMPRIMÉ

**14678 86,00€**

ROTOR

**14769 37,75€**

5 VITESSES DIFFÉRENTES



Instructions sur les vitesse rotatifs



- Comprend:  
Poignée.  
Sélecteur de sens de rotation avant / arrière.  
Déclencheur.  
Rétro-éclairage LED.  
Crochet pour courroie.





## CLÉ À CHOC 1/2" AVEC MO- TEUR BRUSHLESS

**1200Nm**

**60044** 478,00€

3.20	-	5	144
Kg	Sub	ff	

Batterie non incluse.

Cet outil est conçu pour **visser / dévisser** des fixations.



**BRUSHLESS MOTOR**

**20V**

**1200 Nm**

**1/2"**

①

0-1000 RPM

②

0-1350 RPM

③

0-1600 RPM

0-1000IPM

0-1600IPM

0-2000IPM

ARBRE DE SORTIE

**16151** 50,00€

INTERRUPTEUR

**16152** 25,10€

BOÎTIER

**16153** 81,00€

CIRCUIT IMPRIMÉ + STATOR

**16154** 34,10€

BLOC DE CHOC

**16155** 34,10€

CIRCUIT IMPRIMÉ

**16156** 12,60€

ROTOR

**16157** 59,00€

## CLÉ À CHOC 1/2" A BATTERIE AVEC MA- LLETTE

**60044C** 652,00€

3.20	-	4	-
Kg	Sub	ff	

CHARGEUR 20 V - 4A

**60016** 49,00€

0.80	-	5	210
Kg	Sub	ff	

BATTERIE LI-  
THIUM-ION 4.0 Ah

**60013** 80,00€

0.75	-	5	700
Kg	Sub	ff	



Utilisez-les avec des batteries JBM: une seule batterie adaptée à tous les outils

BATTERIE LI-ION

2.0Ah



**60012**

4.0Ah



**60013**

6.0Ah



**60015**

CHARGEURS



**4A**  
**60016**



HAUTE PERFORMANCE  
**6A**  
**60017**



## CLÉ À CHOC 3/4" AVEC MO- TEUR BRUSHLESS

**1550Nm**

**60034 320,00€**

3,20	-	4	144

Batterie non incluse.

Cet outil est conçu pour **visser / dévisser** des fixations.

### 20V

1550 Nm

①

0-900 RPM

②

0-1600 RPM

③

0-1900 RPM

ARBRE DE SORTIE

**14675** 17,00€

INTERRUPTEUR

**14677** 9,00€

BOÎTIER

**14679** 9,50€

BLOC DE CHOC

**14676** 36,50€

CIRCUIT IMPRIMÉ

**14678** 86,00€

ROTOR

**14769** 37,75€

CIRCUIT IMPRIMÉ + STATOR

**14648** 106,00€

### 5 VITESSES DIFFÉRENTES



### Instructions sur les vitesse rotatifs



- Comprend:
- Poignée.
- Sélecteur de sens de rotation avant / arrière.
- Déclencheur.
- Rétro-éclairage LED.
- Crochet pour courroie.



## OUTIL À CHOC SANS BROSSES

**60005** 132,00€

1.40 - 4 180  
Kg SUB ff

Batterie non incluse.

Cet outil est conçu pour **serrer rapidement les vis et les écrous** et il est particulièrement utile lorsque vous travaillez avec des **attaches longues et des matériaux durs**.

Le tournevis est muni d'un **éclairage LED** de la zone de travail pour un travail plus confortable et précis, d'un **mandrin à changement rapide hexagonal de 1/4"** de pouce pour une installation et un retrait rapides de la buse, ainsi que d'un **déclencheur avec fonction de verrouillage** pour éviter un démarrage accidentel de l'outil.

- Pièces à fournir :  
Crochet pour courroie,  
1 pièce.  
Rétro-éclairage LED intégré.  
Régulateur de vitesse de rotation.  
Poignée souple.  
Réducteur à engrenages métalliques.



BLOC DE CHOC  
**14637** 15,50€

CIRCUIT IMPRIMÉ  
**14642** 83,00€

ARBRE EN T  
**14638** 7,00€

CIRCUIT IMPRIMÉ + STATOR  
**14765** 97,00€

INTERRUPTEUR  
**14640** 8,00€

BOÎTIER  
**15254** 12,50€

ROTOR  
**14641** 18,50€

### CONSOMMABLES

**53857** **53858**



page 111

### Utilisez-les avec des batteries JBM: une seule batterie adaptée à tous les outils

#### BATTERIE LI-ION

2.0Ah



**60012**

4.0Ah



**60013**

6.0Ah



**60015**

#### CHARGEURS



4A  
**60016**



HAUTE PERFORMANCE  
6A  
**60017**

## 1/2" CLIQUET ÉLECTRIQUE BRUSHLESS

**60024** 190,00€

1.90 - 5 150  
Kg SUB ff

CETTE RÉFÉRENCE COMPREND  
X1 BATTERIE ET X1 CHARGEUR

Cet outil est conçu pour **serrer/desserrer les attaches dans les endroits difficiles d'accès**.

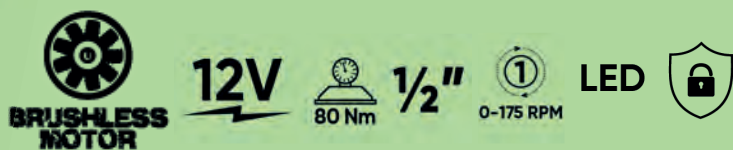

**2.0AH**  
60min +/- 10min

CE RoHS TÜV

COMPREND:

CHARGEUR 12 V  
POUR REF. 60026

**60025** 31,60€

0.30 5 4 700  
Kg SUB ff



BATTERIE AU LITHIUM-ION  
2.0 A\*h SAMSUNG  
POUR REF. 60024

**60026** 37,90€

0.20 8 5 1400  
Kg SUB ff

TVA non comprise

**JBM** / [www.jbmfrance.fr](http://www.jbmfrance.fr)

# PERCEUSE À PERCUSSION À DEUX VITESSES AVEC MOTEUR BRUSHLESS

**60006** 182,00€

2.50 - 4 68



Batterie non incluse.

Cet outil est conçu pour le **perçage du bois et du métal**, les opérations de percussion principalement dans la **maçonnerie, le béton, la pierre et la brique rouge**, ainsi que pour le serrage/desserrage des vis et écrous.

L'outil possède un commutateur pour sélectionner le mode de fonctionnement (**perçage, perçage à percussion et serrage des fixations**), un accouplement avec **23 valeurs prédéfinies** du couple de serrage, un régulateur de vitesse de rotation et un **mandrin sans clé de 1/2"** pour une installation/un retrait rapide et pratique de l'outil.



- Pièces à fournir:  
Poignée supplémentaire, 1 pièce.  
Crochet pour courroie, 1 pièce.  
23 réglages de couple.  
Rétro-éclairage LED intégré.  
Commutateur à 2 vitesses.  
Poignée souple.

MANCHON PORTE-FORET

**14643** 24,50€

INTERRUPTEUR

**14644** 8,00€

ROTOR

**14645** 45,00€

CIRCUIT IMPRIMÉ + STATOR

**14646** 110,00€

POIGNÉE SUPPLÉMENTAIRE

**14954** 14,50€

**20V** 80 Nm **1/2"** 29750IPM  
**BRUSHLESS MOTOR** ① ② **LED**  
 0-500 RPM 0-1750 RPM  
**DIAMÈTRE DU MANDRIN: 2-13MM (1/2")**  
**POIGNÉE SUPPLÉMENTAIRE**

## CONSOmmABLES

page 109-111

KIT DE FORETS POUR BÉTON

**53861**

**53860**



KIT DE FORETS HÉLICOÏDAUX HSS 4341

**53852**

**53856**



KIT S2 D'EMBOUS À CHOC À CHANGE-MENT RAPIDE - REVÊTEMENT NOIR

**53857**

**49**  
PCS



**53858**

**21**  
PCS



KIT DE SCIES CLOCHES BIMÉTALLIQUES

**53859**

**8**  
PCS



# MEULEUSE ANGULAIRE AVEC MOTEUR BRUSHLESS

Batterie non incluse.  
Disque non inclus.

Diamètre du disque: **115 mm (4-1/2")**

Diamètre du disque: **125 mm**

**60008** 141,00€

**60028** 142,00€

1.85 - 4 156



1.95 - 4 144



- La meuleuse angulaire est conçue pour **moudre, dénuder et couper divers matériaux**.  
- Taille de filetage: **M14**.

**20V** **BRUSHLESS MOTOR** ① **8000 RPM** **M14**

- Éléments à fournir :  
Couvercle de meule, 1 pièce.  
Poignée supplémentaire, 1 pièce.  
Clé, 1 pièce.



ROTOR

**14652** 47,00€

INTERRUPTEUR

**14653** 5,25€

CIRCUIT IMPRIMÉ + STATOR

**14654** 104,00€

ENGRENAGE #13

**14655** 5,95€

PLAQUE DE PRESSION

**14656** 4,50€

ROULEMENT #23

**14657** 4,50€

ENGRENAGE #22

**14766** 3,15€

ROULEMENT #29

**14767** 2,34€

POIGNÉE SUPPLÉMENTAIRE

**14956** 4,40€

GARDE-ROUE 115MM

**14957** 4,10€

GARDE-ROUE 125MM

**14808** 3,05€

ÉCROU DE VERROUILLAGE RAPIDE M14

**15014** 20,00€



## CONSOmmABLE

page 112

CERCLE DE COUPE POUR MÉTAL / CERCLE DE COUPE POUR ACIER INOXYDABLE

**14893**

**T42**



**14900**

**T41**



ÉCROU DE VERROUILLAGE RAPIDE M14 POUR MEULEUSE D'ANGLE

**15014**



# PERFORATEUR AVEC MOTEUR BRUSHLESS

**60023** 212,00€

3,10 - 6 120  
Kg

Batterie non incluse.

Cet outil est conçu pour le forage à percussion et le **déchetage du béton et de la brique**, ainsi que pour le forage habituel d'autres matériaux tels que **l'acier, le bois, le métal, la céramique et le plastique**.

- Type de mandrin: **SDS**.



**BRUSHLESS MOTOR**

**20V** 4750BPM 2.2 J 1350 RPM

**WOOD** 28mm **CONCRETE** 22mm **STEEL** 13mm

**SDS**

- Pièces à fournir :  
Clapet anti-poussière.  
Jauge de profondeur.  
Poignée supplémentaire.  
Burin pointu.  
Burin plat.  
Forets SDS: Ø8/10/12 x 150 mm.



LEVIER DE PUISSANCE <b>14693</b> 3,50€	BAGUE D'ÉTANCHÉITÉ <b>14698</b> 1,00€	COUVERCLE ANTI-POUSSIÈRE <b>14967</b> 5,50€
ROULEMENT DU BRAS PENDULAIRE <b>14694</b> 11,50€	ROTOR <b>14699</b> 30,00€	JAUGE DE PROFONDEUR <b>14968</b> 6,00€
MARTEAU DE CHOC <b>14695</b> 4,00€	ROULEMENT N° 61 <b>14700</b> 2,50€	
CYLINDRE PNEUMATIQUE <b>14696</b> 18,00€	CIRCUIT IMPRIMÉ <b>14702</b> 92,00€	
INTERRUPTEUR <b>14697</b> 8,00€	ROULEMENT N° 67 <b>14701</b> 2,50€	

## CONSOMMABLES

page 109

<b>14837</b> BURIN À EXTRÉMITÉ AIGUÉ SDS-PLUS 14 X 250 MM	<b>14839</b> BURIN À EXTRÉMITÉ PLATE SDS-PLUS 40 X 250 MM	<b>14841</b> ADAPTATEUR SDS-PLUS POUR MANDRIN DE PERÇAGE 1/2"	<b>14842</b> MANDRIN DE PERÇAGE À CHANGEMENT RAPIDE 2-13 MM 1/2"-20 UNF	<b>53850</b> KIT DE FORETS POUR PERCEUSE AVEC EMMAN-CHEMENT SDS-PLUS
<b>14838</b> BURIN À EXTRÉMITÉ PLATE SDS-PLUS 20 X 250 MM	<b>14840</b> BURIN À RAINURER SDS-PLUS 250 MM			

# MEULEUSE BRUSHLESS

**60033** 104,00€

13,50 - 4 144  
Kg

Batterie non incluse.

Cet outil est conçu pour **poncer le bois, le fer, le plastique et les matériaux similaires** à l'aide d'un papier abrasif approprié. La conception de cette ponceuse prévoit trois vitesses, une poignée confortable et un sac à poussière intégré.



**20V** 6000 RPM 8000 RPM 10000 RPM

0°C 45°C

x3 SPEED 150mm

SAC À POUSSIÈRE <b>15530</b> 7,50€	ROULEMENT <b>15533</b> 4,50€	ROULEMENT <b>15536</b> 14,50€
SUPPORT SAC ASPIRATEUR <b>15531</b> 5,00€	ROULEMENT <b>15534</b> 4,50€	UNITÉ DE FREIN EN CAOUTCHOUC <b>15537</b> 6,00€
STATOR + CIRCUIT IMPRIMÉ + CAPTEUR <b>15532</b> 98,00€	SELLE DE ROULEMENT <b>15535</b> 3,50€	PLAQUE DE BASE <b>15538</b> 17,00€

Utilisez-les avec des batteries JBM: une seule batterie adaptée à tous les outils

### BATTERIE LI-ION

2.0Ah **60012** 4.0Ah **60013** 6.0Ah **60015**

### CHARGEURS

4A **60016** HAUTE PERFORMANCE 6A **60017**

## POLISSEUSE AVEC MOTEUR BRUSHLESS

60009 168,00€

2.65	-	4	80
Kg	SLB	ff	

Batterie non incluse.



L'outil est conçu pour les processus de finition, tels que le **polissage et l'arrondi des coins et des bords**, ainsi que pour l'obtention de **surfaces lisses** avec un disque et un tampon de polissage.

L'appareil dispose d'un commutateur de vitesse de rotation à **9 vitesses**, ainsi que d'un **déclencheur avec fonction de fixation** pendant le travail ou celle de verrouillage pendant le stockage pour éviter un démarrage accidentel.



**BRUSHLESS MOTOR**

20V

800-2400 RPM

M14

VITESSE RÉGLABLE



Ø 180mm

- Pièces à fournir :  
Poignée supplémentaire en forme de D.  
Clé hexagonale.  
Tampon de polissage.  
Commutateur de tours à 9 vitesses: 800, 1000, 1200, 1400, 1600, 1800, 2000, 2200, 2400 tr/min.  
Poignée souple.  
Commutateur de sécurité.  
Bouton de verrouillage de la broche.

ROTOR

14658 45,00€

CIRCUIT IMPRIMÉ + STATOR

14660 83,00€

ROULEMENT #24

14662 2,50€

ROUE DE POLISSAGE

14958 22,00€

INTERRUPTEUR

14659 5,00€

ENGRENAGE

14661 9,00€

ROULEMENT #26

14663 2,50€

POIGNÉE EN D SUPPLÉMENTAIRE

14959 10,00€



## RABOTEUSE BRUSHLESS

60020 175,00€

3.15	-	4	72
Kg	SLB	ff	

Batterie non incluse.



Cet outil est conçu pour **travailler avec du bois**. Il permet d'obtenir une surface lisse du **bois et de l'effiler si nécessaire**.

Le rabot est muni d'une **base en alliage d'aluminium** pour un positionnement précis, d'un **système de collecte de poussière** pour collecter la poussière provenant du traitement du bois et d'un **bouton de verrouillage** du déclencheur pour éviter un démarrage accidentel de l'outil.

- Pièces à fournir :  
Poignée de réglage de profondeur de languette, 1 pièce.  
Guide parallèle, 1 pièce.  
Poignée de réglage, 3 pièces.  
Clé, 1 pièce.  
Vis, 1 pièce.



**BRUSHLESS MOTOR**

20V



16000 RPM

10,5mm

82mm  
0-2mm

- Caractéristiques:  
Poignée de réglage de profondeur d'échantillonnage  
Base en alliage d'aluminium  
Bouton de verrouillage du bouton de démarrage  
Système de collecte de poussière  
Poignée souple

STATOR

14936 27,50€

CEINTURE

14684 3,00€

GUIDE À BOUVETAGE

14964 8,00€

INTERRUPTEUR

14685 5,00€

GUIDE PARALLÈLE

14965 8,50€

CIRCUIT IMPRIMÉ

14686 73,00€

ROTOR

14687 35,00€





- Éléments à fournir :  
Lame pour bois, 1 pièce.  
Lame pour métal, 1 pièce.

## SCIE ALTERNATIVE AVEC MOTEUR BRUSHLESS

60019 178,00€

3,45 - 4 112



Batterie non incluse.

Cet outil est conçu pour **couper une grande variété de matériaux et est largement utilisé**. Sa conception permet un **remplacement rapide et pratique de la lame de scie** grâce au support à serrage rapide et se caractérise par une vitesse de coupe réglable en fonction de l'opération.



LEVIER D'ÉQUILIBRAGE

14680 17,00€

CIRCUIT IMPRIMÉ + STATOR

14681 108,00€

INTERRUPTEUR

14682 9,00€

CIRCUIT IMPRIMÉ

14683 86,00€

ROTOR

14770 40,00€

CONSOMMABLES POUR REF. 60019

page 112

14995

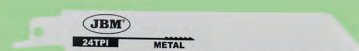

14994

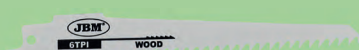

CONSOMMABLES POUR REF. 60010

page 112

14993



14991



## SCIE À HORLOGER AVEC MOTEUR BRUSHLESS

60010 170,00€

2,80 - 4 144



Batterie non incluse.

Cet outil est conçu pour **scier des matériaux** tels que le **bois, l'acier, le plastique et le métal**. La scie à horloger est munie d'un **mécanisme pendulaire à 4 positions** : 3 positions pour la coupe orbitale et 1 position pour la coupe directe, ce qui vous permet de choisir la vitesse de coupe optimale de la lame en fonction de la dureté du matériau.



20V

WOOD Max: 135mm  
STEEL Max: 8mm



2600 SPM LED

CIRCUIT IMPRIMÉ + STATOR

14664 100,00€

INTERRUPTEUR

14665 8,80€

CIRCUIT IMPRIMÉ

14666 97,00€

ENGRENAGE

14667 8,80€

LEVIER D'ÉQUILIBRAGE

14668 7,70€

COMPOSANTS DE ROULEAU

14670 4,50€

ROTOR

14768 28,80€

TUBE À POUSSIÈRE

14960 3,85€

GUIDE PARALLÈLE

14961 3,95€

- Comprend:  
1 pièce: lame pour bois.  
1 pièce: guide de bord.  
1 pièce: tuyau de poussière.

- Caractéristiques:  
Réducteur avec engrenages en métal.  
Poignée souple.  
Régulateur de tours.  
Mécanisme pendulaire à 4 positions.  
Base en aluminium.  
Rétro-éclairage LED intégré.  
Bouton de verrouillage du déclencheur.

Utilisez-les avec des batteries JBM: une seule batterie adaptée à tous les outils

BATTERIE LI-ION

2.0Ah



60012

4.0Ah



60013

6.0Ah



60015

CHARGEURS

4A



60016

HAUTE PERFORMANCE

6A



60017

## SCIE À DISQUE MINIATURE AVEC MOTEUR BRUSHLESS

60011 175,00€

2,55 - 4 128



Batterie non incluse.

Cet outil est conçu pour **scier du bois**. La scie circulaire d'un diamètre de **115 mm avec 24 dents** est idéale pour les **coupes longitudinales/transversales droites**, ainsi que pour le sciage de planches et panneaux de bois à un **angle allant jusqu'à 45°**. La scie possède également un **bouton de verrouillage** du déclencheur pour éviter un démarrage accidentel de l'outil et un **boîtier en aluminium**.



- Comprend:  
1 pièce: lame 24T TCT 115mm.  
1 pièce: guide de bord.  
1 pièce: tuyau de poussière.  
1 pièce: clé hexagonale.

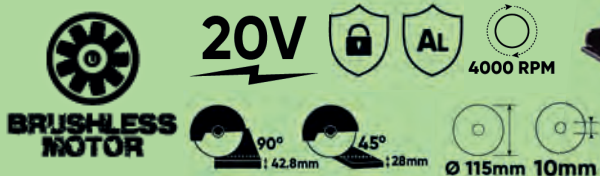

- Caractéristiques:  
Mécanisme de verrouillage  
Poignée souple  
Boîtier supérieur et inférieur en aluminium  
Système de collecte de poussière

ROTOR

14671 44,00€

CIRCUIT IMPRIMÉ + STATOR

14674 73,00€

GUIDE PARALLÈLE

14963 7,50€

INTERRUPTEUR

14672 5,00€

TUBE À POUSSIÈRE

14962 6,50€



CONSOMMABLES POUR REF. 60011

page 112

Scie circulaire 24T 115mm

14989 14986

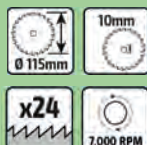

CONSOMMABLES POUR REF. 60007

page 112

Scie circulaire 24T 165mm

14988 14985

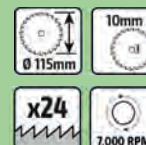

## SCIE À DISQUE AVEC MOTEUR BRUSHLESS

60007 170,00€

Batterie non incluse.

3,75 - 4 60



Cet outil est conçu pour **scier du bois**. La scie circulaire d'un diamètre de **165 mm avec 24 dents** est idéale pour les **coupes longitudinales/transversales droites**, ainsi que pour le sciage de planches et panneaux de **bois à un angle allant jusqu'à 45°**.

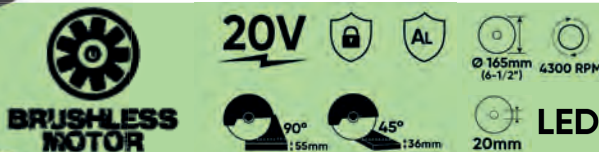

- Caractéristiques:  
Mécanisme de verrouillage  
Poignée souple.  
Boîtier supérieur et inférieur en aluminium.  
Rétro-éclairage LED intégré.

INTERRUPTEUR

14647 3,00€

ENGRENAGE

14650 5,00€

GUIDE PARALLÈLE

14955 7,50€

ROTOR

14649 50,00€

CIRCUIT IMPRIMÉ + STATOR

14651 86,00€

- Comprend:  
1 pièce: lame 24T TCT 165 mm.  
1 pièce: guide de bord.  
1 pièce: clé hexagonale.







## SCIE À TRONÇONNER AVEC MOTEUR BRUSHLESS

**60022 470,00€**

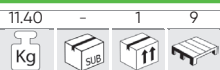

Batterie non incluse.

Cet outil est conçu pour **scier du bois et des matériaux similaires**. L'outil vous permet d'effectuer des coupes à onglet lorsqu'une coupe inclinée le long de la surface de la pièce à travailler est nécessaire, des coupes à un angle qui sont utilisées, en règle générale, pour les joints formant un angle de 90°, ainsi que des coupes combinées lorsqu'une coupe angulaire est nécessaire en même temps le long du bord et de la surface avant de la pièce à travailler.

La scie à tronçonner est munie d'un **sac à poussière**, d'un **pointeur laser**, d'une **clé** pour retirer/installer le disque coupant et d'un **étau pour serrer la pièce à travailler**. De plus, pour des raisons de sécurité, un **verrouillage du bouton de démarrage** est prévu pour éviter un démarrage accidentel de l'outil.

**BRUSHLESS MOTOR 30A**

20V LASER 3500 RPM

90° 90° 45° 90°  
205mm ; 50mm 152mm ; 50mm

90° 45° 45°  
205mm ; 38mm 205mm ; 152mm

Ø185mm 25.4mm

MOTEUR

**14691 167,00€**

INTERRUPTEUR

**14692 5,50€**

SAC À POUSSIÈRE

**14966 7,50€**



Pièces à fournir :  
Scie circulaire à 40 dents, 1 pièce  
Pince, 1 pièce  
Clé pour disque coupant, 1 pièce  
Sac à poussière, 1 pièce



### CONSUMMABLES POUR REF. 60022

page 112

Scie circulaire 40T 185mm

**14990 14987**



- Matériau: lames de coupe YG8, base en carbure de tungstène.



### Utilisez-les avec des batteries JBM: une seule batterie adaptée à tous les outils

#### BATTERIE LI-ION

2.0Ah



4.0Ah



6.0Ah



#### CHARGEURS

4A



HAUTE PERFORMANCE

6A



# OUTIL MULTIFONCTIONNEL OSCILLANT SANS FIL

**60041** 77,00€

1,60 - 4 216



Batterie non incluse.



LEVIER DE VERROUILLAGE

**15320** 1,00€

ROULEMENT À BILLES 625

**15321** 3,00€

RÉGULATEUR DE VITESSE

**15324** 18,00€

PANNEAU DE JONCTION

**15325** 3,50€

COUVERCLE INTERMÉDIAIRE

**15322** 3,50€

MOTEUR

**15323** 24,00€

JOINT

**15326** 1,00€

POIGNÉE AUXILIAIRE

**15327** 5,50€

Une variété d'ACCÉSSOIRES peut être utilisée avec l'outil oscillant multifonction pour s'adapter à une grande variété de tâches. L'outil est particulièrement utile pour le nettoyage, le ponçage et le sciage en profondeur dans des endroits difficiles d'accès.



**20V**  
BRUSHLESS MOTOR



## CONSOMMABLES

page 111

**53999**

**54000**

**54002**

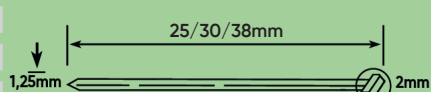

**54008**

**54010**

**54011**

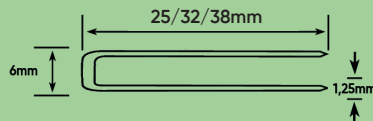

# CLOUEUSE / AGRAFEUSE ÉLECTRIQUE

**60037** 222,00€

3,60 - 4 128



Batterie non incluse.

**20V**

**2000Ah**

**MAX 100**  
grapas por minuto  
staples per minute

**60**  
grapas por minuto  
staples per minute

Capacidad máxima del cargador  
Max. magazine capacity  
**100**  
Clavos (grapas)  
Nails (staples)



L'outil est conçu pour **fixer** le carton, les matériaux isolants, le tissu, le papier d'aluminium, le cuir et **les matériaux similaires au bois ou à d'autres surfaces similaires** par un enfoncement à haute puissance avec de l'air comprimé.

L'outil est équipé d'un rétroéclairage LED pour indiquer l'état et améliorer la visibilité pendant le travail, d'une poignée de sélection de l'entraînement pour sélectionner entre les modes d'enfoncement simple et à goupille pour un travail plus précis ou plus rapide, et d'une molette de réglage de la profondeur pour sélectionner la profondeur souhaitée

d'enfoncement des clous/agrafes. De plus, l'outil est équipé d'un crochet pour courroie et d'une poignée rembourrée.

De plus, l'outil est équipé d'une **goupille de contact de sécurité**, qui doit être serrée contre la pièce à usiner avant que le déclencheur d'enfoncement des clous/agrafes ne soit appuyé en mode d'enfoncement simple, c'est-à-dire la goupille agit comme un mécanisme de sécurité pour empêcher le démarrage accidentel de l'outil.



Longueur des clous max	50 mm
clous sans capuchon taille 18	
Largeur maximale de la section transversale du clou	1,25 mm
Épaisseur maximale de la section transversale du clou	1,05 mm

Longueur des agrafes max.	40 mm
agrafes de type léger avec haut étroit taille 18	
Épaisseur maximale de la section de l'agrafe	1,2 mm
Largeur maximale de la section des agrafes	1 mm
Taille de la partie supérieure de l'agrafe max.	6 mm

ASSEMBLAGE D'IMPACT

**15276** 46,00€

COUVERCLE D'ÉTANCHÉITÉ ASSEMBLÉ

**15277** 9,00€

CADRE DE SÉCURITÉ

**15278** 3,50€

MOTEUR

**15279** 69,00€

COMMUTATEUR

**15280** 91,00€

Utilisez-les avec des batteries JBM: une seule batterie adaptée à tous les outils

BATTERIE LI-ION

2.0Ah



4.0Ah



6.0Ah



CHARGEURS

4A



HAUTE PERFORMANCE

6A



## SERINGUE DE GRAISSE ELECTRIQUE

**60038** 255,00€

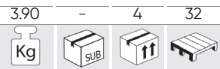

Batterie non incluse.

Cet outil est un **pistolet graisseur**. Grâce à l'alimentation par batterie, l'outil est facile à utiliser et à transporter.

L'outil est équipé d'un rétroéclairage LED pour une meilleure visibilité de la zone de travail, d'une soupape de sortie d'air de sécurité pour protéger contre la surpression et le colmatage, d'une poignée souple pour une utilisation facile et d'un bouton de verrouillage pour éviter toute mise en marche accidentelle. Le débit de graisse est réglé au moyen de la molette de réglage de la vitesse (**8 positions**).



<b>20V</b>	<b>9000PSI</b> 620BAR	Volumen / caudal Volume / flow rate <b>200g/min</b>	Capacidad de grasa en cartucho hasta Grease cartridge capacity up to <b>420g</b>	Capacidad de grasa a granel Bulk grease capacity <b>600g</b>	Tipo de grasa hasta Grease type up to <b>NLGI #2</b>	<b>8</b> Niveles de caudal Flow level
------------	--------------------------	---	--	--	--	---

POMPE	CIRCUIT IMPRIMÉ	GÂCHETTE MICRO	TUYAU FLEXIBLE
<b>15380</b> 169,00€	<b>15382</b> 42,00€	<b>15381</b> 5,50€	<b>15440</b> 33,00€

## PISTOLET DE GARNISSAGE DE JOINTS ELECTRIQUE

**60032** 123,00€

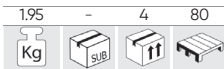

Batterie non incluse.

Cet outil est conçu pour **combler toutes les crevasses ou fissures dans une grande variété de matériaux** tels que le métal, le verre, le bois et la céramique. L'outil est équipé d'une **lampe de travail LED** qui facilite l'utilisation dans des conditions de mauvaise visibilité, ainsi que d'un **régulateur de fréquence** de rotation et d'un **système de verrouillage** du déclencheur. De plus, la conception prévoit un mécanisme de **protection contre les chutes**. Après avoir relâché le déclencheur pendant 0,2-0,3 s, la colle continue de couler pendant 0,8 s.



<b>20V</b>	<b>2500 Nm</b>	<b>LED</b>	<b>MECANISMO ANTIGOTEO</b> ANTI-DROP MECHANISM
<b>300ml</b>	<b>0,5-8mm/s</b>	VITESSE RÉGLABLE	

MOTEUR	CIRCUIT IMPRIMÉ
<b>15126</b> 19,50€	<b>15127</b> 29,00€

Utilisez-les avec des batteries JBM: une seule batterie adaptée à tous les outils

### BATTERIE LI-ION



### CHARGEURS



# PISTOLET DE GARNISSAGE DE JOINTS ELECTRIQUE

60042 106,00€

1.00 - 4 240



Batterie non incluse.

Cet outil est conçu pour **comblar toutes les crevasses ou fissures dans une grande variété de matériaux** tels que le métal, le verre, le bois et la céramique.

L'outil est équipé d'une **lampe de travail LED** qui facilite l'utilisation dans des conditions de mauvaise visibilité, ainsi que d'un **régulateur de fréquence** de rotation et d'un **système de verrouillage** du déclencheur. De plus, la conception prévoit un mécanisme de **protection contre les chutes**. Après avoir relâché le déclencheur pendant 0,2-0,3 s, la colle continue de couler pendant 0,8 s.



MOTEUR

15719 11,00€

ÉLÉMENT CHAUFFANT

15720 59,00€

CARTE DE CIRCUIT IMPRIMÉ

15721 46,00€

20V

15A

550°C

1022°F

Max. 200L/min.

0.6kg

Ø 34mm

PA6-GF30+TPE



# PULVÉRISATEUR DE PEINTURE SANS FIL

60043 123,00€

1.70 - 3 90



Cet outil est conçu pour pulvériser la peinture sur des surfaces intérieures et extérieures.

BUSE DE PULVÉRISATION

15722 4,25€

SOUPAPE

15723 2,21€

RONDELLE D'ÉTANCHEITÉ

15724 2,82€

JOINT TORIQUE

15725 1,86€

RONDELLE D'ÉTANCHEITÉ

15726 2,82€

RÉSERVOIR POUR PEINTURE

16150 7,90€

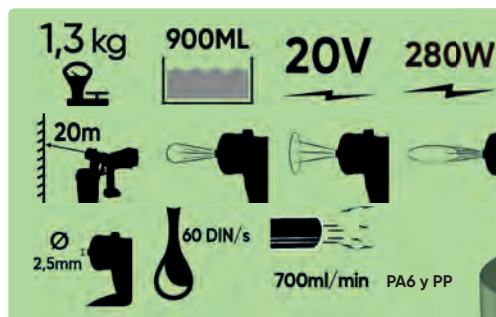

La buse peut être réglée sur l'un des trois modes de pulvérisation : circulaire, horizontal ou vertical.



Utilisez-les avec des batteries JBM: une seule batterie adaptée à tous les outils

BATTERIE LI-ION

2.0Ah



60012

4.0Ah



60013

6.0Ah



60015

CHARGEURS



4A 60016



HAUTE PERFORMANCE 6A 60017

## ASPIRATEUR PORTABLE

<b>60001</b>	<b>88,00€</b>
1.70	- 4 64

Batterie non incluse.

Cet aspirateur électrique **sans fil** est conçu pour nettoyer tous les matériaux qui ne sont pas dangereux pour la santé.

Une **batterie rechargeable** facilite le transport et les **ACCÈS-SOIRES** en option vous permettent d'effectuer le nettoyage de différents types dans différents endroits.



- Comprend:  
1 Suceur plat.  
1 Tube de rallonge.  
1 Tête de brosse.  
1 Buse de sol.



**20V**  
**3.8 kPa 500mL**

ÉLÉMENT FILTRANT	TUBE DE RALLONGE	BUSE DE SOL
<b>14628</b> 2,50€	<b>14950</b> 6,50€	<b>14952</b> 19,00€
INTERRUPTEUR	BUSE À FENTE	BROSSE
<b>14629</b> 4,00€	<b>14951</b> 9,50€	<b>14953</b> 8,50€
MOTEUR	FILTRE AVEC BOÎTIER POUR ASPIRATEUR PORTABLE	
<b>14630</b> 22,00€	<b>15765</b> 14,00€	



## POMPE ÉLECTRIQUE POUR POMPAGE DE ROUE

**60003** 110,00€

Batterie non incluse.

1.85	- 4 100

Grâce à cette pompe, vous pourrez gonfler des pneus d'automobile et de vélo, des ballons, des radeaux, des mate-las / piscines gonflables, etc.



- Le kit de l'appareil comprend:



MODULE DE POMPE	COMMUTATEUR DE MODE DE FONCTIONNEMENT
<b>14634</b> 36,50€	<b>14631</b> 3,50€
VENTILATEUR	INTERRUPTEUR DE FEU LED
<b>14635</b> 10,00€	<b>14632</b> 3,50€
	MANCHON HAUTE PRESSION
	<b>15151</b> 10,50€



Longueur du tuyau haute pression: **760 mm**  
Longueur du tuyau haute capacité: **460 mm**



Utilisez-les avec des batteries JBM: une seule batterie adaptée à tous les outils

BATTERIE LI-ION

2.0Ah



**60012**

4.0Ah



**60013**

6.0Ah



**60015**

CHARGEURS



**4A**

**60016**



HAUTE PERFORMANCE

**6A**

**60017**

DIVERSES



## FEU DE TRAVAIL LED

**60004** 79,00€

1,45 - 4 96



Batterie non incluse.

Ce feu de travail LED est conçu pour **créer l'éclairage** nécessaire dans la zone de travail et dans d'autres endroits. Il est alimenté par une batterie lithium-ion portable, ce qui rend l'appareil portable et **idéal pour tout lieu de travail et toute situation où l'accès au secteur est limité**. Lorsque la batterie est déchargée, le feu peut être connecté à un réseau 230 V à l'aide d'un **câble réseau** situé à l'arrière de l'appareil.

- Comprend: Câble.



1,5m



**20V 2400 LED LM**

INTERRUPTEUR

**14636** 30,00€

## TRÉPIED POUR FEU DE TRAVAIL LED (REF. 60004)

**15049** 37,40€

2,10 - 4 120



↑1200mm  
↓595mm



280mm

325mm

275mm

1200mm

RÉGLAGE À 360°



## LAMPE DE TRAVAIL PORTABLE LED

**60035** 30,00€

0,40 - 5 475



Batterie non incluse.

Cette lampe de travail LED est conçue pour fournir l'**éclairage nécessaire dans la zone de travail et d'autres lieux**. Elle est alimentée par une batterie lithium-ion portable, ce qui la rend portable et idéale pour tous les lieux de travail et les situations où l'alimentation secteur est limitée.

Le diffuseur de la lampe LED fournit un flux lumineux de **500 et 1000 lumens**, et le **mécanisme pivotant de la lampe (90°)** vous permet d'ajuster l'angle souhaité. De plus, le kit comprend une poignée souple pour une manipulation plus confortable et un crochet de suspension pour la fixation à un autre objet.



**20V 10W**

500 Lm

1000 Lm

90°

220-240V 50Hz

Parpadeante Flashing



CIRCUIT IMPRIMÉ

**15124** 9,50€

CIRCUIT IMPRIMÉ

**15125** 23,00€



Utilisez-les avec des batteries JBM: une seule batterie adaptée à tous les outils

BATTERIE LI-ION

2.0Ah



60012

4.0Ah



60013

6.0Ah



60015

CHARGEURS

4A



60016

HAUTE PERFORMANCE

6A



60017

# MACHINE À LAVER ÉLECTRIQUE SANS BROSSES

Le nettoyeur haute pression avec moteur BRUSHLESS est conçu pour nettoyer les véhicules, les équipements, les outils, les meubles de jardin, etc.

60039 265,00€

3.30 - 2 36  
Kg SUB

Batterie non incluse.



**BRUSHLESS MOTOR** 319-507 PSI 22-25 BAR **20V** 2.0-2.4L/min **2.0 kg**

Comprend une buse réglable qui permet de sélectionner le débit d'eau approprié en fonction de la saleté à éliminer et de la surface à nettoyer.

COUVERCLE VIS POUR SOUPAPE D'ALIMENTATION EN EAU

15481 4,50€

RACCORD DE CONDUITE D'ALIMENTATION EN EAU

15484 5,50€

JEU DE 6 SOUPAPES UNIDIRECTIONNELLES

15487 59,00€

AIGUILLE DE CLAPET ANTI-RETOUR POUR CONDUITE D'ENTRÉE ET DE SORTIE

15490 4,00€

ANNEAU SUPÉRIEUR DE RESSORT POUR SOUPAPE D'ALIMENTATION EN EAU

15482 4,00€

BAGUE D'ÉTANCHÉITÉ POUR INTERRUPTEUR

15485 4,00€

BAGUE D'ÉTANCHÉITÉ POUR CONDUITES D'ENTRÉE ET DE SORTIE

15488 4,00€

RESSORT DE SOUPAPE DE SURPRESSION

15491 4,00€

RESSORT DE SOUPAPE D'ALIMENTATION EN EAU

15483 4,00€

INTERRUPTEUR POUR PULVÉRISATEUR DE LAVAGE

15486 9,00€

CONDUITE D'ENTRÉE ET DE SORTIE

15489 10,50€

COUDE DE CONDUITE

15492 5,00€

RESSORT

15493 4,50€

# PULVÉRISATEUR ÉLECTRIQUE INDUSTRIEL À DOS AVEC RÉSERVOIR 15 L

60027 99,00€

5.65 - 1 15  
Kg SUB

Batterie non incluse. Compatible avec REF 60012 - 60013

L'outil convient à la désinfection des maisons privées, des lieux publics, des fermes d'élevage, des jardins, etc., et vous permet de détruire toutes les particules dangereuses, d'empêcher leur propagation et en même temps d'empêcher la reproduction des insectes et le développement de maladies. Poignée intelligente qui fournit un verrou pour un fonctionnement continu. De plus, la livraison comprend 4 buses avec un débit spécifique et des performances en fonction des exigences : 1 buse conique creuse, 1 buse conique creuse double, 1 buse réglable à 4 trous, 1 buse de ventilateur.

Couvercle de remplissage avec verrou.

Poignée pour un transport facile

Support pour installation du montant



Coussin RESPIRANT ET ERGONOMIQUE pour le dos permettant d'éviter la sensation de lourdeur après une utilisation prolongée et de faciliter la sudation et la répartition de la sueur.



Montant télescopique pour pulvérisation



**20V** **15L** 0.3-0.45 Mpa 1-1.2m 40 - 80cm



- Le kit de l'appareil comprend:



Utilisez-les avec des batteries JBM: une seule batterie adaptée à tous les outils

BATTERIE LI-ION

2.0Ah



60012

4.0Ah



60013

6.0Ah



60015

CHARGEURS



4A

60016



HAUTE PERFORMANCE

6A

60017

# TRONÇONNEUSE ÉLECTRIQUE AVEC MOTEUR BRUSHLESS

60029 240,00€



Batterie non incluse.

Cet outil forestier est conçu pour des tâches telles que l'abattage, l'ébranchage, le sciage et la coupe d'arbres. L'outil est équipé d'une poignée pour régler la tension du guide-chaîne et de la chaîne, d'un frein de chaîne pour arrêter la chaîne lors du recul et d'un attrape-chaîne pour l'attraper si elle se casse ou se détache. Il dispose également d'un système de lubrification automatique de la chaîne et d'un bouton de verrouillage du déclencheur pour éviter tout démarrage accidentel. L'outil se compose d'un guide-chaîne, d'une chaîne et d'une protection pour protéger à la fois le guide-chaîne et la chaîne pendant le transport et le stockage.

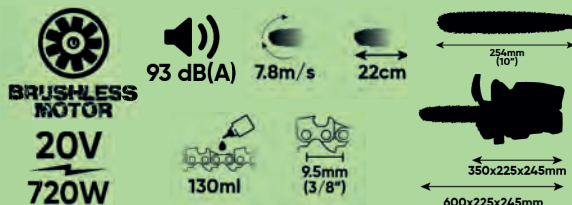

INTERRUPTEUR DE SIGNAL  
15098 11,50€

POMPE À HUILE  
15101 11,00€

CHAÎNE DE SCIE  
15104 31,50€

COMMUTATEUR À GÂCHETTE  
15099 5,50€

ROTOR ASSEMBLÉ  
15102 40,00€

BARRE DE GUIDAGE  
15105 30,00€

CIRCUIT IMPRIMÉ  
15100 70,00€

STATOR  
15103 20,50€

POIGNÉE EN D SUPPLÉMENTAIRE  
15106 15,00€

JEU DE LIMES POUR CHAÎNE DE TRONÇONNEUSE

54128 10,50€

# TAILLE-HAIE ÉLECTRIQUE

60031 142,00€



Batterie non incluse.

Cet outil est conçu pour une exécution rapide et commode des tâches de jardinage telles que la taille ou la coupe des haies vives ou des buissons. La conception légère et alimentée par batterie facilite le transport de l'outil d'un endroit à un autre.

Le kit de l'outil comprend un protège-lame pour maintenir la débroussailluse en bon état, une enveloppe de protection qui aide à éloigner les débris des mains et des yeux de l'opérateur, et une poignée auxiliaire pour un meilleur contrôle et un environnement de travail confortable. De plus, la conception fournit deux interrupteurs et un bouton de verrouillage qui empêche tout démarrage accidentel de l'outil.

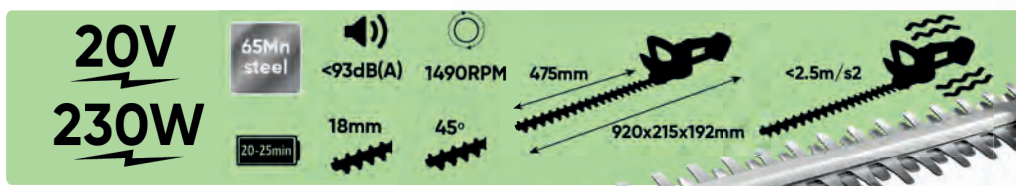

COMMUTATEUR À GÂCHETTE ARRIÈRE  
15114 6,00€

DISQUE COUPANT ASSEMBLÉ  
15118 52,00€

COMMUTATEUR MICRO #8  
15115 8,50€

COMMUTATEUR MICRO #31  
15119 10,00€

CIRCUIT IMPRIMÉ  
15116 29,50€

COMMUTATEUR À GÂCHETTE AVANT  
15120 6,50€

MOTEUR  
15117 29,50€

POIGNÉE EN D SUPPLÉMENTAIRE  
15121 12,00€



Utilisez-les avec des batteries JBM: une seule batterie adaptée à tous les outils

BATTERIE LI-ION

2.0Ah



60012

4.0Ah



60013

6.0Ah



60015

CHARGEURS



4A  
60016



HAUTE PERFORMANCE  
6A  
60017



# MACHINE DE JARDIN ÉLECTRIQUE MULTIFONCTIONNELLE

60040 440,00€

Batterie non incluse.

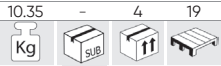

L'outil de jardin électrique multifonctionnel (4 en 1) est conçu pour une grande variété de tâches extérieures, telles que le débroussaillage des espaces verts, la taille des haies, la taille des branches etc. L'outil est idéal pour l'entretien complet du jardin.

- Comprend:



- L'ensemble complet comprend une scie, une cisaille à treillis et une débroussailluse avec une tête fileté et une lame à trois dents.



ROULEMENT

15462 7,50€

ENGRENAGE

15465 11,50€

GOUJON

15468 2,50€

GUIDE DE SCIE À TIGE

15471 20,10€

CHAÎNE DE SCIE À TIGE

15472 19,00€

TÊTE POUR TONDRE DE L'HERBE

15473 13,70€

ROTOR

15463 114,00€

ROULEMENT

15466 6,50€

ARBRE DE SORTIE

15469 9,50€

FIL DE DÉBROUSSAILLEUSE

15474 8,50€

LAME DE DÉBROUSSAILLEUSE À TROIS DENTS

15475 8,50€

COUVERCLE DE PROTECTION POUR DÉBROUSSAILLEUSE

15476 11,00€

ROULEMENT

15464 6,50€

ENGRENAGE

15467 14,00€

ROULEMENT

15470 7,50€

BASE DE COUVERCLE DE PROTECTION POUR DÉBROUSSAILLEUSE

15477 5,70€

LAME DE DÉBROUSSAILLEUSE

15478 3,60€



## SOUFFLEUR ÉLECTRIQUE

60030 112,00€



Batterie non incluse.

Cet outil est conçu pour ramasser les **feuilles, l'herbe, le papier et les matériaux similaires**. La conception légère et alimentée par batterie facilite le transport de l'outil d'un endroit à un autre.

La conception prévoit un commutateur de débit et de **volume d'air élevé/faible** et une **poignée souple** pour une utilisation facile.



COMMUTATEUR MICRO

15107 4,00€



CIRCUIT IMPRIMÉ

15109 25,50€



MOTEUR

15111 30,40€



FAIBLE

22m/s (49MPH)

312m³/h (186CFM)



HAUTE

38m/s (85MPH)

520m³/h (310CFM)

TUYAU DE PURGE

15113 11,80€

COMMUTATEUR À GÂCHETTE

15108 2,16€

COMMUTATEUR

15110 6,55€

CÔNE DE DÉRIVATION D'ENTRÉE

15112 3,25€

Utilisez-les avec des batteries JBM: une seule batterie adaptée à tous les outils

BATTERIE LI-ION

2.0Ah



60012

4.0Ah



60013

6.0Ah



60015

CHARGEURS

4A



60016

HAUTE PERFORMANCE

6A



60017

# ROBOT TONDEUSE

**52598** 1.080,00€

1700 - 1 12



- Robot tondeuse autonome.
- Sans fil et facile à ranger.
- Délimitation de l'espace de travail par fil périmétrique



<b>5200 mAh</b> Capacidad de la batería Battery capacity	<b>1400m<sup>2</sup></b> Superficie de corte Mowing area	<b>2,5H</b> 	<b>2H</b> 	<b>22m/min</b> 
<b>115,44W</b> Consumo de energía Power consumption	<b>AC 100-240V</b> 50/60Hz Tensión de entrada Input Voltage	<b>DC 15-25,5V</b> Tensión de salida Output Voltage	<b>IP X4</b>	<b>70 dB</b> 

Hauteur de coupe: 2,5 - 5,5cm    Largeur de coupe: 18cm    station de charge    Vitesse de rotation de la lame: 3500rpm



CONNEXION DE L'APPLICATION



- |   |  |
|---|--|
| <b>AGRAFES POUR FIL DE RACCORDEMENT 150 PCS</b><br>15425 50,00€ | <b>MOTEUR DE ROUE ARRIÈRE</b><br>15434 147,00€                 |
| <b>LAME DE COUPE ET VIS 3 PCS</b><br>15426 10,00€               | <b>PLAQUE DE COUPE ET PLAQUE DE PROTECTION</b><br>15435 24,50€ |
| <b>ROUES AVANT</b><br>15439 52,00€                              | <b>MOTEUR DE COUPE</b><br>15436 97,00€                         |
| <b>CLOUS POUR STATION D'ACCUEIL 4 PCS</b><br>15427 9,00€        | <b>CARTE MÈRE</b><br>15437 305,50€                             |
| <b>BATTERIE 22,2 V, 2 600 mA'h</b><br>15428 238,00€             | <b>CAPTEUR DE FIL DE RACCORDEMENT</b><br>15438 31,00€          |
| <b>STATION D'ACCUEIL</b><br>15431 241,00€                       | <b>RALLONGE 5 M</b><br>15429 23,50€                            |
| <b>CONNECTEUR DE FIL DE RACCORDEMENT</b><br>15432 18,50€        | <b>ADAPTEUR</b><br>15430 83,00€                                |
| <b>GARAGE POUR TONDEUSE</b><br>15433 197,00€                    | <b>FIL DE RACCORDEMENT 150 M</b><br>15424 105,00€              |

# TONDEUSE À GAZON SANS FIL

**60045** 298,00€

11.60 - 1 6



**40V**

**BRUSHLESS MOTOR**

**800W**

**370x45mm**

**3300 RPM**

**4000 mAh**  
Capacidad de la batería  
Battery capacity

**IP X1**  
**35L**

**96 dB(A)**

Hauteur de coupe: 6 (25-75mm)



- |   |   |  |
|---|---|--|
| <b>CÂBLE</b><br>16138 7,45€                                       | <b>SUPPORT DE LAME DE VENTILATEUR</b><br>16141 4,45€      | <b>PCB - n° 68-4 (REF.60045)</b><br>16145 79,00€                 |
| <b>BAC DE RAMASSAGE - n° 6 (REF.60045)</b><br>16139 14,20€        | <b>LAME DE 370 MM - n° 20 (REF.60045)</b><br>16142 10,80€ | <b>COMMUTATEUR MICRO - n° 68-10 (REF.60045)</b><br>16146 4,45€   |
| <b>ENSEMBLE DE STATORS - n° 32-13 (REF.60045)</b><br>16149 38,60€ | <b>VIS DE LAME - n° 21 (REF.60045)</b><br>16143 2,06€     | <b>GRANDE VITESSE - n° 32-5 (REF.60045)</b><br>16147 13,00€      |
| <b>ROUE ARRIÈRE - n° 13 / REF.60045</b><br>16140 14,20€           | <b>ROUE AVANT - n° 23 (REF.60045)</b><br>16144 12,80€     | <b>ENSEMBLE DE ROTORS - n° 32-11 (REF.60045)</b><br>16148 35,40€ |

**CLÉE DE SÉCURITÉ POUR REF 60045 #61**  
16160 3,99€



## PLATEAU

**14622** 17,00€

0,95 - 10 360



POUR REF. 60001, 60003,  
60004, 60020

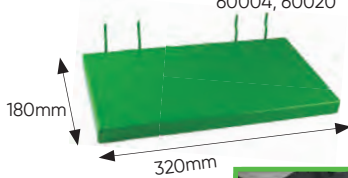

**14624** 17,00€

0,65 - 10 300



POUR REF. 60007,  
60010, 60011

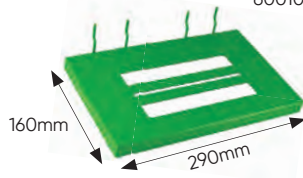

## CROCHET

**14625** 14,00€

0,50 - 10 700



POUR REF. 60008,  
60009

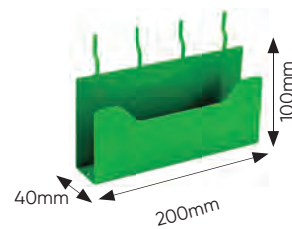

## CROCHET

**14623** 8,00€

0,10 - 10 800

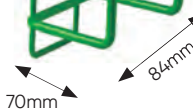

POUR REF. 60005, 60006, 60018

**14626** 7,00€

0,10 - 10 -

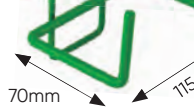

POUR REF. 60023

## SAC À DOS POUR OUTILS ÉLECTRIQUES

**53702** 28,50€

1,00 - 5 180



PETIT



**53703** 41,00€

1,40 - 5 120



MOYEN



**53704** 42,00€

1,65 - 5 120



GRAND



## SAC À DOS POUR OUTILS ÉLECTRIQUES – GRAND

**53782** 14,00€

0,65 - 20 160



25Kg/13L



BANDOLIÈRE



CLOISON INTÉRIEURE



POCHES ARRIÈRE ET LATÉRALES

## SAC À OUTIL

**53258** 67,00€

2,60 - 2 32



15Kg

- Il n'inclut pas d'outils.



## VALISE D'OUTILS

**53253** 98,00€

4,50 - 2 12



20Kg/18L

- 600D polyester.  
- Il n'inclut pas d'outils.



420mm 360mm 250mm



# Utilisez-les avec des batteries JBM: une seule batterie adaptée à tous les outils

Trois types de batterie et deux types de chargeur.  
Choisissez celui que vous préférez!

\*Batteries et chargeurs  
NON INCLUS  
dans les outils.



## BATTERIE LI-ION



INDICATEURS DE  
CHARGE LED



PROTECTION CONTRE  
LES COURTS-CIRCUITS



PROTECTION CONTRE  
LA SURCHAUFFE



PROTECTION CONTRE LA  
SURCHARGE DE LA BATTERIE

### 20V

### 12V

2.0Ah



4.0Ah



6.0Ah



2.0Ah



POUR REF. 60024

**60012** 48,00€

0.45 - 30 920



**60013** 80,00€

0.75 - 5 700



**60015** 138,00€

1.00 - 20 600



**60026** 37,90€

0.20 8 5 1400



## CHARGEURS

50-60Hz



**100V**  
**240V**



INDICATEURS DE  
CHARGE LED



PROTECTION CONTRE  
LA SURCHAUFFE



PROTECTION CONTRE LA  
SURCHARGE DE LA BATTERIE

### 20V



PROTECTION CONTRE  
LES COURTS-CIRCUITS

### 12V



4A

**60016** 49,00€

0.80 - 5 210



6A

**CHARGEUR  
RAPIDE**

**60017** 64,00€

0.80 - 5 290



**CHARGEUR 12 V  
POUR REF. 60026**

**60025** 31,60€

0.30 5 4 700



2.0AH 30min +/-10min  
4.0AH 60min +/-15min  
6.0AH 90min +/-15min

2.0AH 30min +/-10min  
4.0AH 45min +/-10min  
6.0AH 60min +/-15min

2.0AH  
60min +/-10min

## BURIN SDS-PLUS

- Matériau: acier 40Cr, sablage.



ACIER 40CR



60023

POUR LA MAÇONNERIE

EXTRÉMITÉ AIGÜË - 14x250mm

**14837** 3,30€

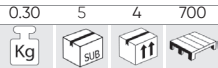

À EXTRÉMITÉ PLATE - 20x250mm

**14838** 3,40€



À RAINURER - 250mm

**14840** 3,35€

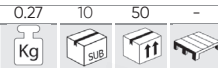

À EXTRÉMITÉ PLATE - 40x250mm

**14839** 4,70€

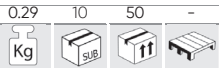

## KIT DE FORETS POUR PERCEUSE AVEC EMMANCHEMENT SDS-PLUS

**53850** 14,90€

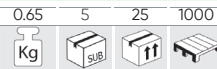

ACIER YG8

7 PCS

60023

5x110, 6x110, 6x160, 8x110, 8x160, 10x160, 12x160mm



POUR LA MAÇONNERIE

- Rainure simple, pointe plate, sablage.  
- Matériau: pointes en acier allié YG8, base en acier au carbone.



### RECHARGE DISPONIBLES

REF.	mm	Kg	SUB	IT	€
14826	Ø 5x110mm	0,05	125	500	1,50€
14828	Ø 6x110mm	0,05	25	500	1,50€
14830	Ø 8x110mm	0,04	25	500	1,50€
14829	Ø 6x160mm	0,04	25	500	1,50€
14831	Ø 8x160mm	0,05	25	500	1,50€
14832	Ø 10x160mm	0,05	25	200	2,00€
14920	Ø 12x160mm	0,10	100	200	2,50€

### TU POURRAIS AUSSI AIMER...

REF.	mm	Kg	SUB	IT	€
14825	Ø 4x110mm	0,05	100	200	1,50€
14827	Ø 5x160mm	0,04	25	500	2,00€
14833	Ø 10x210mm	0,10	20	200	2,05€
14834	Ø 12x210mm	0,10	100	200	2,50€
14835	Ø 14x210mm	0,10	20	125	3,00€
14836	Ø 16x210mm	0,14	20	120	3,50€

## ADAPTATEUR SDS-PLUS 1/2" POUR MANDRIN DE PERÇAGE

**14841** 2,58€



- Matériau: acier 40Cr, sablage  
- Longueur: 7,5 cm  
- Diamètre: 1 cm  
- Poids: 45 g



60023



POUR LA MAÇONNERIE

ACIER 40CR

## MANDRIN DE PERÇAGE À CHANGEMENT RAPIDE 2-13 MM 1/2"-20 UNF

**14842** 9,50€

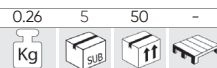

- Type: sans clé  
- Plage de serrage: 2 à 13 mm  
- Filetage: 1/2"-20UNF



60023

- Matériau: acier  
- Longueur: 6 cm  
- Diamètre: 4 cm

## KIT DE FORETS POUR BÉTON

3-10MM

**53861** 5,45€

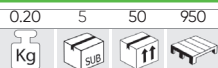

3x60, 4x75, 5x80, 6x100, 7x100, 8x120, 9x120, 10x120mm



**53861**



PIÈCES DE RECHARGE DISPONIBLES

4-10MM

**53860** 3,65€



4x75, 5x80, 6x100, 8x120, 10x120mm



**53860**



PIÈCES DE RECHARGE DISPONIBLES

5 PCS



ACIER YG8



POUR LA MAÇONNERIE

60006

### PIÈCES DE RECHARGE DISPONIBLES

REF.	mm	Kg	SUB	IT	€
14907	Ø 3x60mm	0,01	50	100	0,50€
14908	Ø 4x75mm	0,01	50	100	0,60€
14909	Ø 5x80mm	0,01	50	100	0,80€
14910	Ø 6x100mm	0,01	50	100	1,00€
14911	Ø 7x100mm	0,01	50	100	1,30€
14912	Ø 8x120mm	0,05	50	100	1,55€
14913	Ø 9x120mm	0,05	50	100	1,90€
14914	Ø 10x120mm	0,04	20	100	2,10€

### TU POURRAIS AUSSI AIMER...

REF.	mm	Kg	SUB	IT	€
14915	Ø 11x150mm	0,05	20	100	2,65€
14916	Ø 12x150mm	0,06	20	100	2,95€
14917	Ø 13x150mm	0,10	20	100	3,45€

## KIT DE FORETS HÉLICOÏDAUX HSS 4341

- Matériau: HSS 4341.

1-10MM

**53852** 207,00€

4,20 - 4 192



**170**  
PCS

1x34, 1,5x40, 2x49, 2,5x57, 3x61, 3,5x70, 4x75, 4,5x80, 5x86, 5,5x93, 6x93, 6,5x101, 7x109, 7,5x109, 8x117, 8,5x117, 9x125, 9,5x125, 10x133mm

- Le kit comprend 170 forets:  
1,0 à 8,0 mm x 10 pièces (tous les 0,5 mm),  
8,5 à 10 mm x 5 pièces (tous les 0,5 mm).

1-13MM

**53856** 62,00€

1,32 5 10 550



**25**  
PCS

1x34, 1,5x40, 2x49, 2,5x57, 3x61, 3,5x70, 4x75, 4,5x80, 5x86, 5,5x93, 6x93, 6,5x101, 7x109, 7,5x109, 8x117, 8,5x117, 9x125, 9,5x125, 10x133, 10,5x133, 11x142, 11,5x142, 12x151, 12,5x151, 13x151mm

1-10MM

**53854** 27,00€

0,63 5 20 192



**19**  
PCS

1x34, 1,5x40, 2x49, 2,5x57, 3x61, 3,5x70, 4x75, 4,5x80, 5x86, 5,5x93, 6x93, 6,5x101, 7x109, 7,5x109, 8x117, 8,5x117, 9x125, 9,5x125, 10x133mm



PIÈCES DE RECHANGE DISPONIBLES



PIÈCES DE RECHANGE DISPONIBLES



PIÈCES DE RECHANGE DISPONIBLES



HSS-G  
4341



POUR LES MÉ-  
TAUX

60006



PIÈCES DE RECHANGE DISPONIBLES

REF.	mm	Kg	11	192	€
14868	Ø 1x34mm	0,01	50	400	0,55€
14869	Ø 1,5x40mm	0,01	50	400	0,60€
14870	Ø 2x49mm	0,01	50	400	1,00€
14871	Ø 2,5x57mm	0,01	50	400	1,00€
14872	Ø 3x61mm	0,01	50	400	1,00€
14873	Ø 3,5x70mm	0,01	50	400	1,00€
14874	Ø 4x75mm	0,01	50	400	1,00€
14875	Ø 4,5x80mm	0,01	50	400	1,50€
14876	Ø 5x86mm	0,01	50	300	1,50€
14877	Ø 5,5x93mm	0,02	50	300	1,50€
14878	Ø 6x93mm	0,02	25	400	2,00€
14879	Ø 6,5x101mm	0,02	25	400	2,00€
14880	Ø 7x109mm	0,03	25	400	2,50€
14881	Ø 7,5x109mm	0,03	25	400	2,50€
14882	Ø 8x117mm	0,04	25	400	3,00€
14883	Ø 8,5x117mm	0,04	25	400	3,50€
14884	Ø 9x125mm	0,05	25	400	3,65€
14885	Ø 9,5x125mm	0,05	25	400	4,00€
14886	Ø 10x133mm	0,06	25	400	4,60€
14887	Ø 10,5x133mm	0,07	25	400	5,00€
14888	Ø 11x142mm	0,08	25	400	6,00€
14889	Ø 11,5x142mm	0,09	25	400	6,50€
14890	Ø 12x151mm	0,10	25	300	7,00€
14891	Ø 12,5x151mm	0,09	25	200	7,50€
14892	Ø 13x151mm	0,09	25	200	8,00€

## KIT DE FORETS HÉLICOÏDAUX HSS 4241 NOIR

- Matériau: HSS 4241 NOIR.

1-10MM

**53851** 88,00€

3,80 - 4 192



**170**  
PCS

1x34, 1,5x40, 2x49, 2,5x57, 3x61, 3,5x70, 4x75, 4,5x80, 5x86, 5,5x93, 6x93, 6,5x101, 7x109, 7,5x109, 8x117, 8,5x117, 9x125, 9,5x125, 10x133mm

- Le kit comprend 170 forets:  
1,0 à 8,0 mm x 10 pièces (tous les 0,5 mm)  
8,5 à 10 mm x 5 pièces (tous les 0,5 mm)



PIÈCES DE RECHANGE DISPONIBLES



PIÈCES DE RECHANGE DISPONIBLES



PIÈCES DE RECHANGE DISPONIBLES



HSS-R  
4241



POUR LES MÉ-  
TAUX

60006

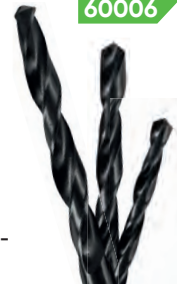

PIÈCES DE RECHANGE DISPONIBLES

REF.	mm	Kg	11	192	€
14843	Ø 1x34mm	0,01	50	400	0,50€
14844	Ø 1,5x40mm	0,01	50	400	0,50€
14845	Ø 2x49mm	0,01	50	400	0,50€
14846	Ø 2,5x57mm	0,01	50	400	0,50€
14847	Ø 3x61mm	0,01	50	400	0,50€
14848	Ø 3,5x70mm	0,01	50	400	0,50€
14849	Ø 4x75mm	0,01	50	400	1,00€
14850	Ø 4,5x80mm	0,01	50	400	1,00€
14851	Ø 5x86mm	0,01	50	300	1,00€
14852	Ø 5,5x93mm	0,02	50	300	1,00€
14853	Ø 6x93mm	0,02	25	400	1,00€
14854	Ø 6,5x101mm	0,02	25	400	1,00€
14855	Ø 7x109mm	0,03	25	400	1,00€
14856	Ø 7,5x109mm	0,03	25	400	1,00€
14857	Ø 8x117mm	0,03	25	400	1,50€
14858	Ø 8,5x117mm	0,04	25	400	1,50€
14859	Ø 9x125mm	0,04	25	400	1,50€
14860	Ø 9,5x125mm	0,05	25	400	2,00€
14861	Ø 10x133mm	0,06	25	400	2,00€
14862	Ø 10,5x133mm	0,07	25	400	2,00€
14863	Ø 11x142mm	0,07	25	400	2,50€
14864	Ø 11,5x142mm	0,07	25	400	2,50€
14865	Ø 12x151mm	0,08	25	300	2,50€
14866	Ø 12,5x151mm	0,09	25	200	3,00€
14867	Ø 13x151mm	0,09	25	200	3,00€

## KIT S2 D'EMBOUS À CHOC À CHANGE- MENT RAPIDE – REVÊTEMENT NOIR

53857 27,00€

0,40	6	24	1152
Kg	Sub	ff	ff

- Matériau: acier S2, revêtement oxydé noir de pointe, norme DIN.

- Comprend:

49 pièces d'embouts impact 25 mm:

PH1x3, PH2x3, PH3x3

PZ1x3, PZ2x3, PZ3x3

SL4x2, SL5x2, SL6x2

H: 3, 4, 5

T: 10x2, 15x2, 20x2, 25x2, 27x2, 30x2, 40x2

T TREMP: 10, 15, 20, 25, 27, 30, 40

7 embouts impact de 65 mm avec pointe: PH2, PH3, PZ1, PZ2, T20, T25, SL6

1 adaptateur de mandrin à changement rapide en acier inoxydable de 60 mm

60005/60006

ACIER S2 49 PCS



## KIT S2 D'EMBOUS À CHOC AVEC ADAPTATEURS – REVÊTEMENT NOIR

53858 28,80€

0,55	6	24	672
Kg	Sub	ff	ff

- Matériau: acier S2, revêtement oxydé noir de pointe.

- Comprend:

21 embouts impact de 25 mm:

PH: 1,2,2,3

PZ: 1, 2, 3

H: 3, 4, 5, 6

SL: 3,4,5,6

T: 10, 15, 20, 25, 30, 40

6 embouts impact de 75 mm: T15, T20, T25, PH2, PZ2, SL5

1 barre d'extension de 80 mm

1 adaptateur de mandrin à changement rapide de 60 mm

4 clés à écrous de 48 mm: 6, 7, 8, 10 mm

60005/60006

ACIER S2 33 PCS



PRÉSENTOIR DE 6 UNITÉS



PRÉSENTOIR DE 6 UNITÉS

## JEU DE CLOUS SANS TÊTE

		Kg	ff	€
53999	25x1.25mm	0,20	50	2,00€
54000	30x1.25mm	0,24	50	2,50€
54002	38x1.25mm	0,29	50	3,00€

60037

1000 PCS

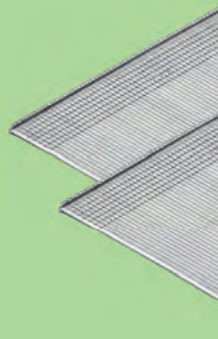
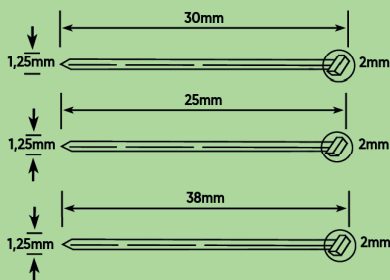

## JEU D'AGRAFES À COURONNE ÉTROITE

		Kg	ff	€
54008	25x6mm	0,43	40	3,50€
54010	32x6mm	0,47	40	4,50€
54011	38x6mm	0,63	40	5,00€

60037

1000 PCS

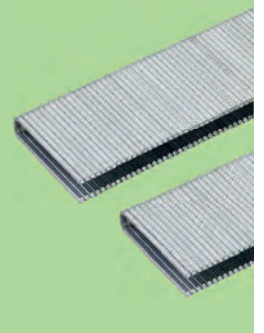
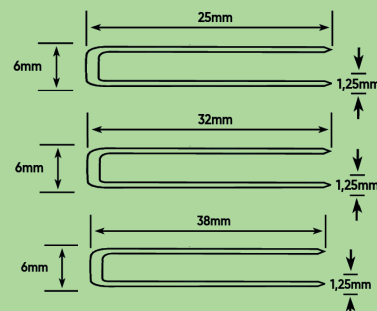

## KIT DE SCIES CLOCHES BIMÉTALLIQUES AVEC ADAPTATEURS

53859 67,00€

1,35	5	10	140
Kg	Sub	ff	ff

- Pour couper le métal et l'acier.  
- Matériau de la scie cloche: Dents: Bimétal HSS M42, 4-6TPI  
Corps: Acier au carbone  
- Matériau du mandrin: Bimétal HSS

CONTIENT

	x6	22, 29, 35, 44, 51, 68mm
	x2	14-30mm, 32-152mm



60006

HSS M42 4-6TPI 8 PCS



POUR LES MÉTAUX ET L'ACIER INOXYDABLE

### PIÈCES DE RECHANGE DISP.

REF.	mm	Kg	ff	ff	€
14901	Scie cloche 22mm	0,04	10	50	3,60€
14902	Scie cloche 29mm	0,08	10	50	4,65€
14903	Scie cloche 35mm	0,10	10	50	5,25€
14904	Scie cloche 44mm	0,12	10	50	6,85€
14905	Scie cloche 51mm	0,12	10	50	8,50€
14906	Scie cloche 68mm	0,19	10	50	10,20€
14934	Mandrin 14-30mm	0,07	10	50	4,25€
14935	Mandrin 32-152mm	0,2	10	50	8,45€



À MÉTAL (ACIER INOXYDABLE, ALUMINIUM, CUIVRE)

POUR	REF.	DESCRIPTION	Kg	Paq	Boîte	€
60011	14989	Scie circulaire 24T 115mm	0,08	-	20 100	6,00€
60007	14988	Scie circulaire 24T 165mm	0,19	-	20 40	8,00€
60022	14990	Scie circulaire 40T 185mm	0,26	-	20 40	10,50€
60019	14995	Lames pour scie sabre 150mm 24TPI	0,01	2	20 200	8,00€
60010	14993	Lames pour scie d'horloger T118A	0,01	5	20 200	5,00€

À BOIS

POUR	REF.	DESCRIPTION	Kg	Paq	Boîte	€
60011	14986	Scie circulaire 24T 115mm	0,07	-	20 100	4,00€
60007	14985	Scie circulaire 24T 165mm	0,18	-	20 40	6,00€
60022	14987	Scie circulaire 40T 185mm	0,24	-	20 40	8,50€
60019	14994	Lames pour scie sabre 150mm 6TPI	0,01	2	20 200	3,50€
60010	14991	Lames pour scie d'horloger T244D	0,01	5	20 200	2,00

**14989 14986**

MÉTAL BOIS

Ø 115mm 10mm

x24 7.000 RPM



- Matériau: lames de coupe YG8, base en carbure de tungstène.

**14988 14985**

MÉTAL BOIS

Ø 165mm 20mm

x24 7.000 RPM



- Matériau: lames de coupe YG8, base en carbure de tungstène.

**14990 14987**

MÉTAL BOIS

Ø 185mm 25.4mm

1.3mm x40 7.000 RPM



- Matériau: lames de coupe YG8, base en carbure de tungstène.

**14995**

MÉTAL

150mm 24 TPI 10mm CORTE MÁX. MAX. CUT



- Matériau: acier rapide.

**14993**

MÉTAL

76mm 8mm CORTE MÁX. MAX. CUT T118A



- Matériau: acier rapide.

**14994**

BOIS

150mm 6 TPI 150mm CORTE MÁX. MAX. CUT



- Matériau: acier à haute teneur en carbone.

**14991**

BOIS

100mm 100mm CORTE MÁX. MAX. CUT T244D



- Matériau: acier à haute teneur en carbone.

CERCLE DE COUPE

- Matériau: Alumine fondue monocristalline SA 50% / Alumine fondue blanche 50%

POUR LES MÉTAUX ET L'ACIER INOXYDABLE

60008/60028

À MÉTAL

REF.	DESCRIPTION	Kg	Paq	Boîte	€
14893	T42 - 115x2.5mm	0,05	50	100	2,00€
14894	T42 - 125x2.5mm	0,70	50	100	1,20€
14895	T27 - 115x6mm	0,15	25	100	1,90€
14896	T27 - 125x6mm	0,78	25	100	2,10€



ACIER INOXYDABLE

REF.	DESCRIPTION	Kg	Paq	Boîte	€
14897	T41 - 115x1mm	0,01	50	400	0,88€
14898	T41 - 125x1mm	0,03	50	400	0,98€
14899	T41 - 115x1.6mm	0,03	50	400	0,88€
14900	T41 - 125x1.6mm	0,04	50	400	0,98€



**14893 T42**

Ø 115mm 22.23mm 2.5mm 13.300 RPM 80 m/s

**14895 T27**

Ø 115mm 22.23mm 6mm 13.300 RPM 80 m/s

**14897 T41**

Ø 115mm 22.23mm 1mm 13.300 RPM 80 m/s

**14898 T41**

Ø 125mm 22.23mm 1mm 12.200 RPM 80 m/s

**14894 T42**

Ø 125mm 22.23mm 2.5mm 12.200 RPM 80 m/s

**14896 T27**

Ø 125mm 22.23mm 6mm 12.200 RPM 80 m/s

**14899 T421**

Ø 115mm 22.23mm 1.6mm 13.300 RPM 80 m/s

**14900 T41**

Ø 125mm 22.23mm 1.6mm 12.200 RPM 80 m/s

ÉCROU DE VERROUILLAGE RAPIDE M14 POUR MEULEUSE D'ANGLE

**15014 20,00€**

0,10	50	100	-
Kg	Sub	Boîte	Paq



60008/60028







# ÉCLAIRAGE

- 114 BALADEUSES D'ATELIER
- 118 BALADEUSES DE LUMIÈRE FRONTALE
- 119 LOUPES LED / LANTERNES
- 120 PROJECTEURS LED / ALLIGNEURS DE PHARES  
/ ALLUME-CIGARE ET TRANSFORMATEURS
- 121 BARRES LED
- 122 LAMPE LED INDUSTRIELLE
- 122 GYROPHARES
- 125 AVISEUR ACOUSTIQUE
- 126 PHARES DE TRAVAIL
- 127 POUR REMORQUE
- 129 AMPOULES VOITURE

## LAMPE DE TRAVAIL 400LM

53734 23,70€

0.25 20 60 1260



BASE ROTATIVE 360° MAGNÉTISÉE



380mm

32mm



lumière LED puissante: de 30Lm à 400Lm



SÉLECTEUR D'INTENSITÉ LUMINEUSE



AVEC CROCHET



CHARGEUR USB



PRÉSENTOIR DE 20 UNITÉS

## LAMPE DE TRAVAIL PORTATIVE ULTRA COMPACTE

53519 42,00€

0.20 12 72 720



PRÉSENTOIR DE 12 UNITÉS

ULTRA COMPACTE



300mm

12mm

38mm

52536 57,00€

0.40 - 10 320



360mm

50mm



# BALADEUSE ATELIER AVEC BASE AIMANTÉE ARTICULÉE

**54122** 38,00€

0,39	12	24	384
Kg	Sub	ff	ff

6500±400 KELVIN

100V 240V USB 5V 1A

3.7V 20Ah

IP 44

LED 3W COB 2,5H

LED 3W 7H

300 Lm

3-4H

COMPREND

257mm 50mm 26mm

**54123** 40,00€

0,39	12	24	384
Kg	Sub	ff	ff

6500±400 KELVIN

100V 240V USB 5V 1A

3.7V 40Ah

IP 44

LED 5W COB 3H

LED 3W 14H

500 Lm

6-7H

COMPREND

**54124** 47,00€

0,39	12	24	432
Kg	Sub	ff	ff

6500±400 KELVIN

100V 240V USB 5V 1A

3.7V 40Ah

IP 44

LM1000 900 700

5 min 30 min 145 min

LED 10W COB 3H

LED 3W 14H

1000 Lm

6-8H

COMPREND



PRÉSENTOIR DE 12 UNITÉS

ADAPTATEUR RÉSEAU USB

**14031** 7,90€

0,10	10	100	1152
Kg	Sub	ff	ff



## BALADEUSE ATELIER RECHARGEABLE 24+6 LEDS DOUBLE AIMANTS ARRIÈRE

**51889** 49,00€

0,43	-	10	360
Kg	Sub	ff	ff

255mm 56mm

60 Lm

x24+6 LED

LITIO 3.7V 1400MAH

3-4H

4-5H

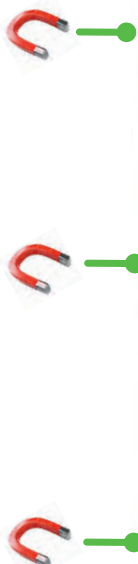

DOUBLE CROCHET ET DOUBLE AIMANT



6 LED SUPERIEUR  
70H AUTONOMIE



## BALADEUSE LED COB AVEC BASE FLEXIBLE

**53216** 49,00€

0,60	-	10	120
Kg	Sub	ff	ff

200 Lm

LED 2W COB

3.7V 2.000MAH

4H

5V 1.000MA

3-4H



390mm

100mm 180mm



## TORCHE DE POCHE AVEC BATTERIE

**53776** 19,10€

0,15 12 48 1920



### 3 MODES D'ÉCLAIRAGE

90-250 Lm	2,5H
3,5-6H	3.7V 1.5Ah
ABS	



PRÉSENTOIR DE 12 UNITÉS



## TORCHE DE POCHE AVEC BATTERIE

**52987** 20,00€

0,17 10 40 720



PRÉSENTOIR DE 10 UNITÉS

120 Lm	LED 3W COB	3.7V 1000MAH
2,5H	2,5H	



## BALADEUSE LED COB AVEC BASE FLEXIBLE

**52883** 38,00€

0,31 - 20 640



180+80 Lm	LED 2W COB	3.7V 1.800MAH
4-5H	3,5-4H	



## LAMPE PORTATIVE À DIODES LED UV COB AVEC BASE MAGNÉTIQUE

**53530** 46,00€

0,35 - 20 620



5V 1A	LED 2W COB
3.7V 2.2Ah	4H
4H	4H



## BALADEUSE LED COB

**53217** 47,00€

0,30 - 20 620



200 Lm	LED 2W COB	3.7V 2600MAH
4H	5V 1.000MA	4H
4H		

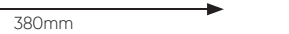

# LAMPE DE TRAVAIL RECHARGEABLE

53974

38,00€

0.75 5 20 240



Instructions sur les vitesses rotatifs

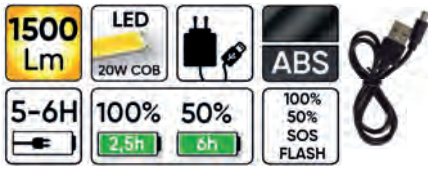

4 MODES D'ÉCLAIRAGE  
100% 50% SOS FLASH



MULTIPOSITION



# FEU DE TRAVAIL LED 400LM

53780

14,50€

0.45 5 20 280



CÂBLE D'ALIMENTATION DE 2,5M



COMPREND UN CROCHET SUPÉRIEUR POUR TRAVAILLER CONFORTABLEMENT



LUMIÈRE PUISSANTE PARFAITE POUR ÉCLAIRER LA ZONE DE TRAVAIL

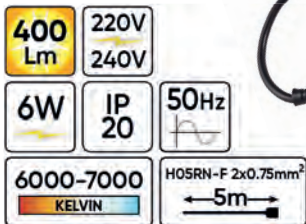

# BALADEUSE EXTRA PLATE LED COB

52384

29,00€

0.33 - 20 600



- Longueur du CÂBLE : 5m
- Longueur du CÂBLE DC : 0,1m
- Longueur de CÂBLE DC jusqu'à pinces : 0,3m

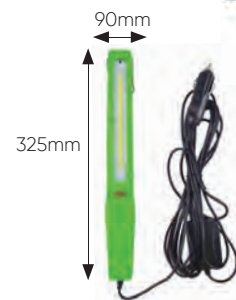
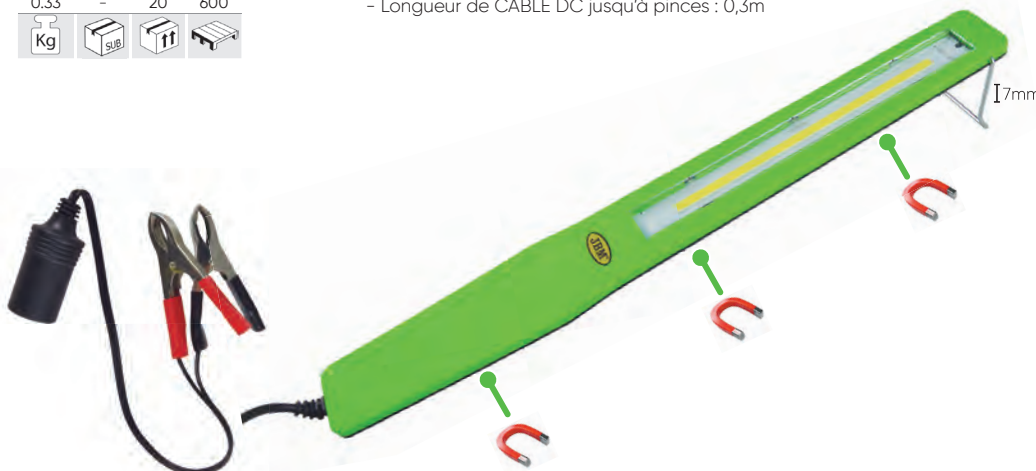

TVA non comprise

BALADEUSES

# PORTATIF À LUMIÈRE FRONTALE DE TÊTE COB

54004 23,00€

0.10	12	96	2592
Kg	Sub	ff	

COB + LED 350LM

<b>COB</b> 350Lm 5W COB	<b>LED</b> 90Lm 3W XPE
3.5V 1200Ah	2.5H
IP X4	2m
Gel de silice Silica gel	70g



350Lm 150Lm **1 COB**

150Lm 60Lm **2 XPE LED**

**3 COB FLASH**

ON +



- Matériau: gel de silice
- Indicateur de puissance, indicateur d'induction
- Mode d'activation du capteur de mouvement
- Câble de chargement USB inclus

BOUTON DE CAPTEUR DE MOUVEMENT

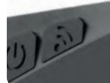

Appuyez pour activer/désactiver.  
Passez votre main devant le bouton pour allumer et éteindre la lumière.

# GANT LUMINEUX À LAMPES LED

54267 9,50€

0.05	10	60	2640
Kg	Sub	ff	



<b>LED</b>	x2 CR2016 Incluses Incluidas	Derecha Right
+20H	120mAh	x2 LED 70Lm



# PORTATIF À LUMIÈRE FRONTALE DE TÊTE 800 LM (COB + CREE)

53569 18,00€

0.30	10	50	400
Kg	Sub	ff	

CREE + COB 800LM



<b>MAX 800 Lm</b>	High/Low Flash/COB	x2 18650
<b>LED COB + CREE</b>	150M	+2,5H

BATTERIES RECHARGEABLES

RÉGULATEUR DE MISE AU POINT



INDICATEUR DE LUMIÈRE ALLUMÉE



**3 MODES D'ÉCLAIRAGE**

90°

# PORTATIF À LUMIÈRE FRONTALE DE TÊTE 350 LM

53568 12,00€

0.20	10	100	400
Kg	Sub	ff	

High/Low Flash/SOS	2000 mAh LI-ION	<b>MAX 350 Lm</b>
150M	+2,5H	

RÉGULATEUR DE MISE AU POINT



**3 MODES D'ÉCLAIRAGE**

90°

## LOUPE LED DE TABLE

**53227** 28,00€

0,60	6	24	192

-Jusqu'à 500 cycles de charge.  
-LED de lumière blanche, grande économie.  
-Longue durée et grande luminosité.



## LED LOUPE (5x)

**53085** 30,00€

0,31	10	40	1500



## LAMPE TORCHE 9 LEDS

**52555** 2,38€

0,03	48	192	3456

**52558** 2,38€

0,03	48	192	3072

30mm
93mm



## TORCHE STYLO AIMANTEE 8 LEDS

**53427** 5,00€

0,05	12	96	3456

160mm	32mm
-------	------



## LAMPE TORCHE 21 LEDS

**51326** 4,40€

0,07	12	144	2880



PRÉSENTOIR DE 12 UNITÉS

## LAMPE DYNAMO 2 LEDS

**51573** 2,50€

0,07	12	96	3456

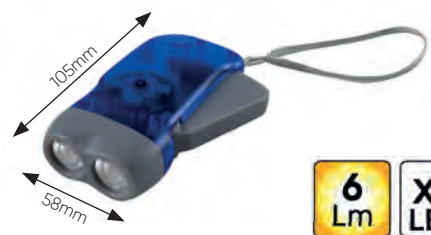

## PILES DE RECHARGE

"AAA" R03 1,5V

**51258** 0,15€

0,01	60	2400	134400



POUR REF. 51325, 51326, 51829, 52233, 51001, 52582, 52555, 52556, 52557, 52558, 52584

PILE CARRÉE 9V

**10923** 1,10€

0,05	10	500	-



POUR REF. 52162, 52450, 51929, 50942

## LANTERNE LED DE 50W

**53505** 77,00€

2.50 - 8 %  
Kg SUB if

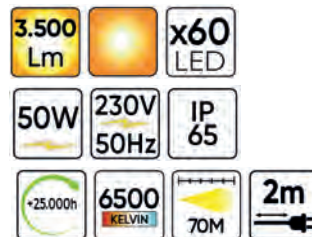

## TRÉPIED POUR LA LANTERNE LED REF. 53505

**53506** 36,00€

2.40 - 8 %  
Kg SUB if



**52254** 64,00€

3.51 - 4 24  
Kg SUB if



- Lampe non incluse.

↑ 2.770mm  
↓ 1.290mm



## REGLOPHARE AVEC LUXMÈTRE

**52740** 690,00€

24.00 - 1 11  
Kg SUB if

HALOGÈNE / XENON / LED

- Distance de mesure: 50cm.
- Facile mesure de la déviation de l'axe optique des feux.
- Aussi pour les camions.



## REGLOPHARE AVEC LUXMÈTRE DOUBLE VISÉE LASER

**52836** 1.100,00€

24.85 - 1 10  
Kg SUB if

- Aussi pour les camions.

HALOGÈNE / XENON / LED

ÉCRAN DE VÉRIFICATION

LUXMÈTRE DIGITAL



DOUBLE LASER

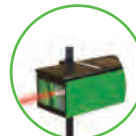

↑ 270mm  
← 520mm  
↑ 1560mm



## CHARGEUR ALLUME-CIGARE ET TRANSFORMATEUR

REF.	DESCRIPTION	POUR	Kg	Sub	if	
11107	CHARGEUR ALLUME-CIGARE ENTRÉE: 100-240V SORTIE: 6V 500mA	54122, 54123, 54124, 51889, 52883, 53568	0,06	1	250	4,50€
10961	CHARGEUR DE BALADEUSE ENTRÉE: 100-240V SORTIE: 6V 500mA	54122, 54123, 54124, 51889, 52883, 53568, 53569	0,08	-	150	13,00€
11989	CHARGEUR ALLUME-CIGARE ENTRÉE: 100-240V SORTIE: 9V 500mA	52536	0,04	-	200	2,00€
11093	CHARGEUR ALLUME-CIGARE ENTRÉE: 230V SORTIE: 6V 500mA	52002	0,06	-	250	4,00€
14031	ADAPTATEUR RÉSEAU USB ENTRÉE: 100-240V SORTIE: 5V 1000mA	54122, 54123, 54124, 53216, 53217, 53519, 52987, 52883, 53530, 53451, 53570, 53707, 53439, 53568, 53569	0,1	10	100	7,90€
13839	ADAPTATEUR DE PRISE DE COURANT USB 110V/60HZ	54122, 54123, 54124, 54216, 53217, 53519, 52987, 52883, 53530, 53451, 53570, 53707, 53439, 53568, 53569	0,04	-	200	8,50€
14032	ADAPTATEUR USB POUR ALLUME-CIGARES ENTRÉE: 12-24V SORTIE: 5V 1A/2,1A	53465, 53466, 53467, 53216, 53217, 53519, 52987, 52883, 53530, 53451, 53570, 53707, 53439, 53568, 53569	0,1	10	100	12,00€
14033	CÂBLE USB LONGUEUR: 80CM	53216, 53217, 53519, 52987, 53530, 53451, 53570, 53707, 53499	0,1	10	100	4,50€
16052	CÂBLE USB TYPE A / FICHE RONDE 3.5MM	54172, 54173	0,1	10	100	2,09€
16053	CÂBLE USB TYPE A / FICHE RONDE 5.5MM	54173	0,1	10	100	2,85€





## LAMPE LED AVEC SUPPORT MAGNÉTIQUE

54270 42,00€

0.17	5	20	-
Kg	Sub	11	11

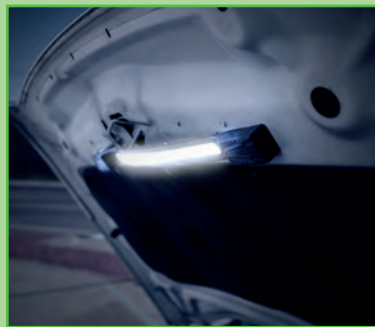
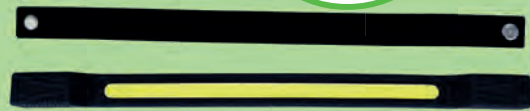

1000 Lm	3.7V 1200mAh	Magnetic Mount
3-4H	2-5H	USB TYPE-C
LED 1000lm 2H	LED 400lm 5H	

## BARRE LED MAGNÉTIQUE AVEC SANGLE DE CAPOT

54271 54,00€

0.33	5	20	-
Kg	Sub	11	11



1000 Lm	3.7V 1200mAh	Magnetic Mount	3-4H	LED 1000lm 2H	LED 400lm 5H
			2-5H	USB TYPE-C	

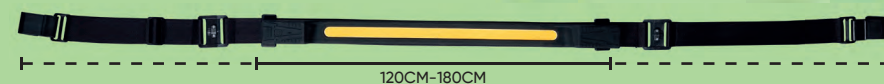

## LAMPE LED AVEC SUPPORT MAGNÉTIQUE POUR ESTACADES

53707 153,00€

2.25	-	4	80
Kg	Sub	11	11

3.7V 2600mAh	7-8H
+6H	Magnetic Mount
ABS	

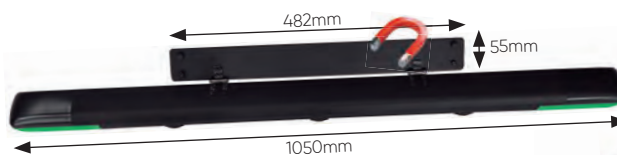

**MULTIFONCTION**  
AVEC SUPPORT MAGNÉTIQUE POUR S'ADAPTER À TOUTES LES SITUATIONS

**3 MODES D'ÉCLAIRAGE**

350Lm	1 LED
700Lm	2 LEDs
1000Lm	3 LEDs

PERMET DE DIRIGER L'AMPOULE INDIVIDUELLEMENT SI NÉCESSAIRE



LUMIÈRES QUI INDICENT L'ÉTAT DE LA BATTERIE



BATTERIE RECHARGEABLE



AUGMENTER CONSIDÉRABLEMENT LA VISIBILITÉ DANS LA ZONE DE TRAVAIL.



## LAMPE D'INSPECTION SOUS CAPOT AVEC BRAS EXTENSIBLES

53570 154,00€

2.70	-	4	48
Kg	Sub	11	11

3.7V 2600mAh	7-8H
+6H	Magnetic Mount



BRAS EXTENSIBLES DE 117CM À 175CM



PERMET DE DIRIGER L'AMPOULE INDIVIDUELLEMENT SI NÉCESSAIRE

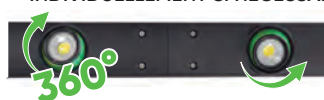

LUMIÈRES QUI INDICENT L'ÉTAT DE LA BATTERIE



BATTERIE RECHARGEABLE



**3 MODES D'ÉCLAIRAGE**

400LM	1 LED
800LM	2 LEDs
1200LM	3 LEDs

AUGMENTER CONSIDÉRABLEMENT LA VISIBILITÉ DANS LA ZONE DE TRAVAIL



## LAMPE LED INDUSTRIELLE

**54039** 154,00€

Ø :50cm x 38cm

2,60	-	1	14

Conçu spécifiquement pour l'éclairage de locaux industriels, d'ateliers et de pièces hautes.

- Faible poids
- Puissance : 200 W
- Flux lumineux : 20 000 lm
- Diamètre : 50 x 38 cm
- Degré de protection : IP20

- LED : MTC
- Driver : Meanwell
- Température de couleur : 6 500 K
- Fréquence : 50/60 Hz



**20.000Lm**

<b>200W</b>	50-60Hz	<b>220V</b>
-------------	---------	-------------

ABAT-JOUR DE RECHANGE

**15385** 50  
**18,00€**



## JEU DE 6 LAMPES À LED INDUSTRIELLES

**54133** 547,00€

12,10	-	6	6



<b>6 PCS</b>	<b>220V</b>
<b>200W</b>	50-60Hz

**20.000Lm**

## LAMPE LED INDUSTRIELLE

**54088** 132,00€

Ø :29,9cm x 14,7cm

2,50	-	1	63

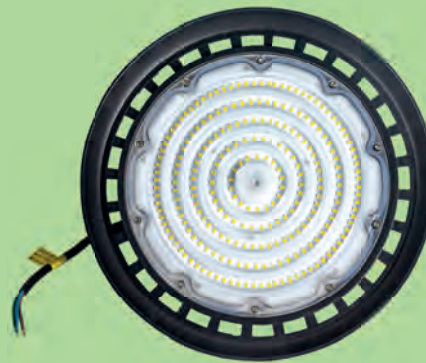

Ra>80	AI	3000K 4000K 5000K
IP 65	60°C 90°C 120°C	<b>18.000 Lm</b>
	100V 277V	<b>150W</b>

## GYROPHARE LED MAGNÉTIQUE

**53691** 36,00€

0,70	-	20	320

- Fonctions:  
Fonction 1: CLIGNOTANT  
Fonction 2: DOUBLE CLIGNOTANT  
Fonction 3: ROTATION



12V 24V	<b>19W</b>	4m
100mm	139mm	
<b>x36 LED</b>	PC	-30°C 50°C

ECE R65 ECE R10

## GYROPHARE LED 12-24V BASE FLEXIBLE

**53690** 34,00€

0,55	-	20	200

- Fonctions:  
Fonction 1: CLIGNOTANT  
Fonction 2: DOUBLE CLIGNOTANT  
Fonction 3: ROTATION



12V 24V	<b>19W</b>	<b>x36 LED</b>	PC
193mm	125mm	-30°C 50°C	



ECE R10  
ECE R65

## SIGNAL LED RECHARGEABLE 9 À 30 V BASE MAGNÉTIQUE

54173 87,00€

0.75	5	20	240
Kg	Sub	ff	ff

- Fonctions:  
Fonction 1: CLIGNOTANT  
Fonction 2: DOUBLE CLIGNOTANT  
Fonction 3: ROTATION
- CÂBLE USB TYPE A / FICHE RONDE 5.5MM



16053 2,85€



Alimentado a batería recargable  
Rechargeable battery powered.

Homologué ECE R10 / R65

ECE R65		9V	x45	3-4H	5-6H	7.4V	2.2Ah
		30V	LED	↔	↔		
PC	ABS	125mm	30°C 50°C	IP 65			

## SIGNAL LED RECHARGEABLE 9 À 30 V BASE FLEXIBLE

54172 81,00€

0.80	5	20	240
Kg	Sub	ff	ff

- Fonctions:  
Fonction 1: CLIGNOTANT  
Fonction 2: DOUBLE CLIGNOTANT  
Fonction 3: ROTATION
- CÂBLE USB TYPE A / FICHE RONDE 3.5MM



16052 2,09€



Alimentado a batería recargable  
Rechargeable battery powered.

Homologué ECE R10 / R65

ECE R65		9V	x45	3-4H	5-6H	7.4V	2.2Ah
		30V	LED	↔	↔		
PC	ABS	125mm	30°C 50°C	IP 65			

## GYROPHARE LED BASE FLEXIBLE

52456 36,00€

0.60	-	20	160
Kg	Sub	ff	ff

- Lentille PC.
- Tulipe anti-rupture.
- Consommation: 8W.

- Fonctions:  
Fonction 1: ROTATION  
Fonction 2: DOUBLE ÉCLAIR  
Fonction 3: 6 ÉCLATS



LED 6 EN 1

ABS - BAES

Ø 24mm

ECE R10

12-24V	240mm
IP 65	128mm
CE	

## GYROPHARE SCINTILLANT DE LED

52375 38,00€

0.70	-	20	240
Kg	Sub	ff	ff

- Lentille ABS-BAES.
- Tulipe anti-rupture.
- CÂBLE: Spiral de 2,5m avec prise allume-cigare.
- Consommation: 9W.

- Fonctions:  
Fonction 1: ROTATION  
Fonction 2: DOUBLE ÉCLAIR  
Fonction 3: 6 ÉCLATS



LED 6 EN 1

ECE R10

12-24V	170mm
Ø 140mm	
CE	

## GYROPHARE BASE FLEXIBLE

51964 28,00€

0.65	-	20	160
Kg	Sub	ff	ff

12V  
55W

51965 29,50€

0.68	-	20	160
Kg	Sub	ff	ff

24V  
70W

ECE R10  
ECE R65  
PC

- Lentille PC.
- Tulipes anti-rupture.
- Bord Lentille avec scellage durable.
- T/min: 40.
- Système de pignon/vis sans fin.
- Ampoule:  
H1, 12V 55W  
H1, 24V 70W
- Avec base filetée.
- Consommation de courant: 3.0 A.



BASE FLEXIBLE

ABS - BAES

Ø 128mm
240mm

## GYROPHARE SANS CÂBLE

51962 25,00€

0.57	-	20	240
Kg	Sub	ff	ff

12V  
55W

51963 29,00€

0.55	-	20	240
Kg	Sub	ff	ff

24V  
70W

ECE R10  
ECE R65

- Lentille ABS-BAES.
- Tulipes anti-rupture.
- Bord Lentille avec scellage durable.
- T/min: 40.
- Système de pignon/vis sans fin.
- Ampoule:  
H1, 12V 55W  
H1, 24V 70W
- Consommation de courant: 3.0 A.



Ø 140mm
155mm

## GYROPHARE AVEC CÂBLE BASE AIMANTÉ

**51960** 34,00€

0.75 - 20 240



**12V**  
**55W**



170mm  
Ø 140mm

**51961** 34,00€

0.78 - 20 240



**24V**  
**70W**



ECE R10  
ECE R65 CE

- Lentilles ABS - BAES.
- Tulipes anti-rupture.
- Bord Lentille avec scellage durable.
- T/min: 40.
- Système de pignon/vis sans fin.
- Ampoule: H1, 12V 55W  
H1, 24V 70W
- CÂBLE: Spiral de 3m +prise allume-cigare.
- Consommation de courant: 3.0 A.

## PHARE SCINTILLANT

**51966** 18,00€

0.31 - 50 800



**12V**  
**110V**

131mm  
Ø 99mm  
Ø 61mm

- Lentille ABS - BAES.
- XÉNON.
- Consommation de courant: 3.0 A.

BASE EN  
TULIPE FILETÉE



ECE R10  
CE

## PHARE SCINTILLANT ROTATIF LED PROFIL BAS

**52827** 46,00€

0.50 - 20 400



**52910** 39,00€

0.50 - 20 320



**52828** 43,00€

0.54 - 20 320



CE ECE R10

- Avec 3 interrupteurs de fonction.
- 3 modes intermittents: ROTATION  
6 ÉCLATS  
MODE DOUBLE FLASH



## LAMPE RECHANGE

POUR REF. 51966

**11103** 6,00€

0.01 - 100 -



POUR REF. 51960, 51962, 51964

**10766** 1,59€

0.01 - 200 -



TULIPES ANTI-RUPTURE

**51969** 14,00€

0.12 - 50 1000



120mm  
Ø 128mm

**11325** 17,50€

0.12 - 50 451



**11324** 17,50€

0.13 - 100 -



## CONNECTEUR POUR GYROPHARE

POUR REF. 51964, 51965,  
52300, 52456, 52549, 53131

**10750** 13,00€

0.25 - 50 -



POUR REF. 51964, 51965,  
52300, 52456, 52549, 53131

**10751** 15,00€

0.30 - 50 -



## RALLONGE ROTATIVE EXTEN- SIBLE POUR GYROPHARE

**52843** 31,60€

0.90 - 20 1500

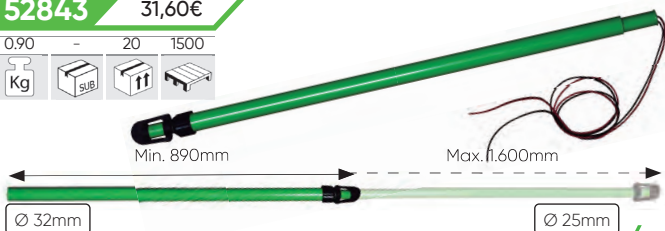

124

JBM / [www.jbmfrance.fr](http://www.jbmfrance.fr)

TVA non comprise

## ALARME DE RECUL 12V-80V

**51967** 16,00€

0.20	10	50	1200
Kg	Sub	ff	

80mm	113mm	50mm
------	-------	------

12V 80V	12V 80V	107 dBa	-30°C 70°C	IP 65
------------	------------	---------	---------------	-------

**51968** 16,00€

0.23	10	50	1000
Kg	Sub	ff	

80mm	113mm	50mm
------	-------	------



- 107 dB.  
- Résistant à différentes conditions climatiques.  
- Possibilité de le laver avec de l'eau à pression.

- Protégé face aux polarités inverses.  
- Scellage avec des résines époxy.  
- Températures supportées : de -30 à 70°C.

## FEU DE SÉCURITÉ POUR CHARIOT ÉLÉVATEUR

**54078** 68,00€

0.66	-	20	200
Kg	Sub	ff	

10V 60V	15W
------------	-----

95mm	150mm	115mm
------	-------	-------



Lampe de sécurité de forme ovale avec 2 diodes émettrices bleu foncé. La lampe projette une lumière bleu foncé directionnelle sur le sol pour avertir les passants.

Grâce à une telle lumière d'avertissement, on pourra éviter des collisions et des accidents impliquant les chariots élévateurs et les gens, tout en renforçant la sécurité dans les conditions de travail, en particulier dans les zones mortes. Idéale pour les environnements obstrués.

Support universel

## PROJECTEUR DE TRAVAIL LUMIÈRE DISPERSÉE

**53428** 18,00€

0.50	5	20	480
Kg	Sub	ff	

1.800 Lm	10V 30V	x9 LED 27W	LED
	IP 67	6000 KELVIN	AL



126mm	108mm	48mm
-------	-------	------

**52566** 28,00€

1.00	-	10	360
Kg	Sub	ff	

1.450 Lm	10V 40V	x9 LED 3W	LED
	+30.000h	IP 68	AL



165mm	117mm	45mm
-------	-------	------

**53429** 18,00€

0.40	5	20	480
Kg	Sub	ff	

1.800 Lm	10V 30V	x9 LED 27W	LED
	IP 67	6000 KELVIN	AL



128mm	Ø115mm	48mm
-------	--------	------

**52567** 29,00€

0.90	-	10	400
Kg	Sub	ff	

1.450 Lm	10V 40V	x9 LED 3W	LED
	+30.000h	IP 68	AL



170mm	Ø127mm	45mm
-------	--------	------

**52302** 25,40€

0.80	5	20	480
Kg	Sub	ff	

1.450 Lm	10-40V 27W	x9 LED 3W	LED
AL	IP 68	+30.000h	



140mm	45mm	117mm
-------	------	-------

**53049** 89,00€

1.53	-	10	468
Kg	Sub	ff	

3.600 Lm	9-36V 40W	x4 LED 10W	LED
AL	IP 68	+30.000h	



118mm	87mm	123mm
-------	------	-------

# PROJECTEUR DE TRAVAIL LUMIÈRE DISPERSÉE

**52303** 26,40€

0.76 5 20 640  
Kg SUB ff

**1.450 Lm** x9 LED 3W

Al 10-40V 27W IP 68 +30.000h



140mm  
45mm  
Ø123mm

**53052** 158,00€

2.65 - 6 144  
Kg SUB ff

**7.200 Lm** x8 LED 10W

Al 9-36V 80W IP 68 +30.000h



191,5mm  
Ø165mm  
98mm

**53045** 35,00€

1.00 - 12 480  
Kg SUB ff

**2.880 Lm** x16 LED 3W

Al 9-36V 46W IP 68 +30.000h



55mm  
127mm  
155mm

**53046** 39,00€

0.74 - 12 480  
Kg SUB ff

**2.272 Lm** x16 LED 1,5W

Al 9-36V 24W IP 68 +30.000h



139mm  
128mm  
48,5mm

# PROJECTEUR DE TRAVAIL LUMIÈRE CONCENTRÉE

**52568** 28,00€

0.75 - 10 400  
Kg SUB ff

**1.450 Lm** x9 LED 3W 10V 40V

+30.000h IP 68 Al



165mm  
117mm  
45mm

**53048** 89,00€

1.50 - 10 1000  
Kg SUB ff

**3.600 Lm** x4 LED 10W

Al 9-36V 40W IP 68 +30.000h



87mm  
123mm  
118mm

**52569** 28,00€

0.70 5 20 320  
Kg SUB ff

**1.450 Lm** x9 LED 3W 10V 40V

+30.000h IP 68 Al



170mm  
Ø127mm  
45mm

**53051** 158,00€

2.75 - 6 468  
Kg SUB ff

**7.200 Lm** x8 LED 10W

Al 9-36V 80W IP 68 +30.000h



191,5mm  
Ø165mm  
98mm

**52415** 19,00€

0.60 5 20 480  
Kg SUB ff

**1.450 Lm** x9 LED 3W

10V 40V +30.000h IP 68 Al



128mm  
110mm  
50mm

**53047** 330,00€

3.51 - 4 40  
Kg SUB ff

**3.200 Lm** x10 LED 5W

Al 12-24V 80W IP 67 +30.000h



230mm  
150mm  
185mm

**52414** 19,00€

0.55 5 20 480  
Kg SUB ff

**1.450 Lm** x9 LED 3W

10V 40V +30.000h IP 68 Al



128mm  
Ø110mm  
50mm



DISTANCE TÉLÉCOMMANDEE 100M



VITESSE RÉGLABLE DE MOUVEMENT



GIRATOIR

## RAMPE D'ÉCLAIRAGE REMORQUE DE 1.100MM X 140MM LED

54163

80,00€

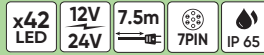

- 4 fonctions:  
Position et plaque d'immatriculation.  
Feu de freinage.  
Clignotant.  
Masse.



Règlement	Homologation
3	E9*3R02/17*23444*00
4	E9*4R00/19*23444*00
6	E9*6R01/29*23444*00
7	E9*7R02/27*23444*00
10	E9*10R06/00*22232*02



## KIT DE SIGNALISATION ARRIÈRE AIMANTÉ LED

54162

81,00€

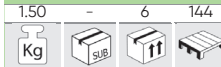

- 4 fonctions:  
Position et plaque d'immatriculation.  
Feu de freinage.  
Clignotant.  
Masse.



Homologué E9\*7R02/27\*23444\*00

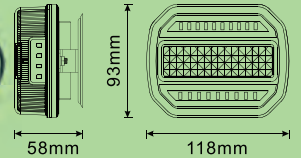

## RAMPE D'ÉCLAIRAGE TÉLESCOPIQUE DE 1,4 A 2,1M

54161

90,00€



- 4 fonctions:  
Position et plaque d'immatriculation.  
Feu de freinage.  
Clignotant.  
Masse.

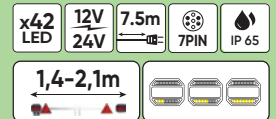

Règlement	Homologation
3	E9*3R02/17*23444*00
4	E9*4R00/19*23444*00
6	E9*6R01/29*23444*00
7	E9*7R02/27*23444*00
10	E9*10R06/00*22232*02



Homologué E9\*7R02/27\*23444\*00

## JEU DE DEUX FEUX ARRIÈRE MAGNÉTIQUES SANS FIL

54044

99,00€



Chargeur de voiture USB

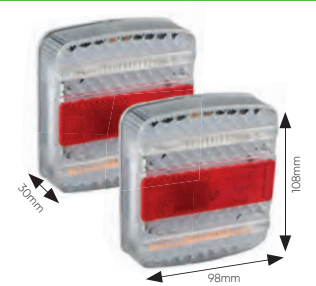

Homologué E9\*178R00\*1448  
E9\*150R00\*1448

Émetteur

Câble de chargement

## FEU LED POUR REMORQUES

53151

14,00€



- 4 fonctions:  
● Bleu: Position et plaque d'immatriculation.  
● Rouge: feu de freinage.  
● Jaune: Clignotant.  
○ Blanc: Masse.



## FEU LED POUR REMORQUES

54160R

17,50€



DOITRE

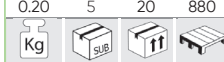

- 4 fonctions:  
● Noir: Position et plaque d'immatriculation.  
● Rouge: feu de freinage.  
● Vert: Clignotant.  
○ Blanc: Masse.

54160L

17,50€



GAUCHE

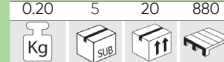

Homologué E9\*7R02/27\*23444\*00

## RAMPE D'ÉCLAIRAGE TÉLESCOPIQUE DE 1,4 à 2,1M CÂBLE DE 6m

**52458** 58,00€

2,60 - 6 48



REFLECTEUR TRIANGULAIRE  
POUR REF.52458, 52848,  
52838, 50810, 51886, 52839

**16158** 9,00€



**52848** 88,00€

2,49 - 6 36



REFLECTEUR TRIANGULAIRE  
POUR REF.52458, 52848,  
52838, 50810, 51886, 52839

**16158** 9,00€



Homologué E4 7R-0218756

BARRES DE REMORQUE

## RAMPE D'ÉCLAIRAGE REMORQUE CÂBLE DE 5m

**50910** 45,00€

1,90 - 6 54



- 4 fonctions:  
Position et plaque d'immatriculation,  
feu de freinage,  
Clignotant.

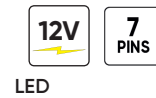

Homologué E4 7R-0218756

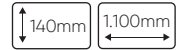

Matériel:  
HDPE



**52838** 56,00€

1,85 - 6 54



REFLECTEUR TRIANGULAIRE POUR  
REF.52458, 52848, 52838, 50810, 51886, 52839

**16158** 9,00€



## KIT DE SIGNALISATION ARRIÈRE AIMANTÉ

**51886** 44,00€

1,50 - 8 120



Lisse: 7m  
Spirale: 2,5m

**52839** 64,00€

1,47 - 8 128

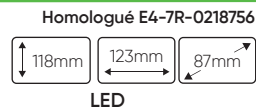

LED



**16158** 9,00€

REFLECTEUR TRIANGULAIRE POUR  
REF.52458, 52848, 52838, 50810,  
51886, 52839





## TESTEUR FAISCEAUX D'ATTELAGE 7/13 BROCHES

**53536** 34,00€

0,40 4 24 432



**7-13**  
broches

**9V**



EXTENSION  
À 7 BROCHES

- Ce testeur a une prise à 13 broches dans chaque extrémité pour être connecté à la prise du remorque et la voiture.
- Il indique rapidement si le câblage de la voiture et de la remorque est endommagé.
- Aussi utile pour vérifier les caravanes et les supports

- à vélos.
- Il a deux sorties, une pour la sortie du véhicule ou une autre pour l'admission de la remorque.
- Comprend un adaptateur de 13 à 7 broches.
- PILES 9V.



13 BROCHES



7 BROCHES



**14753** 13,00€

0,20 - 50 -



- Fiche à 7 broches et prise à 7 broches incluses
- Taille du câble : 20cm x 0,5mm<sup>2</sup>

## TESTEUR FAISCEAUX D'ATTELAGE 7 BORNES

**51929** 22,00€

0,90 4 24 1144



**7**  
pins **9V**



- Ce vérificateur a une prise sur un côté pour brancher la prise à 7 pôles de la remorque et sur l'autre pour brancher la prise à 7 pôles de la voiture.
- Ce vérificateur indique rapidement s'il y a des dommages sur le câblé aussi bien de la voiture que de la remorque.

- Également utile pour la vérification de caravanes et supports pour bicyclettes.
- Il dispose de deux sorties, une pour la prise de sortie du véhicule et une autre pour la prise d'entrée de la remorque.



PRISE  
REMORQUE



PRISE  
VÉHICULE



## MINI COFFRET AMPOULES

12V H9



**12V**

**51615** 5,95€

0,09 10 100 1500



12V H11



**12V**

**51612** 5,95€

0,09 10 100 1500



12 V HB3



**12V**

**50523** 4,70€

0,09 10 100 1500



12V HB4



**12V**

**50524** 4,70€

0,09 10 100 1500



12V H7+H1



**12V**

**50915** 4,20€

0,10 10 100 1800



12 V H1



**12V**

**51613** 2,90€

0,90 10 100 1500



H4



**12V**

**51614** 3,60€

0,10 10 100 1800



**52047** 3,30€

0,09 10 100 1500



H7



**12V**

**50431** 3,80€

0,08 10 100 1800



**52048** 3,95€

0,10 10 100 1500



**24V**

# ARMOIRE A AMPOULES POUR VÉHICULES DE TOURISME

**50551** 350,00€

560mm 650mm

9,39 - 1 14  
Kg sub if

## Stop à 1 PÔLE

P21W 21 W BA15s unités 30  
P21WA 21 W BA15s Orange 10U.  
PY21W 21 W BAU15s  
Ambo Desc. unités 10

## Stop à 2 PÔLES

R21/5 W 21/5 W BAY15d unités 40  
PLAFONIER  
C5W 5 W SV8.5 11x38 unités 22

## Lampes Pilotes

R5W 5 W BA15s unités 30  
R10W 10 W BA15s unités 30

## Lampes Indicatrices

T4W 4 W BA9s unités 22

## Lampes Halogènes

H1 55 W P14.5s unités 10  
H2 55 W X511 unités 4  
H3 55 W PK22s unités 4  
H4 60/55 W P43t unités 10  
H7 55 W PX26d unités 10  
HB3 65 W P20d unités 4  
HB4 55 W P20d unités 4  
H9 65 W PGJ19-5 unités 4  
H11 65 W PGJ19-2 unités 4

## Accent europeen

T5 1,2 W W2.1x4,6d unités 20  
T10 5 W W2.1x9,6d unités 12  
T10 3 W W2.1x9,6d unités 12  
T13 10 W W2.1x9,6d unités 10  
T15 18 W W2.1x9,6d unités 10  
T20 21 W W5x16d unités 10  
T20A 21 W W5x16d Orange 10u.  
T20 21/5 W W5x16d 10 unités



## AMPOULES OBN

H7	H4	H1	H1 55W	H3	BA15S	2 PÔLES
<b>52365</b> 2,46€	<b>52364</b> 2,86€	<b>52362</b> 1,23€	<b>10766</b> 1,59€	<b>52363</b> 1,23€	<b>53203</b> 0,46€	<b>52369</b> 1,19€
0.02 10 200 9000	0.02 10 200 4400	0.01 10 200 14400	0.01 - 200 -	0.02 10 200 14400	0.01 10 200 -	0.01 10 1000 18000
Kg sub if	Kg sub if	Kg sub if	Kg sub if	Kg sub if	Kg sub if	Kg sub if
<b>12V</b> <b>55W</b>	<b>12V</b> <b>60-55W</b>	<b>12V</b> <b>55W</b>	<b>12V</b> <b>55W</b>	<b>12V</b> <b>55W</b>	<b>12V</b> <b>21W</b> AMBRE	<b>12V</b> <b>21-55W</b>
- Emballage: 1pcs par carton	- Emballage: 1pcs par carton	- Emballage: 1pcs par carton	- Emballage: 1pcs par carton	- Emballage: 1pcs par carton		- Emballage: 10pcs par carton - Sans culot T20
<b>T20A</b>	<b>R5W</b>	<b>WEDGE T20</b>	<b>T20</b>	<b>T20</b>	<b>T13</b>	<b>T15</b>
<b>52368</b> 1,14€	<b>53007</b> 0,42€	<b>52862</b> 1,15€	<b>52370</b> 1,17€	<b>52864</b> 1,20€	<b>52865</b> 0,50€	<b>52866</b> 0,25€
0.01 10 1000 18000	0.05 10 200 1500	0.01 10 1000 1500	0.01 10 1000 18000	0.01 10 500 1500	0.01 10 2000 -	0.01 10 2000 256000
Kg sub if	Kg sub if	Kg sub if	Kg sub if	Kg sub if	Kg sub if	Kg sub if
<b>12V</b> <b>21W</b>	<b>5V</b> <b>12W</b>	<b>12V</b> <b>21W</b>	<b>12V</b> <b>21W</b>	<b>12V</b> <b>21/5W</b>	<b>12V</b> <b>10W</b>	<b>12V</b> <b>18W</b>
- Emballage: 10pcs/ctn - Sans culot	- Emballage: 10pcs par carton - Culot BA15S	- Emballage: 10pcs par carton - W3x16d	- Emballage: 10pcs/ctn - Sans culot	- Emballage: 10pcs par carton - W3x16q	- Emballage: 10pcs par carton - Sans culot	- Emballage: 10pcs par carton - Culot



## **OUTILLAGE PNEUMATIQUE**

- 132 CLÉS À CHOC
- 134 POUR CAMIONS
- 135 PERCEUSES / CLIQUETS
- 136 COUPEUSES / KIT DE POLISSAGE
- 137 MEULEUSES
- 138 DÉMONTE PNEUS
- 139 PONCEUSES ORBITALE / PONCEUSES
- 141 MARTEAUX PNEUMATIQUES
- 142 DISQUES DE COUPE / PRÉSENTOIRES
- 143 PISTOLETS DE GONFLAGE / DPF
- 144 FILTRES D'AIR / HUILES LUBRIFIANTES
- 145 MULTIPLES PISTOLETS
- 146 ENROULEUR DE TUYAU D'AIR
- 147 TUYAUX D'AIR / CONNECTEURS
- 148 ADAPTATEURS / CROCHETS

## CLÉ À CHOC 1/2" COMPOSITE

53520 228,00€

2.40 5 10 160



1756Nm

COMPOSITE

TROUSSE DE RÉPARATION POUR OUTILS PNEUMATIQUES REF. 53520

14121 26,00€

0.75 20



## CLÉ À CHOC NANO 1/2"

53588 164,00€

1.65 5 385



109mm



TROUSSE DE RÉPARATION POUR OUTILS PNEUMATIQUES REF. 53588

14165 26,50€

0.05 20



## CLÉ À CHOC MINI 1/2" COMPOSITE

51206 228,00€

COMPOSITE

1.46 5 10 300



TROUSSE DE RÉPARATION POUR OUTILS PNEUMATIQUES REF. 51206

14120 22,00€

0.15 5



## COFFRET CLÉ À CHOC 1/2" COMPOSITE

51207 289,00€

COMPOSITE

3.95 5 80



1756Nm



TROUSSE DE RÉPARATION POUR OUTILS PNEUMATIQUES REF. 51207

14121 26,00€

0.75 20



17, 19, 21mm

## CLÉ À CHOC 1/2"

53733 238,00€

1.30 5 10 280



88mm



237mm



TROUSSE DE RÉPARATION POUR OUTILS PNEUMATIQUES REF. 53733

14633 22,50€

0.03 20

## CLÉ À CHOC 1/2"

53608 98,00€

2.35 5 10 300



TROUSSE DE RÉPARATION POUR 53608

14583 6,00€

0.01 20

## CLÉ À CHOC 1/2" COMPOSITE

53689 238,00€

2.10	5	10	140
Kg	sub	ft	mm

COMPOSITE

1/2"	MAX 1950 Nm	8.600 RPM
95-936 Nm	1,88kg	90 PSI 4 CFM
1/4"	184 L/min	x4 SPEED
	doble martillo twin hammer	

TROUSSE DE RÉPARATION POUR OUTILS PNEUMATIQUES REF. 53689

14618 19,00€

0.01	20	-
Kg	sub	ft



VITESSE ET PUISSANCE RÉGLABLES AVEC UNE SEULE MAIN

## CLÉ À CHOC 1/2"

53726 128,00€

2.35	-	10	240
Kg	sub	ft	mm



1/2"	MAX 1650 Nm	7.000 RPM	2kg	90 PSI 7 CFM
1/4"	198 L/min	107 dBa	190 mm	doble martillo twin hammer

TROUSSE DE RÉPARATION POUR OUTILS PNEUMATIQUES REF. 53726

15564 11,90€

0.01	20	-
Kg	sub	ft

## CLÉ À CHOC COMPOSITE 3/4" RALLONGE 15cm COMPOSITE

51210 650,00€

4.49	-	4	60
Kg	sub	ft	mm

COMPOSITE

3/4"	MAX 2034 Nm	5.500 RPM	271-1627 Nm
4kg	3/8"	198 L/min	90 dBa
x3 SPEED	doble martillo twin hammer		

TROUSSE DE RÉPARATION POUR OUTILS PNEUMATIQUES REF. 51210

14122 34,00€

1.12	50	-
Kg	sub	ft



15,24cm

## CLÉ À CHOC COMPOSITE 1" AVEC RALLONGE 12cm COMPOSITE

51213 690,00€

4.93	-	4	60
Kg	sub	ft	mm

COMPOSITE

1"	MAX 2034 Nm	5.500 RPM	271-1627 Nm
4,4kg	3/8"	198 L/min	90 dBa
x3 SPEED	doble martillo twin hammer		

TROUSSE DE RÉPARATION POUR OUTILS PNEUMATIQUES REF. 51213

14123 33,00€

1.16	20	-
Kg	sub	ft



19cm

## CLÉ À CHOC 3/4" COMPOSITE

51212 488,00€

3.77	-	4	128
Kg	sub	ft	mm

COMPOSITE

3/4"	MAX 2034 Nm	5.500 RPM	90 dBa	x3 SPEED
271-1627 Nm	3,4kg	3/8"	198 L/min	doble martillo twin hammer

TROUSSE DE RÉPARATION POUR OUTILS PNEUMATIQUES REF. 51212

14122 34,00€

1.12	50	-
Kg	sub	ft



## CLÉ À CHOC 1" COMPOSITE

51211 560,00€

3.86	-	4	60
Kg	sub	ft	mm

COMPOSITE

1"	MAX 2034 Nm	5.500 RPM 1.627 Nm	3,5kg	3/8"
5.500 RPM 1.600 Nm	271-1627 Nm	198 L/min	90 dBa	x3 SPEED
doble martillo twin hammer				

TROUSSE DE RÉPARATION POUR OUTILS PNEUMATIQUES REF. 51211

14123 33,00€

1.16	20	-
Kg	sub	ft



JBM RECOMMANDE L'UTILISATION DE SES HUILES LUBRIFIANTES POUR OPTIMISER LES PERFORMANCES ET PROLONGER LA VIE DE L'OUTIL

PAGE 144

14534 600ML



14560 100ML



# CLÉ À CHOC POUR CAMIONS 1"

52814 528,00€

3260Nm

22.25	-	1	24
Kg	sub	ff	

- Échappement: Latérale.
- Facile régulation de vitesse de serrage et desserrage.

670mm



1"	MAX 3260 Nm	3.600 RPM	18,5kg
424 L/min	1/2"	6 bar	90 PSI 18 CFM
x6 SPEED	111 dB	25 m³/h	

32, 33mm
----------



TROUSSE DE RÉPARATION POUR REF. 52814

14153 20,50€

0.05	-	15	-
Kg	sub	ff	



# CLÉ D'IMPACT SPÉCIAL POUR LES CAMIONS 1" - ULTRA LÉGER

53681 743,00€

2441Nm

798	-	2	50
Kg	sub	ff	

1"	MAX 2441 Nm	6.000 RPM	7,1kg
90 PSI 10 CFM	6.3 bar	1/2"	282 L/min
90 dBa	double martillo twin hammer	185mm	522mm

522mm



TROUSSE DE RÉPARATION POUR 53681

14336 58,00€

1.17	10	10	-
Kg	sub	ff	



# CLÉ À CHOC PAPILLON 1/2"

51222 128,00€

101Nm

1.09	-	20	240
Kg	sub	ff	

1/2"	MAX 101 Nm	10.000 RPM	0,9kg
7-68 Nm	6.3 bar	360°	85L/min
1/4"			



TROUSSE DE RÉPARATION POUR OUTILS PNEUMATIQUES REF. 51222

14131 24,00€

0.01	-	10	-
Kg	sub	ff	



MÉCANISME "PAPILLON"

# PERCEUSE D'ANGLE RÉVERSIBLE 3/8"

51221 199,00€

1.27	-	10	120
Kg	sub	ff	

- Réversible des deux côtés.
- Finition en Gomme.



3/8"	1.500 RPM	1,2kg
1/4"	113 L/min	90°
85 dBa	3/8"	Ø 9,5mm

TROUSSE DE RÉPARATION POUR OUTILS PNEUMATIQUES REF. 51221

14130 21,00€

0.01	-	10	-
Kg	sub	ff	



## MINI CLIQUET TRAVERSANT 1/4" COMPOSITE

51225 198,00€

0,89 5 10 120



- Kit inclut:  
 Convertisseur de 1/4" à 3/8".  
 Tête pour Pointes de 1/4".  
 Set 2 pointes plates + 2 Pointes cruciformes.

COMPOSITE



40,7Nm



TROUSSE DE RÉPARATION POUR OUTILS PNEUMATIQUES REF. 51225

14132 21,50€

0,01 - 10 -



1/4" MAX 40,7 Nm

850 RPM

113L/min 0,5kg 85 dBa

## PERCEUSE REVERSIBLE 1/2" COMPOSITE

51220 240,00€

1,64 - 10 120



- Réversible des deux côtés.

COMPOSITE



1/2" 800 RPM

83 dBa 0,5 HP

1,3kg x2 SPEED 12,5mm

TROUSSE DE RÉPARATION POUR OUTILS PNEUMATIQUES REF. 51220

14129 12,50€

0,01 - 10 -



## CLÉ À ROCHET 1/2" COMPOSITE

53784 148,00€

0,55 5 20 1200



COMPOSITE



133mm

1/2" 350 RPM 85 dB 113 L/min  
 43,5mm 40,8 Nm 90 PSI 4 CFM 1/4"  
 0,5kg 360°

TROUSSE DE RÉPARATION POUR OUTILS PNEUMATIQUES REF. 53784

14779 33,00€

0,05 - 10 -



## CLÉ À ROCHET 1/4" COMPOSITE

51214 148,00€

0,55 5 20 -



COMPOSITE



133mm

1/4" MAX 40,7 Nm 350 RPM  
 0,5kg 1/4" 113 L/min  
 360° 90 PSI 4 CFM 85 dBa

TROUSSE DE RÉPARATION POUR OUTILS PNEUMATIQUES REF. 51214

14124 20,50€

0,25 - 10 -



## CLÉ À ROCHET 1/2" COMPOSITE

51215 119,00€

1,55 5 20 240



- Rotation d'air d'admission et échappement.  
 - Roulement à billes.  
 - Régulateur d'Air.



1/2" MAX 68 Nm 150 RPM 14-68 Nm 1,2kg  
 1/4" 113 L/min 6.2 bar 79 dBa 90 PSI 4 CFM

TROUSSE DE RÉPARATION POUR REF. 51215

14125 19,50€

0,33 - 10 -



## DISQUEUSE D'ANGLE COMPOSITE

51218 288,00€

2,27 5 10 120



- Finition en Gomme.  
 - Plus grande prise.  
 - Levier Réversible.

COMPOSITE



TROUSSE DE RÉPARATION POUR OUTILS PNEUMATIQUES REF. 51218

14127 32,50€

0,01 - 10 -



1/4" 12.000 RPM 2kg 1/4"  
 113 L/min 83 dBa 0,6-8mm Ø 125mm

# EXPANDEUR SOUFFLETS DE CARDANS PNEUMATIQUE

**51861** 199,00€

4,00	-	2	32
Kg	Sub	ff	ff

- Matière: Aluminium.
- Ouverture de 20 à 100mm.

**9 bar**  
(125 PSI)



# DISQUEUSE

**51219** 222,00€

2.10	5	10	120
Kg	Sub	ff	ff

- Finition en Gomme.
- Levier de sécurité à 8 positions.

400mm

PIÈCES DE RECHANGE  
PAGE 142

4"	17.000 RPM		
3/8"	1/4"	113 L/min	84 dBa



PROTECTEUR ANTI-ÉTINCELLES

TROUSSE DE RÉPARATION

**14128** 13,50€

0.01	-	10	-
Kg	Sub	ff	ff



# COFFRET MEULEUSE ORBITALE

**51226** 233,00€

1.52	-	10	120
Kg	Sub	ff	ff

- Finition en Gomme.
- Levier de Sécurité.
- Inclut des lunettes, leviers et disques.



TROUSSE DE RÉPARATION  
POUR OUTILS  
PNEUMATIQUES REF. 51226

**14133** 16,50€

0.01	-	10	-
Kg	Sub	ff	ff



# COFFRET DIS-QUEUSE

**51227** 193,00€

2.03	-	10	120
Kg	Sub	ff	ff

- Finition en Gomme.
- Levier Réversible.
- Conception MINI.
- Inclut des lunettes, leviers, Allen et 10 disques de 3".



TROUSSE DE RÉPARATION  
POUR OUTILS PNEUMATI-  
QUES REF. 51227

**14134** 17,50€

0.01	-	10	-
Kg	Sub	ff	ff



PIÈCES DE RECHANGE PAGE 142

PIÈCES DE RECHANGE PAGE 142

# COFFRET BROSEUSE ET ACCESSOIRES

**51216** 650,00€

4,33	-	4	16
Kg	Sub	ff	ff

3.500 RPM	1/4"	83 dBa
-----------	------	--------

- Inclut :  
Différents types de brosses pour la préparation des surfaces.  
Adaptateur métallique.  
Manche anatomique.  
11 mm Brosse à bande caoutchouc (fine).  
23 mm Brosse à fil métallique (fin).  
11 mm Brosse à fil métallique (épais).  
23 mm Brosse à fil métallique (épais).  
Effaceur en gomme.

- Effaceur de peintures avec base d'eau.
- Adaptateur de 23 mm pour effaceur en gomme et brosse à fil métallique.
- Adaptateur de 11 mm brosse à fil métallique.
- Polisseur noir en caoutchouc (jusqu'à 6 pièces).
- Adaptateur unique de polisseur caoutchouc.
- Adaptateur à double bande en caoutchouc.
- Allen.



**19 PCS**  
**1,2kg**

MANCHE ANATOMIQUE

## ACCESSOIRES

### ADAPTATEURS

Pour roue de 23mm <b>51439</b> 26,00€	Pour roue de 11mm <b>51440</b> 28,00€	Roue noir double <b>51441</b> 26,00€	Roue noir simple <b>51442</b> 28,00€
--	--	---	---

### BROSSES

Brosse MÉTAL angle de 23mm <b>51388</b> 22,00€	Brosse MÉTAL angle de 11mm <b>51389</b> 22,00€	Brosse MÉTAL fine de 23mm <b>51390</b> 22,00€	Brosse MÉTAL fine de 11mm <b>51391</b> 22,00€	Gomme dure pour peinture Ø105mm <b>51392</b> 34,00€	Gomme tendre pour peinture Ø105mm <b>51393</b> 34,00€
---	---	--	--	--	--

## ROUE DE RÂCLAGE

Gomme dure pour peinture Ø105mm <b>51392</b> 34,00€
--



TROUSSE DE RÉPARATION POUR  
OUTILS PNEUMATIQUES REF. 51216

**14126** 54,00€

0.01	-	10	-
Kg	Sub	ff	ff

# OUTIL DE FERMETURE DE SOUPAPES POUR PERÇAGE

**54033** 49,00€

0,30	5	20	720
Kg	Sub	ff	ff

- Diamètre de la ventouse : 16, 20, 30, 35, 40 mm
- Diamètre de l'axe : 8mm
- Longueur : 128 mm
- Fréquence de rotation de fonctionnement maximale : 1250 tr/min"



# SERINGUE PNEUMATIQUE POUR GARNISSAGE DES JOINTS

**53567** 43,00€

1.05	-	10	180
Kg	Sub	ff	ff

- Pression de travail: 2,5-5 BAR.
- Entrée d'air: 1/4".
- Capacité de la cartouche: 310 ml.

1/4"	2,5-5 bar
310mL	1,03kg





## MINI MEULEUSE 3/8" 6mm

51245 99,00€

0,60 - 20 240  
Kg SUB f1 f2



TROUSSE DE RÉPARATION POUR OUTILS PNEUMATIQUES REF. 51245

14135 12,50€

0,01 - 10 -  
Kg SUB f1 f2



## MINI MEULEUSE 1/4"

53137 38,00€

0,55 5 20 720  
Kg SUB f1 f2



## CLÉ À CHOC 3/4"

53343 285,00€

7,90 - 2 72  
Kg SUB f1 f2



1600Nm

## CLÉ À CHOC 1"

53344 295,00€

8,05 - 2 80  
Kg SUB f1 f2



1600Nm

## PERCEUSE PNEUMATIQUE

53141 68,00€

0,60 5 20 1120  
Kg SUB f1 f2



## MEULEUSE D'ANGLE PNEUMATIQUE

52528 49,00€

0,70 5 20 960  
Kg SUB f1 f2



BOUTON SÉCURITÉ INCORPORÉE

- Corps fabriqué en aluminium et recouvert en caoutchouc.  
- Facilement maniable et de poids léger.

## SCIE PNEUMATIQUE

52574 69,00€

0,73 4 20 640  
Kg SUB f1 f2



RECHARGE 5 SCIES DE 24 DENTS POUR BOIS

11956 5,50€

0,03 10 300 -  
Kg SUB f1 f2

RECHARGE 5 SCIE DE 32 DENTS POUR FER

11957 5,50€

0,01 10 250 -  
Kg SUB f1 f2

9.000 RPM

1/4"

6 bar

90 PSI

## RIVETEUSE PNEUMATIQUE

52575 119,00€

1,75 5 10 140  
Kg SUB f1 f2



- Traction: 1586LBS / 720 KGS.  
- Longueur tige: 9/16" - 14mm.  
- Max. serrer 60FT LB / 23-69NM.  
- Entrée d'air: 1/4".  
- Consommation moyenne d'air: 0.03CFM/0.86L/MIN.

Inclu:  
- 2 Multioutils  
- Crochet rapide  
- Joints torique  
- Recipient arriere

2,4mm (3/32), 3,2mm (1/8), 4,0mm (5/32), 4,8mm (3/16)

## CISEAUX PNEUMATIQUES POUR MÉTAUX

**53541** 168,00€

1.60	5	10	-
Kg	Sub	ft	

- Ciseaux pneumatique professionnelle, idéale pour couper l'aluminium, autres métaux, le caoutchouc et les plastiques en général, avec une capacité de coupe de 1,02 mm.  
- Poignée ergonomique pour une utilisation confortable et une gâchette facile à utiliser.  
- Permet de couper droit, en angle ou en cercles sans déformation des bords.

1/4"	2.800 RPM	1,3kg
113 L/min	230mm	MIN: 1,02mm

TROUSSE DE RÉPARATION POUR OUTILS PNEUMATIQUES REF. 53541

**14136** 12,00€

0.01	5	-	-
Kg	Sub	ft	



## COUPEUSE PNEUMATIQUE COMPOSITE

**53140** 98,00€

0.99	-	14	400
Kg	Sub	ft	

18.000 RPM	1kg
1/4"	90 PSI
1/4"	5 CFM
Ø 75mm	



DISQUE POUR REF. 53140

**14013** 3,50€

0.01	1000	-	-
Kg	Sub	ft	

## DÉPOINTEUSE PNEUMATIQUE AVEC DÉPLACEMENT DU FORET CENTRAL

**52724** 381,00€

2.55	-	6	84
Kg	Sub	ft	

1/4"



1.800 RPM	8-6.5mm	6.3 bar	90 PSI
-----------	---------	---------	--------

**52725** 349,00€

2.35	-	10	180
Kg	Sub	ft	

1/4"



1.600 RPM	8-10mm	6.3 bar
-----------	--------	---------

FORET POUR 52725 ET 52724

**13817** 17,00€

0.10	500	-	6,5mm
Kg	Sub	ft	

**13818** 20,50€

0.10	500	-	8mm
Kg	Sub	ft	

## DÉCOLLEUR DE PNEU

**53542** 980,00€

6.35	-	4	40
Kg	Sub	ft	



- Détalonneur de jantes pneumatique professionnel spécialement conçu pour les véhicules agricoles, industriels et la plupart des camions.  
- Extrêmement rapide: permet de gagner du temps par rapport aux casseurs hydrauliques conventionnels.  
- Il permet un démontage in situ sur le lieu de travail de la machine.  
- Excellent pour travailler sur le pneu sans démonter la roue: il libère le talon du pneu sur jante avec effet de levier.

SPÉCIALEMENT POUR LES VÉHICULES AGRICOLES

- Spécifications techniques:  
Capacité d'ouverture: 68mm.  
Extension de piston: 80mm.  
Entrée d'air: 1/4".  
Consommation d'air: 113 L / min.  
Longueur: 396mm.  
Poids: 4,6 kg.  
10 000 tr / min

TROUSSE DE RÉPARATION POUR OUTILS PNEUMATIQUES REF. 53542

**14137** 131,00€

0.65	5	5	-
Kg	Sub	ft	



## RODOIR A SOUPAPES PNEUMATIQUE - PERCUSSION ET ROTATION

**53572** 348,00€

1.90	-	5	80
Kg	Sub	ft	

- Contenu:  
1x machine à valve pneumatique.  
5 ventouses (16, 20, 30, 35 et 45 mm).  
5 x adaptateur de valve.  
1x Clé Allen 3 mm.



RÉGULE LA VITESSE

**14157** 8,30€

0.01	50	-	-
Kg	Sub	ft	

16mm

**14158** 9,95€

0.01	50	-	-
Kg	Sub	ft	

20mm

**14159** 12,60€

0.01	50	-	-
Kg	Sub	ft	

30mm

**14160** 12,80€

0.01	50	-	-
Kg	Sub	ft	

35mm

**14161** 13,70€

0.10	50	-	-
Kg	Sub	ft	

40mm



1/4"	800BPM	1/4"
50L/min	1.8 CFM	
289mm		

VIRAGE À DROITE + VIRAGE À GAUCHE

## PONCEUSE AUTOASPIRANTE

**52676** 98,00€

1.45	5	10	80
Kg	Sub	ff	ff

- Corps en aluminium avec manche caoutchouc (ergonomique).  
Avec tube d'aspiration et sac anti-poussière.



10.500 RPM	0,98kg	1/4"	84 L/min	Ø 150mm	5mm
360°	90 PSI	4 CFM	90°		

DESIGN ERGONOMIQUE

## PONCEUSE ADAPTABLE ASPIRATEUR

**52675** 84,00€

1.25	5	10	160
Kg	Sub	ff	ff

**52758** 88,00€

1.33	5	10	160
Kg	Sub	ff	ff

Corps en aluminium avec manche caoutchouc (ergonomique)



## PLATEAUX POUR PONCEUSES

DISQUE DES 6 TROUS POUR 52675, 52758, 52676, 52376

**12009** 11,00€

0.14	50	-
Kg	Sub	ff

Ø 150mm

DISQUE DES 66 TROUS POUR 52675, 52758, 52676, 52376

**13500** 12,90€

0.65	5	50
Kg	Sub	ff

5/16" Ø 149mm

DISQUE DES 15 TROUS POUR 52675, 52758, 52676, 52376

**13499** 12,50€

0.10	50	1500
Kg	Sub	ff

5/16" Ø 147mm

## 3" KIT POUR LA MACHINE DE POLISSAGE PNEUMATIQUE MINIATURE

**53576** 189,00€

1.85	-	5	70
Kg	Sub	ff	ff

- Le kit comprend:  
1x polisseuse pneumatique 3".  
1x disque de ponçage de Velcro (installé).  
1x clé à écrou.  
3x éponges polisseuses avec verso de velcro.



3"	91 L/min	1/4"
2500 RPM	90 PSI	

VITESSE RÉGLABLE

COUSSINET DE POLISSAGE DE LAINE POUR RÉF. 53576

**14162** 25,50€

0.05	50	-
Kg	Sub	ff

COUSSINET SPONGIEUX DUR POUR RÉF. 53576 - JAUNE

**14164** 25,50€

0.50	5	50
Kg	Sub	ff

COUSSINET SPONGIEUX DOUX POUR RÉF. 53576 - BLANC

**14163** 25,50€

0.50	5	50
Kg	Sub	ff

DISQUE VELCRO POUR 53576

**14330** 3,50€

0.01	5	50
Kg	Sub	ff

TROUSSE DE RÉPARATION

**14154** 42,00€

0.05	-	10
Kg	Sub	ff

## 3" KIT POUR LA MACHINE DE POLISSAGE PNEUMATIQUE

**53646** 62,00€

0.85	5	10	400
Kg	Sub	ff	ff

- Le kit comprend:  
1x polisseuse pneumatique 3".  
1x disque de ponçage de Velcro (installé).  
1x clé à écrou.  
3x éponges polisseuses avec verso de velcro.



3.200 RPM	90 PSI	3,5 CFM	6,3 bar	1/4"
99 L/min	3" x 3"	0,69kg		

COUSSINET SPONGIEUX DOUX POUR RÉF. 53646

**14286** 2,99€

0.01	200	-
Kg	Sub	ff

COUSSINET SPONGIEUX DUR POUR RÉF. 53646

**14287** 2,99€

0.01	200	-
Kg	Sub	ff

COUSSINET DE POLISSAGE DE LAINE POUR RÉF. 53646

**14288** 6,00€

0.01	10	200
Kg	Sub	ff

DISQUE VELCRO POUR 53646

**14289** 6,10€

0.10	200	-
Kg	Sub	ff

JBM RECOMMANDE L'UTILISATION DE SES HUILES LUBRIFIANTES POUR OPTIMISER LES PERFORMANCES ET PROLONGER LA VIE DE L'OUTIL

**14534** 600ML

**14560** 100ML

## KIT DE RESTAURATION DE PHARES

**53626** 18,00€

Ce kit est conçu pour restaurer **2 phares**.

0.30 - 12 576



Le kit est conçu pour restaurer la transparence de verres optiques jaunis ou atténués des phares. Le kit de restauration de verres des phares augmente leur efficacité. Trois simples étapes: meulage, polissage et protection. Restaure les feux avant, arrière, antibrouillard ou les indicateurs de direction.

- Complétude:
  - 2x roues d'éméri P800.
  - 2x roues d'éméri P1200.
  - 2x roues d'éméri P2000.
  - 1x 85 g de pâte à polir.
  - 2x 3,0 ml de liquide de protection UV.
- 1x ruban adhésif.
- 1x roue à polir en laine.
- 1x disque éponge blanc.
- 1x buse, filetage M10.
- 2x adaptateur (3/8" et 1/4").



## SPÉCIALE KIT DE POLISSAGE: MACHINE POLISSAGE PNEUMATIQUE + 12 KIT RESTAURATION PHARES

**SERIE262** 199,00€

5.25 - - -



## COFFRET OUTILS PNEUMATIQUE

**52331** 201,00€

7.90 - 2 48



PISTOLE À CHOC + MARTEAU PNEUMATIQUE + CLÉ À ROCHET PNEUMATIQUE + MINI MEULEUSE PNEUMATIQUE + PISTOLET À AIR + PISTOLET À AIR DROITE

- 1x Clé à rochet 1/2"
- 1x Marteau pneumatique 150mm
- 1x Cliquet pneumatique 3/8"
- 1x Meuleuse pneumatique
- 1x Ressort de retenion
- 1x Barre de extension 1/2" - 75mm
- 1x Mini graisseur
- 1x Clé hex. 4mm
- 8x Douille a choc: 12, 13, 17, 19, 1/2", 9/16", 5/8", 11/16"
- 1x Pistolet a air
- 1x Mini pistolet a air
- 1x Ruban teflon
- 4x Escarpes 120mm
- 2x Clés fixes
- 5x Disque de ponceuse 1/4"
- 5x Disque de ponceuse 1/2"
- 5x Pierre de 1/4"
- 5x Pierre de 3/8"
- 2x Cylindres de ponceuse (3/4" et 1")
- 1x Adaptateur rapide female
- 1x Connecteur escarpa
- 8x Embouts de soufflage
- 2x Coliers 1/8"
- 1x Conecteur M-M connexion rapide
- 1x Conecteur rapide M-H
- 1x Embouts caouchouc
- 1x Embouts conique
- 1x Aiguille de gonflage
- 1x bec de haute precision
- 1x Bec de securite
- 1x Coffret plastique



## COFFRET 16 PIÈCES PNEUMATIQUE AVEC CLÉ À ROCHET

**52156** 140,00€

5.36 - 4 112



CLÉ A CHOC:



CLIQUET PNEUMATIQUE: ADAPTATEUR M / H



1/2" 16 PCS

9, 10, 11, 13, 14, 17, 19, 22, 24, 27mm

### CLÉ À CHOC 1/2"

**52165** 118,00€

**610Nm**

2.90 - 6 168



### CLÉ À ROCHET 1/2"

**52167** 48,00€

**61Nm**

1.25 5 10 560



## MARTEAU DE BROSSAGE PNEUMATIQUE

**53625** 68,00€

2.15	5	10	320
Kg	sub	ff	ff

- Vitesse d'impact: 4500BPM  
- 19 aiguilles

350mm 43mm

90 PSI 4 CFM 6.3 bar

1/4"

4500BPM 19 agujas 19 needles

Coup: 43mm

**AIGUILLE POUR REF. 53625**  
**14188** 0,50€

0.00	50	200	-
Kg	sub	ff	ff

## MARTEAU PNEUMATIQUE

**52718** 48,00€

1.95	4	8	144
Kg	sub	ff	ff

9 PCS

21mm 1,8mm 21mm 21mm

## PERCEUSE RÉVERSIBLE 1/2"

**52159** 64,00€

1.79	5	10	240
Kg	sub	ff	ff

1/2" 700 RPM 1/4" 90 PSI 4 CFM 1/2" 12,5mm

## PERCEUSE PNEUMATIQUE DROITE, 3/8"

**53573** 36,00€ - Point de 1,5-10mm.

0.75	5	20	-
Kg	sub	ff	ff

3/8" 20.000 RPM 0,78kg 90 PSI 4 CFM 89 dB 1/4" 113 L/min 6.3 bar 1.5-10mm

## PERCEUSE RÉVERSIBLE 3/8"

**52160** 48,00€

1.22	5	10	400
Kg	sub	ff	ff

3/8" 1.800 RPM 1/4" 90 PSI 4 CFM 3/8" 9,5mm

## PERCEUSE D'ANGLE RÉVERSIBLE 3/8"

**52527** 82,00€

1.22	5	10	480
Kg	sub	ff	ff

3/8" 1.500 RPM 1/4" 90° 3/8" 9,5mm

## COFFRET DE 16 PIÈCES AVEC MEULEUSE PNEUMATIQUE

**52157** 48,00€

0.90	5	10	240
Kg	sub	ff	ff

1/4" 25.000 RPM 0,37kg 1/4" 113 L/min 90 PSI 4 CFM 93 dBa

## MINI MEULEUSE PNEUMATIQUE 1/4"

**52171** 39,00€

0.40	5	20	1080
Kg	sub	ff	ff

1/4" 25.000 RPM 0,37kg 1/4" 113 L/min 90 PSI 4 CFM 93 dBa

123mm

JBM RECOMMANDE L'UTILISATION DE SES HUILES LUBRIFIANTES POUR OPTIMISER LES PERFORMANCES ET PROLONGER LA VIE DE L'OUTIL

PAGE 144

**14534**  
600ML

**14560**  
100ML

## MEULEUSE PNEUMATIQUE DE 3"

52953 38,00€

0,90 5 20 420



DISQUE 3" POUR REF. 52953

12987 1,50€



## DISQUE DE COUPE

POUR REF. 51227



51387 3,25€



∅ Intérieur: 9,53mm  
∅ Extérieur: 75mm

3"

POUR REF. 51219



51385 4,55€



∅ Intérieur: 9,53mm  
∅ Extérieur: 100mm

4"x1/32"

## DISQUE DE PONÇAGE

POUR REF. 51218

51386 5,95€



∅ Intérieur: 22mm  
∅ Extérieur: 125mm

5"



POUR REF. 51226

51444 5,05€



∅ Extérieur: 2"

#80



POUR REF. 51226

51443 5,50€



∅ Extérieur: 2"

#60



POUR REF. 51226

51445 5,05€



∅ Extérieur: 2"

#120



## PRÉSENTOIR POUR OUTILS PNEUMATIQUES

53492 380,00€



LIVRE SANS OUTIL



## SUPPORT MAGNETIQUE

52378 10,00€



3Kg

∅ 6cm



52378

51341 35,00€



9Kg

∅ 7cm



51341

## PRÉSENTOIR POUR OUTILS PNEUMATIQUES

53147 41,00€



LIVRE SANS OUTIL



## PISTOLET DE GONFLAGE

ANALOGIQUE

**53449** 14,00€

0.45 5 20 320



0-7 BAR  
0-100 PSI



DIGITAL

**53450** 28,30€

0.40 5 20 320



0-14 BAR  
0-200 PSI



- Piles incluses.

## PISTOLET NETTOYAGE DE FAP

**52543** 182,00€

0.84 - 6 90



- Universel.
- Capacité maximale 650cc.
- Racor de Nylon de 4x6x2.7m.
- Rang de pression de travail: 3 bar - 7 bar.
- Recipient en alu. + Base en alu.



LIQUIDE NETTOYANT

**90003** 35,20€

1.08 - 12 400



LIQUIDE NEUTRALISANT

**90004** 25,80€

0.50 - 12 320



## KIT PISTOLET DE GONFLAGE + SOUFFLETTE

**51981** 21,50€

0.58 5 20 240



0-16 BAR  
0-220 PSI



## PISTOLET DE GONFLAGE

**51980** 15,00€

0.40 5 25 450



0-16 BAR  
0-220 PSI



## CONTROLEUR DE PRESION

**52648** 9,00€

0.08 5 100 2000



5-6 bar



AVEC TUBE

**53416** 14,10€

0.20 10 100 800



0-10 bar



TESTEUR DIGITAL AVEC TUBE

**53417** 26,30€

0.25 10 100 800



0-15 BAR  
0-200 PSI

0-1.500 KPA



DIGITAL

**53418** 16,90€

0.20 10 100 800



0-15 BAR  
0-300 PSI

0-1.500 KPA



## POMPE À GRAISSE PNEUMATIQUE

**50751** 43,00€

1.50 5 10 150



- Pression: 30Mpa



500ml

JBM RECOMMANDE L'UTILISATION DE SES HUILES LUBRIFIANTES POUR OPTIMISER LES PERFORMANCES ET PROLONGER LA VIE DE L'OUTIL

PAGE 144

**14534**  
600ML



**14560**  
100ML



## KIT 5 ACCESSOIRES

**51277** 64,00€

1,84 - 5 60



- Pistolet pour peindre par gravité avec réservoir de 600 ml.
- Pistolet de soufflage avec réservoir pour solution de nettoyage.
- Tuyau - spirale de 5x8 mm avec connexion instantanée 1/4" extensible jusqu'à 4,5 m.
- Gonfleur de pneus avec manomètre de pression.
- Pistolet à air.



## SOUFFLETTE MÉTAL + ACCESSOIRES

**51383** 11,10€

0,27 10 50 650



- Pistolet à air.
- Emmanchement rapide européen.
- Emmanchement de tuyau.
- Extenseur de tube 10cm.
- Extenseur de tube 20cm.



PRÉSENTOIR DE 10 UNITÉS



## SOUFFLETTE EXTENSIBLE

**52798** 18,00€

0,25 10 50 700



285-530mm



POINTE CAOUTCHOUTÉ POUR ÉVITER LES RAYURES

## SOUFFLETTE

**52490** 6,65€

0,10 10 40 960



100mm



**52491** 10,50€

0,15 10 80 800



300mm



PRÉSENTOIR DE 10 UNITÉS

## PISTOLET À AIR EXTRA-LONG

**53611** 27,50€

0,50 - 40 160



1.020MM



GRAND VOLUME D'AIR

## PISTOLET SOUFFLAGE GRAND DÉBIT

**53205** 19,00€

0,90 - 48 500



- Pistolet de soufflage haut débit.
- Matériau: alliage d'aluminium.
- Surface: nickelée.



GRAND DÉBIT

## SARBACANE EN BLISTER INDIVIDUELLE

**52787** 9,00€

0,20 25 100 1000



## KIT SOUFFLETTE DE 3/8" AVEC TUYAU DE 5m

**52381** 20,50€

0,45 5 25 200



- Matériel: PU // 35 rebondissements.

## FILTRE ET RÉGULATEUR À AIR

**53063** 36,70€

0,60 5 50 300



1/4"

**53064** 37,40€

0,63 5 50 300



3/8"



## FILTRE REGULATEUR D'AIR ET LUBRIFIANT

**53066** 61,00€

1,08 5 25 250



1/4"

**53067** 61,00€

0,50 5 25 250



3/8"



**53065** 36,90€

0,60 5 50 300



1/2"



**53068** 63,00€

1,00 5 25 250



1/2"

## DÉRIVATEUR D'HUILE 1/4"

**14561** 8,80€

0,05 25 50 -



1/4"



## HUILE POUR OUTIL PNEUMATIQUE

**14534** 16,50€

0,55 - 12 540



600ml



**14560** 8,80€

0,10 12 72 1008



100ml





## PISTOLET DE PULVÉRISATION D'AIR

54248 58,00€

0.63	5	20	240
Kg	sub	ff	sub

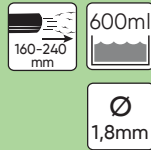

## PISTOLET DE PULVÉRISATION D'AIR PROFESSIONNEL

54249 103,00€

0.71	5	20	240
Kg	sub	ff	sub

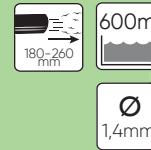

## PISTOLET À SÉCHER PNEUMATIQUE

53606 55,00€

0.60	5	20	-
Kg	sub	ff	sub



VANNE DE RÉGULATION D'AIR

## PISTOLET À JET DE SABLE PNEUMATIQUE

53593 41,00€

2.75	-	5	80
Kg	sub	ff	sub

- Contiens: 1x Sableuse pneumatique. 1x Piège. 2x Sable (850g). 4x Buses: de traitement par points. de traitement de surface. pour les coins externes. pour les coins internes.

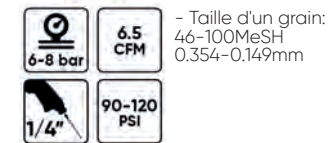

- Taille d'un grain: 46-100MeSH 0.354-0.149mm

- La sableuse pneumatique est idéale pour une variété de travaux de carrosserie et de traitement de surfaces métalliques. L'appareil est conçu pour éliminer la rouille, les saletés, les revêtements, etc. facile à utiliser.



BOUTEILLE DE SABLE POUR RÉF. 53593

14168 7,00€

0.95	-	20	-
Kg	sub	ff	sub



## PISTOLET NETTOYAGE MOTEUR

53202 15,70€

1.40	-	10	80
Kg	sub	ff	sub

- Pistolet de nettoyage du moteur.
- Matériel du réservoir: acier.
- Matériel du pistolet: alliage d'aluminium.
- Surface peinte.



## PISTOLET NETTOYANT THERMIQUE TORNADO

53204 81,00€

0.90	-	5	60
Kg	sub	ff	sub



- Fortement recommandé pour le nettoyage à sec des véhicules.
- Matériel du réservoir: PE.
- Matériel du corps: Alliage d'aluminium.
- Finition polie.



360°

Permet un mouvement à 360° du pistolet et permet aussi le blocage dans n'importe quelle position.



- Peut soutenir 2 pistolets de séchage en toute sécurité
- Comprend 2 tuyaux d'air en spirale: 8mm x 12mm x 5m.
- Corps en acier avec coupleurs d'air en laiton.

- Il contient deux pistolets de séchage pneumatiques (réf. 53606) présentant les caractéristiques suivantes: Corps en aluminium. Pression de travail: 2-4 bar (30-60psi). Consommation d'air: 325 l / min. Entrée d'air: 1/4". Avec valve de régulation d'air.

Hauteur ajustable jusqu'à 208cm et largeur jusqu'à 86cm.



## ENROULEUR DE TUYAU D'AIR 3/8" 20+2m

**53582** 179,00€

10.85	-	1	14
Kg	Sub	ff	

**53583** 170,00€

10.75	-	1	14
Kg	Sub	ff	

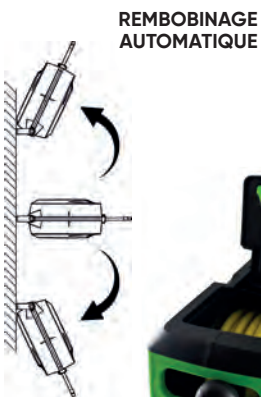
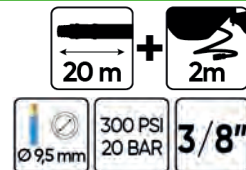

SUPPORT MURAL INCLUS

**SUPPORT MURAL**

**14772** 8,50€

0.35	-	20	-
Kg	Sub	ff	

## ENROULEUR DE TUYAU D'AIR 3/8" 12+1m

**53532** 119,00€

6.80	-	2	30
Kg	Sub	ff	

**53581** 115,00€

6.70	-	2	30
Kg	Sub	ff	

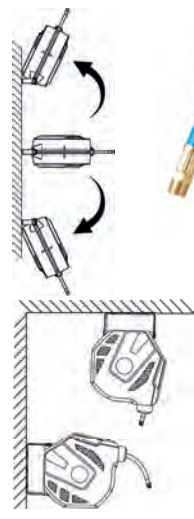

SUPPORT MURAL INCLUS

**SUPPORT MURAL**

**14771** 10,50€

0.35	-	30	-
Kg	Sub	ff	

## ENROULEUR DE TUYAU D'AIR 11m

**53881** 79,00€

4.50	-	4	48
Kg	Sub	ff	

**53882** 79,00€

4.50	-	4	48
Kg	Sub	ff	

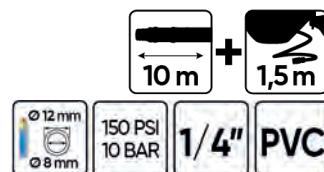

SUPPORT MURAL INCLUS



REBOBINAGE AUTOMATIQUE

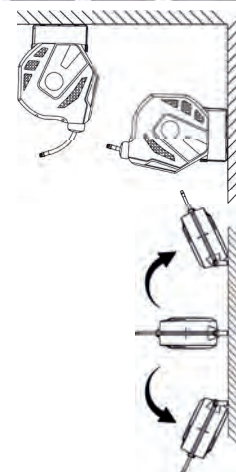

## TUYAUX SPIRAL PNEUMATIQUES

<b>53629</b>	14,30€	10m	<b>53630</b>	18,80€	15m
0,55 - 6 372	8mm		0,65 - 6 240	8mm	
		connecteur 1/4"			connecteur 1/4"

  

<b>53632</b>	46,00€	15m	<b>53631</b>	33,50€	15m
2,20 - 6 78	15mm		1,25 - 6 132	12mm	
		connecteur 1/4"			connecteur 1/4"

<b>53634</b>	63,00€	15m	<b>53633</b>	46,00€	15m
2,60 - 6 66	18mm		2,10 - 6 78	15mm	
		connecteur 1/2"			connecteur 3/8"

AVEC EXTRÉMITÉS PIVOTANTES À 360 DEGRÉS POUR UN DÉPLACEMENT ET UNE UTILISATION FACILES

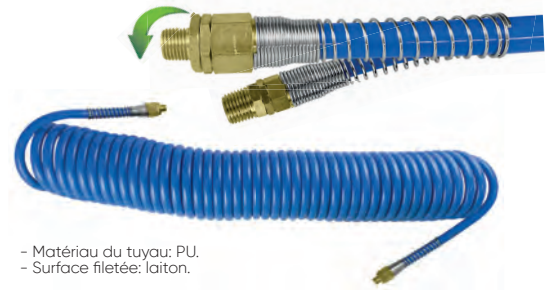

- Matériau du tuyau: PU.  
- Surface fileté: laiton.

## TUYAU PNEUMATIQUE

<b>53594</b>	54,00€	3,20 - 4 96	<b>53595</b>	61,00€	3,20 - 4 96



- Pression de travail: 300PSI / 20bar.
- Pression de rupture: 950PSI / 65bar.
- Température de travail: -40°C / 65°C
- Grande flexibilité.
- Retour à sa forme originale.
- Surface douce, n'endommage pas la peinture.
- Très résistant.

<b>53594</b>	<b>53595</b>
Diamètre intérieur: 8mm Diamètre extérieur: 13mm	Diamètre intérieur: 10mm Diamètre extérieur: 15mm
A utiliser avec: Ref. 52736 M8	A utiliser avec: Ref. 52737 M10

**25m** 300 PSI 20 BAR

HYBRID POLYMER

x10

JEU DE 10 PINCES 8-16mm

<b>14169</b>	3,00€		
0,10 - 125 -			

## CONNECTEUR RAPIDE AVEC FIXATEUR - RACCORDEMENT DE TUYAU

<b>14201</b>	4,00€	0,10 25 100 -	<b>M6</b>
<b>14202</b>	4,00€	0,10 25 100 -	<b>M8</b>
<b>14203</b>	4,50€	0,10 25 100 -	<b>M10</b>

## ADAPTATEUR ARTICULÉ POUR AIR COMPRIMÉ MÂLE

<b>14314</b>	5,00€	0,06 25 100 -	<b>14315</b>	4,50€	0,06 25 100 -

**EUR 1/4"**

**US 1/4"**

## RACCORDEMENT DE TUYAU

REF.	DESCRIPTION		€
14204	EUR - M6	0,06	1,50€
14205	EUR - M8	0,06	1,50€
14206	EUR - M10	0,06	1,50€
14207	US - M6	0,06	1,50€
14208	US - M8	0,06	1,50€
14209	US - M10	0,06	1,50€

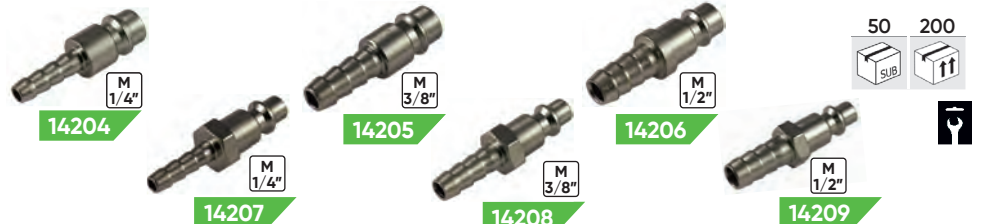

## CONNECTEUR RAPIDE AVEC FIXATEUR DE PROTECTION

REF.	DESCRIPTION		€
14195	FEMELLE - FILETAGE EXTERNE 1/4"	0,5 25 100	4,00€
14196	FEMELLE - FILETAGE EXTERNE 3/8"	0,10 25 100	4,00€
14197	FEMELLE - FILETAGE EXTERNE 1/2"	0,10 25 100	4,50€
14198	FEMELLE - FILETAGE INTERNE 1/4"	0,10 25 100	4,00€
14199	FEMELLE - FILETAGE INTERNE 3/8"	0,10 25 100	4,00€
14200	FEMELLE - FILETAGE INTERNE 1/2"	0,10 25 100	4,50€

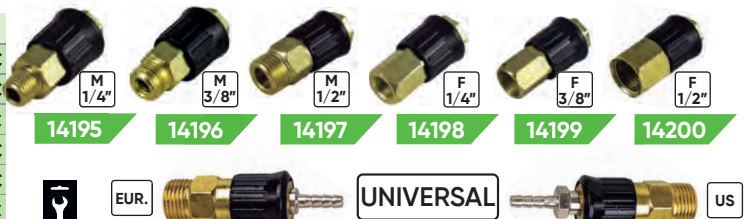

# CONNECTEUR / FILETAGE

REF.	DESCRIPTION	Kg	€
<b>US</b>			
13930	CONNECTEUR MÂLE - FILETAGE MÂLE 1/4"	0,05	1,50€
13932	CONNECTEUR MÂLE - FILETAGE MÂLE 3/8"	0,1	2,50€
14076	CONNECTEUR MÂLE - FILETAGE FEMELLE 3/8"	0,1	1,50€
13933	CONNECTEUR MÂLE - FILETAGE MÂLE 1/2"	0,1	2,00€
13935	CONNECTEUR MÂLE - FILETAGE FEMELLE 1/4"	0,05	2,50€
13936	CONNECTEUR FEMELLE - FILETAGE FEMELLE 1/4"	0,05	3,50€
13937	CONNECTEUR FEMELLE - FILETAGE MÂLE 1/4"	0,05	4,00€
14078	CONNECTEUR FEMELLE - FILETAGE FEMELLE 3/8"	0,1	4,00€
14191	CONNECTEUR MÂLE - FILETAGE FEMELLE 1/2"	0,1	2,00€
14193	CONNECTEUR FEMELLE - FILETAGE FEMELLE 1/2"	0,1	4,00€
<b>EUR.</b>			
13931	CONNECTEUR MÂLE - FILETAGE MÂLE 1/4"	0,05	2,50€
14075	CONNECTEUR MÂLE - FILETAGE FEMELLE 3/8"	0,1	2,00€
13934	CONNECTEUR MÂLE - FILETAGE FEMELLE 1/4"	0,05	2,50€
13938	CONNECTEUR FEMELLE - FILETAGE FEMELLE 1/4"	0,1	3,50€
13939	CONNECTEUR FEMELLE - FILETAGE MÂLE 1/4"	0,1	4,00€
14077	CONNECTEUR FEMELLE - FILETAGE FEMELLE 3/8"	0,1	4,50€
14190	CONNECTEUR MÂLE - FILETAGE FEMELLE 1/2"	0,1	2,00€
14192	CONNECTEUR FEMELLE - FILETAGE FEMELLE 1/2"	0,1	4,00€

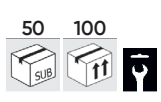

## RACCORD RAPIDE PNEUMATIQUE

52735	4,85€	M6	52736	5,35€	M8	52737	5,50€	M10			
0.05	25	200	4000	0.10	25	200	4000	0.10	25	200	4000
Kg	SUB	↑↑	↑↑↑	Kg	SUB	↑↑	↑↑↑	Kg	SUB	↑↑	↑↑↑



- Contient un connecteur mâle et un connecteur femelle.

## ADAPTATEUR ARTICULÉ PNEUMATIQUE

12988	12,00€	1/2"	13809	18,50€	1/4"	13810	20,50€	3/8"			
0.15	62	125	-	0.10	62	250	-	0.10	62	250	-
Kg	SUB	↑↑	↑↑↑	Kg	SUB	↑↑	↑↑↑	Kg	SUB	↑↑	↑↑↑





# OUTILLAGE À CHOC

- 150 SET DE DOUILLES D'IMPACT
- 152 BARRES D'EXTENSION  
/ ARTICULATIONS D'IMPACT
- 153 SETS DE POINTES
- 154 ADAPTATEURS D'IMPACT  
/ DOUILLES D'IMPACT DE 3/4" ET 1"
- 156 OUTILLAGE D'IMPACT POUR VÉHICULES LOURDS

## JEU 6 DOUILLES À CHOC DE 1/2" 6 PANS

52337 65,00€

1.91 5 10 300

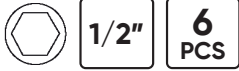

CONTIENT

x3	30, 32, 36mm
x3	14, 17, 19mm

## JEU DE 8 DOUILLES ET POINTES XZN DE 1/2" A CHOC

52547 96,00€

2.70 - 5 200



CONTIENT

x4	27, 30, 32, 34, 36mm
x3	M14, M16, M18

## JEU DE DOUILLES À CHOC DE 13 PIÈCES DE 1/2" 6 PANS + REDUCTEUR

52341 58,00€

1.70 - 4 336



10, 11, 12, 13, 14, 17, 19, 21, 22, 24mm

PIÈCES DE RECHANGE DISPONIBLES

REF.	mm	Kg	fl	€	REF.	mm	Kg	fl	€	REF.	mm	Kg	fl	€			
14728	10mm	0,10	5	20	3,80€	11195	17mm	0,10	10	50	3,70€	14735	Porte-buses à impact	0,05	5	20	6,50€
14729	11mm	0,05	5	20	3,80€	11121	19mm	0,10	10	60	4,10€	12074	Barre d'ext. d'imp. 250mm	0,23	10	60	11,50€
14730	12mm	0,05	5	20	3,80€	14733	21mm	0,10	5	20	4,30€	11990	Cardan pour douilles à choc	0,15	100	100	15,30€
14731	13mm	0,10	5	20	3,80€	14734	22mm	0,15	5	20	5,40€						
14732	14mm	0,10	5	20	3,80€	11122	24mm	0,15	10	20	5,45€						

## JEU DE 3 DOUILLES XZN DE 1/2" A CHOC

52694 49,00€

1.31 5 10 600



30, 32, 36mm (78mmL)



## JEU 19 PIÈCES À CHOC DE 1/2" AVEC 14 DOUILLES + RÉDUCTEURS

52345 109,00€

3.55 - 6 240



53531 109,00€

3.55 - 4 240



52345: PIÈCES DE RECHANGE DISPONIBLES

REF.	mm	Kg	fl	€	REF.	mm	Kg	fl	€		
14728	10mm	0,10	5	20	3,80€	14733	21mm	0,10	5	20	4,30€
14729	11mm	0,05	5	20	3,80€	14734	22mm	0,15	5	20	5,40€
14730	12mm	0,05	5	20	3,80€	11122	24mm	0,15	10	20	5,45€
14731	13mm	0,10	5	20	3,80€	11123	27mm	0,35	10	50	6,50€
14732	14mm	0,10	5	20	3,80€	12937	Barre d'extension d'impact 50mm	0,11	10	100	9,50€
14970	15mm	0,08	5	20	2,50€	14973	Barre d'extension d'impact 150mm	-	5	20	11,50€
14971	16mm	0,07	5	20	2,50€	12075	Barre d'extension d'impact 250mm	0,45	10	50	15,50€
11195	17mm	0,10	10	50	3,70€	11962	Reducteur à choc 1/2"H 3/4"M	0,15	10	100	7,50€
14972	18mm	0,12	5	20	3,50€	11990	Cardan pour douilles a choc	0,15	10	100	15,30€
11121	19mm	0,10	10	60	4,10€						

## JEU DE 15 PIÈCES À CHOC AVEC 12 DOUILLES LONGUES DE 1/2" 6 PANS + RÉDUCTEURS

52346 103,00€

4.55 - 6 252

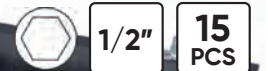

PIÈCES DE RECHANGE DISPONIBLES

REF.	mm	Kg	fl	€	REF.	mm	Kg	fl	€	
12071	24mm	0,30	10	50	11,00€	12061	10mm	0,14	10	9,50€
12072	27mm	0,35	10	20	12,00€	12062	12mm	0,15	10	9,50€
12074	Barre d'extension d'impact 125mm	0,23	10	60	11,50€	12063	13mm	0,15	10	9,50€
12075	Barre d'extension d'impact 250mm	0,45	10	50	15,50€	12064	15mm	0,17	10	9,00€
11990	Cardan pour douilles a choc	0,15	10	100	15,30€	12065	16mm	0,30	10	9,00€
						12066	17mm	0,20	10	9,00€
						12067	18mm	0,20	10	9,50€
						12068	19mm	0,21	10	9,50€
						12069	21mm	0,25	10	9,50€
						12070	22mm	0,30	10	10,50€



## JEU DE 12 DOUILLES À CHOC 1/2" 6 PANS PROFIL BAS

**53060** 34,90€

10, 11, 12, 13, 14, 15, 16, 17, 18,  
19, 20, 21mm (28,2mmL)



1/2"

12  
PCS

0.85	5	25	500
Kg	Sub	ff	ff

28mmL



## JEU DE 11 DOUILLES À CHOC DE 1/2"

**53744** 63,00€

**52342** 63,00€

10, 11, 12, 13, 14, 16, 17, 19,  
21, 22, 24mm (78mmL)

1/2"

11  
PCS

2.30	5	10	360
Kg	Sub	ff	ff



2.05	5	10	360
Kg	Sub	ff	ff



### PIÈCES DE RECHANGE DISPONIBLES

REF.	mm	Kg	Sub	ff	ff	€
12061	10mm	0,14	10	100		9,50€
14736	11mm	0,15	5	20		5,00€
12062	12mm	0,15	10	100		9,50€
12063	13mm	0,15	10	50		9,50€
14737	14mm	0,15	5	20		5,00€
12065	16mm	0,30	10	20		9,00€
12066	17mm	0,20	10	50		9,00€
12068	19mm	0,21	10	50		9,50€
12069	21mm	0,25	10	50		9,50€

REF.	mm	Kg	Sub	ff	ff	€
12070	22mm	0,30	10	20		10,50€
12071	24mm	0,30	10	50		11,00€

## JEU DE 3 DOUILLES À CHOC HEX. LONGUES

**52969** 20,70€



1/2"

3  
PCS

0.80	5	20	640
Kg	Sub	ff	ff

17, 19, 21mm  
(78mmL)



### PIÈCES DE RECHANGE DISPONIBLES

REF.	mm	Kg	Sub	ff	ff	€
12066	17mm	0,18	10	50		9,00€
12068	19mm	0,21	10	50		9,50€
12069	21mm	0,20	10	50		9,50€

## KIT DE 4 EMBOUTS À CHOC POUR LES ROUES EN ALLIAGES LEGERS, 1/2"

**53587** 44,00€

1/2"

4  
PCS

1.05	5	20	-
Kg	Sub	ff	ff



### PIÈCES DE RECHANGE DISPONIBLES

REF.	mm	Kg	Sub	ff	ff	€
14172	15mm - SMART	0,20	10	50		8,50€
14173	17mm - MERCEDES	0,20	10	50		9,50€
14177	22mm - OPEL	0,25	10	50		9,50€
14178	21mm - HYUNDAI/KIA	0,25	10	50		9,50€

## JEU DE 4 DOUILLES A CHOC 1/2" SPÉCIAL EXTRACTION ROUES

**52338** 41,00€



1/2"

4  
PCS

1.00	5	20	640
Kg	Sub	ff	ff

17, 19, 21, 22mm (85mmL)



### PIÈCES DE RECHANGE DISPONIBLES

REF.	mm	Kg	Sub	ff	ff	€
11314	17mm	0,21	10	100		8,50€
11315	19mm	0,23	10	100		8,50€
11316	21mm	0,26	10	100		8,50€
11628	22mm	0,27	10	50		9,50€

## JEU DE 3 DOUILLES A CHOC DE 1/2" SPÉCIAL JANTES ALU

**51336** 29,30€

17, 19, 21mm  
(85mmL)



1/2"

3  
PCS

0.85	-	5	700
Kg	Sub	ff	ff



## JEU DE 10 DOUILLES A CHOC DE 1/2" SPECIAL JANTES ALU

53988 101,00€

3.00	-	10	120
Kg	Sub	ff	

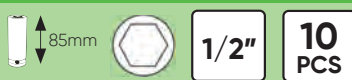

### CONTIENT

x7 1/2"	15, 17, 19, 21, 22, 23, 24mm
x1 7/8"	Tesla
x1 17mm	Mercedes
x1 21mm	Hyundai/Kia



## JEU DE 12 DOUILLES A CHOC DE 1/2" 6 PANS SPECIAL JANTES ALU

52343 52,00€

1.90	-	4	360
Kg	Sub	ff	

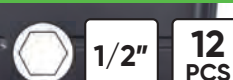

### CONTIENT

x3 85mmL	17, 19, 21mm
x1 42mmL	27mm
x8 38mmL	10, 11, 13, 14, 17, 19, 22, 24mm



## JEU DE 4 DOUILLES D'IMPACT POUR VIS DE SECURITE

53197 46,00€

1.17	5	20	-
Kg	Sub	ff	

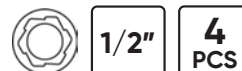

17, 19, 21, 22mm (82mmL)

## KIT DE BARRES D'EXTENSION A CHOC

53077 62,00€

1.58	-	10	240
Kg	Sub	ff	

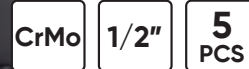

100, 110, 120, 135, 150 Nm



## BARRES D'EXTENSION A CHOC

<p>200NM</p> <p>13680 15,50€</p> <p>0.36" 50</p>	<p>175NM</p> <p>13682 15,50€</p> <p>0.32" 50</p>	<p>150NM</p> <p>13684 15,50€</p> <p>0.28" 50</p>	<p>160NM</p> <p>13683 15,50€</p> <p>0.30" 50</p>	<p>135NM</p> <p>13685 15,50€</p> <p>0.25" 5 50 1500</p>	<p>110NM</p> <p>13687 15,50€</p> <p>0.22" 5 50 1500</p>	<p>90NM</p> <p>13689 15,30€</p> <p>0.20" 5 50 1500</p>
--	--	--	--	---	---	--

## BAR D'EXTENSION A CHOC

<p>12937 9,50€</p> <p>0.11" 10 100 1500</p> <p>50mm</p>	<p>12074 11,50€</p> <p>0.23" 10 60</p> <p>125mm</p>	<p>12075 15,50€</p> <p>0.45" 10 50</p> <p>250mm</p>
---	---	---

## CARDAN POUR DOUILLES A CHOC 3/4" - 1/2"

<p>11938 47,00€</p> <p>0.62" 6 30</p> <p>3/4"</p>	<p>11990 15,30€</p> <p>0.15" 10 100 100</p> <p>1/2"</p>
---	---

## JEUX DE 3 ARTICULATIONS DE CHOC AVEC DOUBLE POSITION (FIXE/ARTICULE)

<p>53043 53,00€</p> <p>0.43" 5 50 1000</p> <p>1/2" 3/8" 1/4" 3 PCS</p>
--



## JEU DE 8 DOUILLES À CHOC HEX. AVEC DOUBLE POSITION (FIXE/ARTICULÉ)

53044 121,00€

2,43 - 8 1000



1/2"

8  
PCS

13, 14, 15, 16, 17,  
19, 21, 22mm

## JEU DE 6 DOUILLES XZN DE 1/2" À CHOC

52546 39,60€

0,80 5 10 720



1/2"

6  
PCS

REF.	mm	Kg	Sub	ff	€
12931	43mmL	0,08			7,50€
12932	43mmL	0,08			7,50€
12933	43mmL	0,08			8,00€
12934	78mmL	0,08			7,50€
12935	78mmL	0,08			8,00€
12936	78mmL	0,08			8,50€



## DOUILLE POINTE XZN INVIOLENT

52810 9,00€

0,20 5 100 -



M16



1/2"

75mm



- Douille à choc carré 75 mm de long et 1/2" pour l'extraction du boulon de drainage avec pistolet d'impact sur les transmissions de véhicules VAG, Porsche, Ford, etc.

52811 9,90€

0,15 5 100 -



M18

- Pour l'extraction du bras de direction sur les modèles de véhicules du groupe VAG.



## JEU DE 13 DOUILLES À CHOC DE 1/2" 6 PANS ET TORX

52344 197,00€

1,45 - 10 600



1/2"

13  
PCS

### CONTIENT

	x5	45mmL	5, 6, 8, 10, 12mm
	x8	45mmL	T30, T40, T45, T50, T55, T60, T70, T80



## JEU DE 8 DOUILLES À CHOC 6 PANS DE 1/2"

52339 61,00€

1,25 5 10 360



### PIÈCES DE RECHANGE DISPONIBLES

REF.	mm	Kg	Sub	ff	€
14004	5mm	0,1	10	240	9,50€
14005	6mm	0,1	10	120	10,50€
14006	7mm	0,1	10	240	9,50€
14007	8mm	0,2	10	240	9,50€
14008	10mm	0,1	10	240	9,50€
14009	12mm	0,1	10	240	9,50€
14010	14mm	0,1	10	120	11,00€
14011	17mm	0,2	10	60	11,00€



1/2"

8  
PCS

5, 6, 7, 8, 10, 12, 14,  
17mm (78mmL)

## JEU DE 8 DOUILLES À CHOC TORX DE 1/2"

52340 58,00€

1,15 5 10 360



### PIÈCES DE RECHANGE DISPONIBLES

REF.	mm	Kg	Sub	ff	€
12938	T25	0,08	10	50	10,00€
12939	T30	0,09	10	50	10,00€
12940	T40	0,09	10	50	10,00€
12941	T45	0,09	10	50	10,00€
12942	T50	0,09	10	60	10,00€
12943	T55	0,1	10	50	10,00€
12944	T60	0,12	10	50	10,00€
12945	T70	0,14	10	20	10,50€



1/2"

8  
PCS

T25, T30, T40, T45, T50,  
T55, T60, T70 (78mmL)

## KIT DE 6 TÊTES À PERCUSSION

53743 39,70€

0.80	5	20	960
Kg	Sub	ft	



6  
PCS

M	F
3/4"	1/2"
1/2"	3/4"
3/8"	1/4"
1/4"	3/8"
1/2"	3/8"
3/8"	1/2"



### PIÈCES DE RECHANGE DISPONIBLES

REF.	mm	Kg	Sub	ft	€
14749	1/4" F - 3/8" M	-	20	100	2,00€
14750	3/8" M - 1/4" F	-	20	100	2,00€
14751	3/8" F - 1/2" M	-	20	100	4,00€
14752	1/2" F - 3/8" M	-	10	100	4,00€

## JEU DE 2 RÉDUCTEURS À CHOC 1"-1/2"

52545 177,00€

3.00	1	4	1500
Kg	Sub	ft	



1" 1/2" F - 1" M  
1" F - 1" 1/2" M

## KIT DE 8 TÊTES HEXAGONALES DE BATTAGE HAUTE TAILLE 3/4"

53470 176,00€

7.50	-	1	85
Kg	Sub	ft	



3/4"

8  
PCS

24, 27, 29, 30, 32, 34, 36, 38mm (90mmL)



## JEU DE 6 RÉDUCTEURS À CHOC

52544 93,00€

2.90	-	4	384
Kg	Sub	ft	

6  
PCS

1"

3/4"

1/2"

### CONTIENT

1/2"	x2	H x 1" M (50mmL), H x 3/4" M (48mmL)
3/4"	x2	H x 1" M (63mmL), H x 1/2" M (85mmL)
1"	x2	H x 3/4" M (69mmL), H x 1/2" M (70mmL)



### PIÈCES DE RECHANGE DISPONIBLES

REF.	mm	Kg	Sub	ft	€
11962	1/2" H - 3/4" M	0,16	10	100	7,50€
11963	1/2" H - 1" M	0,26	6	54	9,00€
11964	3/4" H - 1/2" M	0,34	6	36	12,50€
11965	3/4" H - 1" M	0,44	6	48	16,00€
11966	1" H - 1/2" M	0,53	6	36	18,00€
11967	1" H - 3/4" M	0,53	4	36	18,00€



## JEU DE 8 DOUILLES À CHOC 6 PANS DE 3/4"

52347 158,00€

6.25	-	4	200
Kg	Sub	ft	



3/4"

8  
PCS

26, 27, 29, 30, 32, 35, 36, 38mm (90mmL)



## JEU DE 16 POINTES À CHOC 3/4"

51028 163,00€

6.25	-	2	-
Kg	Sub	ft	

3/4"

16  
PCS

### CONTIENT

	3/4"	x4	E18, E20, E22, E24
	3/4"	x5	T60, T70, T80, T90, T100
	3/4"	x4	H17, H19, H22, H24
	1" - 3/4"	x2	
		x1	4mm



## JEU DE 8 DOUILLES À CHOC 6 PANS DE 1"

52348 179,00€

5.85	-	2	252
Kg	Sub	ft	



1"

8  
PCS

24, 27, 30, 32, 33, 36, 38, 41mm



### PIÈCES DE RECHANGE DISPONIBLES

REF.	mm	Kg	Sub	ft	€
13859	24mm	0,6	6	96	16,00€
13874	27mm	0,6	6	72	17,50€
13875	30mm	0,5	6	18	18,50€
13876	32mm	0,6	6	24	18,50€
13877	33mm	0,6	6	96	18,50€
11153	36mm	0,7	6	18	23,40€
11155	38mm	0,9	6	12	24,40€
11158	41mm	0,95	6	18	28,50€



### PIÈCES DE RECHANGE DISPONIBLES

REF.	mm	Kg	Sub	ft	€
14723	H17	0,35	-	10	18,00€
14724	T60	0,30	-	10	18,50€
14725	T70	0,30	-	10	18,50€
14726	T80	0,30	-	10	17,50€



# DOUILLES D'IMPACT



REF.	mm	Kg	500	1000	€
11153	36mm	0,71	6	18	23,40€
11154	37mm	0,73	6	24	21,70€
11155	38mm	0,74	6	12	24,40€
11156	39mm	0,74	6	24	28,90€
11157	40mm	0,78	6	12	26,60€
11158	41mm	0,81	6	18	28,50€
11159	42mm	0,91	6	18	30,30€
11160	43mm	0,94	6	12	27,00€
11161	44mm	0,93	6	18	32,30€
11162	45mm	0,94	4	8	29,10€
11163	46mm	1,00	4	12	32,70€
11164	47mm	1,02	4	8	30,70€
11165	48mm	1,01	4	8	34,60€
11166	50mm	1,18	4	12	30,90€
11167	51mm	1,18	4	8	38,00€
11168	52mm	1,18	1	10	41,00€
11169	53mm	1,27	4	12	39,20€
11170	54mm	1,33	4	12	40,00€
11171	55mm	1,44	2	8	51,00€
11172	56mm	1,47	4	8	48,00€
11173	57mm	1,44	4	8	47,00€
11174	58mm	1,58	4	8	47,00€
11175	59mm	1,58	4	8	49,00€
11176	60mm	1,62	2	4	56,00€
11177	62mm	1,63	2	4	55,00€
11178	63mm	1,75	-	8	53,00€
11179	65mm	1,87	2	8	65,00€
11180	67mm	1,93	2	8	59,00€
11181	68mm	1,93	2	8	65,00€
11182	70mm	2,09	2	4	73,00€
11183	71mm	3,10	-	6	70,00€
11184	73mm	3,27	-	4	87,00€
11185	75mm	3,34	1	6	97,00€
11186	76mm	3,70	-	5	91,00€
11187	78mm	3,47	-	5	98,00€
11188	80mm	3,69	1	4	103,00€
11189	85mm	3,81	1	4	121,00€
11190	89mm	3,80	-	2	138,00€
11191	90mm	4,29	1	4	149,00€
11192	92mm	4,50	1	2	152,00€
11193	95mm	4,89	-	2	183,00€
11194	100mm	4,36	1	4	176,00€
11621	105mm	7,81	1	2	359,00€
11622	110mm	7,75	1	2	399,00€
11623	115mm	8,21	1	2	489,00€



REF.	mm	Kg	500	1000	€
14728	10mm	0,10	5	20	3,80€
14729	11mm	0,05	5	20	3,80€
14730	12mm	0,05	5	20	3,80€
14731	13mm	0,10	5	20	3,80€
14732	14mm	0,10	5	20	3,80€
11195	17mm	0,10	10	50	3,70€
11121	19mm	0,10	10	60	4,10€
14733	21mm	0,10	5	20	4,30€
14734	22mm	0,15	5	20	5,40€
11122	24mm	0,14	10	20	5,45€
11123	27mm	0,17	10	50	6,50€
11124	30mm	0,20	10	50	7,65€
11125	32mm	0,22	10	50	8,50€



REF.	mm	Kg	500	1000	€
11126	19mm	0,25	6	60	11,20€
11127	21mm	0,29	6	24	13,80€
11128	22mm	0,34	6	24	14,10€
11129	24mm	0,32	6	54	14,10€
11130	25mm	0,33	6	24	13,10€
11131	26mm	0,32	6	36	14,10€
11132	27mm	0,35	6	54	13,70€
11133	28mm	0,40	6	12	12,00€
11134	30mm	0,41	6	24	15,00€
11135	32mm	0,44	6	48	17,20€
11136	33mm	0,47	6	12	15,30€
11137	34mm	0,51	6	24	18,20€
11138	35mm	0,49	6	12	18,00€
11139	36mm	0,52	6	24	18,80€
11140	38mm	0,53	6	24	20,40€
11141	40mm	0,54	6	12	18,60€
11142	41mm	0,61	6	12	21,30€
11143	46mm	0,74	6	18	26,40€
11144	50mm	1,00	6	24	33,30€
11145	51mm	1,10	4	12	35,30€
11146	55mm	1,23	4	12	37,30€
11147	57mm	1,23	4	12	41,00€
11148	60mm	1,40	4	12	47,00€
11149	63mm	1,32	4	12	45,00€
11150	65mm	1,50	1	8	55,00€
11151	67mm	1,49	4	12	57,00€
11152	70mm	1,49	4	12	57,00€



REF.	mm	Kg	500	1000	€
11624	65mm	2,42	1	2	189,00€
11625	85mm	5,11	1	2	282,00€
12984	105mm	4,8	1	2	379,00€



REF.	mm	Kg	500	1000	€
14738	10mm	-	10	100	5,50€
14739	11mm	-	10	100	5,50€
14740	12mm	-	10	100	5,55€
14741	13mm	-	10	100	5,55€
14742	14mm	-	10	100	5,55€
14743	16mm	-	10	100	5,15€
14744	17mm	-	10	50	5,35€
14745	19mm	-	10	50	6,25€
14746	21mm	-	10	50	6,40€
14747	22mm	-	10	50	7,10€
14748	24mm	-	10	50	8,30€
11613	27mm	0,34	10	20	11,00€
11614	30mm	0,42	10	40	13,00€
11615	32mm	0,38	6	24	14,20€
11616	33mm	0,45	6	12	18,10€
11617	34mm	0,40	6	24	18,70€
11618	35mm	0,46	6	18	18,80€
11619	36mm	0,47	6	36	19,50€

LARGES

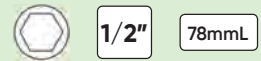

REF.	mm	Kg	500	1000	€
12061	10mm	0,14	10	100	9,50€
14736	11mm	0,15	5	20	5,00€
12062	12mm	0,15	10	100	9,50€
12063	13mm	0,13	10	50	9,50€
14737	14mm	0,15	5	20	5,00€
12064	15mm	0,17	10	100	9,00€
12065	16mm	0,16	10	20	9,00€
12066	17mm	0,18	10	50	9,00€
12067	18mm	0,23	10	20	9,50€
12068	19mm	0,21	10	50	9,50€
12069	21mm	0,24	10	50	9,50€
12070	22mm	0,28	10	20	10,50€
12071	24mm	0,30	10	50	11,00€
12072	27mm	0,35	10	20	12,00€

LARGES



REF.	mm	Kg	500	1000	€
13723	19mm	0,41	6	12	18,50€
13724	21mm	0,48	6	12	19,20€
13725	22mm	0,61	6	18	19,20€
13726	24mm	0,56	6	24	19,00€
13727	26mm	0,51	6	18	18,70€
13728	27mm	0,50	6	18	18,50€
13729	29mm	0,71	6	12	22,00€
13730	30mm	0,68	6	24	22,00€
13731	32mm	0,71	6	24	21,60€
13732	33mm	0,78	5	15	23,80€
13733	34mm	0,81	6	18	24,90€
13734	35mm	0,80	6	18	25,70€
13735	36mm	0,81	6	12	25,80€
13736	38mm	0,83	6	18	25,90€

LARGES



REF.	mm	Kg	500	1000	€
13745	28mm	0,77	6	24	25,20€
13746	30mm	0,95	6	12	25,40€
13747	32mm	0,90	6	12	25,40€
13748	33mm	0,89	6	12	24,90€

EXTRALARGES



## DOUILLE MOYEUR CAMION BPW

**52914** 223,00€

2,90 - 4 500



- Extraction moyeux essieux arrière BPW.



120mm

8 PANS

CARRÉ HEXAGONAL 41mm

## DOUILLE MOYEUR CAMION BPW

**52915** 199,00€

2,90 - 8 1500



- Extraction moyeux essieux arrière BPW.



111mm

OVAL

CARRÉ HEXAGONAL 41mm

## DOUILLE MOYEUR CAMION BPW

**52916** 218,00€

2,57 - 6 1000



- Extraction moyeux essieux arrière BPW.



109mm

8 PANS

CARRÉ HEXAGONAL 41mm

## DOUILLE EXTRACTION MOYEUR CAMION BPW

**52917** 122,00€

1,05 - 10 1000



- Extraction essieux tracteurs 6,5-9 TN.



65mm

OVAL

CARRÉ HEXAGONAL 36mm

## ENJOLIVEURS ARBRE ARRIERE PRISE BPW

**52918** 146,00€

2,05 - 8 1500



- Extraction moyeux essieux arrière BPW.



95mm

CARRÉ 3/4"

## PRISE D'ECROU DE ROUE BPW

**52919** 181,00€

2,65 - 8 1500



- Extraction axe arrière BPW.



110mm

8 PANS

CARRÉ 3/4"

## DOUILLE ÉCROU EXTRACTION ESSIEUX BPW

**52920** 155,00€

1,35 - 10 1000



- Essieux BPW 12 TN.



80mm

CARRÉ 3/4"

## DOUILLE ÉCROU EXTRACTION ESSIEUX BPW

**52921** 117,00€

0,73 - 10 500



- Essieux BPW 6,5-9 TN.



65mm

CARRÉ 3/4"

## DOUILLE EXTRACTION ÉCROU ESSIEUX BPW

**52922** 180,00€

2,10 - 10 1000



- Essieux BPW 16 TN.



85mm

6 PANS

CARRÉ 3/4"

## DOUILLE ÉCROU EXTRACTION AMORTISSEURS SCANIA

**52923** 59,00€

0,55 - 12 1500



28x37mm

CARRÉ 3/4"

## DOUILLE ÉCROU EXTRACTION AMORTISSEURS SCANIA

**52924** 52,00€

0.75	-	24	1500
Kg	Sub	ff	ff

34x46mm

CARRÉ 3/4"



## DOUILLE ÉCROU EXTRACTION SCANIA

**52925** 176,00€

1.80	-	10	1500
Kg	Sub	ff	ff

80mm 8 PANS

CARRÉ HEXAGONAL 41mm

- Extraction essieux avant.



## DOUILLE ÉCROU EXTRACTION ROUE SCANIA

**52926** 201,00€

2.75	-	8	1500
Kg	Sub	ff	ff

100mm 8 PANS

CARRÉ 3/4"

- Extraction écrou essieux arrière.



## DOUILLE ÉCROU EXTRACTION AMORTISSEURS SCANIA

**52927** 59,00€

0.78	-	20	1000
Kg	Sub	ff	ff

34x56mm

CARRÉ 3/4"



## DOUILLE MOYEURS SCANIA

**52928** 172,00€

1.90	-	10	1500
Kg	Sub	ff	ff

80mm 8 PANS

CARRÉ 3/4"

- Extraction moyeux essieux avant.



## DOUILLE ÉCROU ROUE SCANIA

**52929** 185,00€

2.68	-	6	1500
Kg	Sub	ff	ff

95mm 8 PANS

CARRÉ 3/4"

- Extraction écrou moyeux 3 eme essieux de camion 10 essieux.



## DISPOSITIF D'INSTALLATION VILEBREQUIN SCANIA

**52930** 117,00€

2.86	-	4	1500
Kg	Sub	ff	ff

SCANIA 310/320

BAGUES D'ÉTANCHÉITE 0366303-R



## DOUILLES À ERGOTS SCANIA

**52931** 45,00€

0.23	-	10	500
Kg	Sub	ff	ff

CARRÉ 1/2"



## DOUILLE À IMPACT INJECTION ÉLECTROMAGNÉTIQUE SCANIA

**52932** 45,00€

0.47	-	20	1500
Kg	Sub	ff	ff

Ø 38mm

CARRÉ 1/2"



## DOUILLE À ERGOTS POUR ROTULE SCANIA

**52933** 194,00€

3.15	-	6	504
Kg	Sub	ff	ff

SCANIA 420

8 ERGOTS

CARRÉ 3/4"

Ø Extérieur: 11,6cm  
Ø Intérieur: 10cm



# OUTILLAGES POIDS-LOURDS

## DOUILLE ESSIEU IVECO

**53430** 286,00€

- Utilisé avec une douille ou une clé de 36 mm.

2,95 - 8 280  
Kg SUB ff

Ø Extérieur: 134mm  
Ø Intérieur: 110,5mm  
IVECO  
12 PANS  
118x134mm



## DOUILLES POUR ÉCROU DE MOYEU

**52935** 94,00€

0,91 - 10 1000  
Kg SUB ff

60mm CARRÉ 3/4"



## DOUILLES À ERGOTS EXTRACTION BAGUE

**52936** 199,00€

- Pour furgons.

1,58 - 10 1500  
Kg SUB ff

80-95mm 6 ERGOTS  
CARRÉ 3/4"



## DOUILLE À ERGOTS EXTRACTION BAGUE ARRIÈRE

**52937** 265,00€

- Extraction bague axe arrière.

3,05 - 6 1500  
Kg SUB ff

95-115mm 6 ERGOTS  
CARRÉ 3/4"



## DOUILLE D'EXTRACTION ÉCROU DE DIRECTION CAMION

**52938** 199,00€

- Pour extraction de la douille de l'axe de direction.

3,22 - 6 1500  
Kg SUB ff

100mm 6 ERGOTS  
CARRÉ 3/4"



## DOUILLE D'EXTRACTION VALVE D'INJECTION MAN / BENZ / SCANIA

**52939** 28,00€

0,20 - 30 1500  
Kg SUB ff

22-28mm 4 ERGOTS  
CARRÉ 3/4"  
DIESEL



## DOUILLE CAMION BENZ / MAN POUR ÉCROU DIFFÉRENTIEL ARRIÈRE

**52940** 235,00€

4,34 - 4 1500  
Kg SUB ff

101mm 6 ERGOTS  
CARRÉ 3/4"



## DISPOSITIF POUR L'ALIGNEMENT DU VILEBREQUIN

**52941** 70,00€

- Pour Benz de 6, 8 et 10 cylindres.  
- Pour MAN de 12 cylindres.

0,54 - 20 1500  
Kg SUB ff

CARRÉ 1/2"



## DISPOSITIF POUR L'ALIGNEMENT DU VILEBREQUIN

**52942** 105,00€

- Pour Mercedes Actros et Atego.  
- Pour MAN de 5,6 et 8 cylindres.

0,87 - 20 960  
Kg SUB ff

CARRÉ 1/2"



## DISPOSITIF DE ROTATION DU VOLANT POUR MOTEUR MAN

**52943** 75,00€

0,49 - 30 1500  
Kg SUB ff

CARRÉ 1/2"



## EXTRACTOR DE MOYEU CAMIONS ET VEHICULES COMMERCIAUX

**52944** 110,00€

1,00 - 20 1500  
Kg SUB ff

30mm  
CARRÉ HEXAGONAL 19mm



## EXTRACTOR DE MOYEU CAMIONS ET VEHICULES COMMERCIAUX

**52945** 281,00€

2,74 - 24 960  
Kg SUB ff

39mm  
CARRÉ HEXAGONAL 26mm



## DOUILLES POUR ÉCROU DE MOYEU

**52934** 102,00€

1,05 - 12 1000  
Kg SUB ff

56mm  
CARRÉ 3/4"





# **CARROSSERIE**

- 160 POUR CARROSSERIE
- 161 POUR PHARES
- 162 CASQUES POUR SOUDURES / SET DE LEVIERS
- 163 JEU POUR OUVRIR LES VOITURES / REMPLACEMENT DE PARE-BRISE
- 164 TENAILLES
- 166 PISTOLET À COLLE / VENTOUSES
- 167 RUBAN DE FIXATION / SERVANTE ET STOCKAGE
- 168 CHANDELLES / SUPPORTS
- 170 MAINTIEN DU VÉHICULE / PRÉSENTOIRS
- 171 TIPS DE SOL
- 172 PLATE-FORME EN ALUMINIUM

## SET DE RÉPARATION POUR BOSSELLEMENT

53224 142,00€

32  
PCS

AUDI

3,90	-	5	35
Kg	sub	ff	

- 1 pistolet à colle (220-240 ~, 50Hz, 40W).
- 1 marteau de glissement pour enlever les bosses importantes.
- 1 appareil de levage pour les bosses plus petites sur des surfaces planes.
- 1 produit nettoyant.
- 1 raclette.
- 8 barres de colle noire (11 x 200 mm).
- 19 languettes pour colle dans différentes tailles et formes.



### PIÈCES DE RECHANGE DISPONIBLES

REF.	DESCRIPTION	Kg	sub	ff	€
13842	Sac de 5 disques bleus	0,15	10	100	8,50€
13843	Sac de 4 disques jaunes	0,1	10	100	7,00€
13844	Sac de 10 disques rouges	0,3	10	50	9,00€
13845	Jeux de 5 tubes de colle	0,02	10	100	8,00€



13842



13843



13844



13845

## MIROIR D'INSPECTION DES FOSSES

53486 29,30€

0,30	10	40	160
Kg	sub	ff	

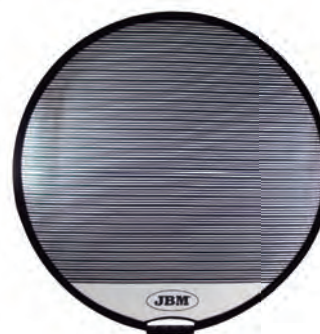
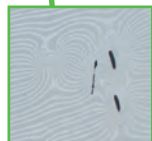

Ø 800mm

## COFFRET A FRAPPER

Permettent d'appliquer un marquage numérique ou alphabétique sur toute surface métallique par indentation ou méthode d'impact. La zone de travail arrondie empêche les fissures ou les fractures sur la surface traitée.

### LETTRES ET CHIFFRES

52422 24,70€

0,82	3	6	540
Kg	sub	ff	



5mm

A-Z & 0-9

53119 52,00€

1,94	3	6	504
Kg	sub	ff	



8mm

A-Z & 0-9

### CHIFFRES

52882 14,00€

0,30	10	60	1500
Kg	sub	ff	

1/4"

9  
PCS



6mm

0-8

## COFFRET TAS POUR CARROSSIER

52876 182,00€

3,13	-	6	84
Kg	sub	ff	



RECOUVERTS  
DE PLASTIQUE



12959



12955



12956



12957



12958

7  
PCS

### PIÈCES DE RECHANGE DISPONIBLES

REF.	DESCRIPTION	Kg	sub	ff	€
12955	Double tas de carrossier	0,29	-	25 99	27,80€
12956	Tas de carrossier rectangle	0,31	-	25 99	27,80€
12957	Tas de carrossier courbure	0,37	5	25 99	27,80€
12958	Tas de carrossier façon hachette	0,41	-	25 -	27,80€
12959	Tas de carrossier épinçoir	0,3	5	25 99	27,80€
12960	Tas de carrossier talon	0,18	-	25 1500	27,80€
12961	Tas de carrossier épinçoir avec manche	0,34	-	25 -	27,80€



## KIT DE RESTAURATION DES PHARES

53673

80,00€

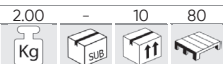

- Le kit de réparation de phares en polymère liquide est un système innovateur qui permet de restaurer les phares grillés jusqu'à leur état d'origine, avec une brillance d'origine et une apparence idéale, de manière rapide et économique.

- Pièces incluses:  
 Récipient avec liquide 600 ml  
 6 feuilles de papier abrasif  
 Papier texturé  
 Entonnoir en plastique  
 Couvercle courbé avec bague d'étanchéité en caoutchouc  
 Couvercle plat avec bague d'étanchéité en caoutchouc  
 Adaptateur ca-cc  
 Adaptateur 12v  
 Tasse d'évaporation  
 Plaque de rodage



15375

28,00€

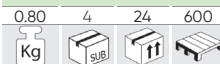

RÉCIPIENT AVEC LIQUIDE 600ml

Le kit de réparation de phares en polymère liquide est un système innovateur qui permet de restaurer les phares grillés jusqu'à leur état d'origine, avec une brillance d'origine et une apparence idéale.

BRILLANCE D'ORIGINE ET UNE APPARENCE IDÉALE



### PIÈCES DE RECHANGE

REF.	DESCRIPTION	Kg	Sub	Unit	€	REF.	DESCRIPTION	Kg	Sub	Unit	€	REF.	DESCRIPTION	Kg	Sub	Unit	€
14564	Kit de 6 papiers émeris 0,10	10	100	9,20€	14568	Couvercle courbé avec bague d'étanchéité en caoutchouc	0,1	10	200	9,20€	14571	Plaque de rodage	0,05	-	100	9,20€	
14565	Adaptateur ca-cc	0,20	10	50	26,70€	14569	Couvercle plat avec bague d'étanchéité en caoutchouc	0,1	10	200	9,20€	14573	Papier texturé	0,70	10	100	4,05€
14566	Adaptateur 12v	0,05	10	100	16,70€	14570	Entonnoir	0,01	10	200	4,05€	15375	Récipient avec liquide 600ml	0,01	4	24	28,00€
14567	Tasse d'évaporation	0,15	10	20	38,00€												



### KIT DE 10 ÉLÉMENTS DE PAPIER ABRASIF

GRAIN 180	GRAIN 280	GRAIN 360	GRAIN 600	GRAIN 800	GRAIN 1200
14710 0.25 3,50€ Kg	14711 0.20 3,75€ Kg	14712 0.20 4,00€ Kg	14713 0.15 4,25€ Kg	14714 0.15 4,50€ Kg	14715 0.10 4,75€ Kg

## COFFRET CARROSSIER POUR DÉBOSELAGE

51131

61,00€



7 PCS



### PIÈCES DE RECHANGE DISPONIBLES

REF.	DESCRIPTION	Kg	Sub	Unit	€	11544	Utility dolly	0,69	5	25	7,00€
11541	Bumping hammer	0,43	5	25	11,00€	11545	Shrinking dolly	0,79	5	25	11,00€
11542	Reverse curve hammer	0,38	5	25	11,00€	11546	Double end dolly	0,81	5	25	12,00€
11543	Pick and finish hammer	0,42	5	25	11,00€	11547	Curve dolly	0,81	5	25	12,00€

## KIT DE RESTAURATION DE PHARES

53626

18,00€



- Le kit est conçu pour restaurer la transparence de verres optiques jaunés ou atténués des phares.  
 - Le kit de restauration de verres des phares augmente leur efficacité.  
 - Trois simples étapes: meulage, polissage et protection.  
 - Restaure les feux avant, arrière, antibrouillard ou les indicateurs de direction.  
 - Ce kit est conçu pour restaurer 2 phares.



- Complétez:  
 2x roues d'émeri P800.  
 2x roues d'émeri P1200.  
 2x roues d'émeri P2000.  
 1x 85 g de pâte à polir.  
 2x 3,0 ml de liquide de protection UV.  
 1x ruban adhésif.  
 1x roue à polir en laine.  
 1x disque éponge blanc.  
 1x buse, filetage M10.  
 2x adaptateur (3/8" et 1/4").

PRÉSENTOIR DE 12 UNITÉS

### PIÈCES DE RECHANGE DISPONIBLES

REF.	DESCRIPTION	Kg	Sub	Unit	€
14286	Coussinet spongieux doux	1,95	-	200	2,99€
14287	Coussinet spongieux dur	2,30	-	200	2,99€
14288	Coussinet de polissage de laine	2,30	10	200	6,00€
14289	Disque velcro	7,40	-	200	6,10€
53646	3" Kit pour la machine de polissage pneumatique	8,95	5	10	62,00€



## SÉRIE 262 SPÉCIALE KIT DE POLISSAGE: MACHINE POLISSAGE PNEUMATIQUE + 12 KIT RESTAURATION PHARES

SERIE262

199,00€

53626



x7

x12

53646

TVA non comprise

JBM / www.jbmfrance.fr

161

## CASQUE À SOUDER AVEC RÉGULATEUR MANUEL

53414 49,00€

0,85	-	6	36
Kg	Sub	ff	ff



## CASQUE À SOUDER AVEC RÉGULATEUR DIGITAL

53415 188,00€

0,95	-	4	40
Kg	Sub	ff	ff



## JEU DE 4 LEVIERS EXTRA LONG

52977 137,00€

8,50	-	1	42
Kg	Sub	ff	ff

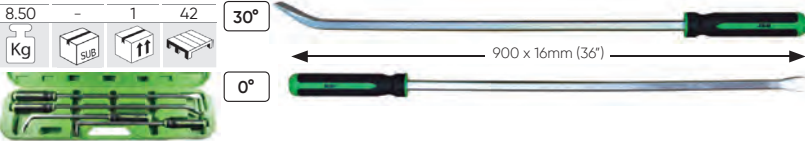

## JEU DE 27 LEVIERS NYLON

52788 39,00€

1,18	27	10	170
Kg	Sub	ff	ff



- Set 27 leviers avec des courbures différentes terminaisons et qui facilitent le travail à l'intérieur et à l'extérieur des véhicules. Sa large gamme vous permet d'utiliser le bon outil pour chaque tâche et la pièce, facilitant le travail dans des endroits difficilement accessibles.

## JEU DE 5 LEVIERS NYLON

50901 16,00€

0,30	5	20	240
Kg	Sub	ff	ff



- Universel
- Avec poignée
- Pour les zones étroites
- Utilisations pratiques
- Tapisserie
- Mesures:

6 x 160mm  
63 x 175 mm  
30 x 200mm  
20 x 180mm  
20 x 215mm



## JEU DE 4 BURINS EN NYLON

51832 18,00€

0,50	12	24	192
Kg	Sub	ff	ff

19x273, 22x273,  
25x273, 38x273mm



## JEU DE 5 LEVIERS COUDES METAL

50903 30,80€

1,90	4	8	200
Kg	Sub	ff	ff

60, 43, 38,  
28, 18cm

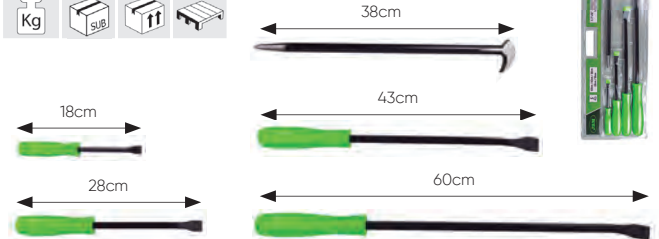

## JEU DE 2 LEVIERS MÉTAL

52026 31,80€

2,04	5	10	240
Kg	Sub	ff	ff

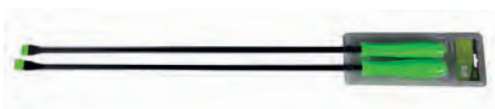

90cm

## PIED DE BICHE

51360 8,05€

0,80	5	20	900
Kg	Sub	ff	ff

18" x 5/8

51361 9,80€

1,46	5	10	500
Kg	Sub	ff	ff

24" x 3/4

FABRIQUÉ EN ACIER



## JEU DE 2 LEVIERS

52851 9,65€

0,35	6	60	600
Kg	Sub	ff	ff



## SET DE 6 LEVIERS

53110 27,30€

1,42	6	12	168
Kg	Sub	ff	ff

5"x8.5 / 5"x10.3  
5"x4.5 / 15"x8.5  
15"x10.3 / 15"x4.5mm

6 PCS

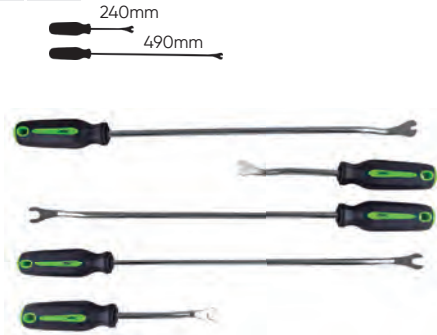

## JEU D'OUTILS POUR OUVRIR LES VOITURES

53230 19,70€

0,65	6	24	288
Kg	Sub	ff	ff



UNIVERSAL

8 PCS

- Coffret à outils spécial pour l'ouverture de véhicules sans clé.
- Composé de cales en plastique, leviers et crochets courbés.
- Contient une clé universelle pour les couvercles de réservoir de carburant.
- Pour utilisation dans les ateliers et les assistances.



## JEU DE 4 COUSSINS GONFLABLES

52077 29,50€

40-50mm

0,35	5	40	400
Kg	Sub	ff	ff

- Contenu: Coussins de 16x16cm, Coussins de 32x12cm, Coussins de 19x6cm, Coussins de 18x4,5cm, Pompe manuel

- En les insérant entre la vitre et le cadre de la portière, ils permettent d'ouvrir le véhicule facilement et sans l'abîmer.

- Pression maximale supportée: 100 kg



POUR REF. 53232

## CÂBLE POUR EXTRACTION PARE-BRIS

13813 7,00€

0,10	10	60	1200
Kg	Sub	ff	ff



## OUTILS POUR EXTRACTION DE VITRES

13814 11,00€

0,20	10	60	1080
Kg	Sub	ff	ff



## OUTILS POUR REMPLACEMENT DE VITRES

53232 39,00€

1,15	-	10	180
Kg	Sub	ff	ff

- Contenu: 1x extracteur de moulures, 1x levier pour extraire la gomme, 1x crochet extracteur.

- 1x 1.8m de câble de coupe.
- 2x poignées pour le câble de coupe.
- 1x passe-câbles.



## CARRÉ MAGNÉTIQUE 45°, 90°, 135°

54111 4,75€

0,35	10	40	1680
Kg	Sub	ff	ff

75mm

54113 7,65€

0,60	10	20	1100
Kg	Sub	ff	ff

100mm



53545 35,70€

0,74	5	20	600
Kg	Sub	ff	ff

8, 10, 12, 13, 14mm

Cr-V BMW, FORD, OPEL, VAG, VAUXHALL

- Permet de régler les câbles du frein de stationnement des véhicules BMW, FORD OPEL, VAG et VAUXHALL.
- Cet outil est utile pour les charnières de porte, les pare-chocs et les feux arrière. Il est également utilisé pour les freins à main.

5 PCS

3/8"



120mmL



TVA non comprise

JBM www.jbmfrance.fr

163

# PINCE À VERROUILLAGE ET MÂCHOIRES

0.90	10	20	300
Kg	sub	ff	ff

## DROITES

**53675** 0.75  
50,00€ Kg

## COURBÉES

**53676** 0.85  
44,00€ Kg

## SUPPORT ROTATIF

**53677** 0.90  
55,00€ Kg

## COURBÉES LONGUES

**53678** 0.90  
52,00€ Kg

10"

REF	←	→
53675	250mm	70mm
53676	250mm	90mm
53677	250mm	80mm
53678	300mm	105mm



PRÉSENTOIR DE 10 UNITÉS

## JEU DE 3 PINCE ETAU EXTRA LONGUES

**52982** 53,00€

1.60	4	8	384
Kg	sub	ff	ff

37cm: pince droite  
36cm: angle 45°  
34cm: angle 90°

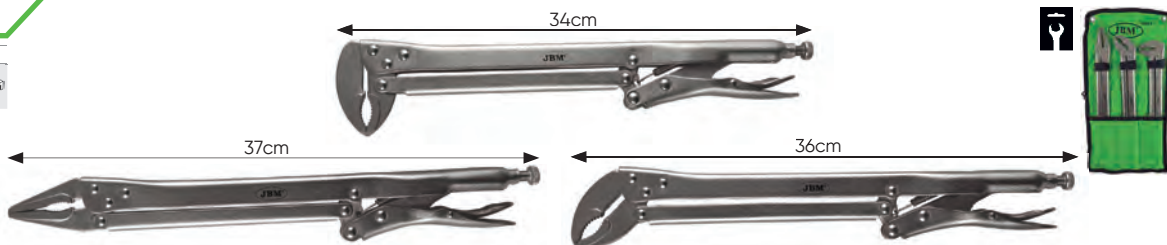

## PINCE ÉTAU

**50577** 12,60€

0.53	5	40	-
Kg	sub	ff	ff

CrV 280mm



## PINCE ÉTAU À BEC PERROQUET

**52386** 23,60€

0.44	10	50	1500
Kg	sub	ff	ff

**52386**  
LISO



**52387**  
DENTADO



**52387** 24,50€

0.44	10	50	1000
Kg	sub	ff	ff

CrMo

215mm

- Prise en 6 différentes mesures de écrou / vis hexagonale.

## SET DE 6 PINCES À ETAU

**52385** 251,00€

3.72	-	6	120
Kg	sub	ff	ff



Type W 195mm

**14103** 32,40€



Type T 215mm

**14104** 32,40€



Type L 225mm

**14105** 32,40€



Type J 210mm

**14106** 32,40€



Type LL 195mm

**14107** 32,40€



Type JJ 195mm

**14108** 32,40€



## PINCE ÉTAU BLOCAGE

**52505** 20,80€

0.27	36	72	2160
Kg	sub	ff	ff

Présentation en coffret



170mm

CrMo

0-40mm

## PINCE ÉTAU MACHOIRES AMOVIBLES

**52506** 16,00€

0.28	36	72	2160
Kg	sub	ff	ff

Présentation en coffret



170mm

CrV

0-50mm

## PINCE ÉTAU POUR SOUDURE MACHOIRES AMOVIBLES

**52512** 50,00€

1.31	-	20	280
Kg	sub	ff	ff

Présentation en coffret



440mm

CrMo

0-210mm

**PINCE ÉTAU POUR SOUDURE****52511** 42,00€

440mm

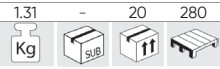
**CrMo**

- Présentation en coffret

**PINCE ÉTAU POUR U ET CORNIÈRES****52507** 30,10€

250mm

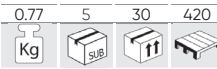
**CrMo**

- Présentation en coffret

**PINCE ÉTAU POUR U ET CORNIÈRES****52504** 27,60€

225mm

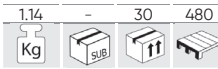
**CrMo**

- Présentation en coffret

**PINCE ÉTAU POUR SOUDURE CHOÏRES AMOVIBLES****52503** 32,50€

280mm

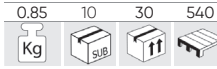
**CrMo**

0-105mm

**PINCE SPECIAL SOUDURE****52390** 35,20€

250mm

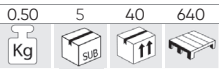
**CrMo****PINCE ÉTAU POUR SOUDURE****52502** 31,40€

280mm

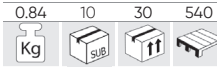
**CrMo****PINCE DE TIRAGE****52477** 70,00€

2T

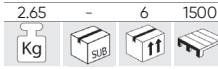

0-60mm

**PINCE DE TIRAGE 90°****52478** 49,00€

5T



0-20mm

**PINCE DE TIRAGE PLATE 90°****52479** 24,70€

3T

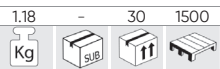

0-20mm

**PINCE DE TIRAGE****52474** 68,00€

6T



0-20mm

**PINCE DE TIRAGE PLATE****52475** 62,00€

3T

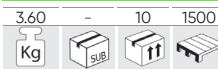

0-25mm

**PINCE DE TIRAGE CARRE****52476** 50,00€

5T

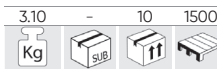

0-25mm

**MINI PINCE DE TIRAGE CARRE 90°****52480** 44,00€

3T

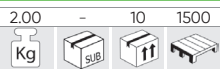

0-25mm

**PINCE DE TIRAGE CARRE****52481** 52,00€

3T



0-20mm

**PINCE DE TIRAGE PLATE ANGLE 45°****52482** 44,00€

5T

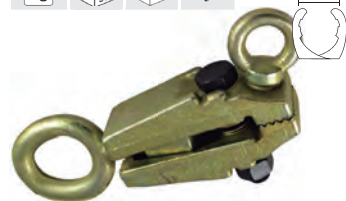

0-10mm

**PINCE DE TIRAGE MINI****52483** 41,00€

3T



0-10mm

**PINCE DE TIRAGE****52487** 63,00€

5T



0-20mm

**UNION CHAÎNES****52484** 66,00€

3T



0-110mm

**UNION CROCHETS****52485** 51,00€

4T



0-90mm

**UNION CHAÎNE CROCHET****52486** 62,00€

3T



0-110mm



## PISTOLET POUR CARTOUCHES

52533 10,00€

0,74	12	24	144
Kg	sub	ff	tbl



9"

300ml



## SERINGUE PNEUMATIQUE POUR GARNISSAGE DES JOINTS

53567 43,00€

1,05	-	10	180
Kg	sub	ff	tbl



- Pression de travail: 2,5-5 BAR.
- Entrée d'air: 1/4".
- Capacité de la cartouche: 310 ml.

310ml



## OUTIL D'ÉTANCHÉITÉ EN SILICONE

54017 12,00€

4,60	5	20	240
Kg	sub	ff	tbl



Ce kit vous permettra de restaurer l'interstice et d'éliminer les résidus de colle, ainsi que d'améliorer le pouvoir adhésif et l'aspect de surface.

- Un grattoir en acier inoxydable enlève le vieil adhésif
- La spatule en silicone élimine les bosses et les enfoncements sur la surface.
- L'outil est bien adapté pour lisser les joints et les lignes d'étanchéité et traitera la plupart des produits en silicone, tous les bords, coins et joints



Le kit comprend cinq cousins de remplacement en silicone (3R, 6R, 10R, 13R, 17R)



Cet outil peut être utilisé pour la maison, la cuisine, la salle de bain, les fenêtres, les raccords d'évier, etc.

## JEU DE 2 MINI VENTOUSES

52295 6,50€

0,15	10	100	1200
Kg	sub	ff	tbl

5KG  
Ø 60mm



## MINI VENTOUSE POUR RETROVISEUR

52589 13,00€

0,28	10	40	640
Kg	sub	ff	tbl



8KG  
Ø 70mm

## VENTOUSE

1 TÊTE

52262 7,50€

0,31	12	48	384
Kg	sub	ff	tbl

40KG  
Ø 115mm



2 TÊTES

52263 13,50€

0,59	6	24	192
Kg	sub	ff	tbl

70KG  
Ø 115mm



3 TÊTES

52264 18,60€

0,92	6	10	100
Kg	sub	ff	tbl

100 KG  
Ø 115mm



4 TÊTES

52265 30,50€

1,24	-	10	100
Kg	sub	ff	tbl

120 KG  
Ø 115mm



## VENTOUSE 2 TÊTES ARTICULES

52765 21,70€

0,72	5	20	80
Kg	sub	ff	tbl

100 KG  
Ø 115mm

- Destiné à l'entretien, l'installation et l'enlèvement des parties du véhicule, à la fois en tôle et de verre.
- Manipulation facile et se conforme à la courbure du potentiel de surface.



## ENSEMBLE DE VENTOUSES ET CLIQUETS

52998 48,00€

2,03	-	8	112
Kg	sub	ff	tbl

80 KG  
Ø 120mm



5m x 25mm

## SANGLE DE FIXATION

**52321** 8,80€

0,35	5	20	1200
Kg	sub	ff	

5m x 25mm

**52327** 12,00€

0,46	5	20	1000
Kg	sub	ff	

8m x 25mm



## PORTE-PIÈCES - PARE-BRISE ET COQUE

**53983** 215,00€ - Disponible pour pare-brise, tôlerie, capots, portes...etc.

1940	-	1	35
Kg	sub	ff	



12 tiges de 630 mm recouvertes de mousse de polyéthylène expansé (EPE)

Jusqu'à 5 grands panneaux ou verres



Roulettes en polyuréthane (PU) 4" x 4" (deux roulettes pivotantes avec frein)

## CHARIOT SPÉCIAL CARROSSERIE

**53125** 477,00€

51,00	-	1	12
Kg	sub	ff	

1.800mm (height) 895mm (width) 585mm (depth)



4x INCLUS

## CHEVALET UNIVERSEL TÉLESCOPIQUE

**53124** 287,00€

21,10	-	1	11
Kg	sub	ff	



HAUTEUR  
↑ 1.320mm  
↓ 840mm

LONGUEUR  
↑ 1.380mm  
↓ 225mm



## CHARIOT CARROSSERIE

**50923** 454,00€

36,40	-	1	18
Kg	sub	ff	

480mm (height) 1300mm (width) 800mm (depth)



- Séparation: 0 à 110cm.



ROUER POUR REF. 50923

**12022** 33,70€

TVA non comprise

## CHEVALET POUR PARE-BRISSES

53080 99,00€

1,130mm 990mm

7.87 Kg 1 28 MESURES PLIÉ

70 KG

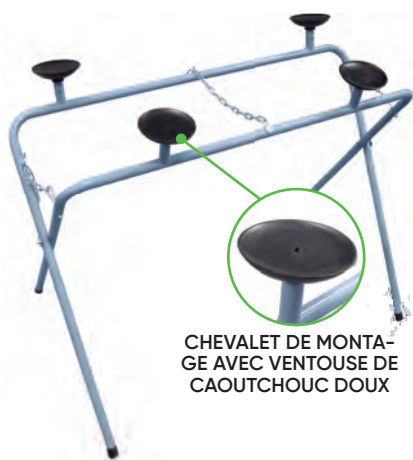

CHEVALET DE MONTAGE AVEC VENTOUSE DE CAOUTCHOUC DOUX

## CHEVALET PLIABLE POUR CARROSSIER

52749 79,00€

80mm 58mm

6.25 Kg 1 31

220 KG



MOUSSE POUR CHEVALET REF. 52749

11959 0.08 100 10,50€ Kg

## CHEVALET EN "X"

53079 89,00€

6.77 Kg 1 44

100 KG

MESURES DÉPLIÉ

660mm

600mm

870mm

ME-

SURES

PLIÉ

1140mm

600mm

300mm



## CHEVALET SUPPORT PARE-CHOC

53736 98,00€

8.10 Kg 1 44

- Idéal pour la fixation des pare-chocs, pour les peindre et les réparer avec plus de confort.
- Ancrage réglable: 75 cm -160cm
- Hauteur maximale: 148cm



L'ANCRAGE RÉGLABLE PERMET QUE LE SUPPORT SOIT ADÉQUAT POUR TENIR DIVERS TYPES ET STYLES DE PARE-CHOC



ACIER

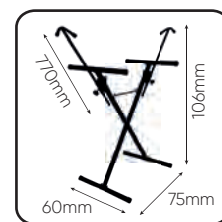

53685 310,00€

14.50 Kg 1 14

1,110mm 760mm 1,340mm

- Supporte n'importe quel pare-chocs sans toucher la surface peinte
- Facilite et accélère les réparations et les peintures.
- Le pivot à 90 degrés permet un accès facile à toutes les surfaces
- Cinq positions de verrouillage différentes
- Quatre roulettes de qualité industrielle, entièrement verrouillables pour plus de stabilité



RÉGLAGE DES BRAS DE SUPPORT DE 134 À 198 cm

ACIER ENDUIT DE POUVRE

4 ROUES DE 4 POUCES (DEUX PIVOTANTES AVEC FREIN)





## SUPPORT ÉLÉMENTS POUR CARROSSERIE

**53134** 144,00€

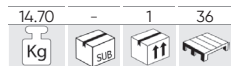

- 6 crochets pour serrer pièces pour peindre ou sécher.
- Cadre ajustable qui s'étend de 127cm à 203cm.

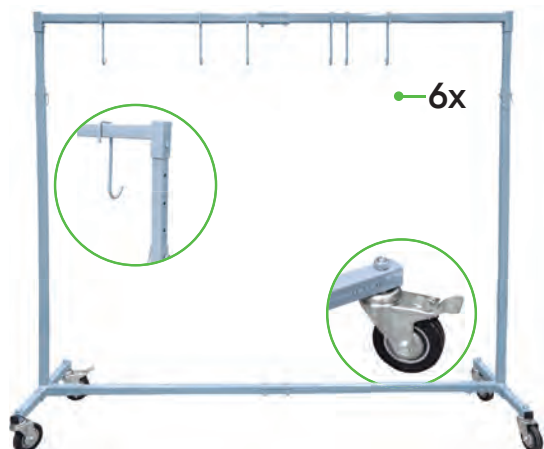

## SUPPORT BASCULANT CARROSSERIE

**53126** 243,00€



- Idéal pour portes, capots voitures, pare-chocs, ailerons, spoilers, etc.



- 6 bras de serrage: 4 avec crochet fixe 2 avec tou.

## PORTE-ROULEAU PAPIER POUR MUR

**53922** 29,00€



- Acier inoxydable
- Rouleau: largeur max. 38 cm
- Pince - plastique ABS,

PAPIER NON INCLUS

- gris.
- Vis et écrous de fixation en acier inoxydable.

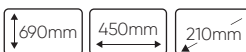
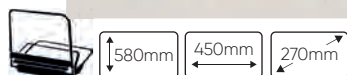

## PORTE-ROULEAU PAPIER

**53921** 39,00€

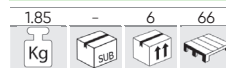

PAPIER NON INCLUS

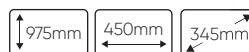

- Matériau: acier inoxydable
- Rouleau: largeur max. 38 cm
- Pince - plastique ABS



## ROULEAU DE HOUSSE DE SIÈGE

MODÈLE CUIDAMOS (ESPAGNOL) / SENSE LATÉRAUX

**51978** 84,00€



25mc 250 u.



MODÈLE ANONYME / SENSE LATÉRAUX

**52244** 84,00€



25mc 250 u.



**25 MICRONS**  
D'ÉPAISSEUR

## KIT PRÉSENTOIR MURAL + CONSOMMABLES D'ENTRETIEN VÉHICULE

COMPOSÉ DE REF.: 52065, 52244, 52057, 52058

**50403** 98,00€



COMPOSÉ DE REF.: 51985, 52244, 52057, 52058, 50409

**50410** 168,00€



COMPOSÉ DE REF.: 51985, 51978, 52057, 52058, 50409

**50400** 168,00€



## PRÉSENTOIR MURAL NU

53705 80,00€

4,90	-	1	28
Kg	Sub	ff	



51985 84,00€

4,85	-	1	28
Kg	Sub	ff	



- Support de tapis de pied.
- Support de housse de siège.
- Couverture de film de poignée de support.

## PRÉSENTOIR MURAL NU POUR BOBINE COUVRE SIÈGE

52065 45,00€

2,19	-	1	77
Kg	Sub	ff	

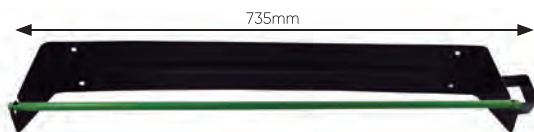

## BOBINE DE FILM COUVRE VOLANT

FILM

52057 6,80€

0,62	-	24	672
Kg	Sub	ff	

- Longueur: 200m
- Largeur: 12,5cm
- Épaisseur: 23mc

MANCHE

52058 4,50€

0,06	-	125	2500
Kg	Sub	ff	



## BOÎTE DE 250 TAPIS PAPIER

50409 26,00€

3,54	-	1	160
Kg	Sub	ff	

UDS PACK



250 U.

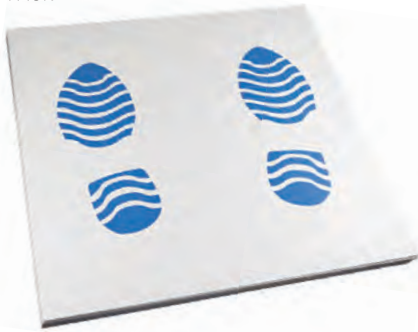

## BOÎTE DE 250 HOUSSES DE VOLANT

51824 36,80€

1,45	-	8	72
Kg	Sub	ff	

250 U.



## KIT DE PROTECTION 5 EN 1

50916 0,88€

0,05	100	400	3200
Kg	Sub	ff	



DISTRIBUTEUR

5in1



20mc

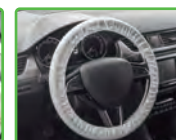
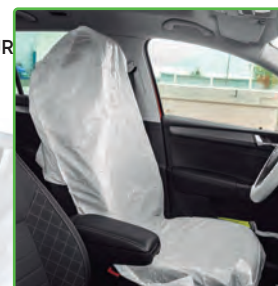

TAPIS DE  
PIED EN  
PAPIER

## PROTECTION POUR SIÈGE DE VOITURE

53226 14,90€

0,20	5	50	600
Kg	Sub	ff	

- Nylon.
- Universel.

51cm	26,5cm	14mm
------	--------	------

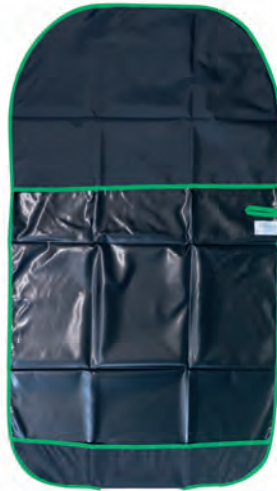

## PROTÈGE AILE AIMANTÉE

51622 25,30€

0,45	-	30	540
Kg	Sub	ff	

110cm	64cm	
-------	------	--



4 POINTS AIMANTÉS

DEUX FACES:  
UNE EN VELOURS,  
UNE PLASTIQUE



## VENTOUSE PNEUMATIQUE POUR CARROSSERIE

52540 221,00€

4,36	-	3	72
Kg	Sub	ff	

- Ventouse avec marteau pneumatique pour enlever les bosses.
- Sa conception permet d'éliminer les bosses de manière rapide et facile.

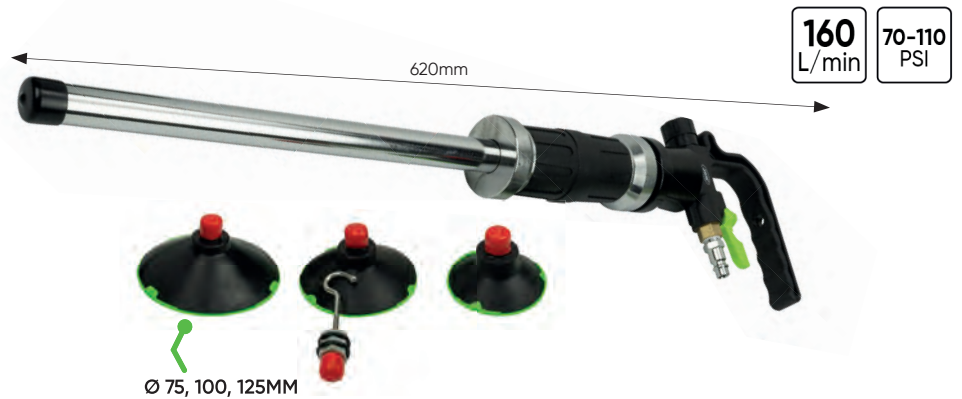

160 L/min	70-110 PSI
-----------	------------

## TAPIS DE SOL

PLIANT

53192 52,00€

0,70	-	2	48
Kg	Sub	ff	

- Mousse EVA.
- Mesures du plié: 20cm x 42cm x 18cm

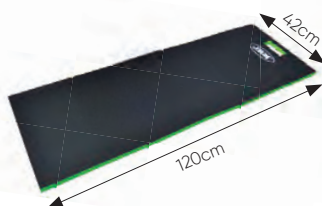

INDIVIDUEL

53191 14,80€

0,15	-	5	140
Kg	Sub	ff	



- Mousse EVA.

32cm	48cm	18mm
------	------	------



TVA non comprise

## PLATE-FORME DE TRAVAIL TÉLESCOPIQUE

52230 398,00€

150 Kg

RENCONTRE AVEC: EN 131

16,75 - 1 14  
Kg SUB

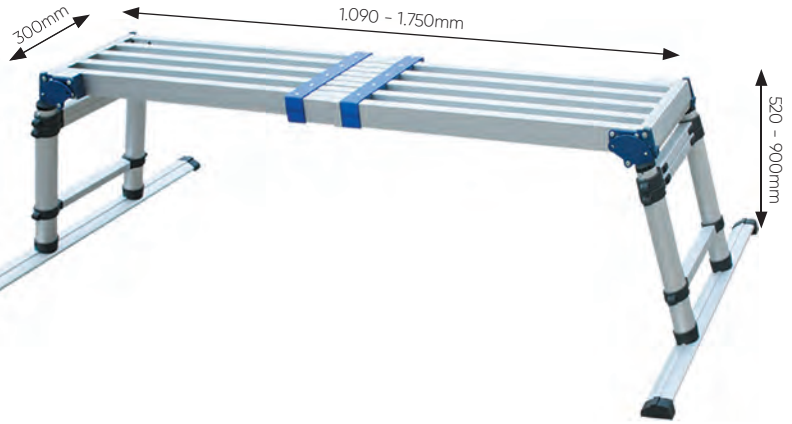

- Largeur: 300mm.
- Longueur plate-forme fermé: 1.090mm.
- Longueur plate-forme étendue: 1.750mm.
- Hauteur réglable de la plate-forme: 520-900mm.
- Largeur des marches: 40mm.
- Distance entre les échelons: 250mm.

- **Positions: 42** (14 en horizontales x 3 en verticale)  
Hauteur 1: 520mm.  
Hauteur 2: 700mm.  
Hauteur 3: 900mm.



SUPER LÉGÈRE

PLIANTE



MONTAGE FACILE

PIED DE RECHANGE POUR  
PLATE-FORME REF. 52230

10966 0,06 1  
13,50€ Kg

MARCHES DE RECHANGE  
POUR PLATE-FORME REF.  
52230

10965 0,01 1  
6,00€ Kg

RECHANGE POUR  
PLATE-FORME REF.  
52230

10964 0,01 1  
9,00€ Kg

## PLATE-FORME DE TRAVAIL EN ALUMINIUM

50913 195,00€

100 Kg

RENCONTRE AVEC: EN 131

6,50 - 1 20  
Kg SUB

800mm 1.400mm 300mm



## JEU DE 2 PLATE-FORME DE TRAVAIL EN ALUMINIUM

50656 290,00€

100 Kg

RENCONTRE AVEC: EN 131

10,45 - 1 8  
Kg SUB

PLATE-FORME DE TRAVAIL EN ALUMINIUM

15552 181,00€ 550mm 1.300mm 300mm

11897 155,00€ 300mm 1.000mm 300mm

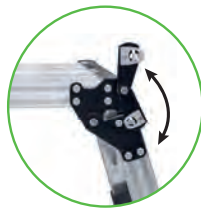

172



## **FREINS**

- 176 REPOUSSE PISTON DE FREIN
- 178 RÉPARATION /MAINTIEN  
/ PURGEUR DE FREIN

## PISTOLET REPOUSSE PISTON FREINS PROFIL BAS

53683 116,00€

1.45	5	10	100
Kg	sub	ff	ff

- Pression normale d'usage: 5-8 bar.
- Pression maximale de travail: 14 bar.



## PISTOLET REPOUSSE PISTON FREINS PNEUMATIQUE

51283 78,00€

1.33	-	10	200
Kg	sub	ff	ff

- Pression normale d'usage: 5-8 bar.
- Pression maximale de travail: 14 bar.



## COFFRET REPOUSSE PISTON AVEC PISTOLET PNEUMATIQUE

52636 114,00€

3.16	-	5	90
Kg	sub	ff	ff

16  
PCS

0: GM most 2-1/2" diamètre des pistons (Seville/ Eldored 79)  
 2: Citroën XM/Xantia (F/R), HONDA  
 3: Audi (F), Fiat, Alfa romeo (F), Ford Fiesta (F), Isuzu (F), Honda Concesto (F), Jaguar XJ6/XJ40 (F/R), BMW 318is/320i/325TD/518i/525i-1x/740i/850ci/ M5 (F), Mercedes BENZ 190/200/300/420/560 serie (F), Mitsubishi Colt (F), Nissan Miera/Stanza/Sunny (F), Rover Austin/Metro200-400 series/Maestra/Montego (F), Toyota Camry (F), VOLVO (F), VW Passat/Golf GTI (F)  
 4: Ford Australia/NZ Telstar, Mazda (R), Saab 9000 (R)/Lumina, Toyota, Fiat 164 2.0 (R), Alfa Romeo Prelude/CRS 16i, Honda Saturn (R)/Grand Prix, GM  
 5: utiliser l'adaptateur de 3/8" avec le prolongateur et le cliquet s'il est nécessaire de faire le plus de force sur le piston.  
 6: Nissan Primera, VW Golf IV  
 7: Audi 80/90/V8+100/Coupe E (R), Rover 800 ABS, Subaru L+Z (R), Ford Sierra ABS/Granada/Scorpio ABS (R), Nissan Bluebird 1.8 Turbo/Silvia Turbo/Primera2.0i LS-GS-GSX (R), Peugeot 405 1.9Gi/Gri/

Sri/Gtxi/MI 16/605 2.0 Sri (R), Toyota Cecilia/Corolla GT/MR2 (R), VW Golf Gti/Jeta Synchron/Jetta Gti 16v, Passat CL, GL, GT, GT 16v, Corrado 16V scirocco GTX 16V(R), Citroën, Alfa romeo, Fiat, Honda, Jaguar, Renault, Saab, Seat, Lancia.  
 8: GM most 1-7/8" diameter pistons  
 9: GM most 2-1/8" diameter pistons  
 A (Z): Renault (R21-Laguna (R))  
 E: Nissan Maximas/Cefiro  
 F (G): OPEL (disque arrière)/ Fiat Stilo  
 K: Citroën C5  
 M: Ford, Mini Cooper, Nissan Primera 03  
 N: Saab, Honda, Alfa Romeo 164 2.0 Twin Spark/2.0 Turbo (88-)/3.0 V6, Audi 200 (80-)/ Coupe GT SE (82-)/80/90/1Q0/200/Quattro (87-)/ 90/20V (88-), Ford Mondeo 2.0/Ghia, Lancia Themaalte (85-), Volkswagen Golf II GTI (83-87)/Sirocco 16V (84).

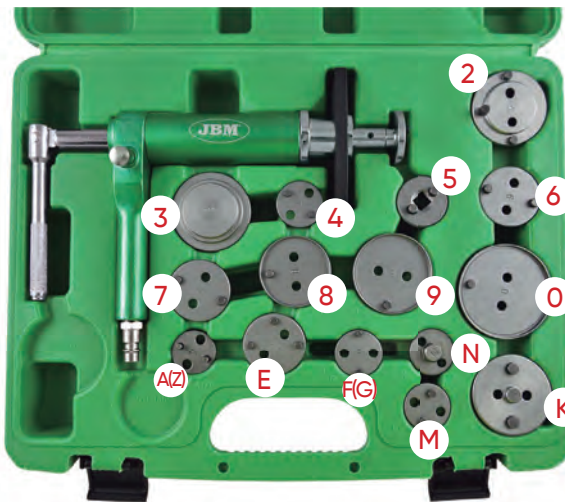

## COFFRET REPOUSSE PISTON

52330 99,00€

5.68	-	3	54
Kg	sub	ff	ff

OPEL  
CITROËN

PEUGEOT  
RENAULT

50  
PCS

1pc: Caliper rotation à droite (avec filetage à droite)  
 1pc: Grappin rotation à gauche (avec filetage à gauche)  
 0 disc: Citroën 1: Disc 11: Disc pour Jaguar Type S  
 12: BMW Mini Disc 5: 13/32" adaptateur (S) avec le Dr Interior-pt 3/8 2: Citroën XM, Xantia u.a.  
 3: Alfa Romeo.Audi. Austin. BMW. Ford. Honda. Jaguar. Mercedes-Benz. Mitsubishi, Nissan Rover, Toyota, VW  
 4: 2.0.Ford Alfa Romeo 164, Mazda, Saab 9000, Subaru 6: Nissan Primera, VW-Golf IV  
 7: 8.0,9.0 Audi V8 +100, Ford Scorpio Sierra ABS + ab 85, Prelude Honda, Nissan Silvia 1.8 turbo, 80000 Rover, Saab 9000, Subaru L + Z, VW-Golf + Passat  
 8: GM Motors G: Opel 9: GM Motors K: Citroën C5  
 O: GM Motors K1, K2: Citroën, Renault. M: Ford  
 A: Nissan Primera 2.0, Bluebird N: Saab, Honda B: Ford, Lincoln, Subaru Z:  
 Renault C: Mini Austin E: Cefiro, Maxima  
 D: Citroën, Renault F: Peugeot 206 CC / Hdi / Gti. Elle exige un arrière 16mm à piston clé.  
 P: Audi, BMW, Ford, Lancia, Piston, Renault, Rover.  
 J: Alfa Romeo 155 1.8-2.0 164 TD(93) 164 3.0 V6(91), 80,90 Audi, A3, A4, A6, A8, Citroen ZX 2 Qi 16V, 16V TD Fiat Tipo, Uno Turbo (85) Crama TD, Ford Sierra (ABS bak). Grenade (85) Crama TD, Ford Sierra (ABS bak). (Australie et Nouvelle-Zélande) Thunderbird Turbo, Honda CRX, 1.6i-16V (8-90). 1800 Accord (84-85) 2.0i. Prelude 16V (88), Legend V6, Jaguar XJ 4 Oseries, Lancia Dadrà 2.0, Eui Tur (93), Delta 1.6 Gti, Nissan, Peugeot, Renault, Seat, Subaru, Volvo V40 et S40.  
 R: Ford (Australie & NZ) Teslar, Laser, Mazda 323 Gti, GTXX (86-), 929 (82-), RX7 (81-) 16V 626 (87-) 626 GT (86-) 929 V6 (88-), Mitsubishi Galant GL Oui, Toyota Celica, Corolla GT, MR2  
 S: Audi 100 TQ (91), BMW 740i 8cyl (91), Lancia Delta 19 TD (95), 416. Proton Renault-la plupart des modèles, Renault Laguna 2.0 (94). Laguna 2.2 D (95) 2.0-2.2 Safrane V6 TD, Rover 623 Si, Volkswagen Golf Gtu Mk 1 & IV, Passat VR6, Vento GT (92)  
 H6: BMW  
 H7: BMW  
 Pin 3.0  
 Pin 5.5  
 100g Fat  
 1/2 "Dr + bit 10mm-56mm Pentagone Système de freinage  
 1/2 "Dr + 14mm de type mâle 38mm pour freins pentagone sur les freins arrière des Opel Astra G, Zafira, intelligent  
 1/2 "Dr + 19mm mâle de type 8mm- Bendix Brake, Citroën, Peugeot, Renault  
 P1: Peugeot 307,308.

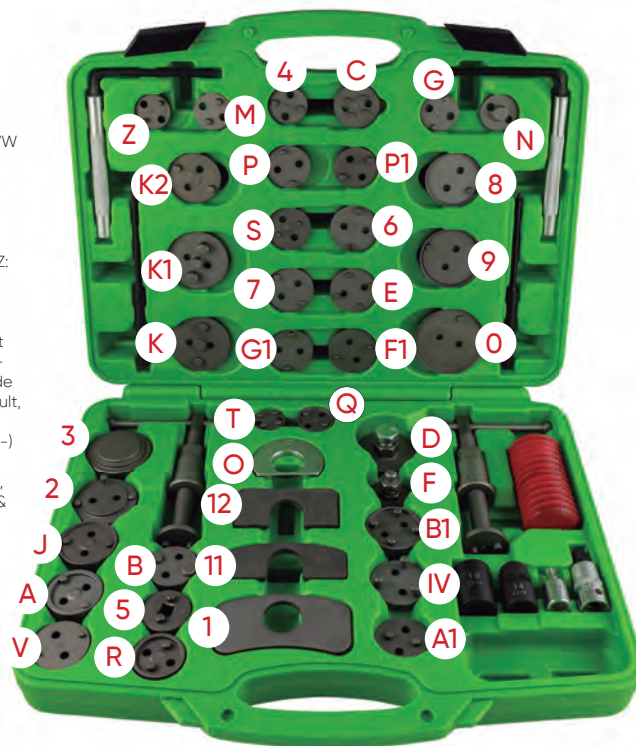

## COFFRET REPOUSSE PISTON

51059

99,00€

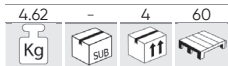

- Liste de modèles de véhicules et usages.
- 26 adaptateurs pour véhicules.
- Contient:
  - 2x clés Hexagonales de 6 et 7 mm.
  - 2x panneaux pour les systèmes de frein de Mercedes et Opel.
  - 3x coussins d'appui à utiliser dans des patins de frein et le travail dans des secteurs avec un espace limité.
  - 1x Soufflet avec de l'huile lubrifiante.

1pc: Caliper rotation à droite (avec filetage à droite) 1pc: Grappin rotation à gauche (avec filetage à gauche)  
 O: Disc 1: Disc 11: Disc pour Jaguar Type S 12: Disc pour BMW mini 5: Adaptateur 3/8" 2: Citroen XM, Xantia (F/R)  
 3: Alfa Romeo, Audi, Austin, BMW, Ford, Honda, Jaguar, Mercedes-Benz, Mitsubishi, Nissan, Rover, Toyota, VW.  
 4: Alfa Romeo 164 2, 0, Ford, Mazda, Saab 9000, Subaru. 6: Nissan Primera, VW-Golf IV.  
 7: Audi 80, 90, V8 +100, Ford Sierra ABS+Scorpio ab 85, Honda Prelude Nissan Silvia 1.8 turbo, Rover 8000, Saab 9000, Subaru L+Z, VW-Golf +Passat. 8: GM Motors. 9: GM Motors. O: GM Motors.  
 M: Ford. N: Saab,Honda. Z: Renault. E: Cefiro ,Maxima. G: Opel. K: CitroenC5. K1,K2: Citroen,Renault.  
 A: Disque double axial de 1-3/16" pour Renault R21, Laguna. B: Ford, Lincoln, Subaru. C: Mini Austin. D: Citroen, Renault. F: Opel (disco trasero) P: Audi, BMW, Ford, Lancia, Proton, Renault, Rover, VW.  
 J: Alfa Romeo 155 1.8-2.0 164 TD (93) 164 3.0 V6 (91) Audi, 80, 90, A3, A4, A6, A8 Citroen ZX 2 Ql 16V, Fiat Tipo TD 16V, Uno Turbo (85) Crama TD, Ford Sierra(ABS bak), Granada (85), (Australia & NZ) Thunderbird Turbo, Honda CRX, 1.6l-16V (8-90), Accord 1800 (84-85) 2.0i, Prelude 16V(88), Legend V6, Jaguar XJ40series, Lancia Dedra 2.0 Ei Tur(93), Delta 1.6Gti, Nissan, Peugeot, Renault, Seat, Subaru, Volvo V40& S40.  
 R: Ford (Australia & NZ) Telstar, Laser, Mazda 323 Gti, GTX(86-),929(82-), RX7(81-), 626 16V(87-), 626 GT (86-), 929 V6(88-), Mitsubishi Galant GL Si, Toyota Celica, Corolla GT, MR2.  
 S: Audi 100TQi(91), BMW 740i 8cyl.(91), Lancia Delta 1.9 TD(95), Proton 416, Renault-most models, Renault Laguna 2.0 (94), Laguna 2.2 D(95), Safrane 2.0-2.2 TD V6, Rover 623 Si, Volkswagen Golf Gti Mk 3&4,Passat VR6, Vento GT(92).  
 H6: BMW H7: BMW Pin Ø 3.0 Pin Ø5.5 100g Fat

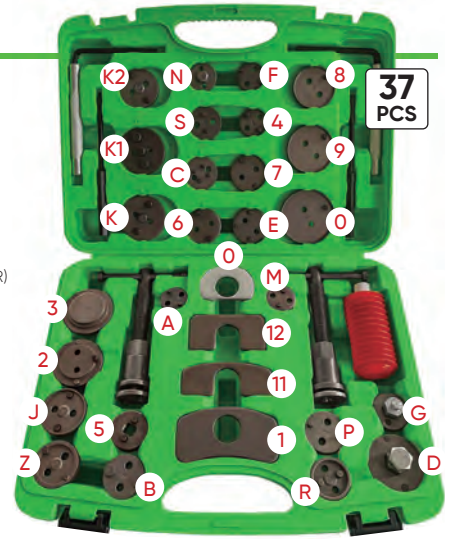

37 PCS

## COFFRET REPOUSSE PISTON

53978

38,90€



- Kit utilisé pour comprimer le piston de l'étrier.

O : Plaque  
 1 : Plaque  
 O : General Motors (pistons Ø 21/2 pouces)  
 2 : Citroën XM, Xantia  
 3 : Alfa Romeo, Audi, Austin, BMW, Ford, Honda, Jaguar, Mercedes-Benz, Mitsubishi, Nissan, Rover, Toyota, VW  
 4 : Alfa Romeo 164 2.0, Ford, Mazda, Saab 9000, Subaru  
 5 : adaptateur carré 3/8 pouce  
 6 : Nissan Primera, VW Golf IV  
 7 : Audi 80 ; 90 ; V8 + 100, 1985 Ford Sierra ABS + Scorpion, Honda Prelude, Nissan Silvia 1.8 turbo, Rover 8000, Saab 9000, Subaru L+Z, VW Golf + Passat  
 8 : General Motors (pistons Ø 17/8 pouces)  
 9 : General Motors (pistons Ø 21/8 pouces)  
 IV : VAG, Renault, Volvo avec frein de stationnement électronique  
 A : Renault  
 E : Nissan Maxima, Cefiro  
 F : Opel  
 J : Pour Fiat Tipo TD 16V, Uno Turbo (85) Crama TD, Honda CRX, Alfa Romeo 155 1.8-2.0i, 164 TD (93), 164 3.0 V6 (91) ; Audi 80, 90 et V8, A3, A4, A6, A8 (étrier arrière) ; Citroën ZX 2.Ql 16v ; Fiat Tipo TD 16V, Uno Turbo (85-), Crama TD ; Ford Sierra (arrière avec système de freinage antiblocage ABS), Granada (85-) ; Ford (Australie et Nouvelle-Zélande) Thunderbird Turbo  
 ; Honda CRX, 1.6l-16V (88-90), Accord 1800 (84-85), 2.0i (86-), Prelude 16V (88-), LegendV6 ; Jaguar XJ série 40 Lancia Dedra. 2.0 Ei Tur(93), Delta 1.6 Gti. (92), The majE 16v (92), Thema. 2000 Turbo. Kappa 2.Q-2.4LS, 2.4TD ; Nissan 280 ZX (82-84), 300 ZX Turbo (84-89), Bluebird 16V (89-), Silvia 1.8 Turbo (85-88) 100 NZ 2.0 (93), Primera 2.0 GT (94), 200 SX turbo 16V, Maxima 2.0 GX-3.0 GX (95) ; Peugeot 306 ; Peugeot 309 Gtj 16S (91), 405. Sirif Q. rj, Gil (87-), 405 M.I 16V ; fourgon Renault Master ; Rover 216 Gti 16V, 820 Si 2.0 (93), 825 SD 2.5 (93) ; Saab 9000 CS 2.0 (93), 9000 CSE Turbo (93) ; Seat Toledo GT. 16V-GT 2.0 (93), Ibiza 1.8 Gti 16V (95) ; Subaru série L et série 2 ; Volkswagen Passat 2.0 & 2.2 litres (84), Golf Rallye (-89), Golf II Gti 16V (89-), Vento GT (92), Transporter T4 ; Volvo S40 et V40  
 K : Citroën C5  
 K1 : Citroën  
 K2 : Citroën  
 M : Ford  
 N : Saab, Honda



23 PCS

## COFFRET REPOUSSE PISTON UNIVERSELLE

52906

38,00€

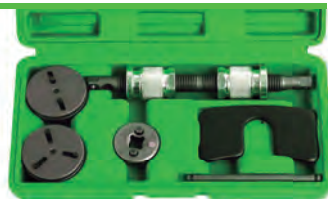

- Alfa Romeo 164 2.0, Ford, Mazda, Saab 9000, Subaru, Nissan Primera, VW, Audi, Ford Sierra ABS + Scorpio ab 85, Honda Prelude, Nissan Silvia 1.8 turbo, Rover 8000, Saab 9000, Ford, Opel, BMW, Lancia, Proton, Renault, Rover, Peugeot 307, 308 A3- Iveco Daily, Volkswagen Passat 2.0 TDI 09, Renault Laguna.

12974

12975

REF.	DESCRIPTION	Kg	Sub	€
12974	Rechange 2 pins	0,15	50	21,00€
12975	Rechange 3 pins	0,17	50	23,00€

## COFFRET REPOUSSE PISTON DE FREIN

14142

109,00€

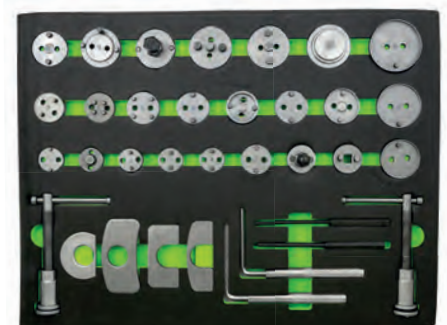
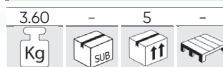

34 PCS

- 24x adaptateurs
- 4x plaques de retenue
- 2x axes pour filetage
- 2x poinçons
- 2x clés hexagonales

## PURGEUR DE FREIN PNEUMATIQUE

**52191** 198,00€

9,05 - 1 15  
Kg SUB fff

- Pression de travail: de 0 à 4 kg/cm<sup>2</sup>.
- Entrée et de sortie de 1/2".
- Poids: 5kg.
- Nombre d'adaptateurs: 11 + 2 universels.
- Domaines d'application: GM, Chrysler, Nissan.



BOUCHONS POUR PURGEUR DE FREIN REF. 52191  
POUR VÉHICULES GM, CHRYSLER, GM, NISSAN

**52328** 99,00€

2,90 - 4 68  
Kg SUB fff

- 9 Adaptateurs burettes huile de frein: Universal n°1, n°2, n°3, n°4



330mm 230mm 230mm

## COFFRET POUR RÉPARATION ET ENTRETIEN DES FREINS

**52434** 125,00€

3,25 - 5 100  
Kg SUB fff

- Contient: Clés pour vis de frein. Pincettes de ressort de frein. Rounevis à choc. Douilles torunevis. Outil d'Assemblage. Tournevis avec articulation universelle. Outil special frein. Brosse. Brosse en laiton. Outil d'assemblage. Pince de câble de frein. Lime pour pince de frein.



## PINCE POUR RESSORT DE FREIN

**52625** 9,00€

0,35 - 6 48 1824  
Kg SUB fff

- Pour extraire et installer les ressorts de retour des freins.



## JEU DE DOUILLES POUR ÉTRIER DE FREIN

**54135** 82,00€

1,45 - 5 10 400  
Kg SUB fff

- Audi (A4, A5, S5, S8, Q5, Q7)
- Porsche (Cayenne, Macan, Cayman)
- Mercedes Benz
- Ford
- BMW
- Alfa Romeo



## REPOUSSE PISTON MANUEL DE FREINS

**52315** 16,00€

0,88 - 5 20 640  
Kg SUB fff

- Ouverture max: 80mm.



## TESTEUR LIQUIDE DE FREIN

**51839** 24,00€

0,05 - 25 100 2400  
Kg SUB fff

- Fonctionne avec des piles 1xAAA LR03.
- Avec 4 niveaux de qualité mesurables de 0% à 4 %.



## JEU DE JAUGES D'ÉPAISSEUR POUR PLAQUETTES DE FREIN

**52455** 16,00€

0,26 - 10 20 864  
Kg SUB fff

COULEUR	METRIC	SAE
Vert	8-10-12mm	0.3150-0.4720"
Jaune	4-5-6mm	0.1575-0.2382"
Rouge	2-3mm	0.0787-0.1181"



## PURGEUR DE FREINS PNEUMATIQUE

**52275** 38,00€

0,79 - 4 112  
Kg SUB fff

- Température de fonctionnement: 10°C à 50°C.
- Tuyau en silicone: 1m.
- Pistolet de soufflage entrée d'air 1/4".
- Pression d'air: 6-12 bar (87 - 174 psi).
- Admission d'air: 180l/min.







# OUTILLAGE

- 178 SYSTÈME DE LUBRIFICATION
- 183 SYSTÈME D'INJECTION
- 187 RÉPARATEUR DE BOUGIES
- 189 COMPRESSIONNÈTRE
- 190 RÉCHAUFFEURS
- 191 EXTRACTEURS
- 203 DINANOMÉTRIQUES
- 205 MULTIPLACATEURS DE FORCE  
/ EMBRAYAGE
- 207 SYSTÈME AACC
- 208 SYSTÈME DE RÉFIGÉRATION
- 210 CROSSE / VALVES
- 211 COMPRESSEUR DE RESSORT
- 212 DIVERS
- 214 ORGANISATEURS / PLATEAUX
- 215 COUPEUSES DE CADENAS / BROSSES

# JEU DE CLÉ POUR FILTRES À HUILE EN ALUMINIUM, 19 PIÈCES

54068 198,00€

4,00 - 2 48  
Kg SUB if



19  
PCS

## PIÈCES DE RECHANGE DISPONIBLES

REF.	N° DE PIÈCES	CARACTÉRISTIQUES	Ø x PANS	Kg	if	€
15494	05101	Mazda, Mitsubishi	100,5mm x 15	5	10	12,50€
15495	0595	Nissan, Toyota	94,5mm x 15	5	10	12,50€
15496	0592	Nissan, Subaru	92mm x 15	5	10	11,50€
15497	0579	Toyota, Honda, Mitsubishi, Subaru, Mazda, Lsuzu	79mm x 15	5	10	11,00€
15498	915	Volvo	87mm x 16	5	10	11,50€
15499	901L	Lexus	79,5mm x 14	5	10	11,00€
15500	901T	Toyota	70mm x 14	5	10	10,00€
15501	901-1	Toyota	63-64mm x 14	5	10	10,00€
15502	902	Ford, Mazda	66,5mm x 14	5	10	10,00€
15503	1284	Dodge Sprinter (2007-), Mercedes Benz E320 (2007-), Jeep Cherokee 3.0L V6 Common Rail (2007-)	84mm x 14	5	10	11,00€
15504	903B	Mercedes Benz	74mm x 14	5	10	10,00€
15505	24mm	BMW 5, BMW 7, BMW X5 V8 (N62) (2004-), Saturn (2008), Astra 1.8L ECOTEC, Chrysler 3.6L V6 (2011-), 200, 300, T/C Dodge Jeep	24mm x 14	5	10	4,00€
15506	27mm	Mercedes Benz Classe A	27mm x 6	5	10	4,00€
15507	30mm	Audi A2, Vw Polo, Lupo 1.4L/1.6L	30mm x 6	5	10	4,50€
15508	32,5 mm	Opel Astra G, Corsa B, Zafira, Audi, VW 1-36 mm, Opel Omega, Vectra B, Zafira (98-), BMW M43/60	32,5mm x 6	5	10	4,50€
15509	36mm	Opel Omega, Vectra B, Zafira (98-), BMW M43/60, Mercedes Benz Vito CDI, C, E, VW Lupo 1.2 TDI, MAN	36mm x 6	5	10	5,00€
15510	38mm	Opel Vectra 2.0D	38mm x 6	5	10	5,00€
15511	917	Universal	55-90mm	5	10	8,00€

# COFFRET CLOCHES POUR FILTRES À HUILE

51332 98,00€

4,20 - 5 60  
Kg SUB if









23  
PCS

## PIÈCES DE RECHANGE DISPONIBLES

REF.	N° DE PIÈCES	CARACTÉRISTIQUES	Ø x PANS	Kg	if	€
11374	901	Toyota, Nissan, Fiat Daihatsu	65mm x 14	0,10	5 20	5,50€
11375	902	Toyota, Daihatsu	67mm x 14	0,08	5 20	6,50€
11376	903	VW, Mercedes, BMW, Opel, Audi	74mm x 14	0,09	5 20	5,50€
11377	903-1	GM/AC, Wix, Ford, Isuzu	75mm x 15	0,09	5 20	5,50€
11378	903-2	VW, Audi, Seat, BMW, Renault	74mm x 8	0,09	5 20	6,50€
11379	903-3	Audi, Rover, Chrysler	74mm x 15	0,11	5 20	6,00€
11380	903-4	Toyota, Lexus	73mm x 14	0,11	5 20	6,50€
11381	903-6	Schlepper, Baumashinen	75mm x 12	0,10	- 50	6,50€
11382	918	Rover, Chrysler, Audi	74mm x 15	0,11	5 20	6,00€
11383	904	Nissan, Ford	79mm x 15	0,10	5 20	6,00€
11384	905	GM, Chrysler	73mm x 15	0,12	5 20	6,00€
11385	905-1	BMW, Mercedes, Opel, Audi, VW	74mm x 14	0,10	5 20	5,50€
11386	906	Baummaschinen, Schlepper	84mm x 18	0,10	5 20	6,00€
11387	907	Mitsubishi, Toyota	89mm x 15	0,13	5 20	6,00€
11388	908	Nissan, Toyota	91mm x 15	0,14	5 20	6,00€
11389	915	Honda Accord, Mitsubishi, Isuzu	90mm x 15	0,16	5 20	6,00€
11390	910	Toyota, Alfa Romeo, Ford	95mm x 15	0,12	5 20	6,00€
11391	911	Fiat, Renault, Citroën	80mm x 12	0,09	5 20	6,50€
11392	911-1	Subaru, Toyota, Honda, Nissan	80mm x 15	0,09	5 20	6,00€
11393	914	Mazda, Toyota	101mm x 15	0,18	5 20	6,00€
11394	909	Isuzu, Nissan	92mm x 15	0,14	5 20	6,00€

REF.	CARACTÉRISTIQUES	Kg	if	€
14992	Clé à 12 pans	0,10	- - -	8,50€
10955	Cliquet 1/2"	0,14	- 1 50	11,00€

# CLOCHES EXTRACTION FILTRE À HUILE

<b>52311</b> 19,00€ 0.13 6 72 1728 Kg SUB ff  GROUPE VAG 42mm	<b>52312</b> 9,00€ 0.10 10 100 1800 Kg SUB ff  VW, OPEL, MERCEDES, BMW, AUDI 74mm x 14C	<b>52313</b> 8,00€ 0.20 6 68 1008 Kg SUB ff  VOLVO 540, 560, 570, 580 86mm x 16C
<b>52314</b> 26,60€ 0.20 5 50 600 Kg SUB ff Présentation en caisse  BMW VOLVO 87mm x 16C	<b>52809</b> 8,50€ 0.15 10 100 1000 Kg SUB ff  3/8" TOYOTA 64,5mm x 14C	<b>53441</b> 9,80€ 0.20 5 20 800 Kg SUB ff  76mm x 14C

## EXTRACTEUR DE FILTRE À HUILE FORD, CITROËN, PEUGEOT 2.0, 2.2 HDI, TDCI

**53008** 15,50€

0.60 5 30 1500  
Kg SUB ff



250mm



## CLÉ À FILTRE DE CAMION

**52518** 115,00€

1.40 6 12 480  
Kg SUB ff

95-165mm



## COFFRET DE 9 CLOCHES POUR FILTRES À HUILE

**52615** 112,00€

3.05 - 5 70  
Kg SUB ff

- Clé à double sens ajustable.  
- Rang d'application: 60-80mm.

Audi, BMW, Mercedes, Opel, Renault, Volvo, Kia, Hyundai, Ford, VW, Skoda, Citroën, Mini

9 PCS

**1/2" x1** **UNIVERSAL** 63-83mm





**3/8" x8**

- 6** - 27mm: Mercedes-Benz, Smart.  
- 32mm: GM, Opel/Vauxhall, Mercedes-Benz.  
- 36mm: Mercedes Diesel, BMW, Mini, Ford.
- 14** - 64,5mm: Toyota (Allion, Auris, Corolla, Prius, Voxy, etc.).  
- 64,5mm: Toyota, Lexus (6 Zyl.).  
- 74,2mm: Audi, BMW, Ford, Toyota, Volkswagen, Porsche, Mercedes-Benz.
- 15** - 88,8mm: Hunday, Kia.
- 16** - 86,6mm: BMW 3+5+X, Volvo.



## CLÉ A FILTRE À 3 BRAS

- Peut être utilisé avec des CLÉ de 1/2" ou 3/8".

<b>51352</b> 9,80€ 0.40 5 40 960 Kg SUB ff  57-118mm - Extrait tous les filtres à huile de 2-1/4" à 5" de diamètre.	<b>51934</b> 11,50€ 0.40 10 40 1200 Kg SUB ff  57-118mm - Extrait tous les filtres à huile de 2-1/2" à 4" de diamètre.	<b>51353</b> 11,50€ 0.65 5 40 960 Kg SUB ff  72-136mm - Extrait tous les filtres à huile de 2-1/2" à 4" de diamètre.	<b>51923</b> 12,50€ 0.56 10 40 960 Kg SUB ff  72-136mm - Extrait tous les filtres à huile de 2-1/2" à 4" de diamètre.
---	--	---	---

# JEU DE 5 JAUGES NIVEAU D'HUILE POUR BENZ/AUDI

**53206** 38,20€

**5**  
PCS

0,55 5 20 140  
Kg SUB ff

- Pour le control du liquide de transmission d'huile dans les moteurs Audi 100:  
La première lecture est à froid à 20 °C.  
La deuxième à 80 °C.  
La troisième lecture est à 80 °C maximum.  
- La jauge moteur pour vérifier le niveau d'huile est compatible avec une large sélection de moteurs de 1988 à 2005 dans la gamme Mercedes.



**BAGUETTE POUR CONTROL D'HUILE - AUDI**

**13856** 7,80€  
0,04 5 100  
Kg SUB ff

## PINCE POUR FILTRES À HUILE

**51354** 13,20€

0,43 5 40 600  
Kg SUB ff

80-120mm



## CLÉ POUR FILTRE À HUILE POUR VAG DSG 1/2" 24 mm

**53670** 29,50€

0,25 10 40 1680  
Kg SUB ff

1/2"

- Ensemble d'outils pour la réparation et la remise en état des boulons de roue, ainsi que pour son ancrage dans le filetage femelle du véhicule; utile dans les discussions partiellement endommagées.



## CLÉS À SANGLE REGLABLE

**52269** 7,00€

0,20 10 50 1200  
Kg SUB ff

80-120mm



RECHANGE 360mm

**11106** 3,00€  
0,02 10 50  
Kg SUB ff

## CLÉ À SANGLE RÉGLABLE

**52677** 17,00€

0,32 10 40 480  
Kg SUB ff

∅ 65-105mm

1/2"



**52678** 18,00€

0,33 10 40 400  
Kg SUB ff

∅ 110-155mm

REF.	RECHANGE	POUR	Kg	SUB	ff	€
11936	383mm	52677	0,03	10	100	4,00€
11937	540mm	52678	0,04	10	100	5,00€

## CLÉ À CHAÎNE

**52417** 28,00€

0,90 5 25 800  
Kg SUB ff

∅ 160mm 300mm

CHAÎNE À HAUTE RÉSISTANCE

SURFACE DENTELÉE POUR UNE MEILLEURE ADHÉRENCE



## CLÉ À SANGLE

**52416** 14,00€

0,37 5 50 900  
Kg SUB ff

∅ 150mm 20mm 540mm

COURROIE EN POLYMÈRE (HAUTE RÉSISTANCE)

SURFACE DENTELÉE POUR UNE MEILLEURE ADHÉRENCE



# CLÉ À CHAÎNE

**52607** 49,00€

0.85	6	24	576
Kg	Sub	ff	ff

Ø 60 - 140mm



**52608** 44,00€

0.95	6	24	360
Kg	Sub	ff	ff

Ø 60 - 195mm



DOUBLE CHAÎNE

# JEU DE 5 BOUCHONS PLASTIQUE D'ÉVACUATION D'HUILE

**53741** 14,00€

0.05	10	100	4000
Kg	Sub	ff	ff

**13969** 19,00€

0.01	10	100	-
Kg	Sub	ff	ff

**53537** 14,50€

0.05	10	100	4000
Kg	Sub	ff	ff

**53538** 14,50€

0.10	10	100	4000
Kg	Sub	ff	ff

**5 PCS**



# COFFRET DOUILLES DE VIDANGE

**53735** 44,00€

1.70	-	5	375
Kg	Sub	ff	ff

3/8" **23 PCS**



- CONTIENT**
- x2 5/16", 3/8"
  - x7 7, 8, 10, 11, 12, 13, 14mm
  - x1 10mm
  - x1 10mm
  - x7 8, 9, 10, 12, 13, 14, 17mm
  - x1 T45
  - x1 M16
  - x1 200mm
  - x2 75, 150mm

# MODULE DE DOUILLES DE VIDANGE

**15084** 68,00€

1.70	-	-	-
Kg	Sub	ff	ff

MODULE FINITION EN FIBRE DE CARBONE

240x135x32mm

**22 PCS**

- CONTIENT**
- x2 5/16", 3/8"
  - x7 7, 8, 10, 11, 12, 13, 14mm
  - x1 10mm
  - x1 10mm
  - x7 8, 9, 10, 12, 13, 14, 17mm
  - x1 T45
  - x1 M16
  - x1 200mm
  - x1 150mm

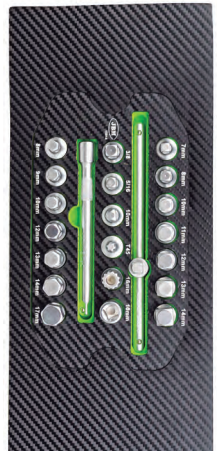

## CLÉ POUR BOUCHONS PLASTIQUES D'ÉVACUATION D'HUILE (VAG)

53472 12,00€

0,10	10	100	1200
Kg	sub	ff	ff

OEM: T10549



- Fonction: Pour l'extraction des bouchons de carter en plastique.

- Applications:

Audi: A1, A3, A4, A5, A6, A7, Q3, Q5, Q7, TT, TTS.

Seat: Alhambra, Leon, Toledo.

Skoda: Octavia, Rapid, Superb, Yeti.

VW: Beetle, Caddy, CC, Golf, Jetta, Passat, Polo, Scirocco, Sharan, Tiguan, Touran.

## CLÉ DE VIDANGE

52617 7,00€

0,23	6	36	1512
Kg	sub	ff	ff

8 - 10mm

- Pour Citroën, Renault, Peugeot.



## JEU D'OUTILS POUR BOUCHONS PLASTIQUES D'ÉVACUATION D'HUILE

53473 36,00€

0,40	10	50	800
Kg	sub	ff	ff

5 PCS

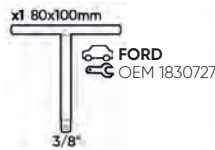

FORD  
OEM 1830727



PEUGEOT / CITROËN  
OEM 9801444780  
OEM 18711598



BMW  
OEM 11137605018



x1 1/4\"/>

3/8\"/>



FORD, VAG, PEUGEOT,  
CITROËN, BMW

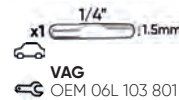

VAG  
OEM 06L 103 801

## COFFRET DE RÉPARATION DES BOUCHONS DE CARTERS D'HUILE

51337 50,00€

1,55	-	10	180
Kg	sub	ff	ff



- Bouchons de SKS3.  
- Tarauds de 1015.  
- Rondelle de Cuivre.

- Contient:  
M13x1,5P  
M15x1,5P  
M17x1,5P  
M20x1,5P

- Tarauds: 1 x mesure  
- Bouchons: 5 x mesure  
- Rondelles: 10 x mesure



### PIÈCES DE RECHANGE DISPONIBLES

5 écrous + 5 rondelles\*

\*Entregado en bolsas de 5 unidades.  
5 écrous + 5 rondelles

REF.	DESCRIPTION	Kg			€
51403	M13 x 1.5P	0,13	5	50 100	17,50€
51400	M15 x 1.5P	0,17	5	50 100	17,00€
51401	M17 x 1.5P	0,15	5	50 100	22,00€
51402	M20 x 1.5P	0,10	5	25 50	20,50€

REF.	DESCRIPTION	Kg			€
14930	M13 x 1.5P	0,05	10	100	9,50€
14931	M15 x 1.5P	0,05	50	100	8,00€
14932	M17 x 1.5P	0,07	5	100	9,50€
14933	M20 x 1.5P	0,10	5	100	9,50€

## SET DE RÉPARATION DE VIS POUR BOUCHON DE CARTER

53235 10,40€

0,25	10	40	-
Kg	sub	ff	ff

M13

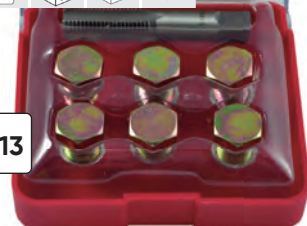

53236 11,50€

0,35	10	40	-
Kg	sub	ff	ff

M15



53237 12,90€

0,35	10	40	-
Kg	sub	ff	ff

M17



53238 18,40€

0,40	10	40	-
Kg	sub	ff	ff

M20



## EXTRACTEUR DE PNEUMATIQUE POUR INJECTEURS

54186

320,00€

Bosch, Delphi, Denso, Siemens

S

6-8 bar

20-30 Nm

6,79 - 2 80  
Kg SUB

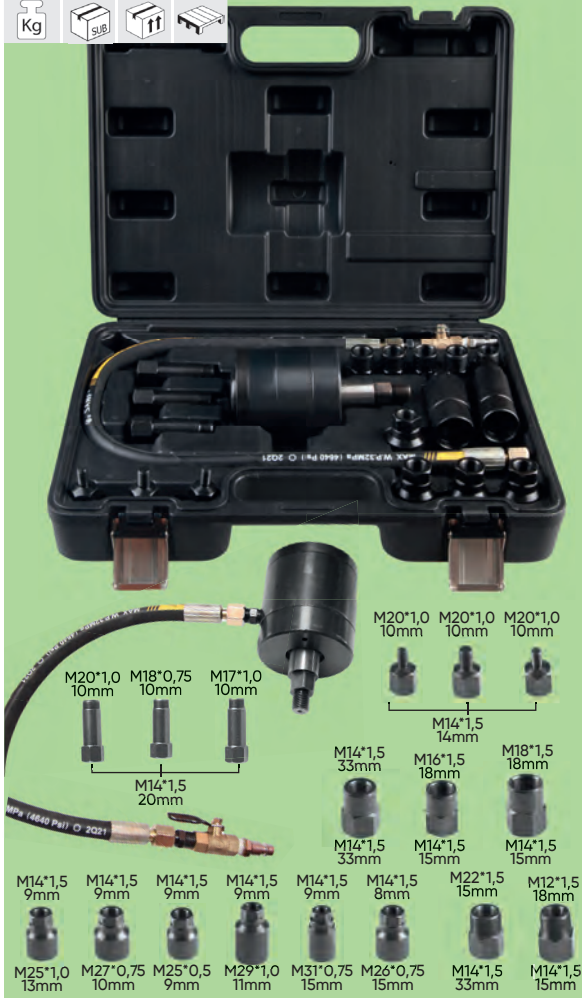

## EXTRACTEUR D'INJECTEUR HYDRAULIQUE

54245

580,00€

GASOIL/DIESEL

Bosch, Delphi, Denso, Siemens

1795 - 1 100  
Kg SUB

Cet ensemble d'outils est conçu pour retirer les injecteurs les plus serrés avec peu d'effort, grâce à son système hydraulique qui permet d'exercer une force allant jusqu'à 10 tonnes.

Raccordement du cylindre hydraulique : NPT de 3/8 PO  
Force du cylindre hydraulique : 10 tonnes

Adapté pour l'extraction des injecteurs de carburant diesel, en particulier :

Elle doit être utilisée avec une pompe hydraulique manuelle.



M17 x 1.0	Bosch	M20 x 1.0	Denso
M14 x 1.5	Delphi	M25 x 1.0 / M27 x 1.0	Siemens
M16 x 1.0	Toyota		

## POMPE HYDRAULIQUE À MAIN

54257

318,00€

11,40 - 1 32  
Kg SUB

POUR REF. 54245

Nombre d'étapes : 2  
Pression de travail :  
Étape 1 : 0 à 20 kg/cm<sup>3</sup>  
Étape 2 : 20 à 700 kg/cm<sup>3</sup>  
Pression de travail maximale : 1000 PSI  
Huile utilisable : 700Cc  
Flux :  
Étape 1 : 13cc  
Étape 2 : 2,3cc  
Longueur du tuyau : 1,8 m  
Connexion : NPT de 3/8 PO



## EXTRACTEUR D'INJECTEURS DIESEL POUR CITROËN, PEUGEOT

53069

98,00€

CITROËN PEUGEOT

3,44 - 5 150  
Kg SUB

- 1x pont compensateur.
- 3x assises du pont compensateur.
- 2x mèche de l'extracteur - Ø17 mm, Ø25 mm.
- 1x écrou cylindrique de mèche.
- 2x têtes de injecteur de 25 mm et 29 mm.
- 1x clé Allen de la protection de 21 mm.



## COFFRET D'EXTRACTION D'INJECTEURS

51494

107,00€

3,60 - 4 96  
Kg SUB

- Avec marteau coulissant pour moteurs CDI et moteurs Mercedes CDI OM 611, 612, 613 etc. Pour extraire les injecteurs obstrués et common-rail sans démonter la culasse.

- La construction robuste permet une réduction radicale des injecteurs les plus durement bloqués.

- Matériel : acier S45C. Longueur totale: 350 mm

- Contenu:  
Marteau: 1,75 kg, Adaptateur: M17x1,0  
Adaptateur: M27 x 1,0  
Adaptateur poignée w/M12 x 1,75P



## CLÉ POUR TUYAU D'INJECTION

52821

28,80€

0,24 - 6 96 -  
Kg SUB



17mm



## COFFRET D'EXTRACTION D'INJECTEURS

52858 298,00€

- Pour retirer les injecteurs diesel.  
- Convient pour la plupart des injecteurs diesel parce que de nombreux adaptateurs inclus.

21,20	-	1	40
Kg	Sub	ff	ff

- Composants:

3 différents marteaux:  
1,6 kg - 160 mm de long.  
2,7 kg - 460 mm de long.  
5,1 kg - 600 mm de long.

Poignées avec une séparation entre les lames:  
13,7x18mm, 105mm de long.  
12,7x19mm, 130mm de long.

1/2" navires fendues 6 pt, 100mm de long.

Tailles: 25, 27, 28, 29, 30.  
Injecteur extracteur de broche M17x1.0.

Adaptateur avec filetage:  
M27x1.0 et M25x1.0.

Adaptateur avec filetage intérieur:  
M27x1.0.



## ÉTUI DE RONDELLES EN CUIVRE POUR INJECTEURS 551 PCS

53464 153,00€

1,85	-	5	90
Kg	Sub	ff	ff



551  
PCS

pg.328

## EXTRACTEUR DES POMPES À CARBURANT DIESEL POUR BMW

53501 24,00€

- Maintient les roues dentées lors du montage de la pompe d'injection.

0,55	10	20	1120
Kg	Sub	ff	ff

- BMW: M47 / M47T2 / M47TU / M57 / M57TU.  
- SERIES: E46 (318D-320D) (1988 - 2005) and E60, E61 (318TD-320TD-525D-530D-530-535) (2000 - 2006).  
- OEM1 13 5 191 | 13 5 192 | 13 5 190 BMW.



## COFFRET D'EXTRACTION D'INJECTEUR POUR MERCEDES

52629 99,00€

MERCEDES

1,22	5	10	440
Kg	Sub	ff	ff



## EXTRACTEURS POUR TUBES D'INJECTION DIESEL

53009 42,00€

0,50	4	20	560
Kg	Sub	ff	ff

3/8"

14, 17, 19mm



- Spécifique pour Mercedes (C/E/S CLASS, VITO) INJ.  
- Mercedes / Bosch. Solution injecteur.  
- Extracteur spécifique pour Mercedes spécifiques, complet, avec prise pour DÉ-MONTAGE de la connexion électrique.

## ARRACHEUR DE PRESSE-ÉTOUPES DE GICLEURS

53522 24,00€

Ø 4,5 - 15mm

0,80	5	20	480
Kg	Sub	ff	ff





# COFFRET NETTOYAGE SIÈGES INJECTEURS DIESEL ET ESSENCE

51493 68,00€

1.85	-	5	80
Kg	sub	ff	ff

Adéquat pour un usage sur BOSCH, SIEMENS, DENSE et DELPHI injecteur.

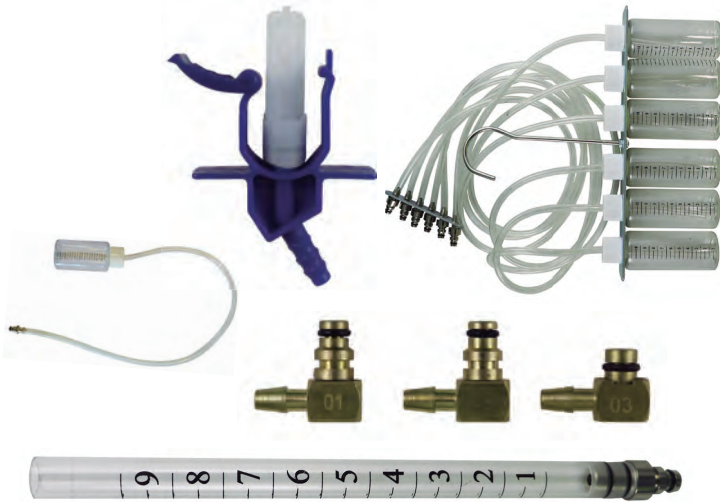

BOUEILLE + TAMPON + TUYAU POUR REF. 51493

- Le but de cet instrument est de mesurer rapidement et efficacement la quantité de carburant que chaque injecteur renvoie au réservoir d'essence, de sorte à savoir si un injecteur déterminé est endommagé.

12901	0.03	10	60
5,20€	Kg	sub	ff

- Le kit inclu:  
Perche à accrocher avec 6 bouteilles de mesure graduées.  
6 tubes de mesure (pour crack unique condition).  
Tubes blancs de remise.  
Étui de stockage.

# 17 PIÈCES NETTOYAGE SIÈGES INJECTEURS

52813 79,00€

2.23	-	5	180
Kg	sub	ff	ff



17 PCS

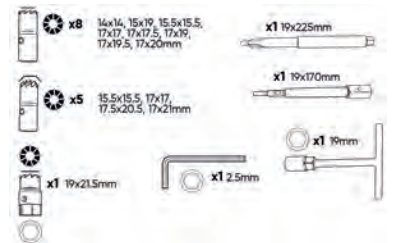

- Jeu de 17 alésoirs pour nettoyer les sièges des injecteurs.

# COFFRET NETTOYAGE SIÈGES INJECTEURS

52273 44,00€

1.40	-	5	180
Kg	sub	ff	ff



8 PCS

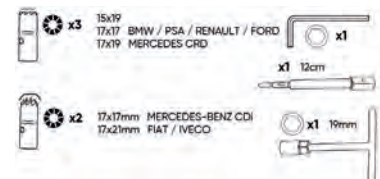

- Jeu de 5 alésoirs pour nettoyer les sièges des injecteurs lorsque les moteurs diesel, les injecteurs sont remis à neuf ou remplacé.



INJECTEURS

## KIT DE NETTOYAGE DE SIÈGES D'INJECTEURS

53650 47,00€

0,90	-	10	140
Kg	Sub	ff	ff



- Kit avec trois brosses en acier recouvert de laiton pour nettoyer les dépôts de carbone restants des parois latérales du SIÈGE INJECTEUR ainsi que deux brosses en nylon de silicone pour nettoyer la base du siège.
- Les brosses de nettoyage peuvent être rapidement connectées à l'extension flexible fournie.
- Ce kit contient également six bouchons d'étanchéité et une tige d'insertion pour empêcher les dépôts de carbone de pénétrer accidentellement dans la chambre de combustion pendant le processus, en plus d'une brosse métallique de petit calibre pour nettoyer le fond du siège.

- Contient:
- 3 brosses en laiton.
- 2 brosses silicone-nylon.
- 1 extension
- 6 bouchons de fermeture pour l'étanchéité de la chambre de combustion.
- 1 tige pour l'insertion des bouchons de fermeture.
- 1 brosse en acier pour le nettoyage de la culasse.



KIT DE 3 BALAIS DE NETTOYAGE DE LAITON (REF.53650)

14348	0,05	50
12,50€	Kg	ff



KIT DE 2 BALAIS DE NETTOYAGE EN SILICONE (REF.53650)

14349	0,07	100
20,50€	Kg	ff

## SET DE DOUILLES POUR POMPE INJECTEUR

53330 38,00€

0,75	-	20	144
Kg	Sub	ff	ff

- Pompe d'injection BOSCH.
- TDI.
- Common Rail.



Cr-V 1/2" 1/4" 5 PCS



## POMPE MANUELLE POUR INJECTION DIESEL

52801 26,00€

0,10	5	50	600
Kg	Sub	ff	ff

- Évite le retour d'essence vers le réservoir pendant le remplacement de la pompe à injection, filtres ou autres parties.
- Après avoir remplacé les parties à changer, il permet de pomper l'essence qui se dirige vers la ligne d'injection.



## COFFRET DOUILLES POUR SYSTÈME D'INJECTION LAMBDA

51491 154,00€

3,99	-	5	150
Kg	Sub	ff	ff

- 17x78mm (12PT): Renault.
- 19x78mm (12PT): VW, Polo, Audi, Seat, Mazda.
- 20x78mm (6PT): Deschis Japon.
- 27x78mm (6PT): Deschis Japon.
- 21x90mm (12PT): Seat,
- Audi, VW, Skoda, Alfa Romeo, Mitsubishi.
- 22x78mm (12PT): Seat, Audi, VW, Skoda, Opel.
- 22x110mm (12PT): Mercedes, Citroën, Peugeot, Ford, Nissan, Mazda, Mitsubishi, Seat, Audi, VW, etc.



14 PCS

## CLE POUR SONDE LAMBDA

52822 32,00€

22mm

0,41	5	20	-
Kg	Sub	ff	ff

- Clé hexagonale de 22mm avec fenêtre, permet l'extraction de sondes Lambda situés dans des endroits difficiles d'accès.



TÊTE ARTICULÉE



# OUTIL D'INSTALLATION ET DE DÉMONTAGE D'INJECTEURS DE CARBURANT POUR BMW MERCEDES BENZ

54220 197,00€

GASOLINA/PETROL

4,40	-	2	240
Kg	sub	ff	tr

## MARQUES

**BMW:**  
135is (2008-),335 (2007-),335xi (2007-),535i (2008-),535xi (2008-),550i GT (2010-),750Li (2009-)  
750i (2009-),X3 3.0i (2007-),X5 (2011-),X5 3.0i (2008-),X6 (2008-)  
**MERCEDES-BENZ:**  
C-class (2007-),CLK / SLK (2007-),E-class (2007-),A / CLA / GLA 45 AMG (2013-),CL / CLS 63 AMG (2010-),E / G / GL 63 AMG (2011-),GLE 63 AMG (2015-) / SL 63 AMG (2010-),SLK 55 AMG (2012-)

## OUTILS OEM

BMW : 130180(1), 130195(2), 130270(3), 130320(4), 2249115(5)  
Mercedes-Benz: 271589023300(6), 278589003300(7)

## CODES MOTEUR

BMW : N14 / N18 / N20 / N47 / N54 / N57 / N55 / N63  
Mercedes-Benz :M133 / M152 / M157 / M270 / M271 / M274 / M276 / M278

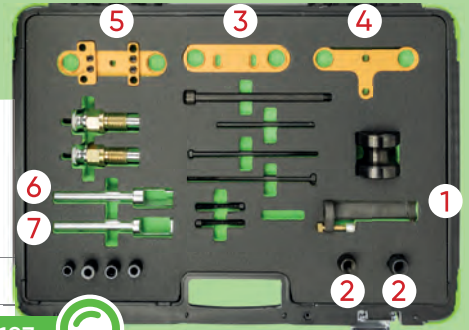

pg.183

## KIT DE RÉPARATION DE FILETAGE INTERNE ET EXTERNE

54003 104,00€

1,60	-	10	270
Kg	sub	ff	tr

Tailles de filetage:

- M14x1,5
- M16x1,5
- M18x1,5
- M20x1,5
- M22x1,5
- M24x1,5
- M27x2,0
- M28x1,5



9 PCS

CrMo



## COFFRET 7 PIÈCES POUR SYSTEME D'INJECTION LAMBDA

51119 62,00€

2,09	5	10	240
Kg	sub	ff	tr

1/2"

3/8"



- Contenu:
- Douille de 1/2" de 29x9 à 90mm long.
- Douille de 1/2" de 7/8" à 50mm long.
- Douille de 1/2" de 27x12 à 78mm long.
- Douille de 3/8" de 7/8" x 6 à 90mm long.
- Douille de 3/8" de 7/8" x 6 à 80mm long.
- Douille de 3/8" de 7/8" à 30mm de long.
- Douille de 3/8" de 1" y 1-1/16" à 74mm long.

## COFFRET KIT INSERTS HÉLICOÏDEAUX

51896 82,00€

115 PCS

2,10	-	5	300
Kg	sub	ff	tr



REF.	CARACTÉRISTIQUES	Kg	x5	€ / x5
52016	Inserts hélicoïdaux M5x0,8	0,01	10	2,10€
52017	Inserts hélicoïdaux M6x1,0	0,01	10	2,40€
52018	Inserts hélicoïdaux M8x1,25	0,05	10	2,60€
52019	Inserts hélicoïdaux M10x1,50	0,01	10	3,20€
52021	Inserts hélicoïdaux M12x1,75	0,02	10	3,40€

REF.	CARACTÉRISTIQUES	Kg	x5	€ / x5
52022	Inserts hélicoïdaux M14x2,0	0,01	10	4,50€
52023	Inserts hélicoïdaux M16x2,0	0,01	10	6,60€
52024	Inserts hélicoïdaux M18x2,5	0,05	10	10,60€
52025	Inserts hélicoïdaux M20x2,5	0,01	10	13,00€



- Contient par dimensions:
- Foret.
- Filière mâle de finition.
- Outil d'insertion hélicoïdal.
- Pointeur de rupture.
- Set de spirales en acier inox.

- Dimensions:
- 25 x M5x0,8
- 25 x M6x1
- 25 x M8x1,25
- 25 x M10x1,5
- 10 x M12x1,75

51897 122,00€

39 PCS

2,21	-	5	378
Kg	sub	ff	tr



- Contient par dimensions:
- Foret.
- Filière mâle de finition.
- Outil d'insertion hélicoïdal.
- Pointeur de rupture.
- Set de spirales en acier inox.

- Dimensions:
- 9 x M12x1,75
- 9 x M14x2
- 9 x M16x 2,0

## COFFRET KIT INSERTS HÉLICOÏDEAUX

53041 37,60€

0,54	-	10	1000
Kg	sub	ff	tr

- SPÉCIAL BOUGIES.



M14x1,25



51898 139,00€

1,81	-	4	252
Kg	sub	ff	tr

M18x2,5

51899 137,00€

2,12	-	4	252
Kg	sub	ff	tr

M20x2,5



- Contenu:
- Foret.
- Filière mâle de finition.
- Outil d'insertion hélicoïdal.
- Pointeur de rupture.
- Set de spirales en acier inox.

## COFFRET TARAUDS ET FILIÈRES DE 60 PIÈCES METRIQUE ET POUCE

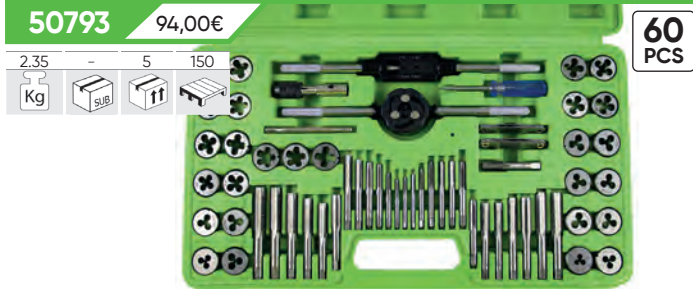

50793 94,00€

60  
PCS

2,35	-	5	150
Kg	Sub	ff	ff

1 mâle NPT (pouces): 1/8-27.  
1 dé de stock TNP (pouces): 1/8-27.  
1 mixte chiens Porta: M3 ~ M12 et 3/16" ~ 1/2".  
Les mâles Porta mixte de type 1T: M3 ~ M6 6-32 et 4-40.  
1 Taps Porta mixtes: 25mm de diamètre.  
1 Tournevis.  
1 Jeu de jauges métriques à la discussion.  
1 Jeu de vis des jauges en pouces.  
10 Mâles (métrique): M3x0.5, M4x0.7, M5x0.8, M6x1.0, M7x1.0, M8x1.25, M9x1.25, M10x1.0, M10x1.5, M12x1.75.

10 Mâles UNC (pouces): 4-40, 6-32, 8-32, 10-24, 12-24, 1/4-20, 5/16-18, 3/8-16, 7/16-14, 1/2-13.  
6 UNF Taps (pouces): 10-32, 1/4-28, 5/16-24, 3/8-24, 7/16-20, 1/2-20.  
10 Taps (métrique): M3x0.5, M4x0.7, M5x0.8, M6x1.0, M7x1.0, M8x1.25, M9x1.25, M10x1.0, M10x1.5, M12x1.75.  
10 UNC meurt (pouces): 4-40, 6-32, 8-32, 10-24, 12-24, 1/4-20, 5/16-18, 3/8-16, 7/16-14, 1/2-13.  
6 UNF Taps (pouces): 10-32, 1/4-28, 5/16-24, 3/8-24, 7/16-20, 1/2-20.

## COFFRET TARAUDS ET FILIÈRES DE 58 PIÈCES TITANE RECOUVERTES DE TITANE



50792 105,00€

58  
PCS

2,59	-	6	216
Kg	Sub	ff	ff

1 Mâle type NPT : 1/8-27.  
1 Filière type NPT : 1/8-27.  
1 Porte-Mâles : M4-M12.  
1 Porte-Mâles type T : M3-M6.  
1 Porte-Filières : 25 mm O/D.  
1 Tournevis.  
1 Set de jauges à fileter.

17 Mâles : 2x0.4, 3x0.6, 3x0.5, 3.5x0.6, 4x0.75, 4x0.7, 5x0.8, 6x0.75, 6x1.0, 7x0.75, 7x1, 8x1.0, 8x1.25, 10x1.25, 10x1.5, 12x1.25, 12x1.75.

17 Filières : 2x0.4, 3x0.6, 3x0.5, 3.5x0.6, 4x0.75, 4x0.7, 5x0.8, 6x0.75, 6x1.0, 7x0.75, 7x1, 8x1.0, 8x1.25, 10x1.25, 10x1.5, 12x1.25, 12x1.75.

## KIT DE TESTS DE PRESSION DU SYSTÈME DE REFROIDISSEMENT UNIVERSEL (5 PIÈCES)



54139 147,00€

5  
PCS

3,15	-	5	60
Kg	Sub	ff	ff

- Évite le retour d'essence vers le réservoir pendant le remplacement de la pompe à injection, filtres ou autres parties.  
- Après avoir remplacé les parties à changer, il permet de pomper l'essence qui se dirige vers la ligne d'injection.

## VÉRIFICATEUR DE PRESSION ET VIDE



53426 39,80€

0,90	4	16	160
Kg	Sub	ff	ff

VACIO VACUUM 0-28 inHg (0-70 cmHg)  
PRESIÓN PRESSURE 0-0,7 kg/cm<sup>2</sup> (0-10 PSIG)

## COMPRESSIOMÈTRE HUILE

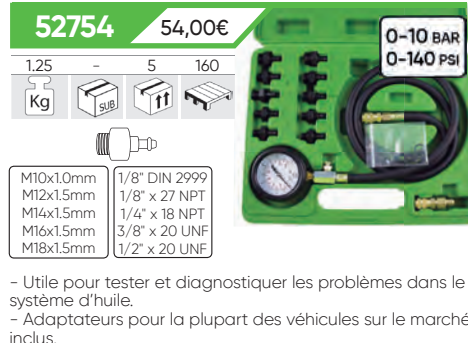

52754 54,00€

1,25	-	5	160
Kg	Sub	ff	ff

M10x1.0mm  
M12x1.5mm  
M14x1.5mm  
M16x1.5mm  
M18x1.5mm

- Utile pour tester et diagnostiquer les problèmes dans le système d'huile.  
- Adaptateurs pour la plupart des véhicules sur le marché inclus.

## MANOMÈTRE DE PRESSION DE TURBOCOMPRESSEUR



53489 68,00€

0,70	5	10	260
Kg	Sub	ff	ff

-1-3BAR  
2M

## COMPRESSIOMETRE DIESEL POUR CAMION



52685 88,00€

3,45	-	6	144
Kg	Sub	ff	ff

0-70 BAR  
0-1000 PSI

- Kit complet pour mesurer la compression des véhicules diesel.  
- Grand rang d'adaptateurs pour la plus part des véhicules sur le marché.  
- Système d'acrochage rapide dans les

endroits de difficile acces.  
- Adaptateur d'angles et adaptateur M18 et M24.  
- Dispose de valve de decharge et de système de retention de lecture.

## COMPRESSIOMETRE ESSENCE



52488 28,00€

0,65	5	20	300
Kg	Sub	ff	ff

0-300 PSI  
0-21 Kg/cm<sup>2</sup>

- Manomètre de double lecture (0-300psi, 0-2000kpa) avec valve de décompression.  
- Le SYSTÈME de attache rapide permet une mesure rapide et précise dans des points d'accès difficile.  
- L'adaptateur conique permet d'utiliser dans la plupart des véhicules du marché.

## JEUX DE PINCES POUR DÉCONNEXION DE TUYAU D'ESSENCE

53445 17,10€

0,35 12 48 576



5/16"  
8mm Ø



3/8"  
10mm Ø

APPLICATION  
SPÉCIALE



## COMPRESSIOMÈTRE POUR CIRCUITS ESSENCE

53997 48,00€

1,40 - 5 150



- Pour détecter les défauts dans le système de carburant.
- L'appareil est compatible avec les systèmes d'injection Schrader.



- 1 Longueur: 25,5 cm  
Diamètre extérieur: 1,2 cm  
Diamètre intérieur: 0,6 cm
- 2 Longueur : 29,5 cm  
Diamètre extérieur: 1,2 cm  
Diamètre intérieur: 0,6 cm
- 3 Longueur: 110cm

## COMPRESSIOMÈTRE POUR CIRCUITS ESSENCE

52599 230,00€

4,00 - 5 60



0-145  
PSI

0-1000  
KPA



- Le kit comprend tous les outils dont vous avez besoin pour vérifier le système d'injection de carburant sur la plupart des véhicules nationaux et étrangers.
- L'emballage comprend un appareil de mesure 3-1/2" avec des lectures de 0-145 psi et 0-1 000 kPa et un appareil de mesure 2-1/2" avec deux modes de lecture.
- Tous les adaptateurs, appareils de mesure et raccords de tuyaux sont équipés d'un système de déconnexion rapide.



## COMPRESSIOMÈTRE DIESEL

52489 58,00€

2,15 - 6 144



- Ford, BMW, Mercedes Benz, VW, Citroën, Mitsubishi, Toyota, Peugeot, Renault, Volvo, Mazda.

- Kit complet pour mesurer la compression des véhicules diesel.
- Large gamme de raccords pour utiliser dans la plupart des véhicules du marché.
- SYSTÈME de attache rapide et précise dans des point d'accès difficile.
- Adaptateur en angle et raccords de M18 et M24.
- Dispose de valve de décharge et de SYSTÈME de retenon de lecture.



0-1000 PSI  
0-70 Kgs/cm<sup>2</sup>



M18x1.5mm  
M24x2.0mm  
M24x1.5mm

M10x1.0x68mm  
M10x1.25x54mm  
M10x1.25x68mm  
M12x1.25x45mm

## COMPRESSIOMÈTRE DIESEL / DCI MULTIMARQUE

51893 690,00€

4,25 - 3 54



0-1000 PSI  
0-70 Kgs/cm<sup>2</sup>



- Kit de vérification et adaptateurs de l'et d'injection.
- Grands, 2-1/2, 70 kg/cm<sup>2</sup> (1 000 PSI) mesureur protégé par gomme, droit et en angle droit.
- Accessoires de connexion instantanée et une vaste plage d'adaptateurs.
- Apte pour couvrir la plupart des véhicules, camions, camionnettes, autobus, machines agricoles et moteurs marins diesel.
- Avec des adaptateurs de: gamme d'Alfa, BMW, Chrysler, Daewoo, Fiat, Ford, Hyundai, IZUSU, Land Rover, LDV, Mazda, Mercedes, Mitsubishi, Nissan, Opel, PSA, Renault, Suzuki, Saab, Toyota, VAG, Opel, Volvo diesel.
- Injecteur: M20, M22, M24 et Ford.

## KIT DE TEST DE COMPRESSION DES MOTEURS ESSENCE ET DIESEL

53490 275,00€

5,50 - 2 40



- Alfa Romeo, BMW, Chrysler, Citroën, Daewoo, Fiat, Ford, Honda, Hyundai, Isuzu, Jeep, Kia, Lada, Lancia, Land Rover, LDV, Mazda, Mercedes, MG, Mitsubishi, Nissan, Peugeot, Renault, Rover, Saab, Ssangyong, Suzuki, Toyota, VAG, Vauxhall/ Opel, Volvo.

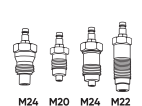

Ø 10, 12, 14, 18mm



# COFFRET RÉPARATION DE BOUGIES DE PRÉCHAUFFAGE

52076 111,00€

0,85	-	10	36
Kg	sub	ff	ff

- Outil d'insertion - 2pcs.
- Poignée Partie 8 - 1 pc.
- Filetage M8 x 1,0 - 5pcs.
- Filetage M10 x 1,0 - 5pcs.
- Filetage M10 x 1,25 - 5pcs.
- Filetage M12 x 1,25 - 5pcs.
- Têtes d'insertion - 3pcs.
- Insertion tige filetée - 1 pc.

- Plaquette de coupe M14 x 1,25 (pour M12 x 1,25 fil) - 1 pc.
- Plaquette de coupe M12 x 1,25 - 1 pc.
- Plaquette de coupe M12 x 1,0 (filetage M10 x 1,25) - 1 pc.
- Plaquette de coupe M10 x 1,25 - 1 pc.
- Plaquette de coupe M10 x 1,0 (pour filetage M8 x 1,0) - 1 pc.
- Plaquette de coupe M8 x 1,0 - 1 pc.

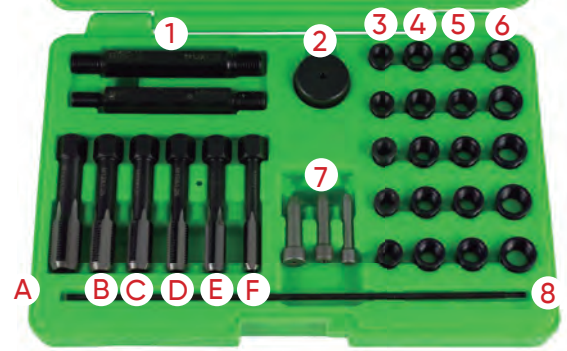

REF.	CARACTÉRISTIQUES	Kg	sub	ff	ff	€
11893	Helicoïdaux M8x1,0	0,01	5			7,00€
11894	Helicoïdaux M10x1,0	0,01	5			7,00€
11895	Helicoïdaux M10x1,25	0,05	5			8,65€
11896	Helicoïdaux M12x1,25	0,01	5			8,80€

## EXTRACTION BOUGIES PRÉCHAUFFAGE ENDOMAGÉES

52305 106,00€

1,79	-	10	180
Kg	sub	ff	ff

16 PCS



- Extracteur de bougie de préchauffage de 16 pièces. Ce kit est utile pour l'extraction, cassé ou bloqué.
- Universel et idéal pour les moteurs Mercedes-Benz CDI.
- Extrait réchauffeurs cassés ou endommagé M8 et M10.
- Comprend les robinets 1/4" M8 at forets étagé de hautesrésistance double taille M8 et M10.

## COFFRET EXTRACTEURS BOUGIES DE PRÉCHAUFFAGE

52815 110,00€

0,95	-	5	280
Kg	sub	ff	ff



- Outils spécialement créé pour extraire les extrémités d'électrode dans le cas où celui-ci se casse pendant le processus d'extraction.
- Facilite l'extraction sans avoir besoin de LÈVER la culasse.

## PINCE POUR BOUGIES DE PRÉCHAUFFAGE

52816 28,10€

0,27	6	36	-
Kg	sub	ff	ff

52817 23,50€

0,27	6	36	-
Kg	sub	ff	ff

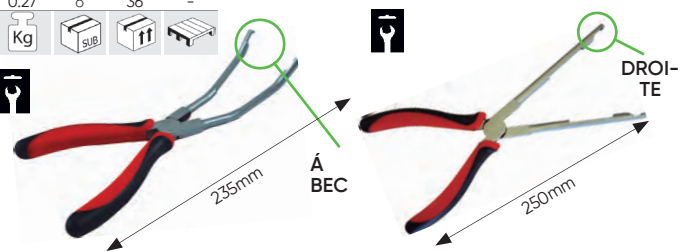

- Pince utile pour extraire les connecteurs chauffe-diesel.
- Conseillé pour une extraction rapide.
- Avec les connecteurs localisés dans les endroits difficiles d'accès, ces pinces permettent de réaliser la manipulation sans aucun risque d'endommager le chauffage ou autre partie du véhicule.
- Manche caoutchouc ergonomique.

## SET DE DOUILLES TWIST DE 1/2" EXTRACTION D'ÉCROUS ENDOMAGÉS

52153 46,00€

0,93	5	20	640
Kg	sub	ff	ff

17, 19, 21, 23, 27mm 1/2"



## SET DE DOUILLES TWIST DE 3/8" EXTRACTION D'ÉCROUS ENDOMAGÉS

51998 38,00€

0,69	5	20	360
Kg	sub	ff	ff

9, 10, 11, 12, 13, 14, 15, 16, 17, 19mm 10 PCS



52962 42,00€

0,75	5	20	1500
Kg	sub	ff	ff

6, 8, 10, 11, 12, 13, 14, 15, 16, 17, 19mm 11 PCS



NOUVEAU DESIGN: PARTIE HEXAGONALE

# KIT DE RETRAIT DES BOULONS DE SECURITE DES ROUES

54253 166,00€

1,85	-	-	700
Kg	sub	ff	

Kit principal facile à utiliser capable d'enLÈVer pratiquement n'importe quel écrou de roue de blocage.  
Le kit comprend des protecteurs qui protègent la roue de tout dommage.  
Très efficace et un outil d'atelier indispensable.  
Le kit contient deux tailles de lames de coupe à impact pour s'adapter à la plupart des écrous de roue de verrouillage en coupant le bord extérieur.  
Sont également incluses trois lames à double face pour le moulage directement dans la forme du socle.  
Universel - supprime une large gamme de tailles, de types et de profils, y compris ceux avec des colliers pivotants  
Comprend un tournevis à percussion et un poinçon.



## JEU DE VIS DE SECURITÉ POUR BMW

53208 126,00€

0,95	5	20	-
Kg	sub	ff	

- BMW Serie 1 F20/F21.
- BMW Serie 3 F30/F31.
- BMW Serie 4 F32/F34/F36.
- BMW Serie 5 F10/F11.
- BMW Serie 6 F12/F13.
- BMW Serie 7 F01/F02/F04.



## JEU DE VIS DE SECURITÉ POUR VW

53207 118,00€

1,55	5	10	330
Kg	sub	ff	

- b51 / 6pt
- b52 / 7pt
- b53 / 8pt
- b54 / 9pt
- b55 / 10pt
- b56 / 11pt
- b57 / 12pt
- b58 / 13pt
- b59 / 14pt
- b60 / 15pt
- b61 / 16pt
- b62 / 17pt
- abc0 / 10pt
- abc1 / 11pt
- abc2 / 13pt
- abc3 / 14pt
- abc4 / 15pt
- abc5 / 16pt
- abc6 / 17pt
- abc7 / 19pt
- abc8 / 20pt
- abc9 / 21pt



## JEU DE D'EMBOUTS POUR VIS DE SECURITE POUR BMW

52802 54,00€

0,62	-	20	-
Kg	sub	ff	

- 30/13 PT,31/15 PT,32/16 PT,33/17 PT,34/18 PT,35/19PT,36/20 PT,37/21 PT,38/22 PT,40/23 PT

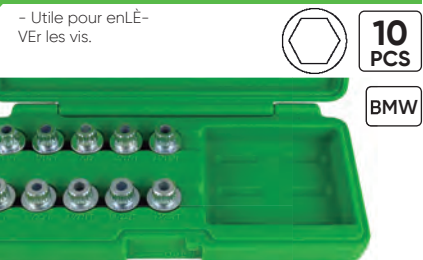

## JEU DE VIS DE SECURITÉ POUR VAG

52823 124,00€

0,94	5	20	-
Kg	sub	ff	

- Conçu spécialement pour enLÈVer les vis de sécurité sur roues de véhicules Volkswagen, couvrant pratiquement 100% de la flotte de véhicules VW sur le marché.



## JEU DE D'EMBOUTS POUR VIS DE SECURITE POUR MERCEDES

53328 76,00€

0,60	5	20	-
Kg	sub	ff	

- Classe A, B, C, GLK, CLC, CLS, CLK, E, SL, SLK, M, C300, C250, C350, E320, 204, 211, 212, R.



## KIT DE RESTAURATION DE FILETAGE DE GOUJONS DE ROUE

53652 53,00€

0,94	5	10	240
Kg	sub	ff	

- M12x1.25 - PSA
- M12x1.5 - MERCEDES BENZ / BMW
- M12x1.75 - VOLVO
- M14x1.5 - VAG



- Ensemble d'outils pour la réparation et la remise en état des boulons de roue, ainsi que pour son ancrage dans le filetage femelle du véhicule; utile dans les discussions partiellement endommagées.

## COFFRET D'EXTRACTION BOBINES D'ALLUMAGE VAG POUR VW

51495 59,00€

0,96	-	20	200
Kg	sub	ff	

- Pour enLÈVer et installer les bobines d'allumage avec couvercle de moteurs à injection de VW CYL 8 et 12 / 5 et 6 CYL, VW GOLF, BORA, 4 et 5 CYL, VW Passat, 6 CYL, Sharan VW, Touareg, Phaeton.  
- Pour extraire et installer les bobines d'allumage avec étape de puissance de la VW Polo, Golf 1.4, 1.6i, 1.4i CADDY, BORA 1.4, 1.6 i Phaeton, Passat, Touran 1.6i, Transporter T4.



## PIÈCES DE RECHANGE DISPONIBLES

DISQUE DE RÉPARATION		BOULON DE RÉPARATION							
REF.	CARACTÉRISTIQUES	Kg	ff	€	REF.	CARACTÉRISTIQUES	Kg	ff	€
14344	M12x1.25	0,49	20	11,00€	14340	M12x1.25 - PSA	0,05	20	10,50€
14345	M12x1.5	0,50	20	11,00€	14341	M12x1.5 - MERCEDES / BMW	1,14	20	10,50€
14346	M14x1.5	0,46	20	11,00€	14342	M12x1.75 - VOLVO	1,12	20	10,50€
					14343	M14x1.5 - VAG	1,29	20	10,50€



## EXTRACTEUR DE GOUJONS QUEUE DE COCHON

**51496** 8,00€

0,12 12 72 2016  
Kg SUB fff

**5**  
PCS

N° 1: 1/8" - 1/4" (M 3-6)  
N° 2: 1/4" - 5/16" (M 6-8)  
N° 3: 5/16" - 7/16" (M 8-11)  
N° 4: 7/16" - 9/16" (M 11-14)  
N° 5: 9/16" - 3/4" (M 14-18)

- Fabriqué à partir d'un traitement thermique d'acier au chrome molybdène.  
Permet une élimination rapide à l'aide des hélices en agissant comme une vise.

## SET D'EXTRACTEURS DES TARAUDS

**53502** 38,70€

0,55 5 20 900  
Kg SUB fff

**9**  
PCS

#2 M5  
#3 M6  
#4 M8  
#5 M10  
#6 M12  
#7 M14  
#8 M16  
#9 M20  
#10 M22

## JEU DE DOUILLES EXTRACTEUR POUR GOUJONS

**52833** 39,30€

0,80 5 20 -  
Kg SUB fff

**1/2"**

6, 8, 10, 12mm

PIÈCES DE RECHANGE DISPONIBLES

REF.	DESCRIPTION	Kg	SUB	fff	€
14211	6mm	0,10	20	100	11,00€
14212	8mm	0,10	20	100	12,00€
14213	10mm	0,20	20	100	12,00€
14214	12mm	0,20	20	100	14,00€

## COFFRET EVASEMENT TUYAU FREIN

**52700** 20,50€

0,95 6 12 468  
Kg SUB fff

3/16, 1/4, 5/16, 3/8, 1/2

## COFFRET DE CLÉS A BOUGIES ARTICULÉES

**52691** 54,00€

0,79 6 24 480  
Kg SUB fff

8, 9, 10, 12, 14, 16mm

**3/8"**

AVEC SYSTÈME MÉCANIQUE DE SUJÉTION

## CLÉ A BOUGIE MAGNÉTIQUE

**52317** 19,90€

0,30 12 72 2880  
Kg SUB fff

250mm **3/8"**

∅16mm

**52316** 18,90€

0,20 12 48 2880  
Kg SUB fff

∅14mm

## DOUILLE DE BOUGIE

**10054** 2,90€

0,08 10 100 -  
Kg SUB fff

16mm

**10055** 3,90€

0,14 10 100 -  
Kg SUB fff

21mm

CAOUTCHOUC À L'INTÉRIEUR



## COFFRET DÉMONTAGE POULIES ALTERNATEUR 30 PIÈCES

52293 98,00€



- 1/2" T50 c/33 dents 19mmX33T - 110mmL.
- 1/2" M10 c/33 dents 19mmX33T - 110mmL.
- H15x33 dents 15mmx33T - 30mmL.
- H22x33 dents 22mmx33T - 30mmL.
- H22 - 30mmL.
- H17x4 Pins special H17x4Pins- 30mmL.
- 1/2"Dr. xH10Bit adaptateur.
- H8 xH10 Pointe 75mmL.
- H10xH10 Pointe 75mmL.
- M8xH10 Pointe 75mmL.
- M10xH10 Pointe 75mmL.
- T40 xH10 Pointe 75mmL.
- T50xH10 Pointe 75mmL.
- M10XH12 Pointe 64mmL.
- Special H22xH28 - 30mmL.

- Special H19xH28 - 30mmL.
- 1/2"Dr.XM10 pointe M10 - 140mmL.
- 3/8:Dr.xM10 c/31 dents 14mmx31T- 85mmL.
- Special H21xH28 - 30mmL.
- Special H17 - 35mmL.
- Special H38x3Pins-20mmL.
- Special 15mmx33T- 30mmL.
- H10xFH10 x68L 68mmL.
- T50XH12 Bit 64mmL.
- Special H 17 x H 21-30mmL.
- Special H15xH28 - 30mmL.
- 3/8" Adaptateur x10mm.
- 1/2"Dr.XT50 pointe T50 140mmL.
- 1/2"Dr.XT50 pointe T50 200mmL.
- 1/2"Dr.XM10 pointe T50 200mmL.

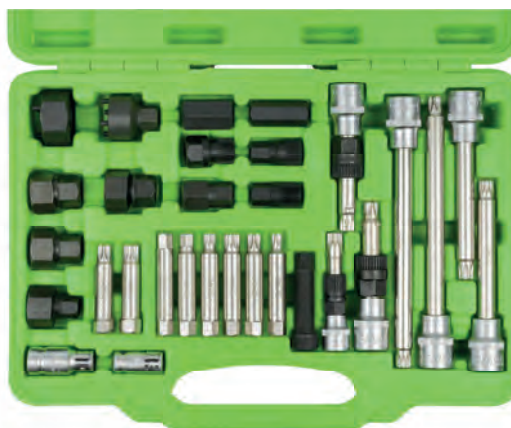

30  
PCS

## COFFRET DÉMONTAGE POULIES ALTERNATEURS 18 PIÈCES

51259 58,00€



- 3 x Douilles combiné: T50x113mm, M10x113mm, M10x90mm.
- 1 x Douille denté: M10x140mm.
- 2 x Adaptateurs hexag. 19 și 22mm.
- 3 x Douille hexagonal: 22x28mm, 19x28mm, 21x28mm.
- 1 x Adaptateur.
- Hex. 1/2" x 10mm.
- 1 Point M10x12x64L.
- 6 x Pointe 10mm x 75mm.
- Mesures: T40, T50, M8, M10, H8, H10.



18  
PCS

### PIÈCES DÉTACHÉS DISPONIBLES



10494 6,50€

DOUILLE RALONGE  
14cm



10495 3,00€

POINTE H10



10496 3,00€

POINTE H8



10497 3,00€

POINTE M10



10498 3,00€

POINTE M8



10499 3,00€

POINTE T40



10500 3,00€

POINTE T50



10501 8,10€

DOUILLE POINTE  
XZN M10 90mm

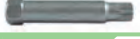

10502 3,50€

POINTE M10 TORX



10485 8,10€

DOUILLE POINTE  
XZN M10 110mm



10486 8,00€

DOUILLE POINTE  
TORX T50 110mm

## JEU DE CLÉ COURBÉES POUR EXTRACTION DE POULIES

52832 75,00€



12, 13, 14, 15, 16,  
17, 18, 19mm



TÊTE  
INTERCHANGEA-  
BLE

## CLÉ UNIVERSELLE BLOCAGE POULIES

52690 54,00€



- Levier 230 mm avec queue 1/2".
- Levier 585 mm avec queue 3/8".
- 3 têtes 13, 14, 15 mm avec queue carrée 3/8".
- 4 têtes hexagonales 13, 15, 16, 18 mm avec queue carrée 3/8".

3/8"

1/2"

1/2" 230mm

3/8" 585mm

## EXTRACTEUR D'ÉCROUS

51368 19,00€

0.41	5	50	1000
Kg	SUB	↑↑	↑↑

∅  
↑ 42mm  
↓ 33mm



## EXTRACTEUR D'ÉCROUS AXIAUX

51369 28,00€

0.55	6	36	756
Kg	SUB	↑↑	↑↑

∅  
↑ 42mm  
↓ 35mm



## EXTRACTEUR POUR GOUJONS

51414 14,00€

0.59	5	40	1440
Kg	SUB	↑↑	↑↑

∅  
↑ 20mm  
↓ 15mm



## OUTIL DE RÉGLAGE DE CARROSSAGE (VAG)

53488 61,00€

2.75	-	5	200
Kg	SUB	↑↑	↑↑

- Permet à une seule personne d'ajuster l'angle de chute de la roue.

- Comprend:  
Broche hexagonale de 22mm.  
3 longueurs différentes:  
- 75mm: Seat - Toledo | VW - Jetta / Golf.  
- 85mm: Seat - Cordoba | VW - Polo / Golf.  
- 115mm: Chrysler - Voyager.



## NIVEAU DE CARROSSAGE MAGNÉTIQUE

52318 73,00€

0.64	6	24	336
Kg	SUB	↑↑	↑↑

-6° / +6°



## COFFRET EXTRACTEUR POULIE ALTERNATEUR

52624 28,00€

1.25	-	5	450
Kg	SUB	↑↑	↑↑

- Contient:  
2 x vise 5/16 nt" de 4".  
2 x vise 1/4" de 3".  
3 x vise 1/4" de 2".  
3 x vise 5/16" de 2".  
1 x 5" vise de pression en alliage aluminium.  
1 x pointa giratoire 3/4".



## EXTRACTEUR POULIES

51500 29,00€

1.55	-	10	640
Kg	SUB	↑↑	↑↑

40-168mm

- Apte pour une utilisation dans des vilebrequins, alternateurs, unités d'AC et pompes à eau.  
- Les bras du profilé bas permettent un accès facile à des zones difficiles du moteur.  
- Conçu pour l'extraction du vilebrequin cannelé, coincé et de poulies auxiliaires.  
- Rang: 40-160mm.



## EXTRACTEUR DE POULIES UNIVERSEL

53664 38,00€

0.80	-	10	2500
Kg	SUB	↑↑	↑↑

- Utilisation universelle.  
- Option de multiposition pour s'adapter à la plupart des poulies.  
- Idéal pour travailler dans des zones étroites, en économisant du temps de travail.

- Mesures:  
Tige de 16mm de diamètre avec bille de centrage et tête hexagonale de 24mm.

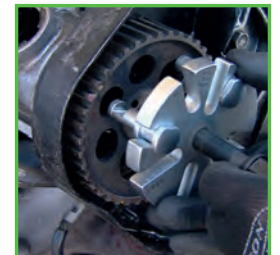

## OUTIL POUR EMBRAYAGE FIAT

52190 8,00€

0.39	-	10	1000
Kg	SUB	↑↑	↑↑

220x110mm



Fournit un accès à la tige de la fourche pour l'enlèvement et le remplacement postérieur du disque.  
Longueur: 22cm, largeur: 11cm  
Vis: 1,5cm de large x 0,5cm diam.  
Spécifications: Outil pour enLEVER la fourche d'embrayage de la Fiat Ducato



## CROCHETS POUR L'EXTRACTION DE JOINS

53053 12,00€

0.21	10	50	1000
Kg	SUB	↑↑	↑↑

1x15.5cm / 1x16.5cm / 1x12cm



## LEVIER UNIVERSEL POUR AXES ET ROTULES

**51902** 84,00€

4,90	-	1	66
Kg	sub	ff	

- Dimensions:  
Longueur: 1180mm.  
Diam. Tube: 3,5 cm.  
Distance d'ancrages:  
50, 45, 40, 35, 30 cm.  
Ancrage de 15x13 cm.



RECHANGE ANCRE DE  
FIXATION POUR REF.  
51902

**10953** 12,50€



## COFFRET D'OUTILS POUR MONTAGE ET DEMONTAGE BIELLETES ET ROULES

**52639** 123,00€

5,05	-	4	84
Kg	sub	ff	

Ø 30-35mm  
Ø 35-40mm  
Ø 40-45mm



## ALIGNEUR DE DIRECTION

**51991** 48,00€

1,15	-	10	120
Kg	sub	ff	

- Longueur totale ouvert: 1 950mm.  
- Longueur totale fermé: 1 100mm.  
- Dimensions de vis: M6x15mm.  
- Tube extérieur de 20x20 en aluminium.  
- Tube intérieur de 16x16 en fer zingué.

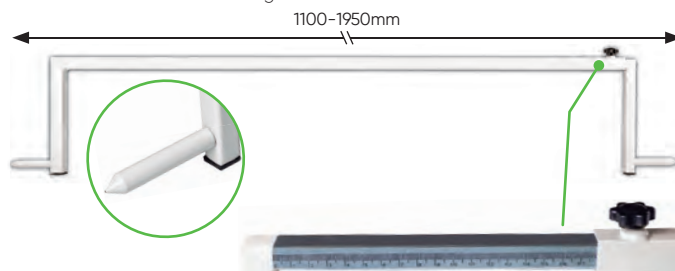

## OUTIL MONTAGE ET DÉMONTAGE BIELLETES ET ROULES

**52640** 52,00€

1,80	-	4	256
Kg	sub	ff	

Ø 28-35mm

**52641** 55,00€

2,20	-	4	140
Kg	sub	ff	

Ø 35-45mm



## CLÉ EXTRACTION DE BRAS DE DIRECTION

**52874** 82,00€

1,20	4	20	1500
Kg	sub	ff	

Ø 9-20mm

**52875** 79,00€

1,25	5	20	1500
Kg	sub	ff	

Ø 14-23mm



## COFFRET DE 12 PIÈCES EXTRACTION D'AIRBAGS

**51501** 38,00€

0,88	5	20	240
Kg	sub	ff	

- Pointes 0.5 PC 1/4" x 87 mm (L):  
2x Torx: T25 (pour BMW), T30 (pour Audi, Opel, Renault, VW).  
2x Torx (inviolable): T25H (Pour BMW), T30H (Pour AUDI, BMW, Mercedes, Opel).  
1x Hex : 5 mm (Pour AUDI).

- 0.7 PC Outil extraction:  
1x pour Airbag conducteur. 1999-04 nouveau style de carrosserie de VW Passat, JETTA, GOLF.  
2x pour VW Passat B5, POLO, LUPO, AUDI A4, A6, Skoda Superb.  
2x pour VW GOLF 4, New Beetle, SEAT, SKODA FABIA, AB Oktavia BJ.99.  
1x pour VW GOLF 4 (BJ, 1998-2004), VW PASSAT BJ.1997 AB, AB BORA BJ.1999.  
1x pour U.A VW-MODELLE : AB PASSAT BJ.2000.

**12**  
PCS



## EXTRACTEUR DE ROTULES HYDRAULIQUE

53384 165,00€

7,30	-	2	74
Kg	sub	ff	tr



- Ouverture: 100mm.  
- Largeur: 35mm.

10kg



1 1/2"-16UNF

M20X1.5

BROCHE HYDRAU-  
LIQUE

15253

62,00€

## COFFRET DE 5 ARRACHES ROTULES

51123 91,00€

5,29	-	2	136
Kg	sub	ff	tr



- Ce système permet l'extraction facile des types les plus populaires d'articulations de rotule et d'autres.  
- Le type de séparateur de la presse du joint permet le retrait du joint de rotule sans endommager les chargeurs et d'autres pièces, ce que font d'autres types d'extracteurs.

## COFFRET EXTRACTION DE ROTULES

51490 36,00€

1,88	-	5	300
Kg	sub	ff	tr

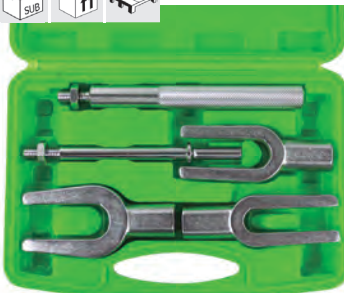

- Fourches faites en acier chrome vanadium forgé de haute résistance.  
- Les deux manches sont interchangeables.  
- 1 manche conçu pour être utilisé avec un marteau pneumatique.

- Contient:  
1 Manche pour son utilisation avec un marteau.  
3 fourches: 11/16, 15/16 et 1-1/8.

## LEVIER CONTRÔLE DES JEUX DANS LES AXES

52541 45,00€

2,10	-	10	110
Kg	sub	ff	tr



- Pour détecter mouvement: Roulements, silentblocs, roulements de roues, articulation axes, paliers cardans, support stabilisateurs, etc

## ARRACHE ROTULE

52642 32,00€

1,32	5	20	600
Kg	sub	ff	tr



- Ouverture Max: 60mm.  
- Ouverture Min: 20mm

17 - 22mm

2 DIMENSIONS  
AJUSTABLES

## ARRACHE ROTULES

52699 22,00€

0,80	5	30	1050
Kg	sub	ff	tr



- Ouverture: 15-50mm.

Ø 18-22mm

## COFFRET DÉCOLLEURS DE ROULEMENTS

51125 88,00€

4,72	-	5	160
Kg	sub	ff	tr

Capacité des Guillotines:

- Set Pouce:  
1/4", avec 30 mm et 50 mm.  
Vis de 3/8" de 95x125 - 24 UNF.  
Tête de 3/8" x 16 UNC.

- Set 2 Ponces:  
1/4" - 3 1/2", avec 50 x 75mm.  
Vis de 1/2" de 12,7x135 - 20 UNF.  
Tête de 3/8" x 16 UNC.



## DÉCOLLEUR DE ROULEMENTS

52626 46,00€

3,65	-	5	800
Kg	sub	ff	tr

75 - 105mm

52627 120,00€

6,50	-	2	231
Kg	sub	ff	tr

105 - 150mm

- Pour extraire les roulements dans les véhicules commerciaux légers.



## DOUILLE POINTE XZN

12029 5,50€

0,17	5	100	1500
Kg	sub	ff	tr



INVOLABLE  
M16X58MM



12030 6,50€

0,25	8	80	-
Kg	sub	ff	tr



INVOLABLE  
M16X100MM



CrV 1/2"

# KIT D'ARRACHE-PIÈCES UNIVERSEL AVEC 2/3 PINCES

**53701** 188,00€

**13**  
PCS

8,45	-	1	44
Kg	Sub	ff	ff

- Plage de travail 2 pattes: 45-120mm.
- Plage de travail 3 pattes: 50-130mm.
- Profondeur de serrage: 100, 200, 250mm.

- Pièces incluses:
- Guide central pour 3 pattes.
- Guide central pour 2 pattes.
- Goujon: 275mm.
- Goujon: 165mm.
- Pattes longues avec pinces: 250mm.
- Pattes moyennes avec pinces: 200mm.
- Pattes courtes avec pinces: 100mm.



**POINTE DE GRIFFE POUR REF. 53701**

**14611** 0.10 50  
12,00€ Kg ff

**VIS POUR REF. 53701**

165mm

**14612** 0.15 20  
11,00€ Kg ff

**VIS POUR REF. 53701**

275mm

**14613** 0.30 20  
13,50€ Kg ff

## COFFRET EXTRACTION ROULEMENT

**51124** 88,00€

3,20	-	5	120
Kg	Sub	ff	ff

- Contient:
- Extracteur Universel (38,5mm).
- Adaptateur de 3/8" à 1/2" (10-14mm).
- Adaptateur de 9/16" à 11/16" (15-19mm).
- Adaptateur de 5/8" à 1" (18-25mm).
- Adaptateur de 1" à 1 1/4" (25-32mm).



## EXTRACTEUR DE TERMINAL AVEC SIX CONNECTEURS

**54112** 18,00€

0,04	20	100	1800
Kg	Sub	ff	ff

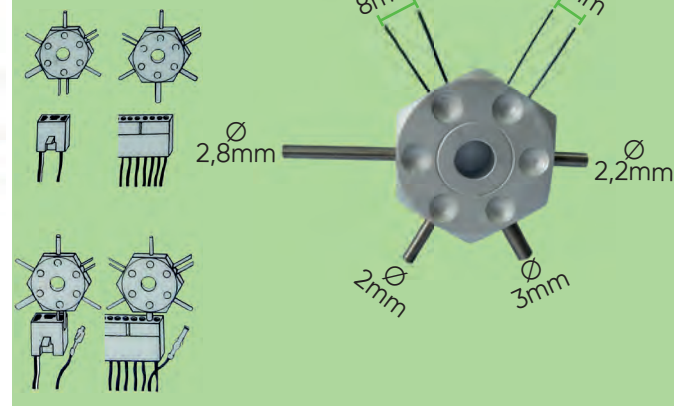

## EXTRACTEUR UNIVERSEL POUR INTERIEURS / EXTERIEURS

**53250** 85,00€

4,80	-	4	72
Kg	Sub	ff	ff

- Matériel: acier.
- Extraction externe: de 40 à 80mm.
- Extraction interne: de 50 à 150mm.

- Matériel: chrome molybdène SD45C.
- Pour moteurs VW, Audi DIESEL.
- Applications: 1.4 SDI, TDI, 1.9 D, SDI, TDI, TDI (PD), 2.0 TDI (PD) & (PD 4-VALVES), 2.5 TDI / TDI (PD), 2.8 TDI (PD), 2.7, 3.0 TDI (Common Rail), 4.2 TDI (Common Rail).

## EXTRACTEUR DE COUSSINETS AVEC FAUSSES SPHERES

**53062** 99,00€

2,41	-	10	160
Kg	Sub	ff	ff

5, 6, 8, 9, 11, 12,5mm

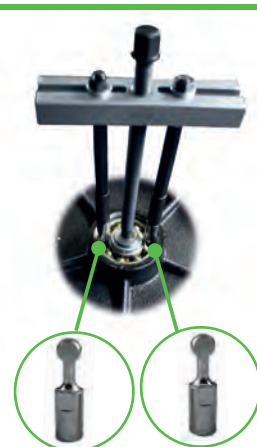

## EXTRACTEUR 2 GRIFFES

**52727** 34,60€

0,20	10	60	1200
Kg	Sub	ff	ff

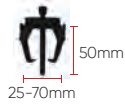

**52728** 68,00€

1,20	5	10	500
Kg	Sub	ff	ff

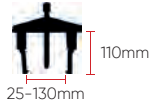

52727



## PRÉSENTOIR POUR EXTRACTEURS

**53146** 30,50€

0,70	5	10	140
Kg	Sub	ff	ff



- Extracteurs non inclus.

**52729** 128,00€

3,39	-	3	240
Kg	Sub	ff	ff

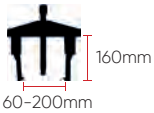

**52730** 288,00€

8,57	-	2	108
Kg	Sub	ff	ff

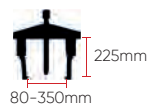

52728

52729

52730

## EXTRACTEUR 3 GRIFFES

**52731** 38,00€

5,30	4	24	504
Kg	Sub	ff	ff

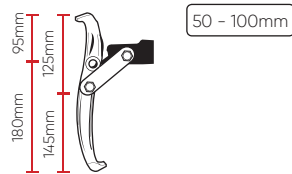

**52732** 58,00€

2,54	5	20	200
Kg	Sub	ff	ff

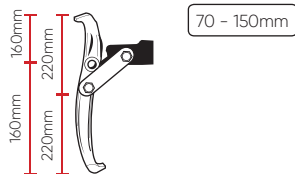

**52733** 98,00€

5,20	-	4	112
Kg	Sub	ff	ff

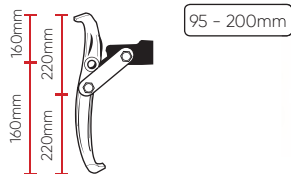

## EXTRACTEUR 3 GRIFFES CONVERTIBLE EN 2 RÉVERSIBLE

**52010** 80,00€

0,50	4	40	360
Kg	Sub	ff	ff

- Dimensions de la griffe: 90mm.
- Dimensions de la clavette: 124mm.
- Onglet de saisie: 12mm.
- Largeur de la croix: 66mm.
- Profondeur: 75mm.



**52296** 119,00€

1,57	4	8	120
Kg	Sub	ff	ff

- Dimensions de la griffe: 132mm.
- Dimensions de la clavette: 217mm.
- Onglet de saisie: 14mm.
- Largeur de la croix: 95mm.
- Profondeur: 110mm.



**52298** 177,00€

2,65	3	6	396
Kg	Sub	ff	ff

- Dimensions de la griffe: courte 134mm, longue 207mm.
- Dimensions de la clavette: 218mm.
- Onglet de saisie: courte 13mm, longue 15mm.
- Largeur de la croix: 95mm.
- Profondeur: 110 - 180mm.

LONGUE ET COURTE



**52297** 172,00€

3,33	-	6	36
Kg	Sub	ff	ff

- Dimensions de la griffe: 210mm.
- Dimensions de la clavette: 313mm.
- Onglet de saisie: 15mm.
- Largeur de la croix: 152mm.
- Profondeur: 180mm.



## SET DE 52 PIÈCES POUR EXTRACTION D'ÉQUIPEMENTS AUDIO

**53388** 90,00€

1,50	-	5	120
Kg	Sub	ff	ff



52 PCS

## KIT DÉMONTAGE AUTO-RADIO

**51126** 18,00€

0,20	10	100	1500
Kg	Sub	ff	ff



10 PCS

- Blaupunkt, Clarion, Skoda, BMW, Audi, Grundig, JVC, Pioneer, Volkswagen, Mercedes, Opel Doppel-Kugel-Inbus, Porsche, Becker, Kenwood, Sony, Panasonic, Fiat Brava, Ford.

- Blaupunkt, Peugeot, Clarion, Skoda, Alpine, BMW, Opel, Audi, Grundig VDO, JVC, Pioneer, Volkswagen, Mercedes, Porsche, Renault, Becker.

## SET DE 23 EXTRACTEURS DE TERMINAL

53393 118,00€

23  
PCS

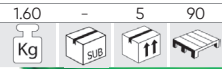

- BMW, Audi, Volkswagen, Mercedes, Opel, Porsche, Jaguar, Saab, Seat, Ford, Skoda, Renault, Citroën, Chrysler, Fiat, Honda, Mazda, Mitsubishi, Toyota.

## SET DE 19 EXTRACTEURS DE TERMINAL

53391 86,00€

19  
PCS

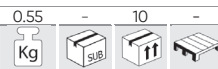

## EXTRACTEUR SILENT-BLOCK AVANT VAG

52432 35,00€

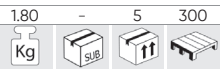

- Utile pour VW POLO 2002.  
- Facilite la modification des coussinets en caoutchouc sur l'essieu avant.

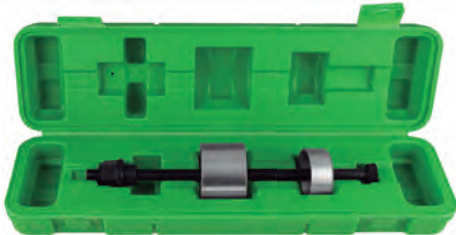

## COFFRET MONTAGE ET DÉMONTAGE SILENT-BLOCK

52270 109,00€

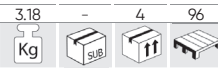

- Contient:  
Axe, Extension de axe, Vis M10x1.25.  
Adaptateur en acier au carbone.  
Separateur.  
Piece de pression.  
Mandril de centrage en aléation en aluminium.



## JEU DE DOUILLES AVEC ERGOTS EXTÉRIEURS

52834 195,00€

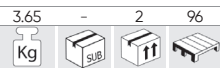

- Set douilles pour extraire les noix de splines dans les véhicules industriels.

11  
PCS

1/2"

CR-MO

mm  
22x3.3  
26x3.8  
30x4.3  
33x4.0  
37x4.8  
44x5.3  
50x5.8  
56x5.8  
63x6.3  
69x6.8  
75x6.8



## JEU DE DOUILLES AVEC ERGOTS INTÉRIEURS

52835 272,00€

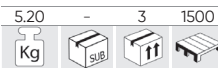

- Set douilles pour extraire les noix de splines dans les véhicules industriels.

10  
PCS

1/2"

mm  
26x5.3  
1.2x6.25  
34.2x6.3  
38.2x6.65  
42.2x7.3  
50.1x8.25  
58.2x9.8  
74.6x11.9  
82.2x13.25  
87.7x13



# COFFRET MONTAGE ET DÉMONTAGE SILENT-BLOCK

52494 227,00€

17,35 - 1 48  
Kg sub ff



- Utile pour installer et désinstaller les bagues et suspension.
- Contient manches de taille différentes tiges filetées métriques pour couvrir la plupart des véhicules sur le marché.
- Dimensions: M10, M12, M14, M16, M18.

12926 21,50€ M10



12927 21,50€ M12



12928 22,00€ M14



12929 23,00€ M16



12930 23,50€ M18



# OUTIL POSE ROUEMENTS ET JOINS SPI

53058 193,00€

8,19 - 1 102  
Kg sub ff



220mm Ø 12mm

- Ø
- 18, 19, 20, 21, 22, 23, 24, 25, 26, 27, 28, 29, 30, 31, 32, 33, 34, 35, 36, 37, 38, 39, 40, 41, 42, 43, 44, 45, 46, 47, 48, 49, 50, 51, 52, 53, 54, 55, 56, 57, 58, 59, 60, 61, 62, 63, 64, 65, 74mm

# COFFRET MONTAGE ET DÉMONTAGE ROUEMENTS

53056 127,00€

8,32 - 2 64  
Kg sub ff

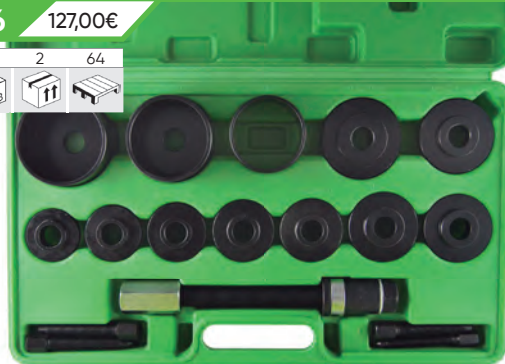

Ø 55,5, 59, 62, 65, 66, 71,5, 73, 78, 84mm

Ø 75,5, 83mm

295mm Ø 69mm

# COFFRET MONTAGE ET DÉMONTAGE ROUEMENTS

51349 37,30€

1,00 - 10 180  
Kg sub ff

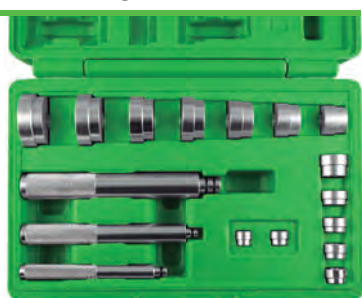

- 42 - 38mm
- 40 - 35mm
- 36 - 32mm
- 30 - 28mm
- 24 - 22mm
- 27 - 25mm
- 18 - 16mm
- 20 - 18mm
- 22 - 20mm
- 12 - 10mm
- 14 - 12mm
- 16 - 14mm
- 17 - 15mm

- 14 Adaptateurs.
- Conçu pour le montage et DÉMONTAGE rapide et précis des roulements sans les endommager.
- Convient à tout les types de roulement.

# EXPANDEUR POUR JOINTS

53129 84,00€

0,96 - 2 10 180  
Kg sub ff

18 - 90mm





## COFFRET MONTAGE ET DÉMONTAGE ROULEMENTS

**52551** 151,00€

10.42 - 2 58

Kg SUB IT

- Boulon: 27mm
- Écrou: 32mm
- Cylindres: 76, 82, 92, 101mm
- Renforce pour usage avec outil a choc.
- Axe en acier-fosfato a fin d'éviter la corrosion.
- Utile pour installer et DÉMONTÉr des roulements industriels.



Le numéro	955-08	955-11	955-07	955-12	955-13	955-14	955-09	955-15	955-06	955-17	955-18	955-19	955-16
Diamètre (mm)	55.7	63.3	67.8	70.7	71.9	71.7	72.8	73.4	74.7	77.4	81.4	83.3	88.4

## KIT EXTRACTION AXES ET RONDELLES

**53059** 52,00€

1.70 5 10 160

Kg SUB IT

∅  
39,5, 44,5, 50, 59, 63,  
65, 72, 76, 81mm



## KIT D'INSTALLATION ET DE DÉMONTAGE DE MOYEU ET DE ROULEMENT DE ROUE

**54299** 227,00€

15.00 - 1 -

Kg SUB IT



- 8,6x10,9cm
- 8,9x17,6cm
- 8,2x10cm
- 9,9x 17,6cm
- 7,1x9,45cm
- 12x17,8cm

∅ 2,3mm

- 5,3cm
- 5,8cm
- 6,5cm
- 6,6cm
- 6,8cm
- 7,1cm
- 7,3cm
- 7,8cm
- 8,3cm
- 9,5cm
- ∅ 2,3cm
- 9,55cm
- ∅ 8,6cm

19  
PCS



## OUTILS EXTRACTION NOIX DE CARDAN

**51364** 26,00€

2.00 - 5 280

Kg SUB IT

∅  
31mm

140 - 240mm



## EXTRACTEUR DE POULIE VILEBREQUIN

**51140** 64,00€

1.02 - 24 290

Kg SUB IT

- Conçu pour soutenir la poulie de l'arbre à cames immobile tandis qu'elle est détendue.
- Permet l'ajustement de l'axe central quand elles sont accouplées.
- En utilisant la barre vissée centrée pour déraciner la poulie.
- Vis de fixation: M6, M8.



# TROUSSE À OUTILS DE NETTOYAGE DE MOYEU 14 PIÈCES

54069 29,50€

0,20 10 40 360



Élimine la saleté et la corrosion de la surface des moyeux avec goujons.

- 1 buse 8 mm avec adaptateur 1/2".
- 1 meule à axe rond et tête hexagonale 8 mm.
- 2 potins amovibles avec base autocollante.
- 5 meules grossières, diamètre extérieur 40 mm.
- 5 meules à grain fin, diamètre extérieur 40 mm, diamètre intérieur 14mm.
- Dimensions d'encombrement d'un kit : 30,5\*17\*2,5 cm
- Poids d'un kit : 240 g



# ARRACHEUR HYDRAULIQUE DE MOYEU DE ROUE

53638 243,00€

13,35 - 1 32



- Ce kit comprend: 3 extracteurs / marteaux: broche hydraulique, vis et marteau à percussion, spécialement conçus pour simplifier le démontage du cube de roue et libérer l'arbre du moyeu sans l'endommager.
- Pour extraction manuelle ou hydraulique.
- Avec une capacité maximale de 10 tonnes.
- Marteau de 4 kg.
- Longueur de barre: 57cm.
- Pour 3, 4, 5 et 6 trous.



VAG (VW, AUDI, SEAT, SKODA), PSA (CITROËN, CITROËN DS, PEUGEOT), RENAULT, FORD, OPEL, BMW, MERCEDES BENZ

BROCHE HYDRAULIQUE

15253 62,00€

# ARRACHEUR DE ROULEMENTS DE ROUES AVEC COULISSEAU A CHOC

53635 85,00€

6,50 - 2 80



440 - 630mm

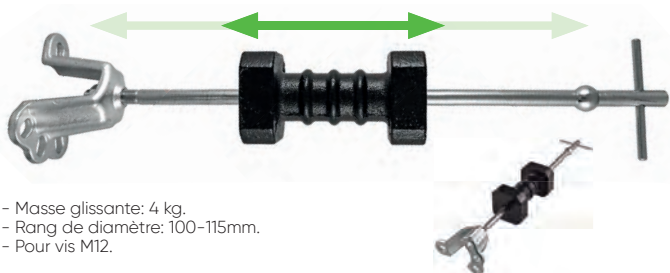

- Masse glissante: 4 kg.
- Rang de diamètre: 100-115mm.
- Pour vis M12.

# COFFRET ÉLARGISSEUR D'ÉCHAPPEMENTS

52637 48,00€

3,01 - 5 220



1-1/8" - 1-3/4"  
1-1/2" - 2-1/2"  
2-1/8" - 3-1/2"



# JEU DE 2 CROCHETS POUR EXTRAIRE GOMME DES TUYAUX ECHAPPEMENTS

52849 8,50€

0,22 10 40 480



# KIT EXTRACTEUR DE BRAS D'ESSUI-GLACE

53463 98,00€

1,65 - 10 180



- VW:** Polo, Lupo, Touareg, Porsche Cayenne.
- Opel:** Astra G, Zaphira B, Corsa C, Vectra C.
- Honda:** Jazz, CRV, FRV, Accord, Turnier.
- BMW:** 5ème Modèle de E 39 à 2005.
- 7ème Modèle de E 38 à 2005**
- Audi:** A3, A4, A5, A6, Audi Q7.
- Ford:** Galaxy, Alhambra.
- Mercedes:** A-Class, B-Class.



# EXTRACTEUR BALAIS ESSUI-GLACES

52454 12,90€

0,20 6 36 1152



- Conçu avec des supports et des extrémités minces fines en laiton pour empêcher n'importe quel type de dommage dans la carrosserie, dans la peinture ou verre.
- Applicable à la plupart des véhicules du marché.
- Sa manipulation permet un retrait en toute sécurité des essuie-glaces, évitant ainsi d'endommager le bras.



## CLÉ DYNAMOMÉTRIQUE AVEC LA TÊTE INTERCHANGEABLE 200NM

**52913** 292,00€

- Certificat d'étalonnage d'usine inclus.

1/2"

3,94	-	4	128
Kg	sub	ff	ff

- Couple serrage: 40-200Nm.
- Chefs inclus: CLÉ à écrous: 13, 14, 15, 17, 19, 22, 24, 27, 30mm.
- Chef de cliquet de 1/2".
- Différentes têtes disponibles séparément.

18x14mm



## CLÉ DYNAMOMÉTRIQUE

**51262** 51,00€

270mm 2-24 Nm  
0,2 - 2,4 M.Kg 1/4"

0,80	4	16	384
Kg	sub	ff	ff



**51338** 53,00€

365mm 19-110 Nm  
1,9 - 11 M. Kg 3/8"

1,05	4	16	320
Kg	sub	ff	ff



**51127** 56,00€

470mm 28-210 Nm  
2,9 - 21,4 M. Kg 1/2"

1,70	4	8	256
Kg	sub	ff	ff



- Certificat d'étalonnage d'usine inclus.

## TROUSSE DE RÉPARATION

**51262R** 14,00€

0,05	20
Kg	ff



**51338R** 14,00€

0,05	20
Kg	ff



**51127R** 14,00€

0,15	20
Kg	ff



## CLÉ DYNAMOMÉTRIQUE AVEC JUDAS

- Certificat d'étalonnage d'usine inclus.

**53081** 115,00€

1,10	5	25	350
Kg	sub	ff	ff

1/4"

4-20NM (36T)

375mm



**53082** 148,00€

1,90	4	8	168
Kg	sub	ff	ff

1/2"

40-210NM (24T)

560mm



**53972** 550,00€

8,75	-	2	42
Kg	sub	ff	ff

3/4"

1000-1210mm 200-800 Nm  
21,4 - 81,6 Kg SMC44

24



DYNAMOMÉTRIQUES

# TOURNEVIS DYNAMOMÉTRIQUE MÉCANIQUE

**51830** 94,00€

- Certificat d'étalonnage d'usine inclus.

1,00	-	12	300
Kg	sub	ff	ff

- Precision: CW: +/- 4%
- Rang de operation: 2-10 N-m
- Unites selection: N-m, in-lb.
- Long (mm): 242
- Embouts: 1/4"
- Vie utile: 100.000 cyCLÉS



# COMPARATEUR AVEC SUPPORT MAGNÉTIQUE

**52904** 61,00€

2,00	-	5	200
Kg	sub	ff	ff

- Mesure: 0-10mm.
- Calibrage: 0,01mm.
- Sphère: 58mm.
- Base magnétique: 40kg.



COMPARATEUR  
PARA REF. 52904

**13704** 21,00€

0,10	-	50	1500
Kg	sub	ff	ff

# COFFRET DÉMULTIPLICATEUR DE FORCE 3/4" + REDUCTEUR DE 1/2"

**51958** 422,00€

4,35	-	4	96
Kg	sub	ff	ff

- Caractéristiques:  
Rapport de transmission 1:4.  
Rapport de couple: 1: 3.3.  
Couple maximal d'entrée: 303 Nm.  
Couple maximal de sortie: 1000 Nm.

- Contenu:  
1x Multiplieur de couple.  
1x Cliquet manuel.  
1x Adaptateur 1/2"M x 3/4".  
1x Kit libération.  
1x Barre d'extension 90°.  
1x Barre d'extension 350 mm.



# CLÉ SERRAGE ANGULAIRE 1/2"

**52583** 8,50€

0,20	4	48	864
Kg	sub	ff	ff



# CLE DE SERRAGE MAGNÉTIQUE 1/2"

**52794** 28,00€

0,48	6	24	288
Kg	sub	ff	ff

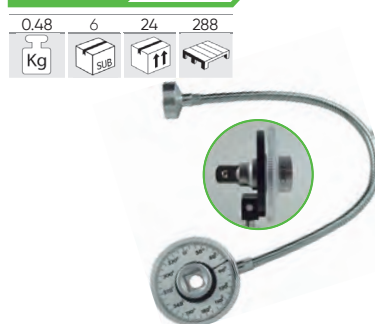

- Utile pour serrer les vis en degrés selon les spécifications déterminées par les fabricants de véhicules et de machines.
- Serrer faite par clé à cliquet ou le couple 1/2".
- Fenêtre transparente à une vision correcte de la mesure.
- Plage de mesure 0 à 360.
- Fixation par magnétique goniomètre



# JEU DE JAUGES D'ÉPAISSEUR

**52433** 4,80€

0,10	10	50	1000
Kg	sub	ff	ff

0,05 - 1mm



# PIED À COULISSE

**50937** 10,50€

0,24	10	50	1500
Kg	sub	ff	ff



MÉCANIQUE

150mm



**50724** 28,00€

0,30	5	50	1200
Kg	sub	ff	ff



DIGITAL

150mm



# JAUGE DE PROFONDEUR DIGITAL

**53042** 9,90€

0,05	10	100	2000
Kg	sub	ff	ff

0-25,4mm



# JAUGE DE PROFONDEUR

**52873** 11,00€

0,04	5	300	1500
Kg	sub	ff	ff

0-40mm



## COFFRET DÉMULTIPLICATEUR DE FORCE

51919 89,00€

7,75	-	3	120

- Matériel: 40CR.
- Puissance maximale: 5800Nm.
- Puissance de travail: 3800Nm.
- Multiple en rang 1:56.
- Inclues douilles: 32mm, 33mm de 1".



## DÉMULTIPLICATEUR DE FORCE ARTICULÉ

52796 98,00€

8,88	-	3	72

6.000Nm

- Emploi sur les camions avec enjoliveur et volant protecteur.
- Prévient les dommages de la bande de roulement.
- Unique sur le marché.
- Facilité d'adaptation à tout véhicule universelle.
- Utile pour vissage et dévisser sans effort.

- Comprend:
- 1x verre 1" 32mm.
- 1x verre 1" 33mm.



1:58

## DÉMULTIPLICATEUR DE FORCE JUNIOR

52012 68,00€

2,34	-	4	128

- Contenu:
- 1x Multiplicateur de couple.
- 1x Barre d'extension de 90°.
- Douilles de 17, 19 et 21 mm.



VOITURE DE  
TOURISME

1/2"

- Multiple en plage: 1: 18.
- Couple maximal de sortie: 360 Nm.
- Couple maximal de torsion: 800 Nm.



## JEU DE 8 DOUILLES 1" POUR DÉMULTIPLICATEUR DE FORCE

52056 66,00€

5,45	-	4	128

22, 24, 27, 30, 32,  
33, 38, 41mm

CrV

1"

8  
PCS



### PIÈCES DE RECHANGE DISPONIBLES

REF.	DESCRIPTION	Kg	if	€
10672	32mm	0,58	1	9,50€
10673	33mm	0,58	1	9,50€
10674	27mm	0,54	1	9,50€
10675	30mm	0,54	1	9,50€

# COFFRET MONTAGE / DÉMONTAGE EMBRAYAGES

**53001** 242,00€

905	-	1	40

- Évite les déformations de l'embrayage en utilisant le Prétendeur.
- En utilisant l'Outil de Reset, nous porterons à la nouvelle position la bague de rajustement de la plaque de pression en montant une nouvelle soupape d'embrayage.
- Adéquat pour presque tous les embrayages SAC (Embrayages à Ajustement Automatique).

- Avantages: Tension de la plaque de pression de l'embrayage lors de l'assemblage et du démontage
- Remplacement du ressort d'ajustement avec l'outil de reset.
- Centrage de la soupape par rapport au coussinet guide.

- Contenu: Prétendeur d'embrayages.
- Centreur à 3 trous.
- Outil de reset.
- Set de goujons de centrage.
- Centreur à 4 trous.



**POUR:**  
VW  
Audi  
Bmw  
Mercedes  
Volvo  
Renault  
Opel

## CENTREUR D'EMBAYAGE SAC

**53410** 92,00€

1,60	-	5	230



- Diamètre de centrage: 15-19 / 20-26.6 / 23-36mm
- Diamètre accessoires: 12, 14, 15, 16, 17, 18, 19, 20 mm



## COFFRET DE RÉPARATION D'EMBAYAGE DOUBLE FACE DE LA TRANSMISSION DSG / VAG

**53057** 149,00€

5,55	-	2	120

- Pour le service de changements de DSG en Golf (2004-), Golf Plus (2005-), AUDI A3 (2004-) avec des transmissions à 7 vitesses code OAM, et Touareg (2003-) avec transmission 6 vitesses code 08D).
- Références OEM des utiles: T10323, T10373, T10374.



## KIT DE DOUILLES AUTOMOBILE SPÉCIAL 10 PCS

**53669** 45,00€

0,70	5	20	1080



TOYOTA, NISSAN, RENAULT, OPEL ASTRA G/ZAFIRA, SMART, CITROËN, PEUGEOT, HONDA CIVIC

### CONTIENT

	<b>10S</b> pour pignon intermédiaire de Toyota		<b>14 mm</b> pour étriers de frein des Opel Astra G, Opel Zafira et Smart
	<b>6S</b> pour embrayages, culasses et têtes d'arbre d'équilibrage des Nissan et Renault		<b>10 mm</b> pour système de freinage et pompe à carburant de Nissan
	<b>8S</b> pour embrayages, culasses et têtes d'arbre d'équilibrage des Nissan et Renault		<b>12.5 mm</b> pour système de freinage et pompe à carburant de Nissan
	<b>12S</b> pour embrayages, culasses et têtes d'arbre d'équilibrage des Nissan et Renault		<b>19 mm</b> pour étriers de frein des Peugeot, Renault et Citroën
	<b>8TS</b> pour arbre d'équilibrage de Nissan		<b>20 mm</b> pour bras inférieur de suspension indépendante de Honda Civic



## CENTREUR D'EMBAYAGES UNIVERSEL

**52495** 14,50€

0,25	4	48	384



- Centreur d'embrayage pour la plupart des modèles dans le marché.
- Contient 3 adaptateurs de différent diamètre.



# SET DE CONTROL REMPLISSAGE ET VIDANGE POUR SYSTEME AACC

53456 98,00€

BAR

2,90	-	5	75
Kg	sub	if	if

- Testez les variations en haute et basse pression des systèmes de climatisation de véhicules.

- Contient blocs légers et en aluminium avec visière et jauges anti-flottement, larges et faciles à lire.

- Connecteurs de service professionnels (codés par couleur et étiquetés).

- Trois tuyaux de chargement codés par couleur et un crochet suspendu pour permettre l'utilisation mains libres.

- Applications: R134a, R12.

- Longueur du tuyau: 1550mm.

- Haute pression: 0-34 BAR.

- Basse pression: 0-24 BAR.

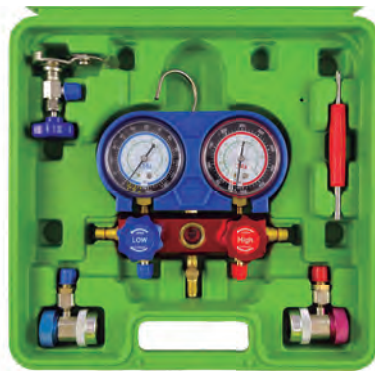

**ACCOUPEMENT RAPIDE HAUTE PRESSION (REF. 53456)**

14300 0.20 100  
19,00€ Kg if

R-134a

**ACCOUPEMENT RAPIDE BASSE PRESSION (REF. 53456)**

14301 0.20 100  
19,00€ Kg if

R-134a

## 1234YF ADAPTEUR POUR GAZ

HAUT

53499 29,00€

0,30	15	60	2400
Kg	sub	if	if



Adaptateur rapide d'air conditionné / liquide de refroidissement de connexion rapide R1234YF. Rouge (haute pression).

La conception de la connexion rapide permet une sécurité complète.

Avec connexion qui protège contre les blessures et la perte de réfrigérant si déconnecté sous pression.

Utilisation: AACC et réfrigérant

Matériel: laiton et métal

Couleur: rouge, bleu

Taille: Hauteur 55 mm, diamètre 30 mm.

BAS

53500 29,00€

0,20	15	60	2400
Kg	sub	if	if



## ENSEMBLE DE NOYAUX DE SOUPE DE CLIMATISEUR

53599 30,30€

0,16	10	100	-
Kg	sub	if	if



134  
PCS

<b>R12</b> 5mm L: 19mm	<b>R12</b> 6mm L: 22mm	<b>R134A</b> 7mm L: 20mm
<b>R12</b> 5mm L: 19mm	<b>R12</b> 6mm L: 22mm	<b>R12</b> 8mm L: 22mm
<b>R12</b> 5mm L: 19mm	<b>R12</b> 6mm L: 26.5mm	<b>R12</b> 9mm L: 22mm



### PIÈCES DE RECHARGE DISPONIBLES

REF.	MESURE	Kg	PCS	€/u.
14594	5x19mm R12 (VERT)	0,01	10	2,00€
14595	5x19mm	0,01	10	1,50€
14596	5x19mm R12	0,01	10	2,00€
14597	6x19mm	0,01	10	7,60€
14598	6x26.5mm	0,01	10	17,80€
14599	7x20mm R134A	0,01	10	4,50€
14600	6x22mm	0,01	10	9,50€
14601	8x22mm	0,01	10	11,00€
14602	9x22mm	0,01	10	11,00€

## MALLETTE JOINT POUR CLIM

50807 38,00€

0,16	6	24	672
Kg	sub	if	if



HNBR

270  
PCS

5.29x1.78mm 20 PCS	6.07x1.78mm 20 PCS	6.8x1.9mm 20 PCS	7.65x1.78mm 20 PCS	7.80x1.90mm 20 PCS	8.0x2.0mm 20 PCS
8.80x1.90mm 20 PCS	10.82x1.78mm 15 PCS	10.77x2.62mm 15 PCS	11.0x2.0mm 15 PCS	12.0x2.0mm 15 PCS	13.9x1.80mm 10 PCS
13.95x2.62mm 10 PCS	14.0x2.0mm 10 PCS	15.0x2.0mm 10 PCS	17.0x2.00mm 10 PCS	17.17x1.78mm 10 PCS	17.04x3.53mm 10 PCS

## KIT DE DÉCONNEXION D'AIR CONDITIONNÉ

53459 66,00€

1,05	-	10	150
Kg	sub	if	if



8mm (5/16"),  
9.5mm (3/8"),  
13mm (1/2"),  
16mm (5/8"),  
19mm (3/4"),  
22mm (7/8")



9.5 mm (3/8"),  
16mm (5/8"),  
13mm (1/2"),  
19mm (3/4")

## KIT DE DÉTECTION DE FUITE POUR CLIMATISATION

53539 78,00€

1.42	-	5	150
Kg	sub	ff	ff



- Spécialement conçu pour détecter les pertes de pression dans la climatisation et système de réfrigération d'une manière facile.  
- Consiste en l'insertion d'un liquide fluorescent neutre dans le circuit pour détecter la fuite rapidement.

- Contient:  
1 x lampe UV.  
1 x lunettes de vision UV.  
1 x pile rechargeable.  
1 x chargeur.  
1 x seringue insertion fluide.  
1 x adaptateur rapide.  
1 x adaptateur extension.



100 Lm	3W	110V 220V	x1 3.7V 1500mAh
--------	----	-----------	-----------------

FLUIDES POUR SYSTÈME DE CLIMATISATION



12977	0.33	3	12	480
36,50€	Kg	sub	ff	ff

250ml

- Une application de 7,5 ml pour chaque 1,4L de réfrigérant.

LUNETTES UV (RÉF. 53539)

14187	0.05	10	120	1080
6,00€	Kg	sub	ff	ff

BATTERIE RECHARGEABLE POUR 53539

15052	0.05	5	10
3,00€	Kg	sub	ff

SERINGUE DE DÉTECTION DE FUITE AA/CC

12200	1.10	50
14,50€	Kg	ff

LANterne POUR 53539

15054	0.12	5	10
34,00€	Kg	sub	ff

CHARGEUR POUR 53539

15053	0.08	10
10,50€	Kg	ff

## LAMPE PORTATIVE À DIODES LED UV COB AVEC BASE MAGNÉTIQUE

53530 46,00€

0.35	-	20	620
Kg	sub	ff	ff

380mm 45mm

LUMIÈRE ULTRAVIOLETTE



200 Lm	LED 2W COB	5V 1.000MA	3.7V 2.600MAh
4H	4H		

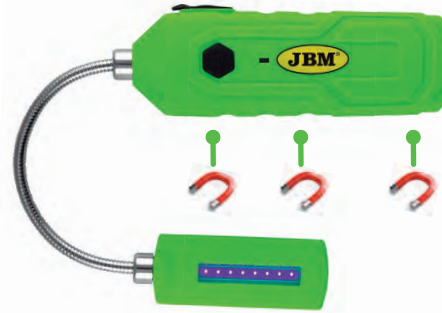

UV



## COFFRET CONTROLÉ CIRCUITS REFRIGÉRISEMENT

52687 168,00€

6.70	-	1	24
Kg	sub	ff	ff

- Rang 0 -2,5 bar.  
- 19 têtes de vérification de radiateurs spécifiques.  
- 1 tête de vérification de radiateurs universelle.



- 1: Pompe de pression avec soupape de décharge.
- 2A: Connecteur 1: attelage pour les têtes No.3(R123) et No.4 (R124).
- 2B: Connecteur 2: attelage pour les têtes No. 3 (R123) et No. 5(R125).
- 3: Mercedes (W123, W126, W124, W201), GM(Buick), Jeep.
- 4: Peugeot, Subaru, Chrysler, Acura, GM (Nova, Spectrum, Sprint), Mitsubishi, Nissan, Mazda, Toyota, Infiniti, GEO, Suzuki, Isuzu, Mercedes.
- 5: Honda, Toyota, Suzuki, Mitsubishi, Chrysler, Acura.
- 6: Mercedes Benz (ML, W163, W164), GM (Achiva, Skylark, Grand Am 1992-2002).
- 7: Volvo, Saab, Sterling, Citroen, Renault, Fiat, Alfa, Jeep.
- 8: VW(Vento, T4, Passat-1996, Golf, Beetle, Sharan).
- 9: Audi (A4, A5, A6), BMW 345, VW (Passat-1997-2002), Porsche(Cayenne).
- 10: BMW (E46, E36, E34, E39, E38, E32, E90).
- 11: Audi, VW.

- 12: Internacional, Land Rover, Jaguar.
- 13: Mercedes (C, E, S, W140, W220, W124, W210, W211, W215, W216, W221, R230).
- 14: Ford Focus.
- 15: Mazda(M3).
- 16: Mercedes classe A (W168).
- 17: BMW E60, E63, E64, E65.
- 18: VW SHARAN 1.8T 2.8.
- 19: TOYOTA-RAV4, PREVIA Adaptateur universelle en caoutchouc pour de purge et de remplissage de radiateurs.
- 20: SAAB.
- 21: LAND ROVER.



# ÉTUI REMPLISSABLE D'HUILE AVEC ENTONNOIR ET ADAPTATEURS

**53485** 140,00€

**15**  
PCS

**53347** 100,00€

**8**  
PCS

3,00	-	4	40
Kg	Sub	ff	ff

2,75	-	4	36
Kg	Sub	ff	ff

Contient :

Extensions d'angle

- 1- Adaptateur de filetage M42 x 4,5 pour Subaru
- 2- Adaptateur de filetage M37 x 3,0 (type court) pour Lotus, Pontiac, Scion et Toyota
- 3- Adaptateur de filetage M35 x 4,0 pour Ford, Jaguar, Land Rover et Mazda
- 4- Adaptateur de filetage M32 x 3,5 pour Acura, Dodge, Ford, Honda, Jaguar, Jeep, Land Rover, Mazda et Nissan
- 5- Adaptateur à baionnette pour Toyota et Lexus 3,0 et 3,3 I V6
- 6- Adaptateur à baionnette pour Audi, BMW, Mercedes-Benz, Porsche, Volvo, VW et VW
- 7- Adaptateur de filetage M30 x 3,0 pour Dodge Cummins
- 8- Adaptateur de filetage (1/2 tour) pour Mazda 3/6/CX-5
- 9- Adaptateur de filetage (1/2 tour) pour Cadillac, Chevy, Ford, GMC, Hyundai, Jaguar, Land Rover, Mazda, Saab et Mercury
- 10- Adaptateur de filetage (1/4 de tour) pour les nouveaux bouchons de remplissage à partir de 2088 sur Audi, Seat, Skoda et VW avec moteur EA888
- 11- Adaptateur de filetage (1/2 tour) pour Dodge Hemi 6,4 L (2011-) et >3,6 L (>2014)
- 12- Adaptateur de filetage M37 x 3,0 (type long) pour Toyota, Lexus, Scion et Pontiac



Comprend :

Extension d'angle

- 1- Adaptateur de filetage M42 x 4,5 pour Subaru
- 2- Adaptateur de filetage M37 x 3,0 pour Lotus, Pontiac, Scion, Toyota
- 3- Adaptateur de filetage M35 x 4,0 pour Ford, Jaguar, Land Rover, Mazda
- 4- Adaptateur de filetage M32 x 3,5 pour Acura, Dodge, Ford, Honda, Jaguar, Jeep, Land Rover, Mazda, Nissan
- 5- Adaptateur à baionnette pour Toyota et Lexus 3,0, 3,3 I V6
- 6- Adaptateur à baionnette pour Audi, BMW, Dodge, Mercedes-Benz, Porsche, Volvo, VW

## POMPE PRESSION ET DEPRESSION

**54016** 76,00€

1,50	-	5	100
Kg	Sub	ff	ff

Avec la pompe à vide, le kit comprend un ensemble de buses, des adaptateurs, des bouchons, des joints en caoutchouc et des appareils de mesure pour une purge et un contrôle corrects et faciles du système de freinage.

Pression maximale :  
40 psi (3 bar)  
Pression minimale :  
-20 psi (-0,75 bar)



**MAX**  
40 PSI  
3 bar

**MIN**  
-20 PSI  
-0,75 bar

## TESTEUR DE FUITE POUR JOINT DE CULASSE DE CYLINDRE

**53662** 89,00€

1,78	5	10	80
Kg	Sub	ff	ff

- Cet outil est conçu pour vérifier les fuites entre les systèmes de combustion et de re-froidissement des moteurs à refroidissement par liquide.
- En raison du processus de combustion, environ 13-14% de CO<sub>2</sub> se forment (entre autres) dans les gaz d'échappement et il n'est pas difficile de le trouver dans le système de refroidissement.
- Si des produits de combustion gazeux sont présents, la couleur du liquide de contrôle dans la chambre supérieure passera au jaune ou au vert, ce qui indique des fuites de gaz combustible (CO<sub>2</sub>) dans le liquide de refroidissement.

- Contient:

- Bouteille ronde de 200 ml.
- Bouteille carrée de 250 ml.
- Adaptateurs:  
Petit: Suzuki, Toyota, Mitsubishi.  
Moyen: Suzuki, Toyota, Mitsubishi, Subaru, Peugeot, Nissan, Lexus, Mazda.  
Grand: Ford, GM, Benz, JEEP.



**LIQUIDE D'ESSAI  
COMBUSTION  
DETECTEUR DE FUITE**

**14563**  
18,00€

0,23	5	50
Kg	Sub	ff



## JEU D'EMBOUITS TORX 6 PIÈCES 1/2" TYPE E EXTRA LONGS

53915

65,00€

TÊTE AVEC  
NOIRCISSEMENT

2.10	-	10	240
Kg	sub	ff	ff

**E12** Douille pour culasse de BMW:  
- Moteur M42, 1,8 L, 4 cylindres, 16 V, modèle 318 (1989)  
- Moteur M50, 2,0 L, 2, 5 L, 6 cylindres, 24 V, modèles 520i, 525i (1991)



ACIER ZINGUÉ



1/2"

6  
PCS

CrV

## LÈVE SOUPAPES

52693

24,50€

0.65	5	20	450
Kg	sub	ff	ff



- Pour la plus part des moteurs OVH, OHC, CHV.  
- Capacité de comprimer et extraire.  
- Avec onglet.  
- Adaptateur réversible et blocage de position.

## COFFRET DÉMONTE SOUPAPES

51120

41,00€

2.10	-	5	160
Kg	sub	ff	ff

- Valable pour voitures et motocyclettes.  
- Les 5 adaptateurs permettent d'installer correctement et facilement pour comprimer le ressort de la soupape.



- Contenu:  
Compresseur à ressorts.  
Adaptateurs de: 30, 25, 23, 19, 16mm.

## LÈVE SOUPAPES 45-145MM

52734

51,00€

2.61	-	5	175
Kg	sub	ff	ff



## ORGANISATEUR POUR COMPOSANTS DE MOTEUR

53637

85,00€

1.40	-	5	20
Kg	sub	ff	ff

260mm	400mm	450mm
-------	-------	-------

- Spécial pour les pièces de culasse.  
- Maintient tous les composants propres et bien rangés au fur et à mesure qu'ils sont retirés de la culasse.  
- Gagnez du temps. Cela facilite votre travail.

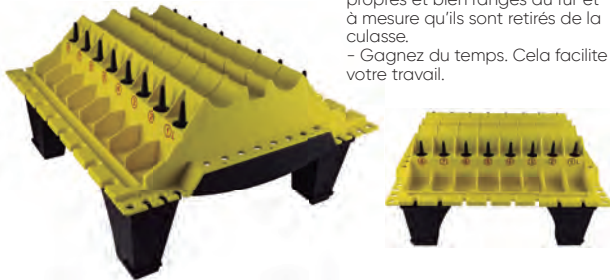

## JEU DE 2X2 VENTOUSES A RODER LES SOUPAPES

52850

7,80€

0.11	6	72	1008
Kg	sub	ff	ff

Ø 3,49-2,86mm  
Ø 1,59-2,06mm

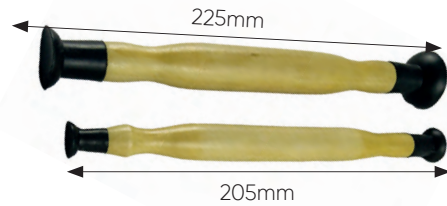

## RODOIR A SOUPAPES PNEUMATIQUE - PERCUSSION ET ROTATION

53572

348,00€

1.90	-	5	80
Kg	sub	ff	ff



RÉGULE LA  
VITESSE



50  
ff

14157  
8,30€

14158  
9,95€

14159  
12,60€

14160  
12,80€

14161  
13,70€

- Contenu:  
1 x machine à valve pneumatique.  
5 ventouses (16, 20, 30, 35 et 45 mm).  
5 x adaptateur de valve.  
1 x Clé Allen 3 mm.



VIRAGE À DROITE +  
VIRAGE À GAUCHE

1/4" 800BPM 1/4"

50L/min 1.8 CFM 289mm

## KIT D'OUTILS POUR ANNEAUX DE PISTON

53251

88,00€

2.80	-	4	72
Kg	sub	ff	ff



- Jeu complet d'anneaux de ceinture et d'anneaux de piston.  
- Tenaillon ou pince pour installation de segments de pistons.  
- Le serrage des anneaux de ceinture ont un système de cliquet dentée.



H:3"  
Ø 53-125mm

H:4"  
Ø 60-175mm

H:6"  
Ø 60-175mm

## COLLIERS À SEGMENTS

52697

16,00€

0.50	5	40	720
Kg	sub	ff	ff

Ø 60-175mm

6"

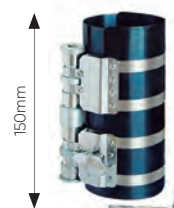

52696

12,00€

0.28	5	40	1200
Kg	sub	ff	ff

Ø 53-175mm

3"

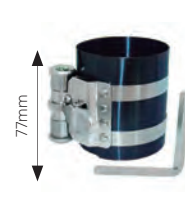

## ALÉSOIRS EXPANSIBLE POUR CYLINDRES

2 BRAS

**52591** 12,00€

0,10 12 72 1728  
Kg SUB fff

Ø ↑ 55mm  
↓ 19mm

28,6mm

1-1/8"



3 BRAS

**52592** 22,00€

0,20 - 20 480  
Kg SUB fff

Ø ↑ 85mm  
↓ 35mm

50,8mm

2"

**52593** 34,00€

0,47 6 36 360  
Kg SUB fff

Ø ↑ 170mm  
↓ 55mm

101,6mm

4"



PIERRE D'AFFÛTAGE 1 - 1/8" - EN BLISTER DE 2 UNITÉS POUR REF. 52591

**11878** 0,10 25 100  
4,10€ Kg SUB fff

PIERRE D'AFFÛTAGE 2" EN BLISTER DE 3 UNITÉS POUR REF. 52592

**11879** 0,04 25 100  
5,10€ Kg SUB fff

PIERRE D'AFFÛTAGE 4" EN BLISTER DE 3 UNITÉS POUR REF. 52593

**11880** 0,09 25 100  
10,50€ Kg SUB fff

## COMPRESSEUR DE RESSORTS

**53394** 598,00€

29,70 - 1 18  
Kg SUB fff

- Kit professionnel qui permet de retirer et d'installer rapidement les ressorts de suspension avant et arrière sans démonter l'essieu.

300 mm

2 x 65-125MM  
2 x 88-160MM  
2 x 126-212MM

26.000 Nm  
1.050 Kg



- Bras télescopique et surfaces antidérapantes qui permettent une prise solide des ressorts.
- Serres équipés d'un plastique interchangeable pour éviter d'endommager le ressort de peinture.
- Il empêche les ressorts de se plier en compression.
- Universal, couvre 90% du parc de véhicules.
- Il peut être utilisé pour les ressorts droits et coniques.

- Comprend:  
Dispositif / piston.  
Trois paires de mâchoires avec des couvertures en plastique.

Peut être utilisé avec des outils pneumatiques

## KIT POUR DÉMONTAGE AMORTISSEURS

**53118** 231,00€

6,66 - 2 44  
Kg SUB fff

CRV 6140  
CRMO  
SCM415  
CRV 50BV30

39 PCS



## COMPRESSEUR DE RESSORTS

**50827** 387,00€

32,90 - 1 15  
Kg SUB fff

- Capacité : 1T (2200 lbs)
- Diamètre du ressort comprimé : 200 mm
- Longueur de compression : 200-500mm

1T



## COMPRESSEUR DE RESSORT PROFESSIONNEL MCPHERSON

**52227** 247,00€

15,10 - 1 36  
Kg SUB fff

- Spécifications:  
Charge maximale: 2500N.  
Un corps principal.  
Prise en charge étendue.



- 3 paires de mâchoires.
- Paire 1: Champ d'application: 80-115mm. Poids: 1,45 kg.
- Paire 2: Domaine d'utilisation: 110-195mm. Poids: 2,2 kg.
- Par 3: Domaine d'utilisation: 140-195mm. Poids: 2,3 kg.

- BMW, Toyota, Ford, Mitsubishi, VW, Audi, Saab, Nissan, Honda Accord, Subaru, Volvo, Opel, Porsche.

NE PAS UTILISER AVEC CLÉ À CHOC

## COMPRESSEUR DE RESSORT

**51121** 27,30€

1,80 - 5 420  
Kg SUB fff

- Griffes et goujon forgés avec alliage fer-carbone, tous les deux thermo-traités pour assurer un grand professionnalisme au travail.
- Outil conçu pour être utilisé dans des espaces limités et sous l'arc de roue, offrant la plus grande protection.
- Ouverture maximale 250 mm.

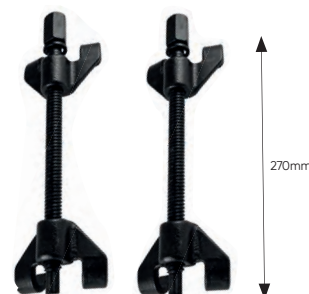

## PISTOLET STROBOSCOPIQUE

- Permet d'ajuster l'allumage des moteurs.

DIGITAL

**53474** 94,00€

0.85	5	20	160
Kg	Sub	ff	ff

12V 1.8m 0,1° 9.000

3,6W

**53240** 58,00€

0.75	-	20	160
Kg	Sub	ff	ff

12V 1.5m

3,6W



2 PINCES



SENSEUR INDUCTIF



2 PINCES



SENSEUR INDUCTIF

## STÉTHOSCOPE ÉLECTRONIQUE

**53249** 192,00€

2.65	-	5	40
Kg	Sub	ff	ff

- Kit apte pour détection des erreurs sur collecteurs d'admission/ échappement, injecteurs, radiateurs, etc.

- Permet d'ausculter plusieurs endroits du véhicule simultanément, facilitant la tâche de l'opérateur pour trouver et diagnostiquer les pannes.

- Sondes marquées en couleur pour faciliter la tâche de l'opérateur.

- Comprend velcro de fixation pour les capteurs.

- Caractéristiques:

Longueur du câble du capteur: 4,8 m

Longueur de la sonde audio: 14 cm

Piles de 9V (incluses)

Nombre de capteurs: 6

Apte pour connecteur de 3,5 mm

Longueur ajustable du microphone: 21cm.



## STÉTHOSCOPE

**51347** 99,0€

0.14	5	50	400
Kg	Sub	ff	ff

910mm 320mm



- Amplifie et localise des bruits internes mécaniques et des passages de fluides.
- Localise rapidement la source du bruit du moteur.
- Écoutez les problèmes de localisation rationnelle des flux d'eau, pétrole, gaz ou vapeur.
- Manche à l'épreuve des coups.



Ø 12mm

## OUTIL DE DÉSAMBLAGE DE CONNECTEURS

**53663** 8,00€

0.01	10	100	4800
Kg	Sub	ff	ff

VAG



- Outil permettant de démonter les connecteurs des véhicules du groupe VAG sans les endommager.

## ENSEMBLE D'OUTILS DE RÉGLAGE LES PHARES

**53729** 19,10€

0,40	10	40	480
Kg	SUB	ff	



## PINCE POUR LES DISPOSITIFS D'OUVERTURE DU CAPOT ET DU COFFRE

**53525** 12,00€

0,10	5	30	1770
Kg	SUB	ff	

- Diamètre d'ouverture maximum: 10mm.



## MANCHE TÉLESCOPIQUE

**52497** 26,80€

0,29	6	48	480
Kg	SUB	ff	

↑120mm  
↓53mm

**53196** 33,00€

0,37	6	48	-
Kg	SUB	ff	

↑160mm  
↓71mm

- Pour vérifier le bon fonctionnement des feux de freinage: extension de la barre, une extrémité en appuyant sur la pédale de frein et la autre sur le volant.
- Afin de déterminer la pression des pneus.
- Pour éliminer les petites pierres ou des clous dans es rainures du pneu.
- Pour souLÉVER le capot supérieur commodément et vérifier l'huile de moteur, batterie, courroie, radiateur, etc.

AVEC 3 SECTIONS ALUMINIUM

FORT ET LÉGER



## ARRACHEUR POUR POIGNÉES DE PORTE VAG

**53655** 12,00€

0,09	12	96	1152
Kg	SUB	ff	



## ADAPTATEUR ANGULAIRE

**52620** 8,80€

0,05	6	36	1584
Kg	SUB	ff	

37mm



- Pour les zones de difficile accès.
- Avec fonction de prise rapide.
- Extraction facile.

- Bit de 6mm.

## JEU DE 8 PINCES PLATES AVEC LE FIXATEUR POUR LES TUYAUX FLEXIBLES

**53477** 36,10€

0,80	-	10	220
Kg	SUB	ff	

8 PCS

NYLON 8, 10, 13mm

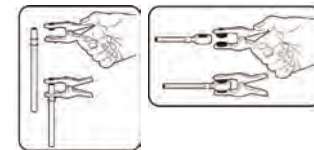

## JEU DE 3 PINCES DURITES

3 PCS NYLON

1/2" 3/4" 5/8"

**52066** 12,00€

0,28	5	40	480
Kg	SUB	ff	

- Constitué d'un matériau léger et isolé électriquement.
- Convient pour le circuit de frein, liquide de réfrigérant et de carburant.

- 0-20mm
- 0-35mm
- 0-70mm



**53395** 16,00€

0,30	5	20	360
Kg	SUB	ff	

Ø 13, 20, 35mm

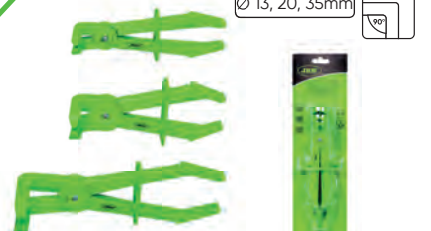

# JEU DE 3 PLATEAUX D'OUTILS ANTIDÉRAPANTS FLÉXIBLES

**53903** 59,00€

1,65	-	10	100
Kg	sub	ff	ff

- Matériau antidérapant.
- Idéal pour tout environnement de travail, offrant un accès facile et pratique aux outils.
- Poignée intégrée portable et pratique.
- Résistant à l'huile.
- Résistant à des températures jusqu'à 140°C.
- Règle intégrée des deux côtés du plateau.
- Compartiments séparés pour une bonne

- organisation des outils.
- Conception unique de ventouse pour une fixation sûre sur des surfaces planes.



- Petit: 285x137x27mm
- Moyen: 285x202x27mm
- Grand: 543x300x27mm
- Matériau: caoutchouc souple.

## PLATEAU PETIT

<b>15010</b>	0,40	20	360
16,50€	Kg	sub	ff

## PLATEAU MOYEN

<b>15011</b>	0,45	20	320
18,00€	Kg	sub	ff

## PLATEAU GRAND

<b>15012</b>	1,05	10	120
31,50€	Kg	sub	ff

# BOL MAGNÉTIQUE PLIANT

- Plateau en plastique soufflé, MAGNÉTIQUE pour accrocher boulons, rondelles, écrous et petites pièces.

**52516** 28,00€

0,42	6	24	1152
Kg	sub	ff	ff

- Ø superior: 225mm.
- Ø base: 88mm.
- Mesures déployées: 135mm.
- Mesures pliantes: 43mm.

**52517** 6,00€

0,10	12	72	1152
Kg	sub	ff	ff

- Ø superior: 135mm.
- Ø base: 53mm.
- Mesures déployées: 90mm.
- Mesures pliantes: 31mm.



# BOL MAGNÉTIQUE

**52466** 11,00€

0,43	-	20	180
Kg	sub	ff	ff

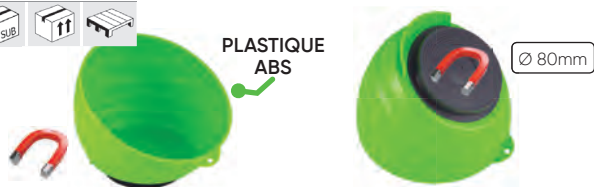

# PLATEAU MAGNÉTIQUE

**50787** 8,00€

0,35	6	36	648
Kg	sub	ff	ff



**50788** 14,50€

0,62	6	24	432
Kg	sub	ff	ff



# PORTE OUTILS AIMANTÉE

**52467** 10,30€

0,50	-	24	1008
Kg	sub	ff	ff

- Aimant de grande portée.
- Protection en mousse pour éviter de endeuimer les surfaces.

40mm	145mm	75mm
------	-------	------



# SUPPORT MAGNÉTIQUE

**52378** 10,00€

0,36	10	40	720
Kg	sub	ff	ff

**3KG** Ø 60mm



**51341** 35,00€

1,62	-	12	96
Kg	sub	ff	ff

**9KG** Ø 70mm



# SET DE 2 ÉTAGÈRES AIMANTÉES

**50790** 29,00€

1,17	-	12	96
Kg	sub	ff	ff

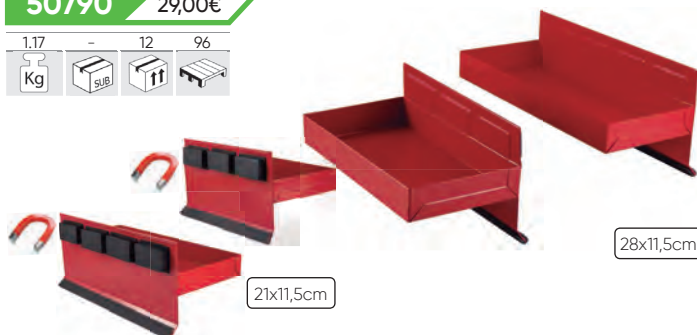

# BARRE AIMANTÉE

**50789** 29,00€

0,89	10	20	500
Kg	sub	ff	ff



# JEU DE 5 AIMANTS

**53958** 6,50€

0,05	10	100	-
Kg	sub	ff	ff

Ø 15mm



## CARTOUCHE DE GAZ

51986 11,90€

0,18	-	24	1584
Kg	sub	ff	ff

200ml



## CHALUMEAU

51920 18,00€

0,14	10	100	400
Kg	sub	ff	ff

- Gaz non inclus.



## EXTRACTEUR DE COLLIERS DE SERRAGE HENN

53696 22,00€

0,10	6	96	1536
Kg	sub	ff	ff

- Volkswagen, Audi, Seat, Škoda, BMW, Peugeot, Citroën, Dacia, Fiat, Ford, Kia, Lexus, Mazda, Mercedes, Nissan, Opel/Vauxhall, Porsche, Renault, Toyota, Volvo.

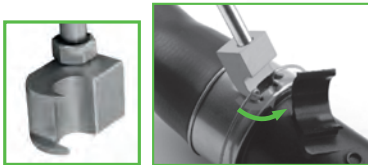

## OUTILS POUR RIVER ET DÉMONTER LES CHAÎNES DE MOTOCYCLETTE

53055 33,00€

0,89	5	10	480
Kg	sub	ff	ff



## COUPE-CHAÎNE DE MOTOCYCLETTE

53665 19,00€

0,35	10	60	1920
Kg	sub	ff	ff



25-60



53666 28,00€

0,70	5	30	1920
Kg	sub	ff	ff

60-100



## NETTOYEUR DE BORNE BATTERIES

52319 8,80€

0,18	12	48	720
Kg	sub	ff	ff



52621 11,00€

0,14	10	40	960
Kg	sub	ff	ff

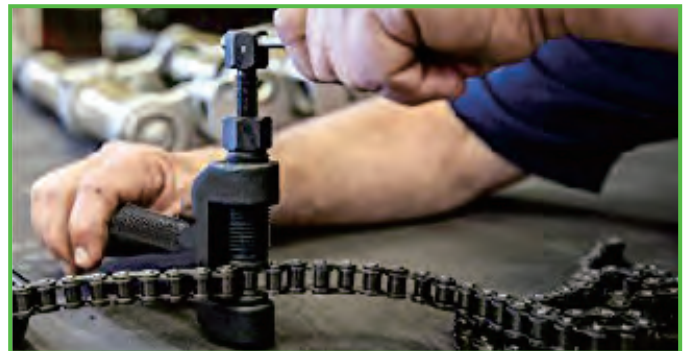

## COFFRETS DE 38 BROSSES MÉTAL/NYLON/LAITON

51989 49,00€

1,64	-	10	120
Kg	sub	ff	ff



Ø 8, 9, 10, 11, 12, 13, 14,  
15, 16, 17, 18, 19mm

**38**  
PCS

- 1 Poignée de 1/4".
- 1 Extension.
- 36 brosses.



## BROSSES MÉTALLIQUES

52760 4,10€

0,09	6	120	2160
Kg	sub	ff	ff



52515 9,10€

0,14	6	72	800
Kg	sub	ff	ff

- 1 x Laiton.
- 1 x Nylon.
- 1 x Acier.



225mm

**3**  
PCS



## CLÉ POUR COUVERCLE DE JAUGE

53096 28,80€

1,00	5	10	300
Kg	sub	ff	ff

89-170mm

15mm



## EXTRACTEUR DE JAUGE DE CARBURANT

52757 16,00€

0,55	5	20	480
Kg	sub	ff	ff



160mm  
75mm



## CLÉ À DOUILLE SPÉCIALE MOTOCYCLETTE

53054 6,00€

0,16	12	72	1500
Kg	sub	ff	ff

19, 22, 24mm



## CLÉ POUR MOTOCYCLETTE

53086 9,00€

0,18	12	72	1500
Kg	sub	ff	ff

17, 19, 22, 24mm

**3/8"**



Yamaha, Kawasaki,  
BMW, Suzuki, Honda







## **COFFRET DE CALAGE**

- |     |   |
|-----|---|
| 218 | BMW   |
| 222 | MERCEDES  |
| 224 | VAG   |
| 229 | RENAULT / NISSAN  |
| 231 | FORD / MAZDA  |
| 233 | JAGUAR / LAND ROVER   |
| 234 | OPEL / VAUXHALL   |
| 238 | CITROËN / PEUGEOT   |
| 242 | DIVERS  |
| 244 | SERVANTE D'OUTILS AVEC OUTILS<br>POUR RÉGLER LA SYNCHRONISATION |
| 245 | OUTILS SPÉCIAUX   |

## COFFRET DE CALAGE POUR BMW N42 / N46 1.8 / 2.0

53259 97,00€

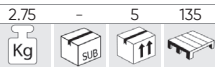

GASOLINA/PETROL

### MARQUES

BMW 1 SERIES: 118i E81/82/87/88 (04-14), 120i E81/82/87/88 (04-14).  
BMW 3 SERIES: 316i/ti Compact E46 (01-07), 318i/ti Compact E46 (01-07), 318i, E90/91/92/93 (05-12), 320i E90/91/92/93 (05-12).  
BMW 5 SERIES: 520i E60/61 (07-10), Z4 2.0 E85/86 (04-09).  
BMW X SERIES: X1 sDrive 18i E84 (10-12), X1 xDrive 18i E84 (10-12), X3 2.0 E83 (05-10).

### OUTILS OEM

119350 (1), 119340 (2), 119291 (3), 119292 (4), 119270 (5), 115120 (6), 119190 (7), 119293 (8)

### CODES MOTEUR

1.8: N42; B18A, N46; B18. / 2.0: N42; B20A, N46; B20, B20B, N46T; B20, B20B, B20BD, B20BZ, B20O2, B2O2.



## COFFRET DE CALAGE POUR BMW N43 1.6 / 2.0

53260 168,00€

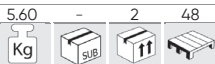

GASOLINA/PETROL

### MARQUES

BMW

BMW 1 SERIES: 116i E81/82/87/88 (07-12), 118i E81/82/87/88 (06-14), 120i E81/82/87/88 (06-14).  
BMW 3 SERIES: 316i/ti Compact E46 (01-07), 318i E90/91/92/93 (07-13), 320i E90/91/92/93 (07-14).  
BMW 5 SERIES: 520i E60/61 (07-10).

### OUTILS OEM

118690 (118691/118692/118693) (1), 118710 (118711/118712) (2), 113340 (3) (4), 118700 (5), 119340 (119341/119342) (6), 115120 (7).

### CODES MOTEUR

1.6: N43 B16A/AA, B16AA, B16AA/OO.  
2.0: N43 B20A, B20A/AA, B20AA, B20AY, B20KO, B20UO.

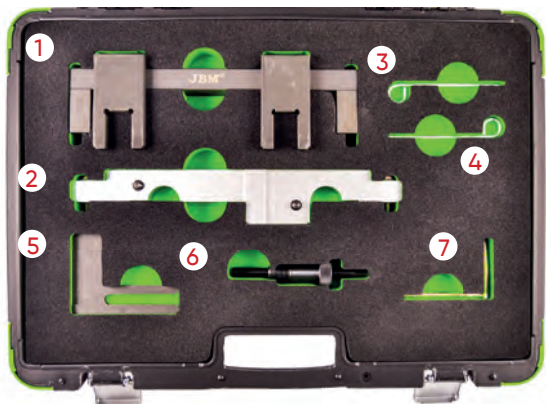

## COFFRET DE CALAGE POUR BMW N42 / N46

53261 214,00€



GASOLINA/PETROL

### MARQUES

BMW 1 SERIES: 118i E81/82/87/88 (04-14), 120i E81/82/87/88 (04-14).  
BMW 3 SERIES: 316i/ti Compact E46 (01-07), 318i/ti Compact E46 (01-07), 318i E90/91/92/93 (05-12), 320i (E90/91/92/93 (05-14)).  
BMW 5 SERIES: 520i E60/61 (07-10).  
BMW X SERIES: X1 E84 sDrive 18i (10-12), X1 E84 xDrive 18i (10-12), X3 E83 2.0 (05-10).  
BMW Z SERIES: Z4 2.0 E85/86 (04-09).

### OUTILS OEM

119190 (1), 119310 (2), 119302 (3)

### CODES MOTEUR

2.0: N42 B18A, N42 B20A, N46 B18, N46 B20, N46 B20B, N46T B20, N46T B20B, N46T B20BD, N46T B20BZ, N46T B20O2, N46T B2O2

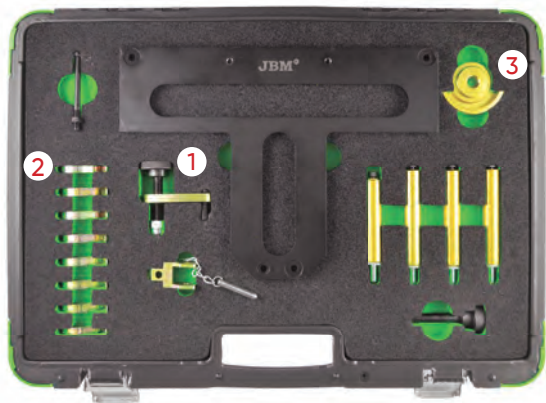

## KIT VEROUILLAGE ARBRE À CAMES BMW M52TU / M54 / M56

53262 251,00€

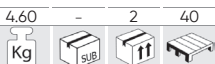

GASOLINA/PETROL

### MARQUES

M52TUB25: 1997-2001 E46 323i/323Ci/323ti (M52T); 1998-2001 E39 523i (M52TU); 1998-2001 E36/7 Z3 (M52TU).  
M52TUB28: 1997-2001 E46 328i/328Ci (M52TU); 1997-2001 E36/7 Z3 2.8 (M52B28/Z3); 1998-2001 E39 528i (M52TU); 1998-2001 E38 728i (M52TU).  
M54B22: 2001-2003 E46 320i/320Ci; 2001-2003 E39 520i; 2001-2002 E36 Z3 2.2i; 2003-2005 E85 Z4 2.2i; 2003-2005 E60/E61 520i.  
M54B25: 2001-2002 E36/7 Z3 2.5i; 2001-2005 E46 325i/325xi; 2001-2006 E46 325Ci; 2001-2004 E46 325ti; 2001-2004 E39 525i; 2003-2004 E60/E61 525i/525xi; 2004-2006 E83 X3 2.5i; 2004-2006 E85 Z4 2.5i.  
M54B30: 2001-2005 E46 330i/330xi; 2001-2006 E46 330Ci; 2001-2003 E39 530i/2001-2002 E36 Z3 3.0i; 2003-2005 BMW E60 530i; 2003-2006 E85 Z4 3.0i; 2001-2006 E53 X5 3.0i.

116150 (1), 113450 (2), 113292 (3), 116180 (4), 114220(5)

### OUTILS OEM

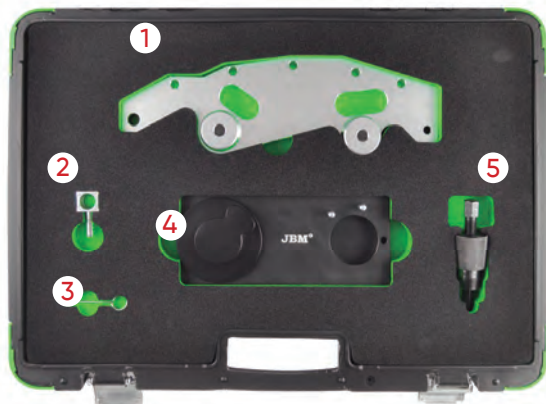

## KIT DE BLOQUAGE ARBRE A CAME BMW M47

**53263** 57,00€

1.80 - 5 165

Kg SUB

**DIESEL/GASOIL**



<b>MARQUES</b>	BMW	<p><b>BMW 1 SERIES:</b> 118d E87 (04-07), 120d E87 (04-07).</p> <p><b>BMW 3 SERIES:</b> 318d/td Compact E46 (01-05), 318d/td E90/91 (05-08), 320d/td Compact E46 (98-05), 320d/cd E90/91 (05-08), 325d E90/91/92/93 (02-10), 330d/cd E46/90/91/92/93 (99-07), 335d E90/91/92 (06-11).</p> <p><b>BMW 5 SERIES:</b> 520d E39/60/61 (00-09), 525d/xd E39/60/61 (00-10), 530d/xd E46/60/61 (98-10), 535d E60/61 (04-10).</p> <p><b>BMW 6 SERIES:</b> 635d E63/64 (07-11).</p> <p><b>BMW 7 SERIES:</b> 730d/ld E38/65/66 (98-08).</p> <p><b>BMW X SERIES:</b> X3 2.0d E83 (04-07), X3 3.0d/sd E83 (03-10), X5 3.0d E53/E70 (00-10), X6 3.0d E71/72 (08-10), X6 3.5d E71/72 (08-10).</p> <p><b>LAND ROVER:</b> Freelander Td4 (00-06), Range Rover Td6 (02-06).</p> <p><b>MG/ROVER:</b> MG-ZT/T (01-05), Rover 75 CDT/CDTi (99-05).</p> <p><b>VAUXHALL/OPEL:</b> Omega-B (01-03).</p>
<b>OUTILS OEM</b>	112300/12-108, 12-171/KM-813 (1), 113340/12-172/KM-823 (2) (3), 116322/12-174/KM-6267 (4) 116320 (5)	
<b>CODES MOTEUR</b>	<p>BMW</p> <p>2.0D: M47, M47T2, M47TU / 2.5D: M57, M57T2, M57TU / 3.0D: M57, M57T2, M57TU</p> <p>LAND ROVER</p> <p>2.0D: 204D3 (TD4) / 3.0D: 306D1 (TD6)</p> <p>MG/ROVER</p> <p>2.0D: M47R / 2.0d CDT: M47R</p> <p>VAUXHALL/OPEL</p> <p>2.5D: Y25DT</p>	

## KIT DE CALAGE POUR BMW, MINI 1.2, 1.5, 2.0, 3.0

**54228** 187,00€

5.15 - 2 48

Kg SUB

**GASOLINA/PETROL**

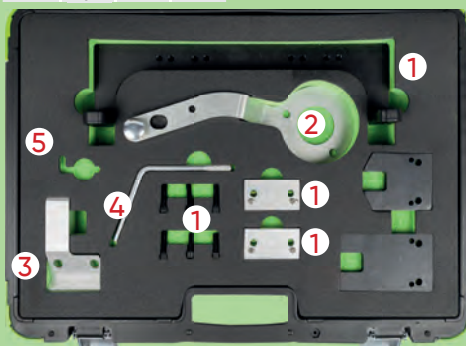

<b>MARQUES</b>	<p>BMW: 1 Series (2015 - 2019), 2 Series (desde 2014), 3 Series (desde 2015), 4 Series (desde 2015), 5 Series (desde 2017), 6 Series (desde 2017), 7 Series (desde 2015), 8 (desde 2014), X1 (desde 2015), X2 (desde 2018), X3 (desde 2017), X4 (desde 2018) and Z4 (desde 2019); MINI: Clubman (desde 2015), Hatch (desde 2014), Convertible (desde 2016) and Countryman (desde 2017)</p>
<b>OUTILS OEM</b>	2 358 122 (1), 2 357 904 (2), 2 365 488 (3), 2 288 380 (4), 11 4 120 (5).
<b>CODES MOTEUR</b>	<p>BMW:</p> <p>1,5 B38 A15A, B38 B15A, B38 K15A ,1,6 B48 B16A, 2,0 B48 A20A, B48 A20B, B48 A20E, B48 B20A, B48 B20B , 3,0 B58 B30A, B58 B30B, B58 B30C</p> <p>Mini</p> <p>1,2 B38 A12A , 1,5 B36 A15A, B38 A15A , 2,0 B46 B20A, B48 A20A, B48 A20B</p>

## KIT DE CALAGE POUR MINI 1.6

**54222** 59,00€

1.40 5 10 240

Kg SUB

**GASOLINA/PETROL**

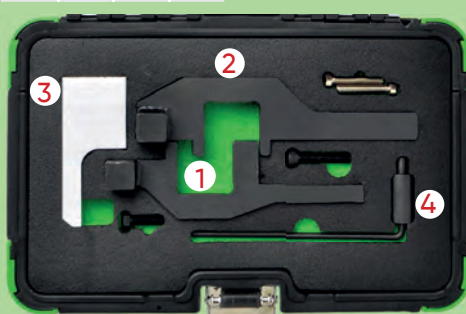

<b>MARQUES</b>	<p>BMW: Mini cooper S(07-10)</p> <p>Peugeot: 207(06-10), 307(06-10), GT(06-10), THP(06-10), GTi(06-10)</p> <p>Citroen: DS3(06-10), C4(06-10), Grande Picasso TPH(06-10)</p>
<b>OUTILS OEM</b>	119550(1), 119551(2), 119552(3), 119590(4)
<b>CODES MOTEUR</b>	N14 B16A , N14 B16CD , N14 B16TO

## COFFRET DE CALAGE POUR BMW DIESEL

**53265** 195,00€

5.45 - 2 40

Kg SUB

**DIESEL/GASOIL**

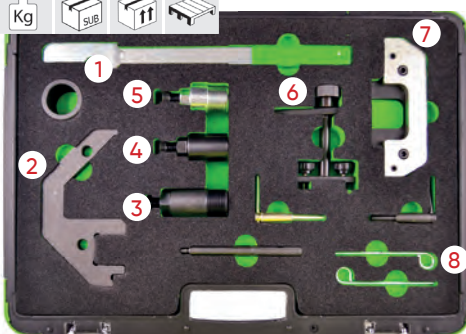

<b>MARQUES</b>	BMW
<b>OUTILS OEM</b>	113360 (1), 116321 (2), 135190 (3), 135191 (4), 135192 (5), 116322 (6), 112300 (7), 113340 (8)
<b>CODES MOTEUR</b>	M41 / M51 / M47TU / M47TU T2. M57TU T2 3.0i 1998 - 2008.

# COFFRET DE CALAGE POUR BMW M42 / 44 / 50 / 52 / 54 / 56

53267 277,00€

GASOLINA/PETROL

8,00	-	2	40
Kg	sub	11	11

<b>MARQUES</b>	BMW SERIES: 3, 5, 7, X, Z
<b>OUTILS OEM</b>	114220 (1), 112300 (2), 113240 (3), 115490 (4), 113292 (5), 113450 (6)
<b>CODES MOTEUR</b>	M40, M44, M50, M52, M54, M56.

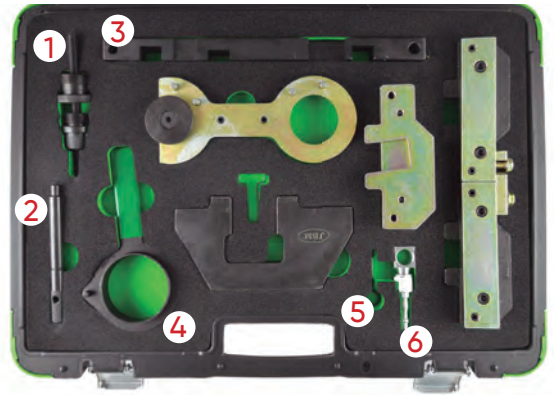

# COFFRET DE CALAGE POUR BMW N62 N73

53264 143,00€

GASOLINA/PETROL

4,65	-	2	40
Kg	sub	11	11

<b>MARQUES</b>	BMW 5 SERIES: 540i E60/61 (05-10), 545i E60/61 (03-06), 550i E60/61 (05-10). BMW 6 SERIES: 645i E63/64 (03-06), 650i E63/64 (05-11). BMW 7 SERIES: 735i E65/66 (02-05), 740i E65/66 (05-10), 745i E65/66 (02-05), 750i E65/66 (05-08), 760i E65/66 (02-08). BMW X SERIES: X5 4.4 E53 (03-07), X5 4.8 E53/E70 (04-10).
<b>OUTILS OEM</b>	119463 (1), 119462 (2), 119340 (3), 119461 (4), 119190 (5)
<b>CODES MOTEUR</b>	3.6 V8: N62 B36A 4.0 V8: N62 B40A 4.4 V8: N62 B44A 4.8 V8: N62 B48B 6.0 V12: N73 B60A

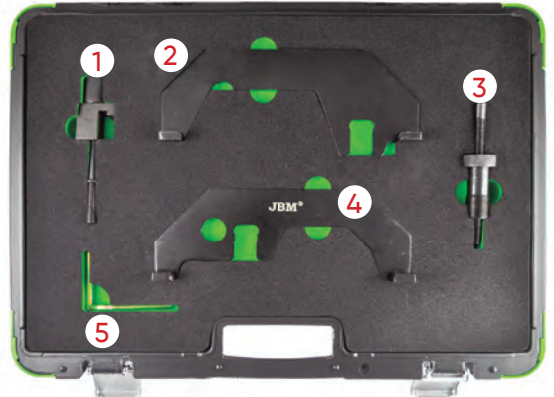

# COFFRET DE CALAGE POUR BMW

53266 224,00€

DIESEL/GASOIL

GASOLINA/PETROL

6,30	-	2	42
Kg	sub	11	11

<b>MARQUES</b>	BMW
<b>OUTILS OEM</b>	113240 (1), 115490 (2), 113190 (3), 112300 (4) (5), 113292 (6), 113320 (7)
<b>CODES MOTEUR</b>	ESSENCE: M42, M43, M50, M52, M60. DIESEL: M51

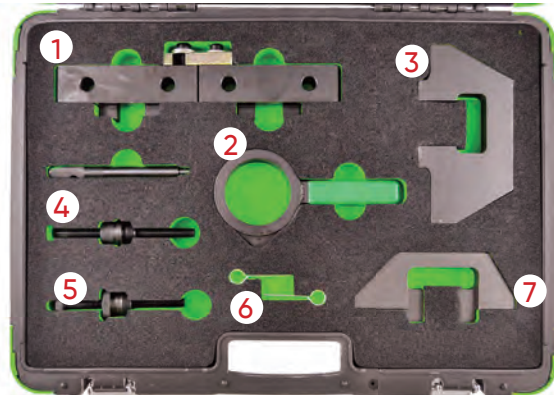

# COFFRET DE CALAGE POUR BMW

53269 50,00€

DIESEL/GASOIL

1,25	5	10	240
Kg	sub	11	11

<b>MARQUES</b>	BMW
<b>OUTILS OEM</b>	118760 (1), 118740 (2), 116480 (3), 115320 (4)
<b>CODES MOTEUR</b>	1.6 D: N47, C16K1, C16U1. 2.0 D: N47, C20K1, C20U1N47; D20, D20A, D20B, D20D, D20K1, D20O0, D20O1, D20T1, D20U0, D20U1, N47S D20TQ, N47T; D20, D20O1, D20U1. 3.0 D: N57; B30B, B30B/T0, B30C, D30BTO, D30O0, D30O1, D30TO, D30T1, D30U0. BMW 1 SERIES: 116d E81/82/87/88 (08-12), 118d E81/82/87/88 (07-14), 120d E81/82/87/88 (07-14), 123d E81/82/87/88 (07-14). BMW 2 SERIES: 218d (11-14), 220d (11-14), 225d (11-14). BMW 3 SERIES: 316d E90/91/92/93 (09-12), 318d E90/91/92/93 (07-12), 320d E90/91/92/93 (07-12), 325d E90/91/92/93 (10-14), 330d/xd E90/91/92/93 (08-14). BMW 5 SERIES: 520d E60/61 (07-10), 525d F10/11 (10-12), 530d F10/11 (10-13), 530dGT F07 (09-12), 535d F10/11 (10-17), 535dGT F07 (10-12). BMW 7 SERIES: 730d/Ld F01/02/04 (08-12), 740d F01/02/04 (09-12), 740d xDrive F01/02/04 (09-12), 750d xDrive F01/02/04 (12-15). BMW X SERIES: X1 sDrive 18d E84 (09-15), X1 sDrive 20d E84 (09-12), X1 xDrive 18d E84 (09-15), X1 xDrive 20d E84 (09-15), X1 xDrive 23d E84 (09-12), X3 2.0d E83 (07-10), X3 xDrive 18d E83 (08-10), X3 xDrive 30d E83 (11-12), X3 xDrive35d F25 (11-17), X5 3.0d E70 (10-13), X5 xDrive 40d X5 F15 M50d (13-17), E70 (10-13), X6 xDrive 30d E71/72 (10-14), X6 xDrive 40d E71/72 (10-14), X6 F16 M50d (14-17). BMW MINI: Paceman (13-17), Countryman (10-17), Mini (10-15), Roadster (12-14), Clubman (10-14), Clubvan (12-14).

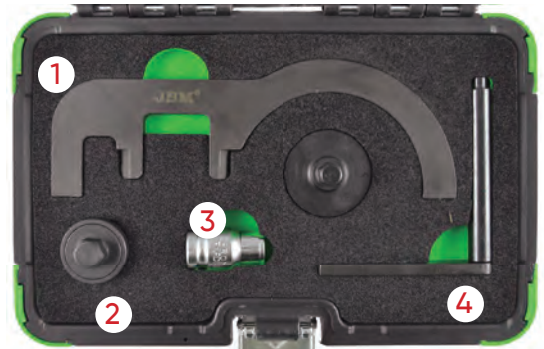

## KIT DE CALAGE POUR BMW & MINI 1.5/ 2.0L

<b>54206</b> 113,00€	<b>GASOIL/DIESEL</b>	<b>MARQUES</b>	<b>BMW</b> - 1 Series - 114d, 116d, 214d - (F20/ 21) - (2015- 2017) - 2 Series - 216d, 118d, 125d - (F22/ 23/ 45/ 46) - (2014-2017) - 3 Series - 218d, 220d, 225d - (F30/31/34) - (2015-2017) - 4 Series - 316d/320d/325d - (F32, 33, 36) - (2015-2017) - 5 Series - 420d, 425d, 418d - (F10, 11) - (2014-2017) - X1 Series - 518d - (F48) - (2015-2017) - X3 Series - (F25) - (2014-2017) - Efficient Dynamics - X4 Series - (F26) - (2014-2017) - xDrive - X5 Series - (F15) - (2015-2017) - sDrive <b>Mini</b> - Clubman - (F54) - (2015-2017) - One D Convertible - (F57) - (2016-2017) - Cooper D/ SD Mini Hatch (F55, 56) - (2014-2017)
1.75 - 5 135 Kg sub ff		<b>OUTILS OEM</b>	114120 (1), 2347904 (2), 2365488 (3), 2288380 (4), 118760 (5), 118740, 118030 (6)
		<b>CODES MOTEUR</b>	1.5: B37 D15A, B37 C15A 2.0: B47 D20A, B47 D20B, B47 C20A, B47, B47 C20B

## COFFRET DE CALAGE POUR BMW MINI / PSA 1.4 / 1.6

<b>53268</b> 92,00€	<b>GASOLINA/PETROL</b>	<b>MARQUES</b>	<b>BMW MINI:</b> Mini Clubvan R55 (12-14), Mini Clubman R55 (08-14), Mini Countryman R55 (07-10), Mini Clubman R56/R57 (07-15), Mini R56/R57 (08-15), Mini Coupe R58 (11-15), Mini Roadster R59 (08-15), Mini Clubman R60 (10-14), Mini Clubvan R60 (12-14), Mini Roadster R61 (13-15), Mini Paceman R61 (14-15), Mini Countryman R60 (10-17). <b>CITROËN:</b> C4 (08-11), C4 Picasso (08-13) C4 Grand Picasso (13-15). <b>PEUGEOT:</b> 207 (06-14), 207CC (07-15), 308 (07-15), 3008 (09-15), 5008 (09-15).
2.60 - 5 120 Kg sub ff		<b>OUTILS OEM</b>	<b>BMW MINI:</b> 115590 (1), 119340 (2), 119551 (3) <b>CITROËN:</b> 0197-A1, 0197-A3, 0197-B. <b>PEUGEOT:</b> 0197-A1, 0197-A3, 0197-BZ.
		<b>CODES MOTEUR</b>	1.4: N12B14, N14B14AB. 1.6: EP3(8FS), EP3C(8FR), EP6(5FW), EP6C(5FS), EP6CDT(5FV), EP6DT(5FT), EP-6DT(SFX), EP6DTS(SFY), N14B16A, N14B16CD, N14B16TO, N14B16CD/TO, N16B16A, N16B16KO, N16B16A/MO, N16B16A/MO, N16B16MO, N16B16UO.

## COFFRET DE CALAGE POUR BMW MINI N13, N18

<b>54227</b> 122,00€	<b>GASOLINA/PETROL</b>	<b>MARQUES</b>	<b>BMW :</b> Serie 1 (2011 - 2015), Serie 3 (2012 - 2015). <b>MINI:</b> Clubman (2011 - 2014), Mini (2010 - 2015), Coupe (2011 - 2015), Roadster (2012 - 2015), Countryman (2010 - 2017) and Paceman (2013 - 2017).
2.40 - 5 135 Kg sub ff		<b>OUTILS OEM</b>	117440 (1), 119340 (2), 2299362 (3)
		<b>CODES MOTEUR</b>	N12, N13, N14, N18, EP3, EP6

## COFFRET DE CALAGE POUR BMW/MINI/CITROEN/PEUGEOT

<b>54219</b> 60,00€	<b>GASOLINA/PETROL</b>	<b>MARQUES</b>	BMW, MINI, PSA
1.09 - 5 135 Kg sub ff		<b>OUTILS OEM</b>	115140(1), 119280(2), 119330(3), 113340 (4), 114360 (5)
		<b>CODES MOTEUR</b>	<b>BMW 1.6</b> (N40 / N45 / N45T, B16, B16A, B16AC) 1.8 / 2.0 (N42 / N46 / N46T) 2.0 / 3.0 (N51 / N52 / N52-Composante / N53 / N54) <b>PSA 1.4 / 1.6 16V</b> (EP3 / EP6 / EP6DT / EP6DTS) <b>MINI 1.4 / 1.6</b> (N12 / N14)

# OUTIL D'INSTALLATION ET DE DÉMONTAGE D'INJECTEURS DE CARBURANT POUR **BMW MERCEDES BENZ**

**54220** 197,00€

GASOLINA/PETROL

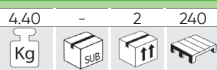

<b>MARQUES</b>	<b>BMW:</b> 135is (2008-),335 (2007-),335xi (2007-),535i (2008-),535xi (2008-),550i GT (2010-),750Li (2009-) 750i (2009-), X3 3.0i (2007-),X5 (2011-),X5 3.0i (2008-),X6 (2008-) <b>MERCEDES-BENZ:</b> C-class (2007-),CLK / SLK (2007-),E-class (2007-),A / CLA / GLA 45 AMG (2013-),CL / CLS 63 AMG (2010-),E / G / GL 63 AMG (2011-),GLE 63 AMG (2015-),S / SL 63 AMG (2010-),SLK 55 AMG (2012-)
<b>OUTILS OEM</b>	BMW: 130180(1), 130195(2), 130270(3), 130320(4), 2249115(5) Mercedes-Benz: 271589023300(6), 278589003300(7)
<b>CODES MOTEUR</b>	BMW : N14 / N18 / N20 / N47 / N54 / N57 / N55 / N63 Mercedes-Benz :M133 / M152 / M157 / M270 / M271 / M274 / M276 / M278

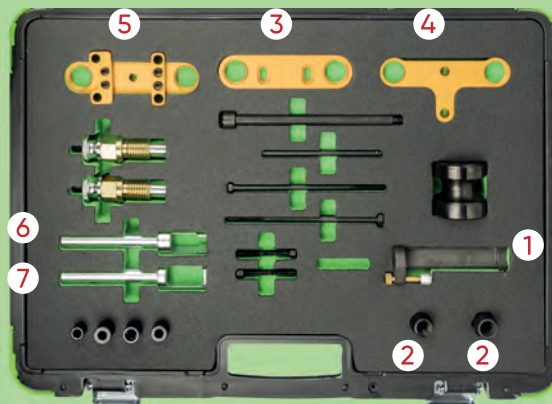

## COFFRET DE CALAGE POUR **MERCEDES BENZ M271**

**53271** 227,00€

GASOLINA/PETROL

GASOIL/DIESEL



<b>MARQUES</b>	MERCEDES
<b>OUTILS OEM</b>	271 589 003100 (1), 271589014000 (2), 271589001500 (3), 156589006100 (4)
<b>CODES MOTEUR</b>	M271, E18ML 2002, DE18ML 2003 - 2005, E16ML 2008, DE18LA 2009.

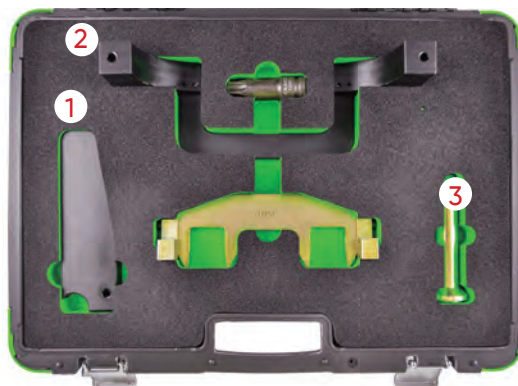

## COFFRET DE CALAGE POUR **MERCEDES AMG 156**

**53272** 195,00€

GASOLINA/PETROL

GASOIL/DIESEL

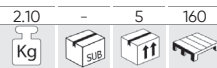

<b>MARQUES</b>	MERCEDES
<b>OUTILS OEM</b>	156589006100 (1), 156589003200 (2), 156589016300 (3), 156589006900 (4)
<b>CODES MOTEUR</b>	BENZ AMG 156,ML 63 AMG.S 63L AMG.S 63. AMG. R 63 AMG L 4MATIC. R63 AMG 4MATIC. E 63 AMG. CLS 63 AMG. CLK 63 AMG. CLK 63 AMG Black series. CLK 63 AMG Cabrio. CL 63 AMG.

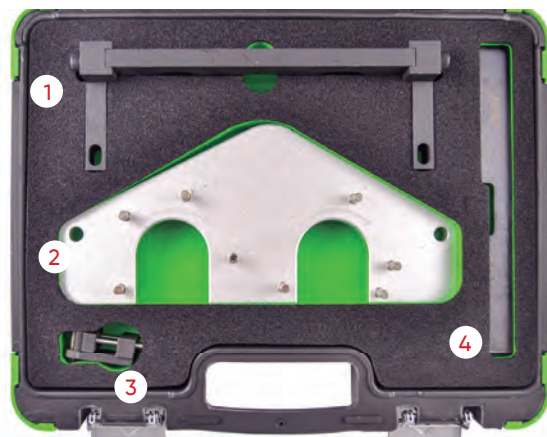

## COFFRET DE CALAGE POUR **MERCEDES / CHRYSLER / JEEP**

**53270** 70,00€

GASOLINA/PETROL

GASOIL/DIESEL

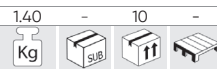

<b>MARQUES</b>	MERCEDES CHRYSLER JEEP
<b>OUTILS OEM</b>	112589034000 (1), 601589024000 (2), 111589031500 (3)
<b>CODES MOTEUR</b>	Herr: 112 589 03 40 00: 112, 113, 137, 155, 156, 272/979, 273, 629, 642/992. Herr: 601 589 02 40 00: 102, 103, 104, 111, 601, 602.91/93/94/96/983, 603.91/93/96/97, 604, 605, 606, 611, 612/965/966, 613. Herr: 111 589 03 15 00: 111, 119, 604, 605, 606, 611/980, 612, 613, 628, 629, 640, 642/922, 612.965/966, 646, 647, 648.

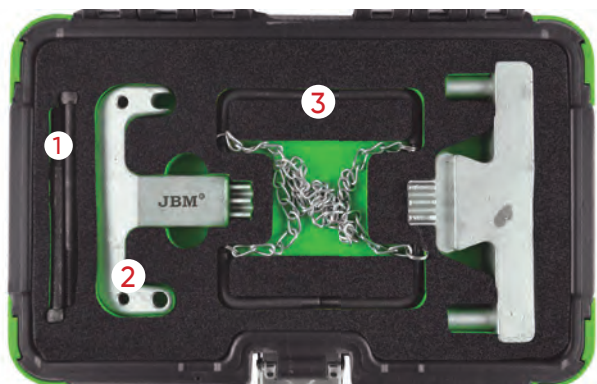

# COFFRET DE CALAGE POUR MERCEDES M276 / M157 / M278

53273 75,00€

GASOLINA/PETROL

GASOIL/DIESEL

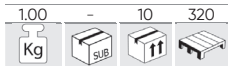

MARQUES	MERCEDES	
OUTILS OEM	27658901400	
CODES MOTEUR	CL 500 / 63 AMG (C 216) 2010-2013. S 500 / 63 AMG (C 217) 2014. CLS 300 (C 218) 2012. E 300 / 350 / 400 (C/A 207) 2011. CLS 350 / 400 / 500 / 63 AMG (C/X 218) 2011-2014. SLK 350 (R 172) 2011. SL 350 / 400 / 500 / 63 AMG (R 231) 2012. S 500 PLUG-IN HYBRID (V 222) 2014. ML 300 / 350 / 500 / 63 AMG (W 166) 2011.	C 400 (W 205) 2014. E 400 HYBRID (W 212) 2012. G 63 AMG (W 463) 2012. E 300 / 350 / 400 / 500 / 63 AMG (W/S 212) 2011. C 350 (W/S/C 204) 2011. S 350 / 500 / 63 AMG (W/V 221) 2010. S 400 / 63 AMG (W/V 222) 2013. R 350 BlueEFFICIENCY (W/V 251) 2012. GL 450 / 500 (X 166) 2012. GLK 350 (X 204) 2011.

# KIT DE CALAGE POUR CHRYSLER JEEP LDV 2.5 CRD

54207 38,90€

GASOIL/DIESEL

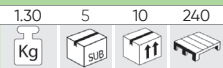

MARQUES	Chrysler: Voyager (01-08), Grand Voyager (01-08) Jeep: Cherokee (01-08) LDV: Maxus (05-09)	
OUTILS OEM	VM 9660 (1), VM1052 (2), VM1053 (3), VM1068 / VM1089 (4), VM1080 (5), VM8873 (6)	
CODES MOTEUR	2.5D CRD: R2516C, R2516K, R2516LVM39/40B.	2.8D CRD: R2816C5.05A, R2816K4.

# COFFRET DE CALAGE POUR VAG 1.2 TFSI

54092 24,00€

GASOLINA/PETROL

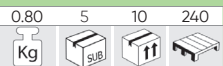

MARQUES	<u>Audi</u> : A1, A3, A3 Sportback, A3 Cabrio <u>Seat</u> : Altea, Altea XL, Ibiza, Leon, Toledo <u>Skoda</u> : Fabia II, Oktavia II, Praktik, Rapid, Rapid Spaceback, Rommster, Yeti <u>VW</u> : Beetle, Caddy, Caddy Maxi, Golf Plus, Golf VI, Golf VI Cabrio, Golf VI Estata, Jetta, Polo, Touran
OUTILS OEM	T10340(1), T10414(2), T10341(3)
CODES MOTEUR	CBZA, CBZB, CBZC

# KIT OUTILLAGE POUR COURROIE DE DISTRIBUTION VW / AUDI

53277 45,00€

GASOLINA/PETROL

GASOIL/DIESEL

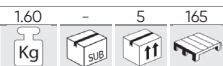

MARQUES	ESSENCE	<u>AUDI</u> : 80, 100, A3, A4, A6 1.6, 1.8/Turbo, 2.0, 2.0 16v, A3, A4 1.6 (96-). <u>SEAT</u> : Ibiza/Cordoba, Toledo, Alhambra, Inca 1.6, 1.8, 1.8 16v, 2.0, 2.0 16v/Ibiza/ Cordoba, Leon, Toledo 1.6 (99-), Alhambra 2.0 (00-). <u>VOLKSWAGEN</u> : Polo Classic, Scirocco, Corrado, Golf, Jetta, Vento, Passat, Sharan, Transporter 1.6, 1.8/Turbo, 1.8 16v, 2.0, 2.0 16v, Polo Classic, Golf, Bora, Beetle 1.6 (97-), 2.0 (99-). <u>SKODA</u> : Octavia 1.6 (97-), 2.0 (99-).
	DIESEL	<u>AUDI</u> : 80, 100, A3, A4, A6 1.9 Turbo D, 1.9TDi, 2.5TDi, A3, A4, A6 2.0TDi, A2, A3, A4, A6 1.2TDi, 1.4TDi, 1.9TDi (99-). <u>SEAT</u> : Ibiza/Cordoba, Leon, Toledo, Alhambra, Inca 1.7SDi, 1.9D/TD /Sdi/Tdi. <u>FORD</u> : Galaxy (02-06). <u>SKODA</u> : Felicia, Octavia 1.9D/Tdi. <u>VW</u> : Polo, Polo Classic, Golf, Jetta, Vento, Bora, Beetle, Passat, Sharan, Caddy, Transporter 1.5D, 1.6D/ Turbo, 1.7D/Sdi, 1.9Sdi/Tdi, Golf, Passat 2.0TDi.
OUTILS OEM	T10020 (1), 3387 (2), V159 (3), T10060/T100604 (4), T10115 (5), T40011 (6)	
CODES MOTEUR	2.0, 2.8, 3.0	

## KIT DE CALAGE DE LA DISTRIBUTION POUR VAG 1.2/1.4 TSI

53648 107,00€

GASOLINA/PETROL

3.70	-	2	48
Kg	sub	ff	

<b>MARQUES</b>	AUDI: A1 (12-15), A1 Sportback (12-15), A3 (13-15), A3 Sportback (12-15). SEAT: Ibiza (12-15), Leon (12-15), Toledo (12-15). SKODA: Fabia (10-13), Octavia II (10-13), Octavia III (10-15).
<b>OUTILS OEM</b>	T10060A (1), T10340 (2), T10476 (3), T10494 (4), T10499 (5), T10504/1 (6), T10504 (7), T10504/2 (8).
<b>CODES MOTEUR</b>	1.2 TSi: CJZA, CJZB. 1.4 TSi: CGGA, CHPA, CMBA, CPVA, CRJA, CXSA. 1.4 TSi ACT: CPTA.

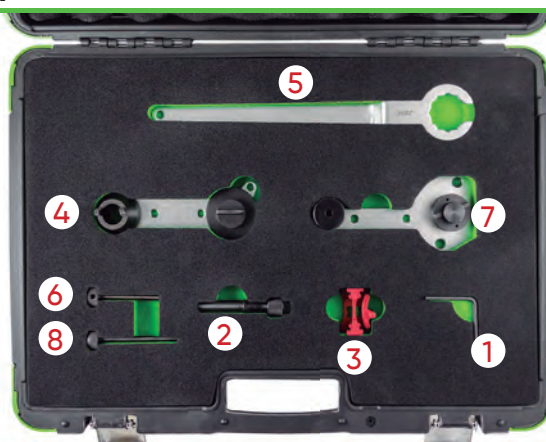

## KIT DE CENTRAGE DE L'ARBRE DE DISTRIBUTION VAG 1.4/1.6/2.0 TDI AVEC SYSTEME DE CARBURANT COMMON RAIL

53706 98,00€

GASOIL/DIESEL

1.95	-	5	150
Kg	sub	ff	

<b>MARQUES</b>	VOLKSWAGEN: Golf Alltrack, Golf Sportsvan, Golf VII, Golf VII Kombi, Passat, Polo. AUDI: A1, A1 Sportback, A3, A3 Cabriolet, A3 Limousine, A3 Sportback, TT, TT Roadster. SEAT: Ibiza, Ibiza V Sportcoupe, Ibiza V ST, Leon, Leon SC, Leon ST, Toledo IV. SKODA: Fabia, Fabia Kombi, Octavia, Octavia Combi, Rapid, Rapid Spaceback.
<b>OUTILS OEM</b>	OEM 3204 (1), OEM 3359 (2), OEM T10490 (3), OEM T10051 (4), OEM T10060A (5), OEM T10264 (6), OEM T10265 (7), OEM T10492 (8), OEM T40098 (9).
<b>CODES MOTEUR</b>	1.4, 1.6, 2.0 TDI CR CXXB, DBKA, DCXA, CGLE, CKFB, CKFC, CLHA, CLHB, CNHA, CNHC, CRBD, CRFA, CRFC, CRKA, CRKB, CRLB, CRLC, CRMB, CRUA, CRVA, CRVC, CSUA, CSUB, CUNA, CUPA, CUSA, CUSB, CUTA, CUUD, CXEB, DBKA, DCXA, DCZA, DFSD.

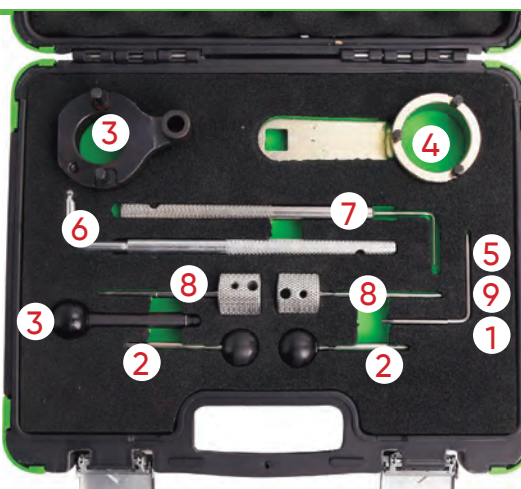

## COFFRET DE CALAGE POUR VAG 2.5 / 4.9D / TDI

53284 306,00€

GASOIL/DIESEL

8.90	-	2	48
Kg	sub	ff	

<b>MARQUES</b>	VOLKSWAGEN: Touareg (03-10), Transporter (03-09).
<b>OUTILS OEM</b>	T10225 (1), T10199 (2), T10234 (3), T10226 (4), T10193 (5), T10194 (6), T10199/01 (7), T10226 (8)
<b>CODES MOTEUR</b>	2.5D TDi PD; AXD, AXE, BAC, BLJ, BLK, BNZ, BPC, BPD, BPE.

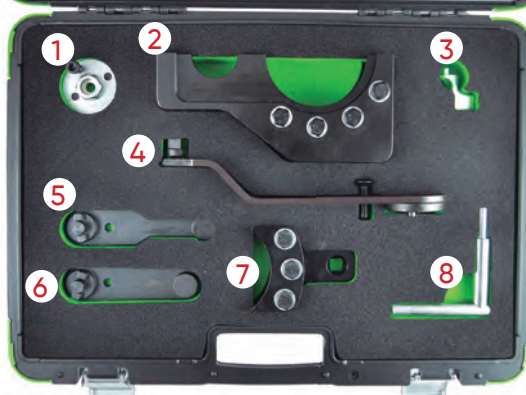

## COFFRET DE CALAGE POUR AUDI V6 2.0 / 2.8 / 3.0 TFSI

53278 143,00€

GASOLINA/PETROL

4.75	-	2	40
Kg	sub	ff	

<b>MARQUES</b>	A2, A4, A4 Quattro, A6 (2004-2007) A2, A3, A4, A3 FSI (2004-2007) A4, A6, A8 3.2 FSI A6 L Quattro 2.4 A6 2.4, A6 2.4 Quattro (2004-2007) A4 3.2 FSI (2004-2007) A6 3.2 FSI (2004-2007) A8 3.2 FSI (2005-2007)
<b>OUTILS OEM</b>	T10172 (1), 3212 (2), T40070 (3), T40069 (4), T40071 (5), T10172/2 (6)
<b>CODES MOTEUR</b>	AUK / BDW / BDY / BKH / CAJA / CALA

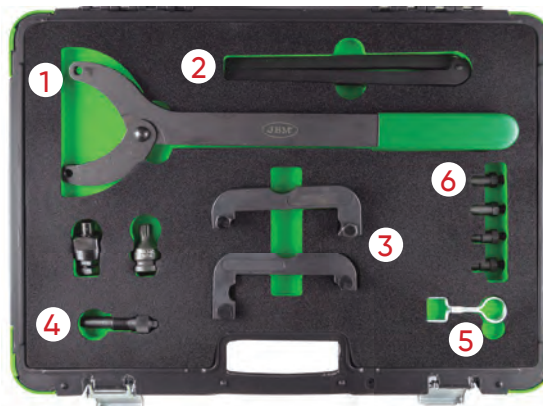



## COFFRET DE CALAGE POUR **AUDI / SKODA**

**53276** 160,00€

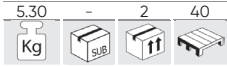

GASOLINA/PETROL

**GASOIL/DIESEL**

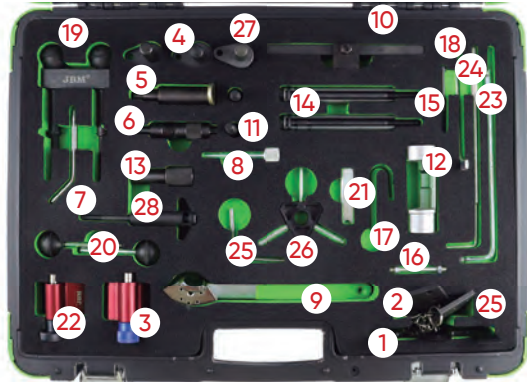

<b>MARQUES</b>	<u>AUDI VW MOTEURS:</u> V6 2.0, 2.8, 3.0T FSI. <u>AUDI QS:</u> 2.0 , A6L 2.8 , 3.0T.
<b>OUTILS OEM</b>	3418 (1), 3458 (2), T10100 (3), T10123 (4), T10121 (5), 3242 (6), 3551 (8), T10020 (9), T10098 (10), 3078 (12), 2064 (13), 3369 (14), T10092 (15), T40011 (17), 2065A (18), T10016 (19), 3359 (20), T10008(21), T10050 (22) T10265 (23), T10264 (24), T10060A (25), T10120 (27), 3366 (28)
<b>CODES MOTEUR</b>	2.0, 2.8, 3.0

## KIT ALIGNEMENT **ARBRE À CAMES VW / AUDI**

**53281** 55,00€



**GASOIL/DIESEL**



<b>MARQUES</b>	<u>VOLKSWAGEN:</u> 2.5 TDi V6 DIESEL <u>AUDI:</u> A4, A6, A8
<b>OUTILS OEM</b>	3369 (1), 3242 (2), 3458 (3)
<b>CODES MOTEUR</b>	AFB/AKN

## COFFRET DE CALAGE POUR **VW / AUDI**

**53282** 48,00€

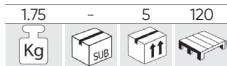

GASOLINA/PETROL



<b>MARQUES</b>	<u>SEAT:</u> Alhambra (10-15), Altea/Altea XL (08-15), Ibiza/ Cordoba (08-12), Leon (07-13), Toledo (07-15). <u>VOLKSWAGEN:</u> Beetle (11-15), Caddy/Caddy Maxi (10-15), EOS (06-12), Golf (03-12), Golf Plus (03-14), Golf V Estate (07-13), Golf VI Cabriolet (10-15), Jetta (06-14), Passat (05-11), Polo (02-14), Scirocco (08-12), Tiguan (07-12), Touran (03-15). <u>SKODA:</u> Fabia II (07-15), Octavia II (04-15), Praktik (10-15), Rapid (12-15), Roomster (06-15), Superb II (09-14), Yeti (09-14). <u>AUDI:</u> A1 (10-15), A3 (03-13).
<b>OUTILS OEM</b>	T10171 (1), T10170 (2), T40011 (3)
<b>CODES MOTEUR</b>	1.2 TFSI: CBZA, CBZB, CBZC. 1.4 FSI: AXU, BKG, BLN. 1.4 TFSI: BLG, BMY, BWK, CAVA, CAVB, CAVC, CAVD, CAVE, CAVF, CAXA, CAXC, CDGA, CSMA. 1.6 FSI: BAG, BLF, BLP, BTS.

## COFFRET DE CALAGE POUR **VOLKSWAGEN / SEAT / SKODA 1.2L**

**53274** 30,50€

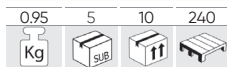

GASOLINA/PETROL

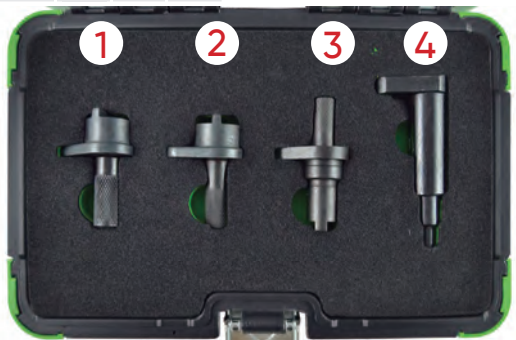

<b>MARQUES</b>	VOLKSWAGEN 1.2: Lupo / Polo / Eos / Fox. SEAT 1.2: Ibiza / Cordoba SKODA 1.2: Fabia
<b>OUTILS OEM</b>	T10123 (1) (2), T10120 (3), T10121 (4)
<b>CODES MOTEUR</b>	AWY / BMD / AZQ / BME.

## COFFRET DE CALAGE POUR VW / AUDI 2.0TFSI

53279 97,00€

2.10	-	5	135
Kg	sub	ff	

GASOLINA/PETROL

### MARQUES

**AUDI:** A3 (96-09), A4 (94-09), A6 (95-11), S3 (99-13), TT (98-14).  
**SEAT:** Alhambra (97-10), Altea/Altea XL (06-09), Cordoba (99-02), Exeo (09-10), Ibiza (99-02), Leon (99-13), Toledo (99-09).  
**SKODA:** Octavia/Octavia Tour (98-10), Octavia II (04-09).  
**VOLKSWAGEN:** Beetle (99-11), Bora (97-04), Eos (06-10), Golf (97-12), Golf Plus (05-09), Jetta (05-09), Passat (96-10), Scirocco (09-14), Sharan (97-10), Touran (03-09).

### OUTILS OEM

T10020 (1), T10252 (2), T10092 (3), T10115 (4), T40011 (4), 3366 (5), T10060 (6)

### CODES MOTEUR

1.8: ADR, AFY, AGN, AJP, APG, APT, AQE, ARG, ARH, AVV.  
 1.8T: AEB, AGU, AJH, AJL, AJQ, AMK, AMU, ANB, APP, APU, APX, APY, AQA, AQX, ARX, ARY, ARZ, AUM, AUG, AVC, AWC, AWT, AWU, AYP, BAM, BFV, BVP, BVR.  
 2.0 FSI: AXW, BHD, BLR, BLX, BLY, BMB, BVX, BVY, BVZ.  
 2.0 TFSI/S/R/Tsi: AXX, BPY, BWA, BGB, BPG, BPJ, BUL, BWE, BWT, BYK, BHZ, BZC, BWJ, BYD, CDLA, CDLB, CDLC, CDLD, CDLF, CDMA.



## COFFRET DE CALAGE POUR VAG TFSI, FSI

54199 94,00€

2.10	-	5	135
Kg	sub	ff	

GASOLINA/PETROL

### MARQUES

**Audi:** A1 (10-15), A1 Sportback (10-15), A3 Cabriolet (10-13), A3 (10-15), A3 Sportback (03-13).  
**Seat:** Altea/Altea XL (10-15), Ibiza (10-15), Leon (10-13), Toledo (12-15).  
**Skoda:** Fabia II (10-15), Praktik (10-15), Rapid (12-15), Rapid Sportback (12-15), Octavia II (04-13), Yeti (09-15), Yeti Outdoor (13-15).  
**VW:** Beetle (11-15), Caddy/Caddy Maxi (10-15), EOS (07-15), Golf V (03-13), Golf V Estate (07-09), Golf VI (10-13), Golf VI Estate (10-13), Golf VI Cabriolet (11-15), Golf Plus (05-14), Jetta (05-14), Passat (05-15), Polo (09-14), Scirocco (08-14), Tiguan (07-15), Touran (03-15).

### OUTILS OEM

T10414 (1), VAS 6079 (2), T10170 (3), T10171 (4), T40011 (5), T10340 (6), T10341 (7)

### CODES MOTEUR

1.2 TFSI: CBZA, CBZB, CBZC  
 1.4 FSI/TFSI: BLG, BMY, BWK, CAVA, CAVB, CAVC, CAVD, CAVE, CAVF, CAXA, CAXC, CDGA, CSMA  
 1.6 FSI: BAG, BLF, BLP

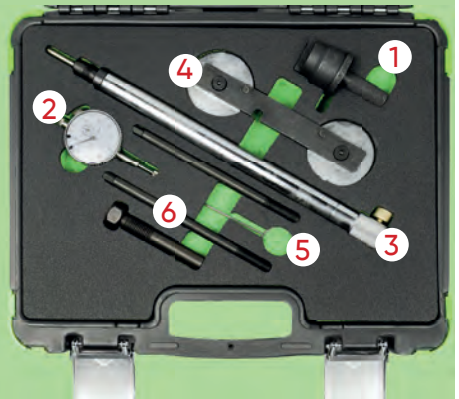

## KIT ALIGNEMENT ARBRE À CAMES VW / AUDI

53280 112,00€

3.50	-	5	165
Kg	sub	ff	

GASOLINA/PETROL

### MARQUES

**AUDI:** A4 (01-08), A6 (01-08), A8 (03-10).

### OUTILS OEM

3387 (1), T40030 (2) (4), T40026 (3), T40028 (5)

### CODES MOTEUR

3.0 V6 3.0v: ASN, AVK, BBJ, BGN.



## KIT DE VERROUILLAGE DE CHAINES POUR VW / AUDI

53326 16,00€

0.30	10	40	-
Kg	sub	ff	

GASOIL/DIESEL



### MARQUES

**VW:** V6 2.5TDi.  
**AUDI:** V6 2.5TDi, V8 3.3TDi.

### OUTILS OEM

3458 (1), 3242 (2)

## KIT DE VERROUILLAGE DE CHAINES POUR VW 1.2L

53327 11,00€

0.20	10	60	3600
Kg	sub	ff	

GASOLINA/PETROL



### MARQUES

**SEAT:** Ibiza 1.2 6v/3cyl (2002-09), Cordoba 1.2 12v/3cyl (2002-13).  
**VW:** Polo 1.2 6v-12v/3cyl (2002-14).  
**SKODA:** Fabia 1.2 6v-12v/3cyl (2002, 2003-), Fabia II 1.2 6v/3cyl (2007-13), Roomster 1.2 12v/3cyl (2006-13), Praktik 1.2 6v/3cyl (2007-13).

### OUTILS OEM

T10123.

### CODES MOTEUR

1.2 6v: AWY, BMD, BBM, CHFA, CHFB  
 1.2 12v: AZQ, BME, BVX, BZG, CEVA, CGPA, CGPB, CGPC.

## COFFRET DE CALAGE POUR VAG 2.7 / 3.0 TDI

53283

92,00€

GASOIL/DIESEL



MARQUES	VOLKSWAGEN: Touareg, Phateon VAG: Diesel 2.7 / 3.0 V6 AUDI: A4, A5, A6
OUTILS OEM	3242 (1), T40060 (2) (3), 3359 (4), T40058 (5), T40061 (6), T40062 (7), T40049 (8)
CODES MOTEUR	ASB, BKN, BKS, BWZ, BNG, BPP, BSG, BUG, BUN, CAWA, CABB, CANA, CANB, CANC, CAND, CAPA, CARA, CARS, CASA, CASE, CASC, CAM, CC/ HA, CCWA, CCWB, CDYA, CDVB, CDVC, CEXA, CGKA, CGKB.

## COFFRET DE CALAGE POUR VAG 2.4 / 2.5D SDI

53285

56,00€

GASOLINA/PETROL

1,95 - 5 135



MARQUES	VOLKSWAGEN: Crafter (06-13), LT (96-06), Transporter (90-03).
OUTILS OEM	2065A (1), T50009 (2), T10025 (3), 3248/3419 (4), 2064 (5), 3355 (6)
CODES MOTEUR	2.4D: AAB, AJA. 2.5D SDI: AGX. 2.5D Tdi: ACV, AHD, AHY, AJT, ANJ, APA, AUF, AVR, AXG, AXL, AYC, AYY, BBE, BBF. 2.5D TDiCR: BJJ, BJK, BJL, BJM.

## COFFRET DE CALAGE POUR VAG 1.8 / 2.0 TSI

53286

87,00€

GASOLINA/PETROL

2,00 - 5 135

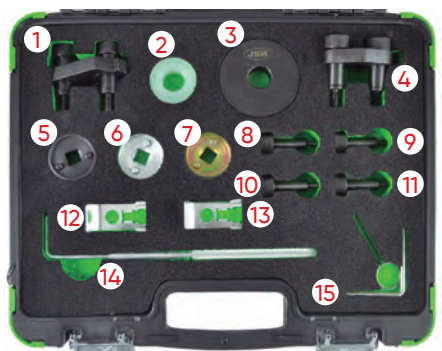

MARQUES	VOLKSWAGEN: 1.8 / 2.0 TSI / TFSI.
OUTILS OEM	T10368 (2), T10354 (3), T40271 (1)(4), T10352/2 (5), T10352/1 (6), T10352 (7), T40196 (8) (9) (10) (11), T40267(12) (13), T40098 (14), T10060A (15), T40011 (15)
CODES MOTEUR	BYT, BZB, CABA, CABB, CABD, CADA, CAEA, CAEB, CAWA, CAWB, CBFA, CCTA, CCZA, CCZB, CCZC, CDA, CDAB, CDHA, CDHB, CDNB, CDNC, CDND, CESA, CETA, CFKA, CGYA, CJEB, CJBA, CJSB.

## COFFRET DE CALAGE POUR VW / AUDI 1.8 / 2.0L

53287

245,00€

GASOLINA/PETROL

4,60 - 2 40

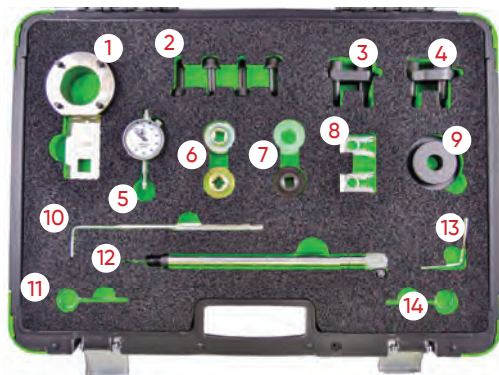

MARQUES	VOLKSWAGEN AUDI	1.8 / 2.0 TURBO
OUTILS OEM	T10355 (1), T40196 (2), T40271 (3) (4), T10352 (5), T10352/1 (6), T10352/2 (7), T10368 (7), T40267 (8), T10354 (9), T40265 (10), T40011 (11) (14), T40098 (12), T10060A (13)	
CODES MOTEUR	BYT, BZB, CABB, CABD, CADA, CAEA, CAEB, CAWA, CAWB, CBFA, CCTA, CBFA, CCTA, CCZA, CCZB, CCZC, CDA, CDAB, CDHB, CDNB, CDNC, CDND, CESA, CETA, CFKA, CGYA, CJEB, CJSB, CJSB.	

## COFFRET DE CALAGE POUR VW / AUDI

53275 35,50€

GASOIL/DIESEL

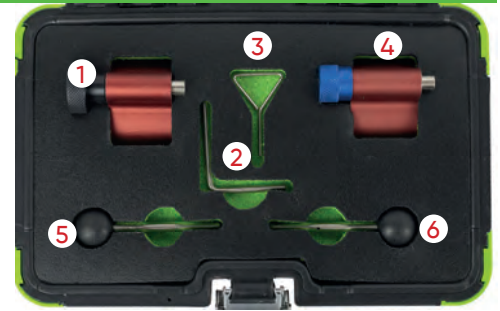
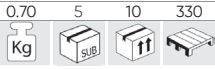

### MARQUES

**DODGE:** Caliber (06-11)  
**FORD:** Galaxy (02-06)  
**MITSUBISHI:** Grandis (05-10), Lancer (05-10), Outlander (07-10).  
**SEAT:** Alhambra (00-15), Altea/Altea XL (04-15), Cordoba (02-09), Ibiza (02-15), Leon (00-13), Toledo (04-11).  
**SKODA:** Fabia (00-14), Fabia II (07-15), Octavia (00-10), Octavia II (04-15), Praktik (10-15), Rapid (11-15), Roomster (07-15), Superb (02-08), Superb II (08-15), Yeti (09-14).  
**AUDI:** A1 (10-15), A2 (00-06), A3 (01-13), A4/Allroad (01-16), A5 (08-15), A6 (11-14), TT (08-14), Q3 (11-15), Q5 (08-15), A6 (10-14).  
**VOLKSWAGEN:** Amarok (10-16), Beetle (02-15), Bora (02-08), Caddy/Maxi (03-15), EOS (06-15), Fox (05-11), Golf (02-15), Golf Plus (05-14), Jetta (05-15), Lupo (02-05), Passat/CC (02-15), Polo (99-14), Scirocco (08-14), Sharan (02-15), Tiguan (07-15), Touran (03-15), Transporter (03-17).

### OUTILS OEM

**DODGE:** 9882, 9883.  
**FORD:** 310-085/23-059, 303-1054.  
**MITSUBISHI:** MB995206, MB995208, MB995209.  
**VAG:** T10100 (4), T10050 (1), 3359 (3/6)/T20102, T10115 (3), T10060A (2)/T40098, T20167.

### CODES MOTEUR

1.2D TDi CR: CFWA.  
 1.4D TDi PD: AMF, BAY, BMS, BNM, BNV, BWB.  
 1.6D TDi CR: CAYA, CAYB, CAYC, CAYD, CAYE, CLNA.  
 1.9D TDi PD: AJM, ANU, ARL, ASZ, ATD, AUY, AVB, AVF, AVQ, AWX, AXB, AXC, AXR, BJB, BKC, BLS, BLT, BMT, BPZ, BRM, BRJ, BRS, BRU, BSU, BSV, BSW, BTB, BVK, BXE, BXF, BXJ.  
 2.0D TDi CR/TDi PD: AZV, BDJ, BDK, BEW, BGW, BHW, BKD, BKP, BKQ, BLB, BMA, BMM, BMN, BMP, BMR, BNA, BPW, BRA, BRC, BRD, BRE, BRF, BRT, BSS, BST, BSY, BUY, BUZ, BVA, BVE, BVF, BVG, BVH, BWC, BWV, CAAA, CAAB, CAAC, CAAD, CAEE, CAGA, CAGB, CAGC, CAHA, CAHB, CBAA, CBAB, CBAC, CBBA, CBBB, CBDA, CBDB, CBDC, CBEA, CCHA, CCHB, CDBA, CDCA, CEGA, CFCA, CFFA, CFFB, CFFD, CFFE, CFGB, CFGC, CFHA, CFHB, CFHC, CFHD, CFHE, CFHF, CFJA, CGLA, CGLB, CGLC, CGLD, CJAA, CJCA, CJCB, CJCC, CLCA, CLCB, CLJA, CLLA, CNEA, ECD, ECD/BSY, ECD/BYL, ECE/BWD.

## KIT DE CALAGE DISTRIBUTION POUR AUDI / VW / SEAT / SKODA

53649 89,00€

GASOLINA/PETROL

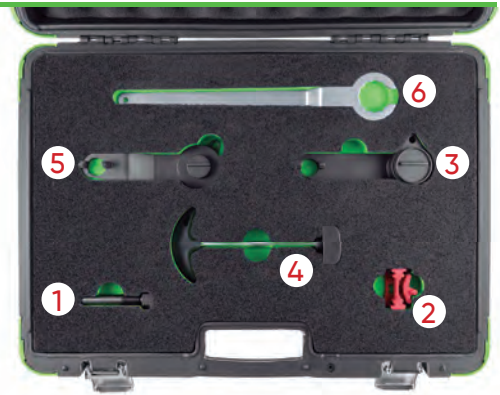
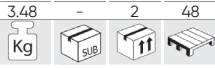

### MARQUES

**AUDI**  
**SEAT**  
**SKODA**  
**VW**

### OUTILS OEM

T10340 (1), T10476 (2), T10477 (3), T10487 (4), T10494 (5), T10499 (6)

### CODES MOTEUR

1.0 MPI: CHYA.  
 1.0 TSI: CHZE, CHZC, CHZA, CHZB, CHZC, CHZD, CHZJ.  
 1.2 TSI: CJZB, CJZC, CYVA, CJZA, CJZD, CYVB.  
 1.4 TSI: CZCC, CMBA, CZCA, CHPA, CPTA (ACT), CZDA, CVNA, CZIA (ACT).

## COFFRET DE CALAGE POUR VAG 1.6 / 2.0L TDi PD COMMON RAIL

53288 72,00€

GASOIL/DIESEL

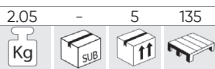

### MARQUES

**SEAT:** Exeo, Leon, Altea, Toledo, Ibiza.  
**VOLKSWAGEN:** Jetta, Touran, Golf, Golf Plus, Polo, Passat, Tiguan, Scirocco.  
**SKODA:** Roomster, Fabia, Praktik, Octavia, Yeti, Superb.  
**AUDI:** A1, A3, A4, A5, Q5, A6, TT.

### OUTILS OEM

T10264 (1), T10265 (2), T20102 (3), T10052 (4), T10051 (5), T10255 (6), T10050 (7), T10100 (8), T40098 (9)

### CODES MOTEUR

1.2 TDI CR, 1.6 D TDI CR, 2.0 D TDI CR

CAGA, CAGB, CAGC, CAHA, CAHB, CFHC, CBAA, CBAB, CFFB, CGLA, CGLB, CJCA, CJCB, CAAA, CBAA, CBAB, CBAC, CBBA, CBBB, CBDA, CBDB, CBDC, CCHA, CEGA, CJAA, CAAB, CAAC, CFJA, CFWA, CAYB, CAYC, CAYA.

## KIT D'OUTILS POUR AMORTISSEUR DE VIBRATIONS DU GROUPE VAG

54218 142,00€

GASOLINA/PETROL

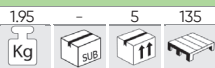

### MARQUES

AUDI, SEAT, SKODA, VOLKSWAGEN

### OUTILS OEM

T10531/1 (1), T10531/2 (2), T10531/3 (3), T10531/4 (4)

### CODES MOTEUR

1.8L TFSI:  
 BZB, CDAA, BPU, BYT, CABA, CABB, CDHA, CDHB, CABD, DAJB, CJSA, CJSB, CJEB, CJEE, CJED, CYGA, CDAC, CJSC, CGYA, DAJA  
 2.0L TFSI:  
 CAWB, CCZA, CBFA, CCTA, CDNB, CDNC, CDND, CJXA, CJXE, CJXH, CHHB, CHHA, CULA, CFKA, DEDA, CHJA, CAWA, CCZC, CCZD, CPSA, CJKA, CJKB, CESA, CETA, CFPA, CNCD, CPLA, CYRB, CYRC, ONCE, CYNB, CYP A, CULB, CULC, CNCB, CWZA, CJXF, CJXC, CJXB, CJXG, CHHC, CCZB

## COFFRET DE CALAGE POUR RENAULT 1.4 / 1.6 / 1.8 / 2.0 16V

53289 45,00€

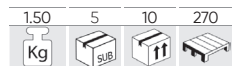

GASOLINA/PETROL

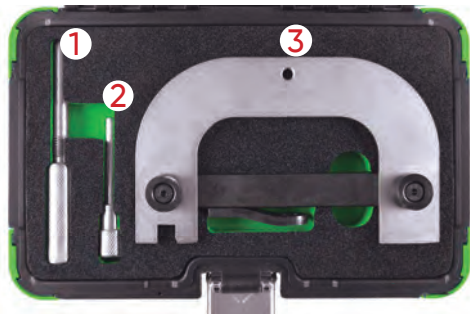

### MARQUES

**RENAULT:** Espace/Grand Espace (98-02), Espace/Grand Espace IV (02-10), Kangoo/Trekka (01-09), Laguna (98-01), Laguna II (01-07), Laguna III (07-13), Megane (99-03), Megane II (02-10), Megane III/Sport (08-13), Megane/Scenic (99-00), Scenic/RX4 (99-03), Scenic/Grand Scenic II (03-09), Trafic II (01-11), Twingo II (08-14), Vel Satis (00-10), Wind (10-14)  
**DACIA:** Logan/MCV (05-11).  
**NISSAN:** Kubistar X76 (03-09), Primastar (02-11).  
**VAUXHALL/OPEL:** Jetta, Touran, Golf, Golf Plus, Polo, Passat, Tiguan, Scirocco.

### OUTILS OEM

Mot1489 (1), Mot1054 (2), Mot1496 (3)

### CODES MOTEUR

**1.4 16v K4J:** 730, 732, 740.  
**1.6 16v K4M:** 752, 753, 760, 761, 764, 788, 812, 813, 854, 856.  
**1.8 16v F4P:** 720, 722, 760, 770, 771, 772, 773, 774, 775.  
**2.0 16v F4R:** 700, 701, 712, 713, 714, 715, 720, 722, 730, 732, 736, 738, 740, 741, 744, 746, 747, 762, 763, 764, 765, 766, 767, 770, 771, 780, 790, 791, 792, 820, 830, 832, 867.  
**2.0 16v F4R(t):** 720, 722, 764, 765, 774, 776, 784, 786, 787, 794, 795, 796, 797, 800, 802, 810, 811, 870, 872, 874, 886, 887, 896, 897.

## COFFRET DE CALAGE POUR RENAULT

53291 68,00€



GASOLINA/PETROL

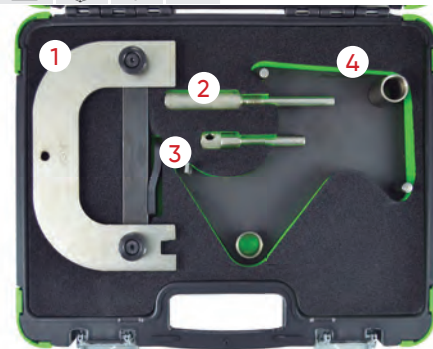

### MARQUES

**RENAULT:** Clio, Laguna, Megane

### OUTILS OEM

MOT1496 (1), MOT1489 (2), MOT861/1863 (3), MOT1490(4)

### CODES MOTEUR

K4J, K4M, F4P, F4R.

## COFFRET DE CALAGE POUR RENAULT / VOLVO 16V / 20V

53290 51,00€

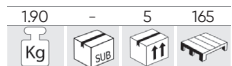

GASOLINA/PETROL

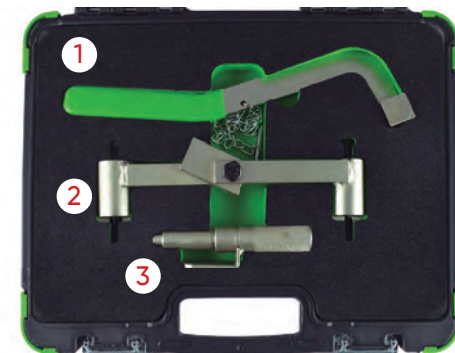

### MARQUES

**RENAULT:** Laguna 2.0 16V / 2.5 20V (1996-1999), Safrane 2.0 16V / 2.5 20V (1996-2001)  
**VOLVO:** 850 (1992-1997), C70 (1998-2002), S40 (1996-2004), V40 (1996-2004), S60 (2001-2005), S70 (1997-2000), S80 (1999-2005).

### OUTILS OEM

MOT1348 (1), MOT1337 (2), MOT1340 (3)

### CODES MOTEUR

**RENAULT:** N7Q 704/710/711(2.0 16V),N7U 700/701(2.5 20V).  
**VOLVO:** B4164S, B4164S2, B4184S, B4184S2, B4184S3, B4184S9, B4184S10, B4194T, B5194T2, B420S4, B4204S2, B4204T, B4204T2, B4204T3, B4204T5, B5202Fs, B5204FT, B5204T2, B5204T3, B5204T4, B5204T5, B5234FS, B5204FT, B5234T3, B5234T4, B5234T5, B5234T6, B5234T7, B5234T8, B5234T9, B5244S, B5244S2, B5244SG, B5244SG2, B5244T, B5244T3, B5244T4, B5244T5, B5244T7.

## KIT DE VERROUILLAGE POUR MOTEUR DIESEL RENAULT / NISSAN 1.6 DCI

53523 91,00€



GASOIL/DIESEL



### MARQUES

**RENAULT:** Espace/Grand Espace IV (06-10), Kaleos (08-11), Laguna II (05-07), Laguna III (07-12), Master III (10-12), Magane II (06-10), Scenic/Grand Scenic II (06-09), Scenic/Grand Scenic III (09-12), Trafic II (06-12), Vel Satis (05-10)  
**NISSAN:** Primastar X83 (06-10), Qashqai/Qashqai+2 J10 (07-10), X-Trail T31 (07-12).  
**VAUXHALL / OPEL:** Movano-B (10-12), Vivaro (06-12).

### OUTILS OEM

MOT1969 (1), MOT1970 (2), MOT1770, MOT1773, EN-48330, EN-48332, EN-48334, EN-48831, KM-6130

### CODES MOTEUR

**M9R 2.0dCi:** 610, 615, 630, 700, 721, 740, 742, 760, 761, 762, 763, 780, 782, 784, 786, 788, 800, 802, 803, 805, 808, 816, 830, 832, 833  
**M9T 2.3dCi:** 670, 672, 676, 678, 680, 686, 690, 692, 694, 698.

# KIT DE BLOCAGE DU VOLANT/DE LA POULIE DU VILEBREQUIN POUR RENAULT, NISSAN

54225 133,00€

GASOLINA/PETROL

2,20	-	5	135
Kg	sub	ft	

<b>MARQUES</b>	<u>Nissan</u> : Primastar (06-15), Qashqai/Qashqai+2 (07-14), X-Trail (07-14), Navara (15-16), NV400 (11-16) <u>Renault</u> : Espace V (15-16), Clio (06-16), Fluence (09-15), Laguna (05-15), Latitude (10-15), Megane (06-15), Scenic/Grand Scenic (06-15), Espace/Grand Espace IV (02-15), Koleos (08-16), Trafic II (07-15), Vel Satis (00-10), Master III (10-16)
<b>OUTILS OEM</b>	MOT 1431(1), MOT 1716(2), MOT 2019(2), MOT 1789(3), MOT 919-02(4)
<b>CODES MOTEUR</b>	1.4: H4J700 1.6: M5M400, M5M450 2.0: M4R700, M4R701, M4R704, M4R711, M4R713, M4R714, 2.0D: M9R726, M9R730, M9R735, M4R737, M9R740, M4R746, M9R742, M9R744, M9R746, M9R748, M4R750, M4R751, M4R752, M4R753, M4R754, M9R610, M9R613, M9S615, M9R630, M9R750, M9R760, M9R761, M9R762, M9R762, M9R763, M9R700, M9R721, M9R722, M9R724, M9R756, M9R780, M9R782, M9R800, M9R802, M9R803, M9R804, M9R805, M9R806, M9R808, M9R809, M9R811, M9R812, M9R814, M9R815, M9R816, M9R817, M9R820, M9R824, M9R828, M9R830, M9R832, M9R833, M9R834, M9R835, M9R836, M9R838, M9R839, M9R844, M9R845, M9R846, M9R849, M9R854, M9R855, M9R856, M9R857, M9R858, M9R859, M9R865, M9R866, M9R784, M9R786, M9R788 2.3D: M9T670, M9T672, M9T676, M9T678, M9T680, M9T686, M9T690, M9T692, M9T694, M9T696, M9T698, M9T700, M9T702, M9T706, M9T708, M9T870, M9T880, M9T890, M9T896, M9T898, M9TC6, YS23DDT, YS23DDTT 2.5: 2TR700, 2TR702, 2TR703, 2TR704, 2TR705, 2ZV604, V4U604, VQ25 3.5: V4Y701, V4Y711, V4Y713, V4Y715



# COFFRET DE CALAGE POUR RENAULT / NISSAN / OPEL / VOLVO

53769 178,00€

GASOLINA/PETROL

GASOIL/DIESEL

5,90	-	3	36
Kg	sub	ft	

<b>MARQUES</b>	<u>RENAULT</u> : Avantime, Clio, Espace, Kangoo, Laguna, Master, Megane, Modus, Scenic, Twingo, Traffic. <u>OPEL</u> /VAUXHALL: Movano, Vivaro. <u>DACIA</u> : Dokker, Duster, Logan, Sandero. <u>NISSAN</u> : Almera, Interstar, Kubistar, Micra, Note, Primera, Qashqai. <u>VOLVO</u> : S40, V40
<b>OUTILS OEM</b>	MOT 1312 (1), MOT 1135-01 (2), MOT 1384 (3), MOT 1340 (4), MOT 1543 / KM-6234 / KV113 B0360 (5), MOT 1489 / KV113 B0130 (6), MOT 1536 / KM-6203 (7), MOT 1489 (8), MOT 1054 / KM-6031 / KV113 / B0280 (10), MOT 1318 (11), MOT 910 (12), MOT 910 (14), MOT 1386 (15), MOT 1534 / KM-6205 (16), MOT 1543 / KM-6234 / KV113 B0360 (17), MOT 1543 / KM-6234 / KV113 B0360 (18), MOT 1543 / KM-6234 / KV113 B0360 (19), MOT 1543 / KM-6234 / KV113 B0360 (20), MOT 1386 (22), MOT 1537 / KM-6204 (23), MOT 1348 (24), MOT 1538 (25), MOT 1337 (26), MOT 1496 / MOT 1750 (27), MOT 1490-01 (28), MOT 1200-01 (29)
<b>CODES MOTEUR</b>	<u>ESSENCE</u> : 2.0 16V, 2.5 20V, 1.4, 1.6 16V, 1.8, 2.0 16V, 1.2, 1.7, 1.8, 2.0 16V, 2.2 <u>DIESEL</u> : 1.9, 2.5, 2.8 D4F702/706/708/712/714/716/722/728/730/740/764, D7F700/701/710/720/722/726/730/744/746/764/766, E7F700/704/706/750, E7J601/624/626/634/635/680/700/706/710/711/716/718/719/720/724/726/728/740/742/745/754/756/757/764/770/771/773/780, F3P670/682/700/704/706/708/710/712/714/720/724/755/758/760, F7P704/722, F3R611/722/723/728/729/750/751/752/791/796/797/798, F5R700/701/740, J7R732/733/734/735/768, F7R710/714, J7T600/760/761/762/766/772/780/782, N7Q704/710/711, N7U700/701, K4J700/710/711/712/713/714/715/730/732/740/750/770/780, K4M700/701/704/706/707/708/709/710/711/712/714/716/718/720/724/730/732/734/736/740/742/743/744/745/746/748/750/752/753/754/760/761/762/764/765/766/768/776/782/788/790/791/794/800/801/802/804/812/813/830, K9K700/702/704/706/710/712/714/716/718/722/724/728/729/732/734/740/750/752/760/762/764/766/768/802/804/806, F9Q610/650/664/670/674/71/716/717/718/720/722/730/731/732/733/734/736/738/740/744/748/750/752/754/758/759/760/768/762/770/772/774/780/782/784/786/788/790/796/800/803/804/808/812/816/818/820, G91600/605/700/702/703/706/707/710/712/720/722/742/743/750, G9U720/724/726/730/750/754, F8M736/760, F8Q600/610/606/620/622/624/630/632/640/644/646/648/662/672/678/680/682/684/692/696/706/714/720/722/730/732/740/742/744/764/768/706/716/784/786/788, J8S620/621/622/758/760/776/778, G8T714/716/740/752/760/790/792/794, S8U720/722/730/731/742/748/750/752/770/772/780/782, S9U700/702/704/714/740, S9W700/702/206/208/212, E5F, E6J, K7M, F4P/F4R, FIN, F2N, F3N, F2R, F3P, F4P, F3R, J5T, J6R, J7R

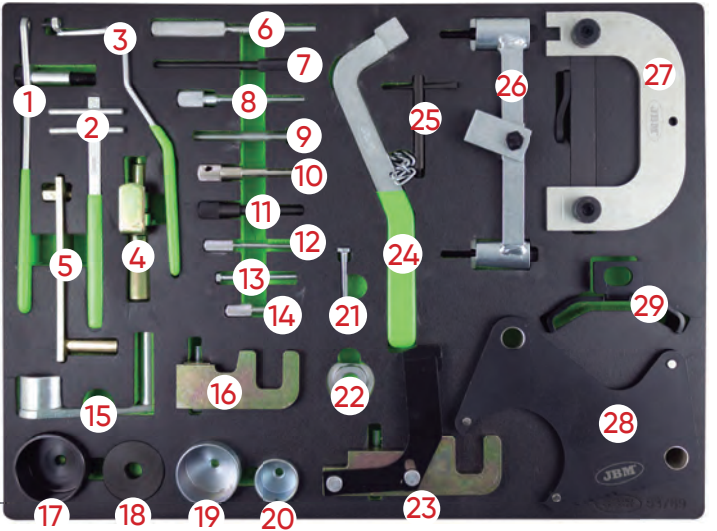

# COFFRET DE CALAGE POUR OPEL 2.2 / 2.5 TDI DCI

53292 116,00€

GASOLINA/PETROL

2,35	-	5	165
Kg	sub	ft	

<b>MARQUES</b>	<u>RENAULT</u> : Laguna II, Espace, Master, Traffic, 2.2 / 2.5 DCI <u>OPEL</u> : Vivaro, Movano, DIESEL: 2.2 / 2.5 DTI, Astra B, Vectra B, Signum, Zafira, 2.2 16V
<b>OUTILS OEM</b>	KM6205 (1), KM6204 (2), KM6077 (3)
<b>CODES MOTEUR</b>	2.2 / 2.5

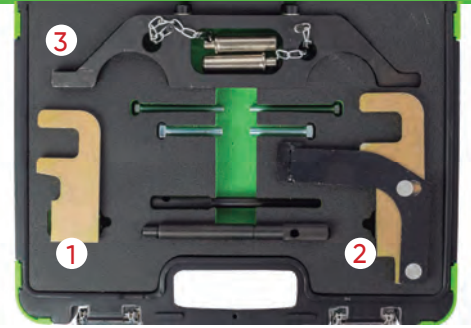

54210 84,00€

GASOLINA/PETROL

1,80	-	5	135
Kg	sub	ft	

<b>MARQUES</b>	<u>Renault</u> Laguna II (2001 - 2009), Megane II (2002 - 2009), Scenic (2002 - 2009)
<b>OUTILS OEM</b>	MOT 1509-01 (1), 1509 (2)
<b>CODES MOTEUR</b>	700, 701, 712, 713, 714, 715, 720, 721, 722, 722, 730, 732, 736, 738, 740, 741, 744, 746, 747, 760, 761, 762, 763, 764, 765, 766, 767, 770, 771, 773, 774, 774, 775, 776, 784, 786, 787, 790, 792, 794, 797, 830, F4P, F4R



# COFFRET DE CALAGE POUR FORD

53293 134,00€

GASOLINA/PETROL

GASOIL/DIESEL

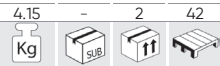

<b>MARQUES</b>	FORD	B-Max (12-17), C-Max (07-17), Cougar (98-01), Courier (00-02), Escort (94-98), Fiesta (95-17), Focus (98-17), Focus C-Max (03-07), Fusion (02-12), Galaxy (06-15), Grand C-Max (10-17), Kuga (08-15), Maverick (01-07), Mondeo (93-15), Orion (94-94), Puma (97-02), S-Max (06-15), Tourneo Connect (02-15), Transit (06-11), Transit Connect (02-16), EcoSport (13-15), Tourneo Courier (14-15), Grand Tourneo Courier (13-15).
<b>OUTILS OEM</b>	303-376 (21-162B) (1), 303-1059 (2), 303-193 (21-104) (3), 303-393-01 (4), 303-1054 (5), 303-1097 (6), 303-748 (7), 303-734 (21-262) (8), 303-651 (21-229) (9), 303-393A (21-168) / 303-393-02 / 303-507 (21-210) / 303-620 (21-163) / 303-732 (21-260) / 303-735 (21-263).	
<b>CODES MOTEUR</b>	<p>ESSENCE: AODA/B, ASDA, ASDB, CFBA, CGBA/B, CHBA/B, CJBA/B, CSDA/B, DHA, DHB, DHC, DHD, DHE, DHF, DHG, EDBB, EDBD, EDDB, EDDC, EDDF, EYDB, EYDC, EYDD, EYDE, EYDF, EYDG, EYDI, EYDJ, EYPA, EYPC, F8JA, F8JB, FHA, FHD, FHE, FHF, FUJA, FUJB, FXDA/C, FXDB/D, FXJA, FXJB, FYDA/C, FYDB/D, FYJA, FYJB, HWDA, HWDB, LIF, LIJ, LIL, LIN, LIQ, LIT, LIV, LIW, M7JA, M7JB, MHA, MHB, NGA, NGB, NGC, NGD, QQDA/B/C, QQDB, RKA, RKB, RKF, RKH, RKJ, RKK, HXDA.</p> <p>DIESEL: F6JA, F6JB, F6JC, HHJA, HHJB, G8DA, HHDA, HHDB, RTN, RTQ, RTP, C9DC, BHDA/B, BHPA, C9DA/B, F9DA/B, FFBA, FFDA, HCPA, HCPB, KKDA, P7PA, P9PA, QYWA, R2PA, R3PA, RWPA, G6DA, G6DB, G6DC, AZWA, QXWA.</p>	

# OUTIL DE BLOCAGE DU PIGNON DE L'ARBRE À CAMES POUR FORD 1.5T

54223 149,00€

GASOIL/DIESEL

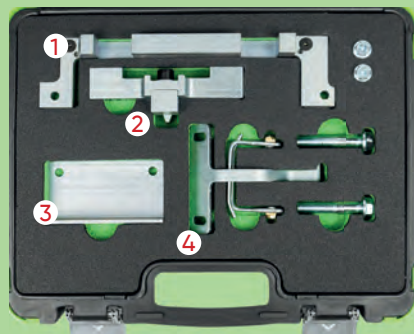

<b>MARQUES</b>	FORD 1,5L Duratec, EcoSport, Fiesta, Focus
<b>OUTILS OEM</b>	303-1639(1), 303-1643(2), 303-1647(3), 303-1648(4)
<b>CODES MOTEUR</b>	2.2 / 2.5

# JEU DE MULTIPLICATEURS DE COUPLE 5:1 DESTINÉ AUX MOTEURS ECOBOOST DE FORD

54260 277,00€

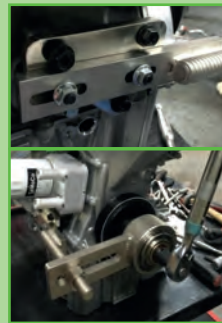

1.0 EcoBoost 2.0 Durator-TDCi  
1.0 Duratec 2.0 EcoBlue Diesel  
2.0 Duratec

# COFFRET DE CALAGE POUR FORD

53653 207,00€

GASOLINA/PETROL

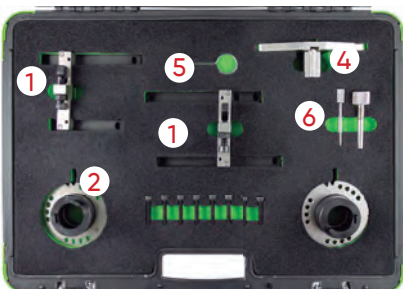
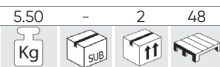

<b>MARQUES</b>	FORD: Fiesta, Focus, B-MAX, EcoSport.
<b>OUTILS OEM</b>	303-1605 (1), 303-1606 (2), 303-1604 (3), 303-1602 / 503-393A / (21-168) (4), 303-1054 (5), 303-732 (6)
<b>CODES MOTEUR</b>	MIDD, MIJA, M1JC, M1JE, M1JHM1JJ, MIDA, M2DA, M2DB, M2DC, SFDBSFJA, SFJB, SFJC, SFJD

# KIT DE CALAGE POUR FIAT, FORD, OPEL, SUZUKI 1.3L

54211 74,00€

GASOIL/DIESEL

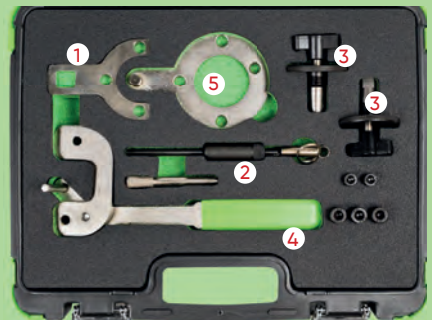

# KIT D'INSTALLATION ET DE DÉMONTAGE DE POMPE À INJECTION POUR FORD 2.0

54224 64,50€

GASOIL/DIESEL

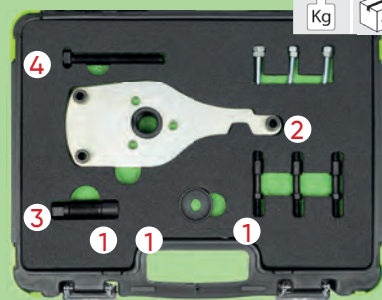
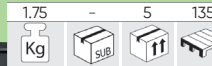

<b>MARQUES</b>	FORD: Transit (17-18), Tourneo Custom (16-18), Transit Custom (16-18)
<b>OUTILS OEM</b>	303-1635(1)/3, 3.3--1635(2)/1, 303-1635(3)/2, 303-1635/6(4)
<b>CODES MOTEUR</b>	YLFS, YMFS, YNFS, YLF6, YMF6, YNF6, YLR6, YMR6 and YNRS.

<b>MARQUES</b>	<p>Fiat: Punto (2003-2007) / Panda (2003-2009) / Idea (2004-2006) / Doblo (2004-2006).</p> <p>Ford: KA.</p> <p>Vauxhall / Opel: Agila (2003-2008) / Corsa C (2003-2007) / Corsa D (2006-2009) / Combo C (2003-2009) / Astra H (2004-2009)</p> <p>Tigra B (2004-2009) / Meriva (2004-2009).</p> <p>Suzuki: Ignis (2003-2009) / Wagon R (2003-2009) / Swift (2003-2010).</p>
<b>OUTILS OEM</b>	1871000200/303-1469/KM-662-C (1), EN 46785 / KM 955/09912-38300 (2), 1871000900/1860985000/303-1472/EN 46781/09917-68610(3), 1870900400 (4), 1870900300 / 303-1468 (5)
<b>CODES MOTEUR</b>	<p>Fiat: 1.3 JTD 188A9000 / 169A.000 / 188A8.000 / 199A3.000.</p> <p>Ford: 1.3 TDCi.</p> <p>Vauxhall / Opel: 1.3 CDTi Z13DT / Z13DTH / Z13DTH.</p> <p>Suzuki: 1.3 CDTi Z13DT.</p>

## COFFRET DE CALAGE POUR FORD 2.0 ECOBLUE

54204 124,00€

2.55 - 5 135  
Kg SUB

GASOIL/DIESEL

<b>MARQUES</b>	Ford Edge, Focus, Galaxy, S-MAX (from 2018); Kuga, Mondeo, Ranger (desde 2019); Transit, Transit Custom and Tourneo Custom (desde 2016); todos con motor EcoBlue TDCi ; AWD, FWD y RWD.
<b>OUTILS OEM</b>	303-1637(1), 303-1650(2), 303-1643(3).
<b>CODES MOTEUR</b>	BCCC,YLCB,YLDA,YLF6,YLFA,YLFB,YLFS,YLR6,YLRA,YM-CB,YMF6,YMFA,YMFB,YM-FS,YMHA,YMRA,YNCA,YNF6,YNFA,YNFB,YNFS,YNR6,YNRA

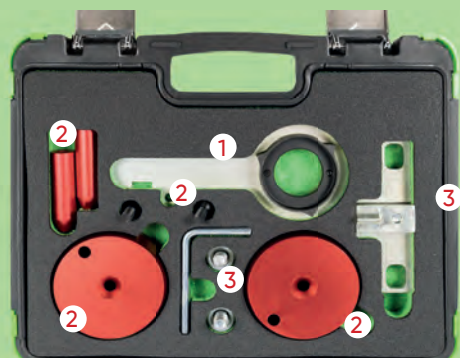

## KIT DE CALAGE POUR FORD

54201 37,60€

1.05 5 10 240  
Kg SUB

GASOLINA/PETROL

<b>MARQUES</b>	Ford: C-MAX(07 - 10), C-MAX/Grand C-MAX(10-18), Fiesta(08-18), Focus/Focus C-MAX(04-11), Focus(11-18), Mondeo(07-15)
<b>OUTILS OEM</b>	303-1097 (1), OEM 303-1054 (2), OEM 303-1059, 303-1270, 0188X, 999-7121 (3), OEM 303-748, 999-7152, 21-259 (4), OEM 303-735, 999 7122, 0187B, 0189B, 0132AJ1, 21-263, 0188M, MOT 1430, 303-1277, 0194B (5)
<b>CODES MOTEUR</b>	11.6.TI-VCT HXDA (2003-2007), 2.0 TDCI , G6DA, G6DB, G6DC 2003-2007

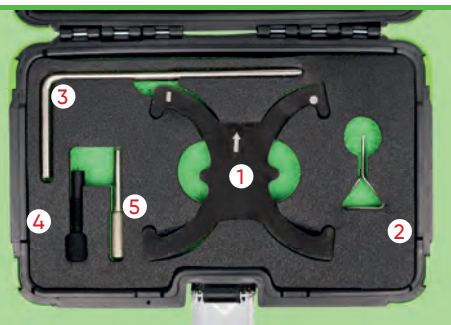

## COFFRET DE CALAGE POUR FORD/MAZDA 2.2, 3.2 TDCI

54209 29,70€

0.85 5 10 240  
Kg SUB

GASOIL/DIESEL

<b>MARQUES</b>	Ford Ranger 3.2L (2011-2016) Ford Ranger 2.2L (2011-2015) Ford Transit 2.2L (2006-2016) Ford Everest 3.2L (2015) Ford Ranger 3.2L (2011)  Mazda BT-50 (2011) Mazda BT-50 3.2L (2011-2016)
<b>OUTILS OEM</b>	303-675/21-234,303-698/21-251 (1), 303-1587(2)
<b>CODES MOTEUR</b>	CYFA,CYFB,DRFA,DRFB,P8FA,P8FB,PGFA,PGFB,QVFA,QWFA,SRFA,SRFB,SRFC,SRFD,SEFE,UHFA,CYFC,DRFC,USRA



## KIT DE CALAGE POUR FORD 2.0 ECO BOOST SCTI& TI-VCT

54208 76,00€

1.95 - 5 135  
Kg SUB

GASOLINA/PETROL

<b>MARQUES</b>	FORD: Galaxy(2010) Mondeo (2010) S Max (2010) Focus(2011)
<b>OUTILS OEM</b>	303-748 (1), 303-1504 (2), 303-1565 (3), 303-1521 (4)
<b>CODES MOTEUR</b>	TNWA, TNWB, TPWA, TNBA, TPBA, MGDA, XQDA

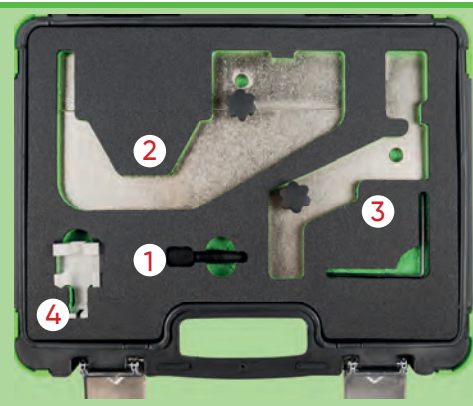

## COFFRET DE CALAGE POUR FORD 1.8TDDI / TDCI

53295 77,00€

GASOIL/DIESEL

2.10 - 5 165  
Kg SUB

<b>MARQUES</b>	C-Max (07-10), Courier (00-02), Fiesta (00-02), Focus (98-11), Focus C-Max (03-07), Galaxy (06-10), Mondeo (07-10), S-Max (06-14), Tourneo Connect (02-13), Transit Connect (02-13).
<b>OUTILS OEM</b>	303-193 (21-104) (1), 303-393 (21-168) (2), 303-376 (21-162B) (3), 303-652 (21-230) (4), 310-095 (23-067) (5)
<b>CODES MOTEUR</b>	1.8D TDCi: BHPA, F9DA, F9DB, FFBA, FFDA, FFWA, HCPA, HCPB, KHBA, KKDA, KKDB, P7PA, P9PA, P9PB, QYBA, QYWA, R2PA, R3PA, RWPA, RWPC. 1.8D TDCi ECOnetic: KHBA. 1.8D Tdi: BHDA, BHDB, BHPA, C9DA, C9DB, C9DC. 1.8D Turbo: C9DC, RTN, RTP, RTQ.





## COFFRET DE CALAGE POUR FORD

53324

12,50€

GASOLINA/PETROL

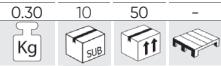

### MARQUES

**FORD:** B-Max (15-17), C-Max (07-10), Cougar (98-01), Fiesta (95-17), Focus (98-11), Focus C-Max (03-07), Fusion (02-12), Galaxy (06-15), Maverick (01-07), Mondeo (93-15), Puma (97-02), S-Max (06-15), Tourneo Connect (02-06), Transit (06-12), Transit Connect (02-06).  
**MAZDA:** 121 ZQ (95-00), 2 DY (02-07), 3 BK (03-09), 3 BL (09-15), 5 CR (05-10), 5 CW (10-12), 6 GG/GY (02-07), 6 GH (07-15), MPV LW (02-05), MX-5 NC (05-16), Tribute EP (04-06).  
**VOLVO:** C30 (06-13), S40 (06-12), S80 (07-11), V50 (04-12).

### OUTILS OEM

**FORD:** 303-1054, 303-507 (21-210), 303-620 (21-163), 303-574, 303-748, 303-376 (21-162B), 303-376B  
**MAZDA:** 49 JE01 061, 303-574, 49 JE02 061, 303-465, 49 JE01 054  
**VOLVO:** 999 7152, 999 7151.

### CODES MOTEUR

1.4 / 1.6

## COFFRET DE CALAGE POUR FORD / MAZDA

53294

119,00€

GASOIL/DIESEL

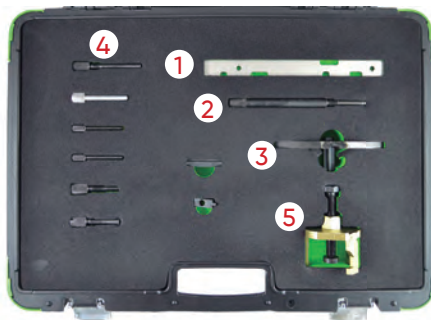
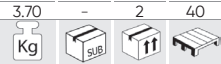

### MARQUES

**FORD:** Courier (00-02), C-Max (03-10), Fiesta (02-11), Focus (98-11), Fusion (02-11), Galaxy (06-10), Kuga (06-10), Mondeo (07-10), S-Max (06-10), Tourneo Connect (02-13), Transit Connect (02-13).  
**PEUGEOT:** Bipper (08-10) Dispatch/Jumpy III (07-12) Expert III (07-12) Nemo (08-10) Partner I/II (05-11) Partner III (08-16) 107 (05-10) 1007 (05-10) 206 (01-12) 206+ (09-13) 206 CC (05-07) 207 (06-13) 207 CC (07-15) 208 (11-15) 307 (01-08) 308 (07-15) 308 CC (09-15) 407 (05-11) 508 (04-15) 2008 (13-15) 3008 (09-15) 4008 (12-15) 5008 (09-15).  
**MAZDA:** 2 (02-15), 3 (09-14).  
**CITROËN:** C1 (05-10), C2 (03-10), C3 I/II (02-10), C3 III (10-15), C3 Pluriel (04-10), C3 Picasso (09-12), C4 (04-11), C4 II (11-15), C4 Picasso (06-12), C4 Grand Picasso (10-12), DS3 (09-12), DS4 (11-12), DS5 (12-15), C5 II (04-08), C5 III (04-12), Xsara II (02-04), Xsara Picasso (04-10).

### OUTILS OEM

**FORD:** 303-376B (1), 303-193 (2), 303-393 (3), 303-732 (4), 303-651 (5), 303-393/01, 303-1059, 303-734, 303-735.  
**MAZDA:** 303-732, 303-734, 303-735.  
**PSA:** 0194-A, 0194-C, 0194-B.

### CODES MOTEUR

**1.4D TDCi/Hdi:** DV4TD(8HT), DV4TD(8HX), DV4TD(8HZ), DV4TD(8HW), DV4TED4(8HX), DV4TED4(8HV), DV4TED4(8HY), DV4C(8HP), DV4C(8HR), DV4TED(8HS), F6JA, F6JB, F6JC.  
**1.6D TDCi/HDi:** DV6TED4(9HZ), DV6ATED4(9HX), DV6TED4(9HY), DV6DTED(9HP), DV6C(9HR), DV6CATED(9HX), DV6C(9HL), DV6TED(9HP), DV6ATED(9HY), DV6TED4(9HV), DV6TED4(9HX), DV6C(9HD), DV6C(BHX), DV6C(BHZ), DV6(9HR), DV6BTED4(9HW), DV6DTED(9HJ), DV6ETED(9HN), DV6TED4BU(9HS), DV6BTED4(9HT), DV6BUTED4(9HT), DV6TED4B(9HV), DV6UTED4(9HX), DV6TED(9HD), DV6UTED4(9HU), DV6D(9HP), DV6TE-D4(9HV), DV6C (9HD), DV6TED4(9HW), DV6AT(9HX), DV6ATED(9HX), DV6CTED(9HC), DV6AUTED4(9HX), DV6TED4B, DV6DTED(9HF), HHJA, HHJB, G8DA, G8DB, HHDA, HHDB, MZ-CD, Y6.  
**1.8D TDCi/HDi:** BHPA, C9DA/B, FFBA, G6DA, G6DB, G6DC, HCPA, HCBP, KKDA, P7PA, P9PA, R2PA, R3PA, RWPA.  
**1.8d:** C9DC, RTN, RTQ.  
**1.8D Tdi:** C9DA/B, C9DC.  
**2.0D TDCi/HDi:** AZWA, G6DA, G6DB, G6DC, RHE(DW10CTED4), QXWA, QXWB.

## KIT DISTRIBUTION POUR POMPE INJECTION DE FORD ET JAGUAR DURATORQ

53296

60,00€

GASOIL/DIESEL

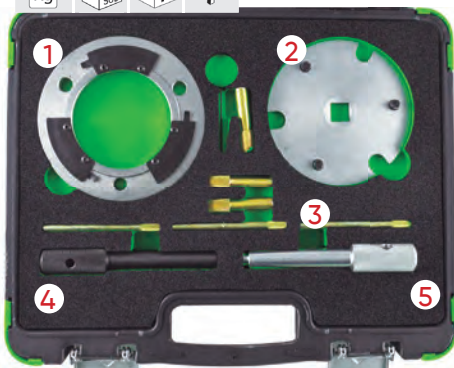

### MARQUES

**FORD:** Mondeo (00-07), Transit (00-14).  
**CITROËN:** Relay, Jumper III (06-13).  
**FIAT:** Ducato (06-11).  
**JAGUAR:** X-Type (03-10).  
**PEUGEOT:** Boxer III (06-12).  
**LAND ROVER:** Defender Td4 (06-11).  
**LDV:** Convoy (02-06).

### OUTILS OEM

303-1151 (1), 303-679A/21-238 (2), 303-732 (3), 303-675/21-234 (4), 303-698/21-251 (5)

### CODES MOTEUR

**12.0D Di/TDci/TDCi:** ABFA, D3FA, F3FA, D5BA, D6BA, F1FA, FMBA, FMBB, HJBA, HJBB, HJBC, HJBE, N7BA, N7BB.  
**2.2D TDCi/ECOnetic:** BG, CYFA, CYFB, CYFC, DRFA, DRFB, DRFC, P8FA, P8FB, PGFA, PGFB, QJBA, QJBA (BG), QJBB, QJBC, QJBD, QVFA, QWFA, SRFA, SRFB, SRFC, SRFD, SRFE, UHFA.  
**2.2D HDi/JTD:** P22DTE (4HM), P22DTE (4HU), P22DTE (4HV).  
**2.4D Di/TDCi:** DOFA, D2FA, D2FB, D4FA, F4FA, FXFA, H9FA, H9FB, H9FD, JXFA, JXFC, PHFA, PHFC.  
**2.4D TD/Tdi:** ZSD 424.  
**2.4D Td4:** 244DT.

## COFFRET DE CALAGE POUR JAGUAR / LAND ROVER

53297

45,00€

GASOIL/DIESEL

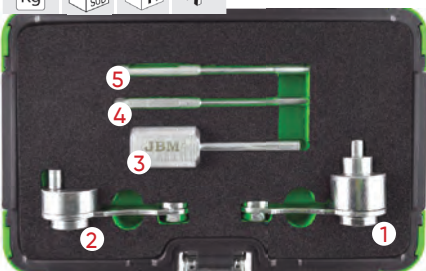

### MARQUES

**JAGUAR:** MS TypeTDVi.  
**LAND ROVER:** Discovery 2.7 TDV6.  
**RANGE ROVER:** Sport 2.7 TDV6.

### OUTILS OEM

303-1117 (1), 303-1116 (2), 303-1132 (3), 303-1126 (4) (5)

### CODES MOTEUR

276DT, 306DT.

## COFFRET DE CALAGE POUR LAND ROVER

53298 91,00€

2,60 - 5 160



GASOIL/DIESEL

### MARQUES

MOTEURS DIESEL: 200 TDI. 300 TDI. 2.5

- Goupille de calage de transmission manuelle EDC.
- 200 TDI. 300 TDI. 2.5 Moteurs diesel.
- Extracteur d'amortisseur à vilebrequin.
- Outil de blocage de pompe d'injection.
- Boulon de synchronisation de la pompe d'injection 200/300 TDI.
- Outil de synchronisation de volant moteur 200/300 TDI.
- Outil de synchronisation de pompe DPS 2.5.
- Outil de synchronisation du volant moteur 2.5.



## COFFRET DE CALAGE POUR OPEL / FORD / FIAT / ALFA ROMEO / LANCIA / SUZUKI

53452 26,50€

0,80 5 10 240



GASOIL/DIESEL

### MARQUES

VAUXHALL/OPEL 1.3 CDTi: Agila, Corsa, Combo (03-08), Astra-H(05-08), Meriva, Tigra-B(04-08)  
SUZUKI 1.3 DDiS: Ignis, Wagon R(03-08), Swift(04-08)  
FORD: 1.3 TDCi  
FIAT/ALFA ROMEO/LANCIA: 1.3 JTD Multijet

### OUTILS OEM

104-A EN 46781 (1), EN 46785 (2)

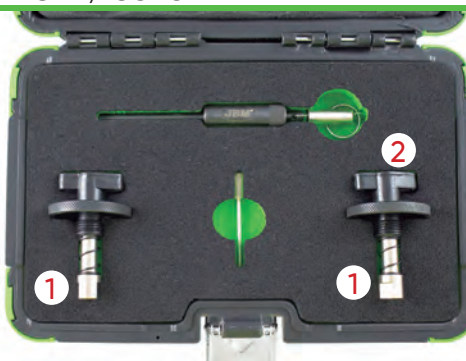

## COFFRET DE CALAGE POUR OPEL / VAUXHALL / CHEVROLET 2.0CDI

53300 41,00€

1,25 - 10 270



GASOIL/DIESEL

### MARQUES

OPEL  
VAUXHALL  
CHEVROLET

### OUTILS OEM

EN-48245 (1), EN-48246 (2),  
205083060 (3) (4) (5) (6)

### CODES MOTEUR

OPEL / VAUXHALL: Z20DM,  
Z20DMH  
CHEVROLET: LLWZ20DMH,  
RA 420, Z20Si, Z 20S3, Z  
20S4, Z 20S5

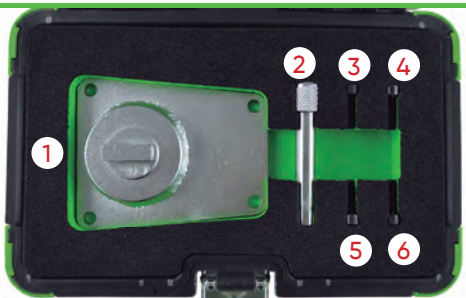

## COFFRET DE CALAGE POUR OPEL / VAUXHALL

53299 291,00€

6,70 - 2 42



GASOIL/DIESEL

### MARQUES

OPEL /  
VAUXHALL

### OUTILS OEM

EN-46788 (1), KM927 (2), EN-46789 (3), KM929 (4), EN-46785 (5), EN-46788 (6), 1 860 985 000 (7), KM932 (8), KM933 (9), EN-49978 (10), KM933 (11)

### CODES MOTEUR

1.3 CDTi 16v, 1.9 CDTi, 2.0 DTi,  
2.2 DTi.



## KIT DE CALAGE POUR FIAT, OPEL, ALFA 1.9, 2.4L 16V

54216 49,00€

1,75 - 5 135



GASOIL/DIESEL

### MARQUES

Opel 1.9, Alfa-Romeo 1.9-2.4 L diesel, Fiat 1.9- 2.4 L diesel

### OUTILS OEM

Opel EN-46788 / Fiat 1.860.905.000 / 1.860.905.010 (1)  
Fiat 1.860.898.000 (2)  
Opel EN-46789 / Fiat 1.870.896.900 (3)  
Opel KM 6130 / KM 6349 (4)

### CODES MOTEUR

Opel 1.9 CDTi Z19DT, Z19DTH, Z19DTJ  
Alfa-Romeo 1.9 y 2.4 L : 323.02, 371.01, 342.02, 325.01, 362.02, 182B9000, 937A2.000, 937A3.000, 192A5.000, 192B1.000, 937A4.000, 937A5.000, 939A2.000, 939A1.000, 939A7.000, 939A8.000, 839A6.000, 841C.000  
Fiat 1.9 y 2.4 L : 182B4.000, 182B9.000, 185A6.000, 186A6.000, 186A8.000, 186A9.000, 188A2.000, 188A7.000, 188B2.000, 192A1.000, 192A3.000, 192A5.000, 192A8.000, 192A9.000, 192B4.000, 192B5.000 198A2.000, 198A3.000, 198A6.000, 199A5.000 223A7.000, 937A5.000, 939A1.000, 939A2.000 939A3.000, 939A7.000

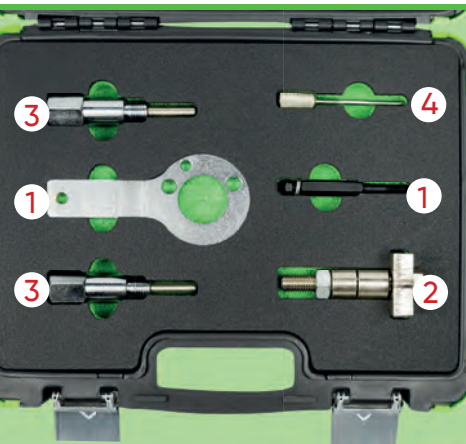

# KIT DE VÉROUILLAGE DE CHAINES POUR OPEL / VAUXHALL 1.0 1.2 1.4 TURBO

53651

91,00€

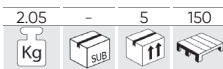

GASOLINA/PETROL

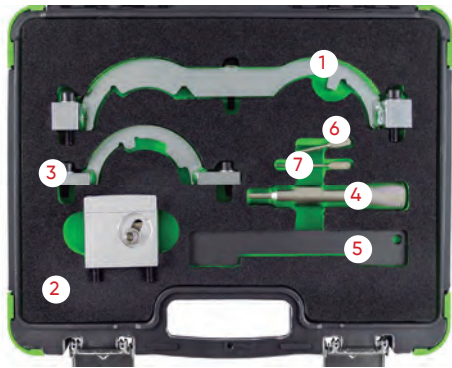

<b>MARQUES</b>	OPEL: Adam, Ampera, Astra-J, Aveo, Corsa-D, Insignia, Meriva-B, Mokka, Zafira-C Tourer
<b>OUTILS OEM</b>	EN 49977-100 (1), EN 49977-200 (2), EN 49978 (3), KM 952 (4), KM 953-A (5), KM 955-1 (6), KM 955-2 (7).
<b>CODES MOTEUR</b>	10: A10XEP (LDB) 12: A12XEL (LWD), A12XER (LDC) 14: A14XEL (L2Z), A14XER (LDD), LDU A14NEL (LUH), A14NET (LUJ), Twinport / ecoFLEX engines A14XFL (LUU), A14NEL (LDD), A14NEL (LUJ), A12XEL (L2Q)

## COFFRET DE CALAGE POUR OPEL 1.0 / 1.2 / 1.4

53301

44,00€

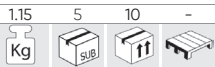

GASOLINA/PETROL

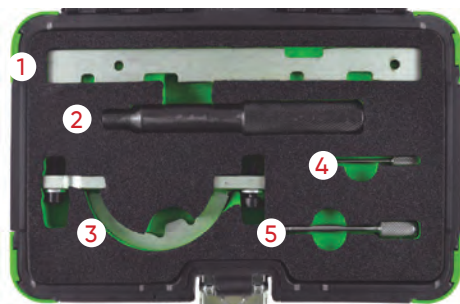

<b>MARQUES</b>	SUZUKI: Wagon R (05-08). VAUXHALL / OPEL: Agila (00-08), Astra-G (98-06), Astra G Classic II (03-10), Astra-H (04-11), Combo (04-12), Corsa-B (97-00), Corsa-C (00-07), Corsa-D (06-12), Meriva-A (04-10), Tigra-B (04-10).
<b>OUTILS OEM</b>	KM-953/09919-58310 (1), KM-952/09912-38310 (2), KM-954/09919-08310 (3), KM-6130 (4), KM-955/09919-58320 (5)
<b>CODES MOTEUR</b>	1.0 12v: X10XE, Z10XE, Z10XEP. 1.2 16v: X12XE, Z12XE, Z12XEP. 1.4 16v/ecoFLEX: Z14XEL, Z14XEP.

## KIT DE CALAGE POUR VAUXHALL, OPEL 1.3 CDTI

54221

111,00€

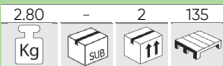

GASOIL/DIESEL



<b>MARQUES</b>	Vauxhall/ Opel 1.3 CDTI Corsa E Diesel Engine From 2015
<b>OUTILS OEM</b>	KM-662-C(1), EN-50515(2), EN-51500(3), EN-46775(4), KM-955-1(5), EN-46785(6)
<b>CODES MOTEUR</b>	LKU B13DTE, LKU B13DTR

## KIT DE CALAGE POUR VAUXHALL, OPEL, SAAB 2.0, 2.2 DTI

54217

104,00€



GASOIL/DIESEL



<b>MARQUES</b>	Vauxhall/Opel: Astra-G (98-06), Frontera-B (98-04), Omega-B, (98-03), Signum (03-05), Sintra (98-99), Vectra-B (97-02), Vectra-C (02-05), Zafira-A (99-05), Saab: 9-3 (98-04), 9-5 (02-06)
<b>OUTILS OEM</b>	Saab: 83 95 394(1), 83 95 337 (2), 83 95 352(3), 83 95 386(4)Vauxhall/Opel/ Saab: KM-927(2), KM-929(3), KM-932 (4), KM-933(1)
<b>CODES MOTEUR</b>	Opel: X20DTH,X20DTL,Y20DTH, Y20DTL, X22DYHY22DTH, Y22DTR Saab: D223L

## COFFRET DE CALAGE POUR FIAT / OPEL

53303

89,00€

GASOIL/DIESEL

1,96	-	5	150
Kg	sub	ff	

**MARQUES** FIAT: 19D/JTD (Motor Peugeot), 2.4D.  
ALFA ROMEO: 145, 146, 156 JTD.  
GM: GM 1.3, 1.6, 1.9, 2.0, 2.4 CDTI (2004 -).

**OUTILS OEM** EN-46789 (1), EN-46789-100 (2), EN-46785 (3), EN-46788 (4), EN-46781 (5), EN-46789 (6)

**CODES MOTEUR** GM: K1.3 CDTI | Z13DT Common Rail engine.  
1.9 CDTi / 04-12 - Z19DT | Z19DTH | Z19DTJ | Z19DTL  
2.0 CDTi / 08-12 - A20DT | LBS / LBX / LBY / LCDV  
SAAB: 1.9 TID.



## COFFRET DE CALAGE POUR OPEL / VAUXHALL ASTRA, VECTRA, ZAFIRA 1.9CDTI

53302

44,00€

GASOIL/DIESEL

1,10	5	10	640
Kg	sub	ff	

**MARQUES** SAAB: 9-3 (04-08), 9-5 (05-08).  
VAUXHALL / OPEL: Astra-H, Vectra-C, Signum (04-07), Zafira-B (05-07).

**OUTILS OEM** EN46789/32 025 008 (1) (3), EN46788/32 025 009 (2), KM6349 (4)

**CODES MOTEUR** Z19DT, Z19DTH, Z19DTL.

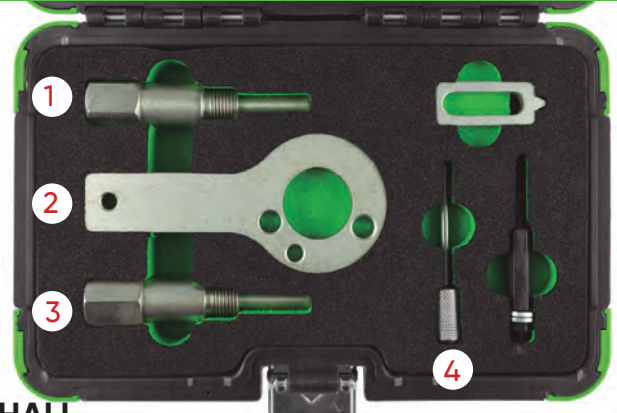

## COFFRET DE CALAGE POUR SAAB / OPEL / VAUXHALL

53305

136,00€

GASOLINA/PETROL

3,60	-	2	42
Kg	sub	ff	

**MARQUES** VAUXHALL / OPEL: Antara (06-10), Calibra (93-98), Cavalier/Vectra-A (93-95), Omega-B (94-03), Signum (03-05), Sintra (96-99), Vectra-B (95-02), Vectra-C (02-05).  
SAAB: 900 (93-98), 9000 (95-97), 9-5 (98-03)

**OUTILS OEM** KM-800-1 (1), KM-800-2 (2), KM-800-20 (3), KM-800-10 (4), 83 95 006 (5), KM-800-30 (6), MKM-6038, 83 95 006 (7)

**CODES MOTEUR** 2,5 V6: Saab; B2581, Vauxhall/Opel; C25XE, X25XE.  
2,6 V6: Vauxhall/Opel; Y26SE.  
3,0 V6: Saab; B308E, B308i, Vauxhall / Opel; X30XE.  
3,2 V6: Vauxhall/Opel; Y32SE, .

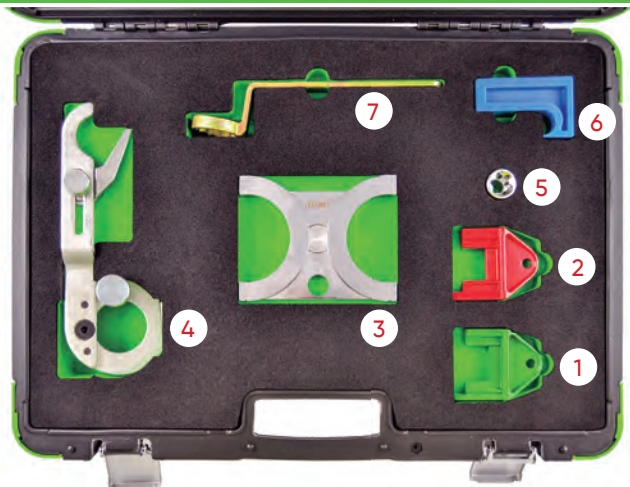

## COFFRET DE CALAGE POUR FIAT

53304

279,00€

GASOLINA/PETROL

6,00	-	2	42
Kg	sub	ff	

GASOIL/DIESEL

**MARQUES** FIAT

**OUTILS OEM** 1 860 874 000 (1), 1 860 895 000 (2), 1 860 898 000 (3), 1 860 905 000 (4), 1 860 845 000 (5)

**CODES MOTEUR** ESSENCE: Fiat Brava, Bravo, Barchetta, Cargo, Coupe, Marea, Palio, Weekend, Punto, Multila, Stilo, Idea, Doblo Twin Cam Engines - 1.2, 1.4, 1.6, 1.8, 16V  
DIESEL: Fiat Brava, Bravo, Marea, Weekend, Palio, Punto, Multipla, Doblo, Ulysse, Ducato, Stilo JTD Diesel Engines - 1.9D/TD, 1.9JTD, 2.4TD/JTD.

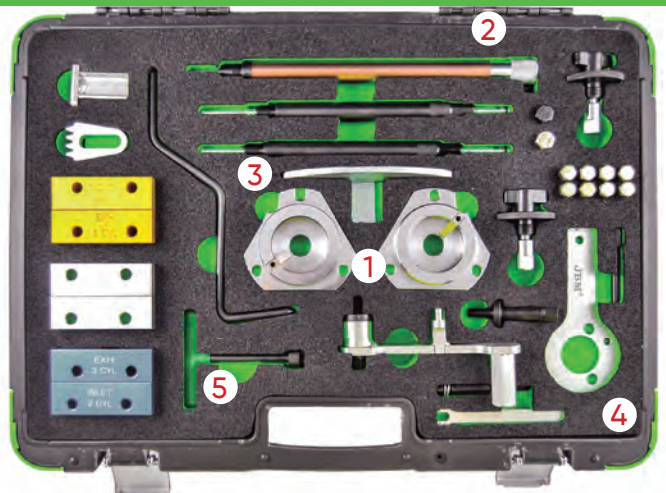

## COFFRET DE CALAGE POUR ALFA / OPEL / VAUXHALL 1.6 / 1.8 16V

53307

38,50€

GASOLINA/PETROL

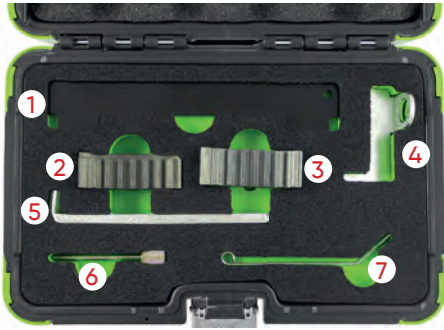
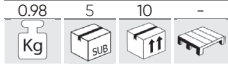

<b>MARQUES</b>	OPEL / VAUXHALL: Corsa-D, Agila, Astra-G-H, Meriva, Zafira-B, Vectra-C, Signum, Insignia	1,6, 1,8
	CHEVROLET: Aveo, Cruze, Orlando	1,4, 1,6, 1,8
	ALFA ROMEO: 159 FIAT: Croma	1,8
<b>OUTILS OEM</b>	E10290 (1), 23056-06 (2) (3), E10230 (4), 23164-04 (5), 23174-01 (6), 23056-05 (7)	
<b>CODES MOTEUR</b>	Opel / Vauxhall: Z16LEL, Z16LER, Z16LET, Z16XE1, Z16XEP, Z16XER, A16XER, 18XER, A18XER, 2HO/A18XEL. Chevrolet: G14D, LDD, LXV (F16D4), 2HO(Z18XER). Alfa / Fiat: 939A4.000.	

## COFFRET DE CALAGE POUR FIAT / OPEL / VAUXHALL 2.2 16V

53316

34,00€

GASOLINA/PETROL

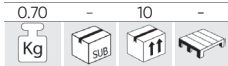

<b>MARQUES</b>	OPEL: Astra-G (2000-2006), Astra-H (2006-2011), Signum (2003-2008), Vectra-B (2000-2002), Vectra-C (2002-2008), Zafira-A (2000-2005), Zafira-B (2005-2012), Speedster (2000-2006). VAUXHALL: VX220 (2000-2006). FIAT: Croma (2005-2009).	
<b>OUTILS OEM</b>	VAUXHALL / OPEL: Z22SE, Z22YH FIAT: 194A1.000.	

## KIT DE CALAGE POUR VAUXHALL/ OPEL 1.6 CDTI

54205

49,00€

GASOIL/DIESEL

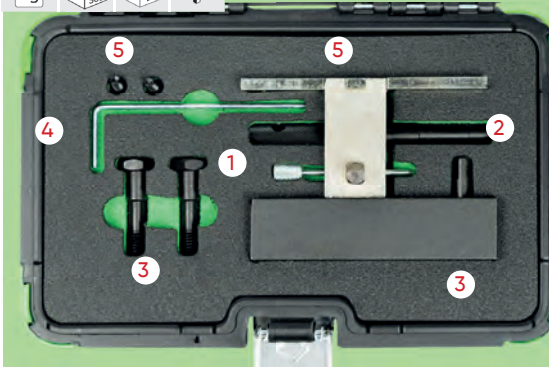
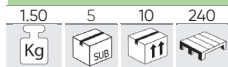

<b>MARQUES</b>	Vauxhall/Opel: Astra J (13-18), Astra K, (15-19), GTC (15-18), Insignia A (15-17), Insignia- B (17-20), Meriva B (13-17), Mokka (14-16), Mokka X (16-20), Zafira C Tourer (13-19).	
<b>OUTILS OEM</b>	EN-6349, EN-6130 (1), EN-51143 (2), EN-51140 (3), EN-50513 (4), EN-51188 (5)	
<b>CODES MOTEUR</b>	B16DTC, B16DTE, B16DTH, B16DTJ, B16DTL, B16DTN, B16DTR and B16DTU. D16DTH, D16DTI, D16DTJ, D16DTN, D16DTR, D16DTU	

## KIT DE CALAGE 1.6D, 1.7D ET ISUZU

54214

96,00€

GASOIL/DIESEL

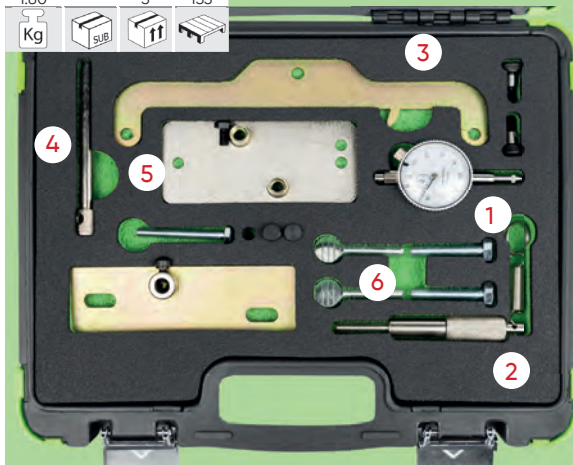

<b>MARQUES</b>	ASTRA, CAVALIES, VECTRA-A(87-00), ISUZU, NOVA, CORSA / COMBO, STRA, CAVALIER, VECTRA, FRONTERA, MONTEREY, MIDI, BRAVA (88-04)	
<b>OUTILS OEM</b>	VAS 6079 (1), KM 951 (2), KM 851 (3), 23-029 (4), KM 661-2 (5), KM 661 (6)	
<b>CODES MOTEUR</b>	OPEL : 16DA, 17D, 17DR, X17DTL ISUZU : 4EC1, 4EE1, 4JB1, 4XJ1, 4JA1, 4JG1, 4FC1, 4FD1, 4FG1, Z17DT, Y17DT/DTL	

## COFFRET DE CALAGE POUR CITROËN / PEUGEOT

53313 139,00€

GASOLINA/PETROL

4,55	-	2	40
Kg	sub	ff	

GASOIL/DIESEL

### MARQUES

CITROËN: AX, BX, Boxer, Berlingo, C25, Dispatch, Evasion, J5, Jumpy, Jumper, Relay, Saxo, Synergie, Visa, XM, Xsara, Xantia, XZ, ZX.  
PEUGEOT: 106, 205, 206, 305, 306, 307, 309, 405, 406, 605, 607, 806, Expert, Partner, Solara, Talbot.

### OUTILS OEM

7099TM (1), 0188X (2), 0188P (3), 0189AZ (4), 0188H (5), 0132AJ1 (6), 0189A (7), 0188PM (8), 21-260 (9), 4527-TS1 (10), M8X70 (11), 0188K (12), 0188J (13), 0132Q (14), 4507-TL (15), 4507-TJ (16), 9044-T (17), 4507-TJ (18), 5711-TA (19), 7014-TJ (20), 7017-TR (21), 0188X (22), 7017-TW (23), 7014-TM (24), 0189L (25)

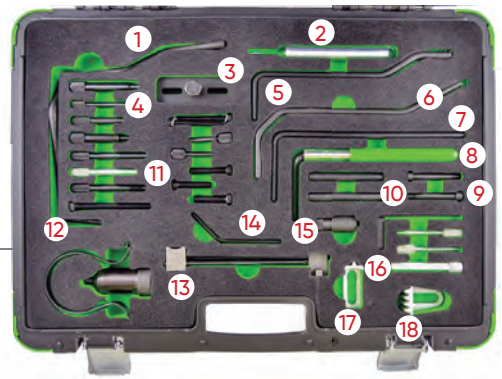

## COFFRET DE CALAGE POUR CITROËN / PEUGEOT 1.8 / 2.0

53314 98,00€

GASOLINA/PETROL

1,85	-	2	-
Kg	sub	ff	

### MARQUES

CITROËN: C4 Picasso/Grand Picasso (06-10), C5 II (04-08), C8 (05-10), Dispatch/Jumpy (07-11), Xsara 2.0 16v, C5 1.8/2.0/HPI, Xsara Picasso 1.8/2.0 16v (02-05)  
PEUGEOT: 406 1.8 16v (00-04), 407 (06-10), 807 2.0 16v (02-05).

### OUTILS OEM

0189S2 (1), 0188J (2), 0188J2 (2), 0189S1 (3), 21-260 (4), 0189B (5), 0188M (6), 0188AH (7), 0189R (8)

### CODES MOTEUR

1.8 16v: EW7A(6FY).  
2.0 16v: EW10A(RFJ), EW10ABE4(RFH), EW10J4S (RFK).



## COFFRET DE CALAGE POUR RENAULT / NISSAN / OPEL / VAUXHALL 2.0 / 2.3 DCI / CDTI M9R / M9T

53311 97,00€

GASOIL/DIESEL

2,55	-	5	135
Kg	sub	ff	

### MARQUES

NISSAN: Primastar X83 (06-15), Qashqai/Qashqai+2 J10 (07-14), X-Trail T31 (07-14).  
VAUXHALL/OPEL: Movano-B (10-17), Vivaro (06-15).  
RENAULT: Espace/Grand Espace IV (06-10), Koleos (08-15), Laguna II (05-07), Laguna III (07-14), Master III (10-15), Megane II (06-10), Scenic/Grand Scenic II (06-09), Scenic/Grand Scenic III (09-15), Trafic II (06-14), Vel Satis (05-10)

### OUTILS OEM

Mot1769 (1), EN-48334 (2), Mot1766 (3), EN-48330 (3), KM-6130 (4), EN-48332 (5), Mot1773 (6), EN-48831 (6)

### CODES MOTEUR

2.0D dCi M9R: 630, 780, 782, 784, 786, 788, 830, 832, 833, 834, 835, 836, 838, 855, 856.  
2.0D CDTI M9R: 630, 780, 782, 784, 786.  
2.3 Bi-CDTI: LP6/M9T706, LW7/M9T706.  
2.3D dCi M9T: 670, 672, 676, 678, 680, 686, 690, 692, 694, 698.



## KIT DE VÉROUILLAGE DE CHAINES POUR CITROËN/PEUGEOT 1.0/1.2 VTI

53876 64,00€

GASOLINA/PETROL

1,80	-	5	120
Kg	sub	ff	

### MARQUES

CITROËN: C3 (III)  
PEUGEOT: 208, 308, 2008 SUV (2012-2014)

### OUTILS OEM

0109-2A (1),  
0109-2B (2)

### CODES MOTEUR

1.0/1.2 VTI.  
EBO, (ZMZ), EB2, (HMZ)

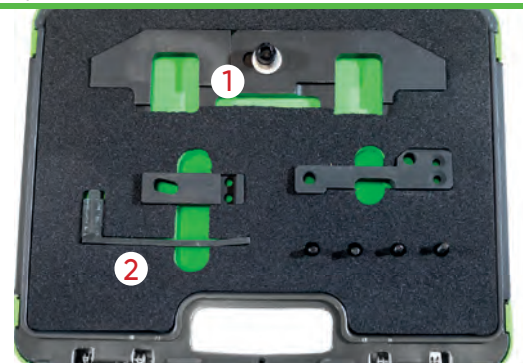

## KIT DE CALAGE POUR ROVER, PEUGEOT, FORD, VOLVO 2.0/ 2.2L D

54213 19,80€

GASOIL/DIESEL

0,40	6	24	240
Kg	sub	ff	

### MARQUES

Peugeot: 807 (05-11), 407 (05-11), 607 (05-09). Citroën: C4 (04-10), C5 II (04-10). Land Rover: Freelander (06-10), Volvo: S40 (03-10), V50 (06-10), C70 (06-10), S80 (07-10), C30 (906-10), V70 (07-10). Ford: S Max 2.2 (08-10), Galaxy 2.2 (08-10), Mondeo 2.2, 2.0 (07-10).

### OUTILS OEM

PSA 0188.M, Ford 303-735, 303-1277, Volvo 999-7122 (1)  
PSA 0188.X, Ford 303-1059, 303-1270, Volvo 999-7121 (2)  
PSA 0188.F, Ford 303-393A, 303-393-01, 303-1272, Volvo 999-7119/7120 (3)

### CODES MOTEUR

PEUGEOT: DW10UTED4 (RHK), DW10BTED4 (RHR)DW12BTED4 (4HS), (4HP), (4HT), (4HR).  
Citroën: DW10BTED4 (RHR). LAND ROVER: DW12BTED4, 224DT. Volvo: D420T 2.0D. FORD: QXBA(2.2), QXWA(2.0), QXWB(2.0), Q4BA(2.2), QXWA(2.0), QXWB(2.0), AZBA(2.0), AZBC(2.0), AZWA(2.0)

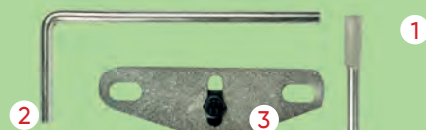

## COFFRET DE CALAGE POUR FIAT / ALFA / LANCIA



<b>MARQUES</b>	ALFA FIAT LANCIA	Alla, Barchetta, Bravo, Brava, Coupe, Delta, Dedra, Punto, Spider, GT
<b>OUTILS OEM</b>	1860845000 (1), 1822154000 (2), 1860905000 (3), 1860992000 (4), 1860895000 (5), 1860874000 (6), 1860985000 (7), KM571A (8), 1 860 896 000 (9), 0153A (10)	
<b>CODES MOTEUR</b>	1.2 / 16V, 1.4 / 12V, 1.6 / 16V, 1.6 eco, 1.8, 2.0 / 16V, 2.0 / 20V, 2.4 / 20V, 3.0 / V6.	

## COFFRET DE CALAGE POUR FIAT/ALFA/LANCIA 1.2 16V, 1.4 16V, T-JET



<b>MARQUES</b>	<b>Alfa Romeo:</b> Giulietta (10-14), MiTo (08-17). <b>Fiat:</b> 500 (07-19), 500L (12-19), 500C (07-19), 500 Abarth (08-17), Bravo (07-14), Brava/Bravo (98-02), Doblo/Doblo Cargo (10-19), Egea (15-20), Grande Punto (07-10), Grande Punto Abarth (07-10), Idea (04-12), Linea (07-10), Marea/Weekend (98-00), Palio Weekend (01-06), Panda (07-11), Punto (97-08), Stilo (01-08), Tipo (15-20). <b>Lancia:</b> Delta (08-12), Musa (04-13), Ypsilon (96-11).	
<b>OUTILS OEM</b>	2.000.004.500 (1), 1.860.985.000 (2), 1.860.992.000 (3), 1.860.987.000 (4), 2.000.015.800 (5)	
<b>CODES MOTEUR</b>	1.2 16v:176B9.000, 182B2.000, 188A5.000. 1.4 16v / T-Jet: 169A3.000, 192B2.000, 198A1.000, 198A4.000, 199A6.000, 198A8.000, 312A1.000, 312A3.000, 843A1.000, 955A1.000.	

## COFFRET DE CALAGE POUR FIAT / ALFA / FORD



<b>MARQUES</b>	<b>FIAT:</b> New 500 (07-09), Idea (04-09), Linea (07-09), Grande Punto (07-09), Doblo 1 Cargo (05-09), Panda EV02 (05) <b>FORD:</b> KA 1.2 Duratec (09) <b>ALFA ROMEO</b>	
<b>OUTILS OEM</b>	1 860 987 000 (1), 2 000 004 400 (2), 2 000 015 800 (3), 2 000 004 300 (4), 2 000 004 500 (5)	
<b>CODES MOTEUR</b>	1.2: 169A4.000 / 199A4.000. 1.4: 350A 1.000 / 188A4.000-EV02.	

## KIT DE CALAGE POUR ALFA ROMEO, LANCIA 1.75 TBI



<b>MARQUES</b>	Alfa Romeo: 159(09-12), Brera(09-11), Giulietta(10-19), Spider(09-11), 4C(13-19). Lancia: Delta(09-14).	
<b>OUTILS OEM</b>	2 000033500 (1), 2000 003000 (2), 1860898 000 (3).	
<b>CODES MOTEUR</b>	Alfa Romeo 1,75 Tbi: 939B1.000, 940A1.000, 940B2.000, 960A1.000 Lancia 1,75 DI Turbo Jet: 939B1.000	

## COFFRET DE CALAGE POUR FIAT 1.2 16V

53306

53,00€

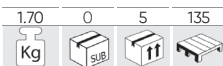

GASOLINA/PETROL

**MARQUES** FIAT: Fiat 1.2L 16v, Fiat Punto / Brava / Bravo / Stilo

**OUTILS OEM** 1860992000 (1), 1871000900 (3), 1860987000 (4), 186985000 (5)

**CODES MOTEUR** 176 B9.000, 182 B2.000, 188 A5.000



## COFFRET DE CALAGE POUR FIAT / IVECO 2.3 / 3.0 JTD

53319

18,00€



GASOIL/DIESEL

**MARQUES** FIAT: 2.3 / 3.0 JTD.  
IVECO: Daily.

**OUTILS OEM** 99360614, 1 860 617 000, 99360615, 2 000 018 200.

**CODES MOTEUR** F1AE0481C, F1AE0481D, F1AE0481N, F1CE0481A/D.

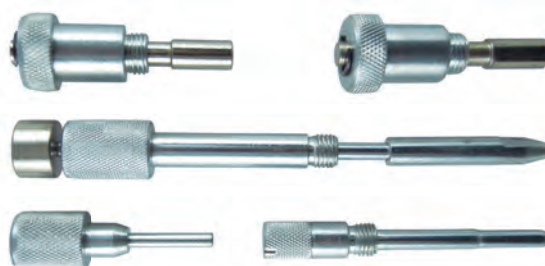

## KIT DE VERROUILLAGE DE CHAINES POUR ALFA / FIAT / LANCIA 1.4 / 1.6 / 1.8 / 2.0 16V

53309

285,00€



GASOLINA/PETROL

**MARQUES**

ALFA ROMEO: 145,146,147,155,156, 1.4 1.6 1.8 2.0 TS, 1.4/1.6 16v; 145/146/147/155/156 (96-10), 1.8 16v; 145/146, (96-01), 155/156 (96-06), Spider/GTV (98-05), 2.0 16v; 145/146 (96-01), 147 (01-10), 155/156 (95-02), 166 (98-07), Spider/GTV (96-05), Purpur: 1.4, 1.6 // Blau: 1.8, 2.0  
FIAT: Barchetta (96-00), Brava (95-00), Bravo (95-00), Coupe (96-01), Marea (96-00), Marea Weekend (96-00), Punto/Punto Classic (99-06), Stilo (01-08)  
LANCIA: Dedra (95-99), Delta (96-99), Kappa (98-02), Lybra (99-06).

**CODES MOTEUR**

1.4 16v: 335.03  
1.6 16v: 321.02, 321.03, 321.04, 372.03, 676.01  
1.8 16v: 322.01, 322.05, 671.06, 182A2.000, 183A1.000, 183A6.000, 188A6.000, 192A4.000  
2.0 16v: 162.01, 323.01, 323.1, 341.03, 363.01, 672.04  
2.0 20v: 175A3.000, 182A1.000, 182B7.000, 185A8.000.



## KIT DE CALAGE POUR FIAT, LANCIA 1,4 12V

54212

39,40€

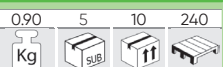

GASOLINA/PETROL

**MARQUES**

Marea/Marea Weekend(96-20), Brava(95-98), Bravo(95-98).  
Lancia: Ypsilon(96-20)

**OUTILS OEM**

1860899000 (1), 1860901000 (2)

**CODES MOTEUR**

1.4 12v : 182A3.000, 182A5.000.

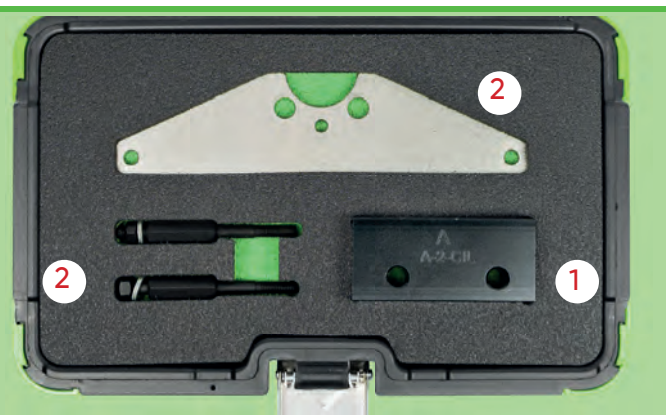



## COFFRET DE CALAGE POUR ALFA ROMEO

53308

55,00€

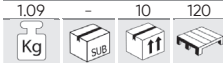

GASOLINA/PETROL

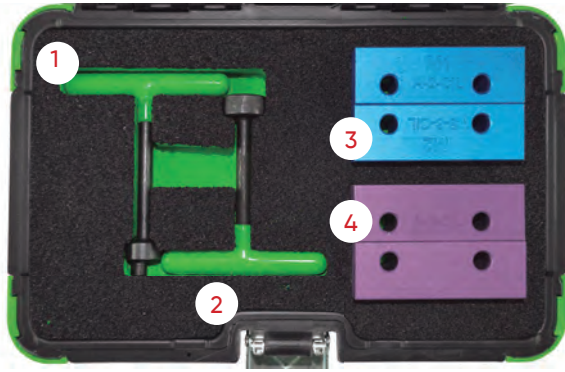

<b>MARQUES</b>	ALFA ROMEO: 145,146,147,155,156, 1.4 1.6 1.8 2.0 TS, 1.4/1.6 16V; 145/146/147/155/156 (96-10), 1.8 16V; 145/146, (96-01), 155/156 (96-06), Spider/GTV (98-05), 2.0 16V; 145/146 (96-01), 147 (01-10), 155/156 (95-02), 166 (98-07), Spider/GTV (96-05), Pùrpura / Purple: 1.4, 1.6 // Azul / Blue: 1.8, 2.0
<b>OUTILS OEM</b>	1822149000 (1), 1822154000 (2), 1825041000 (3), 1825042000 (4)
<b>CODES MOTEUR</b>	Z1.4/1.6-321.02, 321.03, 321.04, 335.03, 676.01 1.8/2.0-323.01, 672.04, 162.01, 323.10, 671.06, 322.01, 671.02, 322.05, 341.03, 363.01.

## COFFRET DE CALAGE POUR ALFA ROMEO FIAT 1.4 MULTIAIR

54215

57,00€

GASOLINA/PETROL

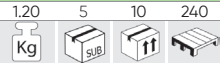

<b>MARQUES</b>	Alfa Romeo Giulietta, Mito / Fiat Punto, Punto Evo 1.4 (Turbo) MultiAir (105/135/163/170PS)
<b>OUTILS OEM</b>	Alfa Romeo / Fiat: 1860987000 (1), 2000034400 (2), 2000004500 (3)
<b>CODES MOTEUR</b>	940A2.000 / 940A2.000 / 955A8.000 / 955A8.000 / 940A2.000 / 955A8.000 / 955A2.000 / 955A7.000 / 955A6.000 / 955A8.000

## KIT DE VÉROUILLAGE DE CHAINES POUR FIAT / ALFA / LANCIA / OPEL / SUZUKI / FORD

53773

298,00€

GASOLINA/PETROL

GASOIL/DIESEL

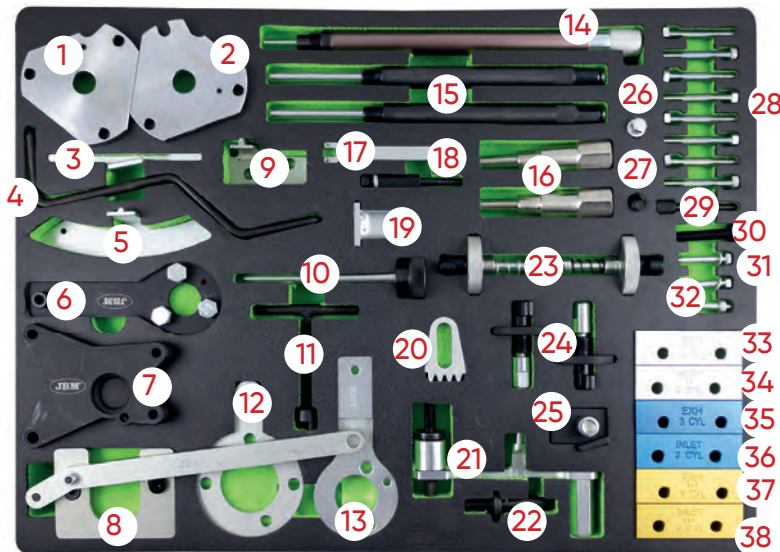

<b>MARQUES</b>	ALFA: Romeo 145, 146, 147, 155, 156, 159, 166, Spider, GTV, TS, GT, Crosswagon Q4 FIAT: Punto, Grande Punto, Brava, Bravo, Marea, Weekend, Stilo, Doblo, Cargo, Idea, Panda, Multipla, Palio, Stilo, 500 LANCIA: Lybra, Ypsilon, Thesis, Musa OPEL: Corsa, Agila, Meriva, Combo, Vectra, Zara, Astra, Insignia, Signum 1.9 CDTI SUZUKI: Ignis, Swift, Wagon R+ FORD: Ka
<b>OUTILS OEM</b>	1860874000 (1), 1860874000 (2), 20000004400 / 2190754400 (3), 1860863000 (4), 1860898000 (5), 2190754500 (6), 20000004300 (7), 18709000400 (8), 1860703000 (9), 1860933000 (10), 1860845000 (11), 1870900300 (12), 1860905000 / EN-46788 (13), 1895443000 (14), 1860992000 (15), 1870896900 (16), 1860987000 (17), 1860905000 (18), 1860771000 (19), 1860161000 (20), 1860876000 (21), 1860876000 (22), 1871000900 (23), 1860985000 (24), 20000004200 / 2190754200 (25), 1860965000 (29)

**CODES MOTEUR**

176B9.000, 182B2.000, 188A5.000, 843A1.000,323.02, 371.01, 182B4.000, 182B9.000, 186A6.000, 188A2.000, 188A7.000, 188B2.000, 192A1.000, 192A3.000, 937A2.000, 939A1.000, 192A5.000, 192B1.000, 198A5.000, 937A5.000, 939A2.000, 325.01, 342.02, 362.02, 185A6.000, 841C.000, 841G.000, 939A3.000, 940A3.000, 940A4.000, 940A5.000, Z19DT/DTH/DTR/DTJ/DTL, 169A1.000, 955A4.000, 350A3.000, 192B4.000, 198A2.000, 350A2.000, 955A3.000, 192A8.000, 198A6.000, 198A3.000, 199B1.000, 199B2.000, 199A2.000, 199A3.000, 199A9.000, 188A3.000, 188A8.000, 188A9.000, 192A9.000, 186A8.000, 186A9.000, 199A5.000, 223A7.000, 223A9.000, 841H.000, 841P.000, 185A2.000, Z13DT, Z13DTJ, Z13DTH, 182A4.000, 182A6.000, 182B6.000, 178B3.000, 186A3.000, 186A4.000, 350A1.000, 169A4.000, 188A4.000, 199A4.000, 199A7.000

# KIT DE VÉROUILLAGE DE CHAINES POUR FORD / SEAT / VOLKSWAGEN / MAZDA / VOLVO

53770 198,00€

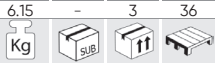

GASOLINA/PETROL

GASOIL/DIESEL

<b>MARQUES</b>	FORD: Fiesta, Fusion, Courier, Escort, Focus, Focus C Max, Puma, Mondeo, Sierra, Cougar, Galaxy, C-Max, Orion, Tourneo Connect, Transit, Transit Connect. VW: Sharan. SEAT: Alhambra. MAZDA: 121. VOLVO: S40, V50.
<b>OUTILS OEM</b>	303-1061 (1), 303-1054 (2), 23-059 / 310-085 (3), 21-105 (4), 323-029 (6), 0194-B / 21-263 / 303-735 / 49 JE 02 021 (7), 0132-AB / 0178-D / 21-151 (9), 0194-C, 21-262, 303-734, 49 JE 02 020 (10), 21-238 / 303-679A / 303-1151 (11), 21-238 / 303-679A / 303-1151 (12), 303-1054 (13), 303-1151 (14), 21-238 / 303-679A (15), 303-393 / 303-393-02 (16), 303-1097 (17), 21-168 / 303-393 (18), 303-0985 (20), 2064 / 23-047 / 310-055 / U20003 (21), 303-652 (22), 21-229, 303-651 (23), 303-748 (24), 21-210 (25), 21-260, 303-732 (26), 21-163, 303-620 (27), 21-234 / 21-251 (28), 303-675 / 303-698 (29), 21-104 / 303-193 (30) / 21-162B / 303-367 / 303-376 (31), 21-162B / 303-376 / 303-376B (32), 23-019 (33), 23-058 / 310-084 (34), 0153-M / 0178-C / 0178-D (35), 0178-B / 5711-TB (36), 21-123 (37), 23-020 (38), 21-234 / 21-251 (39), 303-1059 (40), 23-019 (41), 303-1060 (42), 303-393 / 303-393-01 (43)
<b>CODES MOTEUR</b>	FUJA, FUJB, FXJA, FXJB, FXJB, FYJA, FYJB, F8JA, F8JB, M7JA, M7JB, DHA, DHB, DHC, DHD, DHE, DHF, DHG, FHA, FHE, LIT, LIV, LIE, LIG, LIH, LIK, RDA, RDB, RKC, RQB, RQC, FXDA/C, FXDB/D, FYDA/C, FYDB/D, FYDH, HWDAIZ, AHU, AVG, AFN, D24, D24T, D24TIC, RFN, RTJ, RTK, RVA, RFK, RKD, B4164S3, DV4TD (8HW/8HX/8HZ), DV4TED4 (8HV/8HY), DV6ATED4 (9HX/9HY/9HZ) F6JA, F6JB, F6JC, G8DA, G8DB, KKDA, SNJA, SNJB, STJA, STJB, ASDA, ASDB, FXJC, SPJA, SPJC, FYJC, HWDA, HWDB, SHDA, SHDB, SHDC, JQDA, LQDB, JTDA, JTDB, HXDA, HXJA, HXJB, IQDA/B, IQDB, PNBA, PNDA, RHBA, SIDA, F6JD, TZJA, TZJB, HHDA, HHDB, HHJA, HHJC, HHJD, HHJE, HHJF, RTA, RTB, RTC, RTD, RTG, RTE, RTF, RTH, RTJ, RTK, RFN, BHPA, HCPA, HCPB, KKDA, P7PA, P9PA, P9PB, R2PA, R3PA, RWPA, RWPC, F9DA/B, FFBA, FFWA, KHBA, QYBA, QYWA, KKDB, C9DC, RVA, IZ, AFN, AHU, ANU, AUJ, G6DA, G6DB, G6DC, G6DD, G6DE, G6DF, G6DG, UFDB, TXDB, TYDA, UKDB, QXBA, AZBA, KLBA, QXBB, LPBA, AZBC, TYBA, UKBA, UFBA, TXBA, IXDA, QXWA, QXWB, AZWA, KLWA, AZWC, TYWA, UKWA, TXWA, UFWA, UFDA, TXDA, UKDA, Q4BA, KNBA, 4BA, 4BB, 4BC, 4CC, 4FA, 4CA, 4CB, 4DC, 4EA, 4FA, 4FB, 4FC, 4FD, 4GA, 4GB, 4HC, 4HB, 4HC, 4EB, 4EC, 4ED 4GA, 4GB, 4GC, 4GD, 4GE, 4GF, 4HA, 4HD, FMBA/B, D5BA, ABFA, D3FA, D6BA, HJBA/B, F3FA, D2FA, D4FA, F4FA, F5FA, DOFA, QJBA, QJBB, QJBC, QJBD, FXFA, H9FA, H9FB, N7BA, N7BB, MZ-CD 1.6, Y6

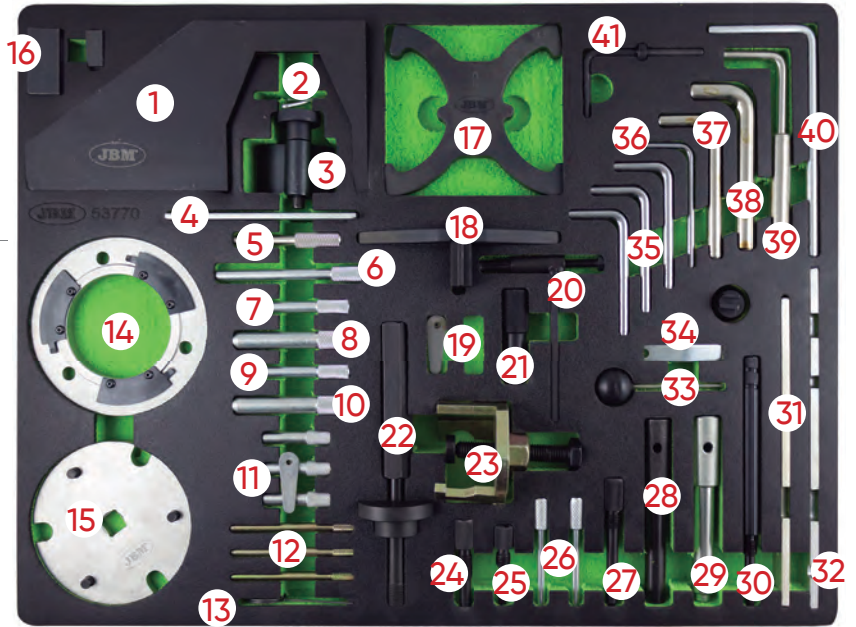

# KIT DE VÉROUILLAGE DE CHAINES POUR OPEL / CHEVROLET / SAAB / FIAT / LANCIA / SUZUKI / FORD

53774 190,00€



GASOLINA/PETROL

GASOIL/DIESEL

<b>MARQUES</b>	ALFA: 145, 146, 147, 156, 159, 166, GT, Crosswagon Q4 FIAT: Punto, Grande Punto, Bravo, Marea Weekend, Stilo, Doblo, Cargo, Multipla Idea, Panda LANCIA: Ypsilon, Musa, Lybra, Thesis OPEL: Corsa B/C, Combo, Tigra, Agila, Tigra B, Meriva, Astra F/G/H, Astravan, Speedster VX220, Zafira A/B, Vectra B/C, Signum, Omega B, Sintra, Frontera A/B, Astravan, Kadett, Ascona, Omega, Monterey, Antara, Cromax, Speedster VX220 SUZUKI: Ignis, Swift, Wagon R+ FORD: Ka CHEVROLET & DAEWOO: Epica, Captiva, Nubira, Lacetti, Evanda SAAB: 9-3, 9-5 (98-04)
<b>OUTILS OEM</b>	1860905000 / 1860905010 / EN-46788 (1), KM-6148 (2), KM-6148 (3), 1870900400 / 1871000200 (4), KM-954 (5), KM-J-43651 (6), 1860905000 / 1860905010 / EN-46788 (7), KM-852 (8), KM-853 (9), 1870900300 / 303-1468 (10), EN-46785 / KM-951 (11), KM-932 (12), 1860703000 (13), KM-955 (14), KM-6130 / KM-6349 / KM-6349 (15), KM-927 (16), EN-48245 (17), KM-933 (18), EN-46785 (19), 1860985000 / 1871000900 / EN-46781 (20), 1860985000 / 1871000900 / EN-46781 (21), EN-48246 (22), KM-929 (23), 1870896900 / EN-46789 (24), KM-952 (25), 21-162B / 303-376 / 303-376B (26), KM-933 (27)
<b>CODES MOTEUR</b>	X14XE, Z14XE, X16SEJ, X16XE, X16XEL, Y16XE, Z16XE, Z16YNG, C18XEL, X18XE, X18XE1, Z18XE, Z18XEL, C20SEL, C20XE, X20XEV, Z20LEH, Z20LEL, Z20LER, Z20LET, Z22SE, X22XE, Y22SE, Y22XE, Z22XE, D223L, X10XE, Z10XE, Z10XEP, X12XE, Z12XE, Z14XEP, X20DTL, X20DTH, X22DTH, Y20DTL, Y20DTH, Y22DTH, Y22DTR, 169A1.000, 955A4.000, 350A3.000, 192B4.000, 198A2.000, 350A2.000, 955A3.000, 192A8.000, 198A6.000, 198A3.000, 199B1.000, 199B2.000, 199A2.000, 199A3.000, 199A9.000, 940A3.000, 188A3.000, 939A2.000, 188B2.000, 188A8.000, 188A9.000, 323.02, 371.01, 937A2.000, 182B4.000, 182B9.000, 188A2.000, 188A7.000, 192A9.000, 186A6.000, 186A8.000, 192A1.000, 192A3.000, 192A5.000, 192A5.000, 186A9.000, 939A1.000, 199A5.000, 223A7.000, 223A9.000, 342.02, 362.02, 841G.000, 841H.000, 841P.000, 939A3.000, 185A2.000, 185A6.000, Z13DT, Z13DTJ, Z13DTH, Z19DT, Z19DTH, Z19DTJ, Z19DTL, X10XE, Z10XE, Z10XEP, Z12XE, Z14XEP, X16SZR, Z16SE, 4EC1/T, 4EC1, 4EE1/T, 4EE1, X17DT, Y17DT, Y17DTI, Y17DTL, 16DA, 17D, 17DR/X, 7DTL, X17DTL, 4JX1/4, JG2T, 4FC1/T, 4FD1, X20DTL, Y20DTL, D223L Z20DMH, Z20DM, RA420, Z20S1, 194A1.000, Z22SE, Z22YH

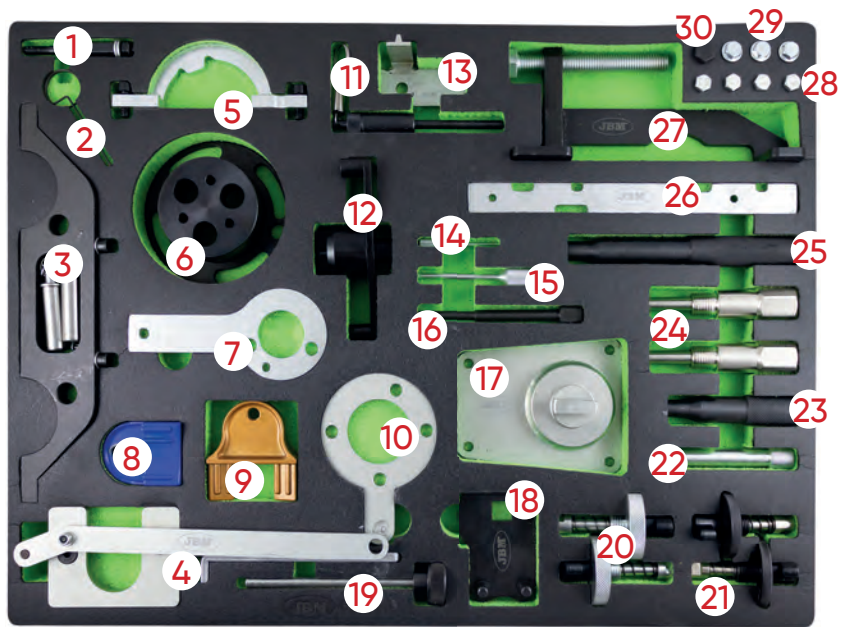

# KIT DE VÉROUILLAGE DE CHAINES POUR FIAT / FORD / CITROËN / PEUGEOT

53771 158,00€



GASOLINA/PETROL

GASOIL/DIESEL

<b>MARQUES</b>	<p><b>FIAT:</b> Ulysse, Scudo, Ducato  <b>LANCIA:</b> Zeta, Phedra  <b>FORD:</b> Fiesta, Fusion, Focus, Focus C-Max  <b>CITROËN:</b> C15, C1, C2, C3 Pluriel, C4, C4 Picasso, C5, C6, C8, DS3, DS4, DS5, Xantia, Xsara, Xsara Picasso, Evasion, Berlingo, Jumpy, Jumper, Saxo, ZX, XM, Evasion, AX  <b>PEUGEOT:</b> 107, 1007, 206 cc, 207, 208, 306, 307 cc, 308, 406, 407, 508, 607, 806, 807, Partner, Expert, Boxer, 206, 106, 605, 205, 405</p>
<b>OUTILS OEM</b>	<p>4200-TH (1), 0117-AR (2), 0188-X (3), 0606-A1A2 (4), 0188-Q2 (5), 0189-S1 (6), 7017-TR (7), 0132-P / 4507-TL (8), 0189-C (9), 0188-J1 (10), 0188-J2 (11), 0178-E (12), 0189-R (13), 0132-AK / 0188-AK / 0189-K / 0153-AK / 4533-TAD / MOT 1436 (14), 0188-AH (15), 0189-S2 (16), 0153-AB / 9041-TZ (17), 0153-M / 0178-C / 0178-D / 7014-TM / 9767-94 (18), 0189-A (19), 4527-TS1 (20), 0153-AB / 9041-TZ (21), 0189-B / 21-163 (22), 0132-AJ1 / 0153-G / 0188-M / 0189-J / 4533-TAC1 / 5711-TA (24), 0189-L (25), 0188-D / 7017-TM (26), 0132-X / 0188-Q1 / 4507-TJ / 9767-89 (27), 0194-B (28), 0132-AB / 0194-A (29), 0194-C / 21-262 / 303-734 (30), 4527-TS2 (31), 0188-E (32), 0153-A / 6012-T / 9765-54 (33), 0134-AF / 0134-Q / 0188-F / 9004-T (34), 0188-P2 / 0188-P / 174 / 7015-T (35), 0153-U 7019-T (36), 0153-N / 0188-Y / 7014-TJ / 7099-TM / 9797-34 (37)</p>

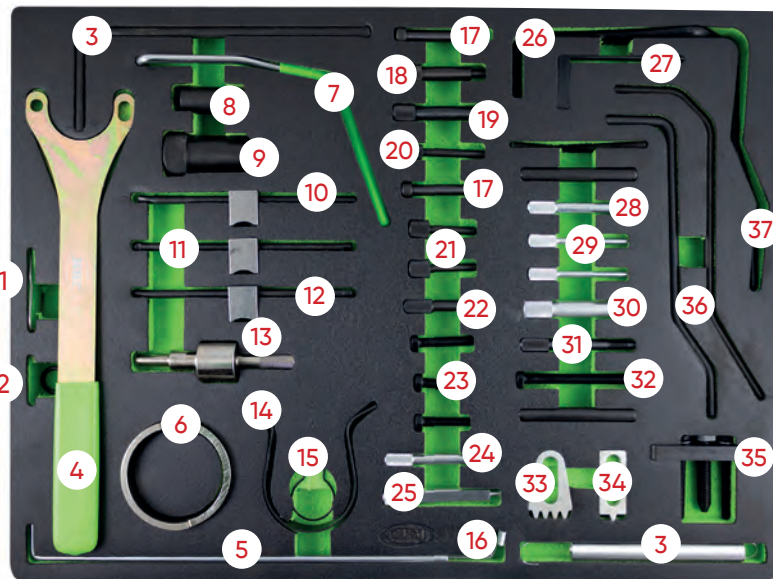

<b>CODES MOTEUR</b>	<p>F6JA, F6JB, F6JC, G8DA, G8DB, HHDA, HHDB, HHJA, HHJB  <b>Citroen_Peugeot:</b> 1.0 / 1.1 / 1.4 / 1.6 / 1.6 16V, 1.4 / 1.6 HDI / 1.8 / 1.8 16V / 2.0 / 2.0 Turbo, 1.9D / 2.0HDI / 2.2HDI / 1.8 16V / 2.0 16V  <b>TU9 (CDY/CDZ), TU1 (HDY/HDZ/HFX/HFY/HFZ), TU3 (KDX/KDY/KDZ/KFX/KFZ), TU5JP4 (NFU/NFX), TU5 (BDY/BFZ/NFT/NFV/NFW/NFY/NFZ), XU7 (LFW/LFX/LFZ), EW7 J4 (RLZ), XU7JP4 (LGY), XU10 (RFL/RFU/RFW/RFX/RGX/RGY), XU10JP4(RGX/RGY), EW10A (RFJ), EW10J4S (RFK), EW10D (RLZ), EW12J4 (3FZ), ET3JE (KFU), TU3A/JP (KFW/KFV), DV4TD (8HW/8HX/8HZ), DV4TED4 (8HV/8HY), DV6ATED4 (9HX/9HY/9HZ), EW10-CVI (RLZ), EW12 (3FZ), DW8 (WJZ/WJY), DW10 (RHY/RHV/RHZ/RHS/RHM/RHW/RHT/RHR/RHX), DW12 (4HX/4HZ/4HW/4HY), EW7J4 (6FZ), EW10J4 (RFR), EW10J4D (RLZ), DW12TED4 (4HW), DW10ATED (RHT/RHV/RHW/RHX/RHZ)</b>  <b>Ford 1.4 / 1.6 Duratorq TDCI</b></p>
---------------------	--

# KIT DE VÉROUILLAGE DE CHAINES POUR FORD / VAG / MAZDA / VOLVO

53772 229,00€

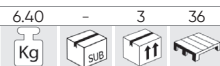

GASOLINA/PETROL

GASOIL/DIESEL

<b>MARQUES</b>	<p><b>AUDI:</b> 80, A1, A2, A3, S3, A4, A5, A6, TT, Q5  <b>SEAT:</b> Arosa, Ibiza, Cordoba, Leon, Toledo, Alhambra, Altea, Inca (99-04)  <b>SKODA:</b> Fabia, Octavia, Superb  <b>VW:</b> Lupo, Polo, Fox, Golf, Bora, Jetta, Golf Plus, Passat, Beetle, Touran, Sharan, Caddy, Caddy Maxi, Transporter, Golf VI Cabrio, Tiguan  <b>FORD:</b> Galaxy</p>
<b>OUTILS OEM</b>	<p>T10252 (1), VAS6079 (2), T10121 (3), MP1-1312 / T10098 / T20038 / T20038 (4), T10123 (5), 23-058 / 310-084 / T10008 (6), 2065A / T10008 / U40021 (7), 3418 (8), T10171 (9), 23-059 / 23-059 / 310-085 / T10050 / T10050 (10), 3458 / T30094 (11), T10016 / T10074 / T10074 (12), T10100 (14), T10414 (15), 3366 / T20018 / T20044 (16), 3411 (17), 3369 / T30092 (18), T10341 (19), 3242 / T40069 / T30052 (20), T 40026 (21), 3359 / MP1-301 / T20102 (22), 2064 / U20003 (23), T10120 (24), MP1-1312 / T10098 / T20038 (25), T10170 (26), T00115 / T10264 / T40098 (27), T10092 (28), T00115 / T10264 / T40098 (29), 303-1054 / T10115 (30), T10060 / T10060A (31), 3359 / MP1-301 / T20102 (32), T10340 (33), 2587 (34), 3387 / U30009A (35), 3387 / T10020 (36)</p>

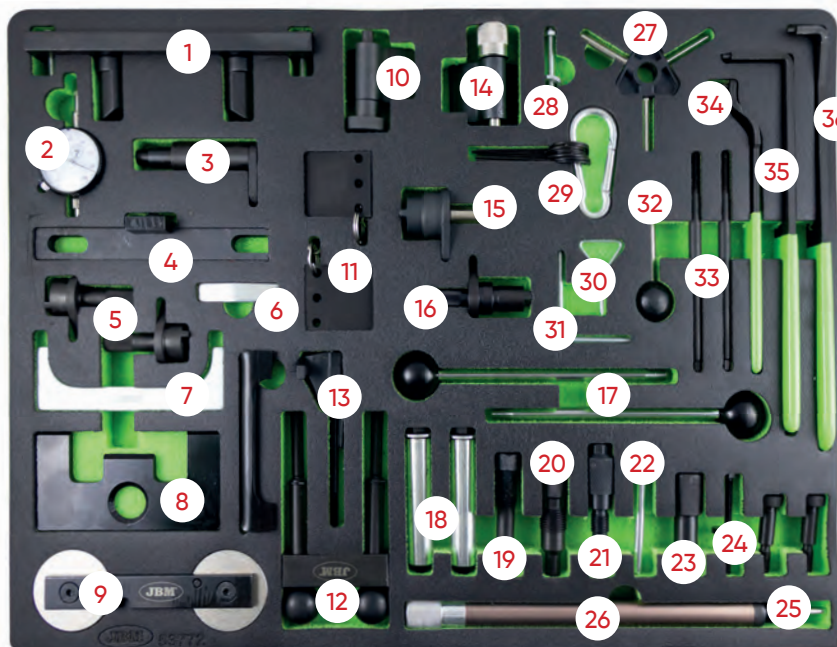

<b>CODES MOTEUR</b>	<p>ARC, ATN, AUS, AVY, AZD, AFH, BCA, AJV, AKQ, AUA, AUB, AXP, AFH, AFN, AFK, AHW, AHU, APE, AQQ, AUS, AXP, AZD, BBY, BBZ, BCB, ANY, AYZ, AMF, ATL, BAY, BHC, BMS, BNM, BNV, BWB, AJM, AMG, ANU, ARL, ASZ, ATD, ATJ, AUY, AVB, AVF, AVG, AWW, AXB, AXC, AXR, BEW, BJB, BKC, BKE, BLS, BLT, BMT, BPX, BRB, BRM, BRR, BRV, BRU, BSU, BSW, BTB, BUK, BVK, BXE, BXF, AZV, BDJ, BDK, BGW, BHW, BKD, BKP, BLB, BMA, BMM, BMN, BMP, BMR, BNA, BPW, BRC, BRE, BRF, BRT, BUZ, BE, BVF, BVG, BVH, BVK, BTS, BMY, BLF, BWV, AZV, BKD, AWY, AZQ (55 - 64 PF), AXU, BAG, BKG, BLF, BLN, BLP, BFV, BKF, BNU, BVP, BVR, IZ, CBZA, CBZC, CBZB, CAXA, CAGA, CAGB, CAGC, CAHA, CAYA, CAYB, CAYC, CBAA, CBAB, CBAC, CBBA, CBBB, CBDA, CBDB, CBDC, CBEA, CEGA, CKUB, AZV, BDJ, BHP, BKD, BLB, BMA, BMM, BMN, BMP, BMR, BNA, BPW, BRC, BRE, BRF, BRT, BSS, BUY, BUZ, BVA, BVE, BVF, BVG, BVH, BWV, ACV, ACV, AFB, AGX, AHD, AHY, AHY, AJT, AKE, ANJ, APA, AUF, AXG, AXG, AXL, AYC, AYM, AYY, BAU, BBE, BBF, BCZ, BDG, BDH, BFC, BJJ, BJK, BJJ, BJM</p>
---------------------	---

## COFFRET DE CALAGE POUR VOLVO 3.0 / 3.2T6 FREELANDER2 3.2I

53315 285,00€

GASOLINA/PETROL

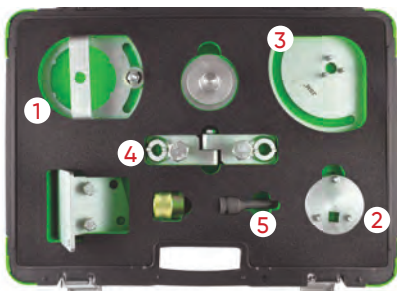
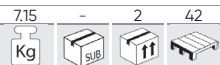

<b>MARQUES</b>	<u>VOLVO</u> : S60 (10-16), S80 (07-15), XC60 (08-15), XC70 (06-15), XC90 (10-14), V60 (10-15), V70 (10-15). <u>LAND ROVER</u> : Freelander II (11-14).
<b>OUTILS OEM</b>	<u>VOLVO</u> : 999-7263 (3), 999-7264 (1), 999-7272 (5), 999-7257 (2), 999-7261 (4). <u>LAND ROVER</u> : 303-1225 (3), 303-1226 (1), 303-1219 (2), 303-1223 (4).
<b>CODES MOTEUR</b>	<u>3.0 Turbo</u> : B6304T2, B6304T4. <u>3.2</u> : B6324S, B6324S5. <u>3.2i6</u> : B6324S.

## JEU D'EXTRACTEURS DE POULIÈRES OU DE PIGNONS DE POMPE HAUTE PRESSION POUR HYUNDAI ET KIA

54226 71,00€

GASOIL/DIESEL



<b>MARQUES</b>	<u>HYUNDAI</u> : Accent (11-15), Elantra (07-10), i20 (09-18), ix20 (10-18), i20 Coupe (15-17), i30 (07-19), ix35 (10-16), i40 (11-18). <u>KIA</u> : Carens (13-18), Ceed (07-18), Optima (11-15), Pro-Ceed (08-19), Rio (09-17), Cerato (05-07), Soul (09-14), Sportage (10-18), Venga (09-18).
<b>OUTILS OEM</b>	09331-2A000/2A010 (1), 09331-2A010 (1)
<b>CODES MOTEUR</b>	1.1D CRDi: D3FF 1.4D CRDi: D4FC(U1), D4FC(U2) 1.6D CRDi: D4FB(U1), D4FB(U2), D4FB-H(U1), D4FB-H(U2), D4FB-L(U1) 1.7D CRDi: D4FD(U2), D4FD-H(U2), D4FD-L, D4FD-L(U2)

## KIT DE VERROUILLAGE DE CHAINES POUR PORSCHE

54200 56,00€

GASOLINA/PETROL

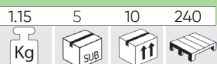

<b>MARQUES</b>	911 (2001 - 2008), Boxster (2002 - 2011), Cayman (2006 - 2009)
<b>OUTILS OEM</b>	9685 (1), 9686 (2), 9595 (3), 9595/1 (4)
<b>CODES MOTEUR</b>	M96/03, M96/05, M96/23, M96/25, M97/20, M96/24, M96/26, M97/01, M97/21, M97/22.



## KIT DE 6 OUTILS POUR SYNCHRONISATION DU MOTEUR

53775 1.109,00€

GASOLINA/PETROL

GASOIL/DIESEL

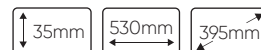
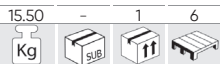

53769 RENAULT / NISSAN / OPEL / VOLVO



53770 FORD / SEAT / VOLKSWAGEN / MAZDA / VOLVO

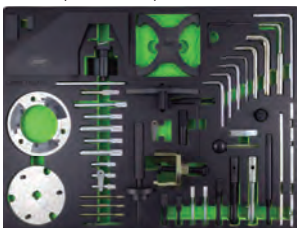

53771 FIAT / FORD / CITROËN / PEUGEOT



53772 FORD / VAG / MAZDA / VOLVO



53773 FIAT / ALFA / LANCIA / OPEL / SUZUKI / FORD



53774 OPEL / CHEVROLET / SAAB / FIAT / LANCIA / SUZUKI / FORD



# SERVANTE D'OUTILS 7 TIROIRS AVEC JEU D'OUTILS POUR RÉGLER LA SYNCHRONISATION

53951

1.794,00€

53952

1.794,00€

53775

1.109,00€

GASOLINA / PETROL

GASOIL / DIESEL



## EXTRACTEUR DE PIGNON POUR ARBRE À CAME FORD

53318

24,00€



**MARQUES** FORD

**VALABLE POUR MOTEURS** F8M, F8Q, S8U, S9U.

## CALAGE POUR RENAULT / NISSAN / DACIA / SUZUKI

51488

16,00€

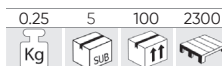

- Clavettes de sécurité pour l'set d'arbre à cames et vilebrequin pour Renault moteurs diesel et essence.  
- Idéal pour le blocage du moteur pendant le changement ou l'entretien de l'set de l'arbre à cames.



**MARQUES**

**RENAULT:** Captur, Clio II,III,IV, Espace/Grand Espace III,IV, Fluence, Kadjar, Kangoo, Laguna I,II,III,IV, Logan/Logan MCV, Megane I,II,III,IV, Modus/Grand Modus, Scenic/Grand Scenic I,II,III,IV, Twing II, Trafic II, Master II 1.5dCi & 1.9 dCi.  
**DACIA:** Dokker, Duster, Lodgy, Logan, Sandero 1.5dCi  
**NISSAN:** Almera, Cube, Juke, Kubistar, Micra, Note, NV200/Evolia, Primera, Tiida, Interstar, Primastar 1.5dCi & 1.9 dCi  
**SUZUKI:** Grand Vitara, Jimny 1.5DDIS & 1.9DDIS

**OUTILS OEM**

MOT1489, MOT1430, MOT1054.

**CODES MOTEUR**

K9K, F8Q, F9Q - Essence, Clio, R19, Laguna 1.8/2.0 F3R F3P



## OUTIL BLOQUAGE ARBRE A CAME GROUPE VAG

53320

12,00€

GASOIL / DIESEL

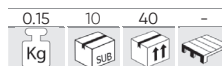

**MARQUES**

**SEAT:** Alhambra, Altea, Arona, Cordoba, Ibiza, Leon, Toledo 1.4/1.9/2.0 TDI.  
**VW:** Passat 1.9.  
**AUDI:** A4/A6 1.9.

**OUTILS OEM**

T10008, T20102, T10100.



## KIT DE 6 OUTILS POUR SYNCHRONISATION DU MOTEUR

53772



53773



53774



53769



53770



53771



## CLÉ UNIVERSELLE POUR ARBRE À CAMES + ADAPTATEURS

51340

39,30€



- Contient:

1 Clé: Plage d'ouverture: 40 mm min - 235 mm max. + Longueur 540 mm.  
4 sets de 2 vis d'adaptation de 4 dimensions.  
1 set de 2 filets de 1 cm de diamètre.



## CALAGE DISTRIBUTION VAG

52271

18,00€



**MARQUES**

**AUDI:** A2 1.4TDI (02-06), A3 1.9, 2.0TDI (02-08), A4 1.6TDI (02-05), A4 1.9, 2.0TDI (04-08), A6 1.9TDI (02-05).  
**SEAT:** Altea 1.9SDI/TDI (05-08), Leon 1.9, 2.0TDI (05-08), Toledo 1.9SDI/TDI (05-08).  
**SKODA:** Fabia 1.4TDI (03-06), Octavia II 2.0TDI (03-06)

**CODES MOTEUR**

**VW:** Beetle 1.9TDI (02-08), Bora 1.9TDI (02-08), Fox 1.4TDI (02-08), Golf 1.9, 2.0TDI (02-08), Lupo 1.4TDI (02-08), Polo 1.4, 1.9TDI (02-08), Sharan 1.9TDI (02-08).  
**SEAT:** BJB, BKC, BLS, BMM, BXE  
**SKODA:** AMF, AZV, BKD  
**VW:** AJM, AMF, ANU, ARL, ASZ, ATD, AUY, AVB, AVF, AWX, AXR, BAY, BMS, BNM, BNV, BWW

## SET BLOQUAGE ARBRE À CAMES

51489

12,00€

GASOLINA / PETROL

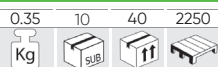

- Facile à utiliser pour le blocage des poulies de l'arbre à cames quand est réalisé l'entretien.

**MARQUES**

**VW:** Lupo 99, Polo 95, Caddy 96, Polo Classic, Variant 96, Beetle 1.4L 99, Golf 1.4L, 1.6L 98 y 1.4L, Bora, 1.6L 99.  
**AUDI:** A2.

**OUTILS OEM**

T10016.

**CODES MOTEUR**

1.4 / 1.6 16V



## KIT DE VÉROUILLAGE DE CHAINES POUR CITROËN/PEUGEOT 1.0/1.2 VTi

53875 134,00€

1.85	-	4	168
Kg	sub	ff	tr



### MARQUES

VW: Golf, Touran  
AUDI: A3, A4

### OUTILS OEM

OEM T10134.

### CODES MOTEUR

1.4i turbo  
1.4 et 1.6 injection directe de carburant  
1.9/2.0 SDi  
Moteurs diesel 2.0 de système Common Rail

## OUTIL DE DÉMONTAGE ET TENSION DE COURROIES EN POLY-V

51927 25,00€

0.65	-	5	640
Kg	sub	ff	tr



- Pour monter-démonter et extraire facilement les nouvelles courroies en POLY-V.
- Adéquat pour le PSA et les moteurs de Ford Fiesta 1.4/1.6, Citroën C4, Peugeot 307, Fiat Doblo, Dacia Logan.
- Outil indispensable pour un usage professionnel.
- Sans un point de prise précis, il n'est pas possible de démonter et d'extraire les courroies appropriées pour cet outil.



## TENSIOMÈTRE POUR COURROIE DE DISTRIBUTION

52616 44,00€

0.35	10	40	800
Kg	sub	ff	tr

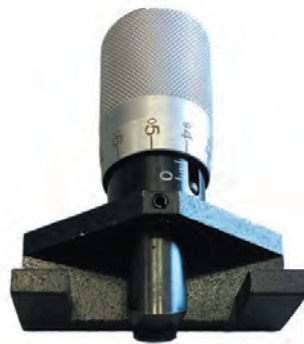

- Deux échelles réglables (daN) avec lecture frontal et arrière.

## OUTIL POUR SYNCHRONISATION DE POULE VW / AUDI 2.5 TDI 32MM

53325 7,50€

0.10	20	100	-
Kg	sub	ff	tr

GASOLINA/PETROL



### MARQUES

AUDI: 100 ('91-), A6 (2.5 TDI) 2.3, 2.4, 2.5, 2.8, 2.9D TDI (1991-2003)  
VW: LT, Transporter

### CODES MOTEUR

AAB, AAT, ACU, ACV, AEL, AET, AGX, AHG, AHY, AJA, AJT, ANJ, APA, APL, AUF, AVT, AXG, AXL, AYC.

OUTILS OEM 3355

## OUTIL RÉGLAGE DE TENSION POUR COURROIE VAG

53321 10,50€

0.25	10	50	-
Kg	sub	ff	tr

GASOLINA/PETROL

### MARQUES

AUDI: A4/1.8T, 2.0 1999-2004 A6/1.8T 2002-2004 A4/3.0 (2002 -), A6/3.0 (2002 -), A8/7.0 (2003 -).  
VW: Golf Passat 2.0 TDI DIESEL, Golf 88-97, Passat 92-97, VW T4/2.0 1992-2004.

### OUTILS OEM

T10020.

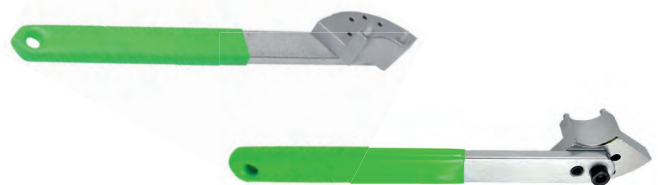

## OUTIL DE RETENTION POUR POMPE À REFROIDISSEMENT

53317 34,00€

0.64	-	12	-
Kg	sub	ff	tr

GASOIL/DIESEL



- Utilisé pour maintenir la position des phases de distribution du moteur lors de la dépose / installation de la pompe du système de refroidissement.  
- Permet de remplacer la pompe sans déplacer la chaîne du mécanisme de distribution de gaz.

### MARQUES

OPEL 2.2 Chaîne  
VAUXHALL 2.2 Chaîne



## DOUILLE 1/2" POUR CHAMBRE DE PRÉCOMBUSTION

52819 22,00€

0.24	15	60	-
Kg	sub	ff	tr

1/2" MERCEDES



58 DENTS





# **LUBRIFICATION**

- 248 BACS POUR BIDONS
- 250 POMPE D'APPROVISIONNEMENT GASOIL
- 251 POMPE DE UREA AUS32
- 252 POMPE D'EXTRACTION
- 253 REMPLISSAGE D'HUILE
- 256 PISTOLETS DE SUCCION
- 258 DIVERS / ENTONNOIR

## BACS DE RETENTION

Caillebotis amovible / Palet fixe pour déversement / Retirez le fut avant d'utiliser un chariot élévateur / Facile à transporter / Pour une utilisation avec la plupart des chariots et transpalettes / Fabriqué en polyéthylène (PE) 100% recyclable.

SUPPORTE 400 KG

SUPPORTE 650 KG

NE CONVIENT PAS POUR LES TRANSPALETTES SUPPORTE 1.250 KG

**52804** 343,00€

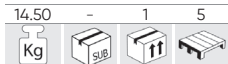

**230L**

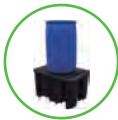

1 FÛT VERTICAL

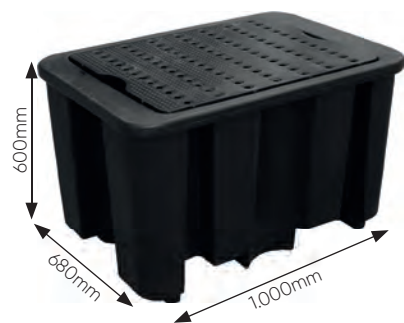

**52805** 426,00€

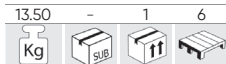

**250L**



2 FÛTS VERTICAUX



**52806** 742,00€



**250L**



4 FÛTS VERTICAUX

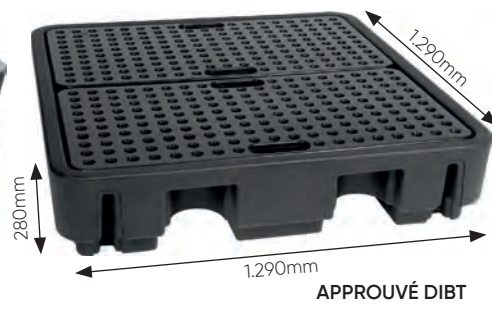

APPROUVÉ DIBT

## RÉSERVOIR POUR 2 FÛTS VERTICAUX SPECIAL EUROPALETTE

**53214** 285,00€

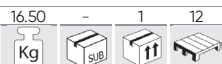

- Pour 2 lb.
- Compatible palette Europe (1200 mm x 800 mm) et palettes plastique de taille similaire.
- Emboltables pour un transport/stockage économique.
- Placant une palette Europe directement sur le bac pour réduire le coût.
- Les palettes chargées peuvent être déposées sur/soulevées du bac ou du caillebotis par chariot élévateur.
- Bac bas profil pour une hauteur de travail idéale.
- Capacité conforme ou supérieure aux réglementations Européennes, GB et US.
- Manipulable à vide par chariot élévateur de 4 côtés et par transpalette de 2 côtés.
- En PE – 100% recyclable.

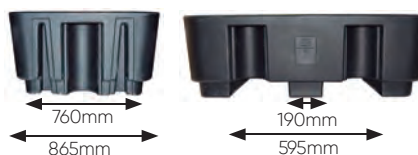

## BAC DE RETENTION CONTENEUR 1.000L IBC

**52807** 1.714,00€

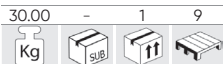

SUPPORTE 2.500 KG

- Empilable, économie d'espace, innovante.
- Faible hauteur (700mm) pour une utilisation facile.
- Large zone de travail (2,5 m2).
- Plate-forme des mains accessible et d'inspection des trous et des pompes insertion.
- Facile à transporter.
- Compatible avec la plupart des chariots élévateurs et des palettes.
- 100% recyclable PE résistant aux UV.



APPROUVÉ DIBT



## JERRICAN BIDON EN MÉTAL

**54181** 25,10€

145	-	4	72
Kg	sub	ff	ff

**5L**

55x26x35cm

**54182** 34,70€

2.55	-	4	48
Kg	sub	ff	ff

**10L**

57x35x42.5cm

**54184** 44,00€

4.10	-	4	24
Kg	sub	ff	ff

**20L**

76x37x50cm



**54183** 38,20€

2.75	1	6	48
Kg	sub	ff	ff

54x39x58cm

u

S

**10L**

**ANTI-RENVERSEMENT**



**TUYAU DE REMPLISSAGE SOUPLE POUR JERRICAN**  
(REF.54181, 54182, 54183, 54184)

**15874**

6,50€

0.30	50	800
Kg	ff	ff

## CHARIOT PORTE BIDONS SPÉCIAL HUILE

**50924** 342,00€

- Apte pour des bidons d'huile de 200L.

31.00	-	1	6
Kg	sub	ff	ff



**ROUE PIVOTANTE**

## PINCE POUR BIDONS (CAPACITÉ DE CHARGEMENT 500 kg)

**53612** 96,00€

4.75	-	1	66
Kg	sub	ff	ff

**500Kg**

- Pour manipuler des bidons d'huile.
- Capacité: 500kg.
- Type de prise verticale de conteneur
- Bidons spéciaux 200 litres.



**CE**

## PINCE POUR OUVERTURE DE FÛT

**52452** 8,00€

0.12	6	60	1080
Kg	sub	ff	ff

- Matière: Nylon.
- Anti-étincelles et anti-poussière.
- Relief de 3/4" et 2".
- Utile pour bidons de 200L.



## ROBINET POUR BIDON DE 200L

**53078** 18,00€

0.25	5	25	300
Kg	sub	ff	ff

- Permet de vider rapidement les fûts de 200 litres.
- Convient à l'eau, à tous les types d'huiles, à l'ALCOHOL ou à la cétone, ainsi qu'aux acides faiblement concentrés et aux liquides légèrement alcalins.

- Matériel: PE.
- Joint EPDM.
- Ressort en acier inoxydable.



## ROBINET DE PLASTIQUE POUR FÛT DE 3/4" 200L

**53518** 3,50€

0.05	10	500	3000
Kg	sub	ff	ff

- Convient à tous les types de fluides.
- Filetage extérieur 3/4".



**200L**

## ROBINET DE 3/4" POUR FÛTS DE 200L

**52453** 21,00€

0.19	5	100	1000
Kg	sub	ff	ff

- Robinet de sécurité.
- Vise de 3/4".
- En Alliage.
- Joint en Nylon.
- Applications: huiles, lubrifiants, essence, diesel, querosene, etc.
- Validé pour Urea AUS32.



**200L**

## POMPE À CARBURANT DIESEL AVEC DOSEUR ET INDICATEUR (200 À 240 V)

**53697** 398,00€

17.00	-	1	18
Kg	sub	ff	ff

- Tension nominale: 200 à 240 V
- Puissance nominale: 550 W
- Débit max.: 60 l/min

- Longueur du câble: 2 m.
- Longueur du tuyau d'aspiration: 2 m.
- Longueur du tuyau en charge: 4 m.

AVEC ARRÊT AUTOMATIQUE



200V	550W	50Hz
240V		
2m	4m	20-65mm



TUYAU POUR ALIMENTATION

15984	0.60	-
48,00€	Kg	ff

TUYAU POUR EXTRACTION

15983	0.60	10
11,50€	Kg	ff



POMPE

15981	8.75	-	2
181,00€	Kg	sub	ff



AVEC ARRÊT AUTOMATIQUE

15980	1.20	20
55,00€	Kg	ff



INDICATEUR DIESEL / ESSENCE

15982	1.85	8
73,00€	Kg	ff

## POMPES DISTRIBUTEUR DIESEL AVEC PISTOLET

- Pompe de transfert de carburant portable.
- Facile à transporter: taille compacte avec poignée intégrée.
- Pistolets à arrêt automatique.

### POMPE DISTRIBUTEUR DIESEL AVEC PISTOLET (230 V)

**53610** 294,00€

13.00	-	1	24
Kg	sub	ff	ff

AVEC ARRÊT AUTOMATIQUE

- Longueur du tuyau d'entrée: 2m.
- Longueur du tuyau avec pistolet et tuyau de sortie: 4m.



230V	10A	2800 RPM	60L/min
550W			
2m	4m	Altura máxima de aspiración Maximum suction height	
		5m	

POMPE

15981	8.75	2
181,00€	Kg	ff

DOSEUR

15980	1.20	20
55,00€	Kg	ff

TUYAU POUR EXTRACTION

15983	0.60	10
11,50€	Kg	ff

TUYAU POUR ALIMENTATION

15984	0.60	-
48,00€	Kg	ff

### POMPE DISTRIBUTEUR DIESEL AVEC PISTOLET (12 V)

**53609** 190,00€

7.30	-	1	24
Kg	sub	ff	ff

AVEC ARRÊT AUTOMATIQUE

- Longueur du tuyau d'entrée: 2m.
- Longueur du tuyau de sortie: 4m.



12V	10A	3600 RPM	45L/min
175W			
2m	4m	Altura máxima de aspiración Maximum suction height	
		3m	

POMPE

15553	3.35	1
108,00€	Kg	ff

DOSEUR

15980	1.20	20
55,00€	Kg	ff

TUYAU POUR EXTRACTION

15983	0.60	10
11,50€	Kg	ff

TUYAU POUR ALIMENTATION

15984	0.60	-
48,00€	Kg	ff

## POMPE À DIESEL ÉLECTRIQUE

**54100** 265,00€

4,00	-	4	24
Kg	sub	ff	box



12V	100V	50-60Hz	18,4 L/min
240V			
200L	2m	2 bar	30 PSI

Longueur du tube d'aspiration : 850-1245 mm  
 Longueur du tuyau : 2 m  
 Température de travail : 5° - 40°C (41° à 104°F)  
 Tension CC : 12 V  
 Courant alternatif : 100-240 V  
 Longueur du câble : 4 m



## PISTOLET AUTOMATIQUE POUR ALIMENTATION EN URÉE AUS32

**15631** 98,00€

1,15	-	10	-
Kg	sub	ff	box

6 bar



## RÉSERVOIR POUR UREA AUS32 (75 L)

**53644** 1.238,00€

18,15	-	1	4
Kg	sub	ff	box

- Une conception autonome et entièrement mobile de 75l de volume avec une pompe alimentée en 12V (on pourra atteindre une productivité de 10l/min), équipée d'un tuyau et d'une vanne d'arrêt automatique.
- Le réservoir en polyéthylène est compact, résistant à la corrosion et aux rayons UV.
- Les roues de grand diamètre (200mm) offrent une grande maniabilité, même sur un sol accidenté.

1.040mm	440mm	520mm
---------	-------	-------

12V	75L	10 L/min
40 PSI	2.75 bar	4m



75L UREA AUS32



## POMPE ÉLECTRIQUE POUR UREA AUS32

**53645** 268,00€

3,10	-	4	24
Kg	sub	ff	box

- La pompe électrique rotative est conçue pour fonctionner avec les agents à base d'eau, Urea AUS32 DEF et permet de pomper le contenu des réservoirs IBC de 205 l ou de 1000-1250l.
- Design compact et léger.
- Fusible intégré pour la protection contre la surcharge et le moteur silencieux.
- Filtre intégré dans le tube d'aspiration en acier inoxydable, empêchant les contaminants de pénétrer et, par conséquent, excluant des pannes.



INTERRUPTEUR MARCHÉ / ARRÊT COMMODE AVEC INDICATEUR LED

ADAPTATEUR INTÉGRÉ 2" + ADAPTATEUR FILETÉ SUPPLÉMENTAIRE



12V	100V	50-60Hz	18,4 L/min
240V			
200L	2m	2 bar	30 PSI

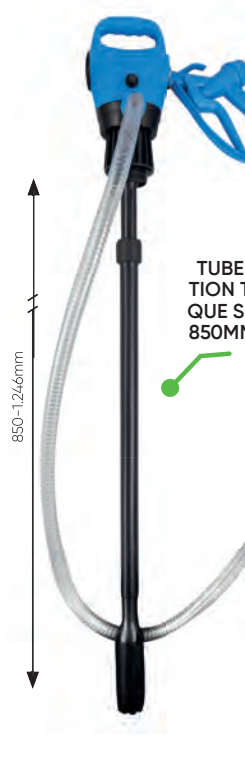

TUBE D'ASPIRATION TÉLESCOPIQUE SE DÉPLIE DE 850MM À 1245MM

UREA AUS32

PISTOLET

15123	10
32,00€	ff

TUYAU 4M

14473	5
46,00€	ff

ADAPTATEUR D'ENTRÉE POUR RÉSERVOIR IBC

14703	50
13,00€	ff

30mm

187mm

187mm

2" BSP



TVA non comprise

**JBM** / [www.jbmfrance.fr](http://www.jbmfrance.fr)

251

## POMPE À GRAISSE + TUYAU AVEC ROBINET

52601 397,00€

200L

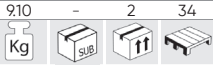

- Pression Rapport: 5: 1.
- Entrée d'air: 1/4".
- Sortie d'air: 1/4".
- Pression de travail: 6-8 bar.
- Pression Max.: 8 bar.
- Consommation d'air: 250 L/min.
- Capacité relative à 6 bar: 18 L/min.
- Plage de température de l'huile: -10~50 °C.
- Viscosité maximale: 240 SAE.
- Longueur du tube: 950 mm.



TUYAU AVEC ROBINET POUR REF. 52601

12056 57,00€



## KIT POMPE À HUILE + TUYAU + PISTOLET A HUILE COMPTEUR DIGITAL

50935 595,00€

200L

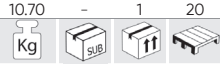

- Longueur du tuyau: 2 m.
- Longueur du tube: 950 mm.
- Viscosité maximale: 240 SAE.
- Consommation d'air: 250 L/min.
- Capacité relative à 6 bar: 18 L/min.
- Plage de température de l'huile: -10~50 °C.
- Pression Rapport: 5: 1.
- Entrée d'air: 1/4".
- Sortie d'air: 1/2".
- Pression de travail: 6-8 bar.
- Pression Max.: 8 bar.



## POMPE À HUILE

50918 341,00€

200L

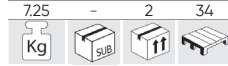

- Pression Rapport: 5: 1.
- Entrée d'air: 1/4".
- Sortie d'air: 1/2".
- Pression de travail: 6-8 bar.
- Pression Max.: 8 bar.
- Consommation d'air: 250 L/min.
- Capacité relative à 6 bar: 18 L/min.
- Plage de température de l'huile: -10~50 °C.
- Viscosité maximale: 240 SAE.
- Longueur du tube: 950 mm.

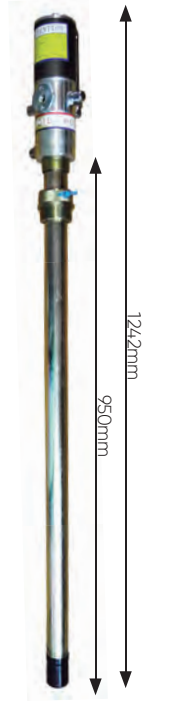

REDUCTION / AUGMENTATION POUR REF. 50935 ET 50918

10767 21,00€



10925 18,00€



## PISTOLET À POMPE AVEC DÉBITMÈTRE POUR HUILE

50917 271,00€

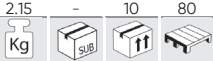

PILES DE RÉCHANGE REF. 50917

10000 7,00€

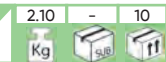

- Entrée d'air: 1/2".
- Plage de débit: 1-35 L/min.
- Pression de travail: 6-8 bar.
- Plage de température de l'huile: -10~60 °C.
- Viscosité maximale: 240 SAE.
- Pile incluse.
- Poids: 1,4Kg.

## ADAPTATEUR FILETÉ POUR TAMBOURS EN PLASTIQUE

13982 4,00€

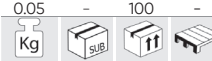

- Prévoit le réglage et la compensation de divers filetages de réservoirs, de fûts et de pompes.



## POMPE ROTATIVE

52428 43,00€

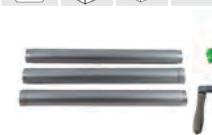
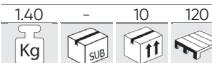

- Pour les fûts de 50 à 200L
- Flux de 400ml par pompage.
- Capacité de pompage: 32l x min.
- Adaptateur 2" inclus.
- Tuyau d'aspiration de 101cm avec entré de 1 1/4" et sortie de 1".
- Pas valable pour les acides forts, eau de javel.
- Applications: huiles, lubrifiants, diesel, fluides à base d'huile.
- Recommandé pour: Diluant, laque, liquide de frein, de détergents, glycérine, acides légers, fluides à base de pétrole.

## POMPE MANUELLE À LEVIER POUR HUILE

51253 41,00€

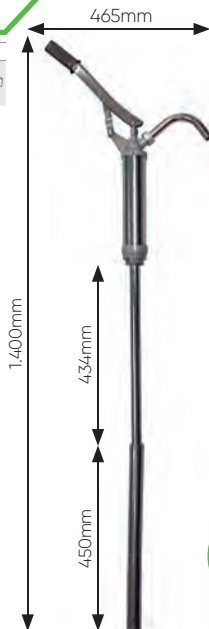
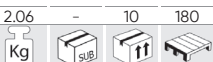

## POMPE À LEVIER

52329 36,40€



- Pour fûts de 25, 50, 200L
- Pompage de 350ml
- Corps et piston en polypropylène
- Poignée en plastique ABS
- Applications: alcools, huiles, lubrifiants, essence, diesel, kérosène, etc.
- Conduit: Larg. min.: 320mm, Larg. max.: 900mm



# RÉCUPÉRATEUR D'HUILE AVEC SYSTÈME D'ASPIRATION

53874 398,00€

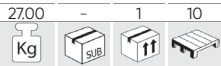

90L 8-10 BAR

## PIÈCES DE RÉCHANGE DISPONIBLES

14937



15282



15283



15305



15306



15307



15310



15311



15312



15318



15308



Conçu pour collecter et vidanger l'huile de moteur et de transmission des véhicules.

- Pression d'air de fonctionnement 8 ~ 10 bar
- Niveau de vide: négatif 0 ~ 0,8 bar
- Capacité du réservoir: 70 l
- Capacité de la crépine de collecte 10 l
- Capacité de la tasse doseuse: 10 l
- Vitesse d'aspiration d'huile en fonction du diamètre de la sonde: 0,8 l/min (Ø5x3,5 mm); 1 l/min (Ø6x4,5 mm); 1,6 l/min (Ø8x6,5 mm)
- Dimensions: 43x49x163 cm
- Milieu: huile de moteur et huile de transmission
- Température d'huile de fonctionnement recommandée: 40 ~ 60 °C
- Avec vide d'EXTRACTION.
- Système de mesure intuitif.
- Grand réservoir.
- Poignée pour contrôler l'utilisation.
- Roulettes pour un transport facile

REF.	CARASTÉRISTIQUES	Kg	Sub	ff	€
15018	Module de douilles de vidange 22pcs	1,45	-	10 480	46,00€
14937	Roue pour collecteur d'huile 80l	0,30	-	14 -	9,50€
15282	Manomètre	0,20	-	20 -	15,00€
15283	Tuyau	0,40	-	20 -	27,50€
15305	Tuyau à robinet courbé	0,65	-	40 -	19,50€
15306	Tuyau pour raccorder l'entonnoir à un réservoir avec vanne d'arrêt	0,35	-	20 -	27,50€
15307	Entonnoir	2,10	-	10 40	39,60€
15310	Partie supérieure de vanne	0,05	-	20 -	11,50€
15311	Jeu de raccords	0,20	-	20 -	11,50€
15312	Raccord pour connecter le réservoir et le tuyau	0,10	5	40 -	11,50€
15318	Tube de raccordement	0,80	-	20 -	17,00€
15308	Petite roue pivotante	0,35	-	40 -	7,00€
14014	Tuyau de remplacement 4mm	0,02	-	150 1500	6,00€
14015	Tuyau de remplacement 6mm	0,05	-	150 2250	6,00€
14016	Tuyau de remplacement 8mm	0,05	-	100 -	6,00€
15550	Tuyau d'aspiration en métal 6mm	0,05	-	100 -	6,00€
15551	Tuyau d'aspiration en métal 8mm	0,05	-	100 -	6,00€



## MODULE DE DOUILLES DE VIDANGE 22PCS

15018 46,00€

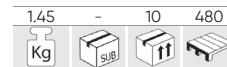

# RÉCUPÉRATEUR D'HUILE

53873 285,00€

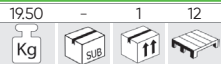

80L 1-3 BAR

Conçu pour collecter et vidanger l'huile de moteur et de transmission des véhicules.

- Pression d'air de fonctionnement 1 à 3 bar
- Capacité du réservoir: 70 l
- Capacité de la crépine de collecte 10 l
- Dimensions: 35x48x163 cm
- Milieu: huile de moteur et huile de transmission.
- Grand réservoir.
- Poignée pour contrôler l'utilisation.
- Roulettes pour un transport facile.
- Peut être utilisé pour les huiles haute température (sans limites).

## PIÈCES DE RÉCHANGE DISPONIBLES

15309

15308



14937



15305



15307



15312



REF.	CARASTÉRISTIQUES	Kg	Sub	ff	€
15018	Module de douilles de vidange 22pcs	1,45	-	10 480	46,00€
14937	Roue pour collecteur d'huile 80l	0,30	-	14 -	9,50€
15305	Tuyau à robinet courbé	0,65	-	40 -	19,50€
15307	Entonnoir	2,10	-	10 40	39,60€
15309	Tube de raccordement	0,75	-	20 -	17,00€
15312	Raccord pour connecter le réservoir et le tuyau	0,10	5	40 -	11,50€
15308	Petite roue pivotante	0,35	-	40 -	7,00€



## POMPE D'ASPIRATION D'HUILE - 12V

**53566** 32,00€

1,00	5	10	210
Kg	Sub	ff	ff

- La pompe d'aspiration d'huile (l'extracteur) est un dispositif idéal pour une vidange d'huile rapide et de grande qualité.
- Elle fonctionne à partir d'une batterie de voiture (12 V) à travers les clips fournis.
- L'huile est extraite du moteur par le trou pour la jauge.
- N'utilisez l'extracteur que pour pomper de l'huile moteur, de l'huile pour moteurs diesel et du liquide de refroidissement.

12V	70 dB(A)	5A
2,5(m/s)	MOTOR-OIL 1L/min	DIESEL-OIL 2L/min

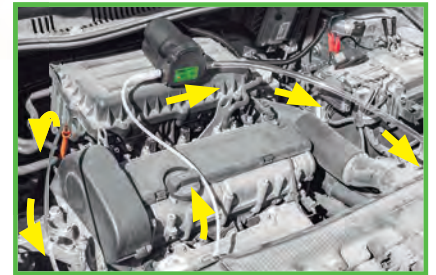
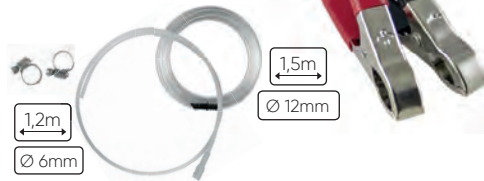

## KIT D'EXTRACTION D'HUILE ET DE CARBURANT

**53627** 22,50€

0,55	-	12	96
Kg	Sub	ff	ff

- L'appareil est conçu et fabriqué pour une évacuation rapide de l'huile, du carburant, ainsi que de l'huile de transmission / huile différentielle des réservoirs de générateurs, des nettoyeurs haute pression, des compresseurs à air, des tracteurs de jardin ou des véhicules tout terrain.



1,6L	1,3m
------	------



## TESTEUR D'ANTIGEL

**53453** 7,00€

-43°C ~ 131°C

0,10	24	96	384
Kg	Sub	ff	ff



## TAPIS AVEC RÉSERVOIR TAPIS POUR LA DÉSINFECTION DES CHAUSSURES

**53862** 6,00€

1,45	-	5	100
Kg	Sub	ff	ff

- Mesures: 85x55x10cm
- Matériel: TPE
- Capacité maximale recommandée: 3L
- Capacité maximale: 8L

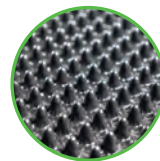

## TAPIS DE SÉCHAGE

**53863** 3,00€

0,70	-	5	240
Kg	Sub	ff	ff

- Mesures: 76x48cm
- Matériel: polyester

## RÉFRACTOMÈTRE POUR ALCOHOL

**50731** 68,00€

0,56	-	5	500
Kg	Sub	ff	ff



## RÉFRACTOMÈTRE UNIVERSEL

**52963** 49,00€

0,28	5	20	460
Kg	Sub	ff	ff

- Éthylène glycol: -50°C ~ -0°C.
- Propylène glycol: -50°C ~ -0°C.
- Liquide de nettoyage: -40°C ~ -0°C.
- UREA AUS32: -30% ~ 35%.
- Liquide de batterie: -1.100 - 1.400 sg/l.

UREA AUS32



# MACHINE D'ÉCHANGE D'HUILE DE TRANSMISSION AUTOMATIQUE

**54050** 980,00€

Permet de changer l'huile de transmission en mode automatique.

25,45	-	1	4
Kg	Sub	ff	ff

- Source d'alimentation : 12 V (batterie de voiture)
- Puissance de la pompe : 70 W
- Diamètre du manomètre d'huile : 70 mm (les deux manomètres d'huile)
- Plage de mesure des manomètres d'huile : 0-10 bar (0-150 psi)
- Capacité du réservoir d'huile fraîche : 30 l
- Capacité du réservoir d'huile usée : 30 l

- Comprend :
- 1 dispositif de remplacement et de rinçage
  - 1 jeu d'adaptateurs avec 37 adaptateurs de raccordement / adaptateurs de tuyaux
  - 1 tuyau de raccordement rouge avec raccord rapide, longueur 250 mm, diamètre 12,5 mm (1/2"), 20 bar (300 psi) max.
  - 1 tuyau de raccordement noir avec raccord rapide, longueur 250 mm, diamètre 12,5 mm (1/2"), 20 bar (300 psi) max.



Le kit de livraison comprend une mallette avec des adaptateurs pour différentes marques de voitures (Volkswagen, BMW, Land Rover, Ford, Mercedes, Buick).



12V BATTERY CLAMPS

KIT D'ADAPTEURS POUR REF. 54050

15539	1.30	5	
104,00€	Kg	ff	ff

ÉLÉMENT FILTRANT

15542	0.10	20	
45,00€	Kg	ff	ff

JOINT TORIQUE POUR ENTRÉE D'HUILE

15480	0.00	-	
0,99€	Kg	ff	ff

# SYSTÈME DE REMPLISSAGE DE BÔÎTE À VITESSE AVEC D'EMBOUITS

**52797** 198,00€

5,00	-	1	24
Kg	Sub	ff	ff

- Capacité: 7,5L.
- Débit: 80cc cycle.
- Viscosité max. de huile débitée SAE 140.
- Permet de remplir et de vider

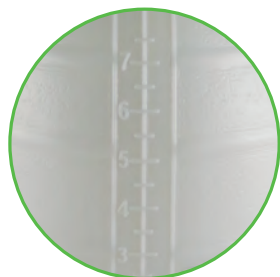

POMPE DE REMPLISSAGE DE SYSTÈME DE TRANSMISSION SANS ACCESSOIRES REF. 52797

13234	3.75	1	24
224,50€	Kg	ff	ff



## COFFRET D'EMBOUITS POUR REF. 52797

**12044** 147,00€

1,32	-	20	120
Kg	Sub	ff	ff

**101**  
FORD 1/8 - 27 (NPT)

**102**  
UNIVERSAL, BMW, HONDA, NISSAN, etc

**103**  
VW/AUDI, SKODA

**104**  
VW/AUDI, PORSCHE

**105**  
VW/AUDI, MINI COOPER M10x1.0

**106**  
VW/AUDI DSG M24x1.5

**107**  
VW/AUDI CVT M22x1.5

**108**  
MERCEDES M12x1.5

**109**  
VW/SKODA M18x1.5

**110**  
AUDI/VW, SKODA, M30x1.5

**111**  
UNIVERSAL FLEXIBLE 300mm, HONDA, HYUNDAI, KIA, etc.

**112**  
VOLVO 5/16 - 24 (UNF)

**113**  
TOYOTA, LEXUS M18x1.0

**114**  
NISSAN, INFINITI M8x1.0

**115**  
ATF - ADAPTER VW PASSAT



15 PCS

## POMPE MANUELLE POUR INJECTION DIESEL

**52801** 26,00€



0.10	5	50	600
Kg	Sub	ff	ff

- Évite le retour d'essence vers le réservoir pendant le remplacement de la pompe à injection, filtres ou autres parties.  
- Après avoir remplacé les parties à changer, il permet de pomper l'essence qui se dirige vers la ligne d'injection.



## POMPE MANUEL EXTRACTION GASOIL

**52789** 15,20€

0.15	10	24	192
Kg	Sub	ff	ff

- Tuyau 90cm longue pour chaque extrémité.



## ENROULEUR D'HUILE RACCORD 1/2"

**50797** 490,00€

26.60	-	1	14
Kg	Sub	ff	ff

À base d'huile/bobine  
Longueur du tuyau : 15+1 m  
Pression de service max. : 2 450 psi  
Entrée d'air : 1/2" BSPT (filetage conique britannique)  
Sortie d'air : 1/2", filetage conique britannique  
Matériau : acier



15m  
**160 BAR**



## SERINGUE TRANSPARENT

**52498** 58,00€

0.85	-	10	120
Kg	Sub	ff	ff

- Fabriqué en polipropylène.  
- Corps transparent.  
- Valable pour huiles de transmission et différentielles.  
- Résiste au liquide de frein et antigel.

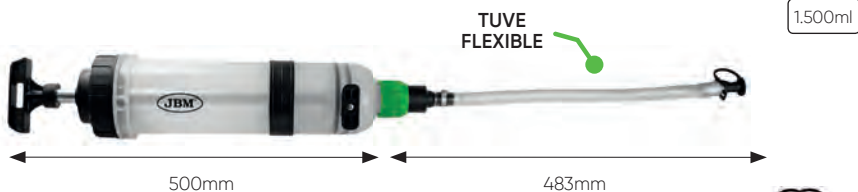

TUVE FLEXIBLE

1.500ml

DEUX JOINTS TORIQUES POUR REF. 52498

**11867** 0.02 100  
9,00€ Kg ff

**52628** 26,50€

0.25	5	20	360
Kg	Sub	ff	ff

- Pour liquide de frein.  
- Connecteur rapide à l'extrémité.

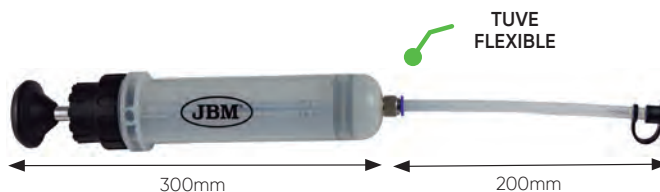

TUVE FLEXIBLE

200ml



## SERINGUE À HUILE

**51928** 14,00€

0.82	5	20	420
Kg	Sub	ff	ff



CHRO-MÉE 500ml

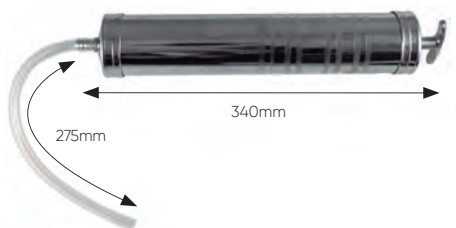

## PISTOLET À GRAISSE MINI

**53849** 16,10€

0.30	-	40	880
Kg	Sub	ff	ff

- Ce pistolet graisseur est parfait pour les bateaux, motos, vélos électriques, vélos ou toute autre machine ou équipement nécessitant une lubrification.  
- Très confortable pour travailler d'une seule main.

- Buse de 0,5 mm.  
- Bouchon amovible avec tube 50°.  
- Pression de service de 1000 psi.  
- Pompe de charge: poussée à ressort.

80cc





# POMPE À GRAISSE MANUELLE AVEC TUYAU FLEXIBLE

**50852** 24,50€

1,30	5	20	240
Kg	sub	ff	tr

500ml



# POMPE A GRAISSE PNEUMATIQUE

**50751** 43,00€

1,50	5	10	150
Kg	sub	ff	tr

- Tube rigide.
- Tube flexible.
- Pression : 30 Mpa



# ACCOUPEMENT À DÉGAGEMENT RAPIDE

**53592** 25,00€

0,15	25	100	-
Kg	sub	ff	tr

Il est recommandé de l'utiliser avec les pistolets graisseurs JBM réf. 50751 et 50852, bien qu'il convienne à la plupart des pistolets.

- Design ergonomique.
- Facile à manipuler: permet d'accoupler et de désaccoupler facilement sans effort et en réduisant le temps de travail.
- La soupape anti-retour intégré permet de déconnecter facilement l'unité à des pressions pouvant atteindre 1 034 bar (15 000 PSI).
- Connexion 1/8 NPT intégrée.



# ENSEMBLE D'ACCESSOIRES POUR PISTOLET À GRAISSE

**54255** 68,00€

1,60	-	10	500
Kg	sub	ff	tr

300mm

7 PCS 360°

330mm 90°

- x1 [Image]
- x1 [Image]
- x1 [Image]
- x1 [Image]
- x1 [Image]
- x1 [Image]



# BACS DE VIDANGE PVC

Sortie d'évacuation latérale / Poignées de charge / PVC très résistant / Compact.

## POUR ANTIGEL

**53215** 19,00€

0,95	-	6	60
Kg	sub	ff	tr

18L

- Dimensions: Hauteur: 185mm / Diamètre: 380mm.



## POUR HUILE

**53144** 18,00€

0,99	-	6	48
Kg	sub	ff	tr

18L

- Dimensions: Hauteur: 185mm / Diamètre: 380mm.



# PLATEAU D'HUILE 8L

**54051** 39,00€

1,95	-	4	32
Kg	sub	ff	tr

110mm 600mm 330mm

8L

PE

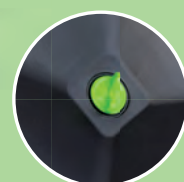

## BAC DE RÉCUPÉRATION

51356 48,00€

3,00	-	5	30
Kg	sub	ff	

23 L	110mm	400mm	600mm
------	-------	-------	-------



## BURETTE 250ml

52243 8,50€

0,14	5	60	720
Kg	sub	ff	

250ml



## BROCS VERSEUR GRADUÉS AVEC FLEXIBLE ET COUVERCLE

52991 10,50€

0,16	-	20	240
Kg	sub	ff	

2L



52992 18,00€

0,30	-	8	96
Kg	sub	ff	

5L

## BURETTE 500ml

52242 12,00€

0,28	10	60	480
Kg	sub	ff	



## ENTONNOIR POUR BIDON 200L AVEC BOUCHON ET FILTRE

53187 39,00€

0,75	-	18	54
Kg	sub	ff	

4,5L

- Ø Intérieur: 245mm.
- Ø Extérieur: 255mm.



## SET DE 3 ENTONNOIRS

53188 7,00€

0,15	-	24	288
Kg	sub	ff	

Ø 90mm  
130mm  
180mm



## ENTONNOIR FLEXIBLE

52391 5,00€

0,09	5	20	240
Kg	sub	ff	



950ml  
140 x 15mm

## ENTONNOIR AVEC TUBE FLEXIBLE

53198 9,50€

0,15	-	24	144
Kg	sub	ff	





## **OUTILLAGES HYDRAULIQUES**

- 260 CRIC ROULEUR
- 262 CRIC BOUTEILLE
- 263 CHANDELLES
- 265 PORTE-ROUES
- 266 PRESSES
- 267 GRUES
- 268 SUPPORT POUR MOTEURS
- 269 POUR MOTO
- 270 TRANSPALLETTE

## CRIC ROULEUR - SYSTÈME RAPIDE

**53725** 248,00€

344mm 682mm 155mm

COQUE AVEC PROTECTION EN CAOUTCHOUC

32.00 - 1 18  
Kg SUB if

465mm  
133mm  
**3T**

GOMA RUBBER NYLON

SISTEMA FAST PUMP FAST PUMP SYSTEM  
RENCONTRE AVEC: EN 1494:2001



PISTON RECHANGE

**14709** 6.15 5  
122,00€ Kg if

## CRIC HYDRAULIQUE 3T AVEC LEVIER D'ÉLEVATION

**53422** 368,00€

372mm 778mm 165mm

COQUE AVEC PROTECTION EN CAOUTCHOUC

44.50 - 1 15  
Kg SUB if

533mm  
100mm  
**3T**

GOMA RUBBER NYLON

CE



GALET ORIENTABLE POUR RÉF. 53422

**14071** 25  
21,50€ if

GALET NON ORIENTABLE POUR RÉF. 53422

**14072** 25  
21,50€ if

PISTON POUR RÉF. 53422

**14073** 3  
128,00€ if

## CRIC ROULEUR AVEC PÉDALE D'APPROCHE 3T

**53112** 298,00€

345mm 720mm 185mm

39.95 - 1 18  
Kg SUB if

520mm  
140mm  
**3T**

CE



PISTON RECHANGE POUR RÉF. 53112

**13853**  
122,00€

BOÎTIER EN CAOUTCHOUC POUR VÉRIN À CHARIOT. RÉF. 53112

**13836**  
9,00€

## CRIC ROULEUR 2T SPÉCIAL VOITURES BASSES

**53421** 298,00€

360mm 740mm 150mm

COQUE AVEC PROTECTION EN CAOUTCHOUC

33.50 - 1 18  
Kg SUB if

505mm  
75mm  
**2T**

DOUBLE PISTON

GOMA RUBBER NYLON

CE



GALET ORIENTABLE POUR RÉF. 53421

**14068** 50  
13,00€ if

PISTON POUR RÉF. 53421

**14070** 4  
116,00€ if

GALET NON ORIENTABLE POUR RÉF. 53421

**14069** 50  
13,00€ if

## CRIC ROULEUR 2,5T SPÉCIAL VOITURES BASSES

**54137** 288,00€

740mm 350mm 150mm

30.65 - 1 18  
Kg SUB if

505mm  
78mm  
**2'5T**



## CRIC HYDRAULIQUE

**50818** 198,00€

346mm 685mm 180mm

35.80 - 1 18  
Kg SUB if

495mm  
133mm  
**3,5T**



EN 1494:2001



ÉLÉMENT EN  
CAOUTCHOUC POUR  
PLAQUE POUR REF. 50818

**14615** 0.05 100  
9,50€ Kg if

PISTON RECHANGE  
POUR REF. 50818

**10768** 6.35 4  
113,00€ Kg if

VIS DE FIXATION  
LATÉRALE POUR REF.  
50818

**10639** 0.34 5  
10,90€ Kg if

SUPPORT POUR  
REF. 50818

**10769** 0.30 1  
21,00€ Kg if

RESSORT POUR  
REF. 50818

**10770** 0.05 50  
6,00€ Kg if

## CRIC ROULEUR 2T SPÉCIAL VOITURES BASSES

**50816** 88,00€

208mm 508mm 125mm

11.25 - 1 63  
Kg SUB if

340mm  
90mm  
**2T**



PISTON RECHANGE  
POUR REF. 50816

**14708** 10  
59,00€ if

## CRIC ROULEUR 2T

**53968** 49,00€

205mm 490mm 140mm

5.80 - 1 90  
Kg SUB if

300mm  
130mm  
**2T**



EN 1494:2001



## CRIC ROULEUR 2T

**50815** 88,00€

205mm 490mm 140mm

10.75 - 1 56  
Kg SUB if

355mm  
130mm  
**2T**



PISTON RECHANGE  
POUR REF. 50815

**11939** 6.00 5  
63,00€ Kg if

## DANS MALLETTE PLASTIQUE

**51895** 99,00€

205mm 490mm 140mm

11.68 - 1 42  
Kg SUB if

355mm  
130mm  
**2T**



PISTON RECHANGE  
POUR REF. 51895

**11939** 6.00 5  
63,00€ Kg if

## CRIC BOUTEILLE 20T

**50823** 94,00€

10,18 - 2 96  
Kg SUB ITT

↑ 452mm  
↓ 242mm

20T

CE



## CRIC BOUTEILLE 20T VOITURES BASSES

**50824** 88,00€

8,47 - 2 120  
Kg SUB ITT

↑ 335mm  
↓ 190mm

20T

CE



## CRIC BOUTEILLE 30T

**50825** 154,00€

7,62 - 2 96  
Kg SUB ITT

↑ 465mm  
↓ 285mm

30T

CE



## CRIC BOUTEILLE 2 - 15T

**50819** 28,00€

2,42 - 6 330  
Kg SUB ITT

↑ 345mm  
↓ 181mm

2T

**50822** 59,00€

5,60 - 4 160  
Kg SUB ITT

460mm  
↓ 230mm

10T

**50820** 34,50€

3,20 - 6 300  
Kg SUB ITT

↑ 372mm  
↓ 194mm

3T

**52304** 84,00€

7,20 - 2 136  
Kg SUB ITT

↑ 365mm  
↓ 225mm

15T

CE



**50821** 47,00€

4,10 - 5 200  
Kg SUB ITT

↑ 413mm  
↓ 216mm

5T

## CRIC BOUTEILLE DANS MALETTE PLASTIQUE

**51905** 34,50€

2,90 - 6 144  
Kg SUB ITT

↑ 340mm  
↓ 185mm

2T

**51906** 39,00€

3,53 - 4 144  
Kg SUB ITT

↑ 385mm  
↓ 195mm

3T

**51907** 48,00€

4,59 - 4 128  
Kg SUB ITT

↑ 450mm  
↓ 215mm

5T



CE

## CRIC À CRÉMAILLÈRE 3T

**53895** 107,00€

9,15 - 1 42  
Kg SUB ITT

↑ 330mm  
↓ 130mm

↑ 510mm  
265mm  
140mm

**53896** 127,00€

11,60 - 1 28  
Kg SUB ITT

↑ 645mm  
↓ 130mm

↑ 840mm  
265mm  
140mm

**53897** 140,00€

13,85 - 1 21  
Kg SUB ITT

↑ 1045mm  
↓ 130mm

↑ 1220mm  
265mm  
140mm

**53898** 148,00€

15,65 - 1 21  
Kg SUB ITT

↑ 1320mm  
↓ 130mm

↑ 1520mm  
265mm  
140mm

- Material: acero 45



CE

### DISPOSITIF POUR SOULÈVER PAR ROUE

**15096** 2,00 10 560  
40,00€ Kg SUB ITT

↑ 340mm  
87mm  
142mm

Conçu pour soulever la voiture directement par la roue lorsqu'une hauteur de levage élevée est requise.

### FIXATEUR DE POIGNÉE

**15095** 0,10 50  
13,00€ Kg SUB ITT

↑ 125mm  
62mm  
16mm

Conçu pour fixer la poignée du cric pendant le transport.

### PIVOT DE SUPPORT DE ROUE

**15093** 3,65 1 50  
38,00€ Kg SUB ITT

↑ 175mm  
175mm  
158mm

Conçu pour fixer solidement le cric à crémaillère à la fixation extérieure de roue de secours 4x4 lors de la conduite hors route. Convient à la plupart des véhicules grâce à la base réglable.

### CALE DE CRIC

**15094** 1,35 5 140  
39,50€ Kg SUB ITT

↑ 293mm  
293mm  
10mm

Conçu pour assurer la stabilité et empêcher le cric de couler sur un sol meuble en augmentant la zone de support.

## JEU DE CHANDELLES À CREMAILLÈRE

**53779** 36,00€

5,05 - 1 72  
Kg SUB if

195mm 205mm

↑ 430mm  
↓ 290mm **3T** **2 PCS**



**53845** 64,00€

9,35 - 1 30  
Kg SUB if

230mm 260mm

↑ 610mm  
↓ 370mm **6T** **2 PCS**



**54143** 249,00€

35,50 - 1 12  
Kg SUB if

↑ 500mm  
↓ 700mm **12T** **2 PCS**



## CRIC EN CISEAUX

**53218** 26,00€

2,25 - 6 216  
Kg SUB if

**1,5T** ↑ 370mm  
↓ 90mm



- Apte pour tout modèle de voiture.

## CHANDELLES ALUMINIUM

**53200** 69,00€

4,70 - 1 72  
Kg SUB if



↑ 385mm  
↓ 245mm **3T**



**54144** 298,00€

28,00 - 1 18  
Kg SUB if

↑ 338mm  
↓ 500mm **22T** **2 PCS** **CE**



**54145** 377,00€

1,80 - 1 4  
Kg SUB if

↑ 482mm  
↓ 775mm **10T** **2 PCS** **CE**



**54146** 492,00€

2,00 - 1 4  
Kg SUB if

↑ 736mm  
↓ 1212mm **10T** **2 PCS** **CE**

## SUPPORT ÉLEVATEUR 1,8 T

**54147** 198,00€

0,80 - 1 6  
Kg SUB if

↑ 1200mm  
↓ 2146mm **1,8T**

**1 PCS**



## VÉRIN DE FOSSE

**54001** 285,00€

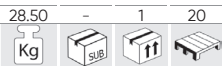

↑1.900mm  
↓1.100mm

900mm

**500**  
KG **CE**

- Plage de levage de 116 à 197 cm.

- Permet de souLÈVEr et de déplacer des boîtes de vitesses, des différentiels, des réservoirs, etc. de façon sûre et stable.

- Support double position.

- Élévation confortable et rapide avec pédale.

- Soupape avec ressort pour descente contrôlée.

### JEU DE 4 ROUES

**15526** 3,00 25  
48,00€ Kg

### PISTON RECHANGE

**15527** 15,00 -  
276,00€ Kg

### SUPPORT DOUBLE POSITION

**15528** 1,95 -  
39,00€ Kg

2 POSTES



AVEC SOUPAPE  
DE SÉCURITÉ

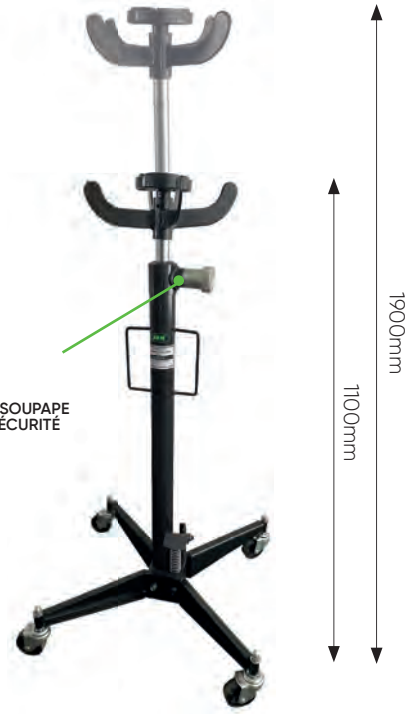

## VÉRIN DE FOSSE

**50830** 560,00€

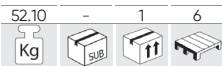

- Avec poignée.  
- Rapide.  
- Double piston.

**500**  
KG

↑1.740mm  
↓850mm

**CE**



SUPPORT DOUBLE POSITION  
POUR 50830

**14929** 1,95 10  
35,00€ Kg

Pratique pour stocker les  
outils achetés séparé-  
ment.

PISTON RECHANGE  
POUR REF. 50830

**12046** 28,50 -  
385,00€ Kg

SABOT POUR RÉF. 50830

**10962** 10,60 -  
85,00€ Kg

## POMPE HYDRAULIQUE À MAIN

**54257** 318,00€



Pression de travail :  
Étape 1 : 0 à 20 kg/cm<sup>3</sup>  
Étape 2 : 20 à 700 kg/cm<sup>3</sup>

Flux :  
Étape 1 : 13cc  
Étape 2 : 2.3cc



3'8"  
NPT

1,8m

**1000**  
PSI

**CE**



## CHARIOT PORTE ROUES

51901 999,00€

75,00	-	1	10

- Longueur: 1040 mm
- Largeur: 1090 mm
- Hauteur: 890 mm
- Plage de levage: 50 à 100 mm
- Diamètre max. de roue: 1320 mm

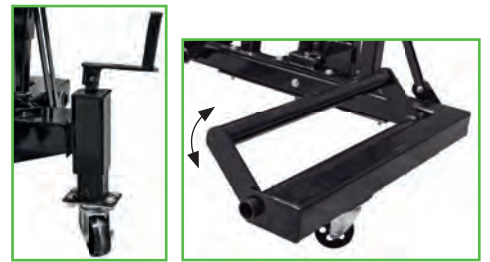

## CHARIOT PORTE ROUE HYDRAULIQUE SPECIAL ROUE TRACTEURS

52241 1.690,00€

139,00	-	1	5

- Capacité de charge: 1,5 T
- Plage de levage: 0 à 770mm
- Longueur d'encombrement: 1270mm
- Largeur d'encombrement: 990mm
- Hauteur d'encombrement: 1340mm
- Diamètre maximal des roues: 2200mm (86")
- Diamètre minimal des roues: 1000mm (39")
- Largeur maximale des roues: 800mm



LA CONCEPTION FOURNIT UN CROCHET SUPÉRIEUR POUR LA STABILISATION PENDANT LE TRANSPORT



LES ROUES NE LAISSENT PAS DE TRACES SUR LA SURFACE GRÂCE À L'UTILISATION D'UN REVÊTEMENT PU RÉSISTANT À L'USURE



## CINTREUSE HYDRAULIQUE

50835 290,00€

35,50	-	1	14

CONÇU POUR L'UTILISER EN HORIZONTAL OU VERTICALE

- Permet de plier des tubes de 2"(50mm).
- Conçu pour l'installation et fabrication de tuyaux.
- Coins ajustable.
- Pression d'air 0,75 - 0,75mpa.
- Taille coins: 1/2", 3/4", 1", 1-1/4", 1-1/2", 2".

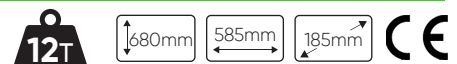

PISTON

13870	6,70	1
82,00€		

JEU DE 6 ÉTAMPES FLEXIBLES

15255	8,75	1
114,00€		

## PRESSE HYDRAULIQUE SUR PIEDS DE 30T.

**53684** 1.880,00€

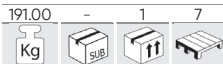

- Capacité (T): 30.
- Hauteur (mm): 1560.
- Plaque de travail (mm): 166x1018.
- Largeur de la base (mm): 540.

**30T** CE

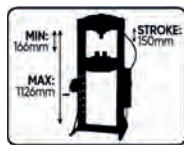

ACTION-  
NEMENT  
MANUEL ET  
AU PIED



TREUIL À MAIN POUR RÉGLER  
LA HAUTEUR DE LA TABLE DE  
PRESSE

## GRILLE DE PROTECTION

**14616** 96,00€

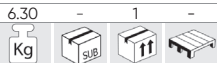

PISTON

**15044**  
259,00€

LEVIER

**15048**  
5,00€

MANOMÈTRE

**15046**  
47,00€

GRILLE DE PRO-  
TECTION

**14616**  
96,00€

MANOMÈTRE

**15047**  
47,00€

PISTON

**15043**  
195,00€

LEVIER

**15048**  
5,00€

POMPE

**14639**  
195,00€

## PRESSE HYDRAULIQUE SUR PIEDS DE 20T.

**53590** 1.190,00€

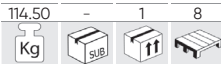

- Capacité (T): 20.
- Trait (mm): 145.
- Plaque de travail (mm): 58-1018.
- Largeur de la base (mm): 540.
- Largeur intérieure (mm): 536.
- Course latérale (mm): 180.

**20T** CE

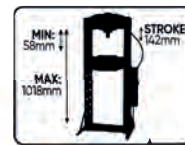

PISTON À  
DÉPLACEMENT  
HORIZONTAL



2 VITESSES

## SUPPORT POUR PRESSES

**52999** 168,00€

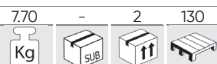

GRAND BLOC



TAILLE BLOC



**30T**  
CE

## GRUE 2T PLIANTE

**50831** 460,00€



Hauteur de levage:  
1'80m (2T) - 2,19m (½T)  
- Dimensions pliée:  
800 x 680 x 1.600mm.  
- Capacité de levage:  
Position 1: 2T - 80mm.  
Position 2: 1½T - 255mm.  
Position 3: 1T - 425mm.  
Position 4: ½T - 610mm.

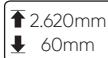

## GRUE 1T PLIANTE

**52985** 598,00€

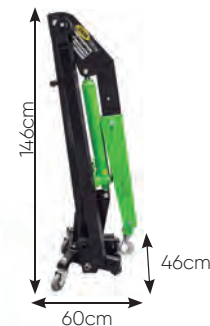

ROUES PIVOTANTES  
POUR REF. 50831



PISTON RECHANGE  
POUR REF. 50831



JEU DE VIS  
POUR REF. 50831



PISTONS DE RECHAN-  
GE POUR 52985



BAGUE D'ÉTANCHÉITÉ POUR  
PISTON - REF. 52985



## ÉQUILIBREUR DE CHARGE

**50631** 68,00€



GRUE NON COMPRISE.



## COMPRESSEUR DE RESSORTS

**50827** 387,00€



- Capacité : 1T (2200 lbs)  
- Diamètre du ressort comprimé : 200 mm  
- Longueur de compression : 200-500mm



## CHARIOT EN ACIER

**54262** 88,00€



**54263** 130,00€



**54264** 240,00€



	54262	54263	54264
Hauteur de levage	2,8M	2,8M	2,8M
Chutes de chaînes	1	2	2
Mesures de la chaîne	Chaîne de charge: 6x30mm	Chaîne de charge: 6x30mm	Chaîne de charge: 6x30mm
	Chaîne manuelle: 4,5x25mm	Chaîne manuelle: 4,5x25mm	Chaîne manuelle: 4,5x25mm
	Chaîne de charge: 3m	Chaîne de charge: 3m	Chaîne de charge: 3m
Longueur	Chaîne manuelle: 2,5m	Chaîne manuelle: 2,5m	Chaîne manuelle: 2,5m
	Chaîne de charge: 3m	Chaîne de charge: 3m	Chaîne de charge: 3m
Effort pour une charge maximale	304N	310N	361N
Matériel	Chaîne de charge: Acier 20Mn2	Chaîne de charge: Acier 20Mn2	Chaîne de charge: Acier 20Mn2
	Chaîne manuelle: Acier Q235	Chaîne manuelle: Acier Q235	Chaîne manuelle: Acier Q235

## TRAVERSE SUPPORT MOTEUR

**50840** 138,00€

20,45	-	1	40
Kg	sub	ff	

1750mm

500  
KG

CE

**53682** 98,00€

15,45	-	1	36
Kg	sub	ff	

1480mm

500  
KG

CE



ATTELAGE ET  
MANIVELLE POUR  
REF.50840

**51452**  
69,00€

3,43	1
Kg	ff

## TRAVERSE SUPPORT MOTEUR UNIVERSEL

**52055** 129,00€

10,00	-	1	55
Kg	sub	ff	

- Convient à tous types de voitures et de camionnettes.
- Idéal pour changer la courroie de distribution ou de sangles auxiliaire, remplacement ou la modification de l'inclinaison de la courroie avant.
- Épargne avec un unique outil on peut effectuer des tâches réalisables uniquement avec des outils spécifiques.
- Simple. Installations rapide avec seulement la nécessité d'un travailleur.
- Pièce perpendiculaire avec angle de rotation et réglable à n'importe quelle hauteur de la barre longitudinale.
- Mise en place et accès par partie inférieure.
- Crochets réglables en hauteur, rotation des crochets de 360°.



500  
KG

CE



## SUPPORT MOTEUR

**50836** 148,00€

18,15	-	1	36
Kg	sub	ff	

850mm

900mm

800mm

340  
KG



**50838** 299,00€

43,90	-	1	7
Kg	sub	ff	

900mm

1100mm

900mm

900  
KG

CE



- Dimensions pliée: 100 x 50 x 44cm.

## LÈVE MOTOCROSS

**53969** 96,00€

6,00	-	1	32
Kg	sub	ff	

328mm

293mm

400mm  
300mm

150  
KG

CE



## LEVAGE AUXILIAIRE POUR MOTO

**52692** 129,00€

13,20	-	1	44
Kg	sub	ff	

400mm  
95mm

500  
KG

CE

- Actionnement avec douille de 21mm.



## TABLE ÉLÉVATRICE 360KG

53246 1.144,00€

104.00 - 1 4  
Kg SUB

↑ 1.350mm  
↓ 370mm

360  
KG

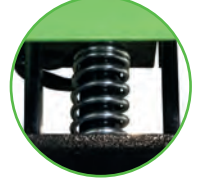

## TABLE ÉLÉVATRICE

50630 590,00€

63.00 - 1 4  
Kg SUB

↑ 480mm

840mm

↑ 780mm  
↓ 290mm

400  
KG

CE

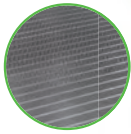

## TABLE ÉLÉVATRICE HYDRAULIQUE POUR MOTO

50911 788,00€

135.00 - 1 5  
Kg SUB

↑ 780mm  
↓ 205mm

365  
KG

CE



PISTON RECHANGE  
POUR REF. 50630

10993 8.80 1  
117,00€ Kg

ESSIEU RECHANGE  
TABLE ÉLÉVATRICE  
POUR REF. 50630

11950 0.03  
18,00€ Kg

JEU DE 2 ROUES AVEC  
FREIN POUR 50911

14706 0.00 -  
8,90€ Kg

PISTON RECHANGE  
POUR REF. 50911

14727 7.10 1  
108,00€ Kg

## LÈVE MOTO HYDRAULIQUE

51750 299,00€

31.00 - 1 12  
Kg SUB

↑ 500mm

450mm

340mm

↑ 890mm  
↓ 340mm

135  
KG

CE



## CRIC ÉLÉVATION QUAD

53423 199,00€

29.40 - 1 24  
Kg SUB

↑ 790mm

370mm

330mm

680  
KG

CE

NYLON  
↑ 368mm  
↓ 118mm



LEVIER  
DE  
LEVAGE

PISTON RECHANGE  
POUR REF. 53423

14291 4.60 3  
87,00€ Kg

ROUES DE NYLON

## SET 2 RAMPES ÉLÉVATRICES 1T

52845 170,00€

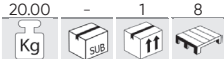

- Utile pour présenter les véhicules d'exposition, ainsi que pour réaliser des travaux de maintenance dans la partie inférieure du véhicule.

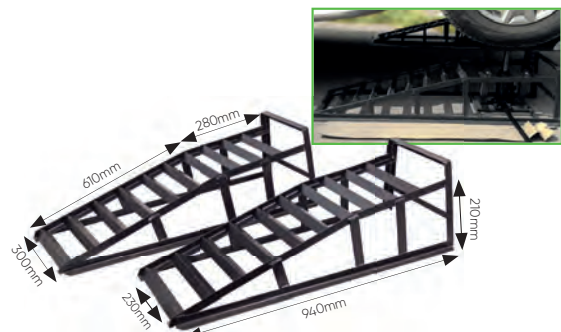

## CHARIOT MANUTENTION VÉHICULE 680Kg

50839 180,00€



- Longueur plastique noir des extrémités: 300mm.  
- Longueur avec roues: 600mm.



PISTON POUR REF. 50839



ROUER POUR REF. 50839



## TRANSPALETTE LEVA-GE RAPIDE

53880 598,00€

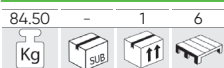

- Capacité de charge: 2500kg  
- Longueur du poussoir: 1150mm  
- Poignée: Carrée, caoutchoutée  
- Roue de direction (rotative): PU (200x50mm)  
- Roue fixe: Double, PU (80x70 mm)  
- Hauteur min. des fourches: 85mm  
- Hauteur max. des fourches: 200mm  
- Nombre de parcours du piston de pompe: 8



JEU DE 2 GOUPILLES POUR AXE DE POIGNÉE



À ACTION RAPIDE (ACIER COULÉ)

ROULEAU DE FOURCHE



ROUE DE DIRECTION



UNITÉ HYDRAULIQUE



270

JBM www.jbmfrance.fr

## BÉQUILLE MOTO

AVANT

52514 84,00€



CROCHET SUPPORT MOTO

PLATES (x2)

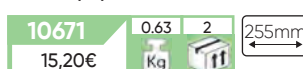

ARRIÈRE

51751 99,00€

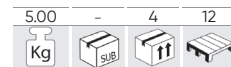

RONDES (x2)



## CHARIOT CARROSSERIE

50923 454,00€

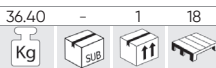

- Séparation: 0 à 110cm.

ROUER POUR REF. 50923

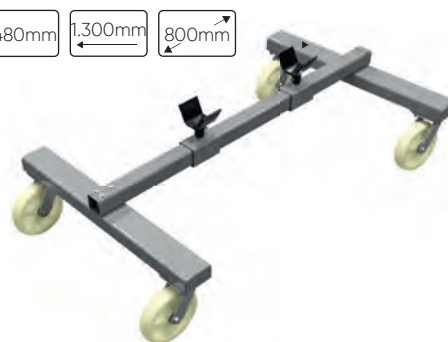

## JEU DE 4 COUSSINS DE LEVAGE TESLA

54175 34,00€



NR GAUCHO RUBBER

TESLA 3/X/S/Y



## TRANSPALETTE ÉLECTRIQUE

53777 4.352,00€



CONCEPTION INNOVANTE  
- Unité hydraulique étanche  
- Entretien facile  
- Faible niveau de bruit clés x2  
ROUES PU / PV



TVA non comprise



## **OUTILLAGE ÉLECTRIQUE**

- 272 BOOSTER DE VÉHICULE
- 273 CHARGEURS / TESTEUR DE BATTERIE
- 274 AMPÈREMÈTRE
- 275 THERMOMÈTRE
- 276 ENDOSCOPE
- 277 SOUDEURS
- 278 MEULEUSE DE TABLE
- 279 NETTOYEURS DE PIÈCES
- 280 ASPIRATEURS
- 281 RÉCHAUFFEURS / TONDEUSE ROBOT
- 282 NETTOYEUR HAUTE PRESSION
- 283 ENROULEUR DE CÂBLE ÉLECTRIQUE
- 284 VENTILATEURS

## CABLES DE DÉMARRAGE

### PINCE MASSIVE EN LAITON

REF.	Ø CORD + COVER	LONGUE	A	SECTION	Kg			€
51238	17mm	5m	700	70mm <sup>2</sup>	4.95	2	84	138,00€
51239	15mm	7m	700	70mm <sup>2</sup>	5.90	2	72	159,00€



### PINCE EN LAITON

REF.	Ø CORD + COVER	LONGUE	A	SECTION	Kg			€
52069	11mm	2,5m	250	25mm <sup>2</sup>	1.55	10	240	29,50€
52070	12mm	3m	350	35mm <sup>2</sup>	1.95	5	160	40,00€
52071	13mm	3m	500	50mm <sup>2</sup>	2.35	5	90	47,00€



### PINCE MASSIVE EN LAITON AVEC PROTECTEUR SURCHARGE

REF.	Ø CORD + COVER	LONGUE	A	SECTION	Kg			€
51363	12mm	3m	350	35mm <sup>2</sup>	2.63	5	120	114,00€
51365	12mm	3m	600	50mm <sup>2</sup>	3.10	5	90	118,00€



### COLLIERS DE CÂBLE DE DÉMARRAGE EN CUIVRE

14145	0.20	30
8,50€	Kg	



### PINCES EN LAITON

14147	0.35	15
25,00€	Kg	



### COLLIERS DE CÂBLE DE DÉMARRAGE EN CUIVRE

14146	0.20	30
8,00€	Kg	



### PINCES EN LAITON

14148	0.35	15
25,00€	Kg	



### SET DE 2 PINCES CROCODILES

53357	0.01	6	24
7,00€	Kg		



2 PCS 30 AMP

## DÉMARREUR DE VÉHICULES

53687 298,00€

11.35	-	1	14
Kg			

12V 9,5kg

- **Voltage:** 12V.
- **Batterie:** 22Ah batterie de plomo-acide AGM (1PC).
- **Corrente de arranque:** 750A.
- **Corrente máxima:** 1500A.

53688 495,00€

18.05	-	1	14
Kg			

12V 24V 16,3kg

- **Tension:** 12V/24V.
- **Batterie:** 22Ah plomb-acide AGM (2 pièces).
- **Courant de démarrage/de crête:** 12V: 1500A/3000A. 24V: 750A/1500A.
- **Temps de charge de la batterie:** Charge complète de la batterie: 40 h. Charge jusqu'à 10-20%: 6 h.



PINCES



12V DC 15A

230V 50Hz 12V 1A

6-40H

370mm 392mm 209mm



Bouton de vérification de la tension de la batterie interne

Mesureur de tension de batterie interne

Interrupteur allumé / éteint

Prise de charge

ÉCLAIRAGE LED INTÉGRÉ: AUGMENTE LA VISIBILITÉ DE LA ZONE DE TRAVAIL

### PIÈCES DE RECHANGE

REF.	DÉSCRIPTION	Kg		€
14755	Batterie 22 A·h pour réf. 53687, 53688	6,50	2	134,00€
14756	Circuit imprimé pour réf. 53687	0,05	10	15,20€
14757	Circuit imprimé pour réf. 53688	0,05	10	15,20€
14758	Câble de démarrage rouge avec pince d'extrémité pour réf. 53687	0,40	10	18,00€
14759	Câble de démarrage noir avec pince d'extrémité pour réf. 53688	0,40	10	18,00€
15782	Câble de démarrage noir avec pince d'extrémité pour réf. 53687	0,30	10	16,00€
15781	Câble de démarrage rouge avec pince d'extrémité pour réf. 53688	0,30	10	19,84€

Câble de démarrage noir pour charger la batterie avec pince d'extrémité pour réf. 53687

53688



14757

15781



14759



53687



14756

14758



15782



14755



53688 53687



## MAINTIEN DE TENSION POUR CHANGEMENT DE BATTERIES

52884 73,00€

0,25	5	20	360
Kg	Sub	ff	



235mm ± 20mm

2,070mm ± 20mm

- Utile pour se tenir au courant dans le système électrique du véhicule pendant le changement de la batterie.
- Connexion par Cable OBDII ou l'allume-cigare.

## CHARGEURS DE BATTERIE

6/12V

53927 66,00€

0,65	5	20	240
Kg	Sub	ff	



12/24V

53929 95,00€

0,90	5	20	240
Kg	Sub	ff	

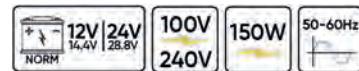

COMPATIBLE AVEC LES TYPES BATTERIES PLOMB-ACIDE: LIQUIDE, HÉLIUM, MF ET AGM

## MESUREUR DE RÉSISTANCE D'ISOLATION

54114 248,00€

1,48	-	10	100
Kg	Sub	ff	

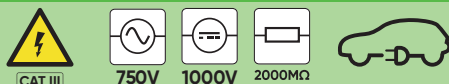

Cet instrument vous permet de mesurer l'isolation électrique à une tension déterminée (250 V, 500 V ou 1000 V). C'est un outil indispensable pour évaluer l'intégrité d'un circuit électrique, il est particulièrement utile pour vérifier que les composants et l'installation dans les voitures électriques sont complètement isolés de la carrosserie. Dans les installations industrielles, c'est l'outil qui permet d'effectuer des inspections périodiques de la résistance de l'isolation. Mesures requises pour la norme DIN VDE 0105-100 (VDE 0105-100):2009-10.



## TESTEUR DE BATTERIE NUMERIQUE DIGITAL

51816 49,00€

0,30	6	48	576
Kg	Sub	ff	

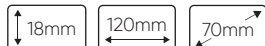

- 150Ah.
- Applicable à des batteries de 12 V.
- Mesure en SAE (CCA), EN, IEC, DIN, CA.
- Plage : 200~1200 CAA (SAE).
- Mesureur de volt : 7 V~15 V.
- Écran 4 + 3 Leds (vert, rouge, jaune).



## TESTEUR DE BATTERIE

51235 49,00€

1,25	-	10	150
Kg	Sub	ff	

- Pour des batteries de 6 V et 12 V.
- Charge jusqu'à 100 Ah.
- Test d'état de charge.
- Test de consommation de démarrage.
- Test de tension de charge.
- Test condition de la batterie.



## TESTEUR DE BATTERIE ET ALTERNATEURS AVEC IMPRIMANTE

52233 328,00€

2,32	-	6	72
Kg	Sub	ff	

- Applicable à des batteries de 6V et 12V.
- Système de charge en allumage de 12V et 24V.
- Rang: 40 - 2000 CCA (SAE).

- Voltmètre: 1.5V - 30V.
- Jeu de Cables de 180cm.

- Contient: Pile 6x1.5AA.
- 1 rouleau papier thermique.



AVEC IMPRIMANTE

AGM, GEL, VRLA, SLI

## HYDROMÈTRE POUR BATTERIES

53209 8,50€

0,14	24	96	768
Kg	Sub	ff	

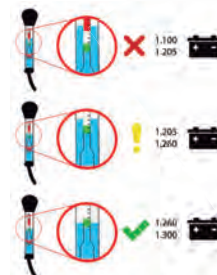

PAPIER THERMIQUE 57mmx60mm

51842 6,90€

0,10	6	72
Kg	Sub	ff

TVA non comprise

# TESTEUR DE BATTERIE ET ALTERNATEURS AVEC IMPRIMANTE

**54040** 240,00€

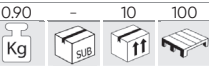

- Applicable aux batteries 12 V, AGM (tapis de verre absorbant), GEL (gel), VRLA (plomb-acide scellé), SLI (à électrolyte liquide).
- Plage de fonctionnement : 100 à 2 000 ampères de démarrage à froid CCA (SAE)
- Langues du système disponibles : espagnol (ES), anglais (EN), français (FR), allemand (DE), italien (IT), portugais (PT), roumain (RO).
- Applicable aux systèmes de démarrage 12/24 V.
- Applicable aux batteries 12 V, AGM (tapis de verre absorbant), GEL (gel), VRLA (plomb-acide scellé), SLI (à électrolyte liquide).
- Testeur de démarreur et d'alternateur.

\* Une batterie CR2032 est incluse

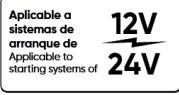
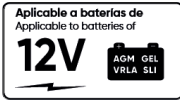

100 - 2000 CCA (SAE)



AVEC IMPRIMANTE

# PINCE AMPÈREMÉTRIQUE

**52382** 19,50€

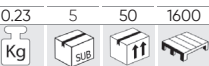

- FONCTIONS: Test du fil en direct.

- Instrument idéal pour les électriciens.
- Il peut mesurer la tension: AC, DC, courant AC, résistance, diode, fréquence.
- Environnement d'exploitation: 0°C à 40°C, a <80%RH.
- Environnement de stockage: -10°C à 40°C, a <85%RH.

**52952** 74,00€

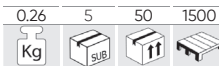

- FONCTIONS: Test du fil en direct. Test de diode. Test de continuité. Fonction ADP. Fonction de détection de phase. Commutateur ZERO.

	52382	52952
DCB	600V	20V, 600V
ACB	600V	600V
DCA		200A
ACA	20A, 200A, 600A	200A
OHM	2KΩ, 200KΩ, 2MΩ	2000Ω



52382



52952

167mm

55mm

22mm

# MULTIMÈTRE DIGITAL

**50942** 28,00€

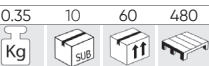

- Digits: 3 1/2.
- Mesure: 2.000.
- Données instantanées.

- Auto déconnexion.
- Indicateur de batterie.
- Batteries de 9 V.
- Sonde de température.
- Température de -40°C à 1000°C.



AVEC PROTECTEUR LATERAL



<b>V</b> AC	200mV, 2V, 20V, 200V, 1000V	<b>A</b> AC	20mA, 200mA, 20A
<b>V</b> DC	200mV, 2V, 20V, 200V, 750V	<b>A</b> DC	20mA, 200mA, 20A
<b>Ω</b>	200Ω, 2KΩ, 20KΩ, 200KΩ, 2MΩ, 20MΩ, 2000MΩ		
<b>F</b>	2nF, 20nF, 200nF, 2μF, 20μF, 200μF		



# COFFRET DE CONNECTEURS ET APPAREILS DE DIAGNOSTIQUES POUR REF. 50942

**52439** 227,00€

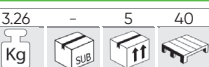

- 2 mesureurs de résistance variable.
- 2 lumières led de vérification.
- 2 SRS substitution et des dispositifs de test.
- 2 pinces de cocodrile.
- 2 prises de raccord rapide.
- 4 sondes.
- 24 connecteurs forme ronde.
- 48 connecteurs forme plate.



## JEU D'ACCESSOIRES POUR MULTIMETRE

52231 49,00€

0,41	5	20	240
Kg	Sub	ff	ff

- Ce kit est approprié pour la plupart des multimètres.

- Contenu:
- 2 sondes.
- 2 pinces petites
- 2 pinces longues.
- Câbles d'extension.



## PROTECTEUR DE SURTENSION AUTOMATIQUE

54256 48,00€

0,45	-	20	800
Kg	Sub	ff	ff

12V  
24V

35V

800 AMP

1500W



## TESTEUR POUR CIRCUIT AUTOMOBILE

53028 5,80€

0,70	10	120	1440
Kg	Sub	ff	ff

6-12-24V

1,8 x 190mm



- Convient pour vérifier la polarité

53029 6,80€

0,08	12	240	2400
Kg	Sub	ff	ff

6-12-24V

2 x 115mm



53030 12,00€

0,17	6	60	720
Kg	Sub	ff	ff

6-12-24V

LED

3 x 142mm



## THERMOMETRE LASER

52162 38,00€

-50° A 550°C

0,17	6	72	576
Kg	Sub	ff	ff

- Rang de mesure: -50° à 550 °C (58° F à 1022° F).
- Précision: ± 2° C / ± 2%.
- Option de rétroéclairage.
- Pointeur laser pour une mesure objet précis.
- Mesure en °C / °F.
- Emissivité: Réglable (0,1-1,0).
- Temps de réponse: ≤ 0,8 s
- Possibilité de mesurer le blocage.
- DC pile 9V.
- Indicateur de batterie faible.

LASER 9V

-50°C-550°C  
-58°F-1022°F  
± 2°C / ± 2%



52450 105,00€

-50° A 1.000°C

0,72	5	20	200
Kg	Sub	ff	ff

- Thermomètre infrarouge.
- Lecture de: -50°C ~1000°C / -58°F ~ 1.832°F.
- Tolerance+/-1,5°C.

- Fonctions:
- Pointeur laser pour une mesure précise.
- Alarme de température maximale o minimale.
- Lecture en °C / °F.
- Fonction de memoire de résultat.
- Indicateur de batterie faible.

MAX: 1000°C  
MIN: -50°C

LASER 9V

-50°C-1.000°C  
-58°F-1.832°F  
± 1,5°C

9V 4/22 Including Included



## THERMOMETRE NUMERIQUE DE CONTACT

53503 12,00€

0,05	20	100	2400
Kg	Sub	ff	ff

1.5V x1

-50°C-330°C  
-58°F-572°F  
± 1°C (0,2°F)  
(-20°C-80°C)



## TESTEUR LIQUIDE DE FREIN

51839 24,00€

0,05	25	100	2400
Kg	Sub	ff	ff

- Fonctionne avec des piles 1xAAA LR03.
- Avec 4 niveaux de qualité mesurables de 0% à 4%.



## VIDÉOSCOPE WIFI

53724 46,00€

0,15 - 50 800  
Kg SUB if

720p  
20FPS HD



- Endoscope avec fonction de transfert d'image par Wi-Fi. Possibilité de se connecter à n'importe quel smartphone. Possibilité de travailler avec une tablette ou un ordinateur.

- Le lot de livraison comprend:

**Caméra endoscopique.**  
**Émetteur Wi-Fi.**  
**Buse crochet.**  
**Buse aimant.**  
**Buse rétroviseur.**



2560x1920  
1280x720  
640x480

SMP

- Résolution: 2560x1920 / 1280x720 (720p 16:9) / 640x480 (480p 4:3).  
- 20fps.  
- 5 mégapixels.  
- Angle de vision: 70 degrés.  
- Diamètre: 5,5mm.  
- Distance focale: 4-6cm.  
- Résistant à l'eau IP67 (jusqu'à 1 mètre).  
- Batterie au lithium 2.600mAh.

CÂBLE SEMI-RIGIDE DE 1M

Ø 5,5MM



FONCTIONNE AVEC JBM APP:



App Store  
Google Play



## VIDÉOSCOPE CABLE 1m

52436 680,00€

2,41 - 5 40  
Kg SUB if



- Alimentation: DC5  
- Ecran 3,5TFT 320x240px.  
- Interface: MINI USB 1.1/V.  
- Batterie: Li-Polymer 3.7V.  
- Adaptateur: 100-240V.  
- Sortie AC 5VDC.  
- Video NTSC&PAL.  
- Stockage: CARD SD (jusqu'à 32Gb).  
- Compression: JPG.  
- Enregistrement: MPEG4 (640x480).  
- Température de fonctionnement: -20°C - 60°C.  
- Température de stockage: 0°C - 40°C.  
- Diam. cable: 5 mm.  
- Functions: la sortie vidéo, 6 langues, auto-off, photos, vidéos, date/heure.



ÉCRAN EN COULEURS

1M

RECHARGE POINTE POUR VIDÉOSCOPE

11992 0,01 20  
65,00€ Kg if

CABLE 3m

11219 0,32 1  
659,00€ Kg if

CABLE 1m

11329 0,22 1  
564,00€ Kg if

## DÉTECTEUR DE LA FUITE DE GAZ

53484 615,00€

4,70 - 4 32  
Kg SUB if

12V 6 L/m 15Psi



- HUILE NON COMPRISE.

275mm 220mm 235mm



LIQUIDE 500ML POUR REF. 53484

14081 0,50 48 960  
12,60€ Kg if

TUYAU DE RECHARGE POUR 53484

14109 0,01 20  
29,00€ Kg if

POMPE DE GONFLAGE POUR 53484

14110 0,20 20  
110,00€ Kg if



Comprend:



## PISTOLET À COLLE

51831 24,00€

0,35 12 36 288  
Kg SUB if

- Voltage: 100~ 230 V.  
- Température: 190~230 °C.  
- Consommation: 60~150 W.  
- Diâm. de bec: 2,0~2,3 mm.  
- Plage: de 8 à 16g de produit/minute.



BÂTONNETS DE COLLE

51859 0,12 8 32 1520  
3,80€ Kg SUB if

- Ø 8mm.  
- Cole rapidement tous les types de matériaux flexibles.  
- Temps de séchage: 20".

CE

# FER À SOUDER ÉLECTRIQUE

**53977** 17,50€

0,30	12	48	576
Kg	Sub	Box	Tray

- Tension 220 à 240 V
- 40 W
- Fréquence: 50Hz
- Longueur: 240mm
- Câble: 1,3 m
- Température maximale de travail : 450° +/- 10%



**53111** 19,00€

0,30	5	25	625
Kg	Sub	Box	Tray

- Voltage: 220-240V.
- Temp: 420°C + / - 10%.
- Long: 250mm.
- Cable: 1,5m.



## SOUDAGE INVERTER MMA

**53981** 143,00€

**100A DC**

3,35	-	1	90
Kg	Sub	Box	Tray

- Peut être utilisé pour souder des pièces en acier et en fer avec tous types d'électrodes acides et alcalines.
- Outil compact, léger et économe en énergie.
- Haute qualité d'amorçage de l'arc et puissance de l'arc, arc stable et faibles projections.
- Soudure de haute qualité, profondeur de pénétration élevée.
- Protection automatique contre les surtensions, les surintensités et les surchauffes.
- La technologie IGBT améliore considérablement la fiabilité de l'appareil.
- Elle fournit une égalisation automatique lorsque la tension d'entrée fluctue.



- ✓ ONDULEUR AVEC TECHNOLOGIE IGBT
- ✓ SOUDAGE À L'ARC MANUEL AVEC COURANT CONTINU
- ✓ PROTECTION CONTRE LES BRÛLURES
- ✓ PUISSANCE DE L'ARC
- ✓ AMORÇAGE DE L'ARC CHAUD

- Comprend: Porte-électrode avec câble de 2m. Pince de mise à la terre avec câble de 1,5m. Brosse marteau. Écran facial manuel.

1ph AC 230V	50Hz	3.7 KVA Potencia Absorbida Rated Input Power	16A Intensidad nominal máx. Max. Input Current	65V Tensión al vacío No-load Voltage
100A 24V	10-100A Intensidad de salida Output Range	0.7 Factor de potencia Power Factor	IP21S Clase protección Protection Class	F Clase aislamiento Insulation Class



RECHANGES POUR REF. 51837

REF.	DÉSCRIPTION	€
15237	porte-électrode avec câble de 2m	12,00€
15238	Brosse pour marteau de soudeur	5,00€
15239	Écran facial manuel	5,50€
15240	Pince de mise à la terre avec câble de 1,5 m	9,50€
15241	Panneau de commutation	65,00€
15242	Accouplement à dégagement rapide (négatif/positif)	2,50€
15243	Ventilateur	4,00€
15244	Commutateur d'alimentation	2,00€

**53982** 219,00€

**160A DC**

6,10	-	1	33
Kg	Sub	Box	Tray

- Largement utilisé pour les travaux de soudage lors de la décoration intérieure et des travaux en hauteur.
- Compacité, stabilité et fiabilité.
- Amorçage de l'arc simple, faibles projections et formation stable.
- La technologie IGBT améliore considérablement la fiabilité de l'appareil.
- Des électrodes basiques et rutiles peuvent être utilisées.
- Tension à vide et puissance d'arc élevées.
- Protection automatique contre les surtensions, les surintensités et les surchauffes.
- Courant de soudage stable lorsque la tension d'entrée fluctue et possibilité d'une égalisation automatique lorsque la tension d'entrée fluctue.



- ✓ ONDULEUR AVEC TECHNOLOGIE IGBT
- ✓ SOUDAGE À L'ARC MANUEL AVEC COURANT CONTINU
- ✓ PROTECTION CONTRE LES BRÛLURES
- ✓ PUISSANCE DE L'ARC
- ✓ AMORÇAGE DE L'ARC CHAUD

- Comprend: Porte-électrode avec câble de 2m. Pince de mise à la terre avec câble de 1,5m. Brosse marteau. Écran facial manuel.

1ph AC 230V	50Hz	16A Intensidad nominal máx. Max. Input Current	65V Tensión al vacío No-load Voltage	6.5 KVA Potencia Absorbida Rated Input Power
160A 26.4V	10-160A Intensidad de salida Output Range	0.7 Factor de potencia Power Factor	IP21S Clase protección Protection Class	F Clase aislamiento Insulation Class



RECHANGES POUR REF. 51837

REF.	DÉSCRIPTION	€
15238	Brosse pour marteau de soudeur	5,00€
15239	Écran facial manuel	5,50€
15245	Pince de mise à la terre avec câble de 1,5 m	7,50€
15246	Panneau de commutation	108,00€
15247	Accouplement à dégagement rapide (négatif)	2,50€
15248	Accouplement à dégagement rapide (positif)	2,50€
15249	Ventilateur	5,00€
15250	Commutateur d'alimentation	4,50€
15251	porte-électrode avec câble de 2m	15,00€

# DÉCAPEUR TERMIQUE 2000W

**53145** 39,20€

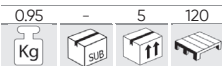

- 220V-240V.  
- 50Hz-60HZ.  
- 2000W.



- Température de sortie d'air: 50-600°C.  
- Débit d'air: 220-480L/min.  
- 2 options de température: 300 et 600°C.

**53162** 60,00€

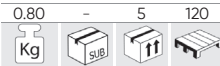

- 220V-240V.  
- 50Hz-60HZ.  
- 2000W.



- Température de sortie d'air: 100-600°C.  
- Débit d'air: 280-480L/min.

DIGI-TAL

# RESCULPTEUR DE PNEUS

**52643** 596,00€

PUISSANCE MAXIMALE 350W

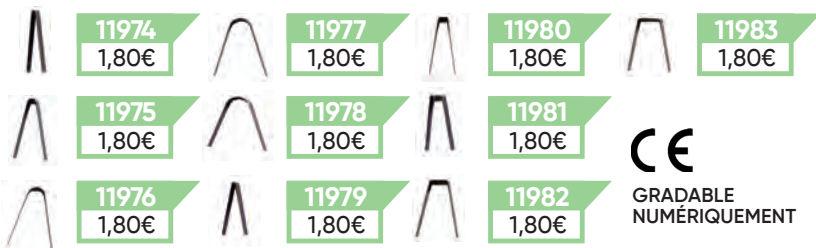
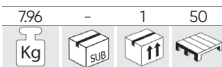

CE  
GRADABLE  
NUMÉRIQUEMENT

## RECHANGES

REF.	11974	11975	11976	11977	11978	
TYPE DE LAME	R1	R2	R3	R4	R5	
LAME ARRONDIE	mm	mm	mm	mm	mm	
	A	3	5	6	8	10
	B	7	7	10	12	12
	C	5	8	15	16	18
	D	21	21	23	25	24

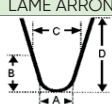

REF.	11979	11980	11981	11982	11983	
TYPE DE LAME	W1	W2	W3	W4	W5	
LAME CARRÉE	mm	mm	mm	mm	mm	
	A	3	5	7	9	11
	B	7	7	10	12	12
	C	5	6	10	13	15
	D	21	21	22	24	23

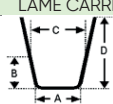

# TOURET A MEULER

450W

**53656** 198,00€

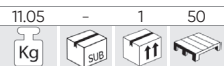

600W

**53657** 248,00€

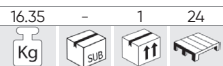

250W

**53658** 99,00€

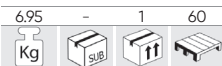

250W

**53659** 121,00€

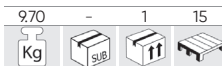

Poignée de fixation du support d'outil

Meule



Protège-meule

Meule



Réservoir d'eau

Meule pour rectification sans refroidissement

## BASE EN ACIER POUR MEULEUSE DE BANC

**53660** 146,00€

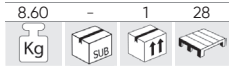

- Hauteur: 790mm.
- Dimensions de la plaque de fixation: 250x280mm.
- Poids: 8kg.

## TOURET À MEULER 150mm

**52195** 170,00€

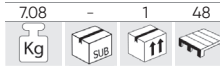

- Puissance nominale d'entrée: 250W.
- Tension nominale: 230V / 50Hz.
- Vitesse sans charge: 2.950Rpm.
- Ø de rue: 150 x 20 x 12.7mm.
- Poids net: 8,5Kg.



## FONTAINE DE NETTOYAGE ÉLECTRIQUE

**52980** 480,00€

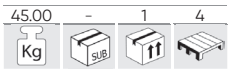

**150L**

- Débit: 25L.
- Fonctionne avec des solutions de nettoyage de moteur solubles dans l'eau.

**50632** 298,00€

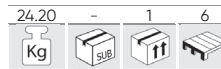

**100L**

MESURES TOTALES MACHINE

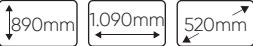

MESURES INTÉRIEURES DÉPÔT

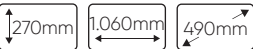

MESURES TOTALES MACHINE



MESURES INTÉRIEURES DÉPÔT



POMPE

**11101** 0.71 20 120  
154,00€ Kg SUB

FILTRE

**11102** 0.01 100  
6,60€ Kg SUB

BROSSE DE RECHANGE

**11100** 0.35 100 1000  
24,30€ Kg SUB

## APPAREIL DE NETTOYAGE PORTATIL

**53220** 260,00€



- FORMAT PORTABLE.
- Fermeture hermétique pour éviter les pertes durant le transport.
- Utiliser avec un dissolvant de base aqueuse.

- Interrupteur d'allumage latéral.
- Filtre de nettoyage de liquide inclus.
- Crochet pour outils et tuyau inclus.
- Compartiments de rangements.
- Séparation de zones de travail, zone de nettoyage et zone de séchage, permet un travail de plusieurs pièces à la fois.

- Capacité maximale: 27.5L.
- Connexion à 220V.
- Capacité de pompage: 1.000 L/h.
- Capacité de travail: 20L.
- Tuyau de 1,10m de long.

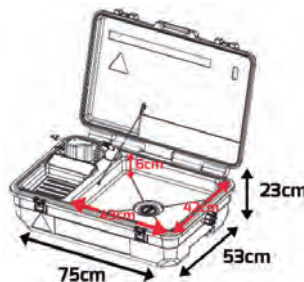

TVA non comprise

## ASPIRATEURS INDUSTRIELS

**51837** 195,00€

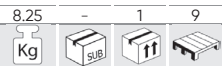

**30L**

POUSSIÈRE - CUVE 30L



INCLUS



RECHANGES POUR REF. 51837

REF.	DÉSCRIPTION	€
10720	Tuyau de plastique 1,5m	24,50€
11095	Tuyau de plastique 3m	31,00€
10721	Tube metal telescopique	19,00€
10761	Filtere	16,00€

**51838** 667,00€

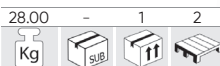

**80L** CE

EAU + POUSSIÈRE CUVE 80L



INCLUS



RECHANGES POUR REF. 51838

REF.	DÉSCRIPTION	€
10722	Tuyau de plastique 1,5m	24,50€
11098	Tuyau de plastique 6m	57,00€
10723	Coude supérieur	29,50€
10724	Coude inférieur	29,50€
10762	Filtere	23,50€

## BALAYEUSE À POUSSÉE MANUELLE

**54252** 199,00€



650X15mm



REF.	DÉSCRIPTION	€
16165	BOUCLE DE DISQUE BALAYEUSE POUR REF. 54252	2,00€
16166	DISQUE DE BALAYAGE POUR REF. 54252	23,50€
16167	JEU DE 2 ROUES 50MM POUR REF. 54252	7,00€
16168	COURROIE DE TRANSMISSION POUR REF. 54252	5,00€
16169	PIGNON DROIT POUR REF. 54252	1,50€
16170	PIGNON GAUCHE POUR REF. 54252	1,50€
16171	JEU DE 2 ROUES 200MM POUR REF. 54252	20,50€
16172	TIGE DE POUSSOIR POUR REF. 54252	22,50€
16173	PINCE DE LA BARRE POUR REF. 54252	3,00€

## PULVÉRISATEUR INDUSTRIEL

**53820** 388,00€

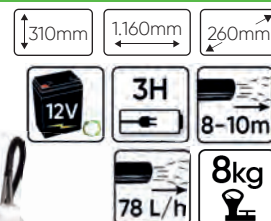
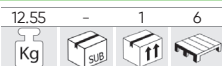

Capacité du réservoir	15L
Distance de pulvérisation	8-10m
Taille des particules liquides	<50 microns(µm)
Capacité du réservoir de carburant	2L
Consommation d'essence	3,2L/hora

- HAUTE EFFICACITÉ: x7-10 FOIS Plus élevée que le pulvérisateur manuel

- BONNE DIFFUSION: ÉCONOMISE L'eau et les pesticides

- DÉSINFECTE LES COUVERTURES Larges à travers les fines particules de fumée



# CHAUFFAGE

**54229** 48,00€

1.76 - 4 80

Kg SUB if

210-160-217mm

2Kw 220V 240V 5000 MOOD 20m<sup>2</sup>

SPCC PTC 197 m<sup>3</sup>/h

**54230** 68,00€

3.10 - 1 56

Kg SUB if

210-160-217mm

3Kw 220V 240V 5000 MOOD 30m<sup>2</sup>

SPCC PTC 197 m<sup>3</sup>/h



54229/54230



**54231** 138,00€

4.80 - 1 27

Kg SUB if

300-235-345mm

5Kw 380v 400v 5000 MOOD 48m<sup>2</sup> SPCC

1,4m PTC 588 m<sup>3</sup>/h

**54232** 248,00€

790 - 1 12

Kg SUB if

395-307-455mm

9Kw 380v 400v 5000 MOOD 80m<sup>2</sup> SPCC

1,4m PTC 1180 m<sup>3</sup>/h



54231/54232



# ROBOT TONDEUSE

**52598** 1.080,00€

17,00 - 1 12

Kg SUB if

- Robot tondeuse autonome.
- Sans fil et facile à ranger.

5200 mAh Capacité de la batterie Battery capacity

1400m<sup>2</sup> Superficie de coupe Mowing area

115,44W Consommation de énergie Power consumption

AC 100-240V 50/60Hz Tension de entrée Input Voltage

DC 15-25,5V Tension de sortie Output Voltage

2,5H

2H

70 dB

IP X4

7,5kg

22m/min

50-35,5-24 cm



CONNEXION DE L'APPLICATION



HAUTEUR DE COUPE: 2,5 - 5,5CM

LARGEUR DE COUPE: 18CM

VITESSE DE ROTATION DE LA LAME: 3500RPM



REF.	DÉSCRIPTION	€
15424	Fil de raccordement 150m	105,00€
15425	Agrafes pour fil de raccordement 150 pcs	50,00€
15426	Lame de coupe et vis	10,00€
15427	Clous pour station d'accueil	9,00€
15428	Batterie 22,2 v, 2 600 mah	238,00€
15429	Rallonge 5 m	23,50€
15430	Adaptateur	83,00€
15431	Station de recharge	241,00€
15432	Connecteur de fil de raccordement	18,50€
15433	Garage	197,00€
15434	Moteur de roue arrière	147,00€
15435	Plaque de coupe et plaque de protection	24,50€
15436	Moteur de coupe	97,00€
15437	Carte mère (avec fonction wifi)	305,50€
15438	Capteur de fil de raccordement	31,00€
15439	Roues avant	52,00€

# LAVEUSE HAUTE PRESSION

Ce nettoyeur haute pression à **moteur de 1400 W / 2400 W** est idéal pour nettoyer les vélos, les voitures, les équipements situés en plein air, les patios, les terrasses, les serres, etc.

**53947** 145,00€

5,80 Kg 1 31



## MOTEUR

**15398**

75,00€

1 10

- Pression nom.: 70 bar
- Débit: 5,5 l/min
- Pression d'entrée max.: 4 bar
- Taille: 28x25,5x44 cm
- Type de moteur électrique: à brosse

- Comprend:
- 1 pulvérisateur
- 1 tuyau haute pression 3 m
- 1 cordon d'alimentation 5 m



**53948** 324,00€

12,10 Kg 1 10

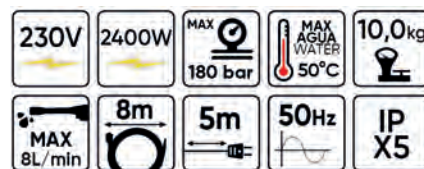

## MOTEUR

**15399**

117,00€

1 10

- Pression nom.: 120 bar
- Débit: 5,5 l/min
- Pression d'entrée max.: 4 bar
- Taille: 44x34,5x50,5 cm
- Type de moteur électrique: à brosse

- Comprend:
- 1 pulvérisateur
- 1 tuyau haute pression 8 m
- 1 cordon d'alimentation 5 m
- 1 buse turbo
- 1 connexion transparente
- 1 générateur de mousse 750ml
- 1 nettoyant pour terrasse
- 1 brosse à pneus
- 1 brosse fixe



## PULVÉRISATEUR

**15388** 20 33,00€

## INJECTEUR TURBO

**15393** 100 12,50€

## TUYAU PVC 5M

**15389** 20 18,50€

## PULVÉRISATEUR À MOUSSE

**15394** 50 26,00€

## NETTOYANT DE SURFACE 8 POUCES

**15390** 15 43,00€

## RACCORD DE TUYAU

**15395** 50 3,50€

## BROSSE FIXE

**15391** 50 13,50€

## BROSSE DE JANTE

**15392** 50 17,50€

## ENROULEUR CÂBLE ÉLECTRIQUE - 21m

**53585** 168,00€

8,35	-	2	34
Kg	sub	ff	ff

**53586** 158,00€

5,15	-	2	30
Kg	sub	ff	ff

PROTECTION DIFFÉRENTIELLE DES SURCHARGES



AVEC SUPPORT MURAL

230V	1000W 3000W	H07RN-F 3G1.5mm <sup>2</sup>	IP 44
20m	+	1m	



SUPPORT MURAL

**14771** 0,35 30  
10,50€ Kg ff

REBOBINAGE AUTOMATIQUE

## ENROULEUR CÂBLE ÉLECTRIQUE - 12M

**53584** 119,00€

5,10	-	4	48
Kg	sub	ff	ff

**53526** 168,00€

8,35	-	2	34
Kg	sub	ff	ff



AVEC SUPPORT MURAL

230V	1000W 3000W	H07RN-F 3G1.5mm <sup>2</sup>	IP 44
11m	+	1m	



SUPPORT MURAL

**14774** 0,40 10  
10,50€ Kg ff

REBOBINAGE AUTOMATIQUE

PROTECTION DIFFÉRENTIELLE DES SURCHARGES

BLOCAGE DE CÂBLE

## ENROULEUR CÂBLE ÉLECTRIQUE

**51033** 98,00€

3,86	-	2	48
Kg	sub	ff	ff

- Protection de surcharge.  
- Protection pour enfants.

**25m** H05W-F 3x1.5 mm<sup>2</sup> PVC IP 20



## EXTENSION DU CÂBLE ÉLECTRIQUE

**53166** 10,50€

0,45	5	30	600
Kg	sub	ff	ff

3m

**53167** 12,50€

0,65	5	20	600
Kg	sub	ff	ff

5m

**53168** 19,00€

1,20	5	10	300
Kg	sub	ff	ff

10m



## VENTILATEUR D'AUTOMOBILE - 12 V

53543 13,80€

0,75 5 20 160



x2 VITESSES



## VENTILATEUR DE VOITURE DOUBLE

53600 13,80€

0,55 5 20 160



x2 VITESSES

## VENTILATEUR

SUR PIED

53189 128,00€

710 - 1 12



## PULVERISATEUR D'EAU

54125 152,00€

8,25 - 1 14

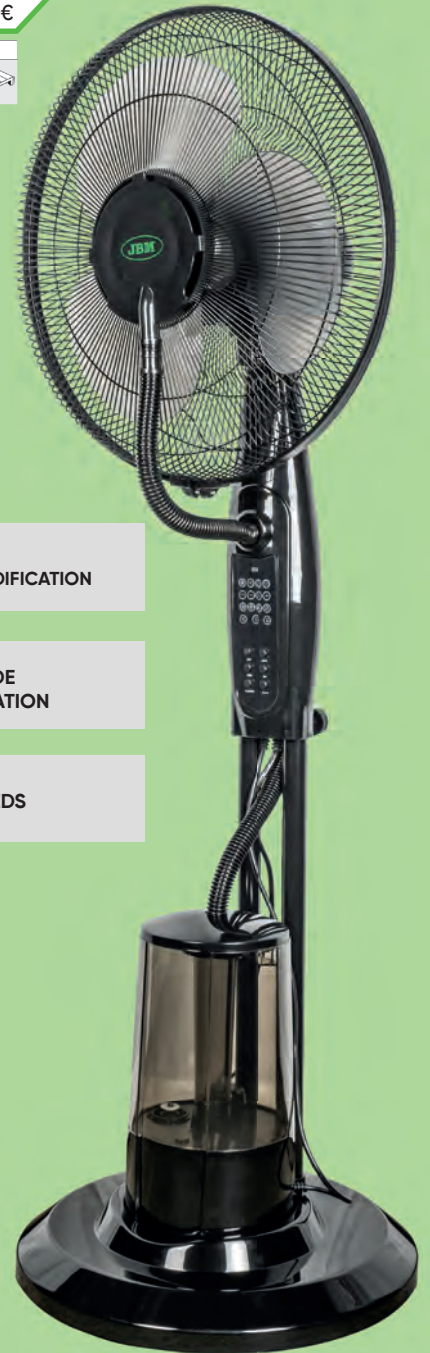
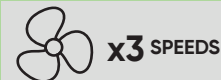
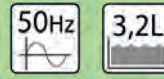

SUR SOL

53190 98,00€

6,10 - 1 16

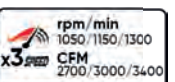
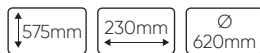

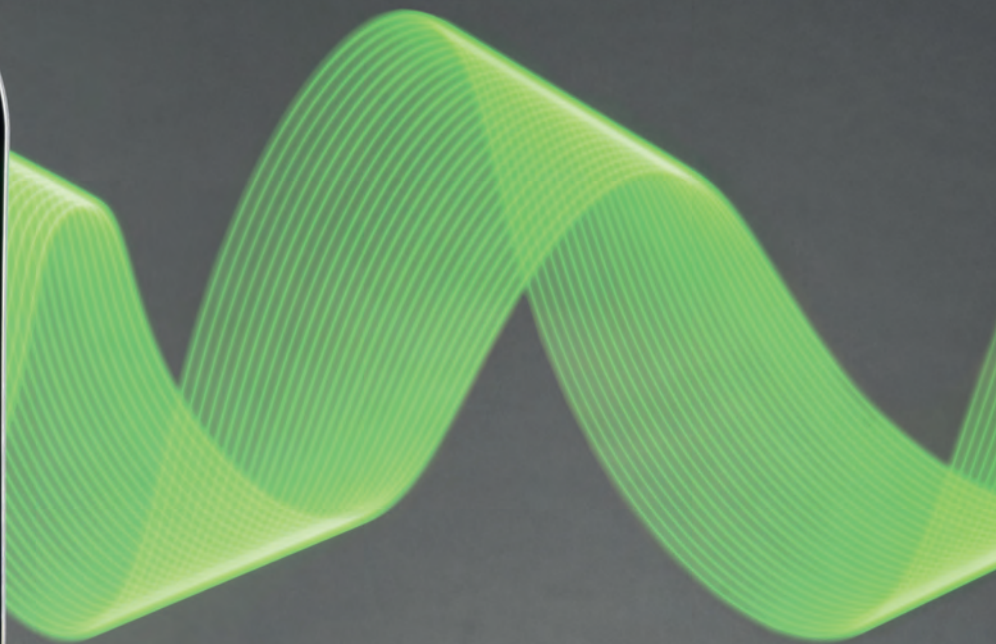

## **ÉNERGIE RENOUVELABLE ET MOBILITÉ DU FUTUR**

- 286 STATION D'ÉNERGIE PORTATILE
- 286 PANNEAUX SOLAIRES
- 287 VOITURE ÉLECTRIQUE / CÂBLES
- 288 ACCESSOIRES
- 289 OUTILLAGES ISOLÉS

# STATION DE PUISSANCE 1920 WH / 48V 40 AH

53970

3.790,00€

L'usine de force motrice portable est un générateur électrique puissant, portable et alimenté à l'énergie solaire. En l'absence de soleil, il peut également être chargé à partir de n'importe quelle source d'énergie.

34,70 - 1 13  
Kg SUB

Salida nominal de CA Rated AC output <b>3000W</b>	Carga rápida Fast Charging <b>54V/10A</b>	Carga solar Solar Charging <b>54V/7,5A</b>	<b>220VAC</b> ± 10%
Pico de salida de CA Peak AC output <b>6000W</b>			
Ciclo de carga de la batería Battery life cycles <b>&gt;2000</b>	1920Wh LiFePO4	Temperatura de descarga Discharging Temperature -10°C 60°C	Temperatura de carga Charging Temperature 0°C 45°C
50/60 Hz	2W(x2) LED	USB-GC 5V/9V/ 12V/3A	DC(x2) 12V/10A
USB-Type-C 5V/3A 9V/ 2A 12V/1,5A	USB 5V 2.4A*2	12V 10A	Universal
CC-CA	MPPT	390mm	418mm
		245mm	



IL COMPREND:



Chargeur de batterie



Chargeur solaire par plaque solaire



Câble connecteur par chargeur mural

GÉNÉRATEUR D'ÉNERGIE

ÉNERGIE N'IMPORTE OÙ

LARGE GAMME D'APPLICATIONS



3000W +0,75h	2000W +1h	1500W +1h	1000W +1,5h	120W +12h
200W +7,5h	70W +22h	30WH +50 fois	10WH +150 fois	100W +15h
20W +75h	2200W +1h	500W +3h	500W +3h	2000W +1h



COMPATIBLE AVEC 53971

# PANNEAU SOLAIRE 200 W

53971

468,00€

13,45 - 2 12  
Kg SUB

200W

Ouvert:  
884mm x 1320mm x 54mm  
Fermé:  
884mm x 659mm x 54mm

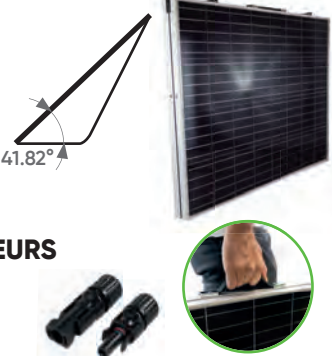

CONVERSION D'ÉNERGIE ÉLEVÉE



TRANSPORT FACILE  
INSTALLATION FACILE

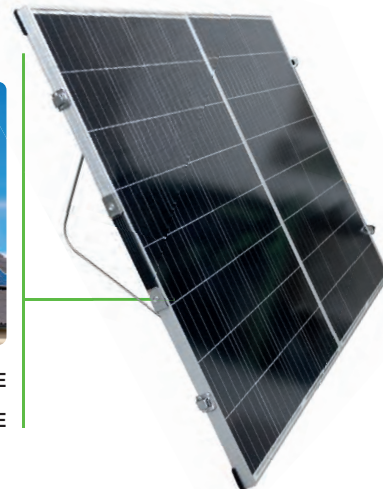

# PANNEAU SOLAIRE

54067

599,00€

2900 - 1 31  
Kg SUB

550W

**CARACTÉRISTIQUES MÉCANIQUES**  
Type de cellule : Monocristallin (type P), 182x91 mm  
Nombre de cellules : 144 (6x24)  
Nombre de barres par photoce-  
llule : 10  
Verre : haute transparence, 3,2 mm,  
revêtement antireflet

Câble de sortie (connecteur  
inclus) : diamètre : 4,0 mm  
Longueur : 300/400 mm  
(personnalisable).  
Boîte de jonction : IP68, 3 diodes  
shunt.  
Connecteur : compatible avec  
MC4

**CARACTÉRISTIQUES DE  
FONCTIONNEMENT**  
Tension max. du système :  
1 000 V/1 500 V CC  
Température de fonctionnement :  
-40 °C à +85 °C  
Courant max. de fusible : 25 A  
Charge de neige, face avant : 5  
400 Pa

Charge de vent, face arrière : 2  
400 Pa  
Température de fonctionnement  
nominale du tableau de distribu-  
tion : 45±2 °C  
Niveau d'application : Classe A

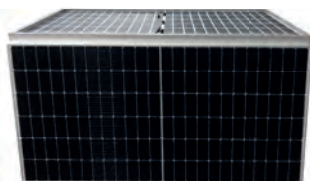
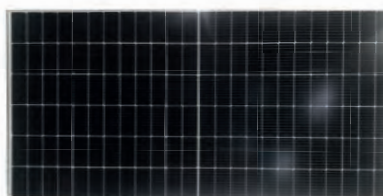

2279mm x 1134mm x 35mm

**CONDITIONS D'ESSAI STANDARD**

Puissance maximale : 550 W  
Force photoélectromotrice : 50,2 V  
Tension maximale : 42,4 V  
Courant de court-circuit : 13,78 A  
Courant maximal : 12,97 A  
Rendement du module : 21,28 %

**FONCTIONNEMENT NORMALE DE CELLULE**

Puissance maximale : 409 W  
Force photoélectromotrice : 47,1 V  
Tension maximale : 39,8 V  
Courant de court-circuit : 11,13 A  
Courant maximal : 10,29 A

Contactez-nous à l'adress  
[solar@jbmcamp.com](mailto:solar@jbmcamp.com)



pour des offres, des  
rapports, des prix et des  
informations techniques

# VÉHICULE ÉLECTRIQUE



Hybride et électrique

## CÂBLE DE CHARGE

<b>54053</b>	248,00€	2.15	-	1	-
Kg	sub	ff	ff		
<b>54054</b>	268,00€	2.90	-	1	102
Kg	sub	ff	ff		
<b>54055</b>	220,00€	2.15	-	1	102
Kg	sub	ff	ff		
<b>54056</b>	260,00€	2.85	-	5	102
Kg	sub	ff	ff		
<b>54057</b>	248,00€	2.95	-	5	102
Kg	sub	ff	ff		
<b>54058</b>	348,00€	3.85	-	1	102
Kg	sub	ff	ff		

<b>16A</b>	<b>3.6 kW</b>	<b>Tipo 1 - 2</b>	Monofásico Single-Phase
<b>32A</b>	<b>7.5 kW</b>	<b>Tipo 1 - 2</b>	Monofásico Single-Phase
<b>16A</b>	<b>3.6 kW</b>	<b>Tipo 2 - 2</b>	Monofásico Single-Phase
<b>16A</b>	<b>11 kW</b>	<b>Tipo 2 - 2</b>	Trifásico Three-Phase
<b>32A</b>	<b>7.5 kW</b>	<b>Tipo 2 - 2</b>	Monofásico Single-Phase
<b>32A</b>	<b>22 kW</b>	<b>Tipo 2 - 2</b>	Trifásico Three-Phase

## CHARGEUR SECTEUR

<b>52600</b>	884,00€	4.65	-	4	80
Kg	sub	ff	ff		
<b>52902</b>	970,00€	4.90	-	4	40
Kg	sub	ff	ff		
<b>52903</b>	1.100,00€	5.25	-	1	40
Kg	sub	ff	ff		
<b>54052</b>	1.100,00€	5.60	-	1	80
Kg	sub	ff	ff		

<b>16A</b>	<b>3.6 kW</b>	<b>Tipo 2</b>	Monofásico Single-Phase
<b>32A</b>	<b>7.5 kW</b>	<b>Tipo 2</b>	Monofásico Single-Phase
<b>16A</b>	<b>11 kW</b>	<b>Tipo 2</b>	Trifásico Three-Phase
<b>32A</b>	<b>22 kW</b>	<b>Tipo 2</b>	Trifásico Three-Phase



IP 66	5m	-25° +55°	Tipo 1 - 2	IP 66	5m	-25° +55°	Tipo 2 - 2
-------	----	--------------	------------	-------	----	--------------	------------

## STATION DE CHARGE PORTABLE

<b>54059</b>	428,00€	2.55	-	5	102
Kg	sub	ff	ff		
<b>16A</b>	<b>3.68 kW</b>	<b>Tipo 2</b>			
IP 66	6m	-25° +55°			



## RFID-KARTE

<b>15460</b>	5,00€	0.01	-	250	-
Kg	sub	ff	ff		

<b>16198</b>	5,00€	0.01	-	-	-
Kg	sub	ff	ff		



## CHARGEUR SECTEUR 22 KW, 32 A, POUR VOITURES ÉLECTRIQUES (TRIPHASE)

<b>54265</b>	1.290,00€	5.35	-	1	120
Kg	sub	ff	ff		
<b>32A</b>	<b>22 kW</b>	<b>Tipo 2</b>			
			Trifásico Three-Phase		



<b>16130</b>	290,00€	0.40	-	15	-
Kg	sub	ff	ff		

## TESTEUR DE COURANT POUR CHARGEUR 54265

<b>16130</b>	290,00€	0.40	-	15	-
Kg	sub	ff	ff		

Avec cet accessoire le chargeur 54265 est capable de réguler sa puissance de charge en calculant la consommation totale du reste des appareils électriques de l'installation domestique ; évitant les surcharges et les coupures du réseau domestique.



## POTEAU DE PLASTIQUE POUR CHÂÎNES HAUTE TENSION

53940 13,20€

0,55	-	6	96
Kg	Sub	ff	ff

- Matériau: PVC.

  
SIGNALISATION  
SPÉCIALE  
HAUTE TENSION



BASE GONFLABLE

850mm



## MAILLE DE CHÂÎNE

53942 0,50€

0,01	50	5000	75000
Kg	Sub	ff	ff



## CHÂÎNE PVC

53941 6,05€

0,30	-	40	600
Kg	Sub	ff	ff



- Longueur: 5m
- Lien: 6 mm
- Couleur: rouge / blanc



## RUBAN DE SIGNALISATION 200M

53987 9,50€

0,59	-	40	560
Kg	Sub	ff	ff



200M X 10cm



## PINCE AMPÈREMÉTRIQUE

52382 19,50€

0,23	5	50	1600
Kg	Sub	ff	ff



52952 74,00€

0,26	5	50	1500
Kg	Sub	ff	ff



55mm

167mm

22mm

	52382	52952
DCB	600V	20V, 600V
ACB	600V	600V
DCA		200A
ACA	20A, 200A, 600A	200A
OHM	2KΩ, 200KΩ, 2MΩ	2000Ω

## MULTIMÈTRE DIGITAL

50942 28,00€

0,35	10	60	480
Kg	Sub	ff	ff

- Digits: 3 1/2.
- Mesure: 2.000.
- Données instantanées.
- Auto déconnexion.
- Indicateur de batterie.
- Batteries de 9 V.
- Sonde de température.
- Température de -40°C à 1 000°C.

<b>V</b> AC	200mV, 2V, 20V, 200V, 1000V	<b>A</b> AC	20mA, 200mA, 20A
<b>V</b> DC	200mV, 2V, 20V, 200V, 750V	<b>A</b> DC	20mA, 200mA, 20A
<b>Ω</b>	200Ω, 2KΩ, 20KΩ, 200KΩ, 2MΩ, 20MΩ, 2000MΩ		
<b>F</b>	2nF, 20nF, 200nF, 2μF, 20μF, 200μF		

CE



## SET D'OUTILS ISOLANTS 20 PIÈCES DE 3/8"

53154 462,00€

3,30	-	3	72
Kg	Sub	ff	ff



CrV 3/8" 20 PCS



420mm

80mm

33mm



## SET D'OUTILS ISOLANTS 20 PIÈCES DE 3/8"



54091 441,00€

4,20	-	3	72
Kg	Sub	ff	ff



CrV 3/8" 26 PCS

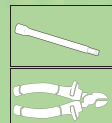
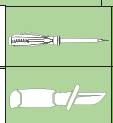
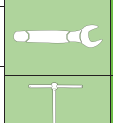
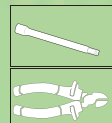
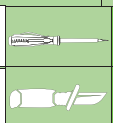
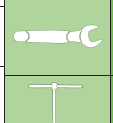

	x1	125mm		x4	≥SL VDE 4x10mm, 5x125mm PHILIPS VDE 1x80mm, 2x100mm		x1	3/8"
	x1	ALICATE COURT DIAGONAL		x1	200mm		x6	7x8 6mm, 8x99mm, 10x109mm, 12x127mm, 14x141mm, 17x156mm
	x1	200mm		x1	200mm		x1	



## JEU DE 50 TOURNEVIS ISOLÉS

**52521** 125,00€

1.43 - 6 216

Kg SUB ff

**CrV** **50 PCS** **AC 1000V** IEC 60900:2004

x9	T6x100 T8x100 T9x100 T10x100 T15x100 T20x100 T25x100 T27x100 T30x100	x7	0.4x2.0x100 0.4x2.5x100 0.5x3.0x100 0.6x3.5x100 0.8x4.0x100 1.0x5.5x100 1.2x6.5x100	x5	H2.5x100 H3.0x100 H4.0x100 H5.0x100 H6.0x100
	x4		4x100 6x100 8x100 10x100		TRI 1x100 TRI 2x100 TRI 3x100 TRI 4x100
x2		6.3x89 8.1x89	x4	TORO 4x100 TORO 6x100 TORO 8x100 TORO 10x100	x3
	x2	R1x100 R2x100		x1	

89 Voltage Tester: 3.0x70 + Torx: 31x105



## SET DE TOURNEVIS ISOLÉS À 1000V

**52009** 36,00€

0.34 10 50 1200

Kg SUB ff

**AC 1000V** IEC 60900:2004

x2	PH1x100, PH2x100
	0.4x2.5x100, 0.8x4.0x100, 1.0x5.5x100, 1.2x6.5x100

## JEU DE 7 TOURNEVIS ISOLÉS 1000V

**52519** 25,50€

0.14 5 10 840

Kg SUB ff

**AC 1000V** IEC 60900:2004 **CrV**

x2	PH0x50, PH0x50mm
	SL1.5x0.23x50, SL1.8x0.30x50, SL2.0x0.40x50, SL2.5x0.40x50 SL3.0x0.50x50mm

## JEU DE TOURNEVIS AVEC EVA CARBONE MODULE

**15162** 30,20€

0.65 - 10 240

Kg SUB ff

**1000V C** IEC 60900

**8 PCS** **VDE**

x2	PH 0x75mm PH 1x80mm PH 2x100mm
	SL 3x75mm SL 4x100mm SL 5.5x125mm SL 6.5x150mm
x5	140mm SL 0.5 x 3.0 mm 1000V

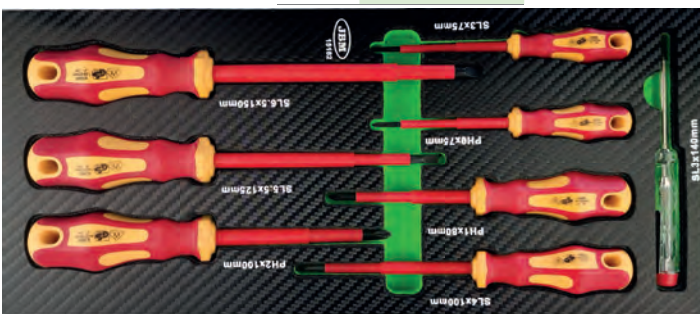

## COUTEAU ISOLANT

**DROIT**

**53164** 16,50€

0.10 6 36 1152

Kg SUB ff

**1000V C** IEC 60900 **CrV**

Certificate EN60900

180mm  
50mm

**COURBÉ**

**53165** 19,60€

0.10 6 36 1152

Kg SUB ff

## MESUREUR DE RÉSISTANCE D'ISOLATION

**54114** 248,00€

1.48 - 10 100

Kg SUB ff

Cet instrument vous permet de mesurer l'isolation électrique à une tension déterminée (250 V, 500 V ou 1000 V). C'est un outil indispensable pour évaluer l'intégrité d'un circuit électrique, il est particulièrement utile pour vérifier que les composants et l'installation dans les voitures électriques sont complètement isolés de la carrosserie. Dans les installations industrielles, c'est l'outil qui permet d'effectuer des inspections périodiques de la résistance de l'isolation. Mesures requises pour la norme DIN VDE 0105-100 (VDE 0105-100):2009-10.

Catégorie d'installation :	2	Réglage du zéro :	Réglage automatique
Catégorie de mesures :	CAT III	Température de fonctionnement :	0° - 40°C (32°F - 104°F), humidité de l'air relativement inférieure à 80%
Altitude :	Jusqu'à 2000 mètres	Température de stockage :	-10°C - 60°C (14°F - 140°F), humidité de l'air relativement inférieure à 70%
Double affichage avec :	afficheur LCD	Source d'alimentation :	DC9V (6 piles "AA" de 1,5V)
Tension AC :	0 - 750V	Dimensions (longueur x largeur x hauteur) :	200 x 92 x 50mm
Tension DC :	0 - 1000V		
Résistance :	0 - 200Ω / 200 - 2000 Ω		
Résistance d'isolement :	0 - 200MΩ / 200 - 2000 MΩ		
Taux d'échantillonnage :	2,5 fois par seconde		

# SERVANTE D'OUTILS 7 TIROIRS SPÉCIAL VDE

<b>54233</b>	1.856,00€	<b>54234</b>	1.856,00€	<b>54235</b>	1.856,00€	<b>54236</b>	1.856,00€
67.70	-	1	4	67.70	-	1	4
Kg	sub	ff	ff	Kg	sub	ff	ff

Servante spécialement configurée afin de couvrir toutes les nécessités basiques du maintien et réparation de véhicules hybrides et électriques, ainsi que pour les travaux de hautes tensions.

**TERMOMETRE LASER -50°C A 550°C**

52162 38,00€



**POTEAU DE PLASTIQUE POUR CHÂÎNES - JAUNE / NOIR**

53940 13,20€



x4

**CHAÎNE PVC - 5M - JAUNE/NOIR**

53941 6,05€



x4

**MAILLE DE CHÂÎNE EN PLASTIQUE NOIR**

53942 0,50€



x8

**GANTS ISOLANTS POUR TRAVAUX SOUS TENSION T.9**

54130 58,00€



**PERCHE DE SAUVETAGE ISOLÉE - 45KV**

54241 120,00€



**MODULE D'OUTILS VDE AVEC ISOLATION EVA (ÉTHYLENE VINYLE ACÉTATE) -26 PIÈCES**

54093 441,00€



**MESUREUR DE RÉSISTANCE D'ISOLATION**

54114 248,00€



**TAPIS ISOLANT CLASSE 0**

54129 110,00€

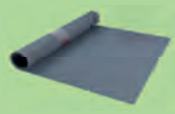

## GANTS ISOLANTS POUR TRAVAUX SOUS TENSION

<b>54130</b>	58,00€	T.9	<b>54131</b>	58,00€	T.10
0.35	-	1	100		
Kg	sub	ff	ff		

IEC ELECTRICAL SAFETY GLOVES 60903-2014 CLASS 0

1000V AC - 1500V DC

AZC

360mm

LATEX

CLASS 0 / CLASS 0

cat.3

## PERCHE DE SAUVETAGE ISOLÉE - 45KV

<b>54241</b>	120,00€	Ø 3cm	165cm	37cm
1.10	-	1	50	
Kg	sub	ff	ff	

Warning symbols: lightning bolt, car with lightning bolt

## TAPIS ISOLANT CLASSE 0

<b>54129</b>	110,00€	2.10	-	5	200
Kg	sub	ff	ff		

0,6x1m

2mm

1,8KG

IEC ELECTRICAL SAFETY MATTING 60911-2007 CLASS 0

1000V AC - 1500V DC

CLASS 0 / CLASS 0

SLIP RESISTANT / ANTI-DESKINING

ROLLS / ENROLLABLE

RECYCLABLE / RECYCLABLE

OIL RESISTANT / RESISTANT À L'ACIER

## ÉCRAN FACIAL ISOLANT POUR LES TRAVAUX ÉLECTRIQUES

<b>54132</b>	190,00€	0.70	-	1	62
Kg	sub	ff	ff		

EN 166 : 2001

EN 170 : 2002

ANSI Z87.1

Anti-vaho / Anti fog

Anti-ralladuras / Scratching proof

Class 1 / 1 class



## ACCÉSSOIRES

- 292 ENROULEURS
- 293 ESCALIERS
- 294 SERVANTES
- 295 ORGANISATEURS
- 296 POUR VOITURE
- 298 KIT D'URGENCE / TROUSSES DE PREMIERS SOINS
- 305 CAPTEUR DE STATIONNEMENT
- 306 TAPIS
- 307 BALAIS D'ESSUIE-GLACE
- 308 MASSES D'ÉQUILIBRAGE
- 309 VALVES TPMS
- 310 POUR PNEUMATIQUES
- 314 SOUFFLET DE PALIER POUR TOURISME UNIVERSEL /  
OUTIL PNEUMATIQUE DE MONTAGE DE SOUFFLET DE  
PALIER

## ENROULEUR D'EAU RACCORD

53872 118,00€

7,50	-	1	21
Kg	Sub	ff	ff

- Longueur: 15+1,5 m
- Connexion 3/4"
- Diamètre du tuyau: 1/2"
- Diamètre intérieur: 11,5 mm
- Diamètre extérieur: 15,8 mm
- Pression de service 120 psi / 8 bar
- Enroulement automatique du tuyau
- Matériau du tuyau: PVC



### RACCORD DE TUYAU 1/2"

15153 2,50€

0,05	-	50	-
Kg	Sub	ff	ff

### BUSE

15154 7,50€

0,05	-	50	-
Kg	Sub	ff	ff

## ENROULEUR DE TUYAU D'AIR

VOIR PAGE 146



53582 179,00€

10,85	-	1	14
Kg	Sub	ff	ff

22M



53583 170,00€

10,75	-	1	14
Kg	Sub	ff	ff

53532 119,00€

6,80	-	2	30
Kg	Sub	ff	ff

13M



53581 115,00€

6,70	-	2	30
Kg	Sub	ff	ff

53881 79,00€

4,50	-	4	48
Kg	Sub	ff	ff

11 M



53882 79,00€

4,50	-	4	48
Kg	Sub	ff	ff

11 M

## ENROULEUR CÂBLE ÉLECTRIQUE



53585 168,00€

8,35	-	2	34
Kg	Sub	ff	ff

21M



53586 158,00€

8,35	-	2	30
Kg	Sub	ff	ff

53526 168,00€

5,15	-	4	48
Kg	Sub	ff	ff

12M



53584 119,00€

5,10	-	4	48
Kg	Sub	ff	ff

## ENROULEUR D'HUILE RACCORD

50797 490,00€

26,60	-	1	14
Kg	Sub	ff	ff

160 BAR



À base d'huile/bobine  
Longueur du tuyau : 15+1 m  
Pression de service max. : 2 450 psi  
Entrée d'air : 1/2" BSPT (filetage conique britannique)  
Sortie d'air : 1/2", filetage conique britannique  
Matériau : acier

TVA non comprise

## ÉCHELLE MULTIFONCTIONNELLE

**54176** 188,00€

16,00 - 1 8  
Kg SUB

**CONTIENT**

JEU DE 2 PLATAFORMES

**15866** 32,00€

5,00 - 1 -  
Kg SUB



## ÉCHELLE TÉLESCOPIQUE

**51982** 120,00€

5,51 - 1 36  
Kg SUB

↑ 2.000mm  
↓ 730mm

6 marches

**51983** 180,00€

9,41 - 1 23  
Kg SUB

↑ 3.200mm  
↓ 930mm

10 marches

**51984** 190,00€

9,78 - 1 21  
Kg SUB

↑ 3.800mm  
↓ 1.020mm

12 marches

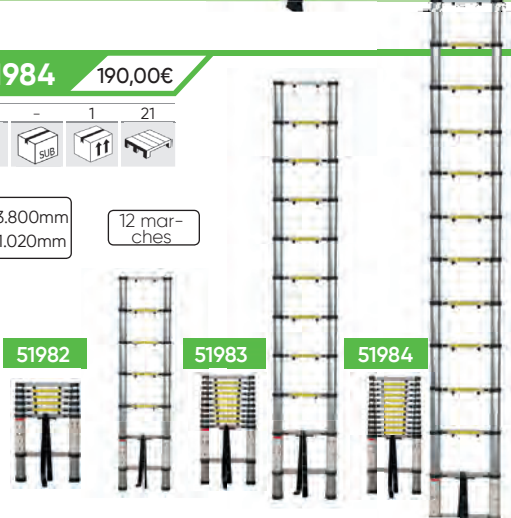

RENCONTRE AVEC: EN 131

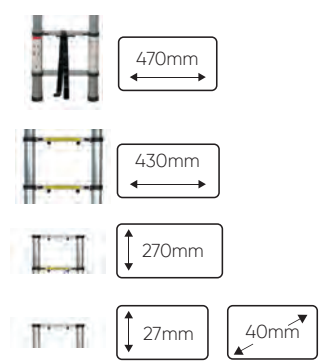

## ÉCHELLE TÉLESCOPIQUE TRANSFORMABLE

**52149** 230,00€

14,00 - 1 13  
Kg SUB

- Échelle pliante et légère.
- Système de pliage par blocage.
- Fabriqué en aluminium et en plastique.
- Hauteur pliée: 835mm.
- Hauteur étendue: 3800mm.
- Hauteur déployée: 1900mm.

↑ 270mm  
↑ 680mm

470mm

25mm

470mm



RENCONTRE AVEC: EN 131

## ESCALIERS

**50517** 129,00€

3,85 - 1 24  
Kg SUB

DE 4 MARCHES  
- Hauteur totale: 1,30m.  
- Hauteur max: 0,79m.





**50518** 169,00€

5,32 - 1 12  
Kg SUB

DE 6 MARCHES  
- Hauteur totale: 1,91m.  
- Hauteur max: 1,31m.



## BALANCE DE PRÉCISION

<b>54246</b> 104,00€ 2,27 - 10 - 400 Kg SUB ff 0°C / 40°C 220V G/LB CT/OZ 5,0kg PRECISION 0,01g CONVERSION DE UNITES BATTERIE ULTRA DURABLE PROTECTOR	Inox 304 	<b>54247</b> 99,00€ 2,40 - 8 - 400 Kg SUB ff 0°C / 40°C 220V G/LB CT/OZ 2,0kg PRECISION 0,01g CONVERSION DE UNITES PROTECTOR CONVERSION DE UNITES BATTERIE ULTRA DURABLE	
--	---	---	---

## CHARIOT EN ALUMINIUM

<b>52201</b> 66,00€ 6,18 - 4 - 36 Kg SUB ff PLIÉ 700mm 400mm 200mm 400mm	ÉLARGIE 1.060mm 380mm 400mm
---	--------------------------------------

PLIABLE ET EXTENSIBLE



## DIABLE ACIER

<b>52202</b> 88,00€ 9,35 - 1 - 12 Kg SUB ff 110mm 450mm 500mm	90Kg 200Kg
--	---------------



ROUE PLASTIQUE 3.00-4 (260x85) POUR REF. 52202 - 52661

<b>12055</b> 20,00€ 1,11 - 10 - 160 Kg SUB ff
---



## CHARIOT EN ACIER

<b>52200</b> 88,00€ 780 - 1 - 32 Kg SUB ff ÉLARGIE 840mm 725mm 475mm PLIANTE	150Kg
---	-------



PLIÉ 230mm 725mm 475mm
---------------------------



2 ROUES TOURNANTES

ACCESSOIRES D'ATELIER

## MALLETTE DE RANGEMENT 24+2

**50957** 22,00€

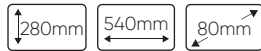
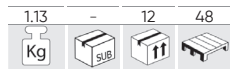

- 24 compartiments de 8x5,5 cm.
- 2 compartiments de 15x7,5 cm.
- Rabattable de 26 à 5 séparations.

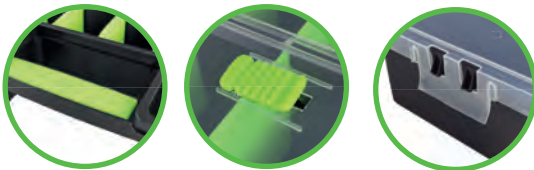

## MALLETTE DE RANGEMENT 18+1

**50959** 12,00€

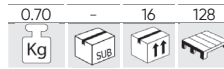

- 18 compartiments de 6x7 cm.
- 1 compartiment de 35x7 cm.
- Rabattable de 19 à 4 séparations.

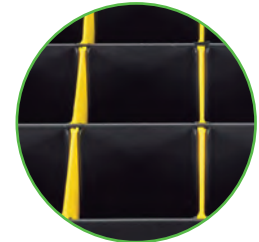

## CASIER DE RANGEMENT

**51051** 34,80€

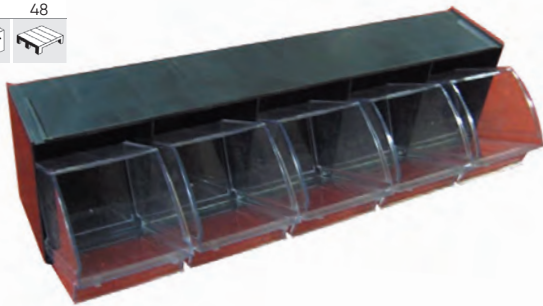
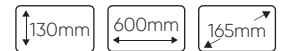
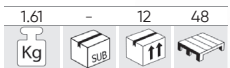

TIROIRS  
INSÉPARABLES

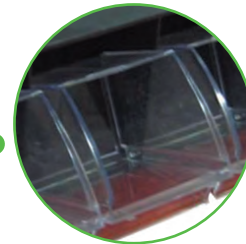

## JEU DE 8 BÔITES À BEC

**50960** 18,30€

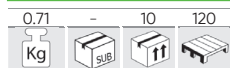

TIROIRS



GLISSIÈRE



## ÉTAGERÈS SUR PIEDS AVEC 47 BÔITES À BEC

**51050** 285,00€

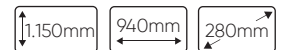
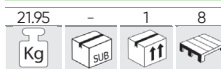

GRANDS COMPARTIMENTS  
Total: 15  
Dimensions: 24x14,5x13 cm  
Dimensions de l'étagère:  
84x14x24 cm  
Total étagères: 3

COMPARTIMENTS PETITS  
Total: 32  
Dimensions: 16x10x7,5 cm  
Dimensions de l'étagère:  
84x16x8 cm  
Total étagères: 4



## TENTE DE TOIT AVEC COQUE RIGIDE

54180

2.400,00€

100,00	-	1	-
Kg	Sub	Box	Box

- Housing material: White fiberglass. Keeps the inside of the tent away from the outside temperature.
- Fabric: 600D Ripstop polyester, water, mildew and UV resistant.
- High density foam mattress with washable cover; 60mm thick.
- Telescopic aluminum ladder
- Mini light inside
- Includes installation accessories
- Interior size: 120x208cm

REF.	DÉSCRIPTION	Kg	Sub	Box	Box	€
15905	Jeu de vis et de boulons pour la tente	0,15	10	100		16,50€
15906	Jeu de plaques de montage pour la tente	0,1	10	100		28,50€
15907	Eclairage intérieur de la tente	0,3	10	100		12,00€
15908	Supports de fenêtre et de porte pour tente	0,95	10	100		14,50€
15909	Barre de support pour tente					21,50€
15910	Rideau d'entrée pour tente					16,50€



## AUVENT DE VOITURE

54185

390,00€

20,00	-	1	-
Kg	Sub	Box	Box

2000mm  
2500mm

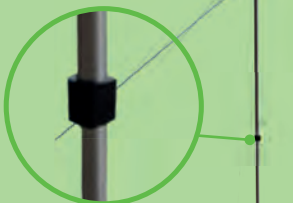
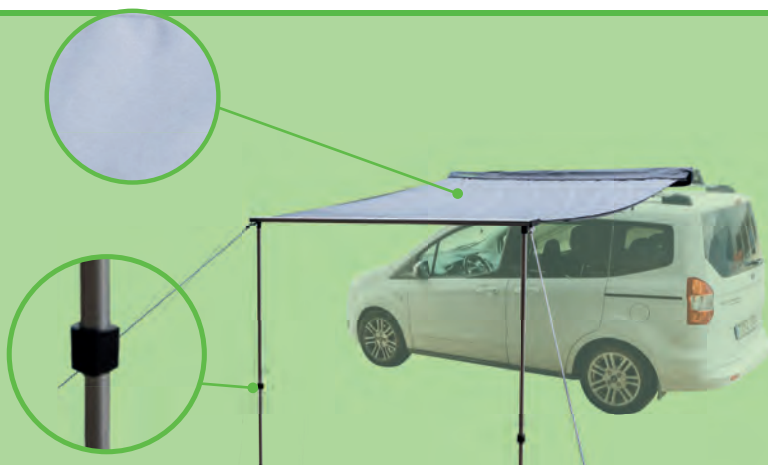

REF.	DÉSCRIPTION	Kg	Sub	Box	Box	€
15911	supports pour auvent de voiture (2 pcs)	0,15	10	100		30,50€
15912	jeu de vis et de boulons pour auvent de voiture	0,1	10	100		35,50€
15913	piquets pour auvent de voiture (2 pcs)	0,3	10	100		7,50€
15914	sac et 2 cordes pour auvent de voiture	0,95	10	100		7,50€



## SIÈGE AUTO

54196

133,00€

9,15	-	2	24
Kg	sub	ff	

E24

ECE R44/04

Groupe 1 (9 à 18 kg) face à l'avant, avec un système de harnais, et équipé d'une ceinture de sécurité à 3 points.

### GRUPE 0+ / 1/2

Groupe 0+ (0 à 13 kg) face à l'arrière avec un système de harnais dans la position la plus inclinée.

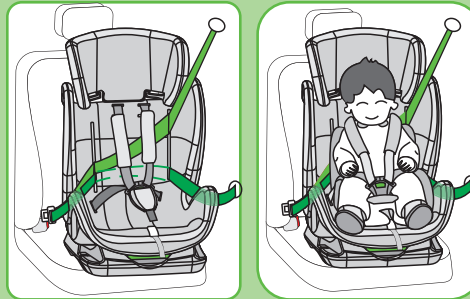
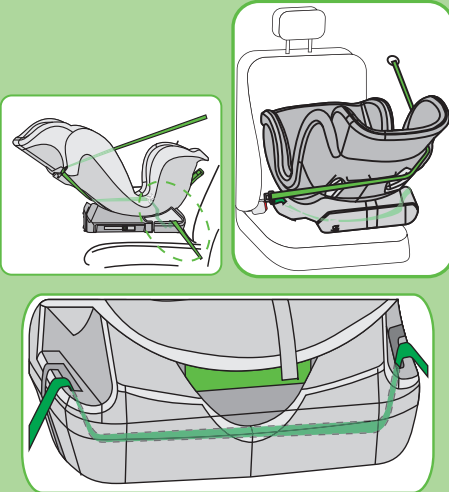

Groupe 2 (15 à 25 kg) face à l'avant, sans système de harnais, équipé d'une ceinture de sécurité à 3 points, 6 positions sur l'appui-tête



- 3 positions sur la ceinture
- 4 positions inclinées
- Housses en tissu amovibles et lavables

54197

118,00€

6,95	-	4	24
Kg	sub	ff	

E24

ECE R44/04

### GRUPE 1/2/3

Groupe 1 (9 à 18 kg) face à l'avant, avec système de harnais et équipé d'une ceinture de sécurité à 3 points

Groupe 2/3 (15 à 36 kg) face à l'avant, sans harnais, mais équipé d'une ceinture de sécurité à 3 points

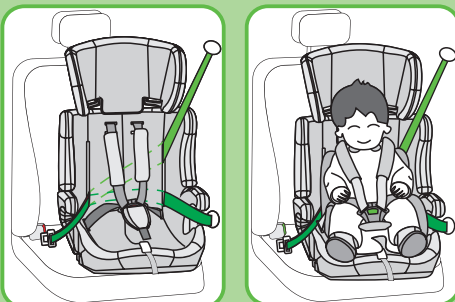

Housses en tissu amovibles et lavables.

## COUSSIN D'ALERTE POUR SIÈGE AUTO POUR ENFANT

54102

60,00€

0,15	-	20	200
Kg	sub	ff	

Système anti-abandon avec capteurs intégrés qui, placés dans le siège auto, permettent de détecter la présence de l'enfant à bord. Des capteurs de pression connectés à une application installée sur le smartphone détectent la présence de l'enfant dans le siège auto et envoient un signal d'alarme si les parents laissent l'enfant dans la voiture. L'application est disponible gratuitement pour les systèmes Android et iOS, se connecte aux capteurs de pression via Bluetooth et offre la possibilité d'enregistrer plusieurs contacts d'urgence.



### PORTE-CLÉS ALERTE POUR SIÈGE AUTO BÉBÉ

15671

20,50€



#### SPECIFICATIONS TECHNIQUES

Dimensions : 220*300*13.5mm
Poids : 100g
Bande de fréquence : 24-2485GHz
Puissance d'émission : 2,51 mW
Alimentation : pile Cr 3032 (remplaçable)
Température de fonctionnement - 10 °C à + 60 °C
Tissu : Néoprène, Spandex, SBR
Compatible avec iOS et Android



# KIT D'URGENCE ET DE SÉCURITÉ

TARIF PAR QUANTITÉ; NOUS CONSULTER (IMPRESSION ET SÉRIGRAPHIE EN OPTION)



## KIT D'URGENCE EN BOÎTE PLASTIQUE

**53540** 23,00€

2.10	-	9	144
Kg		Sub	Paq



2X TRIANGLE DE PRESIGNALISATION



Personnalisable à partir de 50 unités.

\* Double triangle, obligatoire uniquement en Espagne.

BOÎTE EN PLASTIQUE RIGIDE

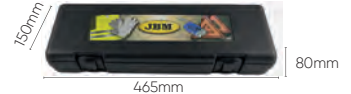

## POCHETTE AVEC RIVET

550 x 90 x 130mm

**51692** 3,25€

0.11	-	100	1200
Kg		Sub	Paq



**51694** 3,55€



**51693** 3,55€

**51696** 3,55€

## POCHETTE MINI 550 x 150mm

**53624** 2,50€

0.05	-	100	3200
Kg		Sub	Paq



**53621** 2,50€

**53623** 2,50€

**53622** 2,50€



## POCHETTE ROUGE AVEC 1 COMPARTIMENT 565 x 100 x 130mm

**51681** 4,50€

0.17	-	100	700
Kg		Sub	Paq



- En tissu réseau et fermeture en velcro.

## POCHETTE NOIR PVC

570 x 110 x 65mm

**51691** 2,40€

0.18	-	100	1600
Kg		Sub	Paq

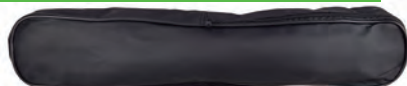

VELCRO



## SAC NOIR AVEC LISERÉ SPÉCIAL

**11328** 4,00€

0.12	-	100	1200
Kg		Sub	Paq



## POCHETTE NYLON VERT SPÉCIAL

470 x 65 x 140mm

**10945** 2,30€

0.12	-	100	1600
Kg		Sub	Paq



VELCRO



## POCHETTE AVEC 6 COMPARTIMENTS

570 x 100 x 130mm

**51680** 2,40€

0.28	-	100	800
Kg		Sub	Paq



VELCRO



- En tissu réseau et fermeture en velcro.  
- Division centrale avec 6 compartiments.

## KIT DE SÉCURITÉ POCLETTE AVEC LISERÉ

METTEZ VOTRE LOGO

x1	<b>53177</b> 11,90€	x2	<b>53181</b> 11,90€
	<b>53178</b> 12,20€		<b>53182</b> 12,20€
	<b>53179</b> 12,20€		<b>53183</b> 12,70€
	<b>53180</b> 12,20€		<b>53184</b> 12,20€

\* Double triangle, obligatoire uniquement en Espagne.

## KIT DE SÉCURITÉ POCLETTE PVC

METTEZ VOTRE LOGO

x1	<b>53185</b> 13,20€	x2	<b>53186</b> 13,20€
----	---------------------	----	---------------------

\* Double triangle, obligatoire uniquement en Espagne.

## KIT DE SÉCURITÉ POCLETTE AVEC RIVET

METTEZ VOTRE LOGO

<b>53087</b> 11,20€	<b>53089</b> 11,50€
<b>53088</b> 11,50€	<b>53090</b> 11,50€

## KIT DE SÉCURITÉ POCLETTE

METTEZ VOTRE LOGO

<b>53091</b> 10,20€	<b>53093</b> 10,30€
<b>53092</b> 10,30€	<b>53094</b> 10,20€

## KIT DE SÉCURITÉ POCLETTE

H1 (12V)    H4 (12V)    H7 (12V)

MK H1

<b>52768</b> 13,80€
<b>52772</b> 13,90€
<b>52776</b> 13,80€
<b>52780</b> 13,90€

MK H4

<b>52769</b> 14,50€
<b>52773</b> 14,60€
<b>52777</b> 15,50€
<b>52781</b> 14,60€

MK H7

<b>52770</b> 23,00€
<b>52774</b> 14,80€
<b>52778</b> 14,60€
<b>52782</b> 14,80€

MK H7+H1

<b>52771</b> 23,40€
<b>52775</b> 15,20€
<b>52779</b> 17,10€
<b>52783</b> 15,20€

\* Double triangle, obligatoire uniquement en Espagne.



KITS DE SÉCURITÉ

## TRIANGLE DE PRESIGNALISATION HOMOLOGUÉ

<b>53778</b>	<b>4,50€</b>		
0,35	-	40	1440
Kg	sub	ff	tr

x1 



RENCONTRE AVEC: E4 27R-032736

<b>52795</b>	<b>5,80€</b>		
0,60	1	20	980
Kg	sub	ff	tr

x1 



RENCONTRE AVEC: E4 27R-032738

## GILET RÉFLÉCHISSANT HOMOLOGUÉ

<b>51817</b>	<b>4,50€</b>		
0,13	-	100	2600
Kg	sub	ff	tr

Bande marqué



RENCONTRE AVEC: EN ISO20471:2013 +A1:2016

<b>50654</b>	<b>4,00€</b>		
0,13	-	100	2600
Kg	sub	ff	tr

Bande marqué



RENCONTRE AVEC: EN ISO20471:2013 +A1:2016

<b>50966</b>	<b>4,00€</b>		
0,12	-	100	2600
Kg	sub	ff	tr

Bande marqué



RENCONTRE AVEC: EN ISO20471:2013 +A1:2016

## IMPERMÉABLE DE SECOURS

<b>50525</b>	<b>1,00€</b>		
0,05	-	250	6250
Kg	sub	ff	tr



## PISTOLET ADAPTABLE POUR AEROSOL

<b>52493</b>	<b>4,50€</b>		
0,06	-	180	2160
Kg	sub	ff	tr

- Accessoire utile fonctionne avec la plupart des spray commercialisé.



## BOMBE ANTI CREVAISON

<b>51814</b>	<b>8,00€</b>		
0,30	-	12	1260
Kg	sub	ff	tr

- Pour réparer la crevaison en moins d'une minute sans besoin de changer la roue ni la démonter.



300ml

## RACLETTE DE DEGIVRAGE

<b>51697</b>	<b>0,80€</b>		
0,03	-	300	6000
Kg	sub	ff	tr



## PARAPLUIE PLIANT

<b>50526</b>	<b>4,80€</b>		
0,20	-	100	2000
Kg	sub	ff	tr



## CISEAUX MINI 9 cm

<b>51925</b>	<b>1,00€</b>		
0,01	100	1000	40000
Kg	sub	ff	tr



## MARTEAU BRISE GLACE ET COUPE CEINTURE

<b>52259</b>	<b>3,75€</b>		
0,15	50	100	2400
Kg	sub	ff	tr

135mm	20mm
75mm	Ø 160mm



## SUPPORT D'AUTO POUR TELEPHONE

<b>53443</b>	<b>7,55€</b>		
0,05	-	100	5000
Kg	sub	ff	tr



CROCHET 

## COUVERTURE THERMIQUE POUR TROUSSES DE PREMIERS SECOURS

<b>15396</b>	<b>2,04€</b>		
0,01	-	200	-
Kg	sub	ff	tr

CE



# CEINTURES DE SÉCURITÉ POUR AUTOCARS

## CEINTURES AVEC 2 POINTS

RENCONTRE AVEC:  
E4-16R-0436213

**50644** 11,60€

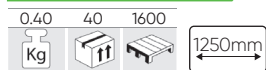

## CEINTURES AVEC 2 POINTS ENROULABLE

RENCONTRE AVEC: E4-16R-0436232

**50717** 21,90€

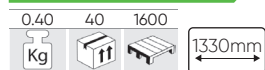

## CEINTURES AVEC 3 POINTS ENROULABLE

RENCONTRE AVEC: E4-16R-0436232

**51266** 28,00€



## SAC EN PVC AVEC ZIP

**14918** 0,23€

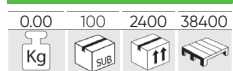

25 x 30cm



**14919** 0,45€

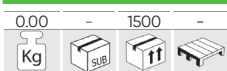

60 x 18 cm



## KIT DE RANGEMENT MULTIFONCTION

**52618** 29,00€



Set de 4 pieces:  
- Coffre flexible 37 l avec couvercle (300mm x 490mm).  
- Bidon circulaire avec couvercle de 180mm Ø. (230mm hauteur).  
- Crochet porte objets sans couvercle (90mm hauteur x 260mm longueur).  
- Plateau (175mm hauteur x 300mm longueur).



## SET DE 3 LAVETTES MICROFIBRE

**53221** 4,75€

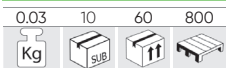

- Lot de 3 chamois en microfibre, 100% polyester de haute qualité.  
- Idéal pour le nettoyage général (dépoussiérage, dégraissage, polissage...)  
- Grande capacité d'absorption des liquides.  
- Sans laisser de filets résiduels.



IDÉAL POUR LE NETTOYAGE GÉNÉRAL DE TOUT VÉHICULE



APPLICATIONS MULTIPLES

GRANDE CAPACITÉ D'ABSORPTION DES LIQUIDES



## GANTS EN NITRILE, VINYLE, CUIR, COTON ...

VOIR PAGE 306



TVA non comprise

**JBM** [www.jbmfrance.fr](http://www.jbmfrance.fr)

301

## BANDE REFLECHISSANTE ADHESIVE

**51935** 135,00€

1.04	-	10	280
Kg	Sub	ff	ff

**51936** 135,00€

1.04	-	10	140
Kg	Sub	ff	ff

50mm 50mm

**51937** 135,00€

1.02	-	10	280
Kg	Sub	ff	ff



- Application à partir du 10 juillet 2011 selon la modification du Règlement Général sur les Véhicules, approuvé par le Royal Décret 2822/1998, du 23 déc. 2010.  
- Bobines indivisibles de 50m.



**APPROBATION: RÈGLEMENT CEPE/ONU 104R**

## LAMPE DYNAMO 2 LEDS

**51573** 2,50€

0.07	12	96	3456
Kg	Sub	ff	ff



PRESENTATION EN BOITE INDIVIDUELLE

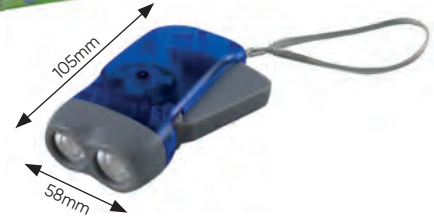

## PLAQUE D'AVERTISSEMENT V-20 "FRET SURDIMENSIONNÉ"

- Plaque pour charges dépassant de l'arrière de tout véhicule: camion / fourgonnette / tourisme / ...  
- Avec l'approbation V20.

- Signalisation obligatoire dans toute l'Europe pour des transports sûrs.  
- Mesure: 500x500mm

**53636** 22,00€

0.45	5	25	750
Kg	Sub	ff	ff

FABRIQUÉ EN POLYPROPYLÈNE POUR UNE MAJEURE FLEXIBILITÉ

**53507** 24,00€

0.75	5	25	800
Kg	Sub	ff	ff

PARTIE AVANT EN POLYMÉTHACRYLATE DE MÉTHYLE (PMMA) ET FACE ARRIÈRE EN ALUMINIUM

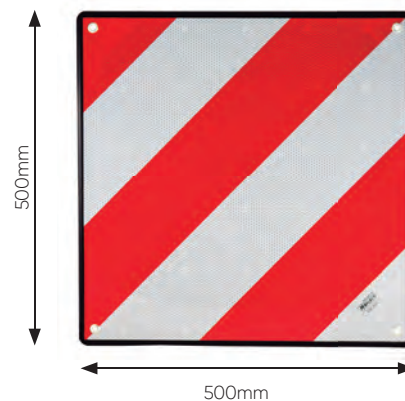
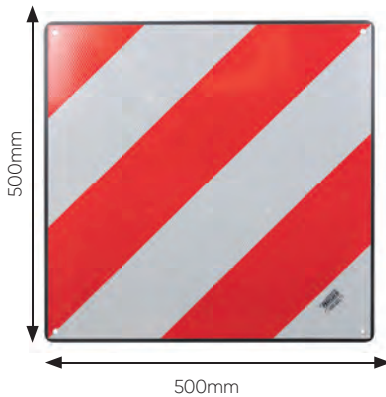

## ARRÊT ANTI-RETOUR

**53561** 28,00€

1.65	-	4	72
Kg	Sub	ff	ff



- Jaune intense pour détecter visuellement de manière facile et rapidement quand il est utilisé.  
- Poids léger: facile à transporter et à manipuler.

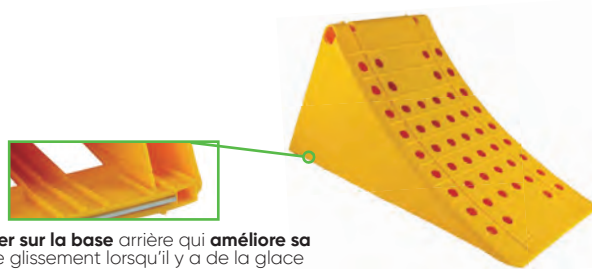
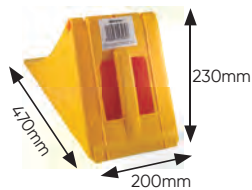

Avec une bande d'acier sur la base arrière qui améliore sa fixation et empêche le glissement lorsqu'il y a de la glace ou du sable sur le sol.



SUPPORT DE L'ARRÊT ANTI-RETOUR

**14118** 26,00€

1.25	4	80
Kg	ff	ff

## COINS D'ARRÊT

**53508** 14,00€

0.35	4	24	288
Kg	Sub	ff	ff

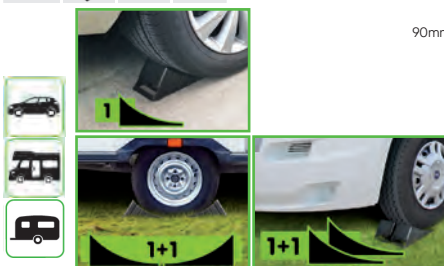

## TROUSSE DE SECOURS - DIN13164: 2022

54042 13,00€

0,40	-	10	600
Kg	Sub	ff	

Une trousse de premiers soins compacte qui est idéale pour le véhicule et le transport. Livrée dans un sac avec fermeture éclair et velcro au dos.

Comprend :

- Sparadrap DIN13019-A 5x2,5
- 1 kit de 14 pièces qui comprend :
  - 4 sparadraps DIN 13019-E 10x6
  - 2 emplâtres élastiques pour les doigts 4x7 cm
  - 2 emplâtres élastiques pour les doigts 12x2 cm
  - 2 bandes imperméables de sparadrap 1,9x7,2 cm
  - 4 bandes imperméables de sparadrap 2,5x7,2 cm
- 1 bande stérile DIN 13151-K 6x8 cm
- 2 bandes stériles DIN 13151-M 8x10 cm
- 1 bande stérile DIN 13151-G 10x12 cm
- 1 pansement de premiers secours DIN 13152-BR 60x40 cm
- 1 pansement de premiers secours DIN 13152-A 60x80 cm
- 2 bandes stériles DIN 61634FB6 6 cm x 400 cm
- 3 bandes stériles DIN 61634FB6 8 cm x 400 cm
- 1 couverture de sauvetage 160x210 cm
- 6 compresses stériles pour plaies 10x10 cm
- 2 bandes triangulaires DIN 13168-D
- 1 ciseaux DIN 58279-A145 145 cm
- 4 gants jetables DIN EN 455-1
- 2 lingettes humides pour nettoyer le cuir
- 1 liste des contenus
- 1 guide de premiers secours



## TROUSSE DE SECOURS DIN13157: 2021

54072 38,50€

1,55	-	10	120
Kg	Sub	ff	

Cette trousse de premiers secours de montage mural comprend les ancrages nécessaires pour accrocher au mur.

Contient :

- 1 sparadrap 5 x 25 - DIN13019-A
- 1 jeu de bandes adhésives 10 x 6 cm (8 pièces) - DIN13019-E
- 6 emplâtres pour les doigts 4 x 6,5 cm
- 6 emplâtres pour les doigts 120 x 20 mm
- 6 emplâtres pour les doigts 7,2 x 1,9 cm
- 12 emplâtres pour les doigts 25 x 72 mm
- 1 jeu de bandes de premiers secours, compresse stérile 6 x 8 cm - DIN13151-K
- 3 jeux de bandes de premiers secours, compresse stérile 8 x 10 cm - DIN13151-M
- 1 jeu de bandes de premiers secours, compresse stérile 10 x 12 cm - DIN13151-G
- 1 compresse stérile (pansement pour brûlures) 60 x 80 cm - DIN13152-A
- 3 bandes stériles pour les plaies (compresses) 100 x 100 mm, 2 pcs/sachet - DIN58953-2
- 2 cache-œil - 55mm x 75mm 1,5 g

- 1 compresse froide pour traitement d'urgence, min. 200 cm<sup>2</sup>
- 1 couverture de premiers secours, 160 x 210 cm, 12 microns
- 2 bandes élastiques conformes aux exigences de la norme (gaze), 6 cm par 400 cm - DIN61634 FB6
- 2 bandes élastiques conformes aux exigences de la norme (gaze), 8 cm par 400 cm - DIN61634 FB8
- 2 bandes triangulaires 96x96x136 cm - DIN13168-D
- 1 ciseaux métal 190 mm - DIN58279-B190
- 2 sacs poubelle en plastique, 300 x 400 mm, 45 microns
- 5 non-tissés 20 x 30 cm, min. 15 g/m<sup>2</sup>
- 1 gants jetables PVC L-AQL1.5 (kit de 4 pièces) - DIN EN 455-1
- 1 livret d'informations



## TROUSSE DE SECOURS

51246 6,40€

0,20	-	50	800
Kg	Sub	ff	

Contient:

- 1 Prospectus premiers secours
- 1 Ciseaux
- 1 Pair de gants en latex
- 2 Lingettes alcoolisées
- 2 Lanières adhésifs
- 25g. de coton
- 1 Sac avec 5 bandages 20x20cm
- 1 Voie
- 1 Rol de sparadrap
- Dim. sac: 180x130x55mm



## PORTE PLAQUE IMMATRICULATION

51412 2,10€

0,09	-	100	3000
Kg	Sub	ff	

- Dimensions : 53,20 cm x 13,70 cm.
- Zone de marquage : 52 cm x 1,60 cm.

TYPON ET SÉRIGRAPHIE NON INCLUS

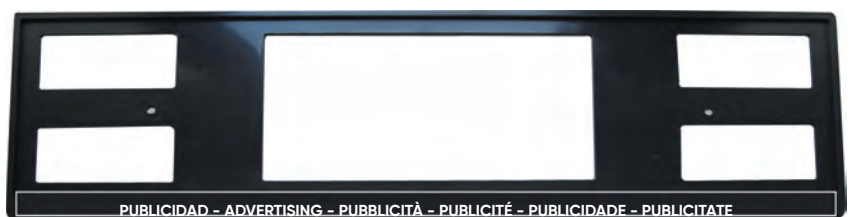

PUBLICIDAD - ADVERTISING - PUBBLICITÀ - PUBLICITÄ - PUBLICIDADE - PUBLICITATE

## SUPPORT DE RÉPARATION DE VÉLO

53919 81,00€

30 KG

785 - 1 28  
Kg sub ff

- Matériau: acier Q195, ABS, nylon
- Dimensions en état assemblé: 198x104 cm
- Hauteur réglable: 107 à 188 cm
- Longueur du tube transversal pivotant: 37 cm
- Longueur du support: 69 cm
- Diamètre du tube transversal pivotant: 35 mm
- Diamètre du tube télescopique: 35 mm
- Diamètre du tube principal: 38 mm
- Diamètre du tube de support: 25 mm
- Capacité maximale: 30 kg

POUR TOUS LES TYPES DE VÉLOS  
VÉLO DE VILLE / ROUTE / VTT



PINCE RÉGLABLE À DÉGAGEMENT RAPIDE (360°)



En ABS renforcé et nylon pour faire tourner le vélo à n'importe quel angle et sans endommager la peinture.



DIMENSIONS DU PLATEAU À OUTILS MULTIFONCTIONNEL 25x13cm



CONCEPTION ANTIDÉRAPANTE 4 PIEDS



TIGE RÉGLABLE DE FIXATION: 50 À 90CM

## POMPE À PLANCHER POUR BICYCLETTE

54166 32,40€

0,90 - 5 100  
Kg sub ff

32mm 530mm



presta dunlop schrader



## POMPE À MAIN PORTABLE POUR VÉLO

54170 16,50€

0,12 5 50 2560  
Kg sub ff

21mm 195mm



presta schrader



100 PSI AI

## KIT D'OUTILS POUR VÉLO - 20 PCS

54073 70,00€

2,00 - 5 240  
Kg sub ff

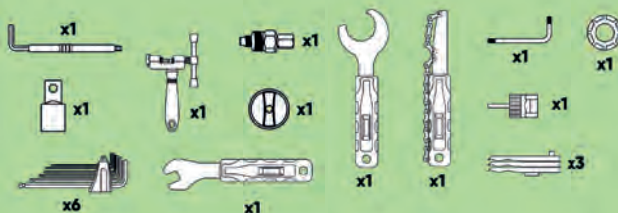

## OUTIL DE RÉPARATION DE VÉLO MULTIFONCTIONNEL

54074 18,50€

0,17 12 48 1008  
Kg sub ff



## ANTIVOL VÉLO À COMBINAISON

54169 13,80€

0,30 5 60 360  
Kg sub ff

S PVC  
10mm 1000mm





## PELLE PLIABLE

51858 15,00€

0,96	-	20	320
Kg	Sub	ff	ff

- Fabriqué en métal résistant.
- Plié: 240mm.
- Déplié: 600mm.



## PELLE EXTENSIBLE ALUMINIUM

53033 21,50€

0,63	-	5	50
Kg	Sub	ff	ff

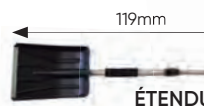

## PELLE MÉTALLIQUE

52187 21,80€

1,60	-	1	120
Kg	Sub	ff	ff



## PELLE MÉTALLIQUE

52251 21,80€

1,74	-	1	120
Kg	Sub	ff	ff



## RADAR DE RECUIL AVEC TÉMOIN VISUEL ET ACOUSTIQUE

51863 54,00€

0,70	5	20	200
Kg	Sub	ff	ff



- Tension nominale: dc 12 v.
- Puissance: 3,6 w.
- Température de travail: -20° à 70°.
- 4 Capteurs de rapprochement.
- Distance de détection: 0,3-2,0 m.
- Angle de détection: h>60°, v>60°.
- Radiofréquence: 315 mhz / 433 mhz.
- Angle de la chambre: 92 ou 120°.
- Inclut un indicateur de 2 couleurs de marquage de rapprochement.
- Capteurs couleur noir pas peindre.



## CORDE MULTIUSAGE 30M

53964 9,65€

0,70	5	20	240
Kg	Sub	ff	ff



53965 25,80€

1,85	5	10	120
Kg	Sub	ff	ff



## RADAR DE RECUIL AVEC TÉMOIN ACOUSTIQUE

51973 45,00€

0,54	5	20	200
Kg	Sub	ff	ff

- Tension nominale: dc 12 v.
- Puissance: 3,6w.
- Température de travail: -20° à 70°.
- 4 Capteurs de rapprochement.
- Distance de détection: 0,3-2,0 m.
- Angle de détection: h>60°, v>60°.
- Radiofréquence: 315 mhz / 433 mhz.
- Angle de la chambre: 92 ou 120°.
- Sans indicateur visuel.
- Inclut une sonnerie de 4cm de diamètre.



## RADAR DE RECUIL AVEC ALARME 8 CAPTEURS

52742 64,00€

0,91	5	20	200
Kg	Sub	ff	ff

- Avant + arriere.
- Alarme par voix.
- 4 Capteurs arriere.
- Résistant à la pluie et mauvais temps.
- Pièces de rechange disponibles.
- Les capteurs peuvent être peints.



## JEU DE 4 TAPIS EN CAOUTCHOUC UNIVERSELLE - REVERSIBLE

**50585** 14,70€

2,86	-	8	208
Kg	Sub	ff	ff

- Caoutchouc de haute qualité.
- Très résistant.
- Adaptable à la plus part des véhicules.

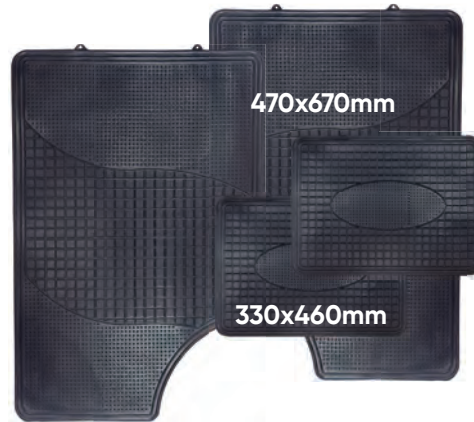

REVERSIBLE!

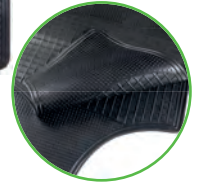

PRÉSENTOIR POUR TAPIS

**METEXP** 62,00€

6,00	-	1
Kg	Sub	ff

## JEU DE 4 TAPIS EN CAOUTCHOUC UNIVERSELLE

**53241** 9,00€

1,65	-	12	288
Kg	Sub	ff	ff

- Caoutchouc de haute qualité.
- Très résistant.
- Adaptable à la plus part des véhicules.

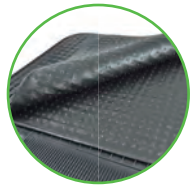

3 PCS



PRÉSENTOIR POUR TAPIS

**METEXP** 62,00€

6,00	-	1
Kg	Sub	ff

## JEU DE 4 TAPIS EN MOQUETTE

**52530** 14,00€

2,00	-	8	160
Kg	Sub	ff	ff

- 2 Avant (390mm).
- 2 Arrière (365x480mm).
- Lége, confortable, avec talonnet plastique.
- Revers anti derrapant.



PRÉSENTOIR POUR TAPIS

**METEXP** 62,00€

6,00	-	1
Kg	Sub	ff

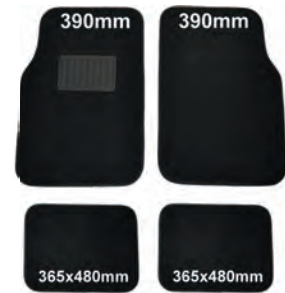

## JEU DE 4 TAPIS EN MOQUETTE

TALONNETE COULEUR ALUMINIUM

**52534** 15,00€

1,55	-	8	160
Kg	Sub	ff	ff

- 2 Avant (425x660mm).
- 2 Arrière (295x425mm).
- Lége, confortable, avec talonnet plastique.
- Revers anti derrapant.

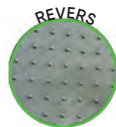

TALONNETE MOQUETE

**52535** 16,50€

1,55	-	8	160
Kg	Sub	ff	ff

PRÉSENTOIR POUR TAPIS

**METEXP** 62,00€

6,00	1	25
Kg	ff	ff



# BALAI D'ÉSSUIE-GLACE UNIVERSEL



**INSTALLATION FACILE**

**GRANDE PUISSANCE DE NETTOYAGE À GRANDE VITESSE**

**99%**

Installation facile de l'adaptateur dans plus de 99% des véhicules.

**38dB**

L'ergonomie et l'élimination des pièces de poids réduisent le bruit de 38 dB.

**30%**

Pression de longueur de brosse uniforme grâce au ressort en acier pour une meilleure visibilité que les brosses d'origine et une performance supérieure de 30%.

**100%**

100% caoutchouc naturel résistant à toutes les conditions météorologiques extrêmes.

**160km/h**

Conception aérodynamique qui permet une utilisation jusqu'à 160 km/h.

**45°**

Angle de coupe à 45° et précision du nettoyage transversal qui élimine les plus petites gouttes.



**11 ADAPTEURS DIFFÉRENTS: POUR DES APPLICATIONS MULTIPLES**



REF.	DÉSCRIPTION	Kg	10	50	800	€
53745	11" 280mm	0,20	10	50	800	6,40€
53746	12" 310mm	0,20	10	50	800	6,40€
53747	13" 330mm	0,20	10	50	600	6,40€
53748	14" 350mm	0,20	10	50	800	6,60€
53749	15" 380mm	0,20	10	50	800	6,70€
53750	16" 410mm	0,20	10	50	800	6,70€
53751	17" 430mm	0,20	10	50	550	6,80€
53752	18" 460mm	0,25	10	50	800	6,95€
53753	19" 480mm	0,25	10	50	600	7,10€
53754	20" 510mm	0,25	10	50	600	7,40€
53755	21" 530mm	0,25	10	50	600	7,50€
53756	22" 560mm	0,25	10	50	700	7,90€
53757	24" 610mm	0,25	10	50	550	7,90€
53758	26" 650mm	0,30	10	50	550	8,20€
53759	28" 700mm	0,30	10	50	550	8,50€
53760	30" 750mm	0,30	10	50	500	9,60€



**12 PCS**

## PRÉSENTOIR

**JBMWEXP 24,50€**

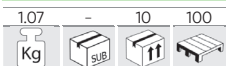

# MASSE ÉQUILIBRAGE AUTOCOLLANTES DE 45 g. (SEGMENT DE 5g - 10g - 5g - 10g - 5g - 10g)

**50600**

0,60€

0,05	100	400	36000
Kg	sub	ff	sub

ZINC



**50601**

0,29€

0,05	100	400	48000
Kg	sub	ff	sub

FER



## MASSE D'ÉQUILIBRAGE AUTOCOLLANTES 60g.

**52665**

0,37€

0,06	100	400	37600
Kg	sub	ff	sub

5gr x 12 u.



- Fer.  
- Adherence optimale et de longue durée.

**52666**

0,36€

0,06	100	400	37600
Kg	sub	ff	sub

5gr x 4 u.

10gr x 4 u.

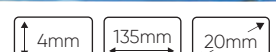

### MASSES D'ÉQUILIBRAGE EN ZINC SPÉCIAL JANTE UNIVERSELLE

REF.	g.	Kg	sub	ff	sub	€
50760	5g.	0.01	100	1600	80000	0,10€
50761	10g.	0.01	100	1600	102400	0,19€
50762	15g.	0.02	100	800	76800	0,29€
50763	20g.	0.02	100	800	64000	0,38€
50764	25g.	0.03	100	800	48000	0,49€
50765	30g.	0.03	100	600	50400	0,58€
50766	35g.	0.04	100	400	32000	0,68€
50767	40g.	0.04	100	400	25600	0,78€
50768	45g.	0.05	100	400	32000	0,88€
51055	50g.	0.05	100	400	2000	0,98€



### MASSES D'ÉQUILIBRAGE EN ZINC SPÉCIAL JANTE ALLIAGE

REF.	g.	Kg	sub	ff	sub	€
50778	5g.	0.01	100	1600	80000	0,10€
50779	10g.	0.01	100	800	76800	0,19€
50780	15g.	0.02	100	1200	60000	0,29€
50781	20g.	0.02	100	800	80000	0,38€
50782	25g.	0.03	100	800	48000	0,49€
50783	30g.	0.03	100	600	30000	0,58€
50784	35g.	0.04	100	400	32000	0,68€
50785	40g.	0.04	100	400	32000	0,78€
50786	45g.	0.05	100	400	32000	0,88€
51604	50g.	0.05	100	400	2000	0,98€



## MASSES ÉQUILIBRAGE PL

SEGMENTATION DE 50G

**52667**

0,76€

0,05	50	400	25600
Kg	sub	ff	sub



SEGMENTATION DE 100G

**52668**

1,49€

0,10	25	200	12800
Kg	sub	ff	sub



SEGMENTATION DE 150G

**52669**

2,22€

0,15	20	160	10240
Kg	sub	ff	sub



SEGMENTATION DE 200G

**52670**

2,95€

0,20	10	80	5120
Kg	sub	ff	sub



SEGMENTATION DE 250G

**52671**

3,70€

0,25	10	80	5120
Kg	sub	ff	sub



SEGMENTATION DE 300G

**52672**

4,45€

0,30	10	80	5120
Kg	sub	ff	sub



# ROULEAU DE MASSES AVEC DÉVIDOIRE AUTOCOLLANTES EN FER DE 5g.

- 1.000 pastilles de 5g de contreponds en fer. / Autocollantes avec 4 mm d'épaisseur. / Dimensions du devidoir: 29,5 cm x 29,5cm.

**51908** 44,00€

5,60 - 4 - 240

Kg SUB ff



Avec aimant de retenue de reste.

**53256** 34,00€

5,30 - 4 - 240

Kg SUB ff



## COFFRET DE MASSES UNIVERSELLE

**53864** 138,00€

10,50 - 1 - 71

Kg SUB ff

MASSE D'ÉQUILIBRAGE AUTOCOLLANTES  
60gr: 4x10gr 4x5gr - 70u. (ref. 52666)

80mm  
540mm  
280mm

MASSES ÉQUILIBRAGE EN ZINC AVEC AGRAFE	
SPÉCIAL JANTE UNIVERSELLE	SPÉCIAL JANTE ALLIAGE
5g - 20 uds (ref. 50760)	5g - 20 uds (ref. 50778)
10g - 20 uds (ref. 50761)	10g - 20 uds (ref. 50779)
15g - 20 uds (ref. 50762)	15g - 20 uds (ref. 50780)
20g - 20 uds (ref. 50763)	20g - 20 uds (ref. 50781)
25g - 20 uds (ref. 50764)	25g - 20 uds (ref. 50782)
30g - 10 uds (ref. 50765)	30g - 10 uds (ref. 50783)
35g - 10 uds (ref. 50766)	35g - 10 uds (ref. 50784)
40g - 10 uds (ref. 50767)	40g - 10 uds (ref. 50785)



## KIT DE RÉPARATION DE CREVAISONS COMPRESSEUR DE LIQUIDE ET D'AIR

**54013** 35,00€

1,15 - 5 - 20 - 200

Kg SUB ff

- Scelle les crevaisons jusqu'à 6 mm de diamètre.  
- Jusqu'à 60 crevaisons peuvent être évitées en appliquant une seule fois du liquide sur le pneu.  
- Le matériau ne corrode pas le métal et le caoutchouc.  
- Liquide non inflammable et résistant au gel avec une longue durée de vie.

SCÉLLANT POUR PNEUS - 500 ML

**15300** 5,00€

0,50 - 12 - 936

Kg SUB ff



OUTIL POUR VALVES

**11960** 1,50€

0,01 - 10 - 500

Kg SUB ff



SAC POUR KIT

**15317** 4,50€

0,10 - 500

Kg SUB ff



COMPRESSEUR D'AIR

**53150** 24,00€

0,55 - 10 - 40 - 640

Kg SUB ff



## COMPRESSEUR D'AIR

**53150** 24,00€

120mm 165mm 55mm

0,55 - 10 - 40 - 640

Kg SUB ff

- Appliquer aux voitures: voiture familiale, SUV, Etc.



- DC 12V
- 100W
- 150 PSI 10 BAR
- 10A
- 16L/min
- 30mm

## VALVES TPMS

**12902** 4,50€

0,01 - 4 - 100 - 1500

Kg SUB ff

4,25 Nm  
OE 72-20-223

**12920** 7,80€

0,02 - 4 - 100 - 1500

Kg SUB ff

4 Nm (screw)  
4 Nm (nut)

**12910** 4,40€

0,01 - 4 - 100 -

Kg SUB ff

75 Nm  
OE 72-20-206, TPK65655

**12924** 4,10€

0,01 - 4 - 100 - 1500

Kg SUB ff

1,4 Nm (screw)  
4,0 Nm (nut)  
OE 72-20-116

**53723** 68,00€

0,05 - 50 - 6000

Kg SUB ff

EU-PRO HYBRID 3.5

**12908** 4,50€

0,01 - 4 - 100 -

Kg SUB ff

4,25 Nm  
OE 72-20-205, TPK65654

**12923** 9,50€

0,01 - 4 - 100 - 1500

Kg SUB ff

8 Nm  
OE TPK43211

**12915** 12,40€

0,04 - 4 - 100 - 1000

Kg SUB ff

8 Nm (nut)  
1,4 Nm (screw)  
OE 72-20-116

**12925** 10,70€

0,02 - 4 - 100 -

Kg SUB ff

# KIT DÉPANNAGE TUBELESS

**52662** 36,50€

0,63 - 10 600

Kg SUB

**52663** 30,00€

1,20 - 10 320

Kg SUB



## MÈCHE DE RECHANGE POUR REF. 52662/52663

**12973** 1,00€

0,01 10 500

Kg SUB

x5

## OUTIL DE PERFORATION REF. 52663

**13806** 10,50€

0,35 5 50

Kg SUB

## OUTIL POUR INSERTION DE MECHES REF. 52663

**13805** 10,50€

0,50 50

Kg SUB

- 1 x Fraise
- 1 x Outil d'insertion
- 1 x Outil de gonflage
- 4 x Compressed air bottles
- 1 x Cutter
- 10 x Meches
- 1 x Outil demonte obus

- 1 x Outil d'insertion
- 1 x Fraise
- 1 x Rechange outil insertion
- 1 x Cutter
- 20 x Meches
- 1 x Lubrifiant

## OUTIL POUR VALVES

**52653** 3,00€

0,03 10 250 6000

Kg SUB

- Pour monter et demonter les valves.



## OUTIL DE REPARATION DE VALVES

**52652** 2,80€

0,03 25 100 7200

Kg SUB



## PINCE MASSES ÉQUILIBRAGE

**51355** 19,00€

0,45 5 50 -

Kg SUB

- Extrait facilement et remplace le contrepois.
- Coupe et plie facilement.
- Fait en acier renforcé à la chaleur.
- Inclut manche ergonomique.
- Avec ressort automatique en ouvert dans la poignée pour faciliter son opération.



## COFFRET SPÉCIALE VALVERIE

**52673** 18,00€

0,23 - 25 875

Kg SUB



### EST ÉGALEMENT DISPONIBLE

**11900** 3,50€

Bouchon en aluminium pour valves dans blister de 4 unités

**11901** 2,50€

Bouchon de plastique vert pour valves dans blister de 4 unités

**11902** 3,50€

Bouchon de plastique noir pour valves dans blister de 4 unités

### CONTIENT

**11903** 5,00€

Pochette 16 unités bouchon alu

**11905** 1,50€

Pochette 50 unités bouchon plastique noir

**11907** 11,00€

Pochette 50 unités obus haute pression

**11904** 2,00€

Pochette 16 unités bouchon alu

**11906** 8,50€

Pochette 50 unités obus standar

**11960** 1,50€

Extractor obuses

## KIT DE MONTAGE / SERRAGE VALVES TPMS

**52818** 148,00€

1,38 - 10 -

Kg SUB

- Définir plusieurs outils spécialement conçus pour montage et démontage facile des capteurs TPMS.  
- Il a tous les outils de l'opérateur a besoin de faire un changement rapide, avec un minimum d'effort et en toute sécurité.

- ① 2-14 NM
- ② 0,5-3,5 NM
- ③ 2x Ø 11, 12mm
- ④ 3x T10, T15, T20
- ⑤ 150mm
- ⑥ 2mm
- ⑦ 0,25 Nm
- ⑧ 0,45 Nm



## VALVES EN POCLETTE

TR413

**51741** 0,50€

0,01	100	1000	48000
Kg	Sub	ft	ft



TR414

**51742** 0,50€

0,01	100	1000	48000
Kg	Sub	ft	ft



TR418

**51743** 0,55€

0,02	100	1000	48000
Kg	Sub	ft	ft



## TIRE VALVES

- Pour monter les valves dans des jantes aluminium.

METAL

**52649** 5,00€

3,20	10	50	2250
Kg	Sub	ft	ft



PLASTIQUE

**52650** 5,00€

0,15	10	100	2400
Kg	Sub	ft	ft



## ROULETTE POUR PNEU

**52842** 11,00€

0,15	10	100	1500
Kg	Sub	ft	ft

38mm



## SET DE 3 PROTECTEURS DE JANTES

**53419** 9,70€

0,10	10	100	600
Kg	Sub	ft	ft

3 PCS



## CLÉ EN CROIX CROISEMENT SOUDÉ

**51661** 12,00€

1,17	5	20	480
Kg	Sub	ft	ft

355mm 17, 19, 21mm

1/2"



**52881** 17,00€

1,40	-	10	420
Kg	Sub	ft	ft

400mm 17, 19, 21, 22mm

1/2"



**52880** 42,00€

3,75	-	5	100
Kg	Sub	ft	ft

700mm 24, 27, 32mm

3/4"



## CLÉ TÉLESCOPIQUE À DOUILLE REVERSIBLE

**51416** 12,00€

1,05	10	20	600
Kg	Sub	ft	ft

330-490mm

1/2"



DOUILLE CHROMÉE

21mm /23mm

17mm /19mm



# TÊTE COMPOSITE UNIVERSELLE POUR DEMONTE-PNEUS

**52657** 37,50€

0,18	5	20	800
Kg	Sub	ff	Sub



**52658** 39,70€

0,17	-	20	800
Kg	Sub	ff	Sub



**52659** 39,70€

0,26	-	20	1920
Kg	Sub	ff	Sub



## PINCE REPOUSSE TALON

**52655** 39,70€

0,39	-	25	1500
Kg	Sub	ff	Sub

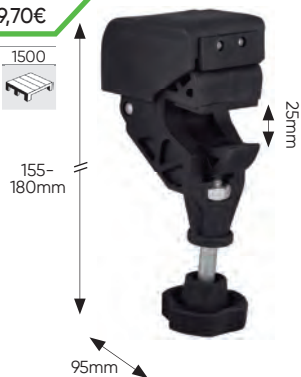

**52656** 39,50€

0,40	5	20	1920
Kg	Sub	ff	Sub



## LEVIER DEMONTE PNEUS

**51362** 3,00€

0,15	5	60	500
Kg	Sub	ff	Sub

**51358** 7,50€

0,47	6	24	1008
Kg	Sub	ff	Sub

**51359** 9,00€

0,90	6	30	1440
Kg	Sub	ff	Sub



## LEVIER DEMONTE PNEUS SPECIALE PL

**52664** 168,00€

12,30	-	1	15
Kg	Sub	ff	Sub



## MACHINE DE MONTAGE MANUELLE DE PNEUS

**53605** 141,00€

16,00	-	1	21
Kg	Sub	ff	Sub

950mm

1 poignée pour enlever les pneus de 37 pouces de long.  
Outil de montage / démontage.

- Applicabilité: tous les pneus de 8 pouces jusqu'aux pneus de camion léger (7-1/2 pouces x 16 pouces).
- Perméabilité: jusqu'à 12,5 L 16.
- Complétude:



## CHARIOT À PNEUS AVEC ROULETTES

**54198** 59,00€

4,25	-	1	35
Kg	Sub	ff	Sub



66x66x11cm

- Quatre roulettes pivotantes de 3" (dont une verrouillable).
- Poignée latérale pour un transport simplifié
- Capacité de charge : 136 kg
- Dimensions : 66 x 66 x 11 cm



- Poids : 3,4 kg
- Couleur : noir
- Matériau des roues : acier + TPR
- Matériau du corps : plastique

## MACHINE DE MONTAGE MANUELLE DE PNEUS

**54136** 107,00€

5,25	-	2	144
Kg	Sub	ff	Sub

257mm 162mm 110mm

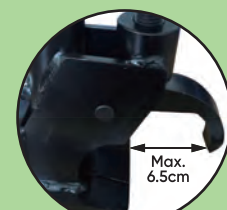





# SOUFFLET DE CARDANS UNIVERSEL EN NEOPRENE

POUR TOURISME

**51705** 8,45€

0,23	-	20	400
Kg	sub	ff	ff



POUR CAMIONETTE

**51703** 10,50€

0,28	-	20	320
Kg	sub	ff	ff



RECHANGE POUR  
REF. 51703

<b>13739</b>	0,15	100	1600
5,50€	Kg	sub	ff



RECHANGE POUR  
REF. 51705

<b>13738</b>	0,08	150	2400
3,50€	Kg	sub	ff



## KIT DE SOUFFLET POUR DIRECTION UNIVERSELLE

**52644** 8,80€

0,19	-	20	400
Kg	sub	ff	ff

NÉOPRÈNE



LUBRIFIANT POUR KIT  
UNIVERSEL DE LA BOTTE

<b>13880</b>	0,01	600	21000
1,50€	Kg	sub	ff

RECHANGE POUR  
REF. 52644

<b>13740</b>	0,10	72	-
5,50€	Kg	sub	ff



## EXPANDEUR SOUFFLETS DE CARDANS

**52829** 19,00€

0,45	-	10	200
Kg	sub	ff	ff

EXTÉRIEUR INTÉRIEUR

Ø 10cm Ø 9,5cm

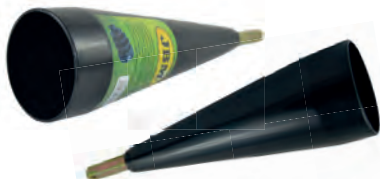

## EXPANDEUR SOUFFLETS DE CARDANS PNEUMATIQUE

**51861** 199,00€

4,00	-	2	32
Kg	sub	ff	ff

- Matière: Aluminium.  
- Ouverture de 20 à 100mm.



**9 bar**  
(125 PSI)

## ENSEMBLE SPÉCIAL INTERCHANGEABLE POUR LES JOINTS HOMOCINÉTIQUES

**SERIE124** 710,00€

22,15	-	-	20
Kg	sub	ff	ff

SAC DE GRAISSE

**13879** 1,38€

0,09	-	150	5250
Kg	sub	ff	ff



**51861** x1

**52633** x100

**13738** x100

**13879** x100

## BOÎTE DE 100 SOUFFLETS DE CARDANS

**53693** 521,00€

19,80	-	1	20
Kg	sub	ff	ff



x100  
**13738**



x100  
**52633**



x100  
**13879**

## BOÎTE DE 100 SOUFFLETS DE CARDANS POUR VAN

**53698** 717,00€

19,80	-	1	24
Kg	sub	ff	ff



x100  
**13739**



x100  
**52633**



x100  
**13880**

## BOÎTE DE 80 SOUFFLET POUR DIRECTION UNIVERSELLE

**53695** 504,00€

11,25	-	1	24
Kg	sub	ff	ff



x80  
**13740**



x80  
**52633**



x80  
**13880**

TUBES FLEXIBLES



## **SÉCURITÉ ET EPI**

- 316 GANTS / EPIS
- 318 TROUSSES DE PREMIERS SOINS
- 319 MASQUES / DISPENSEURS
- 320 CAMÉRAS THERMIQUE / THERMOMÈTRES  
/ DÉTERGENTS DE SURFACE / NETTOYANTS
- 321 DISTANCE DE SÉCURITÉ
- 322 DÉSINFECTION D'ESPACES / OZONEMÈTRE

## GANTS DE TRAVAIL RENFORCÉS POLYURETHANE

<b>REF.</b>	1,54€		
0.05	12	144	3456
Kg	sub	ff	ff

51640N T.8  
51642N T.9  
51636N T.10  
51638N T.11

EN 388 3131  
CE CAT-II

## GANTS DE TRAVAIL RENFORCÉS EN NITRILE

<b>REF.</b>	1,74€		
0.04	12	144	3456
Kg	sub	ff	ff

51633 T.8  
51634 T.9  
51632N T.10  
51398N T.11

EN 388 3121X  
CE CAT-II

## GANTS TRICOTÉS ANTIDERAPANT

<b>51785</b>	0,75€		
0.04	12	300	3600
Kg	sub	ff	ff

CE

PALME RENFORCÉE

## GANTS TRICOTÉS

<b>51745</b>	0,70€		
0.05	12	144	4320
Kg	sub	ff	ff

CE

## GANTS EN CUIR ET TOILE

<b>52310</b>	3,65€		
0.20	12	120	1920
Kg	sub	ff	ff

CE

## GANTS EN PEAU

<b>52738</b>	5,00€		
0.10	12	144	2304
Kg	sub	ff	ff

T.9  
CE EN388: 16 2121X

<b>52739</b>	5,00€		
0.12	12	144	2304
Kg	sub	ff	ff

T.10

## GANTS DE TRAVAIL

<b>REF.</b>	19,00€		
0.15	12	60	2040
Kg	sub	ff	ff

54188 T.8  
54189 T.9  
54190 T.10  
54191 T.11

EN 388 3131  
CE

## GANTS DE TRAVAIL THERMIQUES

<b>REF.</b>	8,90€		
0.15	12	144	3456
Kg	sub	ff	ff

54192 T.8  
54193 T.9  
54194 T.10  
54195 T.11

AUTOMOBILE INDUSTRIE  
TECHNIQUE  
ANTI-COÛTE  
EN 511 EN 388 3131

## GANTS DE TRAVAIL SPÉCIAL ÉCRAN TACTILE

<b>52570</b>	2,60€	<b>T.8</b>		
0.03	12	144	3456	EN 388 3131X
Kg	sub	ff	ff	

<b>52571</b>	2,60€	<b>T.9</b>		
0.03	12	144	2592	EN 388 3131X
Kg	sub	ff	ff	

<b>52572</b>	2,60€	<b>T.10</b>		
0.03	12	144	2592	EN 388 4131
Kg	sub	ff	ff	

<b>52573</b>	2,60€	<b>T.11</b>		
0.04	12	144	2592	EN 388 4131
Kg	sub	ff	ff	

### POUR ÉCRAN TACTILE

CE

# BÔTE DE GANTS NITRILE

JBM	REF.	DÉSCRIPT ION	Kg			€	
	<b>3.5 MIL</b>						
	54294	S	0,40	100	10	500	8,80€
53984	M	0,50	100	10	400	8,80€	
53985	L	0,50	100	10	400	8,80€	
53986	XL	0,55	100	10	400	8,80€	



JBM	REF.	DÉSCRIPTION	Kg			€	
	<b>3.5 MIL</b>						
	54155	M	0,50	100	10	570	8,80€
54156	L	0,50	100	10	570	8,80€	
54157	XL	0,50	100	10	570	8,80€	



EN 420:  
2003 + A1: 2009



EN ISO  
374-5: 2016

JBM	REF.	DÉSCRIPTION	Kg			€	
	<b>5.0 MIL</b>						
	54151	M	0,62	100	10	510	10,90€
54152	L	0,62	100	10	510	10,90€	
54153	XL	0,67	100	10	510	10,90€	

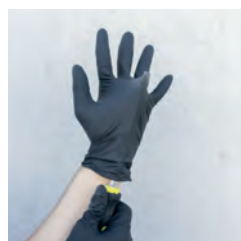

JBM	REF.	DÉSCRIPTION	Kg			€	
	<b>7.0 MIL</b>						
	53551	M	0,90	<b>100</b>	10	300	18,95€
53552	L	1	<b>100</b>	10	300	18,95€	
53553	XL	1	90	10	300	18,95€	



**100  
PZ**

EN ISO  
374-5: 2016

EN 420:  
2003 + A1: 2009

JBM	REF.	DÉSCRIPTION	Kg			€	
	<b>7.0 MIL</b>						
	54177	M	0,90	<b>100</b>	10	300	18,95€
54178	L	0,90	<b>100</b>	10	300	18,95€	
54179	XL	0,90	90	10	300	18,95€	



**CE**

EN ISO  
374-1:2016/Type B

JKPT

**51817** 4,50€



Bande marqué

**50966** 4,00€



**50654** 4,00€



**HOMOLOGUÉ**  
ISO20471:2013



TVA non comprise

## LUNETTES DE PROTECTION SPORTIVES, AVEC PROTECTION ANTI-BUÉE

53598 3,95€

RENCONTRE AVEC: EN166:2002-04 / EN166:2003-01

53596 3,65€

53597 3,70€



PRÉSENTOIR DE 12 UNITÉS

0,01	12	144	2016
Kg	sub	ft	ft



53596, 53597, 53598



53597

## LUNETTES DE PROTECTION AVEC PROTECTION ANTI-BUÉE

53785 4,80€

RENCONTRE AVEC: EN166:2002-04

0,05	14	112	896
Kg	sub	ft	ft

- Protection directe contre les liquides et les bactéries.
- Bande élastique réglable.
- Traitement des verres antibuée



Valves intégrées pour empêcher le vide à l'intérieur.



## CASQUE ANTI-BRUIT

52430 10,90€

0,34	6	24	96
Kg	sub	ft	ft



PVC

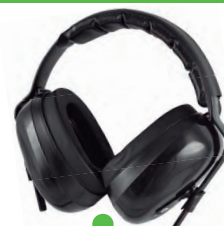

ABS

RENCONTRE AVEC: EN352 - 1:2003

## TROUSSE DE SECOURS - DIN13164

54042 13,00€

Une trousse de premiers soins compacte qui est idéale pour le véhicule et le transport. Livrée dans un sac avec fermeture éclair et velcro au dos.

0,40	-	10	320
Kg	sub	ft	ft

Comprend :  
Sparadrapp DIN13019-A 5x2,5  
1 kit de 14 pièces qui comprend :  
• 4 sparadraps DIN 13019-E 10x6  
• 2 emplâtres élastiques pour les doigts 4x7 cm  
• 2 emplâtres élastiques pour les doigts 12x2 cm  
• 2 bandes imperméables de sparadrapp 1,9x7,2 cm  
• 4 bandes imperméables de sparadrapp 2,5x7,2 cm

1 bande stérile DIN 13151-K 6x8 cm  
2 bandes stériles DIN 13151-M 8x10 cm  
1 bande stérile DIN 13151-G 10x12 cm  
1 pansement de premiers secours DIN 13152-BR 60x40 cm  
1 pansement de premiers secours DIN 13152-A 60x80 cm  
2 bandes stériles DIN 61634FB6 6 cm x 400 cm  
3 bandes stériles DIN 61634FB6 8 cm x 400 cm

1 couverture de sauvetage 160x210 cm  
6 compresses stériles pour plaies 10x10 cm  
2 bandes triangulaires DIN 13168-D  
1 ciseaux DIN 58279-A145 145 cm  
4 gants jetables DIN EN 455-1  
2 lingettes humides pour nettoyer le cuir  
1 liste des contenus  
1 guide de premiers secours



## TROUSSE DE SECOURS DIN13157: 2021

54072 38,50€

Cette trousse de premiers secours de montage mural comprend les ancrages nécessaires pour accrocher au mur.

1,55	-	10	120
Kg	sub	ft	ft

Contient :

1 sparadrapp 5 x 25 - DIN13019-A  
1 jeu de bandes adhésives 10 x 6 cm (8 pièces) - DIN13019-E  
6 emplâtres pour les doigts 4 x 6,5 cm  
6 emplâtres pour les doigts 120 x 20 mm  
6 emplâtres pour les doigts 7,2 x 1,9 cm  
12 emplâtres pour les doigts 25 x 72 mm  
1 jeu de bandes de premiers secours, compresse stérile 6 x 8 cm - DIN13151-K  
3 jeux de bandes de premiers secours, compresse stérile 8 x 10 cm - DIN13151-M  
1 jeu de bandes de premiers secours, compresse stérile 10 x 12 cm - DIN13151-G  
1 compresse stérile (pansement pour brûlures) 60 x 80 cm - DIN13152-A  
3 bandes stériles pour les plaies (compresses) 100 x 100 mm, 2 pcs/sachet - DIN58953-2  
2 cache-œil - 55mm x 75mm 1,5 g

1 compresse froide pour traitement d'urgence, min. 200 cm2  
1 couverture de premiers secours, 160 x 210 cm, 12 microns  
2 bandes élastiques conformes aux exigences de la norme (gaze), 6 cm par 400 cm - DIN61634 FB6  
2 bandes élastiques conformes aux exigences de la norme (gaze), 8 cm par 400 cm - DIN61634 FB8  
2 bandes triangulaires 96x96x136 cm - DIN13168-D  
1 ciseaux métal 190 mm - DIN58279-B190  
2 sacs poubelle en plastique, 300 x 400 mm, 45 microns  
5 non-tissés 20 x 30 cm, min. 15 g/m2  
1 gants jetables PVC L-AQL1.5 (kit de 4 pièces) - DIN EN 455-1  
1 livret d'informations



## TROUSSE DE SECOURS

51246 6,40€

0,20	-	50	800
Kg	sub	ft	ft

Contient:  
1 Prospectus premiers secours  
1 Ciseaux  
1 Pair de gants en latex  
2 Lingettes alcoolisées  
2 Lanières adhésifs

25g. de coton  
1 Sac avec 5 bandages 20x20cm  
1 Voie  
1 Rol de sparadrapp  
Dim. sac: 180x130x55mm



# MASQUE DE PROTECTION ANTI-BUÉE

## FFP2

- Arc en aluminium pour une adaptation facile au nez.
- Conception arquée pour une respiration plus douce.
- Bande élastique en caoutchouc facile à attacher.

**53787** 0,98€

0.01	10	800	6400
Kg	Sub	ff	ff



Pénétration du matériau filtrant	≤ 6%
Fuite totale	≤ 11%
Résistance respiratoire max.	30l/min (inspiration): ≤ 0.70 mbar 95l/min (inspiration): ≤ 2.4 mbar 160l/min (expiration): ≤ 3 mbar

✓ Approuvé selon le règlement UE 2016/425  
Conforme à la norme EN149:2001+A1:2009

## AVEC VALVE

**53844** 2,80€

0.02	3	360	1440
Kg	Sub	ff	ff



Servi en cartons de 3 unités

✓ Approuvé selon le règlement UE 2016/425  
Conforme à la norme EN149:2001

## FFP2

**53946** 0,83€

**53960** 0,98€

**53959** 0,98€

**53961** 0,98€

**537870** 0,98€



✓ Approuvé selon le règlement UE 2016/425  
Conforme à la norme EN149:2001+A1:2009

Pénétration du matériau filtrant	≤ 6%
Fuite totale	≤ 11%
Résistance respiratoire max.	30l/min (inspiration): ≤ 0.70 mbar 95l/min (inspiration): ≤ 2.4 mbar 160l/min (expiration): ≤ 3 mbar

0.01	10	1000	9000
Kg	Sub	ff	ff

## FFP3

**53916** 3,80€

0.03	10	200	1600
Kg	Sub	ff	ff



- Matériau filtrant à trois couches (polypropylène)
- Fixateur pour nez qui assure une adhérence parfaite du demi-masque au visage.
- Soupape d'expiration.
- Boucles élastiques avec bandes en caoutchouc naturel, sans latex.
- Fermetures des boucles en plastique.
- Doublure intérieure pour une meilleure étanchéité et un meilleur confort.

✓ Approuvé selon le règlement UE 2016/425  
Conforme à la norme EN149: 2001

## VALVE D'EXPIRATION INTÉGRÉE

Pénétration de particules de brouillard de sel (chlorure de sodium) ou d'huile dans le matériau filtrant	≤ 1%
Temps d'utilisation maximum	8 h

## JETABLE

### HYGIÉNIQUE

**53797** 0,10€

0.00	50	2000	24000
Kg	Sub	ff	ff

**53957** 0,26€

0.01	50	2000	24000
Kg	Sub	ff	ff

EFB Efficacité à la filtration bactérienne	>98%
Résistance à la respiration	35-50 Pa

✓ UNE 0064-1:2020



Présentation en boîte de 5 socs de 10 unités chacun.

## TAPIS POUR LA DÉSINFECTION DES CHAUSSURES

### TAPIS AVEC RÉSERVOIR POUR LE LIQUIDE DÉSINFECTANT

**53862** 6,00€

1.45	-	5	100
Kg	Sub	ff	ff



- Mesures: 85x55x10cm
- Matériel: TPE
- Capacité maximale recommandée: 3L
- Capacité maximale: 8L

### TAPIS DE SÉCHAGE

**53863** 3,00€

0.70	-	5	240
Kg	Sub	ff	ff

- Mesures: 76x48cm
- Matériel: polyester

### LIQUIDE POUR TAPIS 53862

**53893** 5,00€

4.30	-	4	128
Kg	Sub	ff	ff



## DISTRIBUTEUR AUTOMATIQUE DE COUVRE-CHAUSSURES

**53781** 18,00€

2.20	-	8	32
Kg	Sub	ff	ff



- Permet de couvrir les pieds avec des housses en plastique uniquement en les plaçant à l'intérieur du distributeur.
- Dans la partie inférieure, il y a 8 pièces en PVC pour une meilleure adhérence.



Matériau: plastique ABS

### COUVRE-CHAUSSURES 100PCS

**14781** 9,90€

0.25	-	84	336
Kg	Sub	ff	ff



## DISTRIBUTEUR AUTOMATIQUE 1200ml

**53902** 25,00€

1.15	-	18	144
Kg	Sub	ff	ff

- Débit de liquide : réglable, de 0,5 ml à 2,5 ml.
- Compatible avec du savon liquide, de l'alcool, du gel et un désinfectant pour les mains.
- Dimensions: 100x110x220mm.

DISTANCE D'ACTIVATION DU CAPTEUR: 50-150MM



Comprend un support et des vis à fixer au mur.

### ADAPTATEUR AC/DC 6V 1.5A

**15059** 10,00€

0.10	-	200	-
Kg	Sub	ff	ff

### BATTERIE R14 C1.5V

**15062** 1,00€

0.05	24	480	-
Kg	Sub	ff	ff

## DISTRIBUTEUR AUTOMATIQUE 400ML

**53826** 16,00€

0.35	-	40	400
Kg	Sub	ff	ff

- Compatible avec du savon liquide, de l'alcool, du gel et du désinfectant pour les mains.
- Technologie de capteur infrarouge avec LED.
- Dosage: 1ml.
- Tension: 6 V (4 piles de 1,5 V).
- Piles non incluses.

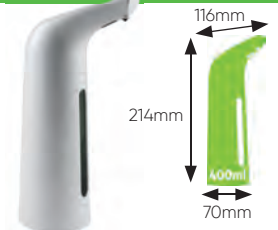

## DISTRIBUTEUR POUR CARAFE

**14793** 12,00€

0.05	-	100	1200
Kg	Sub	ff	ff



## PIED POUR DISTRIBUTEUR DE GEL AUTOMATIQUE

**53827** 14,00€

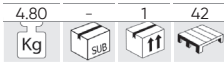

POUR

**53902** 25,00€

- Poids: 4,3 kg
- Matériau: acier
- Couleur: noire
- Mesures du plateau: 417x67 mm
- Dimensions du support du distributeur: 480x133 mm
- Diamètre de la base: 395 mm

## THERMOMÈTRE INFRAROUGE

**53794** 28,00€

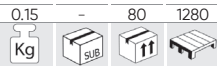

Distance de mesure: **15 - 50mm**



CE 0123  
2 piles A

AVEC ALARME SONORE

AVEC PUCE INTELLIGENTE ET MÉMOIRE JUSQU'À 32 REGISTRES

ÉCRAN POUR UNE VISUALISATION FACILE

- Mesure la température corporelle en **1 seconde** et **sans contact physique**.
- Arrêt automatique après 1 minute.

Température corporelle 32,0°C - 42,2°C (89,6°F - 108°F)  
Précision ±0,2°C (35°C - 42°C)

## MASQUE DE PROTECTION ANTI-BUÉE

**53798** 1,95€

✓ Selon EN166

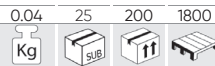

- Protection directe contre les liquides et les bactéries.
- Mousse à l'intérieur pour améliorer le confort
- Traitement anti-buée à l'écran
- Réglable



## CAMÉRA AVEC SYSTÈME DE MESURE DE TEMPÉRATURE

**53830** 1.300,00€

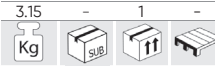

**Puissance:** 12VDC  
**Relay:** +:NO -:COM  
**Internet:** RJ45



Elle fonctionne à travers une connexion IP

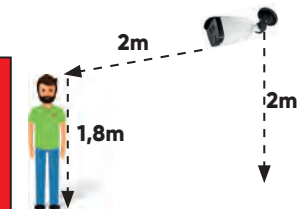

## SAC EN PVC AVEC ZIP

**14918** 0,23€

25 x 30cm

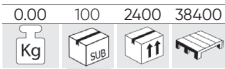

**14919** 0,45€

60 x 18 cm

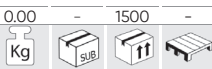

## NETTOYEUR DE SURFACE LIQUIDE

FORMAT LIQUIDE

FORMAT DE PULVÉRISATION

Nettoyé tous types de surfaces: accueil - voiture - bureau - AACC

- Spray idéal pour nettoyer tous types de surfaces.
- Aspect physique: Liquide transparent.
- Contient: isopropanol / éthanol.



Accessoire utile fonctionne avec la plupart des spray commercialisés.

**PISTOLET ADAPTABLE POUR AEROSOL**

**53829** 14,00€

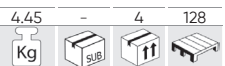

**53828** 6,00€



**53824** 2,85€

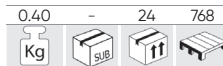

**53804** 0,80€



**52493** 4,50€



## SOIN ET HYGIÈNE DES MAINS: NETTOYEURS ET FORMULES HYDROALCOOLIQUES



- Contient: propan-2-ol, alcool isopropilico / Etanol / propan-1-ol, n-propanol

**Mode d'emploi:**

Appliquer une quantité susante de produit sur une peau saine et sèche et frotter pendant au moins 30 secondes. Il n'a pas besoin d'être rincé.

FORMAT GEL

FORMAT LOTION

FORMAT MOUSSE

valable pour surfaces

- Solution hydroalcoolique à la glycérine et à l'aloë vera pour l'hygiène et le soin des mains.



**53832** 1,81€



**53791** 4,80€



**53822** 2,50€

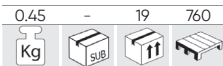

**53803** 0,90€

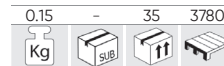



## ÉCRAN DE PROTECTION MÉTACRYLATE

**53835** 16,00€

2.30	-	5	80
Kg	Sub	ff	ff



**53836** 16,00€

4.05	-	5	60
Kg	Sub	ff	ff

Grosseur: 5mm  
Trou: 300x160mm  
Base: 150x200mm

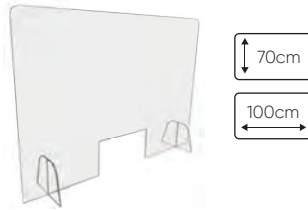

## RUBAN DE SIGNALISATION 200M

**53811** 8,90€

0.45	-	40	560
Kg	Sub	ff	ff

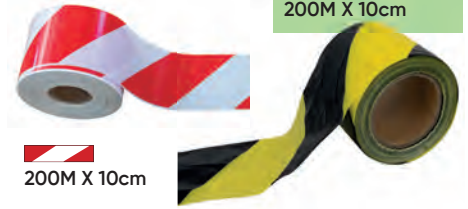

200M X 10cm

**53987** 0.59  
9,50€  
Kg

200M X 10cm

## POTEAU EN PLASTIQUE POUR CHÂÎNES DE HAUTE TENSION

**53940** 13,20€

0.55	-	6	96
Kg	Sub	ff	ff

- Matériau: PVC.

CHAÎNE NON INCLUS

- ✓ Pour une clôture simple, rapide et mobile des espaces intérieurs et extérieurs avec des limitations.
- ✓ Ses couleurs contrastées rendent la chaîne très visible pour limiter les zones de hautes tensions.



SIGNALISATION SPÉCIALE HAUTE TENSION



BASE GONFLABLE



## POTEAU DE PLASTIQUE POUR CHÂÎNES

**53808** 16,50€

0.55	-	6	114
Kg	Sub	ff	ff

- Matériau: PVC.

CHAÎNE NON INCLUS



BASE GONFLABLE



## MAILLE DE CHÂÎNE

**53839** 0,25€

0.00	10	2000	16000
Kg	Sub	ff	ff



## CHAÎNE PVC

**53809** 8,00€

0.30	-	40	960
Kg	Sub	ff	ff

- Longueur: 5m
- Lien: 6 mm
- Couleur: rouge / blanc



## PÔLE DE SÉPARATION AVEC BANDE RÉTRACTABLE

**53914** 75,00€

8.50	-	5	90
Kg	Sub	ff	ff



- Matériel: acier
- Diamètre du tube: 63 mm
- Diamètre de la base: 320 mm
- Hauteur: 910 mm

- Sortie ruban dans 4 directions
- Longueur du ruban: 3 m
- Largeur de ceinture: 48 mm

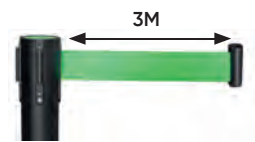

SORTIE DE RUBAN À 4 VOIES

## RUBAN ADHÉSIF DE SIGNALISATION DISTANCE DE SÉCURITÉ

**53840ES** 6,00€

0.05	10	360	-
Kg	Sub	ff	ff

1.000x1.000 mm

DISPONIBLE DANS TOUTE LANGUE

- Texte:  
\* S'IL VOUS PLAÎT! GARDEZ LA DISTANCE DE SÉCURITÉ\*



## SUPPORT D'AVERTISSEMENT - DISTANCE DE SÉCURITÉ

**53812** 23,50€

0.30	-	-	240
Kg	Sub	ff	ff

PP



# GÉNÉRATEUR D'OZONE PORTABLE

Désinfecte l'air des pièces à l'aide d'ozone O<sub>3</sub> pour oxyder pratiquement toutes les particules: virus, bactéries, composants organiques et inorganiques.  
Utilisation dans les zones inoccupées

OLOR ODOR
VIRUS VIRUSES
BACTERIAS BACTERIA
HCHO
+
HYGIENE
ANTI BACTÉRIES
PURIFIÉ

**53786** 98,00€

2.20 - 8 32  
Kg sub ft

158mm 172mm 187mm

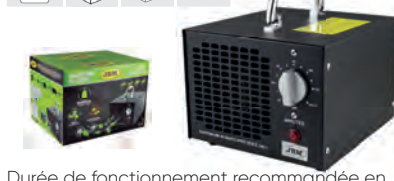

67W 2 Amp 5x20mm 80 CFM  
5000mg/h

PLAQUE POUR REF. 53786  
14775  
30,50€

Durée de fonctionnement recommandée en fonction de la taille de la pièce:

50m<sup>3</sup> 100m<sup>3</sup> 150m<sup>3</sup> 200m<sup>3</sup> 300m<sup>3</sup> 20min 40min 60min 80min 100min

**10.000mg/h**

**53805** 220,00€

2.80 - 4 40  
Kg sub ft

275mm 190mm 235mm

- Léger, rapide et puissant.
- Faible niveau de bruit.
- 3 types de désinfection: ozone, ion, ozone + ion.
- Minuterie et modèle de maintien.
- Taille portable avec poignée.



95W 1000mg/h 220V 240V 20000 h  
ANION NEGATIVE ION 20x10 ions/cm<sup>3</sup> 100 CFM (2,83m<sup>3</sup>/min)

PLAQUE POUR REF. 53805

14802  
44,00€

Volume de la pièce	Temps de travail requis
50m <sup>3</sup>	8 min
100m <sup>3</sup>	16 min
150m <sup>3</sup>	24 min
200m <sup>3</sup>	32 min
300m <sup>3</sup>	48 min

**10.000mg/h - 20.000mg/h**

**53806** 250,00€

3.90 - 4 32  
Kg sub ft

242mm 233mm 300mm

- Léger, rapide et puissant.
- Faible niveau de bruit.
- Dissipateur thermique pour éviter la surchauffe de la plaque d'ozone.
- Taille portable avec poignée.
- Filtre à air et plaque d'ozone facilement remplaçables.



**UV**  
INCORPORENT LA LUMIÈRE UV POUR STÉRILISER

PLAQUE POUR REF. 53806

14803  
43,00€

190W 120 CFM 220V 240V 20000 h 50 dB

**2 MODES DE TRAVAIL**

LOW 10.000mg/h		HIGH 20.000mg/h	
Volume de la pièce	Temps de travail requis	Volume de la pièce	Temps de travail requis
50m <sup>3</sup>	8 min	500m <sup>3</sup>	30 min
100m <sup>3</sup>	16 min	600m <sup>3</sup>	40 min
150m <sup>3</sup>	24 min	700m <sup>3</sup>	50 min
200m <sup>3</sup>	32 min	800m <sup>3</sup>	60 min
300m <sup>3</sup>	48 min	900m <sup>3</sup>	70 min
500m <sup>3</sup>	65 min	1.000m <sup>3</sup>	80 min

## BOÎTE DE TRAITEMENT À L'OZONE

**53838** 38,00€

1.10 - 8 96  
Kg sub ft



TEMPS DE DÉSINFECTION

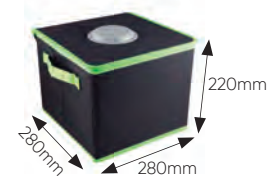
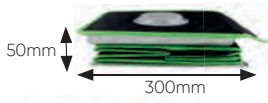

POCHE ARRIÈRE



DÉTACHABLE

La boîte est facilement assemblable et démontable, facilitant ainsi son transport.



- Longueur d'onde ultraviolette: 254 nm
- Prise de courant: connecteur micro-USB



5V 2W Amp 0.38-0.42 UV 1550 (µW/cm<sup>2</sup>) 12V 1.5-2.0 mg/h 3min

- ✓ HYGIÈNE
- ✓ PUISSANT
- ✓ SÛR ET EFFICACE
- ✓ ELIMINE LES MAUVAISES ODEURS
- ✓ RAPIDE
- ✓ TRANSPORTABLE

## OZONOMÈTRE

**53802** 120,00€

0.65 - 20 240  
Kg sub ft

- Précision: ±5% F.S.
- Plage de mesure: 0-50ppm (0-98mg/m<sup>3</sup>)
- Alarme basse: 5ppm (9.8mg/m<sup>3</sup>)
- Alarme haute: 10ppm (19.6mg/m<sup>3</sup>)
- Temps de réponse: <30 segundos
- Températures de fonctionnement: -10°C - 55°C
- Protection IP65



109x60x30mm

DEUX NIVEAUX D'ALARME CONFIGURABLES POUR DIFFÉRENTS NIVEAUX DE CONCENTRATION

TEMPS DE TRAVAIL: >8H

TEMPS DE CHARGE: 4H-6H

CONFORME À: EN61326-1, EN61000-4-2, EN61000-4-3



**JBM**

**110  
PCS**



M6x1  
M8x1.25  
M10x1.5



M6x1  
M8x1.25  
M10x1.5



M6x1  
M8x1.25  
M10x1.5



- (ES) SURTIDO DE ENGRASADORES
- (EN) METRIC GREASE FITTING ASSORTMENT
- (FR) MALETTE DE GRAISSEURS
- (DE) SATZ VON SCHMIERBUCHSEN MIT METRISCHEM GEWINDE
- (IT) SET DI INGRASSATORI CON FILETTATURA METRICA
- (PT) SURTIDO DE LUBRIFICADORES
- (RO) ASORTIMENT DE NIPLURI DE GRESARE
- (NL) SET VAN SMEEDERS MET METRISCHE DRAAD
- (HU) ZSIRZÓKÉSZLET METRIKUS MENETTEL
- (RU) НАБОР МАСЛЕНОК С МЕТРИЧЕСКОЙ РЕЗЬБОЙ
- (PL) ZESTAW OLFIARZEK O GWINCIE METRYCZNEJ

## CONSOMMABLES

- 324 PASSE-CÂBLES / GOUPILLES
- 325 LANGUETTES / VIS ET ÉCROUS
- 327 RIVETS
- 328 RONDELLES
- 331 OBUS
- 332 O-RING  
/ TUBES THERMORÉTRACTABLE
- 333 RACCORDS DE TUYAU  
/ GRAISSEURS
- 334 PINCES / RESSORTS / FUSIBLES
- 335 COSSES
- 336 CLIPS EN PLASTIQUE

## ÉTUI DE E-CLIPS

53348 14,00€

0,30 6 24 672  
Kg SUB 11



150  
PCS



	M1.5	M3	M5	M6	M9	M12	M15	M19	M22
	15 PCS	15 PCS	20 PCS	25 PCS	25 PCS	20 PCS	10 PCS	10 PCS	10 PCS

## ÉTUI DE PASSES-CABLES EN CAOUTCHOUC

53349 14,00€

0,25 6 24 672  
Kg SUB 11



125  
PCS



19,5x23 2 PCS	16x24 3 PCS	13x15 3 PCS	11,5x19 4 PCS	10x20 3 PCS	10x12 5 PCS	25 2 PCS	22 3 PCS	19 4 PCS	15 5 PCS
	9,8x11,5 6 PCS	8x14 3 PCS	7,5x13 7 PCS	6x7,5 10 PCS	3,5x6 15 PCS		12 10 PCS	9 20 PCS	7 20 PCS

## ÉTUI DE PASSE-CABLE CAOUTCHOUC

53370 26,00€

0,30 6 12 -  
Kg SUB 11

190  
PCS



	M2	M3	M4	M5	M6	M8	M10
	25 PCS	25 PCS	30 PCS	30 PCS	30 PCS	20 PCS	20 PCS

## ÉTUI DE BARRETTES ÉLASTIQUES

53350 14,00€

0,40 6 24 -  
Kg SUB 11

120  
PCS



1/16x3/16 4u.	3/32x1-1/4 4u.	3/16x1 5u.	1/4x1-3/4 4u.
1/16x5/16 4u.	1/8x5/8 5u.	3/16x1-1/4 5u.	5/16x3/4 4u.
1/16x3/4 4u.	1/8x1 5u.	7/32x5/8 4u.	5/16x1-1/2 4u.
5/64x1/4 4u.	1/8x1-1/4 5u.	7/32x1-1/4 4u.	5/16x2 4u.
5/64x1/2 4u.	5/32x5/8 4u.	7/32x1-3/4 4u.	3/8x3/4 2u.
5/64x1 4u.	5/32x1 4u.	1/4x5/8 4u.	3/8x1-1/2 2u.
3/32x5/8 4u.	5/32x1-1/2 4u.	1/4x1-1/4 4u.	3/8x2 2u.
3/32x1 4u.	3/16x5/8 5u.		

## MALLETTE GOUPILLES FONDUES 365 PIÈCES

52027 14,00€

0,90 6 12 432  
Kg SUB 11

365  
PCS



	1,2x25mm 50 PCS	1,6x32mm 50 PCS	2x40mm 50 PCS	2,5x40mm 50 PCS	3,2x40mm 50 PCS
	3,2x50mm 50 PCS	4x50mm 40 PCS	5x63mm 10 PCS	6,3x63mm 15 PCS	

## ÉTUI DE CLAVETTES

53372 26,00€

1,30 6 12 -  
Kg SUB 11

144  
PCS



	3x50mm 50 PCS	4x60mm 30 PCS	5x75mm 20 PCS	6x50mm 20 PCS	6x75mm 16 PCS	8x60mm 8 PCS
--	------------------	------------------	------------------	------------------	------------------	-----------------

## ÉTUI DE GOUPILLES CLIPS

53371 29,00€

1,45 6 12 288  
Kg SUB ITT

50  
PCS



	5x36	6x45	8x45	11x45
	16 PCS	18 PCS	6 PCS	10 PCS

## ÉTUI DE GOUPILLES CLEVIS ET DE CLIPS EN R

53363 34,00€

1,15 6 24 -  
Kg SUB ITT

71  
PCS



	8x50	9,5x50	11x63	12,5x50
	5 PCS	18 PCS	5 PCS	3 PCS

	3,5x44	2,5x42	2,5x58	2x3
	6 PCS	20 PCS	7 PCS	7 PCS

## MALLETTE ASSORTIMENT GOUPILLES BETA

52044 19,00€

0,55 6 12 384  
Kg SUB ITT

150  
PCS



## ÉTUI DE CLAVETTES

53364 16,00€

0,80 6 24 -  
Kg SUB ITT

60  
PCS



PIÈCES DE RECHANGE DISPONIBLES



REF.	MESURE	UNI.	€/u.
10882	2,00x32mm	42	0,25€
10883	1,60x36mm	30	0,25€
10884	1,60x42mm	25	0,25€
10793	2,30x43mm	25	0,25€
10794	3,20x52mm	20	0,40€
10795	3,80x75mm	8	0,60€

	3x3x25	3x3x20	5x5x30	5x5x25	5x5x20	6x6x40	6x6x30	
	4 PCS	4 PCS	5 PCS	5 PCS	5 PCS	5 PCS	5 PCS	
			6x6x20	8x8x40	8x8x30	10x10x40	10x10x30	12x12x40
			5 PCS	5 PCS	5 PCS	5 PCS	5 PCS	2 PCS

## ÉTUI DE VIS CROCHET

53352 12,00€

0,60 6 24 672  
Kg SUB ITT

151  
PCS

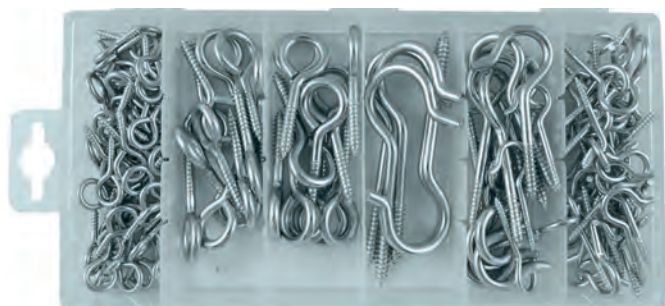

	2,4x25	4x45	4x50
	60 PCS	12 PCS	12 PCS

	2,4x41	4x64	4,2x85
	50 PCS	12 PCS	5 PCS

## ÉTUI DE VIS ET ÉCROUS

53351 12,50€

0,90 6 12 -  
Kg SUB ITT

240  
PCS



	4x12	4x20	5x16	5x25	
	10 PCS	10 PCS	10 PCS	10 PCS	
	6x20	6x30	8x25	8x40	
	10 PCS	10 PCS	5 PCS	5 PCS	
	10x16	10x40			
	5 PCS	5 PCS			
	4	5	6	8	10
	20 PCS	20 PCS	20 PCS	10 PCS	10 PCS
	4	5	6	8	10
	20 PCS	20 PCS	20 PCS	10 PCS	10 PCS

## ÉTUI DE VIS FILETÉS

53354 14,00€

0,55	6	24	-
Kg	Sub	ff	

200 PCS



#8x12.5	#8x16	#8x19	#8x25	#10x12.5	#10x16	#10x19	#10x25
30 PCS	30 PCS	30 PCS	30 PCS	20 PCS	20 PCS	20 PCS	20 PCS

## ÉTUI DE VIS ALLEN

53362 14,00€

0,65	6	24	672
Kg	Sub	ff	

106 PCS



4x12	5x12	5x25	10x40	6x25	8x40	10x25	6x12	8x25
25 PCS	25 PCS	20 PCS	3 PCS	10 PCS	5 PCS	3 PCS	10 PCS	5 PCS

## ÉTUI DE VIS ET ÉCROUS TYPE U

53366 14,00€

0,30	6	24	672
Kg	Sub	ff	

170 PCS



M3 5X8	M4 2X16	M4.2	M3.5	M3.5	M6.35
40 PCS	20 PCS	20 PCS	20 PCS	20 PCS	10 PCS
M6.35X19	M5X12	M5	M5	M5	M5
15 PCS	10 PCS	15 PCS	15 PCS	15 PCS	15 PCS

## ÉTUI DE CLAVETTES

53369 14,00€

0,65	6	24	672
Kg	Sub	ff	

550 PCS



2.8x13mm	3.5x13mm	3.5x19mm	4.2x16mm	4.2x31mm	4.8x25mm	2.8x16mm
65 PCS	65 PCS	45 PCS	40 PCS	20 PCS	20 PCS	55 PCS
3.5x10mm	3.5x16mm	4.2x13mm	4.2x25mm	4.8x19mm	4.8x32mm	
60 PCS	60 PCS	50 PCS	30 PCS	25 PCS	15 PCS	

## MALLETTE D'ÉCROUS FREIN

52029 14,00€

1,01	6	12	360
Kg	Sub	ff	

228 PCS



M3	M4	M5	M6	M8
50 PCS	50 PCS	40 PCS	30 PCS	20 PCS
M10	M12	M14	M16	
15 PCS	10 PCS	8 PCS	5 PCS	

## MALLETTE D'ÉCROUS

52028 15,20€

1,05	6	12	360
Kg	Sub	ff	

243 PCS



### PIÈCES DE RECHANGE DISPONIBLES

REF.	MESURE	UNI.	€/u.
10805	M3	50	0,10€
10779	M4	50	0,05€
10780	M5	50	0,05€
10781	M6	50	0,05€
10784	M8	50	0,05€
10785	M10	20	0,10€
10786	M12	40	0,15€

REF.	MESURE	UNI.	€/u.
10812	M14	8	0,30€
10813	M16	5	0,30€



## ÉTUI D'ÉCROUS PAPILLON

53365 14,00€

0,75	6	24	-
Kg	Sub	ff	ff



150 PCS



	M4	M5	M6	M8	M10
	40 PCS	40 PCS	25 PCS	25 PCS	20 PCS

## ÉTUI DE RIVETS INSERTS ALUMINIUM

53361 24,00€

0,20	6	24	672
Kg	Sub	ff	ff



150 PCS



3x9	4x11	5x13	6x15	8x18	10x21
40 PCS	35 PCS	25 PCS	25 PCS	15 PCS	10 PCS

## MALLETTE INSERTS TETE PLATE

52703 22,00€

0,79	6	24	480
Kg	Sub	ff	ff

235 PCS



M3	M4	M5	M6	M8	M10	M12
50 PCS	50 PCS	50 PCS	40 PCS	20 PCS	15 PCS	10 PCS

## ÉTUI DE RIVETS INSERTS

53360 18,00€

0,45	6	24	672
Kg	Sub	ff	ff



150 PCS



3x9	4x11	5x13	6x15	8x18	10x21
40 PCS	35 PCS	25 PCS	25 PCS	15 PCS	10 PCS

**X** PIÈCES DE RECHANGE DISPONIBLES

REF.	MESURE	UNI.	€/u.
13235	M3	200	0,15€
13236	M4	200	0,15€
13237	M5	200	0,15€
13238	M6	100	0,20€
13239	M8	50	0,20€
13240	M10	40	0,40€
13241	M12	20	0,55€



## MALLETTE DE RIVETS

52043 16,50€

0,80	6	12	384
Kg	Sub	ff	ff

300 PCS



4.8x16.9mm	4.8x24.8mm	
50 PCS	40 PCS	
3.2x9.7mm	4.8x12.7mm	4.8x20mm
90 PCS	70 PCS	50 PCS

## MALLETTE INSERTS PLASTIQUE

52711 27,50€

0,44	6	24	384
Kg	Sub	ff	ff



150 PCS

RIVETUSEUR DISPONIBLE SUR LA PAGE 48 ET 127 (REF. 52575)



**X** PIÈCES DE RECHANGE DISPONIBLES



REF.	MESURE	UNI.	€/u.
13674	6x19,3mm	25	0,50€
13675	6x17,8mm	25	0,50€
13676	6x25,5mm	25	0,50€
13677	6x24,5mm	25	0,50€
13678	6x24mm	25	0,50€



6x19.3mm	6x17.9mm	6x25.5mm
25 PCS	25 PCS	25 PCS
6x24.5mm	6x24mm	6x24mm
25 PCS	25 PCS	25 PCS



**X** PIÈCES DE RECHANGE DISPONIBLES

REF.	MESURE	Kg	Sub	ff	ff	€/u.
10877	4,8x16,90mm	0,04	5	500	2.000	0,25€
10878	4,8x24,80mm	0,01	10	500	1.800	0,30€
10879	3,2x9,70mm	0,02	10	500	4.000	0,20€
10880	4,8x12,70mm	0,03	10	500	2.000	0,20€
10881	4,8x20,00mm	0,04	10	500	1.480	0,25€



# MALLETTE MIXTE VISSERIE BOULONNERIE ET RONDELLES

**51804** 58,00€

5,68	-	5	120
Kg	Sub	ff	

**828**  
PCS

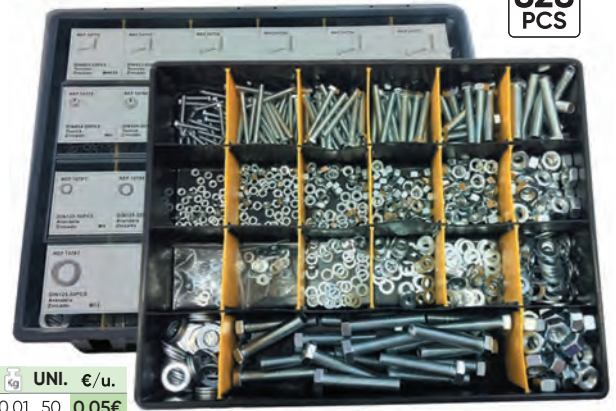

## PIÈCES DE RECHANGE DISPONIBLES

REF.	MESURE	Kg	UNI.	€/u.
10772	Vis zinguée DIN 933 8.8 M4x25	0,01	25	0,05€
10773	Vis zinguée DIN 933 8.8 M5x25	0,01	25	0,10€
10774	Vis zinguée DIN 933 8.8 M6x25	0,01	25	0,10€
10775	Vis zinguée DIN 933 8.8 M7x50	0,01	15	0,15€
10776	Vis zinguée DIN 933 8.8 M8x50	0,01	15	0,20€
10777	Vis zinguée DIN 933 8.8 M10x50	0,04	12	0,20€
10778	Vis zinguée DIN 933 8.8 M12x60	0,05	20	0,35€
10779	Écrou zingué DIN 934 M4	0,02	50	0,05€
10780	Écrou zingué DIN 934 M5	0,01	50	0,05€
10781	Écrou zingué DIN 934 M6	0,01	50	0,05€
10782	Écrou zingué DIN 934 M7	0,01	50	0,05€
10784	Écrou zingué DIN 934 M8	0,01	50	0,05€
10785	Écrou zingué DIN 934 M10	0,01	50	0,10€
10786	Écrou zingué DIN 934 M12	0,01	40	0,15€
10787	Rondelle zinguée DIN 125 M4	0,01	50	0,05€



REF.	MESURE	Kg	UNI.	€/u.
10788	Rondelle zinguée DIN 125 M5	0,01	50	0,05€
10789	Rondelle zinguée DIN 125 M6	0,01	50	0,05€
10790	Rondelle zinguée DIN 125 M7	0,01	50	0,05€
10791	Rondelle zinguée DIN 125 M8	0,01	50	0,05€
10792	Rondelle zinguée DIN 125 M10	0,01	50	0,05€
10783	Rondelle zinguée DIN 125 M12	0,01	50	0,05€
50959	Caisse 19 compartiments	0,7	1	12,00€

# MALETTE RONDELLES TRES LARGE GALVANISEES

**52158** 38,50€

3,45	-	5	90
Kg	Sub	ff	

5x20x1,5mm 50 PCS	6x20x1,5mm 50 PCS	7x20x1,5mm 50 PCS
8x20x1,5mm 50 PCS	8x20x1,75mm 50 PCS	10x30x2,5mm 25 PCS
6x30x2mm 25 PCS	7x30x2mm 25 PCS	8x30x2mm 25 PCS
4x11x0,98mm 50 PCS	12x40x3mm 25 PCS	4x20x1,5mm 50 PCS



**475**  
PCS

# ÉTUI DE RONDELLES ACIER

**53377** 20,00€

1,60	6	12	-
Kg	Sub	ff	



20x6x1.5 20 PCS	20x8x1.5 20 PCS	20x10x1.5 20 PCS	25x6x1.5 20 PCS
32x2x1.5 20 PCS	32x4x1.5 20 PCS	32x6x1.5 20 PCS	32x8x1.5 20 PCS
25x10x1.5 20 PCS	32x10x1.5 20 PCS	32x10x1.5 20 PCS	25x8x1.5 20 PCS



**240**  
PCS

# MALLETTE RONDELLES EN ALUMINIUM

**52031** 44,00€

0,56	6	18	288
Kg	Sub	ff	

3x7x1,5mm 50 PCS	4x8x1,5mm 50 PCS	5x6x1,5mm 50 PCS	16x22x1,5mm 50 PCS	14x22x1,5mm 50 PCS	14x20x1,5mm 50 PCS
6x10x1,5mm 50 PCS	6x11x1,5mm 50 PCS	7x11x1,5mm 50 PCS	7x12x1,5mm 50 PCS	8x12x1,5mm 50 PCS	8x14x1,5mm 50 PCS
9x12x1,5mm 50 PCS	10x14x1,5mm 50 PCS	11x16x1,5mm 50 PCS	11x17x1,5mm 50 PCS	12x16x1,5mm 50 PCS	12x16x1,5mm 50 PCS



**900**  
PCS



# MALLETTE RONDELLES GROWER

52032 28,00€

1,68 - 5 870



1.735  
PCS

3mm 600 PCS	4mm 400 PCS	5mm 220 PCS	6mm 220 PCS	8mm 110 PCS
10mm 65 PCS	12mm 50 PCS	14mm 40 PCS	16mm 30 PCS	

# ÉTUI DE RONDELLES EN CUIVRE POUR INJECTEURS

53229 38,70€

0,40 5 20 720



150  
PCS



13.8x7.3x1.4mm 10 PCS	15.0x7.0x2.0mm 10 PCS	15.0x7.5x2.5mm 10 PCS	16.0x7.5x1.7mm 10 PCS	16.0x7.5x2.0mm 10 PCS	16.4x7.5x2.0mm 10 PCS
14.6x7.5x1.3mm 10 PCS	15.0x7.5x1.0mm 10 PCS	15.0x7.5x2.0mm 10 PCS	15.0x7.5x3.0mm 10 PCS	16.0x7.5x1.5mm 10 PCS	20.0x9.4x0.9mm 10 PCS
14.6x7.5x3.0mm 10 PCS	15.0x7.5x1.5mm 10 PCS	15.5x7.5x2.0mm 10 PCS			

53340 86,00€

0,90 - 10 1050



375  
PCS



13.8x7.3x1.4mm 25 PCS	15.0x7.0x2.0mm 25 PCS	15.0x7.5x2.0mm 25 PCS	15.5x7.5x2.0mm 25 PCS	16.0x7.5x2.0mm 25 PCS
14.6x7.5x1.3mm 25 PCS	15.0x7.5x1.0mm 25 PCS	15.0x7.5x2.5mm 25 PCS	16.0x7.5x1.5mm 25 PCS	16.4x7.5x2.0mm 25 PCS
14.6x7.5x3.0mm 25 PCS	15.0x7.5x1.5mm 25 PCS	15.0x7.5x3.0mm 25 PCS	16.0x7.5x1.7mm 25 PCS	20.0x9.4x0.9mm 25 PCS

**PIÈCES DE RECHANGE DISPONIBLES**

<b>13819</b> 50 6,50€	<b>13822</b> 50 11,00€	<b>13825</b> 50 11,50€	<b>13828</b> 50 11,50€	<b>13831</b> 50 12,60€
13.8 x 7.3 x 1.4 mm	15.0 x 7.0 x 2.0 mm	15.0 x 7.5 x 2.0 mm	15.5 x 7.5 x 2.0 mm	16.0 x 7.5 x 2.0 mm
<b>13820</b> 50 7,00€	<b>13823</b> 50 6,00€	<b>13826</b> 50 13,00€	<b>13829</b> 50 10,50€	<b>13832</b> 50 13,00€
14.6 x 7.5 x 1.3 mm	15.0 x 7.5 x 1.0 mm	15.0 x 7.5 x 2.5 mm	16.0 x 7.5 x 1.5 mm	16.4 x 7.5 x 2.0 mm
<b>13821</b> 50 14,00€	<b>13824</b> 50 8,00€	<b>13827</b> 50 15,00€	<b>13830</b> 50 10,50€	<b>13833</b> 50 9,00€
14.6 x 7.5 x 3.0 mm	15.0 x 7.5 x 1.5 mm	15.0 x 7.5 x 3.0 mm	16.0 x 7.5 x 1.7 mm	20.0 x 9.4 x 0.9 mm

# MALLETTE RONDELLES PLATES

52030 98,00€

1,21 3 18 288



**PIÈCES DE RECHANGE DISPONIBLES**

900  
PCS

REF.	MESURE	Kg	€ / u.
10823	3x7x1,5mm	0,01 50	0,20€
10824	4x8x1,5mm	0,01 50	0,20€
10825	5x6x1,5mm	0,01 50	0,20€
10826	16x22x1,5mm	0,01 50	0,40€
10827	14x22x1,5mm	0,01 50	0,60€
10828	14x20x1,5mm	0,01 50	0,45€
10829	6x10x1,5mm	0,01 50	0,20€
10830	6x11x1,5mm	0,01 50	0,20€
10831	7x11x1,5mm	0,01 50	0,20€
10832	7x12x1,5mm	0,01 50	0,20€
10833	8x12x1,5mm	0,01 50	0,20€
10834	8x14x1,5mm	0,01 50	0,25€
10835	9x12x1,5mm	0,01 50	0,25€

REF.	MESURE	Kg	€ / u.
10836	10x14x1,5mm	0,01 50	0,30€
10837	11x16x1,5mm	0,01 50	0,30€
10838	11x17x1,5mm	0,01 50	0,30€
10839	12x16x1,5mm	0,01 50	0,40€
10840	12x18x1,5mm	0,01 50	0,35€



# ÉTUI DE RONDELLES EN CUIVRE POUR INJECTEURS 551 PCS

53464 153,00€

1.85 - 5 90  
Kg SUB



## 30 PIÈCES DE RECHANGE DISPONIBLES

- |  |  |  |
|--|--|--|
| <br>UNIVERSAL<br>Ø15.0X8.0X1.5<br>13945 7,40€                | <br>MERCEDES<br>Ø15.0X7.0X1.5<br>13946 6,70€       | <br>RENAULT<br>Ø13.0X7.5X2.5<br>13947 5,85€    |
| <br>IVECO, FORD,<br>BMW, MAN<br>Ø15.0X7.5X1.5<br>13948 5,00€ | <br>UNIVERSAL<br>Ø15.0X7.5X2.0MM<br>13949 6,50€    | <br>UNIVERSAL<br>Ø15.45X8.0X2.0<br>13950 7,80€ |
| <br>MAZDA<br>Ø13.5X10X2.0<br>13951 5,15€                     | <br>FORD<br>Ø15.5X7.5X2.5<br>13952 10,90€          | <br>LAND ROVER<br>Ø15.5X7.5X1.5<br>13953 8,00€ |
| <br>RENAULT<br>Ø15.0X7.5X3.0<br>13954 12,70€                 | <br>DEUTZ<br>Ø13.0X7.0X1.5<br>13955 4,95€          | <br>FORD<br>Ø13.5X7.5X1.5<br>13956 4,30€       |
| <br>FIAT<br>Ø15.0X7.5X1.5<br>13957 9,70€                     | <br>MAN ROVER<br>Ø15.5X7.5X1<br>13958 5,45€        | <br>MERCEDES<br>Ø16.5X7.5X2<br>13959 10,10€    |
| <br>KIA<br>Ø13.7X7.3X3<br>13960 9,65€                        | <br>KIA<br>Ø13.7X7.3X2<br>13961 9,25€              | <br>ACIER<br>Ø10X6.0X1.0<br>13962 1,76€        |
| <br>LAITON<br>Ø15.8X7.5X3.0<br>13963 12,40€                  | <br>CONNECTEURS DE<br>TUYAU EN "T"<br>13964 15,00€ | <br>ALUMINIUM<br>Ø8X5.8X1<br>13965 1,50€       |
| <br>CONNECTEURS DE<br>TUYAU EN "L"<br>13966 12,90€           | <br>SPRINGS<br>RETENUE<br>13967 4,65€              |  |

Ø15.0X8.0X1.5 30 PCS	Ø15.0X7.0X1.5 12 PCS	Ø13.0X7.5X2.5 30 PCS	Ø15.0X7.5X1.5 30 PCS	Ø15.45X8.0X2.0 30 PCS
Ø15.45X8.0X2.0 30 PCS	Ø13.5X10X2.0 12 PCS	Ø15.5X7.5X2.5 30 PCS	Ø15.5X7.5X1.5 12 PCS	Ø15.0X7.5X3.0 30 PCS
Ø13.0X7.0X1.5 12 PCS	Ø13.5X7.5X1.5 30 PCS	Ø15.0X7.5X1.5 12 PCS	Ø15.5X7.5X1 12 PCS	Ø16.5X7.5X2 30 PCS
Ø13.7X7.3X3 12 PCS	Ø13.7X7.3X2 12 PCS	Ø10X6.0X1.0 50 PCS	Ø15.8X7.5X3.0 30 PCS	Ø8X5.8X1 30 PCS
"T" 20 PCS	"L" 30 PCS	springs retenue 25 PCS		



## JOINTS CAOUTCHOUC À LÈVRE

- |  |  |   |
|--|--|---|
| <br>Ø 10MM / 0,02KG<br>52719 0,19€<br>0.04 100 5000 150000<br>Kg SUB | <br>GOMME (Ford)<br>Ø 13MM / 0,01KG<br>51554 0,28€<br>0.01 100 5000 180000<br>Kg SUB | <br>Ø 16MM / 0,01KG<br>51799 0,20€<br>0.01 50 2500 120000<br>Kg SUB |
| <br>Ø 12MM / 0,03KG<br>51843 0,19€<br>0.01 100 5000 200000<br>Kg SUB | <br>Ø 14MM / 0,01KG<br>51546 0,19€<br>0.01 100 5000 150000<br>Kg SUB                 |   |

## MALLETE JOINT DE VIDANGE

52163 95,00€

0.65 6 18 288  
Kg SUB



PIÈCES DE RECHANGE DISPONIBLES

Ø10MM 100 PCS	Ø12MM 100 PCS	Ø14MM 100 PCS
Ø16MM 100 PCS	Ø18MM 100 PCS	Ø20MM 25 PCS



COMPRESSIBLE



## ÉTUI DE RONDELLES EN CUIVRE

53353 18,00€

0,20 6 24 720  
Kg SUB ff

110 PCS



	M6	M8	M10	M12	M14	M16
	30 PCS	25 PCS	20 PCS	15 PCS	10 PCS	10 PCS

## ÉTUI DE GOUPILLES

53373 14,50€

0,25 6 24 672  
Kg SUB ff

260 PCS



	M3x10	M4x12	M5x14	M6x14	M8x18	M10x20	M12x25
	30 PCS	30 PCS	40 PCS	50 PCS	50 PCS	40 PCS	20 PCS

## ÉTUI DE GOUPILLES SEGER EXTÉRIEUR

53383 11,50€

0,20 6 24 672  
Kg SUB ff

300 PCS



	M4	M6	M8	M10	M12
	50 PCS	40 PCS	45 PCS	30 PCS	30 PCS
	M14	M16	M18	M20	M22
	25 PCS	25 PCS	25 PCS	15 PCS	15 PCS

## ÉTUI DE GOUPILLES SEGER INTÉRIEUR

53382 11,00€

0,15 6 24 672  
Kg SUB ff

300 PCS

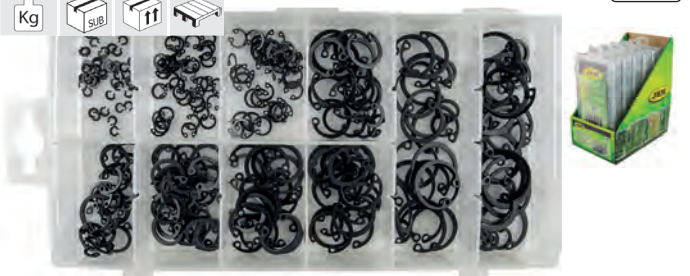

	M4	M6	M8	M10	M12
	50 PCS	40 PCS	45 PCS	30 PCS	30 PCS
	M14	M16	M18	M20	M22
	25 PCS	25 PCS	25 PCS	15 PCS	15 PCS

## ÉTUI RONDELLES DE FIBRE

53381 14,50€

0,19 6 12 384  
Kg SUB ff

600 PCS



	10x5.5x1	16x10x1	19x12x1	22x16x1	22.5x14x1	32x22x1
	160 PCS	80 PCS	40 PCS	30 PCS	20 PCS	20 PCS
	12x6.5x1	16x8x1	20x12.5x1	27x20x1	25.4x17.5x1	32x24x1
	100 PCS	60 PCS	40 PCS	20 PCS	15 PCS	15 PCS

## ENSEMBLE DE NOYAUX DE SOUPE DE CLIMATISEUR

53599 30,30€

0,16 10 100 -  
Kg SUB ff



134 PCS

	R12	5mm L: 19mm		R134A	7mm L: 20mm
	R12	6mm L: 19mm		R12	8mm L: 22mm
	R12	5mm L: 19mm		R12	6mm L: 22mm
	R12	5mm L: 19mm		R12	6mm L: 26.5mm
	R12	6mm L: 19mm		R12	9mm L: 22mm

### PIÈCES DE RECHANGE DISPONIBLES

REF.	MESURE	Kg	u.	€/u.
14594	5x19mm R12 (VERT)	0,01	10	2,00€
14595	5x19mm	0,01	10	1,50€
14596	5x19mm R12	0,01	10	2,00€
14597	6x19mm	0,01	10	7,60€
14598	6x26mm	0,01	10	17,80€
14599	7x20mm R134A	0,01	10	4,50€
14600	6x22mm	0,01	10	9,50€
14601	8x22mm	0,01	10	11,00€
14602	9x22mm	0,01	10	11,00€



# COFFRETS DE JOINTS TORIQUE

METRIQUE - 386 UNITÉS

COUVERCLE DE L'ÉTU	Position dans l'étui	006	007	008	009	010	011
	Largeur caoutchouc (mm)	2	2	2	2	2	2
	Ø Intérieur (mm)	3	4	5	6	7	8
	Quantité	16	16	16	16	16	16

COUVERCLE DE L'ÉTU	Position dans l'étui	113	112	111	110	012
	Largeur caoutchouc (mm)	2.5	2.5	2.5	2.5	2
	Ø Intérieur (mm)	14	12	11	10	10
	Quantité	13	13	13	13	17

COUVERCLE DE L'ÉTU	Position dans l'étui	114	115	116	210
	Largeur caoutchouc (mm)	2.5	2.5	2.5	3
	Ø Intérieur (mm)	16	17	19	19
	Quantité	13	13	13	10

BASE DE L'ÉTU	Position dans l'étui	222	325	326	327
	Largeur caoutchouc (mm)	3	4	4	4
	Ø Intérieur (mm)	38	38	41	44
	Quantité	12	10	9	9

BASE DE L'ÉTU	Position dans l'étui	221	220	219	218	217
	Largeur caoutchouc (mm)	3	3	3	3	3
	Ø Intérieur (mm)	36	35	33	32	30
	Quantité	12	12	12	12	12

BASE DE L'ÉTU	Position dans l'étui	211	212	213	214	215	216
	Largeur caoutchouc (mm)	3	3	3	3	3	3
	Ø Intérieur (mm)	20	22	24	25	27	28
	Quantité	12	12	12	12	12	12

**50651** 16,50€

0.55	5	20	360
Kg	Sub	ff	ff

QUALITÉ HNBR



**386**  
PCS

POUCE - 386 UNITÉS

COUVERCLE DE L'ÉTU	Position dans l'étui	006	007	008	009	010	011
	Largeur caoutchouc	1/16	1/16	1/16	1/16	1/16	1/16
	Ø Intérieur	1/8	5/32	3/16	7/32	1/4	5/16
	Quantité	20	20	20	20	20	20

COUVERCLE DE L'ÉTU	Position dans l'étui	113	112	111	110	012
	Largeur caoutchouc	3/32	3/32	3/32	3/32	1/16
	Ø Intérieur	9/16	1/2	7/16	3/8	3/8
	Quantité	13	13	13	13	13

COUVERCLE DE L'ÉTU	Position dans l'étui	114	115	116	210
	Largeur caoutchouc	3/32	3/32	3/32	1/8
	Ø Intérieur	5/8	11/16	3/4	3/4
	Quantité	13	13	13	10

BASE DE L'ÉTU	Position dans l'étui	222	325	326	327
	Largeur caoutchouc	1/8	3/16	3/16	3/16
	Ø Intérieur	11/2	11/2	15/8	13/4
	Quantité	10	7	7	7

BASE DE L'ÉTU	Position dans l'étui	221	220	219	218	217
	Largeur caoutchouc	1/8	1/8	1/8	1/8	1/8
	Ø Intérieur	17/16	13/8	15/16	11/4	13/16
	Quantité	10	10	10	10	10

BASE DE L'ÉTU	Position dans l'étui	211	212	213	214	215	216
	Largeur caoutchouc	1/8	1/8	1/8	1/8	1/8	1/8
	Ø Intérieur	13/16	7/8	15/16	1	11/16	11/8
	Quantité	10	10	10	10	10	10

**50652** 16,50€

0.66	5	20	360
Kg	Sub	ff	ff

QUALITÉ HNBR



# MALLETTE JOINT POUR CLIM

**50807** 38,00€

0.16	6	24	672
Kg	Sub	ff	ff



5.29X1.78MM	6.07x1.78mm	6.8x1.9mm		
20 PCS	20 PCS	20 PCS		
7.65x1.78mm	7.80x1.90mm	8.0X2.0MM	8.80X1.90MM	10.82X1.78MM
20 PCS	20 PCS	20 PCS	20 PCS	15 PCS
10.77X2.62MM	11.0X2.0MM	12.0X2.0MM	13.9x1.80mm	13.95x2.62mm
15 PCS	15 PCS	15 PCS	10 PCS	10 PCS
14.0X2.0MM	15.0X2.0MM	17.0X2.00MM	17.17x1.78mm	17.04x3.53mm
10 PCS	10 PCS	10 PCS	10 PCS	10 PCS



**270**  
PCS

# ÉTU DE TUBES THERMORÉTRACTS

**53374** 10,00€

0.15	6	24	672
Kg	Sub	ff	ff



**53376** 10,50€

0.15	6	24	672
Kg	Sub	ff	ff

**53374**

**53376**

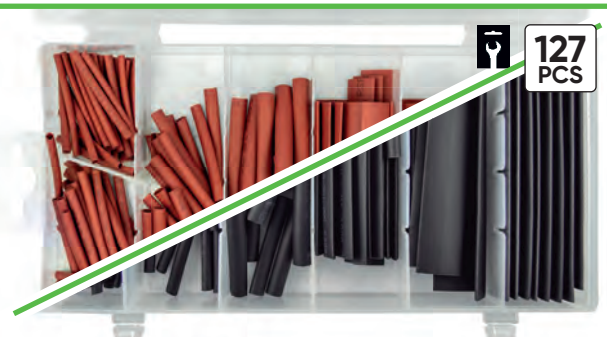

**127**  
PCS

CHALUMEAU

**51920** 18,00€

0.14	10	100	400
Kg	Sub	ff	ff

M2x40	M2.5x40	M3.5x40	M5x40	M7x80	M10x80	M13x85
30 PCS	25 PCS	20 PCS	20 PCS	16 PCS	8 PCS	8 PCS

PAGE 206

**332**

# JEU DE MANCHONS DE SOUDURE THERMORÉTRACTABLES 100PCS

53992 18,00€





0,10 6 84 1512



- Permet de connecter facilement et rapidement les câbles, de les souder et de les sceller en plaçant les câbles dans le manchon de soudure pour l'application ultérieure de la chaleur.
- Matériau: polyéthylène.
- Matériau de l'anneau de soudure: étain.

**100 PCS**









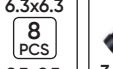

 Ø1.7mm 0.25-0.34mm <sup>2</sup> 26-24 AWG <b>25 PCS</b>	 Ø2.7mm 0.5-1.0mm <sup>2</sup> 22-18 AWG <b>35 PCS</b>	 Ø4.7mm 1.5-2.5mm <sup>2</sup> 16-14 AWG <b>30 PCS</b>	 Ø6.0mm 4.0-6.0mm <sup>2</sup> 12-10 AWG <b>10 PCS</b>
---	--	---	---

## ÉTUI DE CONECTEURS TUYAUX

53910 19,00€

0,25 6 24 480

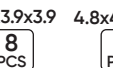

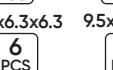
DROIT		RÉDUCTEUR	
 4.8x4.8 <b>10 PCS</b>	 6.3x6.3 <b>8 PCS</b>	 3.17x3.17 <b>30 PCS</b>	 9.5x6.3 <b>6 PCS</b>
 7.9x7.9 <b>6 PCS</b>	 9.5x9.5 <b>6 PCS</b>	 6.3x4.8 <b>10 PCS</b>	
RACCORD EN T			
 3.9x3.9x3.9 <b>8 PCS</b>	 4.8x4.8x4.8 <b>8 PCS</b>	 3.17x3.17x3.17 <b>12 PCS</b>	
 6.3x6.3x6.3 <b>6 PCS</b>	 9.5x9.5x9.5 <b>3 PCS</b>		









**113 PCS**



53434 18,00€

0,15 6 24 672



 4x28.7 <b>10 PCS</b>	 3.9x30.8 <b>5 PCS</b>	 10.4x44.4 <b>10 PCS</b>	 5.6x47.1 <b>5 PCS</b>
 7.9x38 <b>10 PCS</b>	 4.7x38.9 <b>5 PCS</b>	 5.2x33.9 <b>10 PCS</b>	 7x30 <b>10 PCS</b>



**65 PCS**

## MALLETTE GRAISSEUR

52033 43,00€

0,89 6 24 576

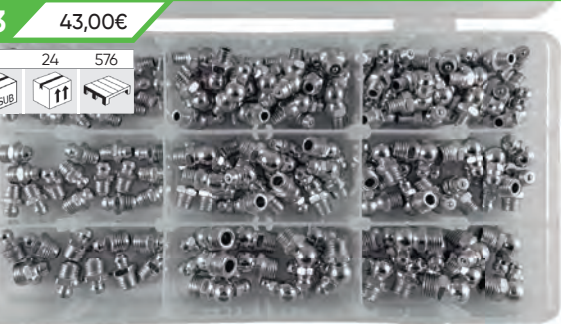

### PIÈCES DE RECHANGE DISPONIBLES

**135 PCS**









ANGLE DROIT		ANGLE 90°		ANGLE 45°					
REF.	MESURE	Kg	€/u.	REF.	MESURE	Kg	€/u.		
10868	6x1	0,01	20	0,30€	10871	6x1	0,01	20	0,30€
10869	8x1	0,01	20	0,30€	10872	8x1	0,01	15	0,40€
10870	10x1	0,01	10	0,45€	10873	10x1	0,01	10	0,45€

## MALETTE GRAISSEURS

53359 16,00€

0,49 6 24 672



 6x1 <b>5 PCS</b>	 8x1.25 <b>5 PCS</b>	 10x1.5 <b>5 PCS</b>
 6x1 <b>60 PCS</b>	 8x1.25 <b>10 PCS</b>	 6x1 <b>5 PCS</b>
 8x1.25 <b>5 PCS</b>	 10x1.5 <b>10 PCS</b>	 10x1.5 <b>5 PCS</b>
<b>ANGLE 90°</b>	<b>ANGLE DROIT</b>	<b>ANGLE 45°</b>

**110 PCS**



## ÉTUI SERRE-TUBES

53378 13,00€

0,45 6 24 672



	1" 4 PCS	1-1/4" 2 PCS	1-3/4" 2 PCS	2" 4 PCS
	2-1/2" 2 PCS	3" 2 PCS	3-1/2" 2 PCS	4" 2 PCS



20 PCS



## ÉTUI DE RESSORTS

53358 11,50€

0,35 6 24 672



	9/32x1/2 10 PCS	1/4x13/32 10 PCS	7/32x11/16 10 PCS	7/32x1-1/2 10 PCS
	5/16x1-3/4 12 PCS	3/8x5/8 8 PCS	3/8x3/4 12 PCS	23/64x1-3/8 8 PCS
	9/32x3/4 10 PCS	13/64x13/16 10 PCS	7/32x1 10 PCS	1/4x7/8 10 PCS
	5/16x1-1/8 8 PCS	5/16x1-1/4 10 PCS	3/16x1-3/4 8 PCS	9/32x1-1/2 10 PCS
	11/32x1-7/16 10 PCS	11/32x1-27/32 12 PCS	9/32x2 12 PCS	5/32x3-1/8 12 PCS



200 PCS



## SET DE 2 PINCES CROCODILES

53357 7,00€

0,01 6 24 1080



2 PCS  
30 AMP



## ÉTUI DE FUSIBLES MINI

53355 11,50€

0,15 6 24 672



120 PCS



	5A 20 PCS	10A 20 PCS	15A 20 PCS	20A 20 PCS	25A 20 PCS	30A 20 PCS
--	-----------	------------	------------	------------	------------	------------

## ÉTUI DE FUSIBLES

53356 11,50€

0,25 6 24 672



### PIÈCES DE RECHANGE DISPONIBLES

REF.	MESURE	Kg	ff	€/u.
10915	5A	0,01	20	0,25€
10917	10A	0,01	20	0,30€
10918	15A	0,01	20	0,30€
10919	20A	0,01	20	0,30€
10920	25A	0,01	20	0,25€
10921	30A	0,01	20	0,30€

	15A 20 PCS
--	------------

	5A 20 PCS	10A 20 PCS
--	-----------	------------

	20A 20 PCS	25A 20 PCS	30A 20 PCS
--	------------	------------	------------



120 PCS



## ÉTUI DE FUSIBLES

53367 9,50€

0,10 6 24 1560



48 PCS

	5A 8 PCS	10A 8 PCS	15A 8 PCS		20A 8 PCS	25A 8 PCS	30A 8 PCS
--	----------	-----------	-----------	--	-----------	-----------	-----------

## ÉTUI DE FUSIBLES

53368 9,00€

0,10 6 24 1368



Mini fusibles



50 PCS



	5A 8 PCS	10A 8 PCS	15A 8 PCS	20A 8 PCS	25A 8 PCS	30A 10 PCS
--	----------	-----------	-----------	-----------	-----------	------------

## ÉTUI DE FUSIBLES MINI

53380 11,50€

0,15 6 24 672



	5A	10A	15A
	20 PCS	20 PCS	20 PCS
	20A	25A	30A
	20 PCS	20 PCS	20 PCS



## ÉTUI DE FUSIBLES ANFICHABLES

52054 17,00€

0,30 6 24 672



PIÈCES DE RECHANGE DISPONIBLES

252 PCS



MINI XXA

REF.	COLOR	PUISSANCE	Kg	ff	tray	€/u.
10905	Blue	3A	0,01	20	-	0,25€
10906	Red	4A	0,01	20	-	0,25€
10907	Brown	5A	0,01	20	-	0,25€



STANDARD XXA

REF.	COLOR	PUISSANCE	Kg	ff	tray	€/u.
10914	Pink	4A	0,01	20	-	0,25€
10915	Yellow	5A	0,01	20	-	0,25€
12954	Purple	3A	0,01	20	-	0,25€

3A	4A	5A	7,5A	10A	15A	20A	25A	30A
20 PCS	20 PCS	20 PCS	20 PCS	20 PCS	20 PCS	20 PCS	20 PCS	20 PCS
3A	4A	5A	7,5A	10A	15A	20A	25A	30A
8 PCS	8 PCS	8 PCS	8 PCS	8 PCS	8 PCS	8 PCS	8 PCS	8 PCS



MINI XXA

REF.	COLOR	PUISSANCE	Kg	ff	tray	€/u.
10908	Yellow	7,5A	0,01	20	-	0,30€
10909	Pink	10A	0,01	20	1000	0,30€
10910	Blue	15A	0,01	20	-	0,30€



STANDARD XXA

REF.	COLOR	PUISSANCE	Kg	ff	tray	€/u.
10916	Brown	7,5A	0,01	20	-	0,30€
10917	Red	10A	0,01	20	4000	0,30€
10918	Blue	15A	0,01	20	3500	0,30€



MINI XXA

REF.	COLOR	PUISSANCE	Kg	ff	tray	€/u.
10911	Yellow	20A	0,01	20	1000	0,30€
10912	Grey	25A	0,01	20	-	0,25€
10913	Green	30A	0,01	20	-	0,30€



STANDARD XXA

REF.	COLOR	PUISSANCE	Kg	ff	tray	€/u.
10919	Yellow	20A	0,01	20	2000	0,30€
10920	Grey	25A	0,01	20	2000	0,25€
10921	Green	30A	0,01	20	2000	0,30€

## MALETTE DE COSSES 635 PIÈCES

52053 45,00€

0,55 6 24 576



PIÈCES DE RECHANGE DISPONIBLES



635 PCS



REF.	COLOR	PUISSANCE	Kg	ff	tray	€/u.
10885	Red	RV1.25-4S	0,01	20	-	0,20€
10886	Blue	RV2-4S	0,01	20	-	0,20€
10887	Blue	RV2-6S	0,01	20	-	0,25€
10888	Yellow	RV5.5-6S	0,01	20	-	0,30€
10889	Yellow	RV5.5-5S	0,01	20	-	0,30€
10893	Blue	RV2-5S	0,01	20	-	0,25€



REF.	COLOR	PUISSANCE	Kg	ff	tray	€/u.
10894	Red	SV1-4S	0,01	20	-	0,20€
10895	Blue	SV2-4S	0,01	20	-	0,20€



REF.	COLOR	PUISSANCE	Kg	ff	tray	€/u.
10890	Yellow	BV5.5	0,01	20	-	0,35€
10891	Blue	BV2	0,01	20	-	0,25€
10892	Red	BV1.25	0,01	20	-	0,30€



REF.	COLOR	PUISSANCE	Kg	ff	tray	€/u.
10896	Red	FDD1.25-250	0,01	20	2000	0,30€
10898	Blue	FDD2-250	0,01	20	1500	0,30€
10900	Yellow	FDD5.5-250	0,01	20	2000	0,30€



REF.	COLOR	PUISSANCE	Kg	ff	tray	€/u.
10902	Purple	FDFN 1.25-250	0,01	20	2000	0,30€



REF.	COLOR	PUISSANCE	Kg	ff	tray	€/u.
10897	Red	MDD1.25-250	0,01	20	-	0,30€
10899	Blue	MDD2-250	0,01	20	3000	0,30€
10901	Yellow	MDD5.5-250	0,01	20	-	0,25€

50 PCS	50 PCS	30 PCS	20 PCS	20 PCS	15 PCS
25 PCS	30 PCS	40 PCS	50 PCS	40 PCS	45 PCS
50 PCS	40 PCS	50 PCS	25 PCS	30 PCS	25 PCS

PINCE À SERTIR

VOIR PAGE 59



# COFFRET CLIPS EN PLASTIQUE

UNITÉS DANS L'ÉTUI | UNITÉS PAR SAC DE PIÈCES DE RECHANGE



SACS PAR SOUS-BOÎTE / BOÎTE

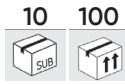

PIECES DE RECHANGE DISPONIBLES

## POUR MAZDA

52896 26,00€



190 PCS



13110 1,85€  
OE 6508197AA



13111 1,20€  
OE B1016825200



13112 1,65€  
OE B09251833

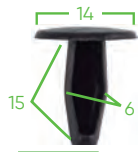

13113 2,20€  
OE 992640543A



13114 2,20€  
OE B45556741

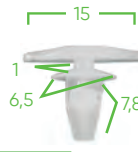

13115 2,50€  
OE G03158762



13104 1,90€  
OE 2042301

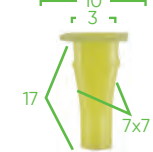

13105 2,50€  
OE 999100402

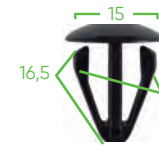

13106 2,00€  
OE B0016830200



13107 2,15€  
OE N30413356A



13108 1,90€  
OE 992640543A



13109 2,90€  
OE 99249051B

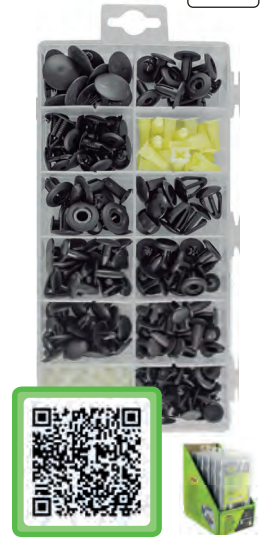

## POUR TOYOTA / LEXUS

52886 18,00€

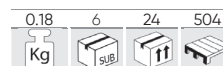

89 PCS

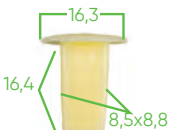

13002 1,45€  
OE 9018906001



13003 1,70€  
OE 9046707138



13004 1,85€  
OE 9046707117

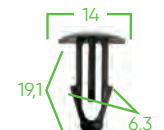

13005 1,25€  
OE 9046709138



13006 1,40€  
OE 9046709101

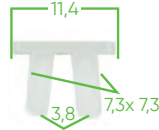

13007 1,30€  
OE 75521611000

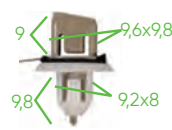

13008 2,25€  
OE 7503933060

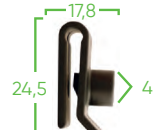

13009 1,65€  
OE 9017905060

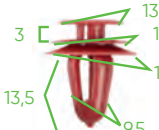

13010 1,75€  
OE 677711250



13011 1,15€  
OE 9046708124



13012 1,80€  
OE 7539533030



13013 1,75€  
OE 9046711063

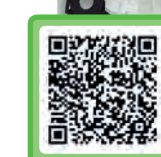

## POUR HONDA

52887 22,00€



150 PCS

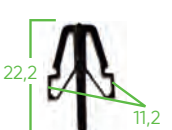

13014 1,45€  
OE 75103SJ4003



13015 1,20€  
OE 90675SB003



13016 1,15€  
OE 91566SP0003

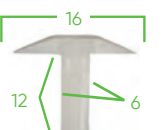

13017 2,60€  
OE 91513SE003



13018 1,45€  
OE 91530ST5003



13019 1,75€  
OE 90687SA50030



13020 1,70€  
OE 91620SR2003



13021 1,30€  
OE 38529689A6300



13022 2,10€  
OE 90683SA5003

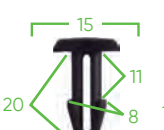

13023 1,50€  
OE 90672671003



13024 2,45€  
OE 91534SEO000

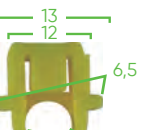

13025 1,50€  
OE 34355SD2003





# POUR PEUGEOT / CITROËN

**52899** 34,00€

0,50 6 24 336  
Kg SUB

**345**  
PCS

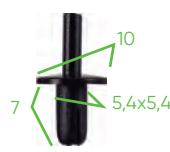

**13128** 50 50  
1,85€  
OE 947098



**13129** 20 20  
2,00€  
OE 856535

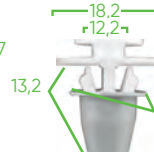

**13130** 20 20  
3,75€  
OE 6991W4



**13131** 20 20  
3,45€

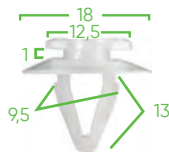

**13132** 25 25  
2,65€  
OE 694143

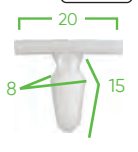

**13133** 35 35  
3,45€  
OE 743707



**13134** 30 30  
3,95€  
OE 7703074022

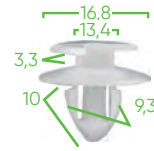

**13135** 35 35  
3,45€  
OE 7703077059



**13136** 15 15  
2,60€  
OE 698317

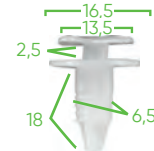

**13137** 25 25  
2,25€  
OE 699502



**13138** 30 30  
2,85€  
OE 6995X3

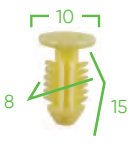

**13139** 40 40  
3,85€  
OE 69945

# POUR FIAT

**52900** 34,00€

0,50 6 24 336  
Kg SUB

**308**  
PCS



**13140** 30 30  
2,65€  
OE 14591784

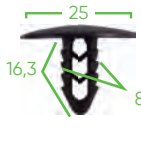

**13141** 20 10  
1,80€  
OE 1459487



**13142** 25 25  
3,10€  
OE 1300433650

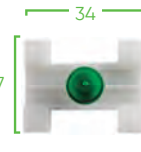

**13143** 8 8  
1,95€  
OE 71717421

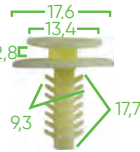

**13144** 25 25  
2,20€  
OE 82456515



**13145** 25 25  
3,85€  
OE 5757139



**13146** 20 8  
4,50€  
OE 46306526

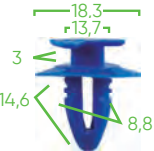

**13147** 25 25  
3,10€  
OE 14591687

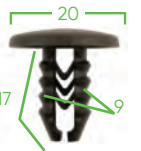

**13148** 25 25  
3,30€  
OE 14592387



**13149** 25 25  
3,10€  
OE 83468473

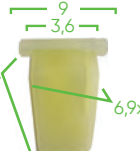

**13150** 30 30  
2,25€  
OE 7677865



**13151** 50 50  
5,35€

# POUR VOLVO

**52901** 34,00€

0,48 6 24 216  
Kg SUB

**350**  
PCS



**13152** 25 25  
3,05€  
OE 8099905N07



**13153** 30 30  
3,10€  
OE 4292906



**13154** 20 20  
3,20€  
OE 12681763



**13155** 40 40  
5,60€  
OE 51131804205

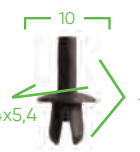

**13156** 40 40  
3,30€  
OE 947098

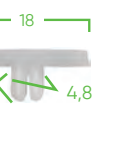

**13157** 40 40  
3,85€  
OE 591740



**13158** 25 25  
3,75€  
OE 6384801G00



**13159** 20 20  
3,20€  
OE 9133417



**13160** 40 40  
5,00€  
OE 9133073



**13161** 30 30  
3,55€  
OE 3272075327462B



**13162** 20 20  
2,60€  
OE 327462A



**13163** 20 20  
2,80€  
OE 3923712

# COFFRET CLIPS EN PLASTIQUE

## POUR VOLSKWAGEN

**52889** 19,00€

0,18 6 24 504  
Kg SUB

Technical drawings of plastic clips for Volkswagen with dimensions and part numbers:

- 13038: 2 2, OE 1H0868243B
- 13039: 10 10, OE N90833801
- 13040: 8 8, OE 3A0853575
- 13041: 5 5, OE 4A0853825
- 13042: 15 15, OE 6U085733
- 13043: 3 3, OE 3B0853576
- 13044: 6 6, OE 1H0819055B01C
- 13045: 5 5, OE 443853909A
- 13046: 6 6, OE 171885767
- 13047: 5 5, OE N9020160H
- 13048: 10 10, OE N0385501
- 13049: 10 10, OE 191941142

85  
PCS



## POUR BMW

**52892** 22,00€

0,17 6 24 672  
Kg SUB

Technical drawings of plastic clips for BMW with dimensions and part numbers:

- 13068: 25 25, OE 51311802258
- 13069: 30 30, OE 5131804205
- 13070: 10 10, OE 51118174185
- 13071: 10 10, OE 51481938725
- 13072: 15 15, OE 703867299
- 13073: 5 5, OE 51131960054

95  
PCS



## POUR NISSAN

**52894** 22,00€

0,15 6 24 672  
Kg SUB

Technical drawings of plastic clips for Nissan with dimensions and part numbers:

- 13080: 15 15, OE 76906T300
- 13081: 20 20, OE 0155300172
- 13082: 10 10, OE 68425H5000
- 13083: 6 6, OE 75521611000
- 13084: 20 20, OE 62869N4700
- 13085: 5 5, OE 6384401A00
- 13086: 5 5, OE 7688257A00
- 13087: 25 25, OE 6684101G00
- 13088: 10 10, OE 1099830880
- 13089: 10 10, OE 8942798070
- 13090: 8 8, OE 6384801G00
- 13091: 5 5, OE 6385401A00

139  
PCS



# COFFRET CLIPS EN PLASTIQUE

UNITÉS DANS L'ÉTUÍ | UNITÉS PAR SAC DE PIÉCES DE RECHANGE



SACS PAR SOUS-BOÍTE / BOÍTE



PIÉCES DE RECHANGE DISPONIBLES

## POUR AUDI

**52890** 22,00€

0,16 6 24 504  
Kg SUB 11 16

**31**  
PCS



**13052** 3 3  
1,25€

OE 1H0868243B

**13054** 5 5  
2,35€

**13055** 3 3  
3,00€

OE 3A0853575

**13050** 5 5  
1,55€

OE 3B0868243

**13051** 5 5  
1,50€

OE 1H0867199A

**13053** 10 10  
2,80€

OE 357853575

## POUR FORD

**52891** 28,00€

0,16 6 24 672  
Kg SUB 11 16

**169**  
PCS



**13056** 8 8  
1,55€

OE 388577S

**13057** 5 5  
1,50€

OE N801925S

**13058** 20 20  
2,20€

OE N806289S

**13059** 20 20  
2,35€

OE N379830S

**13060** 5 5  
1,60€

OE 1007932

**13061** 20 20  
2,65€

OE 16500308

**13062** 20 20  
2,35€

OE N803170S

**13063** 6 6  
1,15€

OE W706713S300

**13064** 20 20  
2,60€

OE N388246S

**13065** 15 15  
2,00€

OE F22Z16774A

**13066** 5 5  
2,25€

OE 1673046

**13067** 25 25  
2,55€

OE F1CZ16674A

## POUR BENZ

**52893** 26,00€

0,20 6 24 504  
Kg SUB 11 16

**95**  
PCS



**13074** 30 30  
4,65€

OE A0019884481

**13075** 20 20  
5,35€

OE A0019882981

**13076** 15 15  
3,90€

OE A1249900492

**13077** 4 4  
2,55€

OE A0019888081

**13078** 6 6  
2,55€

OE A1249880492

**13079** 20 20  
3,35€

OE A0019880325

# COFFRET CLIPS EN PLASTIQUE

## POUR RENAULT

52897 38,00€

0,43 6 24 336  
Kg SUB



13116 50 50  
5,45€

OE 7703077421

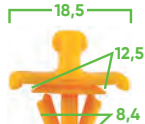

13117 50 50  
3,65€

OE 7703074022



13118 60 60  
15,90€

OE 7703081184

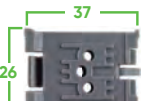

13119 15 15  
5,60€



13120 60 60  
5,50€

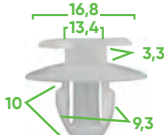

13121 65 65  
8,75€

OE 7703077059

300  
PCS



## POUR MITSUBISHI

52895 22,00€

0,19 6 24 1500  
Kg SUB



13092 15 15  
1,65€

OE 8942180270

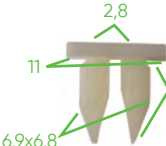

13093 30 30  
2,95€

OE 9018905013

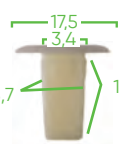

13094 10 10  
1,50€

OE MU480033



13095 8 6  
1,20€

OE 128100231



13096 8 8  
1,70€

OE MU480034



13097 3 3  
1,20€

OE MR138807



13098 4 4  
1,65€

OE MB253964



13099 30 30  
2,75€

OE HB121467



13100 3 3  
1,20€

OE MB271999

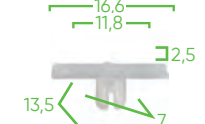

13101 8 8  
1,50€

OE MB696120



13102 5 5  
1,60€

OE MR200300

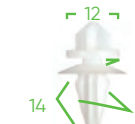

13103 10 10  
1,80€

OE MB846992

132  
PCS



## POUR VAUXHALL / OPEL

52898 36,00€

0,45 6 24 360  
Kg SUB



13122 20 20  
1,95€

OE 90218614



13123 40 40  
5,35€

OE 174864



13124 100 100  
8,20€

OE N0385501

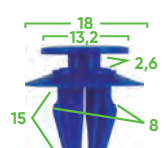

13125 50 50  
5,95€

OE 2345959



13126 50 50  
1,55€

OE 2240582



13127 40 40  
5,60€

OE 180942

300  
PCS



# COFFRET CLIPS EN PLASTIQUE







## UNIVERSEL

52888 24,00€

0,17 6 24 672  
Kg SUB 11 1

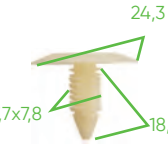
128 PCS

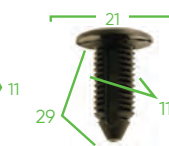
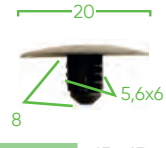
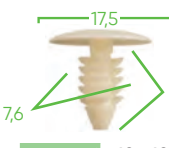
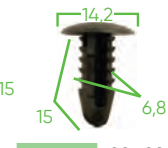

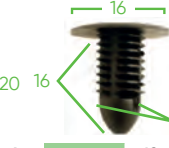
 <b>13026</b> 1,55€ 8 8 OE 388577S	 <b>13027</b> 1,85€ 10 10 GENERAL USE	 <b>13028</b> 1,45€ 6 6 OE 6003423	 <b>13029</b> 1,65€ 6 6 VW: N989022 CHRYSLER: 6003349 FORD: 385661	 <b>13030</b> 2,80€ 25 25 GM: 20699808 CHRYSLER: 6502328	 <b>13031</b> 1,85€ 4 4 FORD: N804379S
 <b>13032</b> 2,00€ 15 15 MAZDA: 6508197AA FORD: F22Z16774A	 <b>13033</b> 1,60€ 10 10 GM: 16674629 FORD: N8061135	 <b>13034</b> 2,65€ 20 20 NISSAN: 0153301781	 <b>13035</b> 1,65€ 6 6 GM: 10124502 BMW: 52201964201 LAND ROVER: DZM100080	 <b>13036</b> 1,40€ 6 6 VW: N9020160H FORD: 6998849 BMW: 51471904317 OPEL: 2207713	 <b>13037</b> 2,10€ 12 12 GENERAL USE

## POUR TAPISSERIE BMW MINI

53720 19,00€

0,20 6 24 672  
Kg SUB 11 1

112 PCS



 <b>14447</b> 1,45€ 7 6 OE 51471911992	 <b>14449</b> 2,20€ 13 10 OE A0009905492	 <b>14471</b> 1,90€ 5 5 OE 51717002953	 <b>14472</b> 1,35€ 5 5 OE 51489119216	 <b>14474</b> 1,50€ 8 8 OE 51118174185	 <b>14475</b> 1,65€ 6 6 OE 2019900050
 <b>14476</b> 2,05€ 9 9 OE 51481915964	 <b>14477</b> 2,45€ 15 15 OE 0009881625	 <b>14478</b> 4,05€ 15 15 OE 7146976114	 <b>14479</b> 1,65€ 6 6 OE 91503SP0003	 <b>14480</b> 2,05€ 15 15	 <b>14481</b> 1,70€ 8 8 OE 51161943122







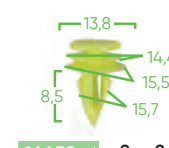

## POUR PANNEAUX DE PORTE/MOLDINGS BMW MINI

53719 19,00€

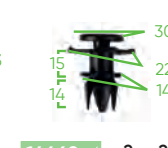
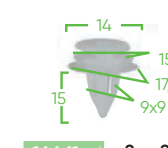
0,15 6 24 672  
Kg SUB 11 1

92 PCS

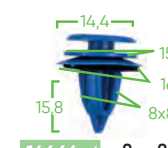

 <b>14359</b> 1,05€ 8 4 OE 51418224768	 <b>14458</b> 1,70€ 8 8	 <b>14459</b> 1,45€ 6 6	 <b>14460</b> 1,15€ 2 2 OE 7147122912	 <b>14461</b> 1,35€ 8 8 OE 51411973500	 <b>14462</b> 1,65€ 8 8
 <b>14463</b> 1,65€ 8 8	 <b>14464</b> 1,50€ 10 10 OE 611769	 <b>14465</b> 2,00€ 10 10 OE 7147145753	 <b>14466</b> 1,65€ 8 8	 <b>14468</b> 1,30€ 8 8	 <b>14469</b> 1,45€ 8 8 OE 7147133419

TVA non comprise

# COFFRET CLIPS EN PLASTIQUE

UNITÉS DANS L'ÉTIUI | UNITÉS PAR SAC DE PIÈCES DE RECHANGE



SACS PAR SOUS-BOÎTE / BOÎTE

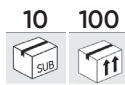

PIÈCES DE RECHANGE DISPONIBLES

## POUR TAPISSERIE MERCEDES-BENZ

**53718** 19,00€

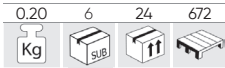

**151** PCS



## POUR PANNEAUX DE PORTE/MOLDINGS MERCEDES-BENZ

**53717** 19,00€

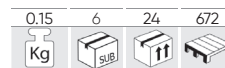

**96** PCS

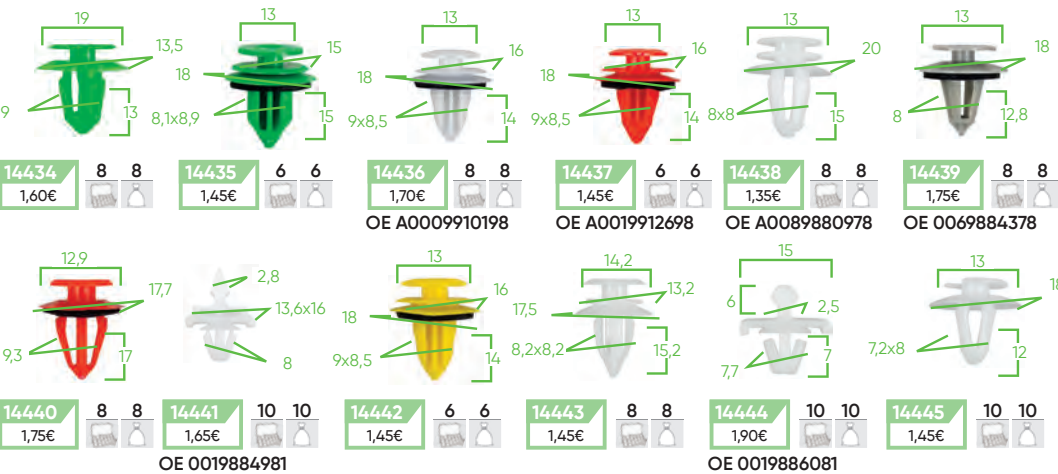

## POUR PANNEAUX DE PORTE/MOLDINGS/TAPISSERIE VAG/SEAT/SKODA

**53716** 19,00€

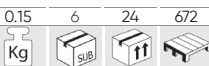

**79** PCS

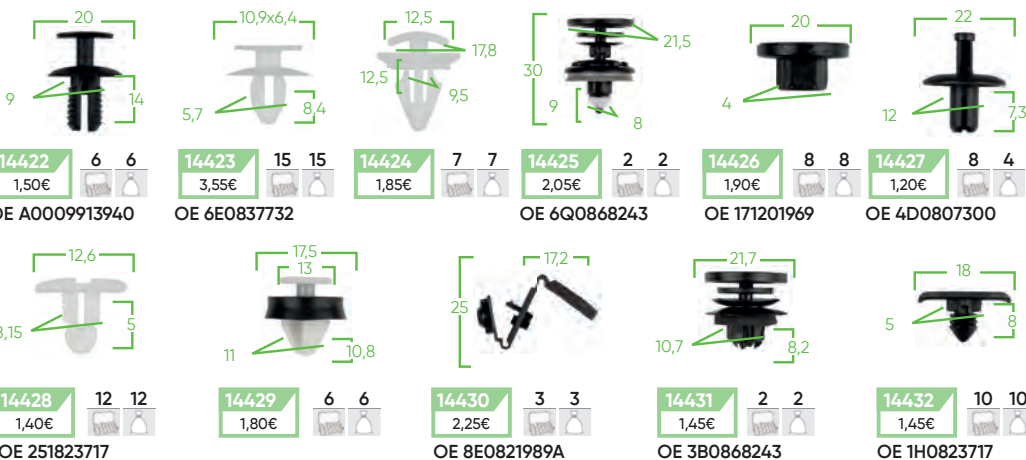

# COFFRET CLIPS EN PLASTIQUE

## POUR TAPISSERIE PEUGEOT/CITROËN

**53715** 19,00€



**110 PCS**

 14410 1,85€ 10 10	 14411 1,70€ 10 5	 14412 1,70€ 10 10	 14413 3,25€ 10 10	 14414 1,70€ 10 10 OE 2346824
 14415 1,70€ 10 10 OE A1249900492	 14416 1,25€ 10 5 OE 6992C6	 14419 1,95€ 15 15	 14420 1,50€ 15 15	 14421 2,45€ 10 10 OE 14093311

## POUR PANNEAUX DE PORTE PEUGEOT/CITROËN

**53713** 16,00€



**93 PCS**

 14350 1,80€ 6 6 OE 6991Y8	 14358 1,70€ 10 10 PEUGEOT: 6991Y8 CITROËN: 6991Y8 FIAT: 9654280780 RENAULT: 7703077469	 14387 1,45€ 8 8	 14388 2,05€ 8 8 OE 7703077250	 14389 1,25€ 6 6 OE 6995A3	 14390 1,35€ 6 6
 14391 2,15€ 15 15	 14392 1,35€ 6 6	 14393 1,50€ 8 8	 14395 1,65€ 8 8	 14396 1,20€ 6 6	 14397 1,45€ 6 6

## POUR MOLDINGS PEUGEOT/CITROËN

**53714** 16,00€



**80 PCS**

 14398 1,30€ 8 8 OE 6995X3	 14399 1,90€ 6 6 OE 129943	 14402 1,50€ 8 8 OE 856548	 14404 2,10€ 8 8 OE 71728806
 14405 1,45€ 16 8 OE 968865987703	 14406 1,55€ 10 10 OE 856540	 14408 1,45€ 10 10 OE 856534	 14409 1,35€ 8 8 OE 357853586

## PINCE POUR EXTRACTION D'AGRAFES DE CARROSSERIE

**53385** 19,30€

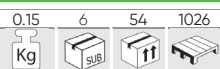

## JEU DE 2 LEVIERS

**52851** 9,65€

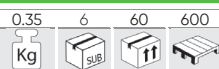

## SET DE 6 LEVIERS

**53110** 27,30€

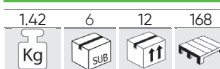

5"x8.5 / 5"x10.3  
5"x4.5 / 15"x8.5  
15"x10.3 / 15"x4.5mm

TVA non comprise

# POUR TAPISSERIE RENAULT / DACIA

**53712** 16,00€

0,15	6	24	672
Kg	Sub	Box	Tray

**14374** 3 3 1,70€  
 OE 7703077435  
**14375** 15 15 1,85€  
 OE 7L6868307  
**14376** 20 20 2,60€  
 OE 7703077117  
**14377** 10 10 1,90€  
**14378** 12 12 1,90€  
**14379** 6 6 1,45€  
**14381** 10 10 1,70€  
 OE 7703072360  
**14383** 6 6 1,35€  
**14382** 10 10 1,85€  
 OE 7703077153  
**14384** 12 12 2,10€  
 OE W705956S300  
**14416** 5 5 1,25€  
 OE 6992C6

109  
PCS



# POUR MOLDINGS RENAULT / DACIA

**53711** 16,00€

0,20	6	24	672
Kg	Sub	Box	Tray

**14358** 10 10 1,70€  
 PEUGEOT: 6991Y8  
 CITROËN: 6991Y8  
 FIAT: 9654280780  
 RENAULT: 703077469  
**14364** 10 10 1,90€  
 OPEL: 7701470779  
 NISSAN: 7703077421  
 RENAULT: 7703077421  
 IVECO: 500326896  
**14365** 10 10 1,90€  
 OPEL: 7701470779  
 NISSAN: 7703077421  
 RENAULT: 7703077421  
 IVECO: 500326896  
**14366** 8 8 1,45€  
 RENAULT: 7703077368  
 OPEL: 4430858  
**14356** 12 10 1,90€  
**14367** 3 3 1,30€  
 OE 7L5853994  
**14368** 8 8 1,45€  
**14369** 15 15 4,95€  
**14371** 3 3 3,00€  
 PEUGEOT: 6991Y8  
 CITROËN: 6991Y8  
 FIAT: 9654280780  
 RENAULT: 703077469  
**14370** 3 3 3,00€  
**14372** 4 4 1,20€  
 OE 7701061797  
**14373** 4 4 1,35€

90  
PCS



# POUR PANNEAUX DE PORTE RENAULT / DACIA

**53710** 16,00€

0,20	6	24	672
Kg	Sub	Box	Tray

**14350** 12 6 1,80€  
 OE 6991Y8  
**14351** 8 8 1,65€  
**14352** 7 7 1,30€  
 OE 51447780135  
**14353** 8 4 2,10€  
 OE 7703077476  
**14355** 8 8 1,70€  
 OE 7703077354  
**14356** 10 10 1,90€  
 OPEL: 4430858  
 RENAULT: 7703077368  
**14357** 10 10 1,90€  
 OE 7703077430  
**14358** 10 10 1,70€  
 OE 51418224768  
**14359** 4 4 1,05€  
**14368** 8 8 1,45€  
 PEUGEOT: 6991Y8  
 CITROËN: 6991Y8  
 FIAT: 9654280780  
 RENAULT: 7703077469

85  
PCS



# AFFICHE DE CLIPS

**15001** 3,00€

- Poster informatif des goupilles en plastique JBM. Avec toutes les informations de chaque goupille (référence, prix, quantités et mesures).



330x1000mm





# **VÊTEMENTS**

346 GILET  
BLOUSON

## GILET JBM

TAILLE L

**70002** 37,50€

0.40 - 5 200  
Kg SUB ITT

TAILLE XL

**70013** 44,00€

0.30 - 10 240  
Kg SUB ITT

TAILLE L

**70015** 44,00€

0.30 - 10 240  
Kg SUB ITT

TAILLE XL

**70003** 37,50€

0.40 - 5 200  
Kg SUB ITT

TAILLE M

**70014** 44,00€

0.30 - 10 240  
Kg SUB ITT

TAILLE XL

**70016** 44,00€

0.35 - 10 240  
Kg SUB ITT

TAILLE S

**70009** 37,50€

0.40 - 5 180  
Kg SUB ITT

TAILLE XXL

**70017** 44,00€

0.35 - 10 240  
Kg SUB ITT



70002, 70003



2 POCHES INTÉRIEURES DE GRANDE CAPACITÉ

70007, 70009



2 POCHES LATÉRALES

70013, 70014, 70015, 70016, 70017



Résistante au froid

Thermique

Légère

## BLOUSON JBM

TAILLE L

**70005** 42,00€

0.70 - 5 140  
Kg SUB ITT

**70011** 42,00€

0.60 - 5 120  
Kg SUB ITT

TAILLE XL

**70012** 42,00€

0.70 - 5 120  
Kg SUB ITT



COL HAUT AVEC FERMETURE ÉCLAIR



3 POCHES EXTÉRIURES



Résistante au froid

Thermique

Légère



490mm

CINTRE

**13929** 3,45€

0.10 - 280  
Kg SUB ITT



PRESENTOIR

**METEXP** 62,00€

6.00 - 1 25  
Kg SUB ITT



## **PROMOTIONNEL**

348 APPAREILS ÉLECTRONIQUES JBM  
352 PROMOTIONNELS  
354 PRÉSENTOIRS ET ACCESSOIRES  
EMBALLAGE

## CAMÉRA DE SPORT

53865 48,00€

0,30 - 36 432



- ✓ Boîtier étanche qui permet d'enregistrer à des profondeurs allant jusqu'à 30 mètres.
- ✓ Écran LCD haute résolution basé sur la technologie LTPS.
- ✓ Batterie amovible facile à remplacer.
- ✓ Enregistrement vidéo numérique, photographie, affichage vidéo et enregistrement sonore.
- ✓ Objectif HD grand angle 120°.
- ✓ Caméra Web.
- ✓ Prend en charge des cartes mémoire jusqu'à 64 GB.
- ✓ Prend en charge plusieurs formats d'enregistrement vidéo.
- ✓ Détection de mouvement et enregistrement en boucle.



ENREGISTREMENT  
HAUTE RÉOLUTION  
TION

### CONÇU POUR:

- L'enregistrement de véhicules
- La sécurité résidentielle
- La photographie
- Les sports de plein air
- enregistrement en eaux profondes
- Etc.

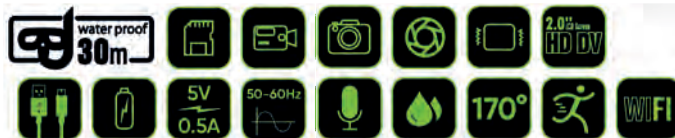

### ACCÉSSOIRES:

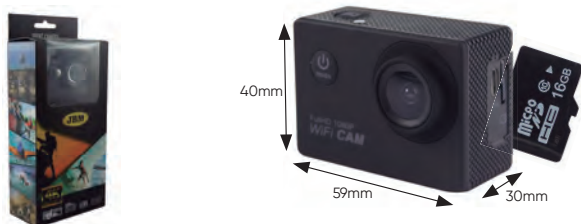

## CHAISE ROTATIVE

53956 353,00€

21.50 - 1 4



- ✓ Matériau: PU
- ✓ Épaisseur du cadre en acier: 1,2cm
- ✓ Assise: Mousse moulée
- ✓ Dossier: Mousse de polyuréthane
- ✓ Accoudoir: 2D
- ✓ Ascenseur à gaz: Classe 3
- ✓ Base en nylon: 350mm

COUSSIN  
D'APPUI-TÊTE

DIMENSIONS  
70X55X126-136CM

200Kg

HAUTEUR  
RÉGLABLE

COUSSIN  
LOMBAIRE

180°

830mm

BASE POUR  
FAUTEUIL ROTATIF

15256 1.85  
36,00€ Kg

ACCODOIR DROIT

15257 1.35  
27,50€ Kg

ACCODOIR GAUCHE

15258 1.35  
27,50€ Kg

AMORTISSEUR

15259 0.85  
18,00€ Kg

JEU DE 5 ROULEAUX

15260 0.60  
22,50€ Kg

## TONELLE JBM 3x3m

53973 284,00€

18.40 - 1 31



### LATÉRAL POUR REF. 53973

15152 160,00€

2.25 - 5



Il se compose de deux parties :  
- Partie latérale qui couvre 3/4 parties de la tente.  
- Partie avant qui couvre 1/4 de la tente. Avec fermeture éclair verticale en guise de porte.



IL COMPREND ÉTUI DE PROTECTION  
POUR STAND JBM

14347 36,50€

0.60 - 5

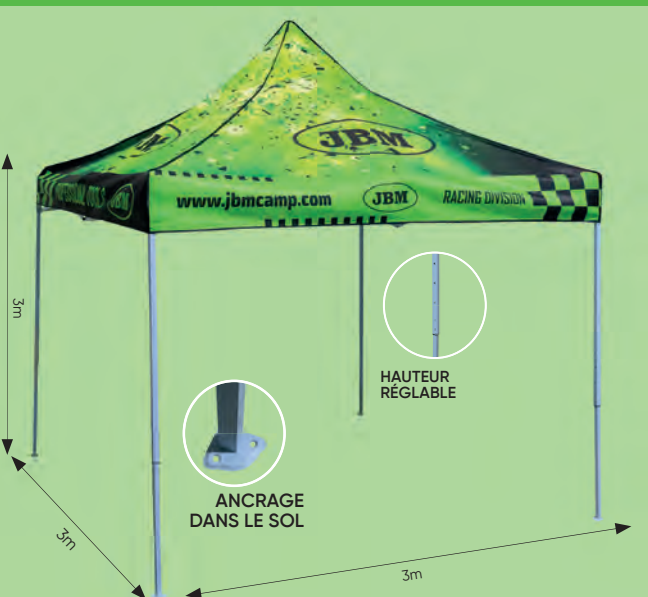

# ASPIRATEUR ROBOT

**54020** 288,00€



Le robot intelligent effectue un **nettoyage et un lavage automatiques**. Grâce à son système intelligent d'orientation spatiale, il peut nettoyer en profondeur la zone de travail. Une configuration flexible est possible avec le choix du mode de fonctionnement, le réglage du niveau d'aspiration et de l'humidité et la programmation des tâches pour une durée déterminée.

4-5H 100-180min 14.8V 2600mAh



3,4kg 68 dB 20cm/s 1200 Pa



**20W**

BROSSE LATÉRALE GAUCHE

**15340**

5,50€



BROSSE LATÉRALE DROITE

**15341**

5,50€



BROSSE PRINCIPALE

**15342**

9,00€



HEPA FILTER

**15343**

9,50€



OUTIL DE NETTOYAGE

**15344**

6,50€



JEU DE 5 VADROUILLES

**15345**

10,50€

CONNEXION DE L'APPLICATION



STATION D'ACCUEIL

**15346**

24,00€



TRANSFORMATEUR SECTEUR

**15349**

8,50€

Máxima superficie cubierta

Maximum covered area

**120m<sup>2</sup>**

Capacidad tanque de agua

Water tank capacity

**300ml**

Capacidad del depósito de polvo

Dust box capacity

**300ml**

# SAC À DOS JBM

**54043** 48,00€

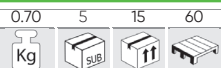

✓ **Espace de rangement et poches :**  
Grâce à ses deux compartiments, elle permet de ranger, entre autres, des ordinateurs portables jusqu'à 17,3 pouces et des tablettes.

✓ **Matériau :**  
Polyuréthane; sac à dos étanche, durable et fiable.

✓ **Léger et confortable :**  
une conception confortable et respirant du dos et des sangles en matériau en éponge.



# TEE-SHIRT JBM

REF.	TAILLE	Kg	Sub	ff	€
13243	M	0,25	100	600	12,50€
13244	L	0,26	100	600	12,50€
13245	XL	0,28	100	600	12,50€



# SAC JBM

**13968** 1,35€



# TASSE JBM

**54076** 9,00€



TVA non comprise

**JBM** / [www.jbmfrance.fr](http://www.jbmfrance.fr)

349

## STYLO 4 COULEURS PROMOTIONNEL JBM

53533 1,50€

0,01	50	1000	12000
Kg	Sub	ff	



- Stylo à 4 couleurs: bleu, rouge, noir, vert.

AVEC POINTEUR  
ARRIÈRE EN CAOUT-  
CHOUIC POUR ÉCRI-  
RE SUR LES ÉCRANS  
TACTILES



## PRÉSENTOIR JBM DE DISTRIBUTEUR

15789 2.545,00€

40.50	-	1	6
Kg	Sub	ff	

L'écran promotionnel JBM est l'avenir de la publicité pour votre entreprise. Avec sa taille LCD de 43" et sa technologie LED, il sera le centre d'attention dans n'importe quel magasin. Ils sont conçus pour avoir un impact. Des images et des vidéos en constante évolution qui créent un effet d'attraction garanti sur le public. Contrairement à la publicité conventionnelle sur les panneaux d'affichage, les enseignes, etc., la publicité sur les écrans LED est très dynamique. Ces caractéristiques font de l'écran promotionnel JBM un produit très rentable qui apportera de grands avantages à votre magasin.



x2



43"



181cm

45cm

59cm

## FRITEUSE À AIR

54171 138,00€

4,90	-	2	18
Kg	Sub	ff	



3,5L	≤65dB	220V 240V	1500W
80°C 200°C	360°	0-60'	



## VÉLO DE FITNESS

53930 276,00€

29,00	-	1	5
Kg	Sub	ff	

- Durée: 0:00~99:59 min
- Distance: 0,00~9999 miles (km)
- Distance totale: 0,00~9999 miles (km)
- Vitesse: 0,0~9999
- Calories: 0,0~9999 kcal
- Pouls: 40~240 bpm
- Pile: AAA, 2 pièces
- Température de fonctionnement: 0 ~ 40°C (32-104°F)
- Température de stockage: 10 ~ 60°C (14-168°F)



SIÈGE CON-  
FORTABLE



ROUES POUR  
TRANSPORT



RÉGLAGE DE  
L'EFFORT



POIGNÉE PRATIQUE

### FONCTIONS DE MESURE:

- DURÉE
- VITESSE
- DISTANCE
- CALORIES
- DISTANCE TOTALE
- POULS
- SCANNING



350

JBM / [www.jbmfrance.fr](http://www.jbmfrance.fr)

TVA non comprise

## TROTINETTE

**53504** 38,00€

3,50 Kg 6 SUB 6 36

77mm 100mm



## TAPIS DE COURSE

**53934** 690,00€

0,25 Kg 10 SUB 40 1480

1160mm 1450mm 675mm

110 KG

- Tension d'alimentation: 220 V - 240 V
- Fréquence du réseau: 50 - 60 Hz
- Puissance nominale: 550 W
- Puissance max.: 1500 W (2,0 ch)
- Vitesse: 1,0 - 12 niveaux (vitesse maximale 9,5 km/h)
- Taille en état plié: 970x675x1275 mm
- Taille du tapis: 400x1100 mm
- Taille: 1450\*675\*1160 mm
- Écran: 3,5", rétroéclairage bleu

**FUNCTION D'AFFICHAGE:**

- DURÉE
- DISTANCE
- VITESSE
- CALORIES
- POULS

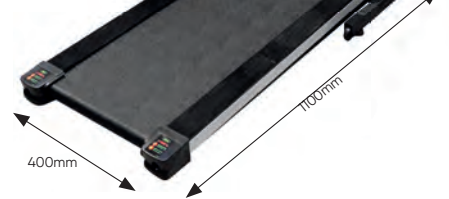

## GRILLE BARBECUE

**53931** 104,00€

6,10 Kg 1 SUB 1 18

ACERO STEEL Cr Zn

- Type: grille carrée
- Matériau: fer et barre
- Épaisseur: 0,4 mm
- Revêtement: couvercle - poudre noire, bol - porcelaine noire
- Grille de cuisson: 43x40 cm, chromée
- Grille à charbon: 36x36 cm, galvanisée
- Hauteur de travail pendant la cuisson: 59 cm
- Pieds: acier inoxydable 430, 19 mm de diamètre



UNE GRILLE DE CUISSON, UNE GRILLE À CHARBON ET UNE GRILLE CHAUFFANTE

OUVERTURE DE VENTILATION DANS LE COUVERCLE



REVÊTEMENT: COUVERCLE - POUDRE NOIRE, BOL - PORCELAINES NOIR



PLANCHE LATÉRALE, 2 ROUES, POIGNÉE ET LE BOL

PIEDS: ACIER INOXYDABLE

## SUPPORT À JAMBON

**14975** 64,00€

2,95 Kg 4 SUB 4 80

- Dimensions: 500x330x440mm
- Poids: 2,18kg

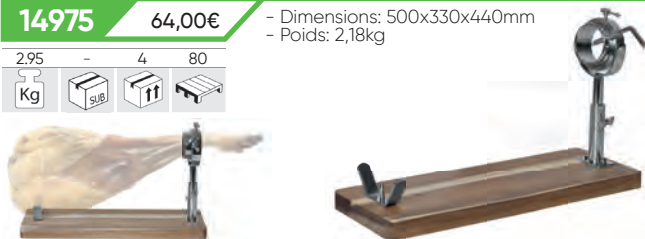

## KIT DE COUTEAUX

**53511** 23,00€

0,65 Kg 5 SUB 20 360



3 PCS

## POCHE JBM RÉFRIGÉRATEUR

**53949** 4,50€

0,10 Kg 15 SUB 15 540

**53950** 4,50€

0,10 Kg 15 SUB 15 630

350mm 675mm 675mm



## KIT D'OUTILS

**53512** 41,00€

1,90 Kg 12 SUB 12 144



24 PCS

## PARAPLUIE PROMOTIONNEL JBM

**52857** 7,50€

0,31 Kg 10 SUB 60 600

84mm



## COLLIER EN PERLES

**53513** 9,00€

0,05 Kg 9 SUB 495 5940



## KIT DE SERVIETTES

**53510** 24,00€

0,65 Kg 25 SUB 100



2 PCS

TVA non comprise

**JBM** / [www.jbmfrance.fr](http://www.jbmfrance.fr)

351

# PRÉSENTOIR LINÉAIRE VIDE

**53877** 430,50€

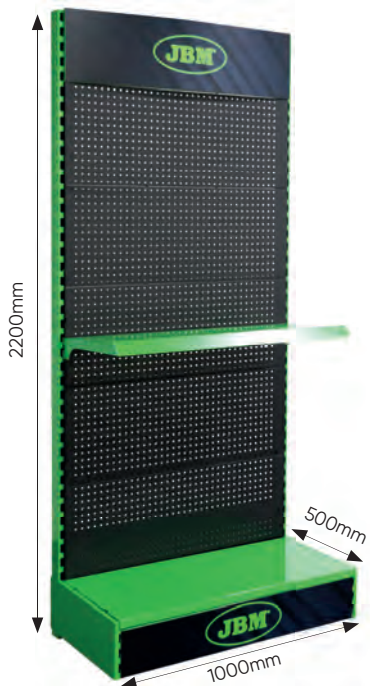
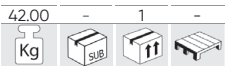

## CONTIENT

**14945** x1



**11318** x20



**14380** x1



**14946** x1



# PIÈCES DÉTACHÉE S AFFICHAGE D'OUTILS

**14946** 58,00€



TÊTE POUR  
PRÉSENTOIR D'OUTILS

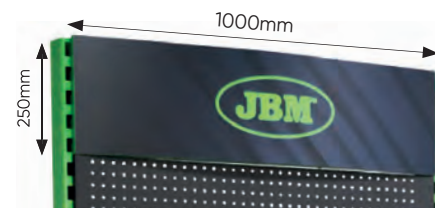

**14947** 201,50€



PORTE-AFFICHAGE  
D'OUTILS ALLÉGÉ

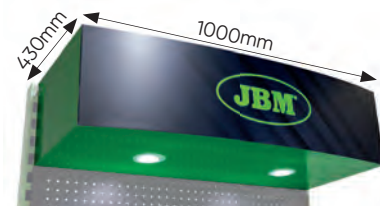

**14380** 51,00€



PLATEAU DE  
PORTE-AFFICHAGE  
D'OUTILS 53877

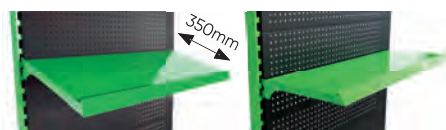

# AFFICHAGE OUTILS + ÉCLAIRAGE

**53878** 574,00€



# AFFICHAGE OUTILS + ÉCLAIRAGE ET PORTES

**53879** 838,50€



**14996** 65,00€



PLATEAU DE  
PORTE-AFFICHAGE  
D'OUTILS AVEC  
PORTE

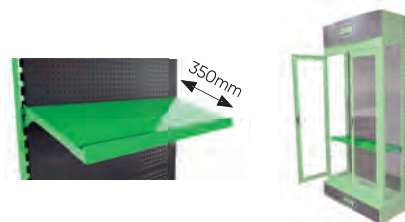

**14948** 251,50€



JEU DE 2 PORTES POUR  
PORTE-OUTILS

**14945** 303,50€



AFFICHAGE  
D'OUTILS



## CONTIENT

**14945** x1



**14380** x1



**14947** x1



**11318** x20



## CONTIENT

**14945** x1



**14948** x1



**11318** x20



**14996** x1



**14947** x1





## PLATEAU

**14622**

17,00€

POUR REF. 60001, 60003, 60004, 60020

0,95	-	10	360
Kg	sub	ff	ff

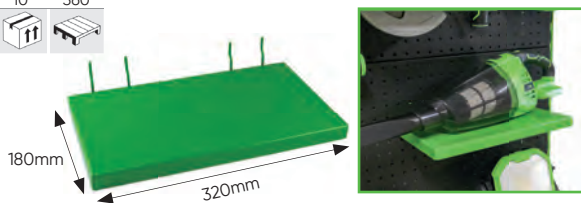

**14624**

17,00€

POUR REF. 60007, 60010, 60011

0,65	-	10	300
Kg	sub	ff	ff

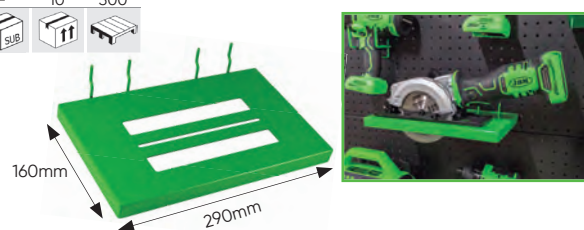

## CROCHETS

**14626**

7,00€

POUR REF. 60023

0,10	-	10	-
Kg	sub	ff	ff

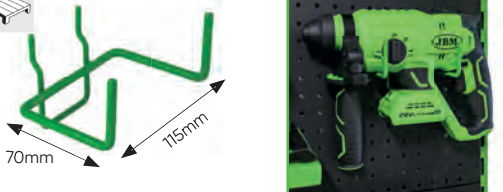

**14623**

8,00€

POUR REF. 60005, 60006, 60018

0,10	-	10	800
Kg	sub	ff	ff

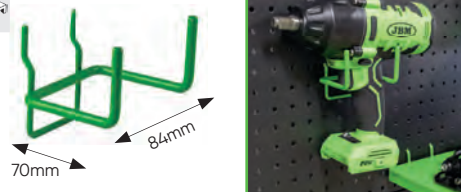

## CROCHETS

À UNE POINTE

**11318**

2,50€

0,04	20	600	-
Kg	sub	ff	ff



À POINTE FERMÉE

**51315**

2,50€

0,02	20	320	44800
Kg	sub	ff	ff



POUR OUTILS PNEUMATIQUES

**14034**

9,00€

0,20	20	80	1920
Kg	sub	ff	ff



## CROCHET POUR REF. 60008, 60009

**14625**

14,00€

0,50	-	10	700
Kg	sub	ff	ff

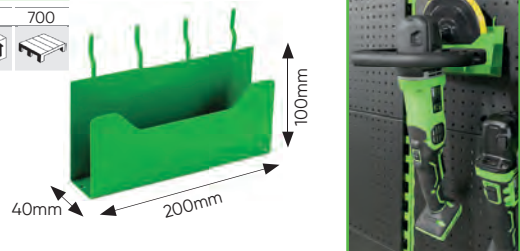

## PRÉSENTOIR POUR OUTILS PNEUMATIQUES

**53492**

380,00€

LIVRE SANS OUTIL

13,00	-	1	7
Kg	sub	ff	ff



## PRESENTOIR POUR TAPIS

**METEXP**

62,00€

6,00	-	1	25
Kg	sub	ff	ff



TVA non comprise

## PÔLE DE SÉPARATION AVEC BANDE RÉTRACTABLE

53914 75,00€

8.50	-	5	90
Kg	Sub	ff	

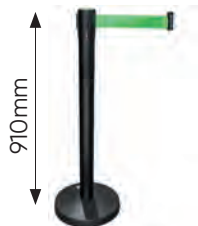

- Matériel: acier
- Diamètre du tube: 63 mm
- Diamètre de la base: 320 mm
- Hauteur: 910 mm

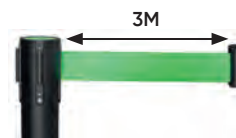

- Sortie ruban dans 4 directions
- Longueur du ruban: 3 m
- Largeur de ceinture: 48 mm

SORTIE DE RUBAN À 4 VOIES

## BOÎTE À OUTILS À MAINS DE RECHANGE

REF.	cm	Kg	ff	€
14922	14,5x9x10	0,10	100	0,84€
14923	17,5x9x7	0,10	100	0,84€
14924	24x11x7	0,10	100	0,84€
14925	31,5x13x4	0,10	100	0,84€
14926	32x8,5x7	0,10	100	1,05€



## ADHÉSIF DE GARANTIE JBM

14807 11,00€

0.45	6	24	864
Kg	Sub	ff	

- 75mm large x 125m long
- Fabriqué en polypropylène
- Adhésif solvant
- Epaisseur: 28 microns



TOUTES LES LANGUES DANS LE MÊME ADHÉSIF

## BOÎTE EN CARTON PROMOTIONNELLE DE NOËL

REF.	cm	Kg	ff	€	
14976	80x31x61	2,20	1	80	18,84€
15056	40x30x61	1,60	1	70	11,70€
13717	76x14x29	0,90	1	200	7,65€
14083	80x28x49	1,80	1	100	13,20€



14083



13717



14976



15056



## BOÎTE EN CARTON JBM



12950



14189

14507

REF.	cm	Kg	ff	€	
11330	19x10x11	0,05	50	4.200	0,57€
12952	40x30x20	0,40	30	360	1,92€
15051	40x32x30	0,40	20	160	1,92€
14974	54x24x40	0,65	20	150	2,28€
13217	57x30x25	0,55	15	150	1,31€
12950	60x40x30	0,80	15	75	3,45€

REF.	CARACTÉRISTIQUES	Kg	ff	€	
14189	Caisse palette américaine triple canal 120x80x100cm	10	1	40	52,00€
14507	Caisse-palette européenne 120x98x80cm	8	1	40	50,00€

# LÉGENDES



## CARACTÉRISTIQUES GÉNÉRALES



Poids de l'article en



Quantité d'articles par sous-caisse



Quantité d'articles par présentation



Quantité d'articles par sac



Quantité d'articles par boîte



Quantité de sac par boîte



Quantité d'articles par palette



Présentation en blister



Aimanté



Poids supporté par l'aimant



83 dBa

Niveau sonore (decibel)



2kg

Poids



ZOOM

Zoom



Connexion bluetooth



Connexion USB

## LÉGENDE MATÉRIAUX



Bois



Acier



PVC



Chrome



Laiton



Cuivre



Néodyme



Aluminium



Nylon



Polypropylène



Maçonnerie



Zingage



Chrome Vanadium



CrMo



## LÉGENDE DOUILLES ET POINTES



Douille carrée



Douilles 12 pans



Douille hexagonale



Douille pointe XZN



Douille Twist



Douille Spline



Pointe Slotted



Pointe Ribbe



Pointe Philips (cruiforme)



Pointe Pozidriv (cruiforme double)



Cuadri-pointe



Pointe Torx inviolable



Pointe Torx inviolable -XZN



Pointe Torx



Tri-pointe



Pointe TS 5 pointes



Pointes 12 pans



Pointe tendeur



Allen



Papillon



Pointe Allen



Allen



Cabota normale



Cabota ronde



## LÉGENDE DES PRODUITS PNEUMATIQUES



Révolution / minute (général)



Révolution / minute (en avant)



Révolution / minute (inverse)



Newton-mètre (Nm)/Kilo-grammes (Kg)



Libre par pouce carré



Unité de pression (Bar)



Entrée d'air



Sortie arrière



Sortie arrière de 360°



Sortie frontale



Sortie frontale



Sortie frontale



Mesure



Manche ergonomique



Orbite de disque



Diamètre de disque



Taille broche



Mesure d'entrée perceuse



Mouvements à 360°



Nombre de vitesses



Force



Mecanisme de double marteaux



Angle de 90°

# LÉGENDES



## LÉGENDE DES PRODUITS ÉLECTRONIQUES

Type de Led: SMD	Type de Led: COB	Type de Led: Cree XP-E	Quantité/ puissance Led	Quantité de Leds	Distance d'illumination	3 intensités de lumière	Flux lumineux (Lumen)
Lumière répartie	Lumière concentrée	Quantité de types de flash	Puissance Volts/ Watts	Durée de vie de la batterie	Durée de charge	Type de batterie	Nombre de piles AAA
Transformateur/ prise murale	Chargeur USB	Prise allume-cigare	Base inclinable	Crochet	Crochet giratoire	Longueur de câble	Largo de câble



## CERTIFICATS ET NORMES DE CONFORMITÉ



Conforme à la Loi de Sécurité des Produits Allemands (ProdSG)



Normes conformes aux gants de protection



## LÉGENDE DE L'OUTILLAGE



Compresseur de ressort



Démontage amortisseurs



## LÉGENDE DES PRODUITS LUBRIFIANTS



Capacité entonnoir



Couler



# INDICE NUMÉRIQUE

REF.	Pg.	PDV	REF.	Pg.	PDV	REF.	Pg.	PDV	REF.	Pg.	PDV
10054	192	2,90€	10569	38	4,50€	10674	205	9,50€	10831	329	0,20€
10055	192	3,90€	10570	38	4,50€	10675	205	9,50€	10832	329	0,20€
10485	193	8,10€	10571	38	5,00€	10720	280	24,50€	10833	329	0,20€
10486	193	8,00€	10579	38	3,00€	10721	280	19,00€	10834	329	0,25€
10494	193	6,50€	10580	38	3,10€	10722	280	24,50€	10835	329	0,25€
10495	193	3,00€	10581	38	3,40€	10723	280	29,50€	10836	329	0,30€
10496	193	3,00€	10582	38	4,00€	10724	280	29,50€	10837	329	0,30€
10497	193	3,00€	10583	38	4,15€	10731	79	17,60€	10838	329	0,30€
10498	193	3,00€	10584	38	5,05€	10732	79	18,70€	10839	329	0,40€
10499	193	3,00€	10585	38	6,75€	10733	79	17,50€	10840	329	0,35€
10500	193	3,00€	10586	38	7,60€	10735	79	20,30€	10868	333	0,30€
10501	193	8,10€	10587	38	9,80€	10750	124	13,00€	10869	333	0,30€
10502	193	3,50€	10588	38	10,50€	10751	124	15,00€	10870	333	0,45€
10527	36	13,10€	10589	38	2,00€	10761	280	16,00€	10871	333	0,30€
10528	36	15,80€	10590	38	2,40€	10762	280	23,50€	10872	333	0,40€
10529	36	18,00€	10591	40	2,50€	10766	124,130	1,59€	10873	333	0,45€
10530	36	28,70€	10592	40	2,55€	10767	252	21,00€	10874	333	0,30€
10531	37	3,00€	10593	40	3,15€	10768	261	113,00€	10875	333	0,40€
10532	37	2,70€	10594	40	3,20€	10769	261	21,00€	10876	333	0,45€
10533	37	3,00€	10595	40	3,35€	10770	261	6,00€	10877	327	0,25€
10534	37	3,25€	10596	40	4,25€	10772	328	0,05€	10878	327	0,30€
10535	37	3,50€	10597	40	4,50€	10773	328	0,10€	10879	327	0,20€
10536	37	3,65€	10598	40	4,60€	10774	328	0,10€	10880	327	0,20€
10537	37	3,90€	10599	40	6,00€	10775	328	0,15€	10881	327	0,25€
10538	37	4,30€	10600	40	6,25€	10776	328	0,20€	10882	325	0,25€
10539	37	4,75€	10601	40	6,50€	10777	328	0,20€	10883	325	0,25€
10540	37	5,25€	10602	40	7,05€	10778	328	0,35€	10884	325	0,25€
10541	37	5,55€	10603	40	2,10€	10779	326,328	0,05€	10885	335	0,20€
10542	37	5,85€	10604	40	2,25€	10780	326,328	0,05€	10886	335	0,20€
10543	37	7,00€	10617	36	14,10€	10781	326,328	0,05€	10887	335	0,25€
10544	37	8,10€	10618	36	15,10€	10782	328	0,05€	10888	335	0,30€
10545	37	9,75€	10619	36	15,70€	10783	328	0,05€	10889	335	0,30€
10546	37	11,60€	10620	36	16,20€	10784	326	0,05€	10890	335	0,35€
10547	37	13,50€	10621	36	9,50€	10785	326,328	0,10€	10891	335	0,25€
10548	37	1,75€	10622	36	10,00€	10786	326,328	0,15€	10892	335	0,30€
10549	37	2,00€	10623	36	12,60€	10787	328	0,05€	10893	335	0,25€
10550	37	2,15€	10624	36	13,50€	10788	328	0,05€	10894	335	0,20€
10551	37	2,15€	10625	36	15,70€	10789	328	0,05€	10895	335	0,20€
10552	34	7,10€	10626	36	17,80€	10790	328	0,05€	10896	335	0,30€
10553	34	7,35€	10627	39	2,80€	10791	328	0,05€	10897	335	0,30€
10554	34	7,50€	10628	39	3,10€	10792	328	0,05€	10898	335	0,30€
10555	34	7,80€	10629	39	3,65€	10793	325	0,25€	10899	335	0,30€
10556	34	8,10€	10630	39	3,90€	10794	325	0,40€	10900	335	0,30€
10557	34	8,10€	10631	39	4,20€	10795	325	0,60€	10901	335	0,25€
10558	34	9,35€	10632	39	5,30€	10805	326	0,10€	10902	335	0,30€
10559	34	9,50€	10633	39	6,60€	10812	326	0,30€	10905	335	0,25€
10560	34	10,60€	10634	39	7,80€	10813	326	0,30€	10906	335	0,25€
10561	34	11,00€	10635	39	8,15€	10823	329	0,20€	10907	335	0,25€
10562	34	12,30€	10636	39	8,80€	10824	329	0,20€	10908	335	0,30€
10563	34	12,50€	10637	39	12,10€	10825	329	0,20€	10909	335	0,30€
10564	38	2,50€	10638	39	12,70€	10826	329	0,40€	10910	335	0,30€
10565	38	3,50€	10639	261	10,90€	10827	329	0,60€	10911	335	0,30€
10566	38	3,50€	10671	270	15,20€	10828	329	0,45€	10912	335	0,25€
10567	38	3,50€	10672	205	9,50€	10829	329	0,20€	10913	335	0,30€
10568	38	4,00€	10673	205	9,50€	10830	329	0,20€	10914	335	0,25€

REF.	Pg.	PDV	REF.	Pg.	PDV	REF.	Pg.	PDV	REF.	Pg.	PDV
10915	334,335	0,25€	11152	155	57,00€	11318	353,352	2,50€	11891	313	0,50€
10916	335	0,30€	11153	154,155	23,40€	11323	267	16,00€	11892	270	12,50€
10917	334,335	0,30€	11154	155	21,70€	11324	124	17,50€	11893	190	7,00€
10918	334,335	0,30€	11155	154,155	24,40€	11325	124	17,50€	11894	190	7,00€
10919	334,335	0,30€	11156	155	28,90€	11328	298	4,00€	11895	190	8,65€
10920	334,335	0,25€	11157	155	26,60€	11329	276	564,00€	11896	190	8,80€
10921	334,335	0,30€	11158	154,155	28,50€	11330	354	0,57€	11897	172	155,00€
10923	119	1,10€	11159	155	30,30€	11360	28	2,60€	11900	310	3,50€
10925	252	18,00€	11160	155	27,00€	11362	28	5,20€	11901	310	2,50€
10945	298	2,30€	11161	155	32,30€	11363	28	3,90€	11902	310	3,50€
10953	195	12,50€	11162	155	29,10€	11364	28	4,50€	11903	310	5,00€
10955	178	11,00€	11163	155	32,70€	11365	28	9,40€	11904	310	2,00€
10961	120	13,00€	11164	155	30,70€	11374	178	5,50€	11905	310	1,50€
10962	264	85,00€	11165	155	34,60€	11375	178	6,50€	11906	310	8,50€
10964	172	9,00€	11166	155	30,90€	11376	178	5,50€	11907	310	11,00€
10965	172	6,00€	11167	155	38,00€	11377	178	5,50€	11938	152	47,00€
10966	172	13,50€	11168	155	41,00€	11378	178	6,50€	11939	261	63,00€
10993	269	117,00€	11169	155	39,20€	11379	178	6,00€	11945	54	7,00€
11093	120	4,00€	11170	155	40,00€	11380	178	6,50€	11946	54	4,50€
11095	280	31,00€	11171	155	51,00€	11381	178	6,50€	11947	54	19,00€
11098	280	57,00€	11172	155	48,00€	11382	178	6,00€	11950	269	18,00€
11100	279	24,30€	11173	155	47,00€	11383	178	6,00€	11956	137	5,50€
11101	279	154,00€	11174	155	47,00€	11384	178	6,00€	11957	137	5,50€
11102	279	6,60€	11175	155	49,00€	11385	178	5,50€	11959	168	10,50€
11103	124	6,00€	11176	155	56,00€	11386	178	6,00€	11960	309,310	1,50€
11106	180	3,00€	11177	155	55,00€	11387	178	6,00€	11962	150,154	7,50€
11107	120	4,50€	11178	155	53,00€	11388	178	6,00€	11963	154	9,00€
11121	150, 155	4,10€	11179	155	65,00€	11389	178	6,00€	11964	154	12,50€
	150, 155	5,45€	11180	155	59,00€	11390	178	6,00€	11965	154	16,00€
11123	150, 155	6,50€	11181	155	65,00€	11391	178	6,50€	11966	154	18,00€
11124	156	7,65€	11182	155	73,00€	11392	178	6,00€	11967	154	18,00€
11125	156	8,50€	11183	155	70,00€	11393	178	6,00€	11971	85	3,10€
11126	155	11,20€	11184	155	87,00€	11394	178	6,00€	11974	278	1,80€
11127	155	13,80€	11185	155	97,00€	11541	161	11,00€	11975	278	1,80€
11128	155	14,10€	11186	155	91,00€	11542	161	11,00€	11976	278	1,80€
11129	155	14,10€	11187	155	98,00€	11543	161	11,00€	11977	278	1,80€
11130	155	13,10€	11188	155	103,00€	11544	161	7,00€	11978	278	1,80€
11131	155	14,10€	11189	155	121,00€	11545	161	11,00€	11979	278	1,80€
11132	155	13,70€	11190	155	138,00€	11546	161	12,00€	11980	278	1,80€
11133	155	12,00€	11191	155	149,00€	11547	161	12,00€	11981	278	1,80€
11134	155	15,00€	11192	155	152,00€	11613	155	11,00€	11982	278	1,80€
11135	155	17,20€	11193	155	183,00€	11614	155	13,00€	11983	278	1,80€
11136	155	15,30€	11194	155	176,00€	11615	155	14,20€	11989	120	2,00€
11137	155	18,20€	11195	150, 155	3,70€	11616	155	18,10€	11990	150,152	15,30€
11138	155	18,00€	11212	46	5,00€	11617	155	18,70€	11992	276	65,00€
11139	155	18,80€	11213	46	10,60€	11618	155	18,80€	11994	79	33,00€
11140	155	20,40€	11214	46	12,50€	11619	155	19,50€	11996	79	48,00€
11141	155	18,60€	11219	276	659,00€	11621	155	359,00€	11997	79	39,00€
11142	155	21,30€	11244	40	8,50€	11622	155	399,00€	11998	79	49,00€
11143	155	26,40€	11245	40	9,15€	11623	155	489,00€	12009	139	11,00€
11144	155	33,30€	11246	40	12,40€	11624	155	189,00€	12022	167,270	33,70€
11145	155	35,30€	11247	40	14,00€	11625	155	282,00€	12029	30,196	5,50€
11146	155	37,30€	11248	40	14,60€	11628	151	9,50€	12030	30,196	6,50€
11147	155	41,00€	11249	40	26,50€	11867	256	9,00€	12031	150, 151, 155	15,00€
11148	155	47,00€	11313	81	54,00€	11878	211	4,10€	12032	267	7,50€
11149	155	45,00€	11314	151	8,50€	11879	211	5,10€	12044	255	147,00€
11150	155	55,00€	11315	151	8,50€	11880	211	10,50€	12046	264	385,00€
11151	155	57,00€	11316	151	8,50€	11890	313	0,55€	12055	294	20,00€

REF.	Pg.	PDV	REF.	Pg.	PDV	REF.	Pg.	PDV	REF.	Pg.	PDV
12056	252	57,00€	12974	175	21,00€	13049	338	2,05€	13108	336	1,90€
12060	47	2,50€	12975	175	23,00€	13050	339	1,55€	13109	336	2,90€
12061	155	9,50€	12977	208	36,50€	13051	339	1,50€	13110	336	1,85€
12062	150, 151, 155	9,50€	12984	155	379,00€	13053	339	2,80€	13111	336	1,20€
12063	150, 151, 155	9,50€	12987	142	1,50€	13054	339	2,35€	13112	336	1,65€
12064	155,150	9,00€	12988	148	12,00€	13055	339	3,00€	13113	336	2,20€
12065	150, 151, 155	9,00€	12995	54	7,00€	13056	339	1,55€	13114	336	2,20€
12066	150, 151, 155	9,00€	12996	54	7,00€	13057	339	1,50€	13115	336	2,50€
12067	155,150	9,50€	12997	54	7,50€	13058	339	2,20€	13116	340	5,45€
12068	150, 151, 155	9,50€	12998	54	9,00€	13059	339	2,35€	13117	340	3,65€
12069	150, 151, 155	9,50€	12999	54	9,50€	13060	339	1,60€	13118	340	15,90€
12070	150, 151, 155	10,50€	13002	336	1,45€	13061	339	2,65€	13119	340	5,60€
12071	150, 151, 155	11,00€	13003	336	1,70€	13062	339	2,35€	13120	340	5,50€
12072	150, 151, 155	12,00€	13004	336	1,85€	13063	339	1,15€	13121	340	8,75€
12074	150,152	11,50€	13005	336	1,25€	13064	339	2,60€	13122	340	1,95€
12075	150,152	15,50€	13006	336	1,40€	13065	339	2,00€	13123	340	5,35€
12200	208	14,50€	13007	336	1,30€	13066	339	2,25€	13124	340	8,20€
12889	270	12,00€	13008	336	2,25€	13067	339	2,55€	13125	340	5,95€
12901	185	5,20€	13009	336	1,65€	13068	338	2,85€	13126	340	1,55€
12902	309	4,50€	13010	336	1,75€	13069	338	4,55€	13127	340	5,60€
12908	309	4,50€	13011	336	1,15€	13070	338	2,15€	13128	337	1,85€
12910	309	4,40€	13012	336	1,80€	13071	338	2,05€	13129	337	2,00€
12915	309	12,40€	13013	336	1,75€	13072	338	2,75€	13130	337	3,75€
12920	309	7,80€	13014	336	1,45€	13073	338	2,10€	13131	337	3,45€
12923	309	9,50€	13015	336	1,20€	13074	339	4,65€	13132	337	2,65€
12924	309	4,10€	13016	336	1,15€	13075	339	5,35€	13133	337	3,45€
12925	309	10,70€	13017	336	2,60€	13076	339	3,90€	13134	337	3,95€
12926	200	21,50€	13018	336	1,45€	13077	339	2,55€	13135	337	3,45€
12927	200	21,50€	13019	336	1,75€	13078	339	2,55€	13136	337	2,60€
12928	200	22,00€	13020	336	1,70€	13079	339	3,35€	13137	337	2,25€
12929	200	23,00€	13021	336	1,30€	13080	338	1,75€	13138	337	2,85€
12930	200	23,50€	13022	336	2,10€	13081	338	2,30€	13139	337	3,85€
12931	153	7,50€	13023	336	1,50€	13082	338	1,35€	13140	337	2,65€
12932	153	7,50€	13024	336	2,45€	13083	338	1,50€	13141	337	1,80€
12933	153	8,00€	13025	336	1,50€	13084	338	2,10€	13142	337	3,10€
12934	153	7,50€	13026	341	1,55€	13085	338	1,60€	13143	337	1,95€
12935	153	8,00€	13027	341	1,85€	13086	338	1,25€	13144	337	2,20€
12936	153	8,50€	13028	341	1,45€	13087	338	3,30€	13145	337	3,85€
12937	150,152	9,50€	13029	341	1,65€	13088	338	2,40€	13146	337	4,50€
12938	153	10,00€	13030	341	2,80€	13089	338	1,70€	13147	337	3,10€
12939	153	10,00€	13031	341	1,85€	13090	338	1,70€	13148	337	3,30€
12940	153	10,00€	13032	341	2,00€	13091	338	1,25€	13149	337	3,10€
12941	153	10,00€	13033	341	1,60€	13092	340	1,65€	13150	337	2,25€
12942	153	10,00€	13034	341	2,65€	13093	340	2,95€	13151	337	5,35€
12943	153	10,00€	13035	341	1,65€	13094	340	1,50€	13152	337	3,05€
12944	153	10,00€	13036	341	1,40€	13095	340	1,20€	13153	337	3,10€
12945	153	10,50€	13037	341	2,10€	13096	340	1,70€	13154	337	3,20€
12950	354	3,45€	13038	338	1,40€	13097	340	1,20€	13155	337	5,60€
12952	354	1,92€	13039	338	1,65€	13098	340	1,65€	13156	337	3,30€
12954	335	0,25€	13040	338	1,80€	13099	340	2,75€	13157	337	3,85€
12955	160	27,80€	13041	338	1,55€	13100	340	1,20€	13158	337	3,75€
12956	160	27,80€	13042	338	1,95€	13101	340	1,50€	13159	337	3,20€
12957	160	27,80€	13043	338	1,20€	13102	340	1,60€	13160	337	5,00€
12958	160	27,80€	13044	338	1,55€	13103	340	1,80€	13161	337	3,55€
12959	160	27,80€	13045	338	1,20€	13104	336	1,90€	13162	337	2,60€
12960	160	27,80€	13046	338	1,55€	13105	336	2,50€	13163	337	2,80€
12961	160	27,80€	13047	338	1,45€	13106	336	2,00€	13217	354	1,31€
12973	310	1,00€	13048	338	2,20€	13107	336	2,15€	13226	49	4,50€

REF.	Pg.	PDV	REF.	Pg.	PDV	REF.	Pg.	PDV	REF.	Pg.	PDV
13227	49	4,50€	13497	35	7,50€	13817	138	17,00€	13961	330	9,25€
13228	49	4,50€	13498	35	8,50€	13818	138	20,50€	13962	330	1,76€
13229	49	4,50€	13499	139	12,50€	13822	329	11,00€	13963	330	12,40€
13230	49	4,50€	13500	139	12,90€	13823	329	6,00€	13964	330	15,00€
13231	49	4,50€	13667	49,79	17,60€	13824	329	8,00€	13965	330	1,50€
13232	49	4,50€	13668	79	18,70€	13825	329	11,50€	13966	330	12,90€
13234	255	224,50€	13669	57	18,00€	13826	329	13,00€	13967	330	4,65€
13235	327	0,15€	13672	267	220,00€	13827	329	15,00€	13968	349	1,35€
13236	327	0,15€	13674	50,327	0,50€	13828	329	11,50€	13969	181	19,00€
13237	327	0,15€	13675	50,327	0,50€	13829	329	10,50€	13982	252	4,00€
13238	327	0,20€	13676	50,327	0,50€	13830	329	10,50€	14004	153	9,50€
13239	327	0,20€	13677	50,327	0,50€	13831	329	12,60€	14005	153	10,50€
13240	327	0,40€	13678	50,327	0,50€	13832	329	13,00€	14006	153	9,50€
13241	327	0,55€	13680	152	15,50€	13833	329	9,00€	14007	153	9,50€
13243	349	12,50€	13681	152	15,50€	13836	260	9,00€	14008	153	9,50€
13244	349	12,50€	13682	152	15,50€	13839	120	8,50€	14009	153	9,50€
13245	349	12,50€	13683	152	15,50€	13842	160	8,50€	14010	153	11,00€
13447	36	16,50€	13684	152	15,50€	13843	160	7,00€	14011	153	11,00€
13448	36	17,50€	13685	152	15,50€	13844	160	9,00€	14013	138	3,50€
13449	36	20,00€	13686	152	15,50€	13845	160	8,00€	14014	253	6,00€
13450	36	23,00€	13687	152	15,50€	13853	260	122,00€	14015	253	6,00€
13451	36	28,00€	13688	152	15,50€	13856	180	7,80€	14016	253	6,00€
13452	36	29,50€	13689	152	15,50€	13859	154	16,00€	14026	54	5,50€
13453	34	9,00€	13704	204	21,00€	13870	265	82,00€	14027	54	5,60€
13454	34	9,50€	13707	61	14,00€	13874	154	17,50€	14028	54	7,00€
13455	34	10,50€	13708	61	14,00€	13875	154	18,50€	14029	54	8,50€
13456	34	11,50€	13709	61	14,00€	13876	154	18,50€	14030	54	9,50€
13457	34	12,00€	13710	61	14,00€	13877	154	18,50€	14031	115,120	7,90€
13460	34	15,00€	13712	61	14,00€	13879	314	1,38€	14032	120	12,00€
13462	34	17,00€	13717	354	7,65€	13880	314	1,50€	14033	120	4,50€
13463	35	5,30€	13723	155	18,50€	13923	79	7,45€	14034	353	9,00€
13464	35	5,30€	13724	155	19,20€	13929	346	3,45€	14049	63	8,00€
13465	35	5,55€	13725	155	19,20€	13930	148	1,50€	14050	63	10,50€
13466	35	5,55€	13726	155	19,00€	13931	148	2,50€	14051	63	18,00€
13467	35	6,00€	13727	155	18,70€	13932	148	2,50€	14052	63	19,50€
13468	35	6,25€	13728	155	18,50€	13933	148	2,00€	14059	73	62,00€
13469	35	6,25€	13729	155	22,00€	13934	148	2,50€	14060	73	65,00€
13470	35	6,60€	13730	155	22,00€	13935	148	2,50€	14061	73	93,00€
13471	35	6,90€	13731	155	21,60€	13936	148	3,50€	14062	73	100,00€
13472	35	7,25€	13732	155	23,80€	13937	148	4,00€	14063	73	119,00€
13473	35	8,10€	13733	155	24,90€	13938	148	3,50€	14064	73	39,50€
13474	35	8,70€	13734	155	25,70€	13939	148	4,00€	14068	260	13,00€
13475	35	9,10€	13735	155	25,80€	13945	330	7,40€	14069	260	13,00€
13476	35	9,60€	13736	155	25,90€	13946	330	6,70€	14070	260	116,00€
13477	35	9,85€	13738	314	3,50€	13947	330	5,85€	14071	260	21,50€
13478	35	12,20€	13739	314	5,50€	13948	330	5,00€	14072	260	21,50€
13479	35	13,10€	13740	314	5,50€	13949	330	6,50€	14073	260	128,00€
13480	35	15,50€	13741	313	21,00€	13950	330	7,80€	14075	148	2,00€
13481	35	15,80€	13745	155	25,20€	13951	330	5,15€	14076	148	1,50€
13482	35	22,10€	13746	155	25,40€	13952	330	10,90€	14077	148	4,50€
13483	35	25,50€	13747	155	25,40€	13953	330	8,00€	14078	148	4,00€
13484	35	27,20€	13748	155	24,90€	13954	330	12,70€	14081	276	12,60€
13491	35	5,30€	13805	310	10,50€	13955	330	4,95€	14083	354	13,20€
13492	35	5,35€	13806	310	10,50€	13956	330	4,30€	14090	267	103,00€
13493	35	5,50€	13809	148	18,50€	13957	330	9,70€	14103	164	32,40€
13494	35	6,00€	13810	148	20,50€	13958	330	5,45€	14104	164	32,40€
13495	35	6,40€	13813	163	7,00€	13959	330	10,10€	14105	164	32,40€
13496	35	6,60€	13814	163	11,00€	13960	330	9,65€	14106	164	32,40€



REF.	Pg.	PDV	REF.	Pg.	PDV	REF.	Pg.	PDV	REF.	Pg.	PDV
14107	164	32,40€	14192	148	4,00€	14365	344	1,90€	14432	342	1,45€
14108	164	32,40€	14193	148	4,00€	14366	344	1,45€	14434	342	1,60€
14109	276	29,00€	14195	147	4,00€	14367	344	1,30€	14435	342	1,45€
14110	276	110,00€	14196	147	4,00€	14368	344	1,45€	14436	342	1,70€
14114	79	19,30€	14197	147	4,50€	14369	344	4,95€	14437	342	1,45€
14118	302	26,00€	14198	147	4,00€	14370	344	3,00€	14438	342	1,35€
14120	132	22,00€	14199	147	4,00€	14371	344	3,00€	14439	342	1,75€
14121	132	26,00€	14200	147	4,50€	14372	344	1,20€	14440	342	1,75€
14122	133	34,00€	14201	147	4,00€	14373	344	1,35€	14441	342	1,65€
14123	133	33,00€	14202	147	4,00€	14374	344	1,70€	14442	342	1,45€
14124	135	20,50€	14203	147	4,50€	14375	344	1,85€	14443	342	1,45€
14125	135	19,50€	14204	147	1,50€	14376	344	2,60€	14444	342	1,90€
14126	136	54,00€	14205	147	1,50€	14377	344	1,90€	14445	342	1,45€
14127	135	32,50€	14206	147	1,50€	14378	344	1,90€	14446	342	2,80€
14128	136	13,50€	14207	147	1,50€	14379	344	1,45€	14447	341,342	1,45€
14129	135	12,50€	14208	147	1,50€	14380	352	51,00€	14448	342	2,05€
14130	134	21,00€	14209	147	1,50€	14381	344	1,70€	14449	341,342	2,20€
14131	134	24,00€	14211	192	11,00€	14382	344	1,85€	14450	342	2,15€
14132	135	21,50€	14212	192	12,00€	14383	344	1,35€	14451	342	2,15€
14133	136	16,50€	14213	192	12,00€	14384	344	2,10€	14452	342	2,55€
14134	136	17,50€	14214	192	14,00€	14387	343	1,45€	14453	342	3,05€
14135	137	12,50€	14286	139,161	2,99€	14388	343	2,05€	14455	342	2,10€
14136	138	12,00€	14287	139,161	2,99€	14389	343	1,25€	14456	342	1,35€
14137	138	131,00€	14288	139,161	6,00€	14390	343	1,35€	14457	342	1,70€
14141	73	105,00€	14289	139,161	6,10€	14391	343	2,15€	14458	341	1,70€
14142	73,175	109,00€	14291	269	87,00€	14392	343	1,35€	14459	341	1,45€
14143	73	124,00€	14296	66,67,68, 69,73,74,76	118,00€	14393	343	1,50€	14460	341	1,15€
14144	73	304,00€	14297	66,67,68, 69,74,76	87,00€	14395	343	1,65€	14461	341	1,35€
14145	272	8,50€	14298	66,67,68, 69,74,76	51,50€	14396	343	1,20€	14462	341	1,65€
14146	272	8,00€	14299	66,67,68, 69,74,76	87,00€	14397	343	1,45€	14463	341	1,65€
14147	272	25,00€	14300	207	19,00€	14398	343	1,30€	14464	341	1,50€
14148	272	25,00€	14301	207	19,00€	14399	343	1,90€	14465	341	2,00€
14153	134	20,50€	14314	147	5,00€	14402	343	1,50€	14466	341	1,65€
14154	139	42,00€	14315	147	4,50€	14404	343	2,10€	14468	341	1,30€
14157	138,210	8,30€	14330	139	3,50€	14405	343	1,45€	14469	341	1,45€
14158	138,210	9,95€	14336	134	58,00€	14406	343	1,55€	14471	341	1,90€
14159	138,210	12,60€	14340	191	10,50€	14408	343	1,45€	14472	341	1,35€
14160	138,210	12,80€	14341	191	10,50€	14409	343	1,35€	14473	251	46,00€
14161	138,210	13,70€	14342	191	10,50€	14410	343	1,85€	14474	341	1,50€
14162	139	25,50€	14343	191	10,50€	14411	343	1,70€	14475	341	1,65€
14163	139	25,50€	14344	191	11,00€	14412	343	1,70€	14476	341	2,05€
14164	139	25,50€	14345	191	11,00€	14413	343	3,25€	14477	341	2,45€
14165	132	26,50€	14346	191	11,00€	14414	343	1,70€	14478	341	4,05€
14167	62	2,50€	14347	348	36,50€	14415	343	1,70€	14479	341	1,65€
14168	145	7,00€	14348	186	12,50€	14416	343,344	1,25€	14480	341	2,05€
14169	147	3,00€	14349	186	20,50€	14419	343	1,95€	14481	341	1,70€
14172	151	8,50€	14350	343,344	1,80€	14420	343	1,50€	14507	354	50,00€
14173	151	9,50€	14351	344	1,65€	14421	343	2,45€	14534	144	16,50€
14177	151	9,50€	14352	344	1,30€	14422	342	1,50€	14560	144	8,80€
14178	151	9,50€	14353	344	2,10€	14423	342	3,55€	14561	144	8,80€
14179	60	8,50€	14354	80	14,00€	14424	342	1,85€	14563	209	18,00€
14180	60	7,90€	14355	344	1,70€	14425	342	2,05€	14564	161	9,20€
14183	44	31,00€	14356	344	1,90€	14426	342	1,90€	14565	161	26,70€
14187	208	6,00€	14357	344	1,90€	14427	342	1,20€	14566	161	16,70€
14188	141	0,50€	14358	343,344	1,70€	14428	342	1,40€	14567	161	38,00€
14189	354	52,00€	14359	341,344	1,05€	14429	342	1,80€	14568	161	9,20€
14190	148	2,00€	14364	344	1,90€	14430	342	2,25€	14569	161	9,20€
14191	148	2,00€				14431	342	1,45€	14570	161	4,05€

REF.	Pg.	PDV	REF.	Pg.	PDV	REF.	Pg.	PDV	REF.	Pg.	PDV
14571	161	9,20€	14660	94	83,00€	14733	150,155	4,30€	14838	93,109	3,40€
14573	161	4,05€	14661	94	9,00€	14734	150,155	5,40€	14839	93,109	4,70€
14578	80	12,50€	14662	94	2,50€	14735	150	6,50€	14840	93,109	3,35€
14580	80	41,00€	14663	94	2,50€	14736	151,155	5,00€	14841	93,109	2,58€
14583	132	6,00€	14664	95	100,00€	14737	151,155	5,00€	14842	93,109	9,50€
14589	267	2,50€	14665	95	8,80€	14738	155	5,50€	14843	110	0,50€
14594	207,331	2,00€	14666	95	97,00€	14739	155	5,50€	14844	110	0,50€
14595	207,331	1,50€	14667	95	8,80€	14740	155	5,55€	14845	110	0,50€
14596	207,331	2,00€	14668	95	7,70€	14741	155	5,55€	14846	110	0,50€
14597	207,331	7,60€	14670	95	4,50€	14742	155	5,55€	14847	110	0,50€
14598	207,331	17,80€	14671	96	44,00€	14743	155	5,15€	14848	110	0,50€
14599	207,331	4,50€	14672	96	5,00€	14744	155	5,35€	14849	110	1,00€
14600	207,331	9,50€	14674	96	73,00€	14745	155	6,25€	14850	110	1,00€
14601	207,331	11,00€	14675	88,90	17,00€	14746	155	6,40€	14851	110	1,00€
14602	207,331	11,00€	14676	88,90	36,50€	14747	155	7,10€	14852	110	1,00€
14611	197	12,00€	14677	88,90	9,00€	14748	155	8,30€	14853	110	1,00€
14612	197	11,00€	14678	88,90	86,00€	14749	28,154	2,00€	14854	110	1,00€
14613	197	13,50€	14679	88,90	9,50€	14750	28,154	2,00€	14855	110	1,00€
14615	261	9,50€	14680	95	17,00€	14751	28,154	4,00€	14856	110	1,00€
14616	266	96,00€	14681	95	108,00€	14752	28,154	4,00€	14857	110	1,50€
14618	133	19,00€	14682	95	9,00€	14753	129	13,00€	14858	110	1,50€
14622	107,353	17,00€	14683	95	86,00€	14755	272	134,00€	14859	110	1,50€
14623	107,353	8,00€	14684	94	3,00€	14756	272	15,20€	14860	110	2,00€
14624	107,353	17,00€	14685	94	5,00€	14757	272	15,20€	14861	110	2,00€
14625	107,353	14,00€	14686	94	73,00€	14758	272	18,00€	14862	110	2,00€
14626	107,353	7,00€	14687	94	35,00€	14759	272	18,00€	14863	110	2,50€
14628	101	2,50€	14691	97	167,00€	14765	91	97,00€	14864	110	2,50€
14629	101	4,00€	14692	97	5,50€	14766	92	3,15€	14865	110	2,50€
14630	101	22,00€	14693	93	3,50€	14767	92	2,34€	14866	110	3,00€
14631	101	3,50€	14694	93	11,50€	14768	95	28,80€	14867	110	3,00€
14632	101	3,50€	14695	93	4,00€	14769	88,90	37,75€	14868	110	0,55€
14633	132	22,50€	14696	93	18,00€	14770	95	40,00€	14869	110	0,60€
14634	101	36,50€	14697	93	8,00€	14771	146,283	10,50€	14870	110	1,00€
14635	101	10,00€	14698	93	1,00€	14772	146	8,50€	14871	110	1,00€
14636	102	30,00€	14699	93	30,00€	14774	283	10,50€	14872	110	1,00€
14637	91	15,50€	14700	93	2,50€	14775	322	30,50€	14873	110	1,00€
14638	91	7,00€	14701	93	2,50€	14779	135	33,00€	14874	110	1,00€
14639	266	195,00€	14702	93	92,00€	14781	319	9,90€	14875	110	1,50€
14640	91	8,00€	14703	251	13,00€	14783	80	5,50€	14876	110	1,50€
14641	91	18,50€	14706	269	8,90€	14785	270	3,50€	14877	110	1,50€
14642	91	83,00€	14708	261	59,00€	14793	319	12,00€	14878	110	2,00€
14643	92	24,50€	14709	260	122,00€	14802	322	44,00€	14879	110	2,00€
14644	92	8,00€	14710	161	3,50€	14803	322	43,00€	14880	110	2,50€
14645	92	45,00€	14711	161	3,75€	14807	354	11,00€	14881	110	2,50€
14646	92	110,00€	14712	161	4,00€	14808	92	3,05€	14882	110	3,00€
14647	96	3,00€	14713	161	4,25€	14825	109	1,50€	14883	110	3,50€
14648	88,90	106,00€	14714	161	4,50€	14826	109	1,50€	14884	110	3,65€
14649	96	50,00€	14715	161	4,75€	14827	109	2,00€	14885	110	4,00€
14650	96	5,00€	14723	154	18,00€	14828	109	1,50€	14886	110	4,60€
14651	96	86,00€	14724	154	18,50€	14829	109	1,50€	14887	110	5,00€
14652	92	47,00€	14725	154	18,50€	14830	109	1,50€	14888	110	6,00€
14653	92	5,25€	14726	154	17,50€	14831	109	1,50€	14889	110	6,50€
14654	92	104,00€	14727	269	108,00€	14832	109	2,00€	14890	110	7,00€
14655	92	5,95€	14728	150,155	3,80€	14833	109	2,05€	14891	110	7,50€
14656	92	4,50€	14729	150,155	3,80€	14834	109	2,50€	14892	110	8,00€
14657	92	4,50€	14730	150,155	3,80€	14835	109	3,00€	14893	92,112	2,00€
14658	94	45,00€	14731	150,155	3,80€	14836	109	3,50€	14894	112	1,20€
14659	94	5,00€	14732	150,155	3,80€	14837	93,109	3,30€	14895	112	1,90€

REF.	Pg.	PDV	REF.	Pg.	PDV	REF.	Pg.	PDV	REF.	Pg.	PDV
14896	112	2,10€	14962	96	6,50€	15051	354	1,92€	15144	82	30,00€
14897	112	0,88€	14963	96	7,50€	15052	208	3,00€	15145	82	20,45€
14898	112	0,98€	14964	94	8,00€	15053	208	10,50€	15146	82	16,20€
14899	112	0,88€	14965	94	8,50€	15054	208	34,00€	15147	53	5,00€
14900	92,112	0,98€	14966	97	7,50€	15056	354	11,70€	15148	53	5,00€
14901	111	3,60€	14967	93	5,50€	15058	80	7,50€	15149	53	5,00€
14902	111	4,65€	14968	93	6,00€	15059	319	10,00€	15151	101	10,50€
14903	111	5,25€	14970	150	2,50€	15062	319	1,00€	15152	348	160,00€
14904	111	6,85€	14971	150	2,50€	15065	80	6,50€	15153	292	2,50€
14905	111	8,50€	14972	150	3,50€	15068	80	15,20€	15154	292	7,50€
14906	111	10,20€	14973	150	11,50€	15069	80	32,80€	15155	67,77	59,00€
14907	109	0,50€	14974	354	2,28€	15070	75	0,50€	15156	39,77	70,00€
14908	109	0,60€	14975	351	64,00€	15071	74	0,60€	15157	77	42,00€
14909	109	0,80€	14976	354	18,84€	15072	74	0,70€	15158	77	59,00€
14910	109	1,00€	14978	54	7,50€	15073	74	1,00€	15159	77	44,00€
14911	109	1,30€	14979	54	9,00€	15074	74	1,00€	15160	77	42,00€
14912	109	1,55€	14980	54	13,00€	15075	74	1,20€	15161	67,77	62,00€
14913	109	1,90€	14981	54	22,50€	15076	74	3,50€	15162	32,78,289	30,20€
14914	109	2,10€	14982	54	27,50€	15083	75	8,50€	15206	39	15,00€
14915	109	2,65€	14985	96,112	6,00€	15084	75,181	68,00€	15207	39	16,50€
14916	109	2,95€	14986	96,112	4,00€	15085	270	156,00€	15208	39	17,00€
14917	109	3,45€	14987	97,112	8,50€	15093	262	38,00€	15209	39	18,00€
14918	301,320	0,23€	14988	96,112	8,00€	15094	262	39,50€	15227	32	3,50€
14919	301,320	0,45€	14989	96,112	6,00€	15095	262	13,00€	15228	32	4,00€
14920	109	2,50€	14990	97,112	10,50€	15096	262	40,00€	15229	32	5,00€
14922	354	0,84€	14991	95,112	2,00€	15098	104	11,50€	15230	32	5,00€
14923	354	0,84€	14992	178	8,50€	15099	104	5,50€	15231	32	3,50€
14924	354	0,84€	14993	95,112	5,00€	15100	104	70,00€	15232	32	4,00€
14925	354	0,84€	14994	95,112	3,50€	15101	104	11,00€	15233	32	5,00€
14926	354	1,05€	14995	95,112	8,00€	15102	104	40,00€	15234	32	3,00€
14929	264	35,00€	14996	352	65,00€	15103	104	20,50€	15237	277	12,00€
14930	182	9,50€	15001	344	3,00€	15104	104	31,50€	15238	277	5,00€
14931	182	8,00€	15010	214	16,50€	15105	104	30,00€	15239	277	5,50€
14932	182	9,50€	15011	214	18,00€	15106	104	15,00€	15240	277	9,50€
14933	182	9,50€	15012	214	31,50€	15107	105	4,00€	15241	277	65,00€
14934	111	4,25€	15014	92,112	20,00€	15108	105	2,16€	15242	277	2,50€
14935	111	8,45€	15018	75,253	46,00€	15109	105	25,50€	15243	277	4,00€
14936	94	27,50€	15023	80	12,50€	15110	105	6,55€	15244	277	2,00€
14937	253	9,50€	15024	80	15,00€	15111	105	30,40€	15245	277	7,50€
14938	270	42,00€	15025	80	12,50€	15112	105	3,25€	15246	277	108,00€
14939	270	57,00€	15026	80	15,00€	15113	105	11,80€	15247	277	2,50€
14940	270	248,00€	15030	80	8,00€	15114	104	6,00€	15248	277	2,50€
14945	352	303,50€	15033	80	6,00€	15115	104	8,50€	15249	277	5,00€
14946	352	58,00€	15034	80	57,00€	15116	104	29,50€	15250	277	4,50€
14947	352	201,50€	15035	80	8,50€	15117	104	29,50€	15251	277	15,00€
14948	352	251,50€	15036	80	8,50€	15118	104	52,00€	15253	196,202	62,00€
14950	101	6,50€	15037	80	8,00€	15119	104	10,00€	15254	91	12,50€
14951	101	9,50€	15038	80	34,50€	15120	104	6,50€	15255	265	114,00€
14952	101	19,00€	15040	80	12,50€	15121	104	12,00€	15256	348	36,00€
14953	101	8,50€	15041	80	15,00€	15122	35,67,77	74,00€	15257	348	27,50€
14954	92	14,50€	15042	80	7,50€	15123	251	32,00€	15258	348	27,50€
14955	96	7,50€	15043	266	195,00€	15124	102	9,50€	15259	348	18,00€
14956	92	4,40€	15044	266	259,00€	15125	102	23,00€	15260	348	22,50€
14957	92	4,10€	15046	266	47,00€	15126	99	19,50€	15276	98	46,00€
14958	94	22,00€	15047	266	47,00€	15127	99	29,00€	15277	98	9,00€
14959	94	10,00€	15048	266	5,00€	15138	51	10,50€	15278	98	3,50€
14960	95	3,85€	15049	102	37,40€	15139	51	12,00€	15279	98	69,00€
14961	95	3,95€	15050	80	9,50€	15140	51	13,50€	15280	98	91,00€

REF.	Pg.	PDV	REF.	Pg.	PDV	REF.	Pg.	PDV	REF.	Pg.	PDV
15282	253	15,00€	15398	282	75,00€	15500	178	10,00€	15732	70,76	293,50€
15283	253	27,50€	15399	282	117,00€	15501	178	10,00€	15733	70,76	113,00€
15300	309	5,00€	15424	106,281	105,00€	15502	178	10,00€	15734	70,76	288,50€
15305	253	19,50€	15425	106,281	50,00€	15503	178	11,00€	15735	76	152,00€
15306	253	27,50€	15426	106,281	10,00€	15504	178	10,00€	15736	76	488,50€
15307	253	39,60€	15427	106,281	9,00€	15505	178	4,00€	15737	48,78	45,00€
15308	253	7,00€	15428	106,281	238,00€	15506	178	4,00€	15765	101	14,00€
15309	253	17,00€	15429	106,281	23,50€	15507	178	4,50€	15781	272	19,84€
15310	253	11,50€	15430	106,281	83,00€	15508	178	4,50€	15782	272	16,00€
15311	253	11,50€	15431	106,281	241,00€	15509	178	5,00€	15789	350	2.545,00€
15312	253	11,50€	15432	106,281	18,50€	15510	178	5,00€	15799	46,79	28,30€
15313	80	14,00€	15433	106,281	197,00€	15511	178	8,00€	15866	293	32,00€
15315	78	28,20€	15434	106,281	147,00€	15514	67,78	9,35€	15874	249	6,50€
15316	36,77	58,00€	15435	106,281	24,50€	15515	36	15,50€	15905	296	16,50€
15317	309	4,50€	15436	106,281	97,00€	15516	36	19,00€	15906	296	28,50€
15318	253	17,00€	15437	106,281	305,50€	15517	36	22,50€	15907	296	12,00€
15320	98	1,00€	15438	106,281	31,00€	15526	264	48,00€	15908	296	14,50€
15321	98	3,00€	15439	106,281	52,00€	15527	264	276,00€	15909	296	21,50€
15322	98	3,50€	15440	99	33,00€	15528	264	39,00€	15910	296	16,50€
15323	98	24,00€	15454	58,77	35,40€	15530	93	7,50€	15911	296	30,50€
15324	98	18,00€	15460	287	5,00€	15531	93	5,00€	15912	296	35,50€
15325	98	3,50€	15462	105	7,50€	15532	93	98,00€	15913	296	7,50€
15326	98	1,00€	15463	105	114,00€	15533	93	4,50€	15914	296	7,50€
15327	98	5,50€	15464	105	6,50€	15534	93	4,50€	15980	250	55,00€
15328	35	6,00€	15465	105	11,50€	15535	93	3,50€	15981	250	181,00€
15329	35	5,50€	15466	105	6,50€	15536	93	14,50€	15982	250	73,00€
15330	35	5,50€	15467	105	14,00€	15537	93	6,00€	15983	250	11,50€
15331	35	5,50€	15468	105	2,50€	15538	93	17,00€	15984	250	48,00€
15332	35	6,00€	15469	105	9,50€	15539	255	104,00€	16020	37	17,00€
15333	35	6,50€	15470	105	7,50€	15541	77	27,60€	16021	37	19,50€
15334	35	7,00€	15471	105	20,10€	15542	255	45,00€	16022	37	23,00€
15335	35	7,50€	15472	105	19,00€	15550	253	6,00€	16023	37	26,50€
15336	35	8,00€	15473	105	13,70€	15551	253	6,00€	16024	37	34,50€
15337	35	8,50€	15474	105	8,50€	15552	172	181,00€	16025	37	37,50€
15338	35	9,00€	15475	105	8,50€	15553	250	108,00€	16052	120,123	2,09€
15339	35	9,50€	15476	105	11,00€	15564	133	11,90€	16053	120,123	2,85€
15340	349	5,50€	15477	105	5,70€	15631	251	98,00€	16111	79	19,20€
15341	349	5,50€	15478	105	3,60€	15632	34	9,35€	16130	287	290,00€
15342	349	9,00€	15480	255	0,99€	15633	34	9,50€	16138	106	7,45€
15343	349	9,50€	15481	103	4,50€	15634	34	10,60	16139	106	14,20€
15344	349	6,50€	15482	103	4,00€	15635	34	11,00€	16140	106	14,20€
15345	349	10,50€	15483	103	4,00€	15636	34	12,30€	16141	106	4,45€
15346	349	24,00€	15484	103	5,50€	15637	34	12,50€	16142	106	10,80€
15349	349	8,50€	15485	103	4,00€	15681	55,78	134,00€	16143	106	2,06€
15375	161	28,00€	15486	103	9,00€	15671	297	20,50€	16144	106	12,80€
15380	99	169,00€	15487	103	59,00€	15706	55,78	31,00€	16145	106	79,00€
15381	99	5,50€	15488	103	4,00€	15708	58	10,00€	16146	106	4,45€
15382	99	42,00€	15489	103	10,50€	15710	58	10,00€	16147	106	13,00€
15385	122	18,00€	15490	103	4,00€	15719	100	11,00€	16148	106	35,40€
15388	282	33,00€	15491	103	4,00€	15720	100	59,00€	16149	106	38,60€
15389	282	18,50€	15492	103	5,00€	15721	100	46,00€	16150	100	7,90€
15390	282	43,00€	15493	103	4,50€	15722	100	4,25€	16151	89	50,00€
15391	282	13,50€	15494	178	12,50€	15723	100	2,21€	16152	89	25,10€
15392	282	17,50€	15495	178	12,50€	15724	100	2,82€	16153	89	81,00€
15393	282	12,50€	15496	178	11,50€	15725	100	1,86€	16154	89	34,10€
15394	282	26,00€	15497	178	11,00€	15726	100	2,82€	16155	89	34,10€
15395	282	3,50€	15498	178	11,50€	15730	70,76	289,00€	16156	89	12,60€
15396	300	2,04€	15499	178	11,00€	15731	70,76	214,00€	16157	89	59,00€

REF.	Pg.	PDV	REF.	Pg.	PDV	REF.	Pg.	PDV	REF.	Pg.	PDV
16158	128	9,00€	50765	308	0,58€	50935	252	595,00€	51259	193	58,00€
16160	106	3,99€	50766	308	0,68€	50937	204	10,50€	51260	25	37,00€
16161	80	17,50€	50767	308	0,78€	50942	274,288	28,00€	51261	25	36,00€
16162	80	35,10€	50768	308	0,88€	50957	295	22,00€	51262	203	51,00€
16163	80	10,20€	50771	308	0,29€	50959	295,328	12,00€	51262R	203	14,00€
16165	280	2,00€	50774	308	0,57€	50960	295	18,30€	51266	301	28,00€
16166	280	23,50€	50776	308	0,76€	50966	300,317	4,00€	51272	55	7,50€
16167	280	7,00€	50778	308	0,10€	50980	30	22,00€	51277	144	64,00€
16168	280	5,00€	50779	308	0,19€	50982	30	22,00€	51283	174	78,00€
16169	280	1,50€	50780	308	0,29€	50983	27	48,00€	51305	52	28,90€
16170	280	1,50€	50781	308	0,38€	50985	27	59,00€	51306	52	28,10€
16171	280	20,50€	50782	308	0,49€	51017	58	6,80€	51307	52	29,70€
16172	280	22,50€	50783	314	0,58€	51018	58	7,05€	51315	353	2,50€
16173	280	3,00€	50784	308	0,68€	51020	58	6,65€	51318	34	98,00€
16188	80	39,60€	50785	308	0,78€	51021	58	7,05€	51326	119	4,40€
16198	287	5,00€	50786	308	0,88€	51028	154	163,00€	51332	178	98,00€
54294	317	8,80€	50787	214	8,00€	51033	283	98,00€	51333	28	18,00€
50400	169	168,00€	50788	214	14,50€	51035	82	799,00€	51336	151	29,30€
50403	169	98,00€	50789	214	29,00€	51050	295	285,00€	51337	182	50,00€
50409	170	26,00€	50790	214	29,00€	51051	295	34,80€	51338	203	53,00€
50410	169	168,00€	50792	188	105,00€	51055	308	0,98€	51338R	203	14,00€
50431	129	3,80€	50793	188	94,00€	51056	308	0,75€	51340	245	39,30€
50517	293	129,00€	50797	256,292	490,00€	51059	175	99,00€	51341	142,214	35,00€
50518	293	169,00€	50807	207,332	38,00€	51119	187	62,00€	51347	212	9,90€
50523	129	4,70€	50808	85	77,00€	51120	210	41,00€	51349	200	37,30€
50524	129	4,70€	50815	261	88,00€	51121	211	27,30€	51352	179	9,80€
50525	300	1,00€	50816	261	88,00€	51123	196	91,00€	51353	179	11,50€
50526	300	4,80€	50818	261	198,00€	51124	197	88,00€	51354	180	13,20€
50551	130	350,00€	50819	262	28,00€	51125	196	88,00€	51355	62,310	19,00€
50560	37	38,60€	50820	262	34,50€	51126	198	18,00€	51356	258	48,00€
50561	38	19,20€	50821	262	47,00€	51127	203	56,00€	51358	312	7,50€
50562	39	23,50€	50822	262	59,00€	51127R	203	14,00€	51359	312	9,00€
50564	38	30,00€	50823	262	94,00€	51131	161	61,00€	51360	162	8,05€
50567	58	9,60€	50824	262	88,00€	51140	201,237	64,00€	51361	162	9,80€
50577	164	12,60€	50825	262	154,00€	51206	132	228,00€	51362	312	3,00€
50585	306	14,70€	50827	211,267	387,00€	51207	132	289,00€	51363	272	114,00€
50600	308	0,60€	50830	264	560,00€	51210	133	650,00€	51364	201	26,00€
50601	308	0,29€	50831	267	460,00€	51211	133	560,00€	51365	272	118,00€
50622	36	64,00€	50835	265	290,00€	51212	133	488,00€	51368	194	19,00€
50623	24	60,00€	50836	268	148,00€	51213	133	690,00€	51369	194	28,00€
50630	269	590,00€	50838	268	299,00€	51214	135	148,00€	51383	144	11,10€
50631	267	68,00€	50839	270	180,00€	51215	135	119,00€	51384	25	34,00€
50632	279	298,00€	50840	268	138,00€	51216	136	650,00€	51385	142	4,55€
50644	301	11,60€	50843	85	79,00€	51218	135	288,00€	51386	142	5,95€
50651	332	16,50€	50844	85	65,00€	51219	136	222,00€	51387	142	3,25€
50652	332	16,50€	50852	257	24,50€	51220	135	240,00€	51388	136	22,00€
50654	300,317	4,00€	50901	162	16,00€	51221	134	199,00€	51389	136	22,00€
50656	172	290,00€	50902	42	13,00€	51222	134	128,00€	51390	136	22,00€
50717	301	21,90€	50903	162	30,80€	51225	135	198,00€	51391	136	22,00€
50724	204	28,00€	50910	128	45,00€	51226	136	233,00€	51392	136	34,00€
50731	254	68,00€	50911	269	788,00€	51227	136	193,00€	51393	136	34,00€
50751	143,257	43,00€	50913	172	195,00€	51235	273	49,00€	51398N	316	1,74€
50754	36	98,00€	50915	129	4,20€	51238	272	138,00€	51400	182	17,00€
50760	308	0,10€	50916	170	0,88€	51239	272	159,00€	51401	182	22,00€
50761	308	0,19€	50917	252	271,00€	51245	137	99,00€	51402	182	20,50€
50762	308	0,29€	50918	252	341,00€	51246	303,318	6,40€	51403	182	17,50€
50763	308	0,38€	50923	167,270	454,00€	51253	252	41,00€	51405	52	21,10€
50764	308	0,49€	50924	249	342,00€	51258	119	0,15€	51406	52	29,20€

REF.	Pg.	PDV	REF.	Pg.	PDV	REF.	Pg.	PDV	REF.	Pg.	PDV
51409	25	36,00€	51656	81	3,65€	51816	273	49,00€	51967	125	16,00€
51410	25	36,00€	51657	81	5,85€	51817	300,317	4,50€	51968	125	16,00€
51412	303	2,10€	51658	81	4,50€	51818	19	95,00€	51969	124	14,00€
51414	194	14,00€	51659	36	59,00€	51819	16	48,00€	51972	57	12,00€
51416	311	12,00€	51661	53,311	12,00€	51824	170	36,80€	51973	305	45,00€
51419	81	2,79€	51674	46	7,75€	51830	204	94,00€	51975	81	2,27€
51422	81	2,97€	51680	298	2,40€	51831	276	24,00€	51976	81	1,63€
51439	136	26,00€	51681	298	4,50€	51832	162	18,00€	51978	169	84,00€
51440	136	28,00€	51691	298	2,40€	51837	280	195,00€	51980	143	15,00€
51441	136	26,00€	51692	298	3,25€	51838	280	667,00€	51981	143	21,50€
51442	136	28,00€	51693	298	3,55€	51839	176,275	24,00€	51982	293	120,00€
51443	142	5,50€	51694	298	3,55€	51842	273	6,90€	51983	293	180,00€
51444	142	5,05€	51696	298	3,55€	51843	330	0,19€	51984	293	190,00€
51445	142	5,05€	51697	300	0,80€	51853	47	18,00€	51985	170	84,00€
51447	54,80	16,00€	51703	314	10,50€	51855	23	378,00€	51986	215	11,90€
51448	54,80	52,00€	51705	314	8,45€	51858	305	15,00€	51989	216	49,00€
51452	268	69,00€	51706	313	22,80€	51859	276	3,80€	51991	195	48,00€
51456	81	550,00€	51707	313	9,05€	51861	136,314	199,00€	51995	60,61	24,50€
51479	55	31,80€	51708	313	14,20€	51863	305	54,00€	51998	190	38,00€
51488	245	16,00€	51709	313	14,70€	51864	40,78	64,00€	52009	32,289	36,00€
51489	245	12,00€	51710	313	17,80€	51886	128	44,00€	52010	198	80,00€
51490	196	36,00€	51711	313	21,20€	51889	115	49,00€	52012	205	68,00€
51491	186	154,00€	51712	313	8,65€	51890	41	92,00€	52016	187	2,10€
51493	185	68,00€	51713	313	13,10€	51893	189	690,00€	52017	187	2,40€
51494	183	107,00€	51714	313	15,80€	51895	261	99,00€	52018	187	2,60€
51495	191	59,00€	51715	313	20,30€	51896	187	82,00€	52019	187	3,20€
51496	192	8,00€	51716	313	23,60€	51897	187	122,00€	52021	187	3,40€
51500	194	29,00€	51717	313	11,20€	51898	187	139,00€	52022	187	4,50€
51501	195	38,00€	51718	313	14,80€	51899	187	137,00€	52023	187	6,60€
51504	46	8,50€	51719	313	22,00€	51901	265	999,00€	52024	187	10,60€
51525	55	9,80€	51720	313	23,50€	51902	195	84,00€	52025	187	13,00€
51526	55	9,80€	51721	313	25,00€	51905	262	34,50€	52026	162	31,80€
51528	40	49,00€	51722	313	13,10€	51906	262	39,00€	52027	324	14,00€
51529	38	59,00€	51723	313	18,70€	51907	262	48,00€	52028	326	15,20€
51546	330	0,19€	51724	313	24,40€	51908	309	44,00€	52029	326	14,00€
51554	330	0,28€	51725	313	28,30€	51909	44	2,46€	52030	329	98,00€
51573	119,302	2,50€	51726	313	31,40€	51918	46	12,50€	52031	328	44,00€
51574	84	52,00€	51727	313	49,00€	51919	205	89,00€	52032	329	28,00€
51575	84	317,00€	51737	82	699,00€	51920	215,332	18,00€	52033	333	43,00€
51576	81	125,00€	51738	82	850,00€	51923	179	12,50€	52043	327	16,50€
51600	84	109,00€	51741	311	0,50€	51925	300	1,00€	52044	325	19,00€
51604	308	0,98€	51742	311	0,50€	51927	246	25,00€	52047	129	3,30€
51612	129	5,95€	51743	311	0,55€	51928	256	14,00€	52048	129	3,95€
51613	129	2,90€	51745	316	0,70€	51929	129	22,00€	52049	48	14,00€
51614	129	3,60€	51746	30	12,00€	51930	24	39,00€	52050	61	98,00€
51615	129	5,95€	51750	269	299,00€	51934	179	11,50€	52052	58	53,00€
51616	23	378,00€	51751	270	99,00€	51935	302	135,00€	52053	335	45,00€
51622	171	25,30€	51785	316	0,75€	51936	302	135,00€	52054	335	17,00€
51632N	316	1,74€	51795	63	9,00€	51937	302	135,00€	52055	268	129,00€
51633	316	1,74€	51796	63	14,00€	51951	47	15,60€	52056	205	66,00€
51634	316	1,74€	51797	63	18,00€	51958	204	422,00€	52057	170	6,80€
51636N	316	1,54€	51798	63	39,60€	51960	124	34,00€	52058	170	4,50€
51638N	316	1,54€	51799	330	0,20€	51961	124	34,00€	52059	30	29,00€
51640N	316	1,54€	51801	53	62,00€	51962	123	25,00€	52060	30	32,00€
51642N	316	1,54€	51804	328	58,00€	51963	123	29,00€	52065	170	45,00€
51653	81	5,10€	51805	54, 80	17,00€	51964	123	28,00€	52066	213	12,00€
51654	81	4,80€	51812	59	46,00€	51965	123	29,50€	52069	272	29,50€
51655	81	4,10€	51814	300	8,00€	51966	124	18,00€	52070	272	40,00€

REF.	Pg.	PDV	REF.	Pg.	PDV	REF.	Pg.	PDV	REF.	Pg.	PDV
52071	272	47,00€	52270	199	109,00€	52368	130	1,14€	52478	165	49,00€
52076	190	111,00€	52271	245	18,00€	52369	130	1,19€	52479	165	24,70€
52077	163	29,50€	52272	59	24,60€	52370	130	1,17€	52480	165	44,00€
52148	85	82,00€	52273	185	44,00€	52373	81	252,00€	52481	165	52,00€
52149	293	230,00€	52275	176	38,00€	52375	123	38,00€	52482	165	44,00€
52152	57	13,50€	52293	193	98,00€	52378	142,214	10,00€	52483	165	41,00€
52153	190	46,00€	52295	166	6,50€	52381	144	20,50€	52484	165	66,00€
52156	140	140,00€	52296	198	119,00€	52382	274,288	19,50€	52485	165	51,00€
52157	141	48,00€	52297	198	172,00€	52384	117	29,00€	52486	165	62,00€
52158	328	38,50€	52298	198	177,00€	52385	164	251,00€	52487	165	63,00€
52159	141	64,00€	52302	125	25,40€	52386	164	23,60€	52488	188	28,00€
52160	141	48,00€	52303	126	26,40€	52387	164	24,50€	52489	189	58,00€
52162	71,275,290	38,00€	52304	262	84,00€	52390	165	35,20€	52490	144	6,65€
52163	330	95,00€	52305	190	106,00€	52391	258	5,00€	52491	144	10,50€
52165	140	118,00€	52308	86	440,00€	52393	74	1.180,00€	52493	300,320	4,50€
52167	140	48,00€	52309	86	941,00€	52412	59	5,00€	52494	200	227,00€
52169	43	25,00€	52310	316	3,65€	52414	126	19,00€	52495	206	14,50€
52170	43	16,00€	52311	179	19,00€	52415	126	19,00€	52497	213	26,80€
52171	141	39,00€	52312	179	9,00€	52416	180	14,00€	52498	256	58,00€
52172	74	780,00€	52313	179	8,00€	52417	180	28,00€	52500	42	19,00€
52180	46	19,00€	52314	179	26,60€	52418	23	164,00€	52502	165	31,40€
52181	46	22,50€	52315	176	16,00€	52419	81	80,00€	52503	165	32,50€
52182	46	24,00€	52316	192	18,90€	52420	81	108,00€	52504	165	27,60€
52183	46	26,20€	52317	192	19,90€	52421	81	172,00€	52505	164	20,80€
52184	46	43,00€	52318	194	73,00€	52422	160	24,70€	52506	164	16,00€
52185	46	55,00€	52319	215	8,80€	52424	63	64,00€	52507	165	30,10€
52186	46	72,00€	52320	30	22,00€	52425	46	33,30€	52508	61	38,40€
52187	305	21,80€	52321	167	8,80€	52426	46	52,00€	52509	61	36,20€
52188	47	15,50€	52327	167	12,00€	52427	46	64,00€	52511	165	42,00€
52190	194	8,00€	52328	176	99,00€	52428	252	43,00€	52512	164	50,00€
52191	176	198,00€	52329	252	36,40€	52430	318	10,90€	52514	270	84,00€
52195	279	170,00€	52330	174	99,00€	52432	199	35,00€	52515	62,216	9,10€
52197	52	36,30€	52331	140	201,00€	52433	204	4,80€	52516	214	28,00€
52198	29	37,70€	52337	150	65,00€	52434	176	125,00€	52517	214	6,00€
52200	294	88,00€	52338	151	41,00€	52436	276	680,00€	52518	179	115,00€
52201	294	66,00€	52339	153	61,00€	52439	274	227,00€	52519	32,289	25,50€
52202	294	88,00€	52340	153	58,00€	52450	275	105,00€	52521	32,289	125,00€
52207	51	24,20€	52341	150	58,00€	52451	39	42,00€	52524	54	51,00€
52227	211	247,00€	52342	151	63,00€	52452	249	8,00€	52525	54	13,80€
52230	172	398,00€	52343	152	52,00€	52453	249	21,00€	52526	54	28,40€
52231	275	49,00€	52344	153	197,00€	52454	202	12,90€	52527	141	82,00€
52233	273	328,00€	52345	150	109,00€	52455	176	16,00€	52528	137	49,00€
52235	64	11,00€	52346	150	103,00€	52456	123	36,00€	52530	306	14,00€
52236	64	13,30€	52347	154	158,00€	52458	128	58,00€	52533	166	10,00€
52237	64	18,10€	52348	154	179,00€	52460	47	16,60€	52534	306	15,00€
52238	64	24,90€	52349	64	22,10€	52461	47	25,70€	52535	306	16,50€
52241	265	1.690,00€	52350	64	22,60€	52462	49	25,30€	52536	114	57,00€
52242	258	12,00€	52351	64	25,40€	52463	49	26,10€	52538	28	62,00€
52243	258	8,50€	52352	64	32,40€	52464	49	42,00€	52539	28	59,00€
52244	169	84,00€	52353	64	33,40€	52466	214	11,00€	52540	171	221,00€
52251	305	21,80€	52354	64	34,40€	52467	214	10,30€	52541	196	45,00€
52254	120	64,00€	52355	64	36,60€	52468	55	5,90€	52542	85	109,00€
52259	300	3,75€	52357	64	54,00€	52472	55	4,90€	52543	143	182,00€
52262	166	7,50€	52358	64	63,00€	52473	55	9,90€	52544	154	93,00€
52263	166	13,50€	52362	130	1,23€	52474	165	68,00€	52545	154	177,00€
52264	166	18,60€	52363	130	1,23€	52475	165	62,00€	52546	153	39,60€
52265	166	30,50€	52364	130	2,86€	52476	165	50,00€	52547	150	96,00€
52269	180	7,00€	52365	130	2,46€	52477	165	70,00€	52550	27	92,00€

REF.	Pg.	PDV	REF.	Pg.	PDV	REF.	Pg.	PDV	REF.	Pg.	PDV
52551	201	151,00€	52642	196	32,00€	52729	198	128,00€	52813	185	79,00€
52552	313	128,00€	52643	278	596,00€	52730	198	288,00€	52814	134	528,00€
52555	119	2,38€	52644	314	8,80€	52731	198	38,00€	52815	190	110,00€
52558	119	2,38€	52645	313	0,55€	52732	198	58,00€	52816	190	28,10€
52565	46	11,50€	52646	313	0,50€	52733	198	98,00€	52817	190	23,50€
52566	125	28,00€	52648	143	9,00€	52734	210	51,00€	52818	310	148,00€
52567	125	29,00€	52649	311	5,00€	52735	148	4,85€	52819	246	22,00€
52568	126	28,00€	52650	311	5,00€	52736	148	5,35€	52821	183	28,80€
52569	126	28,00€	52652	310	2,80€	52737	148	5,50€	52822	186	32,00€
52570	316	2,60€	52653	310	3,00€	52738	316	5,00€	52823	191	124,00€
52571	316	2,60€	52655	312	39,70€	52739	316	5,00€	52827	124	46,00€
52572	316	2,60€	52656	312	39,50€	52740	120	690,00€	52828	124	43,00€
52573	316	2,60€	52657	312	37,50€	52742	305	64,00€	52829	314	19,00€
52574	137	69,00€	52658	312	39,70€	52749	168	79,00€	52830	47	24,00€
52575	50,137	119,00€	52659	312	39,70€	52753	27	107,00€	52831	47	18,00€
52583	204	8,50€	52660	313	126,00€	52754	188	54,00€	52832	193	75,00€
52587	52	39,90€	52661	313	290,00€	52757	216	16,00€	52833	192	39,30€
52588	52	45,00€	52662	310	36,50€	52758	139	88,00€	52834	199	195,00€
52589	166	13,00€	52663	310	30,00€	52760	62,216	4,10€	52835	199	272,00€
52591	211	12,00€	52664	312	168,00€	52761	57	8,00€	52836	120	1.100,00€
52592	211	22,00€	52665	308	0,37€	52762	57	9,00€	52838	128	56,00€
52593	211	34,00€	52666	308	0,36€	52765	166	21,70€	52839	64,128	64,00€
52595	49	64,00€	52667	308	0,76€	52768	299	13,80€	52842	311	11,00€
52596	49	114,00€	52668	308	1,49€	52769	299	14,50€	52843	124	31,60€
52597	49	146,00€	52669	308	2,22€	52770	299	23,00€	52845	270	170,00€
52598	106,281	1.080,00€	52670	308	2,95€	52771	299	23,40€	52846	59	37,80€
52599	189	230,00€	52671	308	3,70€	52772	299	13,90€	52847	59	41,00€
52600	287	884,00€	52672	308	4,45€	52773	299	14,60€	52848	128	88,00€
52601	252	397,00€	52673	310	18,00€	52774	299	14,80€	52849	202	8,50€
52603	26	74,00€	52675	139	84,00€	52775	299	15,20€	52850	210	7,80€
52604	26	78,00€	52676	139	98,00€	52776	299	13,80€	52851	163,343	9,65€
52605	26	76,00€	52677	180	17,00€	52777	299	15,50€	52852	62	6,80€
52606	26	88,00€	52678	180	18,00€	52778	299	14,60€	52857	351	7,50€
52607	181	49,00€	52685	188	88,00€	52779	299	17,10€	52858	184	298,00€
52608	181	44,00€	52687	208	168,00€	52780	299	13,90€	52862	130	1,15€
52609	50	29,00€	52690	193	54,00€	52781	299	14,60€	52864	130	1,20€
52615	179	112,00€	52691	192	54,00€	52782	299	14,80€	52866	130	0,25€
52616	246	44,00€	52692	268	129,00€	52783	299	15,20€	52869	86	52,00€
52617	182	7,00€	52693	210	24,50€	52786	56	14,60€	52870	86	100,00€
52618	301	29,00€	52694	150	49,00€	52787	144	9,00€	52871	86	248,00€
52619	61	23,10€	52696	210	12,00€	52788	162	39,00€	52873	204	11,00€
52620	213	8,80€	52697	210	16,00€	52789	256	15,20€	52874	195	82,00€
52621	215	11,00€	52699	196	22,00€	52791	60,61	18,00€	52875	195	79,00€
52624	194	28,00€	52700	192	20,50€	52794	204	28,00€	52876	160	182,00€
52625	62,176	9,00€	52703	327	22,00€	52795	300	5,80€	52877	56	15,80€
52626	196	46,00€	52711	327	27,50€	52796	205	98,00€	52878	56	11,20€
52627	196	120,00€	52713	19	89,00€	52797	255	198,00€	52879	56	10,10€
52628	256	26,50€	52714	29	15,70€	52798	144	18,00€	52880	53,311	42,00€
52629	184	99,00€	52715	29	10,00€	52801	186,256	26,00€	52881	53,311	17,00€
52633	310	1,00€	52716	29	15,90€	52802	191	54,00€	52882	160	14,00€
52634	81	5,25€	52717	29	11,00€	52804	248	343,00€	52883	116	38,00€
52635	81	4,80€	52718	141	48,00€	52805	248	426,00€	52884	273	73,00€
52636	174	114,00€	52719	330	0,19€	52806	248	742,00€	52885	62	18,00€
52637	202	48,00€	52722	18	87,00€	52807	248	1.714,00€	52886	336	18,00€
52638	62	9,95€	52724	138	381,00€	52809	179	8,50€	52887	336	22,00€
52639	195	123,00€	52725	138	349,00€	52810	153	9,00€	52888	341	24,00€
52640	195	52,00€	52727	198	34,60€	52811	153	9,90€	52889	338	19,00€
52641	195	55,00€	52728	198	68,00€	52812	61	65,00€	52890	339	22,00€



REF.	Pg.	PDV	REF.	Pg.	PDV	REF.	Pg.	PDV	REF.	Pg.	PDV
52891	339	28,00€	52957	57	23,80€	53058	200	193,00€	53141	137	68,00€
52892	338	22,00€	52958	57	28,20€	53059	201	52,00€	53144	257	18,00€
52893	339	26,00€	52959	57	42,00€	53060	151	34,90€	53145	278	39,20€
52894	338	22,00€	52960	57	46,00€	53062	197	99,00€	53146	198	30,50€
52895	340	22,00€	52962	190	42,00€	53063	144	36,70€	53147	142	41,00€
52896	336	26,00€	52963	254	49,00€	53064	144	37,40€	53150	309	24,00€
52897	340	38,00€	52964	58	9,45€	53065	144	36,90€	53151	127	14,00€
52898	340	36,00€	52965	58	9,20€	53066	144	61,00€	53154	31,288	462,00€
52899	337	34,00€	52966	58	9,45€	53067	144	61,00€	53156	29	26,20€
52900	337	34,00€	52967	58	9,40€	53068	144	63,00€	53159	20	289,00€
52901	337	34,00€	52969	151	20,70€	53069	183	98,00€	53162	278	60,00€
52902	287	970,00€	52973	38	59,00€	53070	64	16,20€	53164	32,289	16,50€
52903	287	1.100,00€	52977	162	137,00€	53071	64	26,10€	53165	32,289	19,60€
52904	204	61,00€	52980	279	480,00€	53072	64	31,60€	53166	283	10,50€
52905	56	28,00€	52982	164	53,00€	53073	64	50,00€	53167	283	12,50€
52906	175	38,00€	52985	267	598,00€	53074	15	78,00€	53168	283	19,00€
52908	29	17,00€	52987	116	20,00€	53077	152	62,00€	53177	299	11,90€
52909	29	12,50€	52991	258	10,50€	53078	249	18,00€	53178	299	12,20€
52910	124	39,00€	52992	258	18,00€	53079	168	89,00€	53179	299	12,20€
52912	40,78	91,00€	52998	166	48,00€	53080	168	99,00€	53180	299	12,20€
52913	203	292,00€	52999	266	168,00€	53081	203	115,00€	53181	299	11,90€
52914	156	223,00€	53001	206	242,00€	53082	203	148,00€	53182	299	12,20€
52915	156	199,00€	53007	130	0,42€	53083	48	64,00€	53183	299	12,70€
52916	156	218,00€	53008	179	15,50€	53084	30	24,00€	53184	299	12,20€
52917	156	122,00€	53009	184	42,00€	53085	119	30,00€	53185	299	13,20€
52918	156	146,00€	53010	42	18,00€	53086	216	9,00€	53186	299	13,20€
52919	156	181,00€	53017	34	57,00€	53087	299	11,20€	53187	258	39,00€
52920	156	155,00€	53018	36	119,00€	53088	299	11,50€	53188	258	7,00€
52921	156	117,00€	53025	44	3,50€	53089	299	11,50€	53189	284	128,00€
52922	156	180,00€	53026	44	5,80€	53090	299	11,50€	53190	284	98,00€
52923	156	59,00€	53027	44	9,00€	53091	299	10,20€	53191	171	14,80€
52924	157	52,00€	53028	275	5,80€	53092	299	10,30€	53192	171	52,00€
52925	157	176,00€	53029	275	6,80€	53093	299	10,30€	53196	213	33,00€
52926	157	201,00€	53030	275	12,00€	53094	299	10,20€	53197	152	46,00€
52927	157	59,00€	53031	86	59,00€	53095	48	20,50€	53198	258	9,50€
52928	157	172,00€	53032	86	126,00€	53096	216	28,80€	53200	263	69,00€
52929	157	185,00€	53033	305	21,50€	53102	17	36,00€	53202	145	15,70€
52930	157	117,00€	53037	313	0,50€	53104	25	34,00€	53203	130	0,46€
52931	157	45,00€	53038	313	0,50€	53105	25	37,00€	53204	145	81,00€
52932	157	45,00€	53039	313	0,50€	53106	19	99,00€	53205	144	19,00€
52933	157	194,00€	53040	313	0,50€	53108	18	92,00€	53206	180	38,20€
52934	158	102,00€	53041	187	37,60€	53110	163,343	27,30€	53207	191	118,00€
52935	158	94,00€	53042	204	9,90€	53111	277	19,00€	53208	191	126,00€
52936	158	199,00€	53043	152	53,00€	53112	260	298,00€	53209	273	8,50€
52937	158	265,00€	53044	153	121,00€	53118	211	231,00€	53210	64	48,00€
52938	158	199,00€	53045	126	35,00€	53119	160	52,00€	53211	85	75,00€
52939	158	28,00€	53046	126	39,00€	53120	48	6,00€	53212	14	149,00€
52940	158	235,00€	53047	126	330,00€	53121	48	7,35€	53214	248	285,00€
52941	158	70,00€	53048	126	89,00€	53122	48	9,50€	53215	257	19,00€
52942	158	105,00€	53049	125	89,00€	53124	167	287,00€	53216	115	49,00€
52943	158	75,00€	53051	126	158,00€	53125	167	477,00€	53217	116	47,00€
52944	158	110,00€	53052	126	158,00€	53126	169	243,00€	53218	263	26,00€
52945	158	281,00€	53053	194	12,00€	53127	30	12,00€	53219	16	49,00€
52952	274,288	74,00€	53054	216	6,00€	53129	200	84,00€	53220	279	260,00€
52953	142	38,00€	53055	215	33,00€	53134	169	144,00€	53221	301	4,75€
52955	57	19,80€	53056	200	127,00€	53137	137	38,00€	53222	84	57,00€
52956	57	19,60€	53057	206	149,00€	53140	138	98,00€	53224	160	142,00€

REF.	Pg.	PDV	REF.	Pg.	PDV	REF.	Pg.	PDV	REF.	Pg.	PDV
53225	55	3,50€	53297	233	45,00€	53366	326	14,00€	53443	300	7,55€
53226	171	14,90€	53298	234	91,00€	53367	334	9,50€	53444	22	195,00€
53227	119	28,00€	53299	234	291,00€	53368	334	9,00€	53445	189	17,10€
53229	329	38,70€	53300	234	41,00€	53369	326	14,00€	53449	143	14,00€
53230	163	19,70€	53301	235	44,00€	53370	324	26,00€	53450	143	28,30€
53232	163	39,00€	53302	236	44,00€	53371	325	29,00€	53452	234	26,50€
53235	182	10,40€	53303	236	89,00€	53372	324	26,00€	53453	254	7,00€
53236	182	11,50€	53304	236	279,00€	53373	331	14,50€	53456	207	98,00€
53237	182	12,90€	53305	236	136,00€	53374	332	10,00€	53459	207	66,00€
53238	182	18,40€	53306	240	53,00€	53376	332	10,50€	53463	202	98,00€
53240	212	58,00€	53307	237	38,50€	53377	328	20,00€	53464	184,330	153,00€
53241	306	9,00€	53308	241	55,00€	53378	334	13,00€	53468	54	8,50€
53246	269	1.144,00€	53309	240	285,00€	53380	335	11,50€	53469	73	613,00€
53249	212	192,00€	53310	239	498,00€	53381	331	14,50€	53470	154	176,00€
53250	197	85,00€	53311	238	97,00€	53382	331	11,00€	53472	182	12,00€
53251	210	88,00€	53312	239	127,00€	53383	331	11,50€	53473	182	36,00€
53253	107	98,00€	53313	238	139,00€	53384	196	165,00€	53474	212	94,00€
53256	309	34,00€	53314	238	98,00€	53385	56,343	19,30€	53477	213	36,10€
53258	107	67,00€	53315	244	285,00€	53388	198	90,00€	53478	54	4,55€
53259	218	97,00€	53316	237	34,00€	53389	58	31,50€	53479	54	6,40€
53260	218	168,00€	53317	246	34,00€	53390	60	34,50€	53480	54	19,90€
53261	218	214,00€	53318	245	24,00€	53391	199	86,00€	53481	54	27,40€
53262	218	251,00€	53319	240	18,00€	53393	199	118,00€	53484	276	615,00€
53263	219	57,00€	53320	245	12,00€	53394	211	598,00€	53485	209	140,00€
53264	220	143,00€	53321	246	10,50€	53395	213	16,00€	53486	160	29,30€
53265	219	195,00€	53324	233	12,50€	53396	60	18,30€	53487	61	16,70€
53266	220	224,00€	53325	246	7,50€	53399	45	3,50€	53488	194	61,00€
53267	220	277,00€	53326	226	16,00€	53400	45	5,70€	53489	188	68,00€
53268	221	92,00€	53327	226	11,00€	53401	45	7,40€	53490	189	275,00€
53269	220	50,00€	53328	191	76,00€	53402	45	9,60€	53492	142,353	380,00€
53270	222	70,00€	53330	186	38,00€	53403	45	6,50€	53499	207	29,00€
53271	222	227,00€	53331	50	31,80€	53404	45	6,50€	53500	207	29,00€
53272	222	195,00€	53332	50	34,50€	53405	45	5,30€	53501	184	24,00€
53273	223	75,00€	53339	47	9,50€	53406	45	8,55€	53502	192	38,70€
53274	225	30,50€	53340	329	86,00€	53407	45	12,70€	53503	275	12,00€
53275	228	35,50€	53343	137	285,00€	53408	45	19,30€	53504	351	38,00€
53276	225	160,00€	53344	137	295,00€	53409	45	9,00€	53505	120	77,00€
53277	223	45,00€	53346	52	18,00€	53410	206	92,00€	53506	120	36,00€
53278	224	143,00€	53347	209	100,00€	53411	56	5,00€	53507	302	24,00€
53279	226	97,00€	53348	324	14,00€	53412	56	4,00€	53508	302	14,00€
53280	226	112,00€	53349	324	14,00€	53414	162	49,00€	53509	73	482,00€
53281	225	55,00€	53350	324	14,00€	53415	162	188,00€	53510	351	24,00€
53282	225	48,00€	53351	325	12,50€	53416	143	14,10€	53511	351	23,00€
53283	227	92,00€	53352	325	12,00€	53417	143	26,30€	53512	351	41,00€
53284	224	306,00€	53353	331	18,00€	53418	143	16,90€	53513	351	9,00€
53285	227	56,00€	53354	326	14,00€	53419	311	9,70€	53514	73	990,00€
53286	227	87,00€	53355	334	11,50€	53420	40	72,00€	53517	56	9,50€
53287	227	245,00€	53356	334	11,50€	53421	260	298,00€	53518	249	3,50€
53288	228	72,00€	53357	272,334	7,00€	53422	260	368,00€	53519	114	42,00€
53289	229	45,00€	53358	334	11,50€	53423	269	199,00€	53520	132	228,00€
53290	229	51,00€	53359	333	16,00€	53426	188	39,80€	53522	184	24,00€
53291	229	68,00€	53360	327	18,00€	53427	119	5,00€	53523	229	91,00€
53292	230	116,00€	53361	327	24,00€	53428	125	18,00€	53524	63	51,00€
53293	231	134,00€	53362	326	14,00€	53429	125	18,00€	53525	213	12,00€
53294	233	119,00€	53363	325	34,00€	53430	158	286,00€	53526	283,292	168,00€
53295	232	77,00€	53364	325	16,00€	53434	333	18,00€	53530	116,208	46,00€
53296	233	60,00€	53365	327	14,00€	53441	179	9,80€	53531	150	109,00€

REF.	Pg.	PDV	REF.	Pg.	PDV	REF.	Pg.	PDV	REF.	Pg.	PDV
53532	146,292	119,00€	53603	57	45,00€	53662	209	89,00€	53727	23	198,00€
53533	350	1,50€	53604	57	118,00€	53663	212	8,00€	53728	23	198,00€
53536	129	34,00€	53605	312	141,00€	53664	194	38,00€	53729	213	19,10€
53537	181	14,50€	53606	145	55,00€	53665	215	19,00€	53733	132	238,00€
53538	181	14,50€	53607	145	292,00€	53666	215	28,00€	53734	114	23,70€
53539	208	78,00€	53608	132	98,00€	53667	30	32,00€	53735	181	44,00€
53540	298	23,00€	53609	250	190,00€	53668	30	34,00€	53736	168	98,00€
53541	138	168,00€	53610	250	294,00€	53669	206	45,00€	53737	41	12,50€
53542	138	980,00€	53611	144	27,50€	53670	180	29,50€	53738	41	10,90€
53543	284	13,80€	53612	249	96,00€	53671	51,79	41,00€	53739	41	10,50€
53545	163	35,70€	53613	44	19,50€	53672	83	440,00€	53740	41	9,10€
53547	58	14,70€	53614	44	21,50€	53673	161	80,00€	53741	181	14,00€
53548	58	15,60€	53615	44	34,60€	53674	82	447,00€	53743	28,154	39,70€
53549	58	14,30€	53616	44	10,40€	53675	164	50,00€	53744	151	63,00€
53550	58	14,70€	53617	44	9,25€	53676	164	44,00€	53745	307	6,40€
53551	317	18,95€	53618	44	13,90€	53677	164	55,00€	53746	307	6,40€
53552	317	18,95€	53620	80	88,00€	53678	164	52,00€	53747	307	6,40€
53553	317	18,95€	53621	298	2,50€	53681	134	743,00€	53748	307	6,60€
53556	73	990,00€	53622	298	2,50€	53682	268	98,00€	53749	307	6,70€
53557	73	990,00€	53623	298	2,50€	53683	174	116,00€	53750	307	6,70€
53561	302	28,00€	53624	298	2,50€	53684	266	1.880,00€	53751	307	6,80€
53565	84	258,00€	53625	141	68,00€	53685	168	310,00€	53752	307	6,95€
53566	254	32,00€	53626	140,161	18,00€	53686	69	890,00€	53753	307	7,10€
53567	136,166	43,00€	53627	254	22,50€	53687	272	298,00€	53754	307	7,40€
53568	118	12,00€	53629	147	14,30€	53688	272	495,00€	53755	307	7,50€
53569	118	18,00€	53630	147	18,80€	53689	133	238,00€	53756	307	7,90€
53570	121	154,00€	53631	147	33,50€	53690	122	34,00€	53757	307	7,90€
53572	138,210	348,00€	53632	147	46,00€	53691	122	36,00€	53758	307	8,20€
53573	141	36,00€	53633	147	46,00€	53693	314	521,00€	53759	307	8,50€
53574	28,42	47,00€	53634	147	63,00€	53694	42	18,40€	53760	307	9,60€
53575	43	16,00€	53635	202	85,00€	53695	314	504,00€	53761	69	680,00€
53576	139	189,00€	53636	302	22,00€	53696	215	22,00€	53762	69	680,00€
53577	73	990,00€	53637	210	85,00€	53697	250	398,00€	53763	68	890,00€
53578	73	990,00€	53638	202	243,00€	53698	314	717,00€	53764	68	680,00€
53579	73	990,00€	53639	63	28,60€	53701	197	188,00€	53765	68	890,00€
53580	73	990,00€	53640	63	34,40€	53702	107	28,50€	53766	68	680,00€
53581	146,292	115,00€	53641	63	41,00€	53703	107	41,00€	53767	69	890,00€
53582	146,292	179,00€	53642	63	54,00€	53704	107	42,00€	53768	69	680,00€
53583	146,292	170,00€	53643	63	92,00€	53705	170	80,00€	53769	72,230	178,00€
53584	283,292	119,00€	53644	251	1.238,00€	53706	224	98,00€	53770	72,242	198,00€
53585	283,292	168,00€	53645	251	268,00€	53707	121	153,00€	53771	72,243	158,00€
53586	283,292	158,00€	53646	139,140,161	62,00€	53708	66,68 6974,76	325,00€	53772	72,243	229,00€
53587	151	44,00€	53647	14	96,00€	53710	344	16,00€	53773	72,241	298,00€
53588	132	164,00€	53648	224	107,00€	53711	344	16,00€	53774	72,242	190,00€
53589	62	12,00€	53649	228	89,00€	53712	344	16,00€	53775	72,244,245	1.109,00€
53590	266	1.190,00€	53650	186	47,00€	53713	343	16,00€	53776	116	19,10€
53591	56	5,50€	53651	235	91,00€	53714	343	16,00€	53777	270	4.352,00€
53592	257	25,00€	53652	191	53,00€	53715	343	19,00€	53778	300	4,50€
53593	145	41,00€	53653	231	207,00€	53716	342	19,00€	53779	263	36,00€
53594	147	54,00€	53654	63	81,00€	53717	342	19,00€	53780	117	14,50€
53595	147	61,00€	53655	213	12,00€	53718	342	19,00€	53781	319	18,00€
53596	318	3,65€	53656	278	198,00€	53719	341	19,00€	53782	107	14,00€
53597	318	3,70€	53657	278	248,00€	53720	341	19,00€	53784	135	148,00€
53598	318	3,95€	53658	278	99,00€	53723	309	68,00€	53785	318	4,80€
53599	207,331	30,30€	53659	278	121,00€	53724	276	46,00€	53786	322	98,00€
53600	284	13,80€	53660	279	146,00€	53725	260	248,00€	53787	319	0,98€
53602	57	30,50€	53661	69	890,00€	53726	133	128,00€	53787O	319	0,98€
									53791	320	4,80€

REF.	Pg.	PDV	REF.	Pg.	PDV	REF.	Pg.	PDV	REF.	Pg.	PDV
53794	320	28,00€	53877	352	430,50€	53951	72,245	1.794,00€	54023	51	13,50€
53796	322	76,00€	53878	352	574,00€	53952	72,245	1.794,00€	54024	51	1790€
53797	319	0,10€	53879	352	838,50€	53953	16	29,00€	54028	50	28,00€
53798	320	1,95€	53880	270	598,00€	53954	41	8,50€	54029	50	28,00€
53802	322	120,00€	53881	146,292	79,00€	53955	41	10,00€	54030	50	18,80€
53803	320	0,90€	53882	146,292	79,00€	53956	348	353,00€	54031	50	19,30€
53804	320	0,80€	53883	53	18,40€	53957	319	0,26€	54032	35	84,00€
53805	322	220,00€	53884	53	30,20€	53958	214	6,50€	54033	136	49,00€
53806	322	250,00€	53885	53	35,70€	53959	319	0,98€	54034	7	178,00€
53808	321	16,50€	53886	53	20,30€	53960	319	0,98€	54035	10	149,00€
53809	321	8,00€	53887	53	30,30€	53961	319	0,98€	54036	11	99,00€
53811	321	8,90€	53888	53	37,90€	53964	305	9,65€	54037	12	88,00€
53812	321	23,50€	53893	319	5,00€	53965	305	25,80€	54038	13	88,00€
53820	280	388,00€	53895	262	107,00€	53967	60	10,20€	54039	122	154,00€
53822	320	2,50€	53896	262	127,00€	53968	261	49,00€	54040	274	240,00€
53824	320	2,85€	53897	262	140,00€	53969	268	96,00€	54041	35	198,00€
53826	319	16,00€	53898	262	148,00€	53970	286	3.790,00€	54042	303,318	13,00€
53827	320	14,00€	53900	68,80	890,00€	53971	286	468,00€	54043	349	48,00€
53828	320	6,00€	53901	68,80	680,00€	53972	203	550,00€	54044	127	99,00€
53829	320	14,00€	53902	319,320	25,00€	53973	348	284,00€	54045	7	179,00€
53830	320	1.300,00€	53903	214	59,00€	53974	117	38,00€	54046	10	150,00€
53832	320	1,81€	53904	69,80	890,00€	53976	60	9,00€	54047	11	100,00€
53835	321	16,00€	53905	60	7,30€	53977	277	17,50€	54048	12	89,00€
53836	321	16,00€	53906	60	8,65€	53978	175	38,90€	54049	13	88,00€
53838	322	38,00€	53908	60	7,25€	53979	40,80	34,60€	54050	255	980,00€
53839	321	0,25€	53909	60	9,70€	53980	40,80	34,60€	54051	257	39,00€
53840ES	321	6,00€	53910	333	19,00€	53981	277	143,00€	54052	287	1.100,00€
53844	319	2,80€	53911	60	8,80€	53982	277	219,00€	54053	287	248,00€
53845	263	64,00€	53912	67	1.280,00€	53983	167	215,00€	54054	287	268,00€
53849	256	16,10€	53913	67	1.280,00€	53984	317	8,80€	54055	287	220,00€
53850	93,109	14,90€	53914	321,354	75,00€	53985	317	8,80€	54056	287	260,00€
53851	110	88,00€	53915	24,210	65,00€	53986	317	8,80€	54057	287	248,00€
53852	92,110	207,00€	53916	319	3,80€	53987	288,321	9,50€	54058	287	348,00€
53853	110	14,40€	53917	42	9,00€	53988	152	101,00€	54059	287	428,00€
53854	110	27,00€	53919	304	81,00€	53992	333	18,00€	54060	42	6,00€
53855	110	24,80€	53921	169	39,00€	53993	48	77,00€	54061	42	6,00€
53856	92,110	62,00€	53922	169	29,00€	53997	189	48,00€	54066	34,78	83,00€
53857	91,92,111	27,00€	53927	273	66,00€	53999	111	2,00€	54067	286	599,00€
53858	91,92,111	28,80€	53928	21	278,00€	54000	111	2,50€	54068	178	198,00€
53859	92,111	67,00€	53929	273	95,00€	54001	264	285,00€	54069	202	29,50€
53860	92,109	3,65€	53930	350	276,00€	54002	111	3,00€	54070	43	18,00€
53861	92,109	5,45€	53931	351	104,00€	54003	187	104,00€	54071	43	26,50€
53862	254,319	6,00€	53932	57	8,00€	54004	118	23,00€	54072	303,318	38,50€
53863	254,319	3,00€	53934	351	690,00€	54005	41	14,00€	54073	304	70,00€
53864	309	138,00€	53939	66	1.280,00€	54006	69,71	680,00€	54074	304	18,50€
53865	348	48,00€	53940	71,288 290,321	13,20€	54008	111	3,50€	54076	349	9,00€
53866	75	424,00€	53941	71,288 290,321	6,05€	54010	111	4,50€	54078	125	68,00€
53867	74,80	1.095,00€	53942	71,288 290,321	0,50€	54011	111	5,00€	54079	37	83,00€
53868	66,80	1.090,00€	53943	43,77	21,50€	54013	309	35,00€	54081	39	28,00€
53869	67,80	990,00€	53944	43,77	19,50€	54015	60	10,20€	54082	9	188,00€
53870	67,80	990,00€	53945	43,77	18,90€	54016	209	76,00€	54083	51	9,75€
53871	35	60,00€	53946	319	0,83€	54017	166	12,00€	54084	51	13,10€
53872	292	118,00€	53947	282	145,00€	54018	51	9,85€	54085	51	17,80€
53873	253	285,00€	53948	282	324,00€	54019	51	1790€	54086	51	9,25€
53874	253	398,00€	53949	351	4,50€	54020	349	288,00€	54087	51	17,30€
53875	246	134,00€	53950	351	4,50€	54021	51	13,50€	54088	122	132,00€
53876	238	64,00€				54022	51	9,95€	54089	48	17,50€

REF.	Pg.	PDV	REF.	Pg.	PDV	REF.	Pg.	PDV	REF.	Pg.	PDV
54090	24	56,00€	54159	39	47,00€	54217	235	104,00€	60012	108	48,00€
54091	31,288	441,00€	54160L	127	17,50€	54218	228	142,00€	60013	108	80,00€
54092	223	24,00€	54160R	127	17,50€	54219	221	60,00€	60015	108	138,00€
54093	31	441,00€	54161	127	90,00€	54220	187,222	197,00€	60016	108	49,00€
54097	37	38,90€	54162	127	81,00€	54221	235	111,00€	60017	108	64,00€
54099	48	13,80€	54163	127	80,00€	54222	219	59,00€	60018	88	306,00€
54100	251	265,00€	54164	25	34,00€	54223	231	149,00€	60019	95	178,00€
54101	34	61,00€	54166	304	32,40€	54224	231	64,50€	60020	94	175,00€
54102	297	60,00€	54168	15	49,00€	54225	230	133,00€	60022	97	470,00€
54105	15	33,00€	54169	304	13,80€	54226	244	71,00€	60023	93	212,00€
54106	18,41	89,00€	54170	304	16,50€	54227	221	122,00€	60024	91	190,00€
54108	18	66,00€	54171	350	138,00€	54228	219	187,00€	60025	91,108	31,60€
54109	17	34,00€	54172	123	81,00€	54229	281	48,00€	60026	91,108	379,00€
54110	35	46,00€	54173	123	87,00€	54230	281	68,00€	60027	103	99,00€
54111	163	4,75€	54174	37	139,00€	54231	281	138,00€	60028	92	142,00€
54112	163,197	18,00€	54175	270	34,00€	54232	281	248,00€	60029	104	240,00€
54113	163	7,65€	54176	293	188,00€	54233	290	1.856,00€	60030	105	112,00€
54114	71	248,00€	54177	317	18,95€	54234	71,290	1.856,00€	60031	104	142,00€
54115	39	26,80€	54178	317	18,95€	54235	71,290	1.856,00€	60032	99	123,00€
54116	17	66,00€	54179	317	18,95€	54236	71/290	1.856,00€	60033	93	104,00€
54117	34	74,00€	54180	296	2.400,00€	54237	70	1.887,00€	60034	90	320,00€
54119	39	78,00€	54181	249	25,10€	54238	70	1.887,00€	60035	102	30,00€
54120	37	59,00€	54182	249	34,70€	54239	70	1.887,00€	60037	98	222,00€
54122	115	38,00€	54183	249	38,20€	54240	70	1.887,00€	60038	99	255,00€
54123	115	40,00€	54184	249	44,00€	54241	71,290	120,00€	60039	103	265,00€
54124	115	47,00€	54185	296	390,00€	54245	183	580,00€	60040	105	440,00€
54125	284	152,00€	54186	183	320,00€	54246	294	104,00€	60041	98	77,00€
54126	43	39,00€	54187	37	39,30€	54247	294	99,00€	60042	100	106,00€
54128	104	10,50€	54188	316	19,00€	54248	145	58,00€	60043	100	123,00€
54129	71,290	110,00€	54189	316	19,00€	54249	145	103,00€	60044	89	478,00€
54130	71,290	58,00€	54190	316	19,00€	54250	8	188,00€	60044C	89	652,00€
54131	290	58,00€	54191	316	19,00€	54251	139	43,00€	60045	106	298,00€
54132	71,290	190,00€	54192	316	8,90€	54252	280	199,00€	70002	346	37,50€
54133	122	547,00€	54193	316	8,90€	54253	191	166,00€	70003	346	37,50€
54134	70	1.415,00€	54194	316	8,90€	54254	57	43,00€	70005	346	42,00€
54135	176	82,00€	54195	316	8,90€	54255	257	68,00€	70009	346	37,50€
54136	312	107,00€	54196	297	133,00€	54256	275	48,00€	70011	346	42,00€
54137	260	288,00€	54197	297	118,00€	54257	183,264	318,00€	70012	346	42,00€
54139	188	147,00€	54198	312	59,00€	54260	231	277,00€	70013	346	44,00€
54140	17	36,00€	54199	226	94,00€	54262	267	88,00€	70014	346	44,00€
54141	24	42,00€	54200	244	56,00€	54263	267	130,00€	70015	346	44,00€
54142	62	15,20€	54201	232	37,60€	54264	267	240,00€	70016	346	44,00€
54143	263	249,00€	54202	239	68,00€	54265	287	1.290,00€	70017	346	44,00€
54144	263	298,00€	54203	239	91,00€	54267	118	9,50€	90003	143	35,20€
54145	263	377,00€	54204	232	124,00€	54270	121	42,00€	90004	143	25,80€
54146	263	492,00€	54205	237	49,00€	54271	121	54,00€	JBMW-BEXP	307	24,50€
54147	263	198,00€	54206	221	113,00€	54299	201	227,00€	METEXP	306,346,353	62,00€
54149	38	60,00€	54207	223	38,90€	60001	101	88,00€	SERIE124	314	710,00€
54150	38	23,50€	54208	232	76,00€	60003	101	110,00€	SERIE262	140,161	199,00€
54151	317	10,90€	54209	232	29,70€	60004	102	79,00€			
54152	317	10,90€	54210	230	84,00€	60005	91	132,00€			
54153	317	10,90€	54211	231	74,00€	60006	92	182,00€			
54154	25	37,50€	54212	240	39,40€	60007	96	170,00€			
54155	317	8,80€	54213	238	19,80€	60008	92	141,00€			
54156	317	8,80€	54214	237	96,00€	60009	94	168,00€			
54157	317	8,80€	54215	241	57,00€	60010	95	170,00€			
54158	77	38,00€	54216	234	49,00€	60011	96	175,00€			



[www.jbmfrance.fr](http://www.jbmfrance.fr)

☎ 09.72.28.34.80 ✉ [commande@jbmfrance.fr](mailto:commande@jbmfrance.fr)